

Final

Design Guidance for Application of Permeable Reactive Barriers for Groundwater Remediation

Prepared for

Project Officer: Alison Lightner
Air Force Research Laboratory
Tyndall Air Force Base, Florida

Contract No. F08637-95-D-6004
Delivery Order No. 5503

By

Arun Gavaskar, Neeraj Gupta, Bruce Sass,
Robert Janosy, and James Hicks

BATTELLE
Columbus, Ohio

March 31, 2000

Study sponsored by



REPORT DOCUMENTATION PAGEForm Approved
OMB No. 0704-0188

Public reporting burden for this collection of information is estimated to average 1 hour per response, including the time for reviewing instructions, searching existing data sources, gathering and maintaining the data needed, and completing and reviewing the collection of information. Send comments regarding this burden estimate or any other aspect of this collection of information, including suggestions for reducing this burden, to Washington Headquarters Services, Directorate for Information Operations and Reports, 1215 Jefferson Davis Highway, Suite 1204, Arlington, VA 22202-1302, and to the Office of Management and Budget, Paperwork Reduction Project (074-0188), Washington, DC 20503.

| | | | | |
|--|---|--|---|--|
| 1. AGENCY USE ONLY (Leave blank) | | 2. REPORT DATE March 2000 | 3. REPORT TYPE AND DATES COVERED Final, April 1997 through March 2000 | |
| 4. TITLE AND SUBTITLE Design Guidance for Application of Permeable Reactive Barriers for Groundwater Remediation | | | 5. FUNDING NUMBERS F08637-95-D-6004 DO 5503 | |
| 6. AUTHOR(S) Arun Gavaskar, Neeraj Gupta, Bruce Sass, Robert Janosy, and James Hicks | | | | |
| 7. PERFORMING ORGANIZATION NAME(S) AND ADDRESS(ES) Battelle 505 King Avenue Columbus, OH 43201 | | | 8. PERFORMING ORGANIZATION REPORT NUMBER | |
| 9. SPONSORING/MONITORING AGENCY NAME(S) AND ADDRESS(ES) U.S. Air Force, Air Force Research Laboratory (AFRL) 139 Barnes Drive, Suite 2 Tyndall AFB, FL 32403 | | | 10. SPONSORING/MONITORING AGENCY REPORT NUMBER A012 | |
| 11. SUPPLEMENTARY NOTES Task was performed by Battelle under contract to AFRL, U.S. Air Force | | | | |
| 12a. DISTRIBUTION/AVAILABILITY STATEMENT May not be released by other than sponsoring organization without approval of AFRL, U.S. Air Force | | | 12b. DISTRIBUTION CODE | |
| 13. ABSTRACT (Maximum 200 words) Battelle, under contract to the Air Force, has prepared a comprehensive update to the February 1997 version of a design guidance document for the proposed use of site managers, contractors, and regulators. The design guidance covers permeable barrier application to sites with contaminated groundwater. The document does not purport to replace the scientific judgment of the on-site engineer or hydrogeologist, but provides guidance on the issues and options that need to be considered based on the current understanding of the technology. The guidance addresses design, construction, and monitoring of permeable barriers in various hydrogeologic settings. This update includes the lessons learned during the design, construction, and monitoring of a permeable reactive barrier at Dover AFB, DE, as well as progress made at other sites. It also includes the advances in the technology since the completion of the previous version of the report. | | | | |
| 14. SUBJECT TERMS permeable barrier, groundwater, reactive medium, funnel-and-gate, chlorinated solvent | | | 15. NUMBER OF PAGES 167 + Appendices | |
| | | | 16. PRICE CODE | |
| 17. SECURITY CLASSIFICATION OF REPORT | 18. SECURITY CLASSIFICATION OF THIS PAGE | 19. SECURITY CLASSIFICATION OF ABSTRACT | 20. LIMITATION OF ABSTRACT | |

Preface

This document was prepared by Battelle Memorial Institute, 505 King Avenue, Columbus, OH 43201, under Contract No. F08637-95-D-6004 (Delivery Order No. 5503) for the Air Force Research Laboratory (AFRL), 139 Barnes Drive, Tyndall Air Force Base (AFB), FL 32403. The United States Department of Defense's (DoD's) Strategic Environmental Research and Development Program (SERDP) provided the funds for this project. The AFRL Project Officer for this document was Alison Lightner. Previous versions of this document were supervised by Project Officers Maj. Mark Smith, Cpt. Jeff Stinson, 1st Lt. Dennis O'Sullivan, and Cpt. Gus Fadel. This document is an updated version of the *Design Guidance for Application of Permeable Barriers to Remediate Dissolved Chlorinated Solvents* prepared by Battelle in 1997.

The objective of this report is to provide site managers with a guidance document for designing, constructing, and monitoring a permeable reactive barrier (PRB) for remediation of dissolved groundwater contaminants. Another objective of this document is to bring together the existing knowledge base (published and unpublished) on this technology. This is intended to be a stand-alone document that provides guidance to site managers, contractors, and regulators. Supporting material for the main document is provided in the Appendices.

Battelle would like to acknowledge the advice and reviews provided by several members of the Remediation Technologies Development Forum's (RTDF's) Permeable Barriers Working Group (PBWG) and the members of the Interstate Technology and Regulatory Cooperation's (ITRC's) Permeable Barriers Subgroup. We appreciate the support provided by John Vogan of EnviroMetal Technologies, Inc. (ETI) in providing updates on several new PRB sites and on the other information in the guidance document. Timothy Sivavec from General Electric Co. and Kirk Cantrell from Pacific Northwest National Laboratory are acknowledged for their contributions to the 1997 version of this document.

The information relating to the PRB at Dover AFB was based on a demonstration conducted by Battelle for AFRL, with Alison Lightner as the project officer and Greg Jackson at Dover AFB as the Base contact. The information relating to the PRB at former Naval Air Station (NAS) Moffett Field was based on a study conducted by Battelle for the Naval Facilities Engineering Service Center (NFESC), with Charles Reeter as the project officer and Steve Chao from Engineering Field Activity West as the Base contact. Catherine Vogel, at the DoD SERDP, provided guidance and review support during the project.

This report was prepared as an account of work sponsored by an agency of the United States Government. Neither the United States Government nor any agency thereof, nor any employees, nor any of their contractors, subcontractors, or their employees make any warranties, expressed or implied, or assume any legal liability or responsibility for the accuracy, completeness, or usefulness of any privately owned rights. Reference herein to any specific commercial product, process, or service by trade name, trademark, manufacturer, or otherwise does not necessarily constitute or imply its endorsement, recommendation, or favoring by the United States Government or any agency, contractor, or subcontractor thereof. The views and opinions of the authors expressed herein do not necessarily state or reflect those of the United States Government or any agency, contractor, or subcontractor thereof.

Executive Summary

A. Objective

The Air Force Research Laboratory (AFRL) at Tyndall Air Force Base (AFB), FL contracted Battelle in Columbus, OH to prepare a design guidance document for the application of permeable barriers. The first version of this document was issued in February 1997, after being widely reviewed by several members of the Remedial Technologies Development Forum's (RTDF's) Permeable Barriers Working Group (PBWG) and the Interstate Technology and Regulatory Cooperation's (ITRC's) Permeable Barriers Subgroup. The current document is an effort to update the previous design guidance after reviewing the performance of previously installed permeable reactive barriers (PRBs) and evaluating the design and construction of newer PRB applications, such as the one at Dover AFB. The United States Department of Defense's (DoD's) Strategic Environmental Research and Development Program (SERDP) provided the funds for this project.

The objective of this document is to guide site managers, contractors, and state and federal regulators through the process of:

- (a) Determining the technical and economic suitability of a PRB for a given site, and
- (b) Designing, constructing, and monitoring the PRB.

Unlike conventional ex situ technologies, such as pump-and-treat (P&T) systems, in situ technologies are more dependent on site-specific parameters. Therefore, this document does not purport to replace the scientific judgment of the site hydrologist or site engineer. Instead, this document highlights various chemical, biological, and hydrologic issues that affect the application of PRBs to various sites and the options available for resolving these issues.

B. Background

At many sites, groundwater remediation is proving to be a much more difficult and persistent problem than originally thought. One of the more common and difficult groundwater problems prevalent at DoD sites and other government and industrial properties is the presence of chlorinated solvent-contaminated soil and groundwater. Chlorinated solvents or chlorinated volatile organic compounds (CVOCs), such as trichloroethylene (TCE) and perchloroethylene (PCE), were commonly used at these sites and properties for aircraft maintenance, dry cleaning, electronics manufacturing, metal finishing, and other operations. These solvents have entered the ground through leaks, spills, or past disposal practices, and there may be more than 600 such sites at Air Force bases across the country. The United States Environmental Protection Agency (U.S. EPA) estimates that there are 5,000 DoD, United States Department of Energy (DOE), and Superfund sites contaminated with chlorinated solvents.

Because chlorinated solvents often tend to persist in soil and groundwater for several years or decades, their remediation is usually a technically and economically challenging undertaking. The conventional method for addressing groundwater contamination at most sites has been P&T

systems, which extract groundwater from the aquifer, treat it above ground, and discharge it to a sewer or back to the environment. The energy and labor inputs required to keep these systems operational for many years is a severe economic burden for site owners. PRBs are an innovative technology that offer a passive alternative to conventional P&T systems for addressing long-term groundwater contamination problems. Although PRBs initially were applied to treat CVOC plumes, they also have been applied to treat or capture other contaminants, such as hexavalent chromium and uranium.

C. Scope

The overall methodology for the application of a PRB at a given site is discussed in this document and involves the following steps:

- ❑ Preliminary assessment
- ❑ Site characterization
- ❑ Reactive media selection
- ❑ Treatability testing
- ❑ Modeling and engineering design
- ❑ Selection of a suitable construction method
- ❑ Monitoring plan preparation
- ❑ Economic evaluation.

The guidance in this document is organized in accordance with these design steps.

D. Conclusions

The preliminary assessment is conducted to evaluate the technical and economic suitability of a given site for PRB application. Once a site is determined to be suitable, additional design steps are initiated as shown above. For common contaminants, such as TCE, that are to be treated with common reactive media, namely iron, it may be possible, if regulators agree, to forego treatability testing in favor of published contaminant half-lives and a design that includes appropriate safety factors.

At several existing sites, PRB construction generally has involved installation of reactive media in an excavated space. Excavation using backhoes, continuous trenchers, augers, or caissons is a conventional way of ensuring that the desired thickness and continuity of the reactive cell is achieved. The increasing use of a biodegradable slurry, instead of sheet piles or cross-bracing, to stabilize the excavation has increased the convenience and safety of installing the reactive media in the ground. However, these excavation methods have varying depth limitations (generally between 30 to 50 ft below ground surface). Innovative installation methods, such as jetting, hydraulic fracturing, vibrating beam, deep soil mixing, and the use of mandrels, have been tested at some sites and offer potentially lower-cost alternatives for installing reactive media at greater depths. As published data from various field sites become available on the ability of these techniques to install the reactive media at the desired thickness and continuity, it is likely that deeper aquifers can be accessed in a cost-effective manner.

Ensuring and verifying hydraulic performance are the main design and monitoring challenges during application of PRBs. Aquifer heterogeneities, plume heterogeneities, and seasonal

fluctuations in flow are the factors that make the design and monitoring of a PRB's hydraulic performance difficult. Groundwater flow bypass and/or inadequate residence time in the reactive medium have been the main causes of the inability to meet treatment targets reported at some sites. Adequate site characterization, simulation of multiple flow scenarios, and incorporation of adequate safety factors during design are the main ways of achieving satisfactory hydraulic performance.

The economics of a PRB application depend largely on the useful life (longevity) of the reactive media, especially when treating plumes that are expected to persist for several years or decades. Most current geochemical evaluation techniques (e.g., groundwater monitoring, reactive medium coring, and geochemical modeling) have not been able to predict the life of common reactive media, and empirical evidence is lacking given the relatively short history of PRB applications. In the absence of reliable longevity predictions, this document suggests that multiple longevity scenarios be evaluated to place long-term PRB application costs (and benefits) in the context of varying life expectancies of the reactive medium.

Table of Contents

| | Page |
|---|-------------|
| Preface..... | iii |
| Executive Summary..... | v |
| List of Figures..... | xiii |
| List of Tables..... | xiv |
| List of Abbreviations, Acronyms, and Symbols..... | xvi |
| | |
| 1.0 Introduction..... | 1 |
| 1.1 Project Background..... | 1 |
| 1.2 Groundwater Remediation Difficulties..... | 2 |
| 1.3 The Innovative PRB Technology..... | 3 |
| 1.4 Mechanism of Abiotic Degradation with Metals..... | 3 |
| 1.5 Potential Biologically Mediated Reactions In The Reactive Cell..... | 8 |
| | |
| 2.0 The Design Methodology..... | 11 |
| 2.1 Preliminary Assessment..... | 11 |
| 2.1.1 Preliminary Technical Assessment..... | 11 |
| 2.1.2 Preliminary Economic Assessment..... | 15 |
| 2.2 Site Characterization..... | 16 |
| 2.3 Reactive Media Selection..... | 17 |
| 2.4 Treatability Testing..... | 18 |
| 2.5 Modeling and Engineering Design..... | 18 |
| 2.6 Construction Method..... | 19 |
| 2.7 Monitoring the Performance of a PRB..... | 20 |
| 2.8 PRB Economics..... | 20 |
| | |
| 3.0 Site Characterization..... | 21 |
| 3.1 Hydrogeology of the Site..... | 22 |
| 3.1.1 Local Hydrogeology..... | 22 |
| 3.1.2 Determination of Groundwater Velocity and Direction..... | 23 |
| 3.1.2.1 Groundwater Flow Direction..... | 23 |
| 3.1.2.2 Groundwater Velocity Estimate Using Darcy’s Law..... | 25 |
| 3.1.2.2.1 Hydraulic Conductivity..... | 25 |
| 3.1.2.2.2 Porosity..... | 26 |
| 3.1.2.2.3 Hydraulic Gradient..... | 27 |
| 3.1.2.3 In Situ Ground water Velocity Sensors..... | 27 |
| 3.1.2.4 Downhole Velocity Measurement Probe..... | 27 |
| 3.1.2.5 Colloidal Borescope..... | 28 |
| 3.1.2.6 Tracer Testing..... | 29 |
| 3.2 Contaminant Distribution in the Groundwater..... | 30 |
| 3.2.1 Spatial Distribution of Contaminants..... | 30 |
| 3.2.2 Temporal Changes in Contaminant Concentration..... | 31 |
| 3.2.3 Groundwater Sampling for Volatile Organic Compounds..... | 31 |
| 3.2.4 Analytical Methods for Volatile Organic Compounds..... | 33 |

Table of Contents (Continued)

| | | |
|---------|--|----|
| 3.3 | Geochemical Composition of the Groundwater | 33 |
| 3.3.1 | Sampling and Analysis of Field Parameters | 34 |
| 3.3.2 | Sampling and Analysis of Inorganic Chemical Parameters..... | 34 |
| 3.4 | Geotechnical and Topographic Considerations | 34 |
| 4.0 | Reactive Media Selection..... | 37 |
| 4.1 | Types Of Reactive Media Available | 37 |
| 4.1.1 | Granular Zero-Valent Metal..... | 37 |
| 4.1.1.1 | Granular Iron..... | 37 |
| 4.1.1.2 | Other Zero-Valent Metals | 39 |
| 4.1.2 | Granular Iron with an Amendment | 39 |
| 4.1.3 | Bimetallic Media..... | 40 |
| 4.1.4 | Other Innovative Reactive Media | 40 |
| 4.1.4.1 | Cercona™ Iron Foam..... | 40 |
| 4.1.4.2 | Colloidal Iron..... | 41 |
| 4.1.4.3 | Ferrous Iron-Containing Compounds | 41 |
| 4.1.4.4 | Reduction of Aquifer Materials by Dithionite..... | 41 |
| 4.1.4.5 | Media that Impart Adsorptive and Biological Capability | 42 |
| 4.2 | Screening and Selection of Reactive Media | 43 |
| 5.0 | Treatability Testing | 45 |
| 5.1 | Batch Testing for Media Screening | 45 |
| 5.2 | Column Testing for Media Selection and Contaminant Half-Life Estimation..... | 45 |
| 5.2.1 | Column Test Setup | 46 |
| 5.2.2 | Interpreting Column Data | 49 |
| 5.3 | Measuring the Hydraulic Properties of the Reactive Medium..... | 51 |
| 5.4 | Column Tests for Assessing the Longevity of the Reactive Medium | 53 |
| 6.0 | Modeling and Engineering Design | 55 |
| 6.1 | Hydrologic Modeling | 55 |
| 6.1.1 | Modeling Continuous Reactive Barriers..... | 56 |
| 6.1.2 | Modeling Funnel-and-Gate Systems in Homogeneous Aquifers | 58 |
| 6.1.3 | Modeling PRBs in Heterogeneous Aquifers | 58 |
| 6.1.4 | Summary of Important Results from Modeling Studies | 62 |
| 6.2 | Reactive Cell Thickness Design | 65 |
| 6.2.1 | Determining Flowthrough Thickness of the Reactive Cell..... | 65 |
| 6.2.2 | Correction Factors for Field Application..... | 65 |
| 6.3 | Safety Factors for PRB Design Parameters | 67 |
| 6.4 | Geochemical Evaluation of the PRB | 68 |
| 6.4.1 | Geochemical Evaluation with Simple Inorganic Measurements | 69 |
| 6.4.2 | Geochemical Evaluation with Other Inorganic Measurements | 70 |
| 6.4.3 | Geochemical Modeling..... | 74 |

Table of Contents (Continued)

| | |
|--|-----|
| 7.0 Construction Methods | 75 |
| 7.1 Excavation Methods for Reactive Cell Construction..... | 76 |
| 7.1.1 Excavation with a Backhoe..... | 76 |
| 7.1.2 Excavation with a Clamshell | 79 |
| 7.1.3 Excavation with a Caisson..... | 80 |
| 7.1.4 Excavation with a Continuous Trencher | 83 |
| 7.1.5 Use of a Biodegradable Slurry for Stabilizing a Trench..... | 84 |
| 7.1.6 Excavation with a Hollow-Stem Auger | 85 |
| 7.2 Direct Installation of Reactive Media Using Innovative Techniques | 85 |
| 7.2.1 Hydraulic Fracturing | 85 |
| 7.2.2 Vibrating Beam..... | 85 |
| 7.2.3 Jetting | 86 |
| 7.2.4 Injection with a Mandrel..... | 86 |
| 7.2.5 Deep Soil Mixing | 87 |
| 7.3 Construction Methods for the Funnel | 88 |
| 7.3.1 Sheet Piles..... | 89 |
| 7.3.2 Slurry Walls | 91 |
| 7.3.3 Innovative Construction Methods for PRBs | 93 |
| 7.4 Other Innovative PRB Configurations and Construction Approaches | 93 |
| 7.5 Construction Quality Control..... | 94 |
| 7.6 Health and Safety Issues | 96 |
| 7.7 Waste Minimization..... | 97 |
| 8.0 Monitoring the Performance of a PRB | 99 |
| 8.1 Contaminant Monitoring Strategy | 100 |
| 8.1.1 Monitoring Locations and Frequencies | 100 |
| 8.1.2 Sampling and Analysis for Contaminants and Byproducts | 103 |
| 8.2 Hydraulic Performance Monitoring Strategy..... | 105 |
| 8.2.1 Evaluating Hydraulic Capture Zone of the PRB..... | 105 |
| 8.2.1.1 Evaluating Hydraulic Capture Zone with Hydraulic Gradient Measurements | 105 |
| 8.2.1.2 Evaluating Hydraulic Capture Zone with In Situ Groundwater Velocity Sensors | 106 |
| 8.2.1.3 Evaluating Hydraulic Capture Zone with a Colloidal Borescope | 110 |
| 8.2.1.4 Evaluating Hydraulic Capture Zone with Tracer Tests | 110 |
| 8.2.2 Estimating Residence Time Distribution in the Reactive Cell | 110 |
| 8.2.2.1 Residence Time Estimation with In Situ Velocity Probes | 112 |
| 8.2.2.2 Residence Time Estimation with Tracer Tests | 112 |
| 8.3 Geochemical Performance Monitoring Strategy | 114 |
| 8.3.1 Evaluating Geochemical Performance with Groundwater Monitoring | 116 |
| 8.3.2 Evaluating Geochemical Performance with Geochemical Modeling | 119 |
| 8.3.3 Evaluating Geochemical Performance with Reactive Medium Core Sampling..... | 119 |

Table of Contents (Continued)

| | |
|--|-----|
| 9.0 PRB Economics | 127 |
| 9.1 Capital Investment | 128 |
| 9.1.1 Preconstruction Costs..... | 128 |
| 9.1.2 PRB Materials and Construction Costs..... | 130 |
| 9.1.3 Capital Investment for an Equivalent P&T System..... | 131 |
| 9.2 Operating and Maintenance Costs | 132 |
| 9.3 Present Value Analysis | 133 |
| 9.4 Cost-Benefit Evaluation..... | 137 |
| 9.5 Computerized Cost Models..... | 137 |
| | |
| 10.0 Current Status of the PRB Technology..... | 139 |
| 10.1 Existing PRB Applications | 139 |
| 10.2 Guidance from Government Agencies..... | 140 |
| 10.3 Future Challenges for the PRB Technology | 141 |
| | |
| 11.0 References | 157 |
| | |
| Appendix A: Points of Contact | A-1 |
| Appendix B: Cost Evaluation of a PRB at Dover AFB | B-1 |
| Appendix C: Groundwater Flow Model Review | C-1 |
| Appendix D: Geochemical Modeling | D-1 |

List of Figures

| | | |
|--------------|--|-----|
| Figure 1-1. | Schematic Illustration of Some PRB Configurations | 4 |
| Figure 1-2. | Currently Proposed Mechanism for TCE Degradation by Iron..... | 7 |
| Figure 2-1. | Design Methodology for a PRB Application..... | 12 |
| Figure 2-2. | Preliminary Assessment of the Suitability of a Site for PRB Application | 13 |
| Figure 3-1. | Hydrogeologic Cross Section based on CPT Site Characterization | 24 |
| Figure 5-1. | Typical Column Setup | 48 |
| Figure 5-2. | Column Test in Progress | 48 |
| Figure 5-3. | Column Concentration Profiles of TCE and Its Degradation Byproducts..... | 50 |
| Figure 5-4. | Pseudo First-Order Degradation Rate of TCE | 51 |
| Figure 6-1. | Simulated Capture Zone for a Continuous Reactive Barrier Showing Flowpaths for 180 Days | 57 |
| Figure 6-2. | Simulated Particle Pathlines Showing Capture Zone for a Funnel-and- Gate System in a Homogeneous Aquifer | 59 |
| Figure 6-3. | Details of Simulated Flowpaths in a Reactive Gate of the Funnel-and- Gate-Type PRB at Dover AFB | 60 |
| Figure 6-4. | Capture Zones for the PRB at Dover AFB Showing the Effect of Fluctuating Flow Directions | 61 |
| Figure 6-5. | Funnel-and-Gate System at Former NAS Moffett Field Showing the Effect of Heterogeneity on Capture Zones | 63 |
| Figure 6-6. | Distribution of Dissolved Silica in the PRB at Former NAS Moffett Field | 73 |
| Figure 7-1. | Various PRB Configurations | 77 |
| Figure 7-2. | Placement of Reactive Iron Media (Suspended Bag) and Pea Gravel (Front-End Loader) into Divided Sections of Trench for a PRB..... | 78 |
| Figure 7-3. | Trench Excavation Using a Clamshell and Backhoe | 79 |
| Figure 7-4. | (a) Driving and (b) Excavation of a Caisson for Reactive Media Installation..... | 81 |
| Figure 7-5. | Plan View of a Caisson Gate..... | 82 |
| Figure 7-6. | Continuous Trencher..... | 83 |
| Figure 7-7. | Use of a Biodegradable Slurry for Reactive Media Installation..... | 84 |
| Figure 7-8. | Deep Soil Mixing | 88 |
| Figure 7-9. | Sheet Piles Installed Using a Vibrating Hammer | 89 |
| Figure 7-10. | Cross Section of Sealable-Joint Sheet Piles | 90 |
| Figure 7-11. | Cross Section of a Soil-Bentonite Slurry Trench, Showing Excavation and Backfilling Operations | 92 |
| Figure 8-1. | Various Monitoring Well Configurations for Contaminant Monitoring at a PRB | 101 |
| Figure 8-2. | Monitoring Wells Being Installed in (a) Trench-Type and (b) Caisson- Type Reactive Cells | 104 |
| Figure 8-3. | Water Levels and Capture Zone in Aquifer Near the PRB at Dover AFB (February 1998)..... | 107 |

| | | |
|--------------|--|-----|
| Figure 8-4. | Water Levels and Capture Zone Near the Pilot-Scale PRB at Former NAS Moffett Field (May 1997) | 108 |
| Figure 8-5. | Pictures of (a) an In Situ Groundwater Velocity Sensor and(b) Its Installation..... | 109 |
| Figure 8-6. | (a) Groundwater Velocity and (b) Direction Measured in the Reactive Cell of the PRB at Dover AFB Using an In Situ Velocity Probe | 113 |
| Figure 8-7. | Movement of Bromide Tracer Plume through the PRB at Former NAS Moffett Field | 115 |
| Figure 8-8. | Ionic Charge Balance for Selected Wells at the PRB at Dover AFB (June 1999) | 119 |
| Figure 8-9. | Core Sampler Extracting Vertical Core at Dover AFB | 120 |
| Figure 8-10. | Enviro-Core™ Sampler Extracting Angled Core at Former NAS Moffett Field | 121 |
| Figure 8-11. | Photograph of Core Sleeves Being Placed into Tedlar™ Bags that Contain Packets of Oxygen Scavenging Material | 124 |
| Figure 8-12. | Tedlar™ Bags Flushed with Nitrogen Gas Before Sealing | 124 |
| Figure 9-1. | Illustration of How Break-Even Point or Payback Period Varies with Expected Life of the Reactive Medium | 138 |

List of Tables

| | | |
|------------|---|-----|
| Table 1-1. | Properties of Common CVOCs | 2 |
| Table 2-1. | Compounds Tested and Half-Lives Normalized to 1 m ² Iron Surface per mL Solution (Adapted from Gillham, 1996 and other sources listed in the footnotes) | 14 |
| Table 3-1. | Suggested Site Characterization Parameters for a Prospective PRB Site | 21 |
| Table 3-2. | Porosity Ranges for Sediments | 26 |
| Table 3-3. | Requirements for Field Parameters and Inorganic Analytes (based on EPA SW-846) | 35 |
| Table 5-1. | Hydraulic Conductivities for Different Sources of Iron Measured in a Geotechnical Laboratory..... | 53 |
| Table 6-1. | Illustrative Results of Inorganic Chemical Measurements for Groundwater Flow through a Column of Reactive Medium (Iron) Using Former NAS Moffett Field Data as an Example | 71 |
| Table 6-2. | Average Changes in Species Concentrations Between Influent and Effluent from the Reactive Medium Using Data from Former NAS Moffett Field as an Illustration | 72 |
| Table 6-3. | Estimated Annual Loss of Inorganic Species Due to Precipitation at Former NAS Moffett Field | 73 |
| Table 7-1. | Summary of Various Techniques for Barrier Construction..... | 75 |
| Table 8-1. | Recommended Inorganic Analytical Requirements for Groundwater Samples | 118 |
| Table 8-2. | Survey of Core Sampling and Preparation Methods..... | 122 |
| Table 8-3. | Recommended Characterization Techniques for Coring Samples | 125 |

| | | |
|-------------|---|-----|
| Table 9-1. | Illustration for Estimating Capital Investment Based on the Projections for Operating a Full-Scale PRB at Dover AFB | 129 |
| Table 9-2. | Illustration for Estimating O&M Costs Based on the Projections for Operating a Full-Scale PRB at Dover AFB | 132 |
| Table 9-3. | Illustration of a PV Analysis of PRB and P&T Systems for Dover AFB Assuming 10-Year Life of PRB..... | 135 |
| Table 9-4. | Illustration of the Break-Even Point and Savings by Using a PRB Instead of a P&T System at Dover AFB | 136 |
| Table 10-1. | Update on Design, Construction, and Cost of PRBs | 144 |
| Table 10-2. | Update on PRB Site Characteristics and Monitoring | 149 |

List of Abbreviations, Acronyms, and Symbols

| | |
|--------|---|
| 2-D | two-dimensional |
| 3-D | three-dimensional |
| AFB | Air Force Base |
| AFRL | Air Force Research Laboratory |
| ATR | attenuated total internal reflection |
| B | bulk density |
| BET | Brunauer-Emmett-Teller Adsorption Isotherm Equation |
| bgs | below ground surface |
| BTEX | benzene, toluene, ethylbenzene, and xylenes |
| CCD | charge coupled device |
| CPT | cone penetrometer testing |
| CQC | construction quality control |
| CRB | continuous reactive barrier |
| CVOC | chlorinated volatile organic compound |
| DCE | dichloroethene |
| DDT | dichlorodiphenyltrichloroethane |
| DI | deionized |
| DNAPL | dense, nonaqueous-phase liquid |
| DO | dissolved oxygen |
| DOC | dissolved organic carbon |
| DoD | United States Department of Defense |
| DOE | United States Department of Energy |
| ECD | electron capture detector |
| EDS | energy dispersive spectroscopy |
| Eh | redox potential |
| EPA | Environmental Protection Agency |
| EQL | estimated quantitation limit |
| ESTCP | Environmental Security Technology Certification Program |
| ETI | EnviroMetal Technologies, Inc. |
| FID | flame ionization detector |
| FTIR | Fourier transform infrared spectroscopy |
| GC | gas chromatography |
| GC/MS | gas chromatography/mass spectrometry |
| GC-FID | gas chromatograph-flame ionization detector |

| | |
|----------------------|--|
| HDPE | high-density polyethylene |
| HSU | hydrostratigraphic units |
| IAP | ion activity product |
| IC | ion chromatography |
| ICP | inductively coupled plasma |
| ISRM | in situ redox manipulation |
| ITRC | Interstate Technology and Regulatory Cooperation |
| JAG | jet-assisted grouting |
| K | hydraulic conductivity |
| K_{aquifer} | aquifer hydraulic conductivity |
| K_{cell} | reactive cell hydraulic conductivity |
| MCL | maximum contaminant level |
| meq | milliequivalent(s) |
| MS | matrix spike |
| MSDS | Material Safety Data Sheet |
| mV | millivolts |
| n | porosity |
| NA | not available |
| NAS | Naval Air Station |
| NASA | National Aeronautics and Space Administration |
| NDMA | <i>n</i> -nitrosodimethylamine |
| NERL | National Exposure Research Laboratory |
| NFESC | Naval Facilities Engineering Service Center |
| O&M | operating and maintenance |
| OMB | (U.S. EPA) Office of Management and Budget |
| ORC [®] | oxygen-release compound |
| ORNL | Oak Ridge National Laboratory |
| ORP | oxidation-reduction potential |
| OSHA | Occupational Safety and Health Administration |
| PAH | polycyclic aromatic hydrocarbon |
| PBWG | Permeable Barriers Working Group |
| PCB | polychlorinated biphenyl |
| PCE | perchloroethylene |
| PFLA | phospholipid fatty acid |
| PPE | personal protective equipment |
| ppmv | parts per million by volume |
| PRB | permeable reactive barrier |
| PRC | PRC Environmental Management |
| PRP | potentially responsible party |

| | |
|----------|--|
| P&T | pump-and-treat |
| PV | present value |
| PVC | polyvinyl chloride |
| QA | quality assurance |
| QA/QC | quality assurance/quality control |
| QC | quality control |
| RACER | Remedial Action Cost Engineering and Requirements (System) |
| RCRA | Resource Conservation and Recovery Act |
| RFI | RCRA Facility Investigation |
| RI/FS | Remedial Investigation/Feasibility Study |
| ROD | Record of Decision |
| RTDF | Remediation Technologies Development Forum |
| SEI | secondary electron image(s) |
| SEM | scanning electron microscopy |
| SERDP | Strategic Environmental Research and Development Program |
| SHE | standard hydrogen electrode |
| SI | saturation index |
| SPH | smooth particle hydrodynamics |
| T | temperature |
| TCA | trichloroethane |
| TCE | trichloroethylene |
| TDS | total dissolved solids |
| TOC | total organic carbon |
| TSS | total suspended solids |
| USAF | United States Air Force |
| U.S. EPA | United States Environmental Protection Agency |
| USGS | United States Geological Survey |
| V | volts |
| VC | vinyl chloride |
| VOC | volatile organic compound |
| WSRC | Westinghouse Savannah River Company |
| XRD | x-ray diffraction |

1.0 Introduction

1.1 Project Background

At many sites, groundwater remediation is proving to be a much more difficult and persistent problem than originally thought. One of the more common and difficult groundwater problems presented by United States Department of Defense (DoD) sites and other government and industrial properties is the presence of chlorinated solvent-contaminated soil and groundwater. Chlorinated solvents or chlorinated volatile organic compounds (CVOCs), such as trichloroethylene (TCE) and perchloroethylene (PCE), were commonly used at these sites and properties for aircraft maintenance, dry cleaning, electronics manufacturing, metal finishing, and other operations. These solvents have entered the ground through leaks, spills, or past disposal practices, and there may be more than 600 such sites at Air Force bases across the country. The United States Environmental Protection Agency (U.S. EPA) (1995) estimates that there are 5,000 DoD, United States Department of Energy (DOE), and Superfund sites contaminated with chlorinated solvents.

Because chlorinated solvents often tend to persist in soil and groundwater for several years or decades, their remediation is usually a technically and economically challenging undertaking. The conventional method for addressing groundwater contamination at most sites has been pump-and-treat (P&T) systems. P&T systems extract groundwater from an aquifer, treat it aboveground, and discharge it to a sewer or back to the environment. The energy and labor inputs required to keep these systems operational for many years is a severe economic burden for site owners. Permeable reactive barriers (PRBs) are an innovative technology that offer a passive alternative to conventional P&T systems for addressing long-term groundwater contamination problems. Although PRBs initially were applied to treat CVOC plumes, they also have been applied to treat or capture other contaminants, such as hexavalent chromium and uranium.

The Air Force Research Laboratory (AFRL) at Tyndall Air Force Base (AFB), FL contracted Battelle in Columbus, OH to prepare a design guidance document for the application of permeable barriers (Battelle, 1997a). The first version of this document was issued in February 1997, after being widely reviewed by several members of the Remedial Technologies Development Forum's (RTDF's) Permeable Barriers Working Group (PBWG) and the Interstate Technology and Regulatory Cooperation's (ITRC's) Permeable Barriers Subgroup. The current document is an effort to update the previous design guidance after reviewing the performance of previously installed PRBs and evaluating the design and construction of newer PRB applications, such as the one at Dover AFB. Funding for this project was provided by DoD's Strategic Environmental Research and Development Program (SERDP). A list of relevant points of contact is included as Appendix A.

The objective of this document is to guide site managers, contractors, and state and federal regulators through the process of:

- (a) Determining the technical and economic suitability of a PRB for a given site, and
- (b) Designing, constructing, and monitoring a PRB.

Unlike conventional ex situ technologies, such as P&T systems, in situ technologies are more dependent on site-specific parameters. Therefore, this document does not purport to replace the scientific judgment of the site hydrologist or site engineer. Instead, this document highlights various chemical, biological, and hydrologic issues that affect the application of PRBs to various sites and the options available for resolving these issues.

1.2 Groundwater Remediation Difficulties

One class of groundwater contaminants that has proved to be particularly difficult to remediate is chlorinated solvents. Chlorinated solvents have been used extensively in the past by industry and government for a variety of operations, such as degreasing, maintenance, and dry cleaning. Leaks, spills, and historical disposal practices have led to widespread contamination of the soil and groundwater. Ten of the 25 most common groundwater contaminants at hazardous waste sites are chlorinated solvents, with TCE being the most prevalent (National Research Council, 1994).

Most chlorinated solvents belong to a class of compounds which, when present in sufficient quantity, may form dense, nonaqueous-phase liquids (DNAPLs). DNAPLs are denser than water and therefore move downward in the subsurface until they encounter a low-permeability zone or aquitard. On their way down, solvents typically leave a trail of free-phase residual DNAPL that is virtually immobile and is resistant to pumping. The DNAPLs present in pools or in residually saturated zones provide a long-term source for contaminant releases into groundwater, which often result in large dissolved-phase plumes. Although most chlorinated solvents are sparingly soluble in water, their solubilities are several times higher than the U.S. EPA's maximum contaminant level (MCL) standards for drinking water. Table 1-1 shows the properties of common chlorinated solvents. Because of their low solubilities and mass transfer limitations, chlorinated solvent source zones can persist in the aquifer for several years, decades, or centuries. The dissolved contaminant plume resulting from the source zone can persist for similar lengths of time and has been known to travel large distances because chlorinated solvents are relatively recalcitrant to biodegradation processes at many sites.

Table 1-1. Properties of Common CVOCs

| Compound | MCL (mg/L) | Water Solubility (mg/L at 25°C) | Density (g/cm ³ at 20°C) | Vapor Pressure (Pascals at 25°C) |
|----------------------------------|------------|---------------------------------|-------------------------------------|----------------------------------|
| Carbon tetrachloride | 0.005 | 800 | 1.59 | 15,097 |
| 1,1,1-Trichloroethane | 0.2 | 1,250 | 1.34 | 13,300 |
| 1,2-Dichloroethane | 0.005 | 8,600 | 1.26 | 9,000 |
| Methylene chloride | 0.005 | 20,000 | 1.33 | 46,522 (20°C) |
| Perchloroethylene | 0.005 | 150 | 1.63 | 2,415 |
| Trichloroethylene | 0.005 | 1,100 | 1.46 | 9,910 |
| <i>cis</i> -1,2-Dichloroethene | 0.07 | 3,500 | 1.28 | 26,700 |
| <i>trans</i> -1,2-Dichloroethene | 0.1 | 6,300 | 1.26 | 45,300 |
| Vinyl chloride | 0.002 | 2,000 | 0.91 | 350,000 |

Although one apparent approach to cleaning up these sites is to remediate the DNAPL source zone, in practice this often proves difficult. First, DNAPL source zones are difficult to locate; second, when found, these zones generally are difficult to remediate. Therefore, at many sites, a more viable option is to treat the plume. Conventional P&T systems can be used to capture and treat the plume. However, past experiences at contaminated groundwater sites and recent studies (National Research Council, 1994) have shown the inadequacies of this approach. Also, a P&T system would have to be operated for many years or decades or as long as the source zone and plume persist, and the associated operational costs over several decades can be enormous. The recent development of PRBs has presented a potentially viable alternative to conventional P&T systems.

1.3 The Innovative PRB Technology

Figure 1-1 shows some possible configurations of PRB systems. In its simplest form, a PRB consists of a zone of reactive material, such as granular iron, installed in the path of a dissolved chlorinated solvent plume (Figure 1-1a). As the groundwater flows through the reactive zone, the CVOCs come in contact with the reactive medium and are degraded to potentially nontoxic dehalogenated organic compounds and inorganic chloride. The main advantage of a PRB is that, generally, no pumping or aboveground treatment is required; the barrier acts passively after installation. Because there are no aboveground installed structures, the affected property can be put to productive use while it is being cleaned up. Also, initial evidence indicates that the reactive medium is used up very slowly and, therefore, PRBs have the potential to passively treat the plume over several years or decades, which would result in hardly any annual operating costs other than site monitoring. Depending on the longevity of the reactive medium, the barrier may have to be rejuvenated or replaced periodically; however, it is expected that such maintenance would be required infrequently if at all.

A PRB typically may be installed either as a continuous reactive barrier or as a funnel-and-gate system. A continuous reactive barrier (Figure 1-1b) consists of a reactive cell containing the reactive medium. A funnel-and-gate system (Figure 1-1d) has an impermeable section (or funnel) that directs the captured groundwater flow toward the permeable section (or gate). This configuration may sometimes allow better control over reactive cell placement. However, most recent PRB applications have been continuous reactive barriers. Continuous reactive barriers are easier to install and generate less complex flow patterns compared to funnel-and-gate systems.

1.4 Mechanism of Abiotic Degradation with Metals

Although a variety of reactive media (see Section 4.0) can be used to treat groundwater contaminants, the most commonly used media are zero-valent metals, particularly granular iron. As the zero-valent metal in the reactive cell corrodes, the resulting electron activity is believed to reduce the chlorinated compounds to potentially nontoxic products. Because the reaction mechanism of CVOC degradation with zero-valent iron has been the most widely studied and reported to date, this document focuses on the chemistry of CVOC-iron interactions and groundwater-iron interactions.

The first reported use of the degradation potential of metals for treating chlorinated organic compounds in the environment was by Sweeny and Fischer (1972), who acquired a patent for the

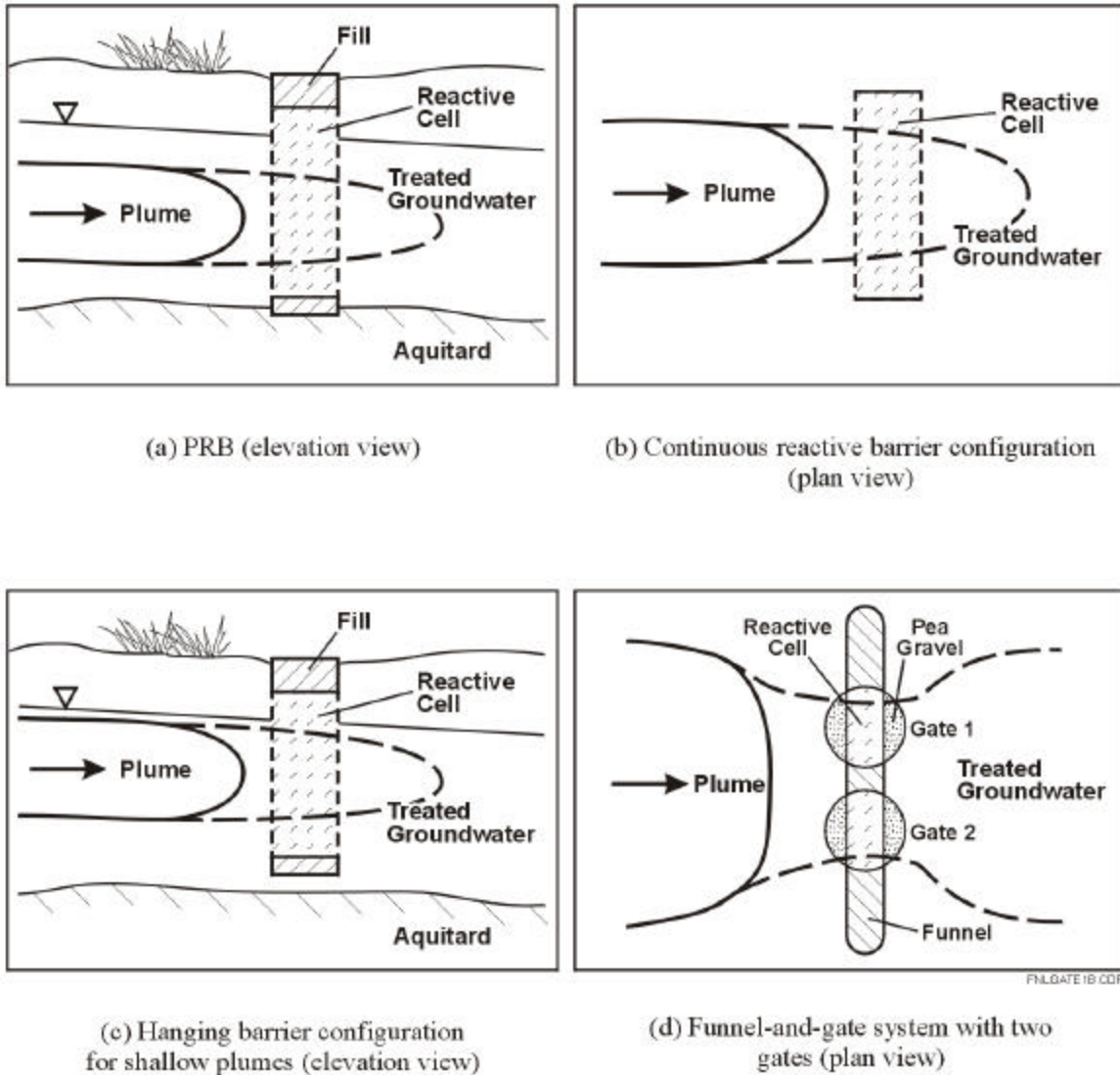
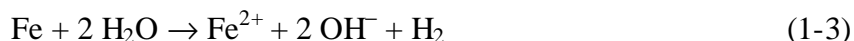
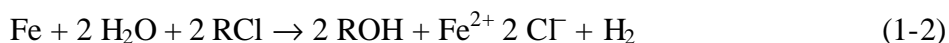

Figure 1-1. Schematic Illustration of Some PRB Configurations

degradation of chlorinated pesticides by metallic zinc under acidic conditions. These researchers found that *p,p'*-dichlorodiphenyltrichloroethane (*p,p'*-DDT) was degraded by zinc at ambient temperatures at a satisfactory rate with ethane as the major product. In two later papers, Sweeny (1981a and 1981b) described how catalytically active powders of iron, zinc, or aluminum could be used to destroy a variety of contaminants, including TCE, PCE, trichloroethane (TCA), trihalomethanes, chlorobenzene, polychlorinated biphenyls (PCBs), and chlordane. The process could be carried out by trickling wastewater through a bed of iron and sand to give suitable retention and flow properties, or by fluidizing a bed of iron powder with the aqueous influent. Sweeny suggested that the reduction proceeds primarily by the removal of the halogen atom and its replacement by hydrogen (Equation 1-1), although other mechanisms probably play a role. Another important reaction suggested was the replacement of a halogen by a hydroxyl group (Equation 1-2). The iron metal also was believed to be consumed by water (Equation 1-3), although this reaction proceeds much more slowly than the other two.



Other researchers such as Senzaki and Kumagai (1988a and 1988b) and Senzaki (1988) also suggested the use of iron powder for removal of TCE and TCA from wastewater. More recently, researchers at the University of Waterloo (Reynolds et al., 1990; Gillham and O'Hannesin, 1992) conducted focused efforts in this area, and were issued a patent for the use of zero-valent metals for in situ groundwater treatment (Gillham, 1993).

The exact mechanism of degradation of chlorinated compounds by iron or other metals is not fully understood. In all probability, a *variety of pathways* are involved, although recent research seems to indicate that certain pathways predominate. If some dissolved oxygen (DO) is present in the groundwater as it enters the reactive iron cell, the iron is oxidized and hydroxyl ions are generated (Equation 1-4). This reaction proceeds quickly, as evidenced by the fact that both the DO and the oxidation-reduction potential (ORP) drop quickly as the groundwater enters the iron cell. The importance of this reaction is that DO can quickly corrode the first few inches of iron in the reactive cell. Under oxygenated conditions, the iron may precipitate out as ferric oxyhydroxide (FeOOH) or ferric hydroxide [Fe(OH)₃], in which case the permeability could potentially become considerably lower in the first few inches of the reactive cell at the influent end. Therefore, the aerobic nature of the groundwater can be potentially detrimental to the technology. However, contaminated groundwater at many sites is not highly oxygenated. Also, engineering controls (see Section 6.0) possibly can be used to reduce or eliminate DO from the groundwater before it enters the reactive cell.



Once DO has been depleted, the created reducing conditions lead to a host of other reactions. Chlorinated organic compounds, such as TCE, are in an oxidized state because of the presence of chlorine. Iron, a strong reducing agent, reacts with the chlorinated organic compounds through electron transfers, in which ethene and chloride are the primary products (Equation 1-5).

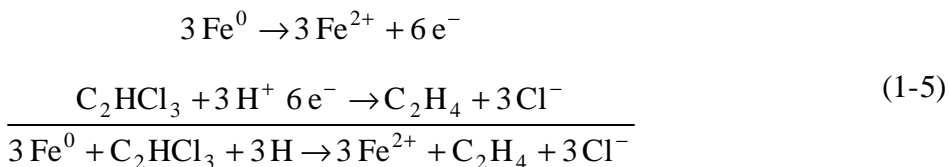

In one study, Orth and Gillham (1996) found that ethene and ethane (in the ratio 2:1) constitute 80% of the original equivalent TCE mass. Partially dechlorinated byproducts of the degradation reaction such as *cis*-1,2-dichloroethene (DCE), *trans*-1,2-DCE, 1,1-DCE, and vinyl chloride (VC) were found to constitute only 3% of the original TCE mass. Additional byproducts included hydrocarbons (C1 to C4) such as methane, propene, propane, 1-butene, and butane. Virtually all the chlorine in the original TCE mass was accounted for as inorganic chloride in the effluent, or as chlorine remaining on the partially dechlorinated byproducts. Similar results were

obtained by Sivavec and Horney (1995), who quantified both liquid and gas phases of the reaction to obtain a carbon balance greater than 90%.

It is unclear whether the reported production of ethane during TCE degradation represents a different pathway or whether it results from the iron-mediated catalytic transformation of ethene. Also unclear is whether the C1 to C4 hydrocarbons represent an alternative pathway for TCE degradation or are the result of some other reaction. One study (Hardy and Gillham, 1996) suggests that aqueous CO₂ is reduced on the iron surface to form these hydrocarbon chains. Another study (Deng et al., 1997) suggests that the source of these hydrocarbons is the acid dissolution of gray cast irons containing both carbide and graphite carbon.

A number of interesting issues are raised by the reaction mechanism as explained in Equation 1-5. For Equation 1-5 to take place in one step without the generation of larger amounts of partially dechlorinated products (e.g., DCE or VC), six electrons must be transferred almost instantaneously. Given the low probability of an instantaneous transfer of this magnitude, Orth and Gillham (1996) suggest that the TCE molecule must remain attached to the metal surface long enough for the six-electron transfer to occur. The TCE molecule remains attached to the metal surface either through the inherent hydrophobicity of TCE or, as Sivavec and Horney (1995) suggest, by the formation of a strong chloroethene-iron pi bond. This bonding prevents desorption until dechlorination is complete, although a few random chloroethene molecules may desorb early, leading to the presence of small amounts of DCE and VC. Overall, these explanations suggest that the degradation of chlorinated organics by metals is a surface phenomenon and that the rate is governed by the specific surface area of the reactive medium.

There is evidence that PCE and TCE in contact with iron may degrade at least partly through a different pathway from the hydrogenolysis pathway discussed above. Experiments by Roberts et al. (1996) indicate that PCE and TCE could be reduced through the β-elimination pathway shown in Figure 1-2 (for TCE only) to dichloroacetylene and chloroacetylene, respectively. Both of these byproducts are potentially toxic, but are likely to be short-lived. Hydrogenolysis could lead to their transformation to lesser chlorinated acetylenes, which could further be reduced to substituted ethenes. Hydrolysis of the chloroacetylenes to acetates is also a possible pathway. Overall, these experiments indicate that there may be multiple pathways (as shown in Figure 1-2) by which chlorinated ethenes, such as PCE and TCE, are transformed in the presence of iron into dehalogenated products such as ethene (Sivavec et al., 1997).

Iron also reacts with water itself under reducing (anaerobic) conditions, although this reaction is believed to be much slower than reactions of iron with halogenated compounds. The slow reaction with water (Equation 1-6) is advantageous to the technology because very little reactive medium (iron) is used up in this side reaction. Hydrogen gas and OH⁻ are formed as water is reduced, as shown in Equation 1-6.

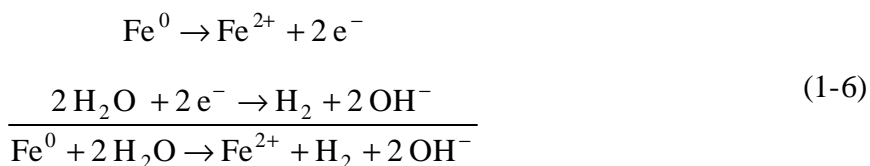

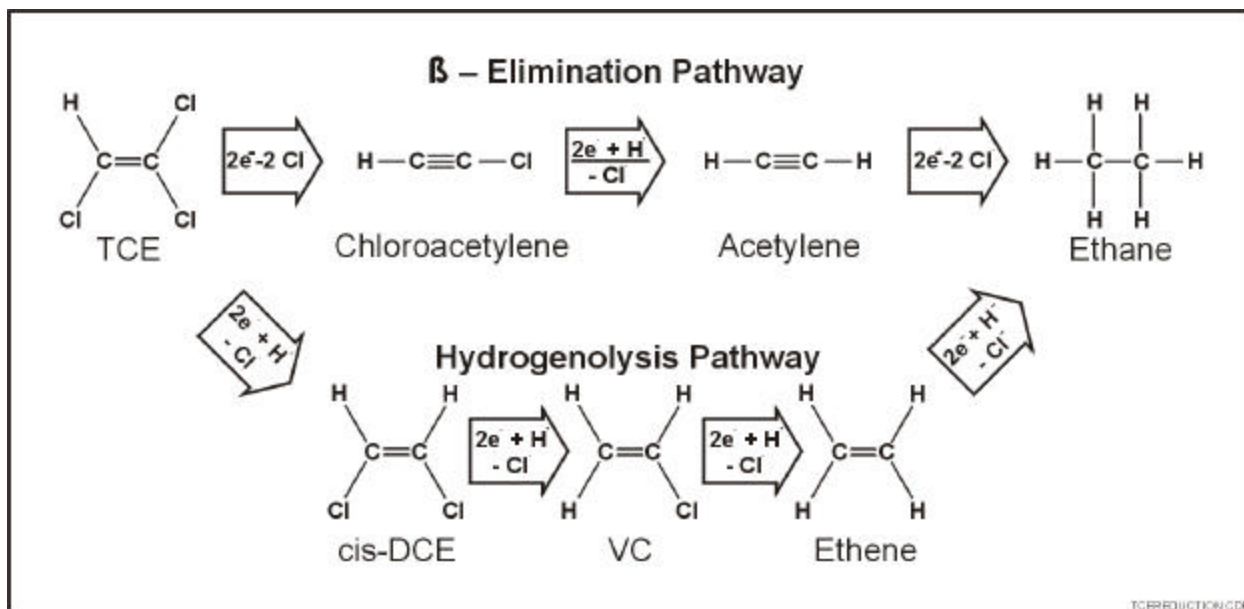
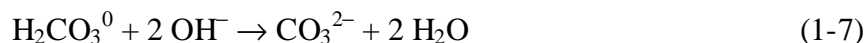

Figure 1-2. Currently Proposed Mechanism for TCE Degradation by Iron

Hydrogen generation could be a concern if hydrogen accumulates in the aquifer as it appears to do in some column tests (Mackenzie et al., 1999). Moreover, hydrogen evolution rates calculated by Reardon (1995) for Master Builder's iron (10-32 mesh) are not insignificant. Apart from the flammability issue, formation of hydrogen could potentially lead to porosity loss and decreased permeability. Column tests have shown porosity losses of 5 to 10% attributable to hydrogen gas buildup (Sivavec, 1999). Because the porosity losses were measured immediately after starting the column tests, it is unlikely that they were caused by mineral precipitation. However, in natural aquifers, hydrogen generated through the reaction shown in Equation 1-6 can degrade through biological transformations (Chiu and Cha, 2000). Therefore, hydrogen buildup has not been identified as a problem at field PRB sites. Hydrogen generation and its fate in natural aquifers is an area requiring further research.

Because several of the above reactions produce OH^- , the pH of the water in the reactive iron cell typically increases, often reaching values above 9.0. One effect of increased pH initially was thought to be a slowing down of the TCE degradation rate (O'Hannesin, 1993), because changes in pH were expected to cause changes in the degradation rate through direct involvement of H^+ (see Equation 1-5). However, subsequent research has raised questions about whether pH affects degradation rate (Agrawal and Tratnyek, 1996).

An indirect effect of increased pH is the potential for precipitates to form, which could coat the surface of the iron and potentially reduce the reactivity of the iron and the hydraulic conductivity of the reactive cell. The dissolved carbonic acid and bicarbonate (alkalinity) present in many natural groundwaters act as buffers limiting pH increase and precipitate formation (Equations 1-7 and 1-8):



Soluble carbonate ions are formed as the OH^- ions are consumed. If carbonate ions continue to build up, however, precipitation of carbonate solid species may occur. Depending on the composition of the groundwater, the precipitates formed could be calcite (CaCO_3), siderite (FeCO_3), or magnesium hydrocarbonates (Reardon, 1995). If groundwater carbonate is exhausted through the precipitation of carbonate minerals, the water may become saturated with respect to $\text{Fe}(\text{OH})_2$ and $\text{Fe}(\text{OH})_3$ as the iron continues to oxidize. $\text{Fe}(\text{OH})_2$ is relatively insoluble and $\text{Fe}(\text{OH})_3$ is extremely insoluble; therefore, both compounds may precipitate if the iron concentration exceeds saturation levels.

In summary, most groundwaters contain many different aqueous species that may play some role in affecting the performance of a PRB. In general, the course of chemical reactions taking place in multi-component systems cannot be predicted by considering each species individually, because most of these reactions are interdependent. To some extent, equilibrium behavior in complex systems can be predicted using geochemical modeling codes, which are described in Sections 6.0 and 8.0. However, many groundwater reactions in PRB systems may not reach equilibrium during the passage of groundwater through the reactive cell. Also, even if the type and mass of reaction products could be predicted, it is unclear how many of these products are actually retained in the reactive cell and how the products affect performance. For example, very fine precipitates that may be formed could be carried out of the reactive cell by colloidal transport with the groundwater flow. It also is unclear whether the precipitates retained in the reactive cell occupy the same reactive sites as those targeted by the contaminants (i.e., CVOCs). However, the reaction chemistry discussed above and the geochemical modeling codes described in Sections 6.0 and 8.0 do provide some basis for selecting appropriate reactive media and assessing the longevity of the media in the groundwater environment at a given site.

1.5 Potential Biologically Mediated Reactions In The Reactive Cell

Microbial growth in the reactive cell can help or hinder the degradation or removal of some types of contaminants. Some reactive media, such as iron, appear to degrade CVOC contaminants primarily through abiotic processes. Similar TCE degradation rates were observed with and without added biocide in column tests with granular iron (Gillham and O'Hannesin, 1994). However, there are indications that microbes could potentially populate the reactive cell and/or the downgradient aquifer under certain conditions.

In one laboratory study (Chiu and Cha, 2000), researchers found that lactate, iron, or hydrogen were able to serve as electron donors in order to sustain a microbial culture from a TCE-contaminated site. These researchers suggest that the microbes used the hydrogen generated during anaerobic iron corrosion for energy and for TCE dechlorination. In this case, microbial activity may be beneficial because it prevents the buildup of hydrogen in an iron reactive cell. However, microbes could potentially enter a field reactive cell through groundwater transport and then populate the reactive medium; if the growth of microbes is excessive, it could lead to biofouling of the reactive cell in the long term.

Microbes can potentially cause biofouling of iron reactive cells over the long term in several ways. For example, three different mechanisms have been identified by which microorganisms can promote $\text{Fe}(\text{III})$ precipitation from the groundwater (Tuhela et al., 1993). The first and most common mechanism for bacteria to produce $\text{Fe}(\text{III})$ is by directly using $\text{Fe}(\text{II})$ as an energy

source. These bacteria include *Thiobacillus ferrooxidans* and *Leptospirillum ferrooxidans*. However, these bacteria are acidophiles, and although they may be present in acidic soils, they probably would not be expected to proliferate in alkaline environments produced by zero-valent iron. The second mechanism is one that relies on a process available to stalked and sheathed bacteria, which is to oxidize Fe(II) on sheath surfaces. *Gallionella* and *Leptothrix* spp. are two such bacteria that appear to be involved in Fe(II) oxidation (Tuhela et al., 1993), and sulfide- and thiosulfate-dependent forms also have been reported (Lütters-Czekalla, 1990). Extensive biofouling by stalked and sheathed bacteria has been detected in water wells (Tuhela et al., 1993) and accumulation of stalked iron bacteria in sand filters used for iron removal also have been reported (Czekalla et al., 1985). By this mechanism, growth of stalked and sheathed bacteria potentially can occur in the reactive cell iron or in the downgradient aquifer. The third mechanism involves heterotrophic bacteria that use carbon in organo-ferric complexes. Biodegradation of organo-ferric complexes would liberate Fe(III), resulting in rapid precipitation of ferric hydroxide. However, this third mechanism may not be a primary source of ferric hydroxide precipitation in DNAPL-contaminated groundwaters, unless a strong Fe(III) chelant is also present.

A concomitant occurrence is the oxidation of ferrous iron or Mn(II) by microbially mediated reactions and the subsequent precipitation of ferric or Mn(IV) hydroxides. Iron-related biofouling has been attributed to various types of clogging problems in groundwater treatment systems (Chapelle, 1993), and there has been speculation that such problems may be encountered in the reactive cell of a PRB or in the downgradient aquifer. Ferric hydroxides can precipitate as amorphous Fe(OH)₃, or they may develop a crystalline structure such as ferrihydrite (5 Fe₂O₃•9 H₂O). Ferrihydrite has been identified as the solid phase in biofouled water wells (Carlson and Schwertmann, 1987; Tuhela et al., 1992). In general, ferric hydroxides have very low solubilities at neutral and alkaline pH; hence, oxidation of Fe(II) is accompanied by nearly complete removal of iron from the aqueous solution by precipitation.

Despite these possibilities, groundwater and iron/soil core samples collected from reactive cells and from downgradient aquifers at PRB sites show no signs of any significant PRB-induced microbial growth, after two to five years of operation at sites such as the former Naval Air Station (NAS) Moffett Field, Dover AFB, and the Intersil site in Sunnyvale, CA (Battelle, 1998; Battelle, 2000; EnviroMetal Technologies, Inc. [ETI], 1999). More research is needed on the potential role of microbial interactions in primarily abiotic media, such as iron. Interestingly, some reactive media may actually be selected for the beneficial role that microbial processes play in contaminant degradation/removal (see Section 4.1.4.5).

2.0 The Design Methodology

The overall methodology for the application of a PRB at a given site is shown in Figure 2-1. PRB design involves the following steps:

- ❑ Preliminary assessment
- ❑ Site characterization
- ❑ Reactive media selection
- ❑ Treatability testing
- ❑ Modeling and engineering design
- ❑ Selection of a suitable construction method
- ❑ Monitoring plan preparation
- ❑ Economic evaluation.

The preliminary assessment is conducted to evaluate the technical and economic suitability of a given site for PRB application. Once a site is determined to be suitable, additional design steps are initiated.

2.1 Preliminary Assessment

Typically, the first assessment that site managers must make is whether or not the site is suitable for a PRB application (see Figure 2-2).

2.1.1 Preliminary Technical Assessment

The factors that need to be considered to determine the suitability of a site for PRB application are listed below. Although an unfavorable response to any of the following factors does not necessarily rule out the use of a PRB, it can make the application more difficult or costly:

- ❑ **Contaminant Type.** Are the contaminants of a type reported in scientific and technical literature as amenable to degradation by suitable (i.e., commercially available, relatively inexpensive, and benign to the environment) reactive media? Table 2-1 lists the contaminants that are currently reported as either amenable or recalcitrant to abiotic degradation with iron. An economically feasible half-life is necessary to support the application. As alternative media or enhancements are discovered, more contaminants may come within the scope of this technology.
- ❑ **Plume Size and Distribution.** Is the plume very wide or very deep? Very wide or very deep plumes will increase the cost of the application. However, at least two sites currently have installed PRBs that are more than 1,000 ft wide (see Section 10.0). Depth of the plume or depth of the aquitard may be a more significant cost consideration.

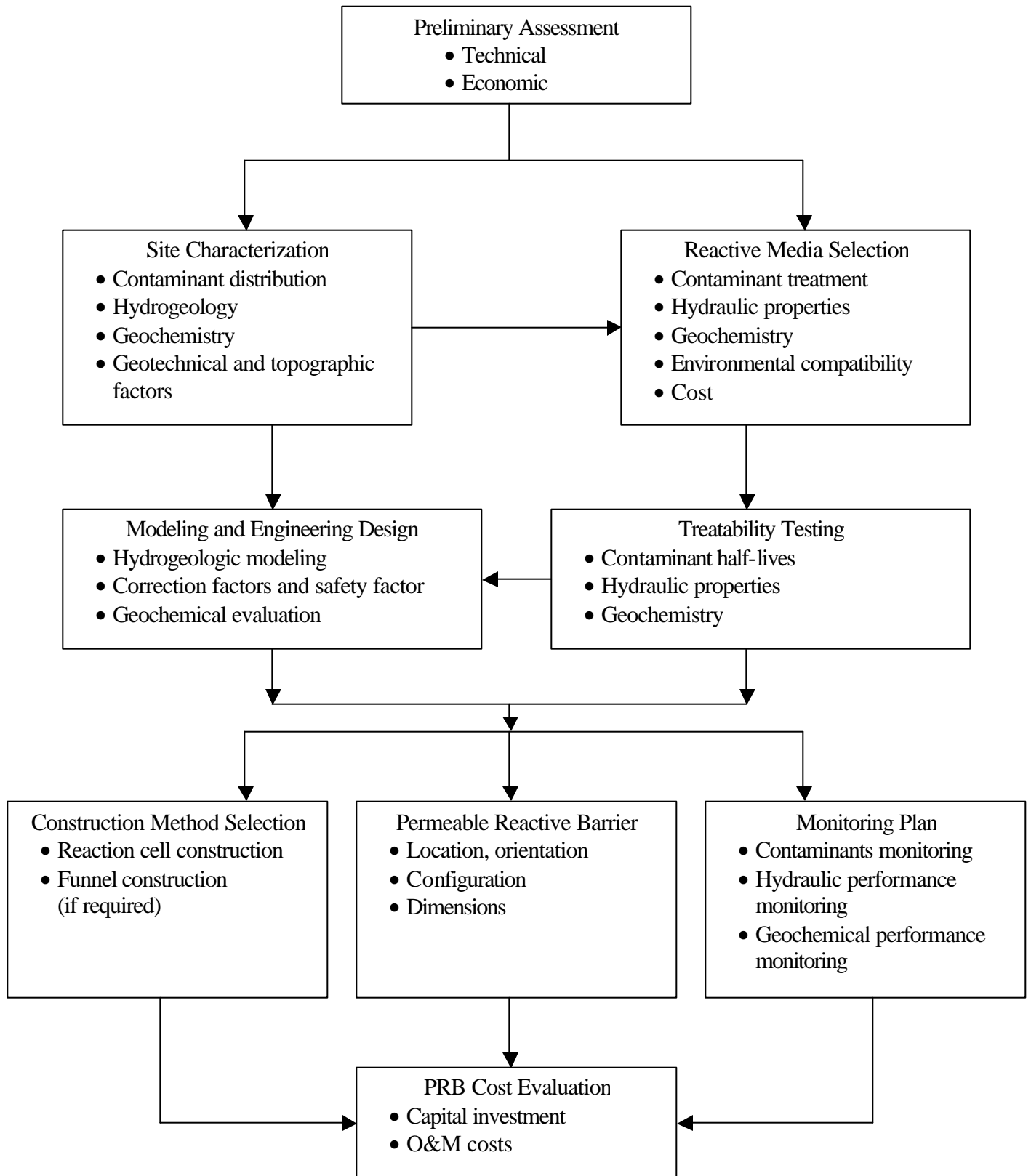

Figure 2-1. Design Methodology for a PRB Application

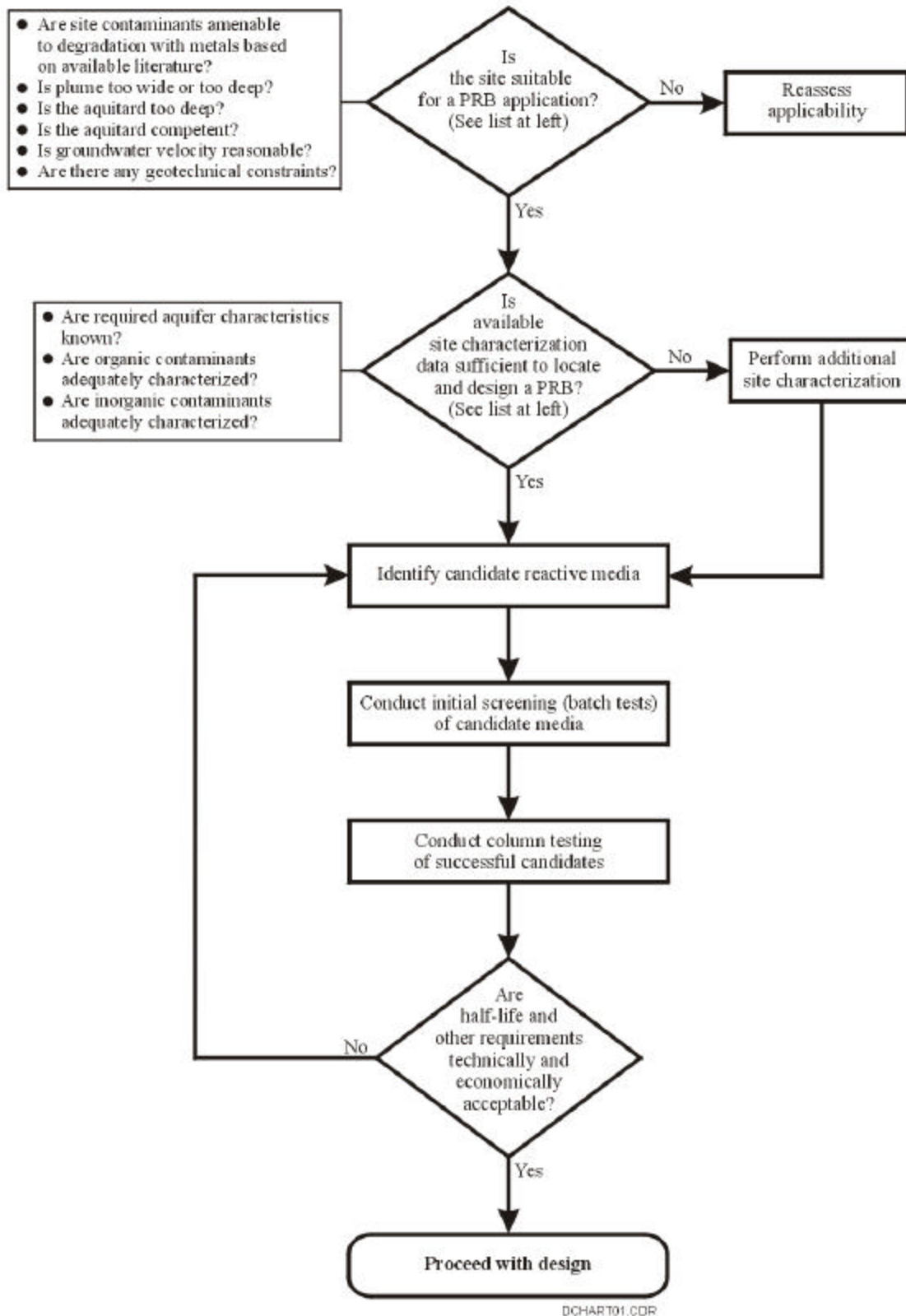

Figure 2-2. Preliminary Assessment of the Suitability of a Site for PRB Application

Table 2-1. Compounds Tested and Half-Lives Normalized to 1 m² Iron Surface per mL Solution (Adapted from Gillham, 1996 and other sources listed in the footnotes)

| Organic Compounds | Pure Iron^(m) t_{1/2} (hr) | Commercial Iron^(m) t_{1/2} (hr) |
|--|--|--|
| <u>Methanes</u> | | |
| Carbon tetrachloride | 0.02 ^(a) , 0.003 ^(g) , 0.023 ⁽ⁱ⁾ | 0.31-0.85 ^(b) |
| Chloroform | 1.49 ^(a) , 0.73 ^(g) | 4.8 ^(b) |
| Bromoform | 0.041 ^(a) | |
| <u>Ethanes</u> | | |
| Hexachloroethane | 0.013 ^(a) | NA |
| 1,1,2,2-Tetrachloroethane | 0.053 ^(a) | NA |
| 1,1,1,2-Tetrachloroethane | 0.049 ^(a) | NA |
| 1,1,1-Trichloroethane | 0.065 ^(a) , 1.4 ^(h) | 1.7-4.1 ^(b) |
| 1,1-Dichloroethane | NA | NA |
| <u>Ethenes</u> | | |
| Tetrachloroethene | 0.28 ^(a) , 5.2 ^(h) | 2.1-10.8 ^(b) , 3.2 ^(e) |
| Trichloroethene | 0.67 ^(a) , 7.3-9.7 ^(g) , 0.68 ^(j) | 1.1-4.6 ^(b) , 2.4 ^(e) , 2.8 ^(f) |
| 1,1-Dichloroethene | 5.5 ^(a) , 2.8 ^(h) | 37.4 ^(e) , 15.2 ^(f) |
| <i>trans</i> -1,2-Dichloroethene | 6.4 ^(a) | 4.9 ^(b) , 6.9 ^(e) , 7.6 ^(f) |
| <i>cis</i> -1,2-Dichloroethene | 19.7 ^(a) | 10.8-33.9 ^(b) , 47.6 ^(e) |
| Vinyl chloride | 12.6 ^(a) | 10.8-12.3 ^(b) , 4.7 ^(e) |
| <u>Other Organics</u> | | |
| 1,1,2-Trichlorotrifluoroethane (Freon 113) | 1.02 ^(b) | NA |
| 1,2,3-Trichloropropane | NA | 24.0 ^(c) |
| 1,2-Dichloropropane | NA | 4.5 ^(c) |
| 1,3-Dichloropropane | NA | 2.2 ^(c) |
| 1,2-Dibromo-3-chloropropane | NA | 0.72 ^(b) |
| 1,2-Dibromoethane | NA | 1.5-6.5 ^(b) |
| <i>n</i> -Nitrosodimethylamine (NDMA) | 1.83 ^(b) | NA |
| Nitrobenzene | 0.008 ^(d) | NA |
| <u>Inorganics</u> | | |
| Chromium ^{(k)(l)} , nickel ^(l) | NA | NA |
| Uranium ^(l) | NA | NA |
| Nitrate ^(l) | NA | NA |
| <u>No Apparent Degradation</u> | | |
| Dichloromethane ^{(a)(g)(h)} | NA | NA |
| 1,4-Dichlorobenzene ^(h) | NA | NA |
| 1,2-Dichloroethane ^(b) | NA | NA |
| Chloromethane ^(b) | NA | NA |

(a) Gillham and O'Hannesin (1994)

(b) ETI (1997)

(c) Focht (1994)

(d) Agrawal and Tratnyek (1994)

(e) Sivavec and Horney (1995)

(f) Mackenzie et al. (1995)

(g) Matheson and Tratnyek (1994)

(h) Schreier and Reinhard (1994)

NA = Not available.

(i) Lipczynska-Kochany et al. (1994)

(j) Orth and Gillham (1995)

(k) Blowes et al. (1997)

(l) WSRC (1999)

(m) The half-lives reported in this table are for illustration purposes only. Contaminant half-lives may vary depending on the iron source and site-specific groundwater chemistry.

- ❑ **Aquifer Depth.** Is the aquifer very deep? If the aquitard is very deep and the barrier must be keyed into it, the construction costs could be high. For many chlorinated solvent applications, the PRB may have to be keyed in because of the potential for underflow of contaminants. If a hanging barrier configuration is used (that is, the PRB does not extend all the way down to the aquitard) for shallow plumes, detailed site characterization and hydrologic modeling will have to be conducted in order to demonstrate to stakeholders that plume underflow will not occur. Currently, PRBs can be installed to depths of 25 to 30 ft using relatively inexpensive excavation equipment, such as a standard backhoe. At greater depths, relatively more expensive commercial methods may have to be deployed, such as clamshell or caisson excavation. Some innovative construction techniques, such as jetting, have been tested at some sites to overcome depth and cost constraints (see Section 7.0). Individual construction contractors generally can provide site managers with guidance on whether the particular construction technique that they offer is feasible for the specific site characteristics involved.
- ❑ **Geotechnical Considerations.** Are there any geologic features at the site that may make installation more difficult? The presence of consolidated sediments or large gravel or rocks may make some types of construction more difficult. Caissons, for instance, may bend or get caught in such formations. Aboveground structures, such as buildings, that are in the vicinity of the installation may impede the maneuverability of construction equipment.
- ❑ **Competent Aquitard.** Is the aquitard very thin or discontinuous? If so, keying the PRB into the aquitard could be difficult. If there is a possibility that the aquitard could be breached during construction of the PRB, thus causing contamination to migrate into the lower aquifer zone, then the application should be reassessed.
- ❑ **Groundwater Velocity.** Is the groundwater velocity too high? If the velocity is high, the reactive cell thickness required to obtain the desired design residence time may also be high and the barrier could become costly. However, PRBs have been installed at sites with groundwater velocities as high as 3 ft/day. A site with very slow-moving or stationary groundwater may also not be particularly suitable because of the dependence of the PRB on achieving passive contact with the groundwater (plume) flow.

2.1.2 Preliminary Economic Assessment

Instead of going through the entire design process and then performing a detailed cost evaluation for the PRB application, it may be desirable to prepare a rough cost estimate during the preliminary assessment stage itself. The preliminary cost evaluation includes a rough cost estimate for a PRB and other competing remediation option(s), such as a P&T system or air sparging, for a given site. Section 9.0 contains the methodology for preparing and comparing the cost estimates for a PRB and a P&T system for plume control/treatment. Appendix B contains an example of a cost evaluation conducted for a PRB site.

A rough estimate can be obtained for most capital investment and operating and maintenance (O&M) cost components for comparison between PRB and a competing technology without preparing a detailed PRB design. The only two exceptions are the reactive medium and PRB construction costs; these two elements require some guesses as to the dimensions and construction method that will be used. However, if the preliminary economic assessment is viewed as an extension of the technical feasibility determination for the PRB application, it may be possible to arrive at a reasonably good cost estimate during preliminary discussions with reactive medium suppliers and construction contractors. Multiple design and construction scenarios may have to be prepared in order to obtain a cost range for the two technologies. As seen in Appendix B, although preconstruction costs constitute a significant portion of the total costs of a PRB, these costs tend to be fairly similar no matter what technology is used. The same is the case with post-construction monitoring costs, which tend to be approximately the same for most technologies. Therefore, preconstruction and monitoring costs could be ignored at the preliminary assessment stage and the focus should be on cost estimates for the reactive medium, construction, and O&M costs of the competing technologies. Significant differences are likely to show up between the O&M costs of active and passive technologies.

Although there may still be some uncertainty in the costs developed at this stage, a preliminary cost assessment performed at this stage would make site managers aware of the cost ramifications of various design scenarios pursued later during detailed design. If nothing else, a qualitative evaluation of the factors listed in Section 2.1.1 from a cost perspective will give site managers some idea about whether any of these factors are likely to make the costs of a PRB application relatively high or relatively low.

Section 10.0 summarizes the reactive medium and construction costs encountered at various PRB sites and could be used to obtain some idea of the costs involved. Note that most of the site-specific cost estimates mentioned in Section 10.0 do not include preconstruction costs (costs for site characterization, modeling and engineering design, and procurement process) or post-construction (i.e., O&M) costs.

2.2 Site Characterization

If a preliminary assessment shows that the site is suitable, the next issue is whether or not the available site characterization data are sufficient to locate and design the PRB. If the site information is inadequate for the purpose, additional site characterization may be required. Section 3.0, Site Characterization, describes the site information that is required and discusses the tools available to collect this information. The important site information required includes the following:

- **Aquifer Characteristics.** The aquifer characteristics that should be known include groundwater depth, depth to aquitard, aquitard thickness and continuity, groundwater velocity, lateral and vertical gradients, site stratigraphy/heterogeneities, hydraulic conductivities of the different layers, porosity, and dimensions and distribution of the plume. This information is required to assist in hydrogeologic modeling performed to locate and design the barrier.

- ❑ **Organic Composition of the Groundwater.** The types of chlorinated solvent compounds and the concentrations should be known. This information will be used to select appropriate reactive media, conduct treatability tests, and design the thickness of the wall.
- ❑ **Inorganic Composition of the Groundwater.** This information is required to evaluate the long-term performance of the PRB and select appropriate reactive media. Knowledge of the presence and concentrations of calcium, magnesium, iron, alkalinity (bicarbonate), chloride, nitrate, and sulfate can be used to evaluate the potential for precipitate formation that may affect the reactivity and hydraulic performance of the PRB. Field parameters such as pH, ORP, and DO also are good indicators of conditions conducive to formation of precipitates.
- ❑ **Geotechnical and Topographic Considerations.** Underground (e.g., utility lines or rocks) and aboveground (e.g., buildings or utility lines) structures that could impede the construction of the barrier need to be identified and evaluated.

2.3 Reactive Media Selection

Once the required site characterization data have been obtained, the next step is to identify and screen candidate reactive media. Section 4.0, Reactive Media Selection, discusses the various media available and the factors affecting their selection. The main considerations in identifying initial candidates are as follows:

- ❑ **Reactivity.** The candidate medium should be able to degrade the target contaminants within an acceptable residence time. Generally, the shorter the half-life of the contaminant with a given media, or higher the reaction rate constant, the better the media. Table 2-1 shows the ranges of half-lives of several contaminants that are degraded by iron. Any alternative medium selected should have comparable or better reactivity, unless other factors (such as the following five factors) dictate a trade-off.
- ❑ **Hydraulic Performance.** Selection of the particle size of the reactive medium should take into account the trade-off between reactivity and hydraulic conductivity. Generally, higher reactivity requires lower particle size (higher total surface area), whereas higher hydraulic conductivity requires larger particle size.
- ❑ **Stability.** The candidate medium should be able to retain its reactivity and hydraulic conductivity over time. This consideration is governed by the potential for precipitate formation and depends on how well the candidate medium is able to address the inorganic components of the site groundwater. One important characteristic of the groundwater that limits precipitate formation is alkalinity, which acts as a buffer. If natural buffers are absent from the groundwater, a reactive medium that provides the required buffering capacity could be incorporated.
- ❑ **Environmentally Compatible Byproducts.** The byproducts generated during degradation should not have deleterious effects of their own on the environment. For example, during degradation of TCE by iron, small amounts of potentially toxic byproducts (such as vinyl chloride) may be generated (see Section 1.0). However,

given sufficient residence time for groundwater flow through the reactive cell, these byproducts are themselves degraded to potentially nontoxic compounds. Any alternative reactive medium selected should demonstrate similar environmental compatibility.

- ❑ **Construction Method.** Some innovative construction techniques, such as jetting, may require a finer particle size of the reactive medium.
- ❑ **Availability and Price.** The candidate medium should be easily available in large quantities at a reasonable price, although special site considerations may sometimes justify a higher price.

2.4 Treatability Testing

Section 5.0 describes the treatability tests that can be conducted to determine some of the design parameters for a PRB. Following identification of candidate reactive media, batch tests could be performed to quickly screen several candidate media. If only one or two candidates have been identified, screening by batch testing could be forgone in favor of column tests. Column tests are more representative of dynamic field conditions than batch tests and provide more accurate design information. Column tests are conducted to select the final reactive medium and determine half-lives and residence times. It is recommended that column tests be performed with groundwater obtained from the site to generate representative design data.

2.5 Modeling and Engineering Design

Once data is obtained from site characterization and laboratory testing, it can be used for conducting modeling of different hydrogeologic and geochemical scenarios and engineering designs to determine the location, orientation, configuration, and dimensions of the PRB. Section 6.0 describes the modeling and engineering design process involved. An iterative process is required to some extent between modeling/design and choice of construction method. For example, if caissons are used for installing the reactive medium in the ground, a funnel-and-gate type configuration may be designed to provide the required plume capture width. If backhoe excavation is used, a continuous reactive barrier configuration may be more suitable. Different PRB configurations will generate different flow velocities and therefore different reactive cell thickness requirements.

Hydrologic modeling (see Section 6.1) is an important tool that can be used to define many aspects of the design. Several hydrogeologic models are available for modeling a PRB flow and transport system. Appendix C describes the various flow and particle transport models available and their main features. Widely available and validated models such as MODFLOW and its enhancements are generally sufficient to achieve PRB design objectives. Hydrogeologic modeling, along with site characterization data, is used for the following purposes:

- ❑ **Location of Barrier.** Determine a suitable location for the PRB with respect to the plume distribution, site hydrogeology, and site-specific features, such as property boundaries and underground utilities.

- ❑ **PRB Orientation.** Design the best PRB orientation that will capture the maximum flow with the minimum reactive cell width, given the seasonal variations in flow direction.
- ❑ **Barrier Configuration.** Determine a suitable PRB configuration (e.g., continuous reactive barrier or funnel-and-gate system).
- ❑ **Barrier Dimensions.** Modeling can be used with the site characterization and laboratory testing data to determine a suitable width and thickness of the reactive cell and, for a funnel-and-gate configuration, the width of the funnel.
- ❑ **Hydraulic Capture Zone.** Estimate hydraulic the capture zone for a given PRB design.
- ❑ **Design Trade-Offs.** Identify a balance between hydraulic capture zone and flow-through thickness of the reactive cell (gate), which are interdependent parameters.
- ❑ **Media Selection.** Help in media selection and long-term performance evaluation by specifying required particle size (and hydraulic conductivity) of the reactive medium with respect to the hydraulic conductivity of the aquifer.
- ❑ **Longevity Scenarios.** Evaluate future scenarios whereby reduced porosity resulting from precipitate formation could potentially cause flow to bypass the reactive cell. This evaluation gives an indication of the safety factors needed in the design.
- ❑ **Monitoring Plan.** Assist in planning appropriate monitoring well locations and monitoring frequencies.

Geochemical evaluation (see Section 6.4) of the site also can commence while treatability tests are in progress, although knowledge of the inorganic composition of the influent and effluent from column tests is helpful to the evaluation. Geochemical evaluation may consist simply of a qualitative assessment of the potential for precipitate formation in the reactive cell based on site characterization and treatability test data. Numerical geochemical codes may or may not be used, depending on site objectives. Most available geochemical models are predictive and based on equilibrium codes, although inverse modeling codes can be used to back-calculate the mass of precipitating and dissolving compounds along a known flowpath.

2.6 Construction Method

Once the location, configuration, and dimensions of the PRB have been designed, the best way to install the barrier in the ground needs to be determined. Section 7.0, Construction Methods, describes the various techniques available for installing the reactive cell and funnel walls (in case the barrier is a funnel-and-gate design). Because the technical feasibility and cost of a construction method depends to a large extent on the depth below ground surface (bgs) that needs to be accessed, the depth of the aquitard is the primary parameter governing selection of the construction method at a given site. Geotechnical considerations, such as presence of rocks or highly consolidated sediments, also may affect the viability of the technique used. Section 7.0 discusses

both conventional construction methods (such as backhoe excavation, sheet pile walls, and slurry walls) and innovative methods (such as caissons and jetting).

2.7 Monitoring the Performance of a PRB

Once the construction of the barrier is complete, the barrier will need to be monitored for as long as the plume is present. Section 8.0 discusses PRB monitoring requirements in terms of the locations, frequency, and type of monitoring. Target contaminants (and their byproducts), hydraulic flow characteristics, and geochemistry (PRB longevity indicators) are the main categories of parameters that are monitored. A monitoring plan generally is prepared along with the design report, and both documents play a significant role in obtaining regulatory approval for PRB application.

2.8 PRB Economics

Detailed estimates of the capital investment and O&M costs of a PRB can be prepared once the engineering design is complete. Section 9.0 discusses the methodology for estimating the costs of a PRB and a competing technology, such as P&T. For both PRB and P&T options, the capital investment is incurred immediately, but the O&M costs are spread over several years or decades of operation. To consolidate present and future costs into a total cost in today's dollars, a present value (PV) or discounted cashflow approach is used. In this approach, future costs are reduced to their PV by incorporating the time effects of inflation, productivity, and risk.

One significant unknown in the cost evaluation is the *longevity* of the reactive medium, a term that refers to the time during which the PRB retains the desired reactive and hydraulic performance. Because existing PRBs have been operational only for about five years, and because most geochemical assessment tools (e.g., modeling, inorganic analysis of groundwater, and analysis of field cores of reactive media) have been primarily qualitative rather than quantitative or predictive, it is unclear how long a PRB may be expected to retain its performance. In a PV analysis of costs, it is important to know not only how much the replacement/regeneration of the reactive medium will cost, but also when in the future it will have to be done. In the absence of a longevity prediction, the methodology outlined in Section 9.0 stresses development of multiple longevity scenarios. In other words, multiple PV cost estimates of a PRB application are obtained assuming different longevities. This multiple-estimate process allows site managers to assess their expectations of the longevity of the reactive medium in terms of the minimum longevity required for the PRB application to be more cost-effective than a competing technology.

Any economic benefits of the PRB application may be included in the evaluation as an offset, or reduction, to capital investment or O&M costs. Economic benefits may accrue, for example, from being able to put the property to more productive use (because of the absence of above-ground treatment structures and the need to operate those structures). Intangible benefits of the PRB, such as the long-term risk reduction achieved, also should be considered.

3.0 Site Characterization

In comparison with a P&T system, a PRB is a relatively permanent structure. For a P&T system, locations of pumping wells, pumping rates, and aboveground treatment methods can be changed or modified as understanding of the site grows. However, once installed, a PRB is difficult to relocate and change, so it is important to understand the site as well as possible before installing a PRB. The following aspects of the site are important to know:

- ❑ Hydrogeology of the site
- ❑ Contaminant distribution in the groundwater
- ❑ Geochemical composition of the groundwater
- ❑ Geotechnical and topographic features.

Seasonal variations in such factors as flow and rainfall events could affect some of these site features, so quarterly data collected over a period of one year are desirable. However, at many sites, site managers must work with the data that are available. It may be useful to note that many of the performance problems encountered at PRB sites have been due to hydraulic issues, such as inadequate plume capture or inadequate residence time.

Table 3-1 contains a list of parameters that are generally required to determine the suitability of a site for PRB treatment and to establish treatability testing and computer modeling parameters.

Table 3-1. Suggested Site Characterization Parameters for a Prospective PRB Site

| Objective | Parameters | Comments |
|---------------------------------------|---|---|
| Contaminant Distribution | Target contaminants (e.g., TCE, PCE, DCE, VC, and Cr) | Horizontal and vertical distribution through multi-level or cluster wells for thicker aquifers; horizontal distribution through long-screen wells for thinner aquifers. |
| Site Hydrogeology | Site stratigraphy Hydraulic gradient Hydraulic conductivity (K) distribution Particle size distribution in aquifer Porosity of aquifer | In the plume, with special emphasis in the vicinity of prospective PRB location; may be conducted in two steps at some sites. |
| Site Geochemistry | Field parameters (ORP, DO, pH, and conductivity) Cations (e.g., Ca, Mg, Fe, and Mn) Anions (e.g., SO ₄ , Cl, NO ₃ /NO ₂ , and alkalinity) TOC and DOC | Horizontal and vertical distribution through multi-level or cluster wells for thicker aquifers; horizontal distribution through long-screen wells for thinner aquifers. |
| Geotechnical and Topographic Features | Consolidated sediments Overhead utility lines/other structures Underground utility lines/other structures | Evaluate accessibility of prospective PRB location to construction equipment; evaluate underground features that may cause difficulties for construction. |

3.1 Hydrogeology of the Site

The requirements for groundwater flow system characterization include data on geologic and hydrologic parameters. A preliminary characterization of the site geology is necessary to identify formation characteristics that may affect groundwater flow, contaminant movement, and permeable wall design. A search for background geologic information should be completed as part of this characterization. In many cases, some of the needed information is available from previous site characterization studies. Remedial Investigation/Feasibility Study (RI/FS) reports, Record of Decision (ROD) reports, RCRA Facility Investigation (RFI) reports, and/or groundwater modeling reports are good sources of initial information. Sometimes, additional site-specific characterization may be needed to support the feasibility study, site selection, and design of the PRBs. Although the regional geology and groundwater flow regime generally is known on a property-wide scale, local information often must be obtained through additional characterization. (The term “local” implies that the information is required on the scale of the plume and in the immediate vicinity of the proposed barrier location. In fact, relatively smaller plumes generally require greater local detail than is available in most site reports.)

3.1.1 Local Hydrogeology

Any pre-existing geological background and site information should be assembled and a preliminary conceptualization of the subsurface geologic features should be completed. This model should have general information on the site-wide lithology, various aquifer layers and confining units, contaminant plume configuration, and factors such as precipitation. A conceptualization of the lithologic variations also should be developed. These variations have a significant impact on aquifer heterogeneity, which may be the most important control on the groundwater flow system and placement of the PRB. This preliminary assessment should be used as a basis for further delineation of the local geology for PRB installation.

At the local scale, the most significant data to be collected include variations in the depth, thickness, lithology, and water levels of different hydrogeologic units. Data collection is achieved by drilling and sampling several locations by conventional drilling or newer characterization techniques, such as cone penetrometer testing (CPT) or Geoprobe[®] sampling. The number and locations of boreholes and samples required for the site heterogeneity assessment should be based on the scientific judgment of the on-site hydrogeologist and on the availability of pre-existing data. At relatively homogeneous sites, only a few boreholes are needed to characterize the site adequately. However, at sites with heterogeneous sediments or channeling, a large number of boreholes are needed before a reliable picture of the subsurface features can be developed. Most of the information for geologic characterization can be collected from soil borings and observation of core samples. The physical properties of the sediments can be determined using borehole logging techniques. CPT rigs have been particularly useful for this. In addition, the CPT or Geoprobe[®] borings also can be used for collecting one-time groundwater samples from specific depth intervals. Some or all of the boreholes may be converted to permanent groundwater monitoring wells for periodic and/or continuous water-level measurements and groundwater sampling. Additionally, these wells also can be used for determination of hydraulic conductivity (K) and porosity (n) by pumping or slug tests. Some of the monitoring wells should be installed as clusters which are screened at different depths to evaluate vertical hydraulic gradients.

Some intact formation samples (e.g., cores, split-spoons, and/or thin-walled tubes) should be collected to provide a field description of the geological conditions and to identify or estimate hydrogeologic properties of the aquifer. Formation samples can be analyzed to measure physical properties (e.g., grain size, mineralogy, lithology, and texture) and hydrogeologic properties (e.g., porosity and permeability). Samples should be described and logged in the field and, if appropriate, submitted to a laboratory for analysis. Laboratory analysis of porosity can be used in the development of design requirements for the PRBs because the determinations of residence times, flow velocity, and discharge are based on these hydrogeologic properties. Other laboratory analyses can be completed to evaluate concentrations of adsorbed contaminants and to evaluate geochemical properties, such as organic carbon content of the aquifer material.

Once all of the field and laboratory data have been obtained, site-specific geologic cross sections should be prepared to evaluate the lithologic variations at the site. In addition, water-level measurements from shallow and deep hydrostratigraphic units (HSUs) should be plotted on the cross section to evaluate the vertical hydraulic gradients across the adjacent aquifers. An example of a detailed hydrogeologic cross section for PRB site characterization at Dover AFB is shown in Figure 3-1. This cross section shows the correlation for soil lithology based on CPT logging of soil properties, on water-level measurements, on depths to aquitard, and on concentrations of key contaminants in the boreholes. Several such cross sections were developed (Battelle, 1997b) for the site as part of the PRB design. Similarly, at former NAS Moffett Field, geologic data from several boreholes and numerous CPTs were used (Battelle, 1998) to delineate the location of the sand channel at the site (see Section 6.1.3). The local-scale lithologic cross sections at this site were also correlated with the Base-wide maps of subsurface sand channel deposits that act as preferential pathways for most of the groundwater flow and contaminant transport. The pilot-scale PRB was placed across one of these channels, and the funnel walls were placed across the finer-grained interchannel deposits.

3.1.2 Determination of Groundwater Velocity and Direction

Hydrologic or groundwater flow parameters are important in PRB design because these parameters determine the groundwater capture zone, and the location, orientation, configuration, and dimensions of the PRB. The objectives of taking hydrologic measurements are to estimate the groundwater flow velocity and direction in the prospective PRB location. These objectives can be achieved through measurement of aquifer properties and the use of Darcy's Law, through tracer testing, or through direct measurement with appropriate probes. Most available probes are in various stages of development and evaluation; therefore, at most sites, the most reliable method of estimating groundwater velocity and direction involves using water-level measurements along with Darcy's Law.

3.1.2.1 Groundwater Flow Direction

Groundwater flow directions are determined using a water-table or potentiometric surface map based on water-level measurements made at the site. Groundwater flow is perpendicular to the equipotential lines expressed on a map as contours of water-table or potentiometric surface elevation. For simple flow fields, groundwater flow directions may be determined using a three-point problem approach. At most sites, however, sufficient measurements should be taken to delineate localized variations in the flow field using contour maps. Maps should be constructed for several different measurement events to determine the range of seasonal hydraulic variations

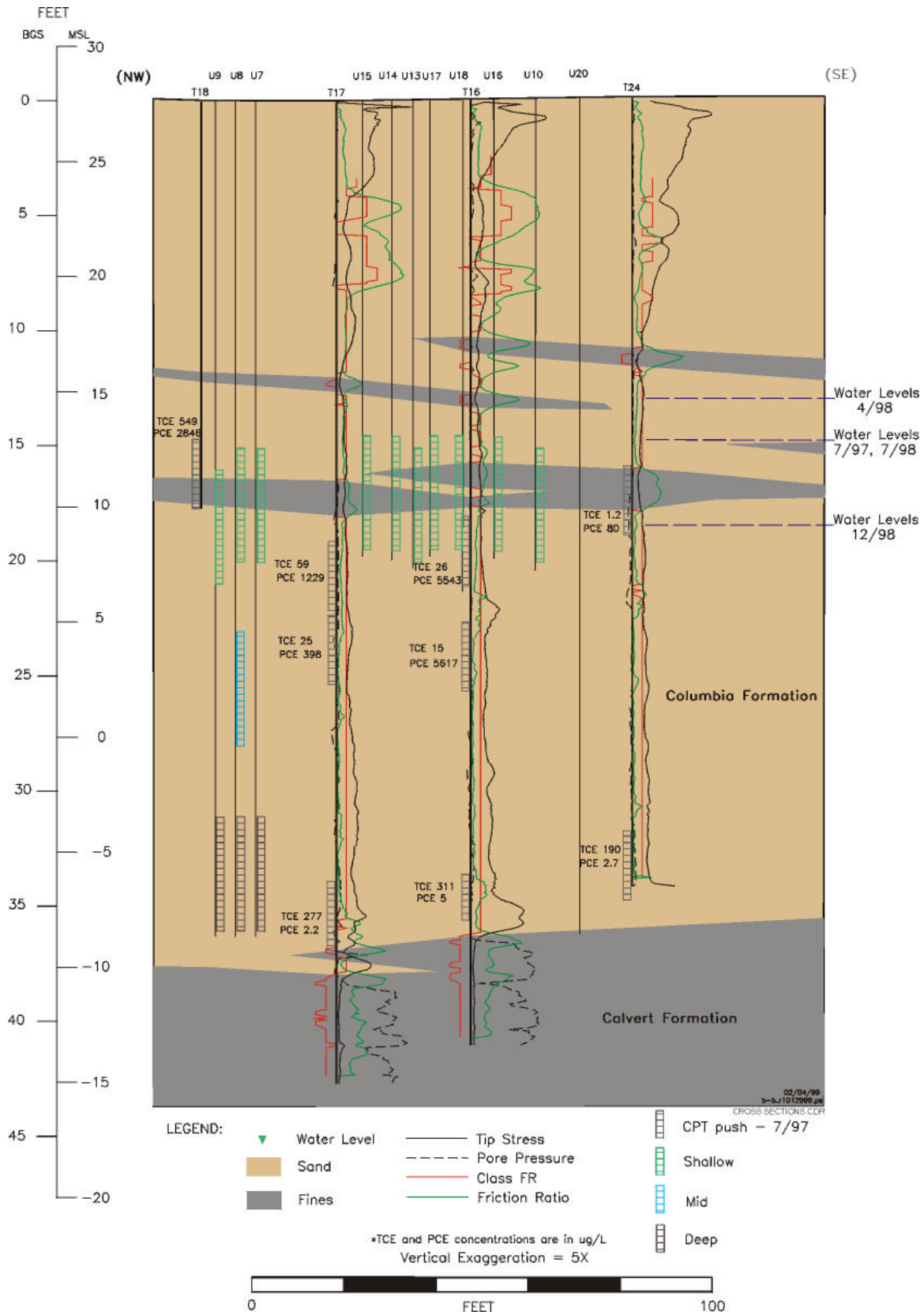

Figure 3-1. Hydrogeologic Cross Section based on CPT Site Characterization

at the site. The final design of the PRB should incorporate the effect of maximum variation in flow directions to avoid future situations where the plume may bypass the barrier.

3.1.2.2 Groundwater Velocity Estimate Using Darcy's Law

The use of the Darcy's Law equation is the most common approach for determining groundwater velocity in the aquifers. This approach requires measurement of hydraulic conductivity (K), effective porosity (n_e), and hydraulic gradient (dh/dl) distribution in the local vicinity of the proposed PRB. The average linear groundwater flow velocity can be calculated by the following equation:

$$V_x = \frac{K(dh/dl)}{n_e} \quad (3-1)$$

where V_x = the average linear groundwater flow velocity
K = the K of the aquifer material (L/t)
dh/dl = the hydraulic gradient
 n_e = the effective porosity.

The parameters needed for hydraulic evaluation are discussed further in the following subsections.

3.1.2.2.1 Hydraulic Conductivity. K is the measure of an aquifer's ability to transmit water and is expressed as the rate at which water can move through a unit thickness permeable medium. K is perhaps the most critical aquifer parameter for the design of PRBs, because K can vary by an order of magnitude or more, even in relatively "homogeneous" sites (e.g., the Dover AFB site). The velocity of groundwater movement and dissolved contaminant migration is directly related to the K of the saturated zone. In addition, subsurface variations in K directly influence contaminant fate and transport by providing preferential pathways for contaminant migration. Estimates of K are used to determine flow velocities and travel times for contaminants and groundwater. At relatively more heterogeneous sites, most of the groundwater flow and contaminant transport in the aquifers may be restricted to high K zones (e.g., the former NAS Moffett Field site). It is important to delineate these preferential pathways by a combination of geologic and hydrologic characterizations so that the permeable barriers can be located across these zones. Ultimately, an accurate estimate of K (or K distribution) at the site will reduce the uncertainties in the velocity estimate and required flowthrough thickness for the PRB. At sites with significant vertical heterogeneities or anisotropy, it would be useful to estimate vertical K. These data can be important in estimating the potential for overflow, underflow, and cross-formational flow.

The most common methods used to quantify K are single- and multiple-well pumping tests and slug tests. Horizontal and vertical K also can be determined from laboratory testing of sediment cores. Pumping tests involve the pumping of a test well and measurement of drawdown in the surrounding wells. Greater details on these tests can be found in Domenico and Schwartz (1990), Fetter (1994), and Kruseman and de Ridder (1991). Pumping tests generally give the most reliable information on K, but they may be difficult to conduct in contaminated areas because the water produced during the test generally must be contained and treated. One of the disadvantages of pumping tests is that they are relatively expensive and time consuming to

conduct, and may cause temporary displacement of the plume if conducted in the contaminated region of interest. Therefore, at highly heterogeneous sites, it generally is impractical to conduct a sufficient number of tests to estimate the K variations in all the hydrostratigraphic units of interest.

Slug withdrawal or injection tests are the most commonly used alternative to pumping tests. A slug test consists of the insertion or removal of a “slug” or known volume of water, or the displacement of water by a solid object. The displaced water causes a stress on the aquifer that is monitored through the change and recovery of hydraulic head or water level. One commonly cited limitation to slug testing is that the method generally gives K information only for the area immediately surrounding the test well. Slug tests do, however, have two distinct advantages over pumping tests: they can be conducted in small-diameter wells, and they do not produce contaminated water that may require treatment and/or disposal. If slug tests are used as part of a site characterization effort to determine the K distribution in an aquifer, it is important that multiple slug tests be performed. The tests should be performed with replicates and in as many wells as feasible. Another big advantage of slug tests over pumping tests is that a large number of tests can be conducted in the amount of time and cost it takes for one pumping test. Therefore, slug tests can be used to estimate the spatial variations in K at heterogeneous sites. A description of the theory and application of slug testing is provided in Fetter (1994), and a complete description of the analysis of slug test data is provided in Kruseman and de Ridder (1991).

K also can be determined from laboratory testing of the soil cores collected in the field. However, this method may not generate representative results because the samples are invariably disturbed during collection, which may impact the accuracy of the tests. CPT pressure dissipation tests also have been used for K determination. For the PRB at Dover AFB, this method resulted in reasonable estimates of K for the lower-K clayey zones. However, for the high-K sandy zones, the pressure dissipation was too fast and the results were not reliable (Battelle, 2000).

3.1.2.2.2 Porosity. The porosity (n) of an aquifer material is the percentage of the rock or soil/sediment that consists of void space. The porosity of a sample of aquifer material is normally determined in the laboratory by submerging a dried sample in a known volume of water until it is saturated. The volume of voids is equal to the original water volume less the volume in the chamber after the saturated sample is removed. This method excludes very small and non-interconnected pores, thus providing the effective porosity of the sample. Table 3-2 lists general ranges of porosity that can be expected for typical sediments. For the purpose of PRB design, the range of porosity for all sediment types at the proposed site should be determined by collecting soil samples from the aquifer and the underlying confining layers.

Table 3-2. Porosity Ranges for Sediments

| Sediment Type | Porosity Range |
|----------------------------|-----------------------|
| Well-sorted sand or gravel | 25-50% |
| Sand and gravel, mixed | 20-35% |
| Glacial till | 10-20% |
| Silt | 35-50% |
| Clay | 33-60% |

Source: Fetter (1994).

3.1.2.2.3 Hydraulic Gradient. The hydraulic gradient is the change in hydraulic head (dh) over a unit distance (dl) along the direction of the steepest head decline. Like groundwater flow direction (see Section 3.1.2.1), the hydraulic gradient is determined using a water-table or potentiometric surface map constructed using water-level measurements taken at the site during a specific time. It is generally important to estimate values of both the lateral and vertical hydraulic gradients at the site. The vertical gradients are useful in evaluating potential for underflow or overflow and flow between adjacent aquifers. The vertical hydraulic gradients may be determined by comparing water levels in multiple well clusters with individual points screened at different vertical depths. It is critical to take water-level measurements at several times during the year and over several years so seasonal and long-term variations in groundwater flow velocity and direction can be evaluated. These variations should be incorporated into the safety factor for PRB design to prevent future bypass of the system by the plume or insufficient residence times.

3.1.2.3 In Situ Groundwater Velocity Sensors

Recently, the in situ groundwater velocity sensors developed at Sandia National Laboratory (Ballard, 1996) have been used at several PRB sites, including former NAS Alameda, Dover AFB, and former Lowry AFB, for evaluation of groundwater velocity and flow direction mainly during the performance assessment phase. The sensors and associated data acquisition system are marketed by HydroTechnics, Inc., of Albuquerque, NM. The sensors have been deployed both in the PRB media and in the surrounding aquifers. So far these sensors have not been used for site characterization during the PRB design phase; however, their use can provide valuable information on the local-scale and seasonal variations in groundwater velocity. If used for site characterization purposes, several sensors should be installed across the investigation area. This may include installation in different lithologic zones, in recharge and discharge zones, or at different depths in the aquifer.

The HydroTechnics sensor uses a thermal perturbation technique to directly measure the three-dimensional (3-D) groundwater flow velocity vector in unconsolidated, saturated, porous media. The technology allows for long-term and continuous monitoring of the groundwater flow regime in the immediate vicinity of the probe. The instrument consists of a cylindrical heater 30 inches long and 2.37 inches in diameter which has an array of 30 calibrated temperature sensors on its surface. The velocity sensor is installed directly in contact with the aquifer media at the depth of interest. Only a data transmission wire connects the sensor to the surface. A heater activated with 70 W of continuous power supply heats the sediments and groundwater surrounding the sensor to about 20 to 30°C above background. The temperature distribution at the surface to the sensor is affected by the groundwater movement resulting from advective flow of heated groundwater. The measured temperature distribution is converted into flow velocity (3-D magnitude and direction) by a computer program.

The manufacturer's specifications indicate that Darcy velocity range of 0.01 to 1.0 ft/d can be measured with the probe with a resolution of 0.001 ft/d and an accuracy of 0.01 ft/d. The life span of the sensor is 1 to 2 years and it can be installed up to a depth of 400 ft. The data can be retrieved remotely with a telephone and modem connection.

3.1.2.4 Downhole Velocity Measurement Probe

A possible alternative to the HydroTechnics velocity sensor is the Geoflo Groundwater Flowmeter System manufactured by KVA Analytical Systems, Inc. This probe can be used in

2-inch-diameter monitoring wells for direct downhole measurement of groundwater velocity and direction. The system is a portable self-contained instrument consisting of a 2-inch-diameter flowmeter probe and associated packer assembly attached to 80 ft of electronic cable, aluminum suspension rods, and a control unit with battery packs. The submersible probe consists of a central heating element surrounded by four pairs of opposed thermistors. The heating element and thermistors are contained within a packer assembly that is filled with 2-mm-diameter glass beads. The measurement of groundwater velocity and direction by the flowmeter is based on initiating a short-term heat pulse at the center of the probe. The distribution of the resulting heat in the glass beads is measured by the thermistors, and the relative difference between opposed thermistors is displayed. The values read from the display are resolved into the rate and direction of flow in the well through (1) a process of vector resolution, and (2) computation with a flow velocity calibration equation. The quality of the tests can be evaluated by use of a cosine test as described in the user's manual.

Proper calibration of the flowmeter instrument is required to ensure accurate results. Factors potentially affecting the instrument response include aquifer matrix type, well screen type and orientation, type and amount of the fill in the annular space of the well, adherence of uniform and horizontal groundwater flow through the well screen, and operator techniques. The calibration is based on measuring the instrument response in a laboratory tank with flow velocity, probe screen, and glass beads similar to that expected at the site. The flow velocity calculated for several flowrates in the tank is plotted against the instrument reading, and the slope of the resulting calibration curve is used to calculate field velocity in the wells. Thus a site-specific calibration equation is obtained for each site. The stated range of velocity for KVA probe use is 0.02 to 100 ft/day. However, at low end of this range, the results may not be very good for the screen types and monitoring well construction at many contaminated sites. An illustration of KVA probe use at the former NAS Moffett Field PRB site is presented in Battelle (1998). The velocity measurements proved to be a mixed success at this site in part because the flow velocities encountered at the site turned out to be lower than the instrument calibration range. However, the results still provide a qualitative indication of groundwater flow directions at the site. At higher flow velocities and in properly screened and completed monitoring wells, the results are expected to be more reliable.

3.1.2.5 Colloidal Borescope

The colloidal borescope is an in situ device that provides direct visual means for observing colloids in monitoring wells. Colloidal size, density, and flow patterns can be assessed, and an evaluation of sampling effects on the natural groundwater flow system can be made. This device has been used previously to evaluate micropurge sampling techniques (Kearl et al., 1994), and currently is being used to determine the flow velocity and directions in monitoring wells by direct observation of colloidal particle movement (Korte, 1999). The colloidal borescope was developed at Oak Ridge National Laboratory (ORNL) as part of the Exploratory Studies Program. The borescope also is marketed by AquaVISION Environmental, LLC.

The instrument consists of a charge coupled device (CCD) camera, optical magnification lens, illumination source, and stainless steel housing. The device is about 60 cm (2 ft) long and has a diameter of less than 5 cm (2 inches), making its use possible for the 2-inch-diameter monitoring wells present at most PRB sites. The electronic image from the well can be seen at the surface

on a monitor and recorded on a VHS tape. The magnified image corresponds to a field of view of approximately 1.0 mm × 1.4 mm × 0.1 mm. The colloidal borescope is inserted into the monitoring well by a set of rigid quick-connect tubes. These tubes maintain the alignment of the borescope in the well so that the flow directions can be determined. The flow velocity and direction can be measured after a waiting period during which the flow changes from turbulent (due to probe insertion) to laminar (due to natural groundwater flow).

A recent study (Kearl, 1997) presents in detail the various aspects of groundwater velocity measurement using the borescope and its comparison with traditional (i.e., Darcy equation-based) approaches to velocity estimation. Kearl evaluates the performance of the borescope in different geologic settings and in laboratory tanks. In most cases flow magnitude and direction appear to be stable within an acceptable standard deviation range. However, large fluctuations and standard deviation due to swirling were observed in a low conductivity setting. It was concluded that the laminar flow establishes more easily in the relatively high-flow zones of the aquifers. In comparison, swirling flow conditions develop as the groundwater enters from the lower-flow zones into the well bore. As a result of this effect, the borescope tends to be more reliable in the higher-flow zones, and the results are biased toward preferential flow zone velocity rather than bulk flow velocity. Essentially, the borescope provides an estimate of maximum velocity rather than the average velocity in the borehole. According to Kearl (1997), field borescope measurements should be reduced by a factor of 1 to 4 for velocity magnitude to account for higher than actual velocities. Within this range, higher multiples are needed for wells with filter pack than those without filter pack, based on laboratory tank studies. A field study of the applicability of the borescope and HydroTechnics sensors at multiple PRB sites is currently being conducted through a joint DoD-DOE effort (Battelle, 1999).

3.1.2.6 Tracer Testing

Tracer testing is a relatively difficult, more expensive way of determining the flow properties of the targeted portion of an aquifer. However, if successfully applied, tracer tests can provide the most direct measurement of flow. Tracer tests can be used to estimate the average groundwater velocity and determine flowpath variations. In general, tracer tests involve injecting a known concentration and volume of a chemical tracer in the upgradient locations and then monitoring for the arrival and concentration distribution in one or more downgradient wells. The plots of concentration versus time are used to calculate travel velocities through the medium. The spread in the concentration distribution is an indicator of the dispersion caused by heterogeneities. The most significant aspects of conducting the tracer tests include the selection of tracers, the location of monitoring points, and the determination of appropriate sampling frequencies.

Conservative tracers usually are used to determine flow velocity in order to prevent the tracer from being retarded significantly by chemical reactions with the aquifer medium. The monitoring point locations must be based on a reasonable understanding of the flow patterns so that the wells are placed directly downgradient of the injection points and so most of the injected tracer can be accounted for during mass-balance calculations. The sampling frequency is based on a pre-estimate of the expected flow velocity and should be sufficient to obtain a relatively large number of samples during the time the tracer passes through the monitoring locations. The mass of tracer should be small enough that the injected volume does not have a large impact on the flow field (i.e., the natural hydraulic gradients should not be disturbed). However, the mass of

tracer should be large enough to obtain detectable concentrations in the monitoring wells. Monitoring for tracer movement may be based on a combination of laboratory analyses of samples and the use of specific ion electrodes. It is better to install specific ion electrodes with data loggers for continuous monitoring of tracer concentrations in several wells. The only disadvantage of using the specific ion electrodes may be the need to calibrate them often. Generally, tracer tests are time-consuming, cumbersome, and expensive. However, when conducted properly, they provide the most direct evidence of the flow patterns in the subsurface.

3.2 Contaminant Distribution in the Groundwater

The distribution of the target contaminants needs to be mapped out so that a suitable location which meets regulatory/administrative objectives can be determined. Many of the design features of the PRB are also dependent on the contaminant distribution, as described in Section 6.0.

3.2.1 Spatial Distribution of Contaminants

In general, the 3-D distribution of each contaminant plume at the site needs to be delineated so that the PRB can be appropriately located and sized to capture it. This delineation includes the identification of the contaminated aquifer(s), the depth and width of the plume(s), the average and maximum concentration, and the rate of plume movement. In addition, it is important to characterize the significant processes that may affect the spread of contamination in the subsurface at the site. These processes may include the effects of adsorption/retardation, chemical reactions, dispersion, and vertical plume movement due to fluid density effects.

In many cases, some of the required data already would be available from the RI/FS, ROD, RFI, or routine monitoring reports from the site. Therefore, no new data may need to be acquired for plume characterization at these sites. Instead, a careful review of existing reports should be conducted and new data should be collected only if significant data gaps are found or if the pre-existing data are out of date or inadequate. If needed, groundwater samples can be collected to fill data gaps or to improve sampling density in areas of particular interest or for specific analytes. Generally, discrete-depth samples of groundwater from several locations are recommended for proper delineation of the plume. Even at sites (e.g., Dover AFB) with relatively homogeneous geology, contaminant concentrations may be heterogeneously distributed both in lateral and vertical planes (Battelle, 2000), either due to preferential flow channels or due to the existence of multiple DNAPL sources. At former NAS Alameda, for example, the plume was found to contain a very thin core of high contamination that was stretching the treatment capacity of the installed PRB (Einarson et al., 2000). Multi-level samples or clusters of short-screen wells should be used to better delineate the plume.

The width of the contaminant plume can be determined from the isopleth maps of concentration. If sufficient data are available, the maps also may reveal the potential source zones for the contaminants and the existence of preferential pathways for contaminant migration along which the contaminants have advanced. The plume maps also can be used to identify a potential location and design for the PRB installation. In most cases, the barrier is installed near the downgradient end of the plume. However, several factors may lead to the installation of barriers within the plumes. For example, site access to the edge of the plume may be difficult, or barriers may have to be installed at the edge of the property boundary even if a portion of the plume already has moved past the property boundary. Sometimes the barrier may be located in the proximity of the

highest concentration parts of the plume to expedite the remediation of the most contaminated areas. Such a location may be required for slow moving plumes. Other measures may be required in such cases to address the remaining portion of the plume.

3.2.2 Temporal Changes in Contaminant Concentration

Although much of the site characterization effort is directed toward mapping the current contaminant distribution, an effort should be made to anticipate the changes in the contaminant distribution over time. The objective is to anticipate the way that the shape of the plume and concentration of the contaminants near the PRB may change with time. If concentrations change significantly over time, the amount of reactive medium installed in the PRB may become insufficient to treat the plume to target cleanup levels. If the shape of the plume changes significantly over time, it may find its way around the PRB. In addition, if the PRB is being designed to replace an existing P&T system, it may be difficult to predict the future shape and movement of the plume once the P&T system is shut down.

Predicting changes in shape and concentration of the plume over time is very difficult. This issue may need to be addressed by evaluating different design scenarios and by incorporating suitable safety factors in the design, rather than through predictions from site characterization. However, characterizing more of the upgradient plume and source area may provide a preliminary indication of how the plume may develop in the future. At the very least, the maximum contaminant concentration upgradient from the prospective PRB location should be determined. Historical plume maps or contaminant data taken at different points in time may be helpful.

3.2.3 Groundwater Sampling for Volatile Organic Compounds

Groundwater sampling for volatile organic compounds (VOCs) provides essential information on water movement, contaminant levels, and inorganic chemistry and geochemistry needed to understand and model the performance of a PRB. Proper quality assurance (QA) procedures, as described in EPA SW-846, should be followed during sampling to ensure that the data are valid. Zero headspace should be ensured prior to sealing the sample containers. Sample containers should be labeled, logged, and stored at approximately 4°C while they are being transferred under chain-of-custody protocol to an analytical laboratory for analysis. Analysis must be completed prior to expiration of recommended holding times. Field duplicates, field blanks, and trip blanks are commonly used quality control (QC) samples that aid data quality evaluation.

At some field sites, monitoring wells already will be installed at a distance from the PRB suitable enough to enable water sample collection that will meet the objectives of the project. The locations of existing groundwater wells may be adequate, particularly if the goal is compliance monitoring. However, questions concerning plume capture or plume migration may arise after the project has begun which could render the number and distribution of existing wells inadequate. To cover a wider sampling area or to enlarge the dataset collected at important points, it is often practical, fast, and economical to install temporary monitoring points, as opposed to installing additional permanent wells. Also, the need for certain types of information may be immediate and there may be no need for follow-up sampling. All of these goals can be met by installing temporary monitoring points.

Temporary points can be installed using several types of available direct push equipment, such as a CPT rig and Geoprobe[®]. Usually, a narrow diameter (typically 3/4-inch) polyvinyl chloride (PVC) tube with slotted well screen is installed through the bore of the drive casing. After the casing is removed, native soil begins to collapse around the PVC tube while adjacent groundwater flows inside. Screen sections can be obtained in various lengths to accommodate discrete level (typically 6-inch to 3-ft) or continuous (long-screen) sampling. Also, narrow slot sizes should be used if the soil texture is fine. The aboveground length can be shortened to a convenient height if desired to accommodate the sampling method.

Sampling can begin immediately after temporary well installation. If water levels are relatively shallow (generally no deeper than 25 ft), samples can be collected by pumping with a peristaltic pump. This is done by first inserting a thin (e.g. 1/4-inch outside diameter) flexible or semi-rigid tube (a grade of Teflon[™] is recommended) into the middle of the screened section of the PVC tube. The sample tubing then should be connected to a section of flexible Viton[®] tubing which is inserted into the pump mechanism. If water levels are too deep for sampling using a peristaltic pump, water samples can be recovered by using a narrow-diameter bailer. An alternative method for collecting moderately deep groundwater is to use a collection device built into the drive tip of a direct-push sampler. One drawback to this kind of device is that only a small volume (up to 100 mL) of sample can be collected. Additionally, a narrow-diameter bailer can recover only a small sample volume and the water will likely remain turbid due to disturbances in the aquifer caused by its use. The peristaltic pump method allows continuous collection of water, as long as the pumping rate is lower than the recharge rate. Slow recharge can be a limitation of temporary wells, because of the small diameter of the hole and absence of an annular sand pack.

When groundwater sampling is done within or nearby the PRB, it should be done in a manner that causes the least disturbance to the inside of the PRB. This is true no matter whether temporary or permanent wells are used. Even relatively low rates of water removal can lead to increased flow and reduced residence time of groundwater in contact with the reactive medium. If a peristaltic pump is used, water samples should be extracted at low flowrates to prevent artificial gradients. In addition, to minimize disruption of normal flow through the barrier, successive samples should be collected in different parts of the barrier, rather than being sampled progressively in nearby wells.

If pumping is used, the flowrate should be set to minimize water-level drawdown. As a rule of thumb, drawdown in the sampling well should be no greater than 0.05 ft. Water levels in nearby wells also may be monitored to check for drawdown until a suitable withdrawal rate is determined for the site. At PRB sites, a typical range of sampling rates is 50 to 500 mL/min. Purging of the wells before sample collection should be kept to a minimum to restrict the sample to the water immediately surrounding the well. One method to assure that water samples are representative is to purge at least three volumes of the sample collection tubing. For a typical 3/16-inch-inside diameter, 25-ft-long tubing segment, three tubing volumes are equivalent to about 400 mL. After sample collection, all tubing should be decontaminated as described below. In addition, all downhole sampling equipment (e.g., water-level tape and water quality sensors) should be similarly decontaminated prior to reuse.

The possibility for cross-contamination during sampling should be minimized by taking certain precautions. The favored approach is to use dedicated sample tubing for specific rows of wells (i.e., rows cross-gradient to the flow direction). For example, different sets of tubing could be used to sample the upgradient aquifer, downgradient aquifer, pretreatment zone, exit zone, and different portions of the reactive cell. Also, if more than one plume will be encountered within the aquifer, different sets of tubing can be used for each plume type. All of the tubing should be thoroughly decontaminated by sequentially flushing with detergent, tap water, and deionized (DI) water, prior to collecting the next investigative sample. Rinsate blanks should be collected after the DI water rinse. If free-phase petroleum hydrocarbons will be encountered, it may be desirable to include a methanol rinse prior to the detergent washing step.

3.2.4 Analytical Methods for Volatile Organic Compounds

This section briefly describes the methods used for analysis of groundwater to meet the essential requirements of a site characterization study. VOCs in groundwater samples can be analyzed using EPA Method 8240 (*Volatile Organic Compounds by Gas Chromatography/Mass Spectrometry [GC/MS]*, EPA SW-846, Update II, September 1994) or EPA Method 8260 (similar to Method 8240, but uses capillary column) in conjunction with EPA Method 624 (*Purgeables*, EPA SW-846, July 1991). Method 624 is a sample preparation and extraction procedure for analysis of VOCs using a purge-and-trap apparatus. This technique can be used for most VOCs that have boiling points below 200°C and are insoluble or slightly soluble in water. Volatile, water-soluble compounds can be included in this analytical technique; however, quantitation limits by gas chromatography (GC) are generally higher because of poor purging efficiency.

QA involves the use of blanks, duplicates, and matrix spikes (MSs) to ensure laboratory data quality. The accuracy and precision of either EPA Method 8240 or EPA Method 8260 are related to the concentration of the analyte in the investigative sample and are essentially independent of the sample matrix. Linear equations pertaining to accuracy and precision for a few compounds are discussed in the method descriptions. The estimated quantitation limit (EQL) for individual compounds is approximately 5 µg/L in groundwater samples. EQLs are proportionally higher for sample extracts and samples that require dilution or reduced sample size to avoid saturation of the detector.

3.3 Geochemical Composition of the Groundwater

Monitoring of field parameters such as pH, DO, or ORP (i.e., redox-potential [Eh]) in the groundwater during site characterization is very important because they can be used to determine whether conditions at the site are conducive to formation of inorganic precipitates in the presence of a reactive medium (see Section 1.4 for a discussion of inorganic reactions that occur in reactive cells containing iron). These three groundwater field parameters should be monitored on a quarterly basis, if possible, to evaluate seasonal fluctuations. Unless the aquifer is relatively thin, these parameters may vary by depth. Although mapping local geochemical heterogeneities is not as important as mapping the local contaminant distribution, depth profiles of these parameters in the aquifer may provide important information that might limit the longevity of the reactive medium over several years. Some geochemical parameters, such as DO, may vary by depth in the aquifer, leading to different degrees of iron corrosion in the reactive cell. Section 8.3 contains additional discussion on the use of inorganic geochemical parameters for evaluating the longevity of PRBs.

Geochemical species that may potentially react with the reductive media considered for PRBs include Ca, Fe, Mg, Mn, Ba, Cl, F, SO_4^{2-} , NO_3^- , silica, and carbonate species (alkalinity); significant redox-sensitive elements include Fe, C, S, and N. For example, iron in solution may be in the ferrous (Fe^{2+}) state or ferric (Fe^{3+}) state, and organic carbon as humic or fulvic substances may be reduced to methane in the reactive cell. Sulfate (S^{6+}) may be reduced to bisulfide (HS^-) and nitrate may be reduced to nitrogen gas or ammonia if conditions are sufficiently reducing. Geochemical modeling codes can be used to determine the types of reactions and products that may be expected when groundwater contacts the reactive medium. Geochemical modeling is discussed in Sections 6.4.3 and 8.3.2.

3.3.1 Sampling and Analysis of Field Parameters

The primary purpose of taking field parameter measurements is to monitor aquifer conditions that can affect the performance of the reactive wall. Therefore, the water level, temperature (T), pH, Eh, and DO should be measured at designated monitoring wells. To obtain accurate readings, T, pH, Eh, and DO should be measured using the most appropriate method available to provide representative values. Typical devices include downhole sensors or flowthrough cells with multiple sensors. Other parameters, such as specific conductivity, turbidity, and salinity of a groundwater sample, can be measured *ex situ*, if required, using appropriate field instruments. Table 3-3 lists the field parameters and corresponding analysis methods.

3.3.2 Sampling and Analysis of Inorganic Chemical Parameters

Inorganic analytes should be measured because they provide useful information about the corrosion byproducts that may be produced during operation of the PRB. Samples should be collected from selected monitoring points for laboratory analysis as indicated in Table 3-1.

Samples for cations should be filtered and preserved immediately after collection. Filtering is especially critical for transition metal cations such as iron and manganese. Without filtering, adsorbed metals on colloidal particles would bias the solution analysis toward higher concentrations. The typical filter pore size for cation analysis is 0.45 μm ; however, filters of smaller pore size may be used from time to time for comparison. Samples for anion analysis usually do not require filtering.

In addition, several samples should be collected and preserved without filtering to determine the content in the suspended matter. TDS and TSS should be determined from filtered and unfiltered samples, respectively. QA procedures include the use of blanks, duplicates, and MSs to ensure data quality.

3.4 Geotechnical and Topographic Considerations

Aboveground factors that could impede the access of construction equipment to the site, such as the presence of buildings or overhead utility lines, should be identified while choosing prospective locations for the PRB. Underground factors that could impede the construction of the PRB, such as the presence of consolidated sediments or rocks, need to be identified. This process could start during the preliminary assessment to evaluate whether the site lends itself to PRB application. These issues may have to be revisited when selecting construction methods for the PRB.

**Table 3-3. Requirements for Field Parameters and Inorganic Analytes
(based on EPA SW-846)**

| Analytes/Parameters | Analysis Method | Sample Volume | Storage Container | Preservation | Sample Holding Time |
|--|------------------------|----------------------|--------------------------|---|---|
| <i>Field Parameters</i> | | | | | |
| Water level | Probe | None | None | None | None |
| pH | Probe | None | None | None | None |
| Groundwater temperature | Probe | None | None | None | None |
| Redox potential | Probe | None | None | None | None |
| Dissolved oxygen | Probe | None | None | None | None |
| Specific conductivity | Field instrument | None | None | None | None |
| Turbidity | Field instrument | None | None | None | None |
| Salinity | Field instrument | None | None | None | None |
| <i>Inorganic Analytes</i> | | | | | |
| Metals (K, Na, Ca, Mg, Fe, Mn, and Ba) | EPA 200.7 | 100 mL (all) | Polyethylene | Filter ^(a) , 4°C, pH<2 (HNO ₃) | 180 days |
| Anions (NO ₃ , SO ₄ , Cl, Br, and F) | EPA 300.0 | 100 mL (all) | Polyethylene (all) | 4°C (all) | 28 days (48 hours for NO ₃) |
| Alkalinity | EPA 310.1 | 100 mL | Polyethylene | None | 14 days |
| <i>Other</i> | | | | | |
| TDS, TSS | EPA 160.2, 160.1 | 100 mL | Polyethylene | 4°C | 7 days |
| TOC, DOC | EPA 415.1 | 40 mL | Glass | 4°C, pH <2 (H ₂ SO ₄) | 7 days |
| Dissolved silica | EPA 6010 | 250 mL | Polyethylene | None | 28 days |

(a) 0.45-µm pore size.

DOC = Dissolved organic carbon.

TDS = Total dissolved solids.

TOC = Total organic carbon.

TSS = Total suspended solids.

4.0 Reactive Media Selection

Once site characterization information has been obtained, a suitable reactive medium must be selected for use in the reactive cell. The choice among reactive metal media for the reactive cell is governed by the following considerations:

- ❑ **Reactivity.** A medium that affords lower half-lives (faster degradation rates) is preferred.
- ❑ **Stability.** Length of time that a reactive medium or that mixed media will maintain reactivity is an important concern. No full- or pilot-scale barrier has been operating for a sufficient length of time to make a direct determination of stability. However, an understanding of the reaction mechanism can provide some indication of the future behavior of the medium.
- ❑ **Availability and Cost.** A cheaper medium is preferred over a more expensive medium, especially if any differences in performance are reported to be slight.
- ❑ **Hydraulic Performance.** The particle size of the reactive medium should be sufficient to ensure required hydraulic capture by the barrier.
- ❑ **Environmental Compatibility.** The reactive medium should not introduce harmful byproducts into the downgradient environment.
- ❑ **Construction Method.** Some innovative construction methods, such as jetting, may require a finer particle size of the reactive medium.

There may be a trade-off between these factors, and final selection may have to be based on the importance of each factor for a given site.

4.1 Types Of Reactive Media Available

Several different types of reactive metal media are available for use in PRBs and are discussed below.

4.1.1 Granular Zero-Valent Metal

Granular zero-valent metal, particularly iron, is the most common medium used so far in bench-, pilot-, and full-scale installations.

4.1.1.1 Granular Iron

The use of zero-valent iron medium for in situ groundwater treatment was investigated and patented by the University of Waterloo (Gillham, 1993). The technology is marketed under an exclusive license by ETI, of Waterloo, Ontario. Both reagent- and commercial-grade iron have proved effective for dissolved chlorinated solvent treatment. Sivavec and Horney (1995) studied

the degradation rates for chlorinated compounds with commercial iron from 25 different sources. They and other researchers (Agrawal and Tratnyek, 1996; Matheson and Tratnyek, 1994) have found that the primary determinant of degradation rate in different irons is the available reactive surface area. The parameter generally used to discriminate between different irons is the specific surface area, or the surface area per unit mass (m^2/g) of iron.

Sivavec and Horney (1995) found that pseudo first-order degradation kinetics (with respect to chlorinated ethene concentrations) were applicable when the ratio of iron surface area to volume of aqueous phase ranged from 0.1 to $1,325 \text{ m}^2/\text{L}$. The surface area of the metal was measured by Brunauer-Emmett-Teller Adsorption Isotherm Equation (BET) Kr or N_2 adsorption. Specific surface areas of untreated iron from the 25 different sources varied by more than four orders of magnitude. Acid pretreatment was found to increase the degradation rate of iron (Agrawal and Tratnyek, 1996; Sivavec and Horney, 1995), probably due to removal of any passivating oxide layer on the iron or due to an increase in the surface area by etching or pitting corrosion. Therefore, commercial irons with higher surface area are preferred. However, the higher surface area requirement for reactivity should be balanced with the hydrogeologic necessity to select a particle size that affords a reactive cell K that is at least five times (or more) higher than that of the surrounding aquifer (see Section 6.1). Generally, sand-sized particles of iron are selected for use in reactive cells. The hydraulic conductivity of the reactive cell also can be improved by mixing sand (or coarser concrete sand) with finer iron particles. Adding sections of pea gravel along the upgradient and downgradient edges of the reactive cell also improves the distribution of flow through the reactive cell, and this feature has been used in several field installations to date.

One variation of granular iron medium that was applied at Dover AFB is the use of a pretreatment zone containing a coarse medium (sand or pea gravel) mixed with a small percentage (10%) of iron (Battelle, 2000). This pretreatment zone removed DO from aerobic groundwater before it entered the 100% iron reactive cell. The advantage of using this pretreatment zone was that the front-end precipitate formation (by the reaction between iron and DO) was spread over a greater flowthrough thickness of the reactive cell, which reduced the potential for clogging of the influent end of the reactive cell.

The general requirements for the iron media that have been used at existing PRB sites are:

- ❑ Iron ideally should be more than 90% Fe^0 by weight, with minor amounts of carbon, a minimal oxide coating, and no hazardous levels of trace metal impurities. Many suppliers perform environmental quality testing on their materials to determine the concentration of impurities.
- ❑ The desired grain-size range is between -8 to 50 mesh. Presence of fines (-50 mesh) should be minimized as much as possible by sieving.
- ❑ Because the iron may be generated from cutting or grinding operations, it should be ensured that there are no residual cutting oils or grease on the iron.
- ❑ A material safety data sheet (MSDS) that identifies health and safety hazards of the material should be provided by the supplier.

4.1.1.2 Other Zero-Valent Metals

A number of other zero-valent metals have been investigated for their potential to reduce chlorinated hydrocarbons. Experiments were conducted to determine the relative rates of reduction of various hydrocarbons by stainless steel, Cu^0 , brass, Al^0 , mild steel, and galvanized metal (Zn^0) (Reynolds et al., 1990; Gillham and O'Hannesin, 1992). Mild steel and galvanized metal had the fastest reduction rates, followed by Al^0 . Little reduction occurred with stainless steel, Cu^0 , and brass. These results indicate that there is no significant advantage to using any of these metals over Fe^0 . Boronina et al. (1995) investigated the reactivity of Mg^0 , Sn^0 , and Zn^0 with CCl_4 . Rapid oxidation of Mg^0 by water effectively prevented it from reducing CCl_4 . Sn^0 and Zn^0 were capable of degrading CCl_4 ; however, the cost, the incomplete degradation of chlorinated reaction products, and the dissolution of these toxic metals must be considered before the use of these metals can be considered as a viable alternative to Fe^0 . Schreier and Reinhard (1994) have investigated the ability of Fe^0 and Mn^0 powders to reduce several chlorinated hydrocarbons. Experiments conducted with manganese followed zero-order kinetics. The rates determined appeared to be fairly slow; the zero-order rate constants were determined to range from 0.07 to 0.13 molar units/day, depending on the aqueous-phase solution composition.

4.1.2 Granular Iron with an Amendment

Oxidation of Fe^0 to Fe^{2+} results in an increase in pH. Depending on a variety of physical and chemical factors (e.g., flowrate through the barrier and groundwater geochemistry), this increase in pH can result in the precipitation of a number of minerals, including $\text{Fe}(\text{OH})_2$, FeCO_3 , and CaCO_3 . Various amendments can be added to the granular iron in order to moderate the pH. Pyrite has been used successfully in laboratory experiments for moderating the pH (Burriss et al., 1995; Holser et al., 1995). The oxidation of the pyrite produces acid, which offsets the acid consumed during the oxidation of Fe^0 :

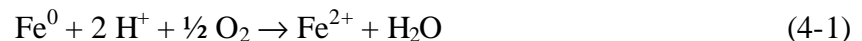

The net reaction for pyrite oxidation is as follows:

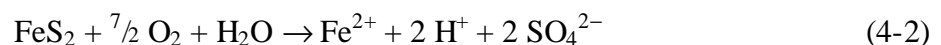

In addition to lowering the pH, the addition of pyrite and iron sulfide to Fe^0 has been shown in the laboratory to reduce the half-life of carbon tetrachloride (Lipczynska-Kochany et al., 1994). At a FeS_2/Fe^0 ratio of 0.03, the half-life of carbon tetrachloride was reduced by 6% over that of iron alone. At a FeS_2/Fe^0 ratio of 0.11, the half-life was reduced by 45%. Ferrous sulfide also reduced the half-life of carbon tetrachloride degradation by Fe^0 . When added at a FeS/Fe^0 ratio of 0.04, the half-life of carbon tetrachloride was reduced by 18%. In addition to the materials discussed above, other materials have been proposed for moderating the pH, including troilite, chalcopyrite, and sulfur. One potential side effect of adding pH-controlling amendments could be the presence of higher levels of dissolved iron in the downgradient water from the reactive cell.

In the PRB at Dover AFB, a mixture of 10% pyrite and sand was used as a pretreatment zone before the 100% iron reactive cell (Battelle, 2000; U.S. EPA, 1997). Just as with 10% iron and sand (see Section 4.1.1.1), front-end precipitation caused by DO was reduced with the use of this

pretreatment zone. The pH reduction achieved in the pretreatment zone, however, did not persist in the 100% iron reactive medium, and pH rose to 11 in the reactive cell.

4.1.3 Bimetallic Media

A number of bimetallic systems in which various metals are plated onto zero-valent iron have been shown to be capable of reducing chlorinated organic compounds at rates that are significantly more rapid than zero-valent iron itself (Sweeny and Fisher, 1972; Sweeny, 1983; Muftikian et al., 1995; Korte et al., 1995; Orth and McKenzie, 1995). Some bimetallics, such as iron-copper (Fe-Cu), act as galvanic couples. Other bimetallics, such as iron-palladium (Fe-Pd), enhance the degradation rate because the metals (in this example, Pd) acts as a catalyst. Some publications (Appleton, 1996) have mentioned that the Fe-Ni bimetallic system has the potential to considerably enhance reaction rates. There may be a cost trade-off between the construction of a smaller reactive cell (because of the faster reaction rate) and the higher cost (relative to granular iron) of the new highly reactive medium.

Of the bimetallic systems studied so far, the Fe-Pd bimetallic appears to have the fastest reaction kinetics. Laboratory studies with palladized iron have demonstrated that the reduction of TCE can be increased by up to two orders of magnitude over that of iron alone (Hayes and Marcus, 1997; Muftikian et al., 1995; Korte et al., 1995; Orth and McKenzie, 1995). In addition, palladized iron allows for the reduction of some of the more recalcitrant compounds, such as dichloromethane. However, due to the high cost of palladium, the economic viability of this medium is unclear.

One caution that should be exercised while examining bimetallic media in particular, and all media in general, is to ensure that the enhanced reactivity can be maintained over long periods of time. There is some preliminary indication from long-term column tests that the reactivity of bimetallic systems initially may be high, but may decline gradually after several pore volumes of groundwater have flowed through (Sivavec, 1997). Also, the metals used in bimetallic systems (e.g., Fe-Ni) should not introduce environmentally undesirable levels of dissolved metals into the downgradient aquifer.

4.1.4 Other Innovative Reactive Media

4.1.4.1 Cercona™ Iron Foam

One group of materials that has been proposed for use in PRBs is ceramic foam and aggregate products made by Cercona, Inc., Dayton, OH (Bostick et al., 1996). As opposed to conventional granular forms of iron that exhibit a trade-off between surface area and porosity, the iron foam material is claimed to be able to provide both properties, a high surface area (high reactivity) and a high porosity, in the same material. This iron foam material is based on gelation of soluble silicates with soluble aluminates. These two solutions are combined with an aggregate or powdered material in a controlled and reproducible manner under specific conditions including the solution concentration, the temperature, and the ratio of materials to make the final product. The addition of the custom aggregate or powdered material to the silicate/aluminate slurry results in a final product with a composition that typically is 5-15% silicate and aluminate with the balance being the additive of choice. The additives are based on the desired properties of the

product. For PRB applications, typical additives would include metallic iron, iron oxides, zeolites, clays, or specialty ceramic materials.

4.1.4.2 Colloidal Iron

Granular iron materials of sand size and larger have been the most common reactive media used in laboratory and field studies of PRBs so far. One alternative form of iron that has been suggested is colloidal-size iron material (1 to 3 μm in diameter). This material is considerably more expensive than granular iron materials; however, it may have some advantages over granular materials. Colloidal-size iron allows the formulation of slurries that can be injected into the aquifer, making it possible to install a PRB anywhere a well can be installed, including in deep sites and fractured media. Some studies have explored the viability of this innovative approach for construction of an in situ PRB composed of iron (Kaplan et al., 1996; Cantrell and Kaplan, 1996; Cantrell et al., 1997). In the proposed approach, colloidal-size iron particles would be injected as a suspension into the subsurface. As the suspension of particles moves through the aquifer material, the particles would be filtered out on the surfaces of the aquifer matrix. As a result of the high density of the iron particles (7.6 g/cm^3), it appears that the primary removal mechanism of iron colloids in aqueous solution passing through sand columns is gravitational settling. Because colloidal-size iron particles have higher surface areas, a lower total iron mass may be required in the treatment zone. Cantrell and Kaplan (1996) estimate that a chemically reactive barrier which is 1.0 m thick with a iron concentration of 0.4% by volume would last for approximately 30 years under typical groundwater conditions. Although laboratory column experiments have been promising, this technology has not been field-tested. The cost of manufacturing iron in a colloidal form has a significant bearing on the economics of this medium and needs to be assessed.

4.1.4.3 Ferrous Iron-Containing Compounds

In addition to zero-valent iron, several ferrous iron-containing compounds have been investigated for their potential as suitable reducing agents for chlorinated hydrocarbons. Lipczynska-Kochany et al. (1994) found that Na_2S , FeS , and FeS_2 all were capable of reducing carbon tetrachloride with half-lives that were nearly the same as Fe^0 (approximately 24 minutes). Kriegman-King and Reinhard (1991 and 1994) also investigated the reduction of carbon tetrachloride by pyrite. The reaction rates that they observed appear to be similar; however, it is difficult to make an objective comparison between their two studies because different experimental conditions were used in each study.

4.1.4.4 Reduction of Aquifer Materials by Dithionite

Another treatment technology that involves lowering aquifer redox conditions has become known as in situ redox manipulation, or ISRM. In ISRM, a reducing agent, usually sodium dithionite ($\text{Na}_2\text{S}_2\text{O}_4$), is injected into the subsurface to create a permeable treatment zone for remediation of redox-sensitive contaminants. Although only certain CVOCs can be treated by ISRM (e.g., carbon tetrachloride), the technology appears promising for immobilizing a number of redox-sensitive metals, such as chromium, uranium, and technetium (Fruchter et al., 1997). The treatment zone is created by reducing ferric iron to ferrous iron in aquifer materials, such as clay minerals.

Work to date on ISRM has taken place in Hanford, WA, where it was developed to treat hexavalent chromium in an unconfined aquifer at the 100-H area. The site had relatively low concentrations of hexavalent chromium, which ranged from 46 to 71 $\mu\text{g/L}$. Initial bench-scale testing determined that the half-life of dithionite is roughly 18 hours when in contact with Hanford area sediments (Fruchter et al., 1997). An intermediate-scale test was conducted at Oregon State University using a wedge-shape flow cell. Specifications for field experiments were determined by modeling and site characterization information. A field-scale experiment was conducted at a site near the Columbia River, WA in September 1997. Approximately 77,000 L of buffered sodium dithionite solution were injected into the aquifer through a well in the expectation of impacting a zone 15 meters in diameter. After 18.5 hours, the spent reagent was withdrawn from the aquifer and monitored for unreacted reagent, buffer, reaction products (sulfate and sulfite), mobilized metals, and tracer. Subsequent monitoring showed that hexavalent chromium decreased to less than 2 $\mu\text{g/L}$ (as total Cr) and DO was below detection levels.

One key advantage of ISRM over other PRB technologies is that it can be implemented at much greater depths than can usually be attained by excavation methods. Another advantage is that injection can be done easily and economically in remote areas, whereas installation costs tend to increase significantly for traditional placement methods when a site is difficult to access by heavy equipment. One disadvantage of ISRM may be that it does not treat a wide a range of contaminants.

4.1.4.5 Media that Impart Adsorptive and Biological Capability

Werner (1998) has proposed the development of granular activated carbon (GAC) as an adsorbent surface for bacterial growth. In an enhanced GAC system, chlorinated aliphatic hydrocarbons, such as PCE, would be sequestered from the contaminant plume and treated by stimulated anaerobic biodegradation simultaneously. Other materials that have been tested for their ability to adsorb dissolved organic contaminants include polymer beads (polyalkastystyrene) (Venhuis et al., 1999) and ground rubber (Kershaw and Pamukcu, 1997).

Another application of biologically mediated reactions has been demonstrated by a barrier at the Nickel Rim Mine near Sudbury, Ontario, Canada. This barrier is being used to treat acidic leachate plumes produced by oxidized mine drainage (Herbert et al., 1998; Benner et al., 1997). The Nickel Rim barrier consists primarily of organic compost and wood, with a small amount of limestone, and has been shown to promote bacterially-mediated reduction of sulfate, leading to precipitation of iron sulfide (Herbert et al., 1998). Also, geochemical modeling calculations have suggested that other soluble metals in addition to iron may become precipitated in the form of sulfides (zinc) and carbonates (manganese) (Waybrant et al., 1998). Other elements that form sulfides in reducing environments include arsenic, cadmium, copper, nickel, and lead. Precipitation of these elements in organic barriers has been explored in laboratory and pilot-scale field studies (Blowes et al., 1998). Immobilization of uranium was studied in laboratory experiments by Thombre et al. (1997). In these experiments, bacteria were shown to use cellulose-based substrates to achieve reduction of nitrate and sulfate and to promote reduction of soluble U^{6+} to insoluble U^{4+} .

Air sparging remains a proven method for stimulating aerobic biodegradation, and numerous studies have been performed on this rather mature technology. In a novel design that incorporates reductive and oxidative processes in sequence, researchers at Waterloo University designed a PRB at Alameda Point, CA, with zero-valent iron in an upgradient gate segment and an air sparge system in a downgradient segment (Morkin et al., 1998). The purpose of this design was to treat a mixture of dissolved contaminants (CVOCs and petroleum hydrocarbons) using a single integrated technology. A recent development in passive biological treatment systems is oxygen release compounds (ORC[®]). These compounds typically are prepared from peroxides of magnesium, calcium, and urea. Biowalls composed of ORC[®] have been used to remediate benzene, toluene, ethylbenzene, and xylenes (BTEX); polycyclic aromatic hydrocarbons (PAHs); and other hydrocarbon contaminants in groundwater plumes (Borden et al., 1997; Clark et al., 1997).

4.2 Screening and Selection of Reactive Media

In general, suitable reactive media should exhibit the following properties:

- ❑ Sufficient reactivity to degrade the contaminants with an economically viable flowthrough thickness (residence time) in the reactive cell.
- ❑ Ability to retain this reactivity under site-specific geochemical conditions for an economically viable period of time (several years or decades).
- ❑ Appropriate particle size to create a porosity and hydraulic conductivity that allows the creation of a reactive cell which captures the targeted plume width.
- ❑ Ability to retain the porosity and hydraulic conductivity at or above minimum specified levels over long periods of time, through the inhibition of precipitate formation under site geochemical conditions.
- ❑ Environmentally compatible reaction products (e.g., Fe²⁺, Fe³⁺, oxides, oxyhydroxides, and carbonates).
- ❑ Easy availability at a reasonable price.

Batch tests can be conducted to initially screen prospective media, but column tests should be performed as described in Section 5.0 to determine half-lives and select the final medium.

Geochemical models (see Section 6.0) also can help identify candidate media by examining potential reaction products in the reactive cell, especially if media other than common granular iron are being considered. This kind of geochemical modeling is referred to as *forward* or *predictive modeling*, in which a set of reactions and their stoichiometries are assumed and the final outcome of water composition and mineral assemblage is calculated using a computer program (see Appendix D.2). The initial state of the groundwater usually is taken as its composition prior to encountering the reactive medium. The final (equilibrium) composition of the water and the mass of mineral matter that is precipitated or dissolved depends somewhat on its initial chemical makeup. For example, groundwaters that are high in inorganic carbon as a result of contact with carbonate minerals or of plant respiration along a root zone may become

oversaturated with minerals in the reactive cell due to an increase in dissolved iron and elevated pH. Such conditions can lead to precipitation of minerals and other solids within the reactive cell. Predictions based on this kind of modeling should be tested using batch or column experiments in a few cases, to verify that relevant system parameters are well understood and can be applied to a laboratory-scale design. If, based on predictive simulations or treatability testing, precipitation is likely to occur, a different medium or mixture of media may be tested experimentally or modeled using a forward geochemical code, and the results may be used to attempt to minimize the potential for precipitation.

Another application of geochemical modeling to media selection is *inverse modeling* (see Appendix D.3), which calculates the outcome of probable reactions based on chemical data at initial and final points along a flowpath. One key difference between inverse and forward modeling is that the former does not necessarily represent equilibrium. Rather, changes in groundwater composition are attributed to changes in solid precipitation or dissolution. Another important difference is that inverse modeling has the capability to predict the amount of mass change that must occur to satisfy the observed conditions, whereas in forward modeling only the tendency for such changes is determined. Inverse modeling as a tool for media selection is best used to predict mass changes in a column experiment based on analyses at different locations within the column. Rates of reactions and subsequent mass changes then may be calculated in conjunction with flow velocity, residence time, and other parameters that are specific to the column setup. This information permits the user to determine whether mineral precipitation is significant in terms of the long-term performance of the PRB.

5.0 Treatability Testing

Following site characterization and identification of prospective reactive media candidates, treatability testing is conducted to evaluate the performance of the reactive medium with groundwater from a specific site. Treatability testing serves the following purposes:

- ❑ Screening and selecting a suitable medium for the reactive cell
- ❑ Estimating the half-life of the degradation reaction
- ❑ Determining the hydraulic properties of the reactive medium
- ❑ Evaluating the longevity of the reactive medium.

As treatability testing and field data from several sites with common contaminants (e.g., TCE) and common reactive media (e.g., granular iron) become available, it may be possible, if regulators agree, to forgo treatability testing at some sites.

5.1 Batch Testing for Media Screening

Batch experiments generally are conducted by placing the media and contaminant-spiked water in septum-capped vials with no headspace. When samples are drawn from the vial for analysis, either the vial is sacrificed or nitrogen is added to fill up the headspace created (Sivavec, 1996). Nitrogen can be introduced into the vial by sampling with the dual-syringe technique. As the sample is drawn into one syringe, the other syringe (filled with nitrogen) slowly releases nitrogen into the headspace. Alternately, deionized water may be used to replace the liquid withdrawn for analysis. In this way, organics concentrations can be measured as a function of time over multiple sampling events.

Batch tests are useful screening tools because they can be run quickly and inexpensively. However, care should be taken in extrapolating the results to dynamic flow conditions. For example, O'Hannesin (1993) found that the column half-lives for TCE and PCE exceeded batch values by factors of 3 and 2, respectively, even though a higher iron-to-solution ratio was used in the columns than in the batch tests.

5.2 Column Testing for Media Selection and Contaminant Half-Life Estimation

Batch tests are useful mainly as an initial screening tool for evaluating different media or for assessing the degradability of contaminants already known to be recalcitrant. For most other purposes, column tests are the favored method of treatability testing for the following reasons:

- ❑ Design parameters are determined under dynamic flow conditions. As concentrations of contaminants and inorganics change with the distance traveled through the reactive cell, they can be measured by installing a number of intermediate sampling ports along the length of the column.

- ❑ Half-lives measured through column tests generally are more reliable than half-lives measured through batch tests.
- ❑ Nonlinear sorption to non-reactive sorption sites (Burris et al., 1995) is better simulated in columns.
- ❑ Any reaction products formed tend to accumulate in a batch system. Continuous flow through the columns may cause some reaction products to be transported out of the reactive medium, a condition more representative of field operation.

Various types of water may be used to run treatability tests:

- ❑ Deionized water spiked with the targeted contaminant(s)
- ❑ Uncontaminated groundwater from the site spiked with the desired concentration of target contaminant compounds
- ❑ Contaminated groundwater from the site.

Screening of new reactive media may be conducted with clean deionized water, whereas other treatability tests may be conducted with uncontaminated or contaminated groundwater from the site. When clean deionized water or uncontaminated groundwater from the site is used, known concentrations of the target contaminants need to be spiked into the groundwater. In this way, better control over feed concentrations is obtained. When target contaminants are spiked into the groundwater using laboratory grade compounds, it may be noted that the minor components (e.g., stabilizers) that may be present in industrial grade chemicals (in site groundwater) may be hard to replicate. However, there is no indication that these minor constituents affect half-lives of the target contaminants to any significant extent. It is important to run at least some tests with groundwater from the site (uncontaminated or contaminated) because of the important role played by native inorganic parameters in the site groundwater.

The main objective of column tests is to estimate the half-life of the degradation reaction. The half-lives of the organic contaminants and their byproducts then are used to either select the reactive medium or to design an appropriate flowthrough thickness for the reactive cell.

5.2.1 Column Test Setup

The design of a typical column setup is shown in Figure 5-1. A single column with multiple sampling ports along its length is used. The column may be made from glass, plexiglass, stainless steel, or other suitable material. Strictly speaking, glass should be expected to have the least adsorptive or reactive effect with chlorinated organic compounds; however, no significant loss of organics has been found using plexiglass columns. All fittings are Teflon™ or stainless steel. Tubing is either stainless steel or Teflon™. A small section of tubing through the peristaltic pump is made of Viton® for added flexibility.

The column is packed with the reactive medium in such a way as to ensure a homogeneous matrix. One way of doing this is to make small aliquots of well-mixed media (e.g., iron and sand) and fill the column in small batches with each aliquot. Optionally, a section of sand may

be placed above and below the reactive medium in the column to ensure good flow distribution. Average bulk densities, porosities, and pore volumes in the column can be taken by measuring the weights of the reactive media in the column.

The feed water is placed in a collapsible bag made from Teflon™ (or other suitable material) to prevent headspace as the bag empties out. The bag is filled by gravity flow to avoid aeration of the water. Water is circulated in the column from bottom to top in order to better simulate lower flowrates and to minimize the interference of gas production in the column. Sampling ports are equipped with gastight and watertight fittings. A nylon swage lock fitting may be used or a septum may be crimped onto the sample port. It is best to leave the sampling syringe needles permanently inserted into the column, with the tip at the center of the column. Valves with luer lock adapters are attached to the protruding ends of the needles outside the column. A luer lock plug is used to seal the needle between samples. Figure 5-2 shows a typical column test in progress.

Sampling should begin only after the concentration distribution in the column has reached steady state; that is, the net contaminant mass entering the column should be equal to the mass degraded in the column. Several pore volumes of contaminated water generally are required to be run through the column before it reaches steady state (Burris et al., 1995). Also, the time (pore volumes) required to reach steady state varies with contaminant type (Burris et al., 1995). For example, water contaminated with PCE requires a longer time to reach steady state than does water contaminated with TCE. The column may be sampled every 5 to 10 pore volumes until steady state is indicated. Depending on the influent concentration, column length, and flowrate used, the contaminant levels in the effluent may not be below detection.

Whenever a sample is to be drawn, a syringe is attached to the luer lock adapter on the needle and the sample is collected after a small amount of water is purged from the needle. The sample is drawn very slowly to create minimum disturbance in the flow. Most researchers conduct column experiments at room temperature. It is important to note, however, that temperature may be an important factor influencing reaction rate.

The flowrate through the columns may be set to simulate site conditions, if field flow velocities are moderate. However, flowrate may not be a critical parameter for column testing. Gillham and O'Hannesin (1992) found that degradation rates were insensitive to flowrates in the range tested (59 to 242 cm/day). Once degradation rates have been determined through column tests, designing the flowthrough thickness of the reactive cell requires an accurate estimate of groundwater velocity from site characterization data.

Concentration profiles may be generated periodically for the chlorinated organics distribution in the column by collecting and analyzing samples from the influent, the effluent, and the intermediate sample ports after every 5 to 10 pore volumes. Eh and pH profiles of the column may be generated less frequently because of the higher sample volumes required for taking these measurements with typical probes. The column influent and effluent should be analyzed also for inorganics, such as major cations (Ca, Mg, Na, Fe, Mn, and K), major anions (Cl, SO₄, NO₃, NO₂, and silica), and alkalinity (bicarbonate).

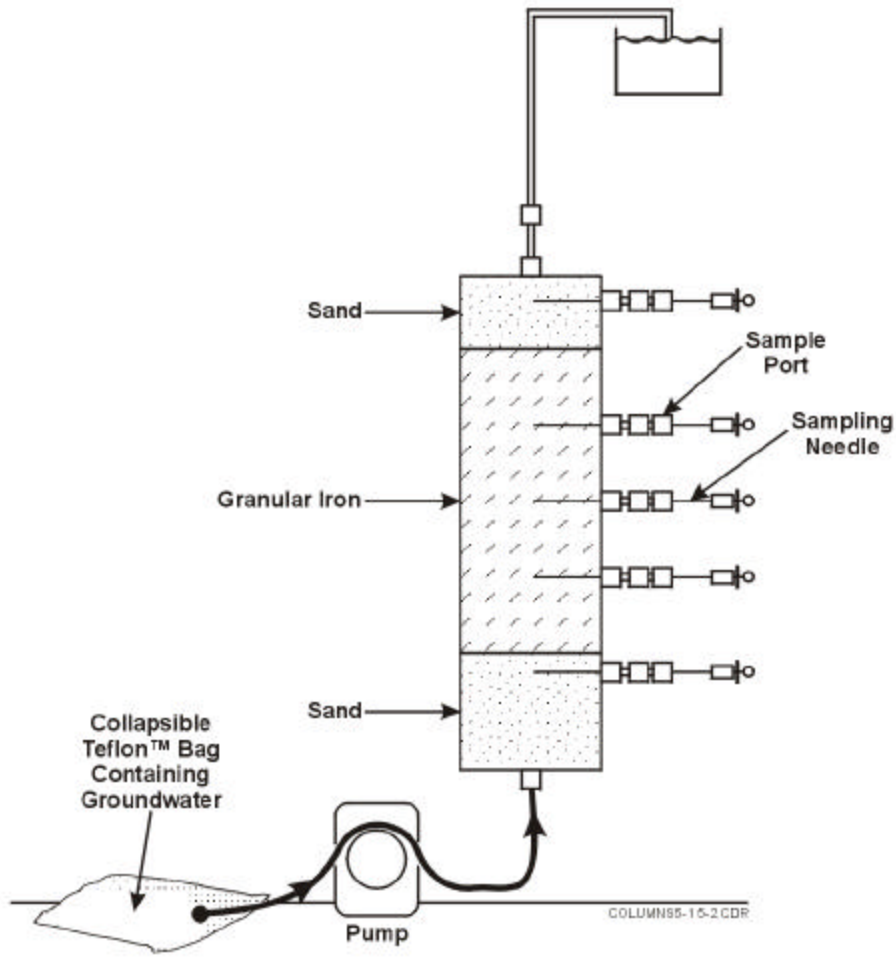

Figure 5-1. Typical Column Setup

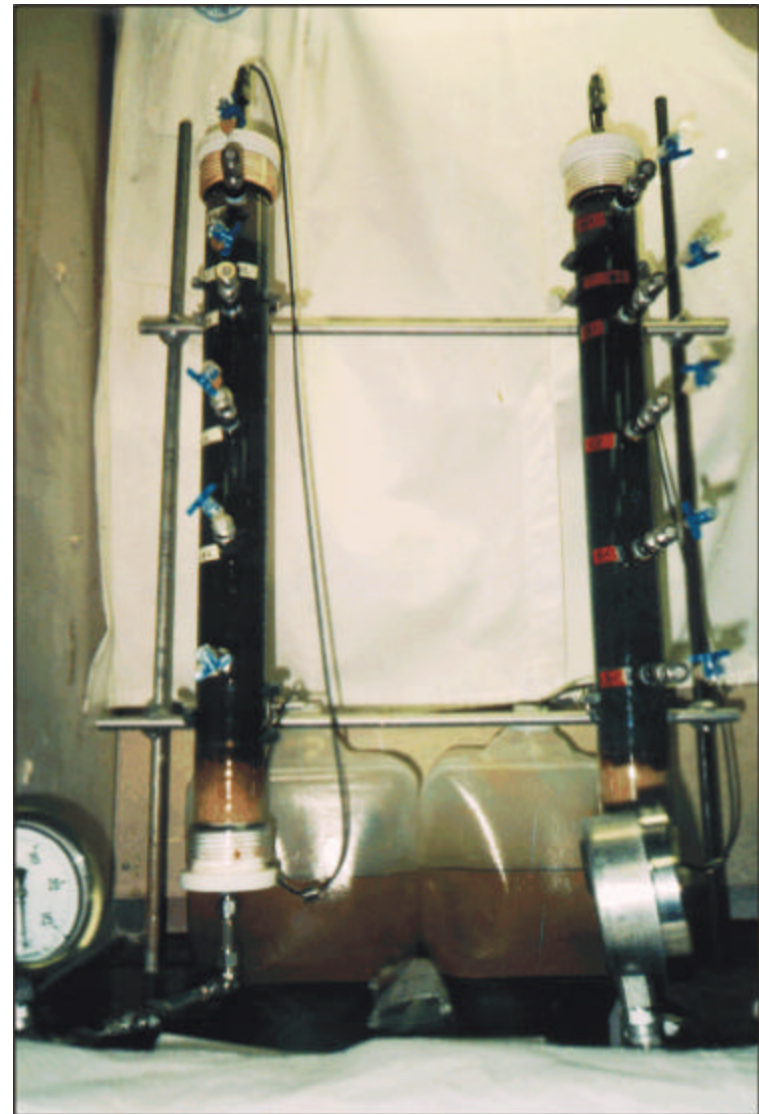

Figure 5-2. Column Test in Progress

Analysis of water samples collected from the column is done by the same general methods used for analyzing groundwater samples during site characterization (see Sections 3.2 and 3.3). Concentrations of CVOCs can be measured using a gas chromatograph-flame ionization detector (GC-FID) with purge-and-trap equipment. Water samples typically are drawn through sampling needles into a gastight syringe and are injected directly into the purge and trap through luer-lock adapters. Although chlorinated compounds can be detected using an electron capture detector (ECD), the GC-FID is suitable for general-purpose work because it can detect both a broad range of low-molecular-weight chlorinated compounds (e.g., TCE, DCE, and VC), as well as nonchlorinated hydrocarbon byproducts such as ethene or ethane. Normally, the instrument is calibrated to detect compounds at the lowest concentrations feasible. A typical detection limit for chlorinated hydrocarbons is 2 µg/L, provided that there is no strong matrix interference that requires dilution of the primary sample.

Anions typically are measured using ion chromatography (IC) and cations by inductively coupled plasma (ICP). Detection limits for inorganic constituents also can depend on the matrix. There should be very little problem with analyte interference when DI or low TDS water (synthetic or actual groundwater) is used; however, this may not be the case when high TDS water is used.

Eh and pH are measured using appropriate probes (usually combination electrodes). Eh and pH can be measured by electrodes inserted into the column at appropriate locations or they can be measured in water samples immediately after they are withdrawn from the column.

Accurate pH measurements can be taken in water samples withdrawn from the column only when the water is buffered or contains adequate concentrations of strong acid or strong base. Because most waters are near neutral to slightly alkaline and metallic compounds may raise the pH above 9, the pH range of 6 to 8 may be the most difficult to obtain accurate readings. This is particularly true when the water in the column contains no buffer, such as carbonate. Similarly, accurate Eh readings taken with a platinum electrode cannot be obtained in water withdrawn from the column unless the system is buffered with respect to electron transfer reactions; such a system is referred to as being “poised.” When a system is not well poised, Eh measurements do not reflect the abundance of electrons that result from the combinations of half-cell couples. Therefore, for accurate Eh and pH measurements, contact between air and the water withdrawn should be minimized as much as possible.

DO is difficult to measure offline, and may require an online flowthrough probe that excludes atmospheric oxygen from the sample. The DO concentration normally will be negligible when Eh is negative, as should be the case when highly reducing metals such as iron or zinc are in equilibrium with the water. Therefore, DO measurements potentially can be omitted during column tests, particularly if Eh can be measured with confidence.

5.2.2 Interpreting Column Data

For each water flow velocity and each column profile, CVOC concentrations can be plotted initially as a function of distance through the reactive column. When the flowrate and porosity are known, distances through the column can be converted easily to residence times. A graph of CVOC concentrations (µg/L) versus residence time (in hours) then can be generated. Several

studies with iron and CVOCs in water have shown that the degradation of CVOCs follows pseudo first-order kinetics (Sivavec and Horney, 1995; Gavaskar, 1999). An example plot of TCE degradation is shown in Figure 5-3. This plot illustrates a series of first-order reactions leading to the formation, and subsequent degradation, of the reaction byproducts DCE and VC. A degradation rate constant, k , can be calculated for each concentration profile using first-order kinetics. Alternately, if the column used in the test is long enough and if the degradation kinetics are fast enough, the TCE, DCE, and VC curves in Figure 5-3 may progress to their respective MCLs. In this case, the required residence time is the longest time taken by any of these CVOCs to reach its MCL. In the illustration in Figure 5-3, the required residence time is determined by the VC degradation time.

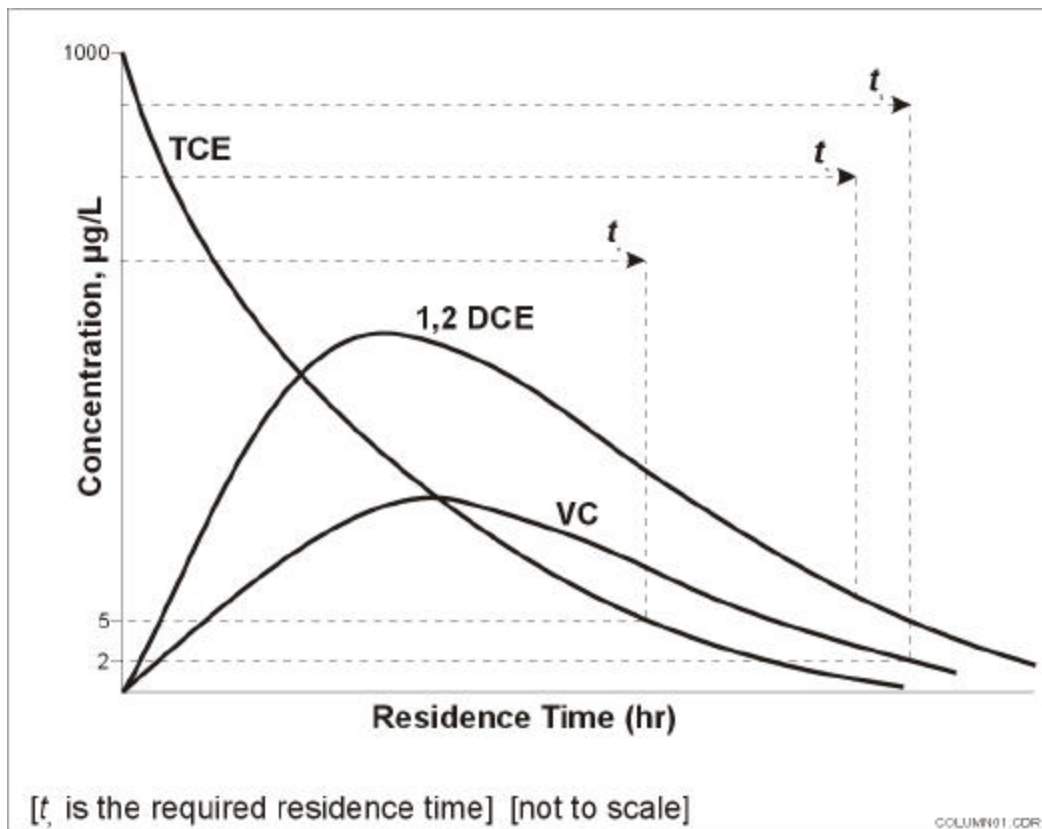

Figure 5-3. Column Concentration Profiles of TCE and Its Degradation Byproducts

Alternately, the first-order kinetics equation (Equation 5-1) can be used to determine a reaction rate (k) or half-life ($t_{1/2}$) for each CVOC compound. When $\ln(C/C_0)$ is plotted against time in hours (see an example plot in Figure 5-4), the slope of the fitted line is the reaction rate, k (hr^{-1}). The degree of fit can be determined by calculating the correlation coefficient (r^2). The r^2 value indicates how well the pseudo first-order model fits the experimental data. Once the rate constant is known, a half-life can be estimated using Equation 5-2 for each organic contaminant of interest in the influent. A half-life is the time period required to reduce the concentration of a contaminant by half. Table 2-1 in Section 2.0 shows the estimated half-lives for various contaminants.

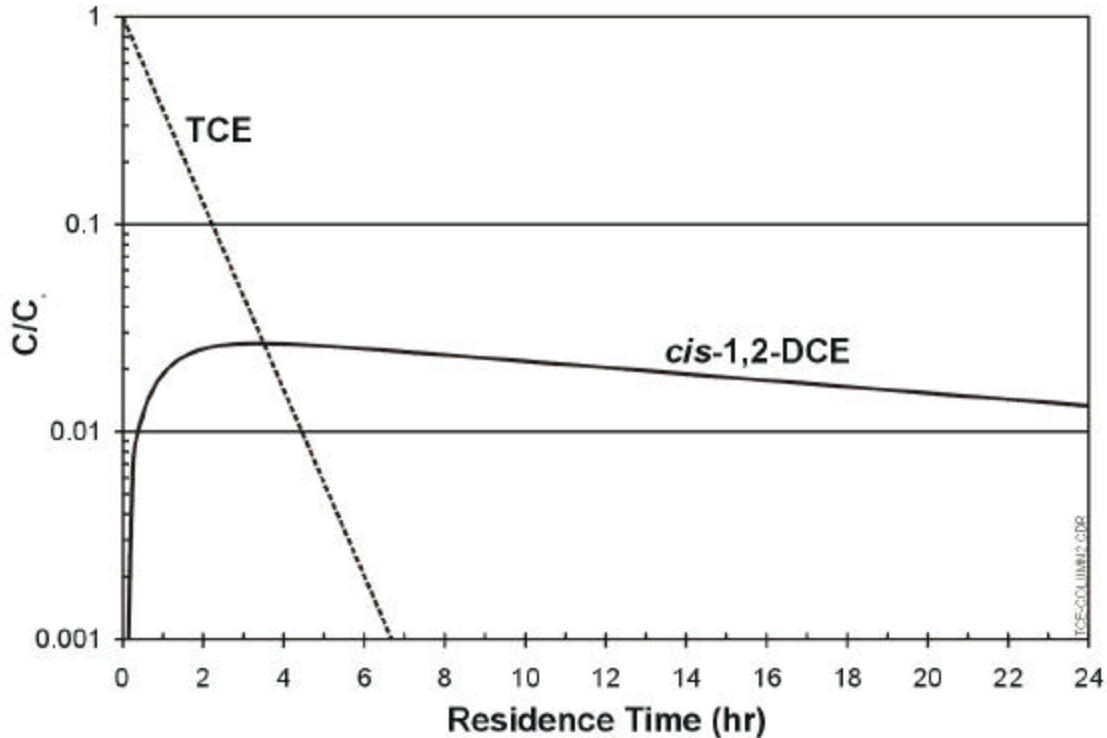

Figure 5-4. Pseudo First-Order Degradation Rate of TCE

$$C = C_0 e^{-kt} \quad (5-1)$$

$$t_{1/2} = \frac{\ln(2)}{k} = \frac{0.693}{k} \quad (5-2)$$

When comparing the half-lives obtained for the same compound in columns with different reactive media, the reactive medium which provides the shortest half-life generally is selected. Costs, availability, environmental effects, and other factors also may be considered, as described in Section 4.0.

Residence time can be estimated from the half-life simply by counting the number of half-lives required to bring the concentration of the CVOC down to its MCL. For example, if TCE enters the reactive cell at 1,000 $\mu\text{g/L}$, eight half-lives are required to degrade TCE to an MCL of 5 $\mu\text{g/L}$. If the half-life of TCE from the column test was determined to be 2 hours, the required residence time in the reactive cell would be at least 16 hours. If there is more than one CVOC of interest in the influent, the residence time is determined from the CVOC with the longest half-life.

5.3 Measuring the Hydraulic Properties of the Reactive Medium

The hydraulic properties of the medium that are required for PRB design include:

- Hydraulic conductivity (K)
- Porosity (n)
- Bulk density (B).

The K value of the reactive medium is required to determine the flow velocity and residence time of groundwater in the reactive cell. Ideally, the K value for unconsolidated media is determined from constant head permeameter tests (Fetter, 1994). These tests are most reliably conducted in laboratories with conventional permeameter facilities. However, it may also be possible to use laboratory treatability test columns to estimate K by setting up the columns as constant head permeameters.

A constant head permeameter consists of an inlet tube with water level (head) maintained at a height slightly above the outlet level of the column. The water is allowed to flow through the reactive medium in the column until steady-state flow is obtained and the volume of water flowing out over a period of time is measured. K is determined from a variation of Darcy's law:

$$K = \frac{V \cdot L}{A \cdot t \cdot h} \quad (5-3)$$

where V = the volume of water discharging in time t
L = the length of the reactive medium sample
A = a cross-sectional area of the sample
h = the hydraulic head difference across the column.

It is important to prepare a uniformly packed column. For design purposes, K is often represented in units of ft/day.

When the flow velocity is known, a porosity (n) estimate of the reactive medium is required to estimate the volumetric flowrate through the reactive cell. The volumetric flowrate in turn is an indicator of the size of the capture zone of the PRB.

A bulk density estimate (B) for the medium is required to obtain initial estimates of the mass of reactive medium that will be required to fill up the specified dimensions of the reactive cell. Porosity and bulk density can be measured during column testing by pre-weighing the reactive medium before it is packed into the column.

Another way to determine K, n, and B is to send a small sample of the reactive medium obtained from a prospective supplier to a geotechnical laboratory for routine analysis for these three parameters. Because the same type of reactive medium (e.g., granular iron) may vary in particle shape and size distribution among different suppliers, sometimes (even for the same supplier) it is important to obtain a representative sample of the medium from the supplier and have it analyzed for K, n, and B during the design phase. It also should be noted that the actual values of these parameters in the field may differ somewhat from the laboratory-measured values because of differences in packing and settling in the field reactive cell. However, the laboratory measurements do provide a relatively good initial basis for design. Table 5-1 lists the hydraulic conductivities measured for granular iron media obtained from different commercial sources. A bulk density correction factor generally is applied to adjust this parameter for the design of the flowthrough thickness of the field reactive cell (see Section 6.2.2).

Table 5-1. Hydraulic Conductivities for Different Sources of Iron Measured in a Geotechnical Laboratory

| Iron Source | Size Range U.S. Standard Sieve Mesh | Bulk Density (lb/ft ³) | Hydraulic Conductivity (K) ^(a) | |
|--|---|---------------------------------------|--|------------|
| | | | (cm/sec) | (ft/day) |
| Peerless ^(b) | -8/+50 | NA | 7×10^{-2} | 198 |
| Peerless ^(b) | -8/+20 | 114 | 6.1×10^{-2} | 173 |
| Peerless ^(b) | -8/+20 | 150 | 6.1×10^{-2} | 173 |
| Peerless ^(b) | -8/+16 | 108 | 8.1×10^{-2} | 230 |
| Peerless ^(b) | -30/+76 | NA | 1.7×10^{-2} | 48 |
| Master Builders ^(b) , Rancho Cucamonga, CA | -8/+50 | NA | 9.0×10^{-2} | 255 |
| Connelly ^(b) | -8/+20 | 110 | 8.3×10^{-2} | 235 |
| Connelly ^(b) | -8/+50 | NA | 5×10^{-2} | 142 |
| Connelly ^(c) | -8/+50 | 146 | 2.7×10^{-1} | 765 |
| Connelly ^(d) | -8/+50 | 122 | 5.5×10^{-2} to 1.9×10^{-1} | 156 to 539 |

(a) Average value from four measurements.

(b) Data supplied by ETI from various PRB sites (ETI, 1999).

(c) Data obtained by Battelle for Dover AFB PRB (Battelle, 2000).

(d) Data obtained from slug tests in the field reactive cell at Dover AFB for comparison (Battelle, 2000).

5.4 Column Tests for Assessing the Longevity of the Reactive Medium

Column tests conducted for contaminant half-life determination also can be used to obtain some indication of the long-term performance potential of the reactive medium with groundwater from a specific site. Concentration profiles can be developed during the column test for inorganic parameters (e.g., plots of pH or Eh versus residence time in the column), just as for the target contaminants. In an iron medium, as conditions become more anaerobic in the column, Eh should decline and pH should increase with increasing distance. Concentrations of anions (nitrate, sulfate, and chloride), cations (Ca, Mg, and Mn), and alkalinity may be measured in the column influent and effluent. Loss of dissolved calcium or magnesium from the groundwater flowing through the column could indicate the potential for precipitate formation in the reactive medium. A comparison of the levels of inorganic constituents in the column influent and effluent can provide a good basis for reactive media selection and longevity assessment. Section 6.4 describes how chemical analysis of the influent and effluent from a laboratory column or a field reactive cell can be used to evaluate the geochemical processes affecting the longevity of the reactive medium.

A more resource-intensive method of evaluating the longevity of a reactive medium is the use of accelerated-flow column tests (Gavaskar et al., 1998; Sivavec, 1996). These tests are not directly required for designing the PRB; however, they provide a means of accelerating the aging of the iron by passing groundwater at a significantly faster rate through the column with reactive medium than would occur at the field site. The advantage is that many pore volumes of groundwater can be passed through the reactive medium in a short time to simulate several years of operation of the field PRB.

Before accelerating the column flow, degradation rates are measured in a column at the expected velocity in the reactive cell at a given site. The flow then is increased to “age” the iron by passing a large number of flow volumes. In the aging process, groundwater species (e.g., DO, cations, and anions) may precipitate out and coat the reactive and adsorptive sites on the medium. Periods of low and high flow are alternated. At each low flow step, as soon as steady state is reached, measurements may be conducted to estimate reaction rates, porosity losses (measured through tracer tests), inorganic profiles, and reaction products.

Caution should be exercised in interpreting the results of accelerated column tests. Aging the reactive medium with 100 pore volumes of flow at 20 ft/day in the laboratory may not exactly mimic the condition of the reactive medium after 1,000 pore volumes of flow at 2 ft/day in the field. Also, reactivity and porosity losses tend to be higher in the first part of the reactive medium. Therefore, extrapolation to the laboratory results to the field situation may not be easy. One precaution in such accelerated-flow tests is to ensure that the flowrate is not set so high that the target inorganic parameters (e.g., DO, pH, ORP, Ca, and Mg) have not leveled off by the time the water exits the column. If the inorganic parameters are leveling off, a fairly representative simulation of field behavior may be possible. Despite all these limitations, accelerated-flow column tests may be the only empirical means for evaluating the longevity of a reactive medium at a given site. Accelerated-flow tests may be considered more an area of investigation for PRB technology developers than for site owners considering routine PRB application.

6.0 Modeling and Engineering Design

Following preliminary assessment, site characterization, reactive media selection, and laboratory testing, the PRB design can proceed. As shown in Figure 2-1 in Section 2.0, designing a PRB involves the following steps:

- ❑ **Hydrologic Modeling.** Hydrologic modeling can be used to select and optimize the best PRB location, configuration, width, and orientation that provide sufficient groundwater capture in the targeted region of the aquifer (plume).
- ❑ **Reactive Cell Thickness Design.** Reactive cell thickness refers to the length of the groundwater flowpath in the reactive medium that provides sufficient residence (contact) time for the contaminants to degrade to target cleanup levels. This thickness is based on the half-lives of the contaminants and the groundwater flow velocity through the reactive cell. The groundwater velocity can be determined through hydrologic modeling of the selected PRB configuration, width, and orientation.
- ❑ **Geochemical Evaluation.** Interactions between the reactive medium and native groundwater constituents, such as DO, calcium, dissolved silica, and carbonate species, may lead to precipitate formation and deposition on the reactive medium surfaces. Over the long-term, precipitation may lead to loss of reactivity and/or hydraulic conductivity of the PRB. For both these reasons, an evaluation of site-specific geochemical parameters and their potential effect on the longevity of the reactive medium needs to be performed.

6.1 Hydrologic Modeling

Hydrologic modeling is an important component of PRB design. Hydrologic modeling analyzes the measured hydraulic characteristics of the aquifer and the reactive medium to:

- ❑ Determine a suitable location and configuration for the PRB with respect to the groundwater flow, plume movement, and site-specific features such as property boundaries, building foundations, and buried utilities.
- ❑ Determine the width of the reactive cell and, for a funnel-and-gate configuration, the width of the funnel that captures the targeted groundwater.
- ❑ Estimate the expected groundwater flow velocity through the reactive cell.
- ❑ Determine appropriate locations for monitoring points in the field PRB system and aquifer (discussed in Section 8.0).
- ❑ Evaluate and incorporate the effects of complications such as temporal fluctuations in groundwater flow direction and velocity; potential for groundwater or plume underflow, overflow, or bypass; and changes in hydraulic parameters over time.

Although several different computer codes have been used for PRB design, the basic steps in hydrologic modeling are common. This section describes the use of models in the evaluation of PRB design and performance. The general requirements of the modeling codes useful for PRB application, a brief overview of the modeling methodology, descriptions of the available codes, and a review of previous modeling studies for PRB design are presented in Appendix C. For most practical purposes, commercially available models such as MODFLOW (flow model) coupled with a particle-tracking model (such as RWLK3D[®]) have been sufficient for the design evaluation and optimization.

The two primary interdependent parameters of concern when designing a PRB are *hydraulic capture zone width* and *residence time*. Capture zone width refers to the width of the zone of groundwater that will pass through the reactive cell or gate (in the case of funnel-and-gate configurations) rather than pass around the ends of the barrier or beneath it. Capture zone width can be maximized by maximizing the discharge (groundwater flow volume) through the reactive cell or gate. Residence time refers to the amount of time contaminated groundwater is in contact with the reactive medium within the gate. Residence times can be maximized either by minimizing the discharge through the reactive cell or by increasing the flowthrough thickness of the reactive cell. Thus, the design of PRBs must often balance the need to maximize capture zone width (and discharge) against the desire to increase the residence time. Contamination occurring outside the capture zone will not pass through the reactive cell. Similarly, if the residence time in the reactive cell is too short, contaminant levels may not be reduced sufficiently to meet regulatory requirements.

The major advantage of constructing a detailed groundwater flow model is that several design configurations, site parameters, and performance and longevity scenarios can be readily evaluated once the initial model has been set up. Thus, the combined effect of several critical parameters can be incorporated simultaneously into one model. Groundwater modeling has been used at most previous PRB installations. In most cases, groundwater flow models have been used in conjunction with particle tracking codes to construct maps showing travel paths and residence times through the reactive cell. The models are usually set up after laboratory column tests have shown the feasibility of the contaminant degradation, and the reaction half-lives and the resulting residence time requirements have been determined. The modeling illustrations for some of the PRB configurations and aquifer conditions are presented in the following sections.

6.1.1 Modeling Continuous Reactive Barriers

The simplest PRB design is a continuous reactive barrier installed in a surficial aquifer and keyed to a confining layer at the bottom. An example simulation for this scenario using MODFLOW followed by a particle-tracking model (RWLK3D[®]) is shown in Figure 6-1. This simulation consists of a 10-ft-long section of reactive cell having a 6-ft thickness in the direction of flow. The aquifer is simulated as a single layer having uniform hydraulic properties with a conductivity of 10 ft/d. The reactive cell is simulated with a hydraulic conductivity of 283 ft/d (0.1 cm/sec). The flow field was simulated with an aquifer gradient of 0.005. Particle tracking techniques were used to delineate the capture zone of the reactive media by delineating flow-paths for 180 days. As indicated by the dashed lines, the capture zone has a width greater than the 10-ft length of the reactive cell. The width of the capture zone will increase or decrease as the ratio of the reactive media hydraulic conductivity to the aquifer hydraulic conductivity increases or decreases, respectively. Residence time through the reactive media can be estimated using particle-tracking methods to ensure sufficient residence time for the degradation reactions

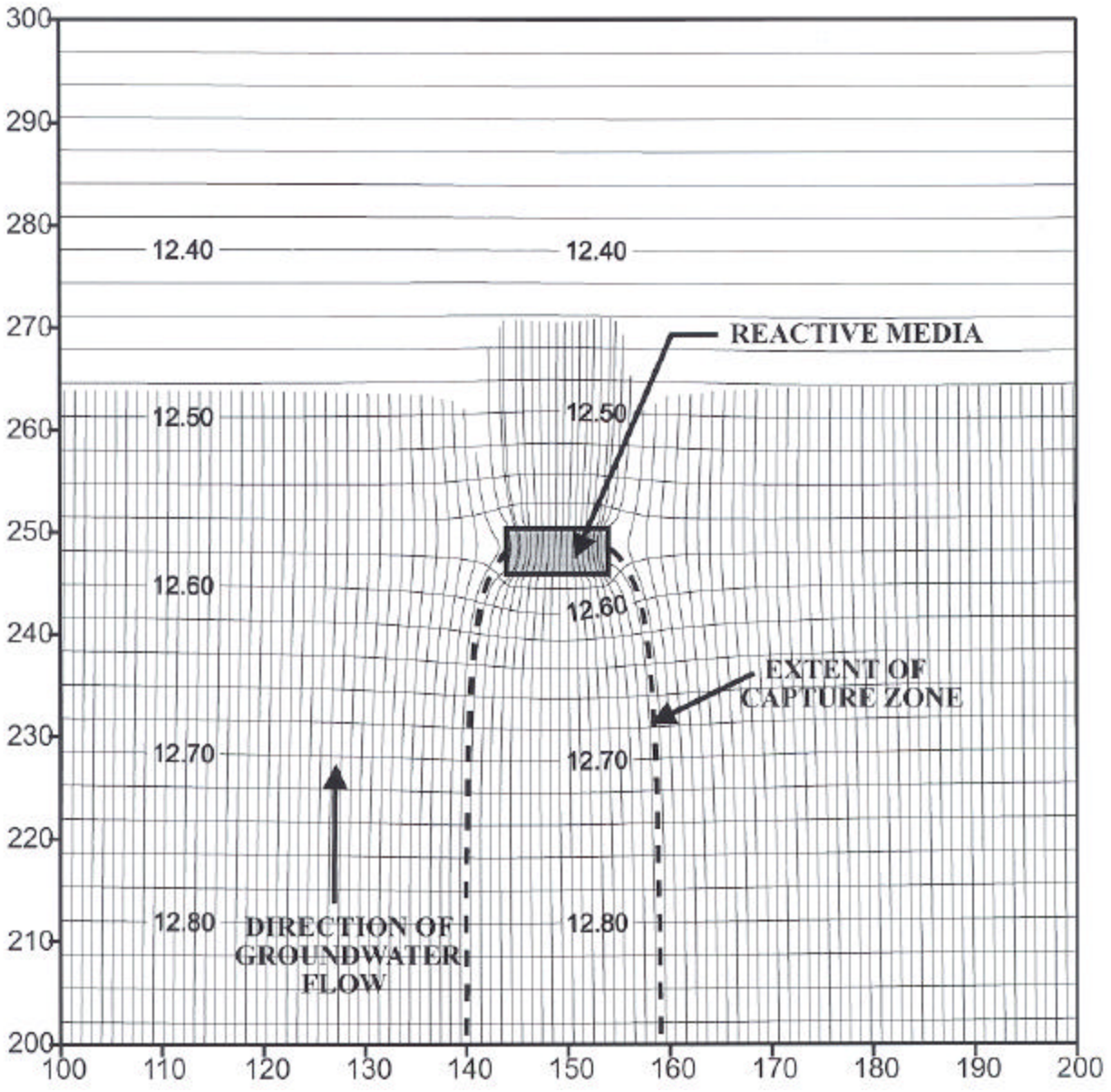

Media: 10 feet long, 6 feet wide (parallel to flow)
 $K_{\text{media}} = 283$ feet/day
 $K_{\text{aquifer}} = 10$ feet/day
 Gradient = 0.005

Figure 6-1. Simulated Capture Zone for a Continuous Reactive Barrier Showing Flowpaths for 180 Days

to occur. In this case, where no funnel walls are used, several short flowpaths into and out of each end of the continuous reactive barrier can occur. Groundwater flowing along these paths does not pass through the entire thickness of the reactive media, and therefore, entrained contaminants may not be fully degraded in these zones unless appropriate safety factors are incorporated into the design. Variations on the straight continuous reactive barrier design mainly include the changes in shape to curvilinear or angled continuous reactive barriers based on site-specific conditions.

6.1.2 Modeling Funnel-and-Gate Systems in Homogeneous Aquifers

At many sites, funnel-and-gate systems may be more appropriate than continuous reactive barriers. The key step in modeling these systems is optimizing the dimensions of the funnel wall so that the capture zone and residence time requirements can be fulfilled. A detailed illustration of the modeling approach for a funnel-and-gate system in relatively homogenous aquifers is presented in Appendix C. This simulation incorporates common PRB features, such as the reactive cell, pea gravel, or funnel walls, into the baseline aquifer model as heterogeneities with the appropriate hydraulic conductivities. Figure 6-2 shows the simulated particle tracking result for this funnel-and-gate system. For the homogeneous aquifer, the hydraulic capture zone is symmetrical and extends beyond the width of the gate. The flow divide upgradient of the funnel walls is at the midpoint of the funnel walls on each side. Mixing of the water flowing through the gate and water flowing around the barrier takes place downgradient.

A more complex funnel-and-gate scenario was used for simulation of a funnel-and-gate system with two gates, one of which was installed at Dover AFB (Battelle, 1997b). The final design for this system is shown in Figure 6-3. Each gate consisted of an 8-ft-diameter caisson containing reactive media, and pre- and post-treatment zone sands. The reactive media section consisted of a 4-ft by 4-ft zone surrounded by a pretreatment and post-treatment zone up to 2 ft thick. Funnel walls were constructed using sheet piling up to a depth of about 40 ft. The funnel walls extended 30 ft between the two gate locations and 15 ft on each end of the installation. A single layer, two-dimensional (2-D) groundwater flow model was used with the aquifer assumed to have a uniform hydraulic conductivity. The calculated flow field was used to estimate the capture zones for the funnel-and-gate installation. At this site, several combinations of K values and temporal variations in groundwater flow conditions were simulated. Figure 6-3 shows the details of flowlines through one of the reactive gates. Based on the simulation, the estimated residence time in the gates ranged from 4 to 26 days and the capture zone ranged from 52 to 54 ft. The capture zone for the entire system and the effect of temporal variations in regional groundwater flow on the portion of the plume captured are shown in Figure 6-4. In this case, it appears that the effect of flow direction fluctuations on plume capture would be minimal and can be easily incorporated in the design. Another aspect at this site is the slow flow velocity of ambient groundwater (around 0.1 ft/d), which may result in very long cleanup times due to slow plume movement. Another observation from this and other flow system simulations presented here is that the flow lines retain their normal course until they reach very close to the funnel walls before turning toward or away from the funnel walls. Therefore, the groundwater flow monitoring efforts in the upgradient aquifer have to be concentrated on this very small zone to observe meaningful changes in flow directions.

6.1.3 Modeling PRBs in Heterogeneous Aquifers

Modeling studies and barrier designs at most existing PRB sites have been primarily based on the assumption that the aquifer sediments in the vicinity of the PRB are homogeneous.

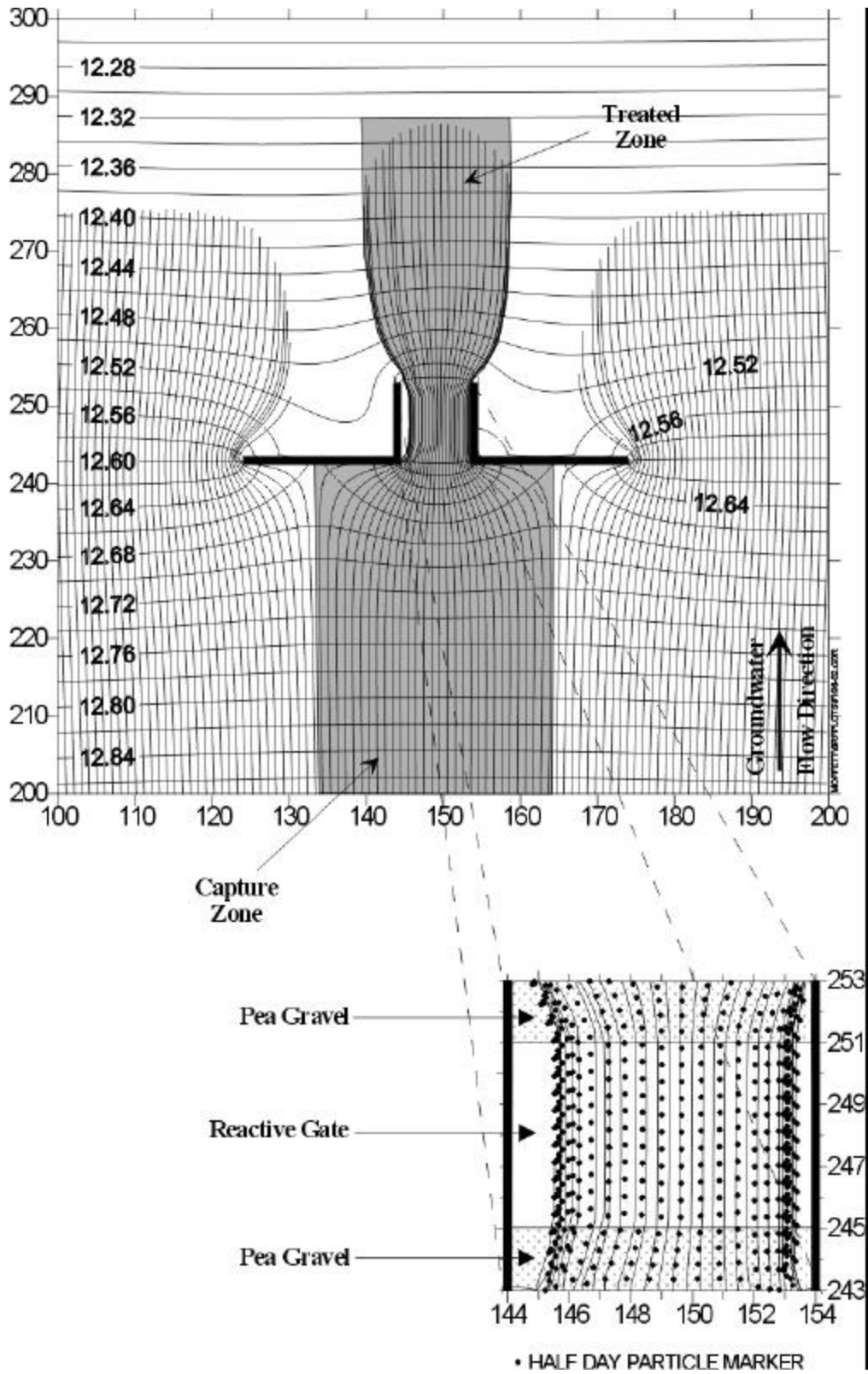

Figure 6-2. Simulated Particle Pathlines Showing Capture Zone for a Funnel-and-Gate System in a Homogeneous Aquifer

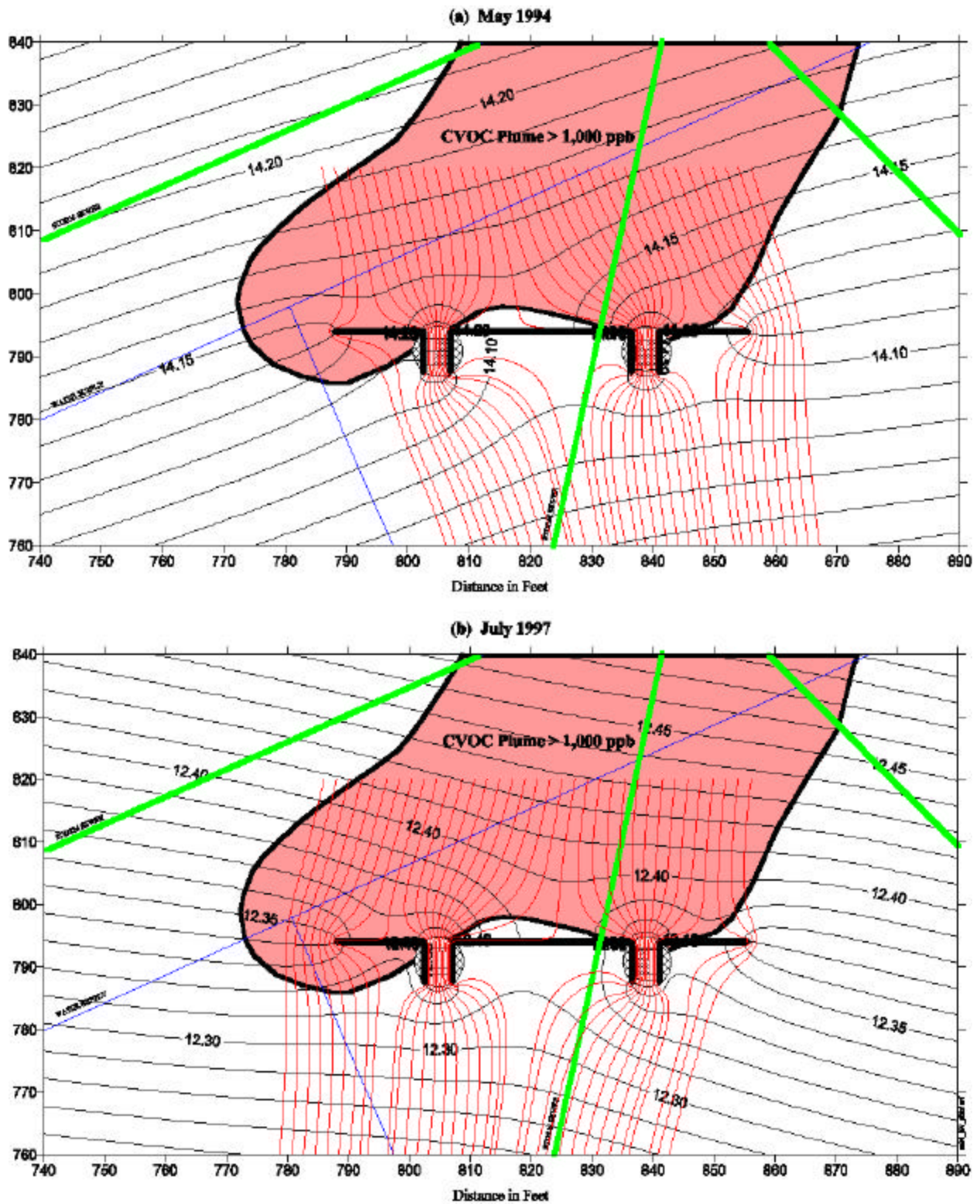

Figure 6-4. Capture Zones for the PRB at Dover AFB Showing the Effect of Fluctuating Flow Directions

However, at many sites, there may be strong heterogeneity in the sediments. This heterogeneity develops mainly due to the variations in depositional environments of the sediments. The general implications of heterogeneity are that more detailed site characterization is required and the models are more complex. The symmetrical capture zones seen in homogeneous sediments become asymmetrical and difficult to predict without detailed characterization and modeling.

Figure 6-5 shows the results of modeling conducted at former NAS Moffett Field (Battelle, 1998). The capture zones at this site, as seen from the particle tracking maps, are highly *asymmetrical*. In the less permeable shallow layers (Layers 1 and 2), there is hardly any movement of particles over 25 days. In the more permeable Layer 3, the particle movement is very fast upgradient of the gate but very slow upgradient of the funnel walls. In the more permeable Layer 4, the particle movement is very fast in front of the west funnel wall but somewhat slower on the eastern side. These irregularities exist because the lower part of the PRB (Layers 3 and 4) is located in a high-conductivity sand channel, whereas the upper part is located in lower-conductivity interchannel deposits. The location of the sand channels at the site was determined based on existing Base-wide site characterization maps and from localized CPT data generated during additional site characterization activities that were conducted to aid the design of the barrier. The irregularities in flow may result in vastly different residence times in the reactive cell. Pea gravel sections along the upgradient and downgradient edges of the reactive cell help to homogenize the vertical and horizontal flow to some extent.

A similar situation is reported by Puls et al. (1995) for the Elizabeth City, NC site. At this site, the geology is characterized by complex and variable sequences of surficial sands, silts, and clays. Groundwater flow velocity is extremely variable with depth, with a highly conductive layer at roughly 12 to 20 ft bgs. The reactive cell was installed in the sand channel to capture the contamination along the fastest flowpath.

These examples illustrate the benefit of placing the reactive cell in a zone of high conductivity that forms a preferential pathway for most of the flow and contaminant transport through the aquifer. Additionally, the dependence of capture zones on aquifer heterogeneities emphasizes the need for detailed site characterization and adequate hydrogeologic modeling prior to PRB design and construction. Particle tracking simulations, such as the one shown here along with a flow model based on good site characterization, also can help in optimizing monitoring well locations for evaluating the performance of the barrier.

6.1.4 Summary of Important Results from Modeling Studies

Several general observations regarding PRB design modeling can be made from the illustrations presented above, the detailed example provided in Appendix C, and from previous modeling studies. Most importantly, modeling can be used to evaluate and optimize different PRB configurations and dimensions for a given set of design parameters. Different widths of a continuous reactive barrier, gate, or funnel can be simulated to evaluate any trade-offs that may occur between various design parameters (e.g., increased hydraulic capture width versus longer residence time in the reactive cell). The illustrative modeling scenarios in Appendix C result in the following considerations for PRB design.

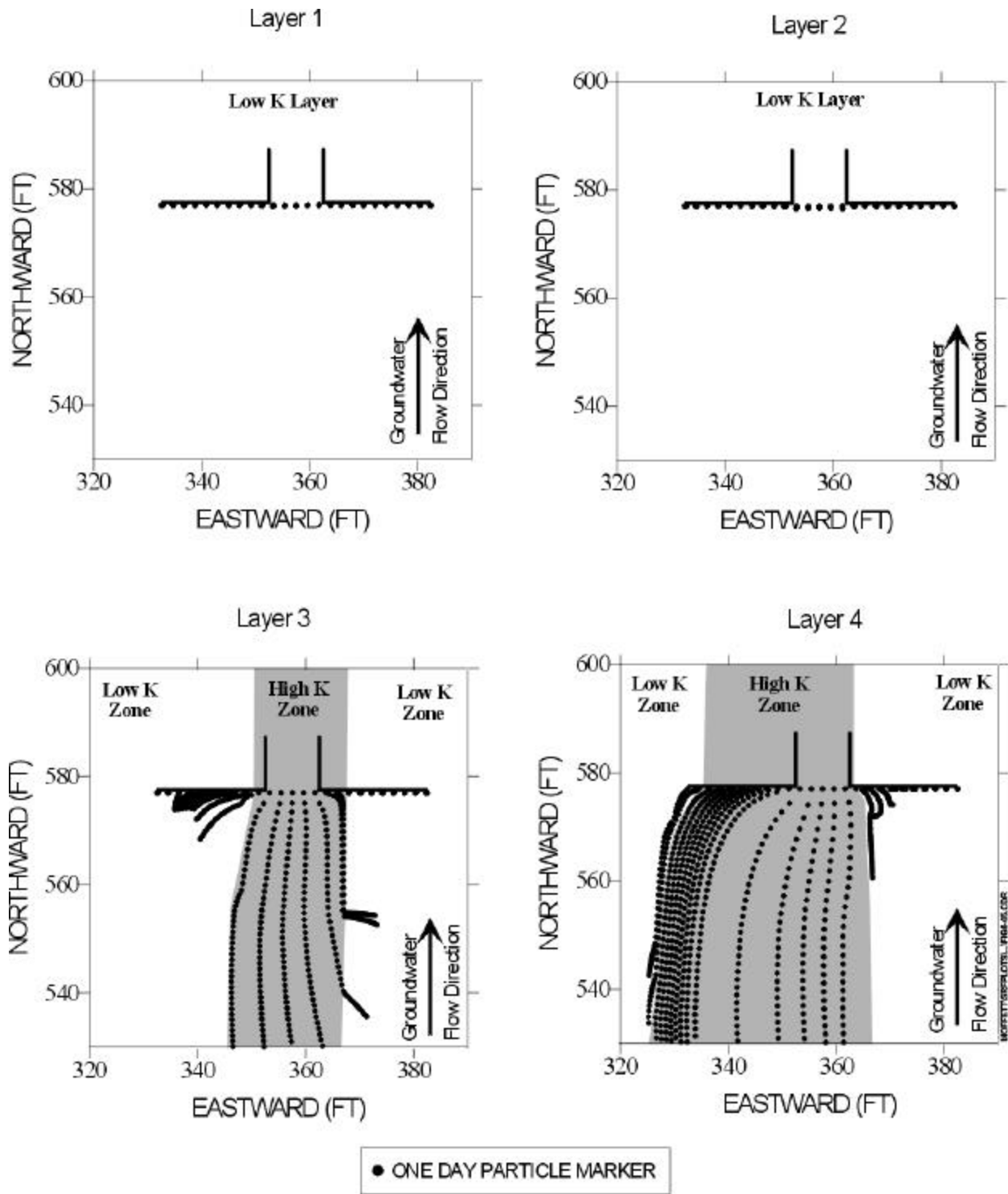

Figure 6-5. Funnel-and-Gate System at Former NAS Moffett Field Showing the Effect of Heterogeneity on Capture Zones (Battelle, 1998)

- ❑ While designing the dimensions of the reactive cell, it is important to note that K_{aquifer} is the sensitive parameter for discharge and residence time through the reactive cell as long as the K_{cell} is several times (about 5) higher than K_{aquifer} . Reductions in K_{cell} do not significantly impact discharge and residence times through the gate until the ratio of K_{cell} to K_{aquifer} drops below about 5:1, at which point K_{cell} becomes an increasingly sensitive parameter. This type of analysis can be used with site-specific models to evaluate the effect of decreasing reactive cell permeability over time on the performance of the permeable cell. Appropriate safety factors (in terms of additional reactive cell width or larger particle size reactive medium) then can be incorporated into the design for anticipated changes in capture zone and residence time.
- ❑ As discharge through the reactive cell increases, capture zone width increases, and travel time through the reactive cell (residence time) decreases. For the scenarios simulated in this illustration, residence times in the reactive cell ranged from more than 200 days for low- K (0.5 ft/day) aquifers to roughly one day for higher-conductivity aquifers (100 ft/day). The estimates of residence times based on particle tracking can be used to optimize the flowthrough thickness of the reactive cell required for achieving the desired reduction in contaminant levels.
- ❑ Particle tracking may be used to design a performance-monitoring network along specific flowpaths. As shown in the simulations, the flowpaths do not bend toward or away from the PRB until the particles are within a few feet of the PRB. Therefore, hydrologic monitoring efforts for capture zone determination need to be focused on these small transitional zones. Particle tracking also is useful if tracer tests are to be conducted in the reactive cell or its vicinity. Some particle tracking codes also can incorporate the solute transport processes, which can be used to evaluate the effects of dispersion within the reactive cell. The fastest travel times determined from the advective-dispersive simulations then would be used to determine the safety factor required in designing the reactive cell.
- ❑ For funnel-and-gate configurations, hydraulic capture zone width appears to be most sensitive to funnel length and aquifer heterogeneity. Capture zone width is generally greater for higher values of K_{cell} when K_{aquifer} is held constant. At ratios greater than 5:1 between K_{cell} and K_{aquifer} , capture zone width does not change significantly when only the K_{cell} is varied. Higher conductivity aquifers have larger capture zones relative to less conductive aquifers for the same K_{cell} . Capture zone width is more sensitive to variability in K_{aquifer} relative to changes in K_{cell} .

The following design results from previous modeling studies (Starr and Cherry, 1994; Shikaze, 1996) are also worth noting:

- ❑ In a funnel-and-gate configuration, the maximum absolute discharge (groundwater flow volume) through the gate occurs when the funnel walls are at an apex angle of 180 degrees (straight barrier).
- ❑ For all apex angles, the maximum discharge occurs when the funnel is perpendicular to the regional flow gradient.

- A balance between maximizing the hydraulic capture zone size of the gate and maximizing the residence time in the reactive cell should be achieved through modeling. In general, for a funnel-and-gate system, hydraulic capture zone size (or discharge through the gate) and residence time are inversely proportional. The residence time usually can be increased without affecting the size of the capture zone by increasing the width of the gate.
- For funnel walls at 180 degrees (straight barrier), the hydraulic capture zone size (or discharge) increases with increasing funnel width. However, the relative capture width decreases dramatically as the funnel width increases. The relative capture zone width is the ratio of the capture zone width to the total width of the funnel-and-gate system.
- For a constant funnel width, the absolute and relative capture zone width increase with gate width. Therefore, it is desirable to have a gate as wide as is economically possible.
- For a given funnel-and-gate design, the capture zone size increases with increase in K_{cell} relative to the aquifer. However, there is relatively little increase in capture zone size when the K_{cell} is more than 10 times higher than K_{aquifer} . Therefore, in selecting the particle size of the reactive medium, it is useful to note that the resulting K_{cell} value need not be more than about 10 times higher than the K of the surrounding aquifer.

6.2 Reactive Cell Thickness Design

The reactive cell thickness is determined by the half-life (residence time) requirements of the target contaminants for a given reactive medium and by the velocity of groundwater through the reactive cell.

6.2.1 Determining Flowthrough Thickness of the Reactive Cell

Based on the groundwater velocity expected in the field reactive cell and the required residence time, the flowthrough thickness (b) of the field reactive cell can now be determined as:

$$b = V \cdot t_w \quad (6-1)$$

where V = velocity in the flow direction
 t_w = residence time.

Hydrologic modeling (Section 6.1) may be used to determine the expected groundwater velocity through the reactive cell. Correction factors are required for temperature and bulk density (see Section 6.2.2). Safety factors may be incorporated into the calculated thickness to account for seasonal variations in the flow, potential loss of reactivity of the iron over time, and any other field uncertainties (Section 6.3).

6.2.2 Correction Factors for Field Application

Some corrections are required to adjust the degradation rate from laboratory data for field application. Temperature and bulk density are the two parameters that often differ between laboratory

and field conditions. The temperature of the groundwater in the field application (typically 10°C) is generally lower than the room temperature of the laboratory column tests (typically 20 to 25°C). The empirical residence time may need to be increased to account for the lower temperature. For example, Senzaki and Kumagai (1988a and 1988b) found that the half-life of 1,1,2,2-TCA increased by 10% when temperature declined from 20 to 10°C. Jeffers et al. (1989) provide a discussion on the use of Arrhenius temperature dependence to adjust for the effects of temperature on degradation rate of organic compounds. The Arrhenius equation relates the reaction rate (k) to absolute temperature (T) as follows:

$$k \propto e^{-E/RT} \quad (6-2)$$

where E is the activation energy, and R is the universal gas constant (8.314 Joules/mol Kelvin). Equation 6-2 can be rearranged as:

$$\ln k = (\ln A) - (E/RT) \quad (6-3)$$

where k = first-order reaction rate constant
 A = frequency factor for the reaction
 E = activation energy
 R = ideal gas constant
 T = absolute temperature.

A plot of ln k versus 1/T should give a straight line with a slope of -E/R and an intercept on the 1/T axis of (lnA)/(E/R). Experimental data from controlled-temperature column tests indicate that the effect of temperature follows the Arrhenius equation (ETI, 1997). Based on the fitted equation, at 15°C in the field, TCE degradation rates could be expected to decline by a factor of 1.4 from those measured in the laboratory at 23°C. Field observations at a test site in New Jersey have shown that the degradation rate declines by a factor of 2 to 2.5 at temperatures of 8 to 10°C compared with laboratory rates. Similar results have been observed at other field sites.

The applicability of the Arrhenius equation was demonstrated in another study (Su and Puls, 1998), in which batch tests were conducted to examine the effects of temperature (10 to 55°C) on TCE degradation by metals, including granular iron. In these batch tests, the normalized half-life for TCE with granular iron from Peerless Metal Powders and Abrasives, Inc., Detroit, MI fell from about 40 hrs to below 10 hrs when the temperature was increased from 10 to 25°C. From 25 to 40°C, and from 40°C to 50°C, the decrease in half-life was not as dramatic. For granular iron from Master Builders the normalized half-lives decreased from about 25 at 10°C to below 10 at 25°C, indicating that iron from different sources may behave differently with temperature. In this study, the activation energy (E) term in Equation 6-3 was estimated at 37.4 kilo-Joules/mole for Peerless iron and 32 kilo-Joules/mole for Master Builders iron.

Temperature versus reaction rate relationships have not yet been determined experimentally for PCE, DCE, or VC. Given PCE's similar behavior to TCE in dehalogenation reactions, it may be assumed that a similar temperature factor would apply.

The bulk density of the reactive cell in the field is generally lower than the bulk density measured in the laboratory because of different settling conditions for the medium. Therefore, the surface area of reactive medium per unit volume of groundwater in the field may be lower than the surface area measured during column testing. Also, degradation rates (or half-lives) are proportional to the specific surface area of the reactive medium (Gillham, 1996; Sivavec and Horney, 1995), so the field residence time must be increased to account for the lower expected ratio of reactive surface area to volume of solution. Currently, there is no clear indication of how large the bulk density correction factor should be. To some extent, this factor would depend on the efficiency of the construction and on how well the reactive medium consolidates after construction. Gillham et al. (1993) reported that an increase in the surface area of iron by a factor of 5 caused the half-life for TCE to decline by a factor of about 2.5. Reduced iron surface area per unit volume of groundwater is the reason why 100% iron degrades faster than iron-sand mixtures. Also, finer iron granules generally have larger surface areas and faster degradation rates.

6.3 Safety Factors for PRB Design Parameters

One of the major design issues in PRB construction is the incorporation of appropriate safety factors into the design. This is a tricky issue, because the estimates of input parameters used in the PRB design can vary by an order of magnitude or more. The parameters that can affect the performance due to variations include the influent contaminant concentrations, the hydraulic gradient, flow direction, and hydraulic conductivity. In addition, potential changes in groundwater geochemistry, porosity, and seasonal variations in temperature also should be considered.

The influent contaminant concentrations may change by several orders of magnitude either as higher-concentration parts of the plume reach the PRB or as a result of changes in recharge or flow patterns over time. The hydraulic gradient generally does not change more than an order of magnitude over time. On the other hand, the groundwater flow direction can change several tens of degrees over time, and hydraulic conductivity may vary by as much as a factor of 5 or 10 between estimated and actual field conditions, even with careful site characterization. These uncertainties may result in the need for wider and thicker PRBs to ensure that the residence time and capture zone requirements are fulfilled.

Detailed and careful site characterization generally can reduce the uncertainty in the parameters to a more acceptable range. It also can prevent future performance failures by ensuring that the minimum requirements for PRB location, width, depth, and thickness are met. However, it may not be possible to incorporate the full range of hydraulic parameter uncertainty into the PRB design, because such caution could lead to unacceptably high capital investment requirements. It is probably sufficient to use a reasonable safety factor, in the range of about 2 to 3 times the calculated flowthrough thickness at most sites. The exact value of this safety factor at a given site depends on the judgment of the design managers concerning the uncertainty in the input parameters (e.g., groundwater velocity) used in the design and in site-specific risk requirements. The safety factor can be reduced by modeling the PRB for a full range of input parameters (e.g., groundwater velocity, groundwater flow direction, and contaminant concentrations) expected at the site, rather than using average values.

A further safety factor can be incorporated into the final design width of the reactive cell, if any perceived uncertainty about groundwater flow velocity and direction exists as a result of either

seasonal variations or limitations of site characterization measurements. Estimating very localized groundwater movement (within a few feet) can be difficult, especially with smaller plumes, and local flow characteristics may be different from regional flow characteristics. The more the actual flow direction deviates from the perpendicular (to the face of the reactive cell), the less likely it is that the targeted groundwater (plume) will be captured, even though the total capture volume may be the same. Such flow variations can be accounted for in the computerized modeling simulations and incorporated with a suitable safety factor into the width of the reactive cell to account for the reduced efficiency of capture. By simulating a wide range of hydraulic flow conditions (including flow direction), optimum orientation and dimensions of the PRB can be designed.

6.4 Geochemical Evaluation of the PRB

Concern over the longevity of permeable barriers arises for contaminant plumes that are expected to persist for the next several years or decades. However, no PRBs have been in operation for more than six years. During this time there have been no reported failures, nor is there a consensus on the factors that would cause them to lose their reactive or hydraulic performance.

Based on studies of geochemical processes in column tests and in existing field PRBs, there seem to be two main reasons that PRB performance could decline. First, the reactivity of granular iron, or other reactive media, could diminish over time until it eventually allows breakthrough of the contaminants of concern. Granular iron, currently the most prevalent reactive medium in use, has not been studied for sufficiently long times in either laboratory or field PRB systems to define the performance lifetime of a barrier. In one accelerated column study (Gavaskar et al., 1998) with granular iron (Peerless Metal Powders and Abrasives, Detroit, MI), the half-life for TCE increased substantially after 1,200 pore volumes of groundwater flow. Samples of the iron were examined by scanning electron microscopy (SEM) and x-ray diffraction (XRD), which indicated the presence of iron oxyhydroxide and iron carbonate nearest the influent end.

Carbonate precipitates (calcite and aragonite) were found in the bulk iron throughout the column. These precipitates, as well as the possibility of iron surface passivation by dissolved silica, have also been reported in studies involving groundwater analysis (inorganic parameters) and analysis of iron core samples from field PRBs at Dover AFB, former NAS Moffett Field, and former Lowry AFB. Trends in the distribution of inorganic parameters at other permeable barrier sites, including Alameda Point, U.S. Coast Guard Support Center at Elizabeth City, NC, and Denver Federal Center, have similarly been attributed to precipitate formation in the iron (Battelle, 1999). Additional research is required in this area to understand the relationship between geochemical processes and loss of reactivity.

Second, inorganic precipitates formed in the reactive medium could occupy the available pore space and eventually reduce the porosity and hydraulic conductivity of the PRB. In the highly reducing environment produced by zero-valent iron, dissolved species, including oxygen, carbonate, sulfate, calcium, magnesium, iron, and silica, can potentially interact to form precipitates that could deposit on the iron or within the pore spaces. Due to their irregular shape and broad size distribution (such as $-8+40$ or $-8+50$), the granular iron typically used in PRBs tends to have a large amount of void space; porosities typically range from 55 to 65% (Battelle, 1999). As shown from the modeling described in Section 6.1, this type of granular medium has considerable capacity to accept such precipitates before its hydraulic performance is significantly

affected. On the other hand, even a thin or mono-molecular layer of precipitates on the iron surface may be enough to prevent access of contaminants to reactive sites on the iron. Additional research is needed in this area to understand the relationship between geochemical processes and loss of hydraulic performance.

The composition of the site groundwater has a strong bearing on the amount of precipitation encountered in a PRB system. Some column studies have shown that precipitation and clogging can be more severe in the entrance to the iron zone when influent DO content is high (Mackenzie et al., 1999). In these experiments a “solidified” zone of iron caused a rapid rise in pressure between a positive displacement pump and the entrance to the column. Clogging of this sort would have greatly reduced flow in a passively fed system, such as would be encountered in an in situ barrier. The researchers in the Mackenzie et al. (1999) study noted that short-term porosity losses are controlled by precipitation of $\text{Fe}(\text{OH})_2$ and entrapment of a film of H_2 gas at the iron surface. $\text{Fe}(\text{OH})_2$, FeCO_3 , and CaCO_3 became important porosity controls at longer treatment intervals, and the appearance of calcium carbonate depended on the carbonate content of the groundwater.

Given these geochemical factors, and the uncertainties associated with their effects, it may be desirable during the PRB design process to evaluate the longevity of the PRB in terms of:

- ❑ Site characterization data (inorganic parameter levels in the site groundwater)
- ❑ Column test data (inorganic parameter levels in the groundwater influent and effluent to the column containing reactive medium)
- ❑ Geochemical modeling.

The sampling and analysis of field parameters (DO, pH, ORP, and conductivity) and other relevant inorganic parameters (including Ca, Mg, NO_3^- , SO_4^{2-} , and Cl) were discussed in Section 3.3. Use of these parameters in geochemical evaluation/modeling and their role in evaluating the longevity of the PRB are discussed in the following two subsections, and are followed by a brief review of further geochemical modeling options.

6.4.1 Geochemical Evaluation with Simple Inorganic Measurements

Inorganic parameters easily monitored during column tests are pH, ORP (Eh), DO, and conductivity. Inorganic parameter measurements should indicate that geochemical conditions inside the reactive medium are conducive to reductive dechlorination. For example, redox measurements should be low and pH should remain close to the steady-state value measured at the beginning of the column test.

DO measurements generally are taken in the field during groundwater collection to determine if the groundwater is aerobic or anaerobic. DO probes are useful for measuring oxygen levels in aquifer groundwater, but generally yield uncertain numbers inside a reactive cell, because iron scrubs oxygen to levels that are many orders of magnitude lower than can be measured by a DO probe.

Conductivity is useful for determining whether the concentration of dissolved ions in the groundwater are changing as water passes through the reactive medium. For example, groundwater entering the reactive medium may become diminished in dissolved ion content due to precipitation reactions brought about by the pH and redox changes. Although details about the precipitation process can only be found by analyzing the inorganic constituents in the water, conductivity measurements provide a quick method to determine if precipitation could be occurring.

6.4.2 Geochemical Evaluation with Other Inorganic Measurements

As water moves through the reactive medium, changes (losses) are often noted between the influent and effluent concentrations of native inorganic species. A change or loss could be an indication that precipitation is occurring within the reactive cell. Due to the large geochemical dissimilarity between a reactive medium (such as iron) and the native aquifer material, changes will be most notable at the influent end of the reactive cell. Although it is usually unclear how much of this precipitate mass stays in the reactive medium and how the mass affects reactivity, the amount of inorganic species (such as calcium and carbonate) lost as the groundwater moves through the reactive medium may be an important indicator of the type and degree of precipitation that is occurring.

Trends in groundwater geochemistry can be detected by routine analysis of some key inorganic species in native groundwater both before (influent) and after (effluent) it has passed through the reactive medium. The influent analysis can be obtained during site characterization. Both influent and effluent concentrations of the inorganic species can be obtained by sampling the influent and effluent to the columns during the laboratory testing stage. The influent and effluent concentrations of various inorganic species can be compared to determine losses that result from interactions with the reactive medium.

Indications that chemical precipitation reactions are taking place in a PRB can sometimes be determined by comparing inorganic parameters along the flowpath in a column test (or in the post-construction monitoring stage in the field PRB system). For example, Table 6-1 illustrates the analysis of groundwater along the flowpath through the reactive medium used at former NAS Moffett Field. The reactive medium samples represent intermediate points along the flowpath through the reactive medium where the speed of some of the reactions can be observed. It can be seen in Table 6-1 that concentrations of Ca, Mg, alkalinity, nitrate, and sulfate are significantly lower in the reactive medium than in the influent. Changes in magnesium are less pronounced compared to Ca and alkalinity, but are also apparent.

Comparing concentrations in the influent and effluent, it can be seen that there is significant decline in dissolved solids, which can be attributed to loss within the reactive cell. Table 6-2 shows the average changes in species concentrations between the influent and effluent sections (equivalent to the influent and effluent from a column test). It can be seen that losses of some species are quite high. For example, alkalinity and sulfate each decline by more than 300 mg/L. These losses also are substantial, relative to the respective influent concentrations; specifically, Mg, Ca, nitrate, and sulfate each decrease by more than 90% and alkalinity decreases by 85%. Some ions behave more conservatively, notably Cl (7%) and Na (18%), while K is intermediate at 34% decline.

Table 6-1. Illustrative Results of Inorganic Chemical Measurements for Groundwater Flow through a Column of Reactive Medium (Iron) Using Former NAS Moffett Field Data as an Example

| Sample Location ^(a) | Calcium (mg/L) | Magnesium (mg/L) | Sodium (mg/L) | Iron (mg/L) | Alkalinity ^(b) (mg/L) | Chloride (mg/L) | Nitrate (mg/L) | Sulfate (mg/L) |
|--|----------------|------------------|---------------|-------------|----------------------------------|-----------------|----------------|----------------|
| <i>Influent to the Reactive Medium</i> | | | | | | | | |
| Influent | 164E | 65.7E | 33.6E | U | 215 | 45.2 | 1.5 | 329 |
| | 163E | 63.7E | 31.9E | U | 289 | 45.7 | U | 335 |
| | 177 | 72.8 | 38.5 | U | 276 | 31.3 | 1.8 | 264 |
| | 164 | 63.9 | 35 | 0.118 | 310 | 46.1 | 2.8 | 342 |
| <i>Groundwater in the Iron Medium</i> | | | | | | | | |
| Upgradient iron | 2.02B | 30.4 | 36.1 | U | U | 38.3 | U | 56.7 |
| | 2.25B | 17.5 | 34.3 | U | 89.2 | 37.8 | U | 21.8 |
| | 3.49B | 32.8 | 32.6 | U | 70.8 | 39.5 | U | 94.4 |
| | 8.27 | 16.3 | 33 | U | 62.2 | 39 | U | 51 |
| Down-gradient iron | 0.921B | 0.349B | 36 | 0.029B | 14.3 | 42.4 | U | 1 |
| | 1.48B | 0.488B | 35.7 | 0.044B | 14.1 | 43.3 | U | 1.1 |
| | 0.486B | 0.852B | 34.7 | U | 16.6 | 41.2 | U | 4.2 |
| | 87.8E | 1.16EB | 41.6E | 0.035B | 134 | 39 | U | 111 |
| <i>Effluent from the Reactive Medium</i> | | | | | | | | |
| Effluent | 1.41EB | 0.593EB | 26E | 0.347 | 12.4 | 41.7 | U | 1 |
| | 5.21 | 1.13B | 27.1 | 0.326 | U | 39.1 | U | 4.6 |
| | 7.51 | 2.31B | 28.5 | 0.053B | 13.6 | 37.1 | U | 11 |
| | 13.2 | 0.327B | 32.1 | U | 19.4 | 36.5 | U | 29 |

(a) Multiple measurements.

(b) Alkalinity as CaCO₃.

U = The compound was analyzed but not detected at or above the specified reporting limit.

B = The compound was detected in the associated method blank.

E = The amount reported exceeded the linear range of the instrumentation calibration.

Table 6-2. Average Changes in Species Concentrations Between Influent and Effluent from the Reactive Medium Using Data from Former NAS Moffett Field as an Illustration

| Section/Change | Na (mg/L) | K (mg/L) | Mg (mg/L) | Ca (mg/L) | Alkalinity (mg/L) | Cl (mg/L) | Nitrate (mg/L) | Sulfate (mg/L) |
|----------------|--------------|-------------|--------------|--------------|----------------------|--------------|-------------------|-------------------|
| Influent | 35.5 | 2.1 | 66.9 | 165.4 | 412 | 42.2 | 2.0 | 333 |
| Effluent | 29.1 | 1.4 | 1.0 | 10.4 | 62 | 39.1 | 0.0 | 18.0 |
| Change | 6.4 | 0.7 | 65.9 | 155 | 350 | 3.1 | 2.0 | 315 |
| % Change | 18% | 34% | 98% | 94% | 85% | 7% | 100% | 95% |

As seen in Table 6-1, the decrease in calcium, nitrate, and sulfate concentrations appears to take place quickly in the iron. Concentrations of these ions decrease sharply as the water enters the upgradient portion of the reactive medium. However, following this initial decline, the concentrations of these ions remain steady as water moves through the rest of the reactive medium, which suggests that the kinetics of the controlling reactions for these ions take place on a similar time scale as the residence time of groundwater in the reactive cell. The appearance of steady-state conditions in the downgradient portion of the reactive medium suggest that reactions are completed by the time water reaches the downgradient end of the iron.

Such changes in inorganic constituents suggest that inorganic compounds are precipitating within the reactive medium as a result of changes in pH and Eh. For example, reductions in the concentrations of alkalinity, calcium, and magnesium are believed to be caused by precipitation of aragonite or calcite (CaCO_3) and magnesite (MgCO_3). The magnesium concentration also may be affected by precipitation of magnesium hydroxide (brucite). Sulfate concentrations are not sufficiently high to cause precipitation of minerals, such as gypsum ($\text{CaSO}_4 \cdot 2\text{H}_2\text{O}$). It is more likely that reducing conditions lead to reduction of sulfate to a lower oxidation state of sulfur, such as sulfide, which then precipitates as FeS or FeS_2 . Other possible precipitates include ferrous carbonate (siderite), iron hydroxide, and “green rust,” a compound of ferrous or ferric iron containing hydroxide, chloride, and sulfate.

A rough estimate of the amount of precipitation that may be expected to occur in the reactive medium in a field PRB can be obtained by measuring the losses (differences) of the inorganic species between the influent and effluent in a column test, without measuring intermediate concentrations. The reduced data set in Table 6-2 can be used to roughly estimate these losses, as shown in Table 6-3. The concentrations in Table 6-2 were multiplied by the estimated volumetric flowrate through the reactive cell designed at the former NAS Moffett Field site for a groundwater velocity range of 0.2 to 0.5 ft/day (310,000 L/yr at 0.2 ft/d and 775,000 L/yr at 0.5 ft/d). Table 6-3 shows that the total solids produced per year ranged from 279 to 697 kg. However, the distribution of inorganic matter may not be even throughout the reactive cell. For example, the bulk of the precipitation may take place in the upgradient portion of the reactive cell. The true difficulty lies in the inability to relate these groundwater inorganic parameter losses to the degree of loss of reactive sites on the reactive medium surfaces.

Table 6-3. Estimated Annual Loss of Inorganic Species Due to Precipitation at Former NAS Moffett Field

| Flowrate ^(a) (ft/d) | Na (kg) | K (kg) | Mg (kg) | Ca (kg) | Alkalinity (kg) | Cl (kg) | Nitrate (kg) | Sulfate (kg) | Total (kg) |
|-----------------------------------|------------|-----------|------------|------------|--------------------|------------|-----------------|-----------------|---------------|
| 0.2 | 2.0 | 0.2 | 20 | 48 | 109 | 1.0 | 0.6 | 98 | 279 |
| 0.5 | 5.0 | 0.6 | 51 | 120 | 272 | 2.4 | 1.5 | 244 | 697 |

(a) Estimated from hydrogeologic modeling of the PRB-aquifer system.

Dissolved silica is another inorganic constituent present in groundwater that is of potential concern to the longevity of a barrier. Monomeric silicic acid, H_4SiO_4 , is known to form polymers that may coat iron grains, producing a passivating film. It is unknown whether or to what extent dissolved silica acts as a corrosion inhibitor for granular iron. Figure 6-6 shows the distribution of dissolved silica (as SiO_2) in the PRB at former NAS Moffett Field. The trend line is for visual effect and is not based on modeling. Note that the overall behavior of silica is similar to that of other inorganic species, whose concentrations decrease due to precipitation.

At this stage of development of the PRB technology, there is no way of linking the mass of precipitates generated in the reactive cell to the depletion of reactive surface area in the reactive medium. Several studies currently are being conducted to address this issue.

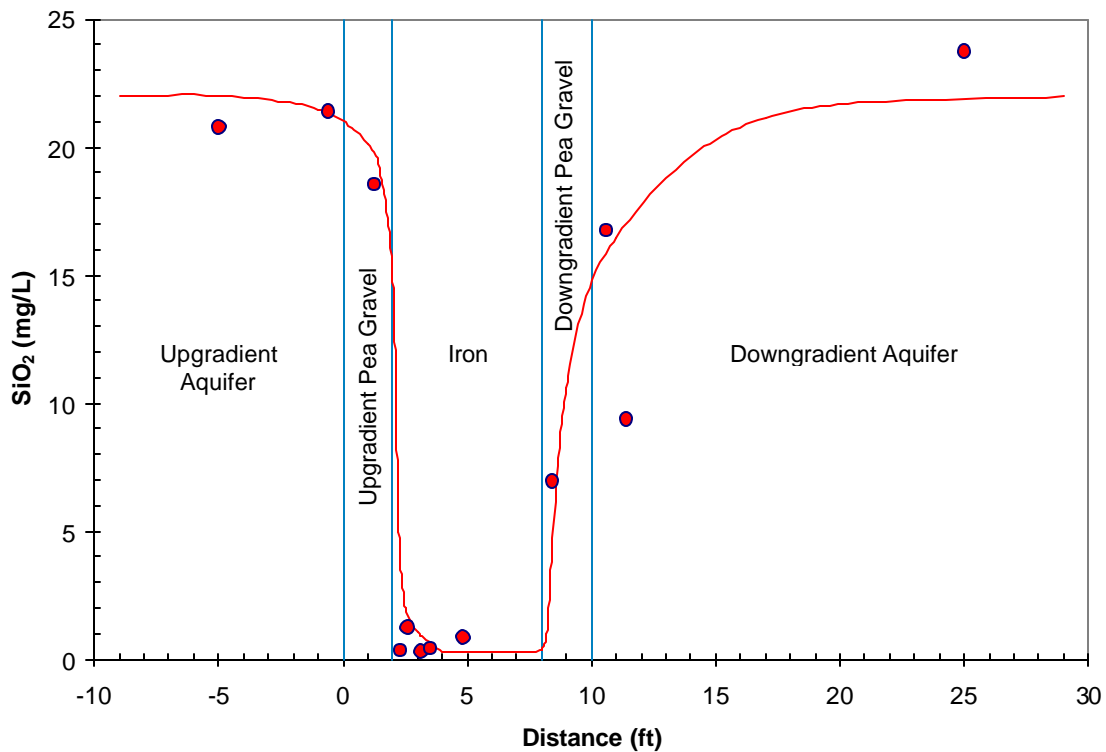

Figure 6-6. Distribution of Dissolved Silica in the PRB at Former NAS Moffett Field

6.4.3 Geochemical Modeling

The geochemical evaluation described in Sections 6.4.1 and 6.4.2 should be possible without significant resources being expended, and should be sufficient for most full-scale PRB applications. If more detailed evaluation is required, Appendix D describes the use of computerized geochemical modeling for evaluating precipitation reactions and the longevity of a PRB. In addition, core samples of the reactive medium can be analyzed after suitable intervals (after the field PRB is installed) for physical evidence of precipitates and confirm their existence (see Section 8.3.3). Geochemical modeling and core analysis are specialized analytical tools that are generally suitable for research work undertaken for technology development purposes. However, if reactivity or flow problems develop at PRB sites, these additional tools may be useful for further evaluation of geochemical processes affecting PRB performance. Geochemical modeling also is useful for evaluating new reactive media for PRB application.

7.0 Construction Methods

Once the desired location, configuration, and dimensions of the PRB have been determined, a suitable construction technique must be selected. Conventional and innovative techniques that could be used to install a PRB are discussed in detail in this section and are summarized in Table 7-1. The information in Table 7-1 was compiled from various vendors. The technical and

Table 7-1. Summary of Various Techniques for Barrier Construction

| Construction Techniques | Maximum Depth (ft) | Vendor-Quoted Cost ^(a) | Comments |
|--|--------------------|-----------------------------------|--|
| <i>Slurry Wall and Sheet Pile Installation</i> | | | |
| Soil-bentonite slurry wall | | | Requires a large working area to allow for mixing of backfill. Generates some trench spoil. Relatively inexpensive when a backhoe is used. |
| • Standard backhoe excavation | 30 | \$2-10/ft ² | |
| • Modified backhoe excavation | 80 | \$2-10/ft ² | |
| • Clamshell excavation | 150 | \$6-17/ft ² | |
| Cement-bentonite slurry wall | | | Generates large quantities of trench spoil. More expensive than other slurry walls. |
| • Standard backhoe excavation | 30 | \$4-22/ft ² | |
| • Modified backhoe excavation | 80 | \$4-22/ft ² | |
| • Clamshell excavation | 200 | \$16-55/ft ² | |
| Composite slurry wall | 100+ | NA | Multiple-barrier wall. Permeability less than 1×10 ⁻⁷ . |
| Geomembrane barrier | 40-50 | \$38/ft ² | |
| Steel sheet piles | 60 | \$15-30/ft ² | No spoils produced. |
| Sealable-joint piles | 60 | \$15-30/ft ² | Groutable joints. |
| <i>PRB Installation</i> | | | |
| Caisson-based construction | 50+ | \$50-300/vertical ft | Relatively inexpensive. |
| Mandrel-based construction | 40-50 | \$10-25/ft ² | Relatively inexpensive and fast production rate. A 3- to 5-inch-thick zone can be installed in a single pass. |
| Continuous trenching | 25 | \$5-12/ft ² | High production rate. High mobilization cost. |
| Jetting | 200 | \$40-200/ft ² | Ability to install barrier around existing buried utilities. |
| Deep soil mixing | 150 | \$80-200 /yd ³ | May not be cost-effective for PRBs. Columns are 3 to 5 ft in diameter. |
| Hydraulic fracturing | 80-120 | \$2,300 per fracture | Can be installed at deep sites. Fractures are only up to 3 inches thick. |
| Vibrating beam | 100 | \$8 /ft ² | Driven beam is only 6 inches wide. |

(a) Does not include mobilization cost.

NA = not available.

cost claims for each technology should be verified on a site-specific basis with direct discussions with the vendors of appropriate technologies. Factors that limit and ultimately determine the type of construction method used include:

- ❑ Installation depth
- ❑ Required reactive cell permeability
- ❑ Site topography
- ❑ Site access and work space
- ❑ Geotechnical constraints
- ❑ Soil characteristics (of backfill)
- ❑ Disposal requirements of contaminated trench spoils
- ❑ Costs.

The reactive cell is the portion of the aquifer that is modified to contain the reactive medium through which a contaminated plume will flow. Figure 7-1 shows various arrangements of a reactive cell that may be used depending on site-specific hydrogeologic conditions. In a continuous reactive barrier configuration, the reactive cell runs along the entire width of the barrier. In a funnel-and-gate system, only a portion of the total barrier width is taken up by the reactive cell. For some initial PRB applications, the reactive medium was bounded on both upgradient and downgradient sides by thinner sections of pea gravel in an effort to improve flow and homogenize influent contaminant concentrations. However, in most subsequent applications, the use of pea gravel zones has been eliminated as their benefit appears to be marginal.

7.1 Excavation Methods for Reactive Cell Construction

The reactive cell generally is excavated and completed above the water table to allow for water-level fluctuations and medium minimization, although this process may vary from site to site. Generally, the reactive cell is keyed at the bottom end into the aquitard, unless the PRB has a hanging-barrier configuration. In a funnel-and-gate system, the funnel walls may also be keyed about 5 ft into the aquitard. In the excavation method of installing the reactive medium, it is relatively easier to ensure and verify the desired continuity and thickness of the reactive cell. If the innovative injection techniques discussed in Section 7.2 are used, greater depths are possible; however, ensuring and verifying the desired continuity and thickness of the reactive cell may be relatively more difficult.

7.1.1 Excavation with a Backhoe

Depending on the design of the PRB, installation of the reactive cell may require the excavation of a trench that will house the reactive medium. Backhoes are the most common types of equipment used for conventional trench excavation. Standard backhoe excavation for shallow trenches down to 30 ft deep is the cheapest and fastest method available. The digging apparatus is staged on a crawler-mounted vehicle and consists of a boom, a dipper stick with a mounted bucket, and either cables or hydraulic cylinders to control motion. Bucket widths generally range in sizes up to 5.6 ft. Because the vertical reach of a backhoe is governed by the length of the dipper stick, backhoes can be modified with extended dipper sticks and are capable of reaching depths up to 80 ft (Day, 1996). Even greater depths are possible if benches can be excavated in which the backhoe can be located, thereby enabling the whole backhoe to sit below

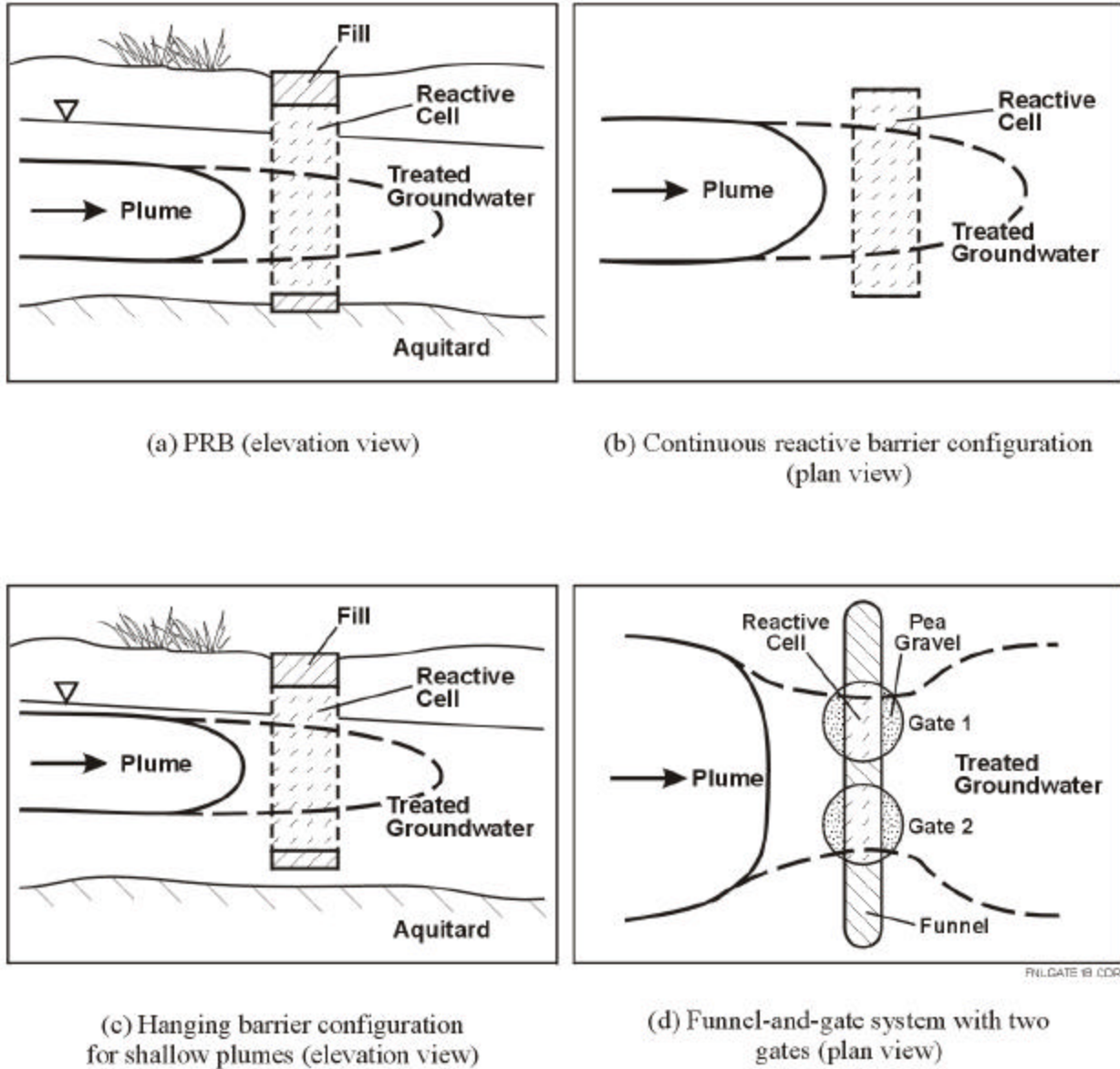

Figure 7-1. Various PRB Configurations

grade; however, this method can be time-consuming and can require a large area to be excavated to reach the required depth.

To ensure the stability of the trench wall during reactive cell construction, several options may be used. A first option is the cofferdam approach, in which temporary steel sheet piles are driven into the ground along the boundaries of the intended reactive cell prior to excavation and then are reinforced with bracing as the trench is excavated. If required, sheet piles also can be used to temporarily separate reactive medium and pea gravel sections within the trench (Figure 7-2). Dewatering of the trench may be required if sheet piling cannot prevent groundwater seepage



Figure 7-2. Placement of Reactive Iron Media (Suspended Bag) and Pea Gravel (Front-End Loader) into Divided Sections of Trench for a PRB (Courtesy of PRC, 1996)

into the reactive cell. Interlocking or sealable-joint sheet piles (see Section 7.3.1) are better at preventing water seepage from the sides, but water may still seep in from the bottom of the excavation. The temporary sheet piles are removed after the excavation is backfilled with the reactive medium. Generally, the sheet piles along the side of the trench (parallel to groundwater flow) are left in place to prevent short-circuiting of flow. The advantage of using this trench stabilization method is that the walls of the trench are retained even as the trench is being dug. The disadvantage is that some portions of the intended trench, such as the corners, may be difficult to access with a backhoe when sheet piles are present. With any excavation technique, if entry of personnel into the trench is required (for example, to clear out the corners of the trench), special safety measures, such as those for confined space entry, may be applicable. The cofferdam approach has been used at a number of PRB sites, including a DOE site in Kansas City, MO; Watervliet Arsenal, NY; Intersil, CA; two industrial facilities in the States of New York and Kansas; and the Denver Federal Center and former Lowry AFB in Colorado.

Another method of trench stabilization involves the use of a trench box to create void space for the installation of either an impermeable or permeable zone (Breaux, 1996). The trench box can be pre-fabricated aboveground using interlocking sheet piles and inserted into the open trench. After backfilling the reactive cell, the sheet piles are removed. The advantage of this method is that clearing the corners of the intended reactive cell is not a problem. The disadvantages are that the trench must be completely excavated before the box can be installed and temporary sheet piles must be used to maintain trench stability. The trench box approach has been used at some PRB sites, including Warren AFB, WY; Watervliet Arsenal, NY; Canadian Forces Base, Canada; former NAS Moffett Field, CA; an industrial facility in the State of Massachusetts; and a National Aeronautics and Space Administration (NASA) facility in the State of Louisiana.

7.1.2 Excavation with a Clamshell

A clamshell bucket can be used for excavation to around 200 ft bgs. A cable-suspended mechanical clamshell is a crane-operated grabbing tool that depends on gravity for accurate excavation and closure of the grab (Figure 7-3). Therefore, a heavier tool is beneficial.

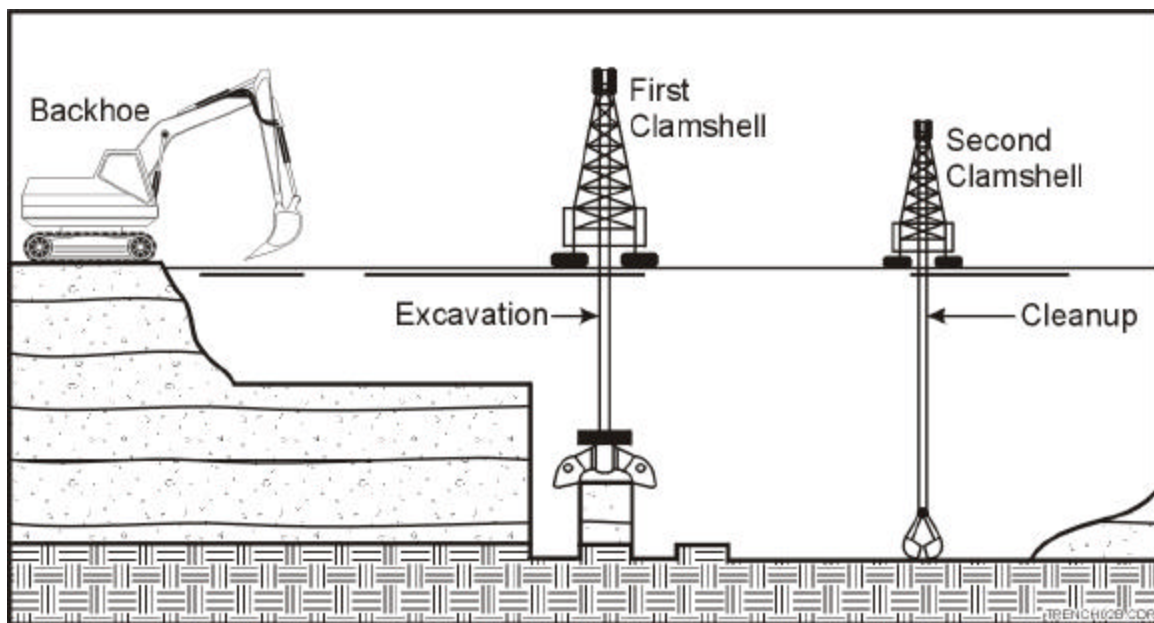

Figure 7-3. Trench Excavation Using a Clamshell and Backhoe

Hydraulic clamshells can be equipped with a Kelly bar to help guide and control the vertical line in addition to providing weight. The verticality of the excavation is controlled by the repeated cyclic lifting and lowering of the bucket under gravity. Mechanical clamshells are preferred over their hydraulic counterparts because they are more flexible in soils with boulders, can reach greater depths, and involve fewer maintenance costs. Clamshell excavation is popular because it is efficient for bulk excavations of almost any type of material except highly consolidated sediment and solid rock. It also can be controlled and operated in small and very confined areas as long as the boom can reach over the trench. Clamshell excavation, however, has a relatively low production rate compared to a backhoe. Also, worker safety can become an issue during clamshell excavation. At previous PRB installations, construction sometimes involved sending a

person into the trench to clear soil out of regions in the perimeter sheet piles that were not accessible to the clamshell. Clamshell excavation has been used to construct the PRB at the Canadian Forces Base at Borden, Canada.

7.1.3 Excavation with a Caisson

Caissons are load-bearing enclosures that are used to protect an excavation (Figure 7-4), and are a relatively inexpensive way of installing reactive cells at depths inaccessible with a standard backhoe. Caissons may have any shape in cross section and are built from common structural materials. The caissons can be pre-fabricated and transported to the site, or they can be built in sections with each section welded on top of the next as the caisson is driven in at the site. For PRB sites at Somersworth Landfill and Dover AFB, where this technique has been used, the barriers were installed to depths of 50 and 45 ft, respectively, and the caissons were 8-ft-diameter circular cylinders open at both ends. Caissons as large as 15 ft in diameter have been used in bridge construction; however, smaller diameter caissons are more common. In spite of the steel edges at the bottom of the caisson, it does not sink through soil under its own weight because friction along the sides of the caisson is high and can range from 300 lb/ft² to more than 1,000 lb/ft². At Dover AFB, a vibratory hammer mounted on a crane was used to drive the caisson in. The interior of the caisson was excavated with a large auger to make room for the reactive medium.

Pulling the caisson out may prove to be more difficult than driving it in, especially with the pressure from the reactive iron medium inside. At the Somersworth and Dover AFB sites, a vibratory hammer was used to pull the caisson out at both sites. At Somersworth, the caisson got stuck after it was withdrawn a few feet. Cobbles and/or highly consolidated sediments were thought to be the cause of the impedance. Extraordinary measures had to be taken to dislodge the caisson and pull it out the rest of the way. At Dover AFB, both caissons were withdrawn easily in spite of the presence of an intermediate clay layer. However, the 0.5-inch-thick structural steel material of the caisson, which held up fairly well when the caisson was driven in, started tearing near the vibratory hammer grip when it was being pulled. When the caisson continued to tear despite changing the position of the grip a few times, a 1-inch-thick steel collar was built around the top edge of the caisson. No further problems were encountered. At Dover AFB, the iron medium subsided by about 2 ft when the caisson was pulled out. Part of this subsidence was due to the reactive medium entering the thin annular space left behind by the caisson walls. But some subsidence was probably due to the granular iron itself consolidating under the vibrations from the caisson (Battelle, 2000).

It is difficult to ensure a good seal between the caisson gates and the funnel wall in a funnel-and-gate system because loose iron consolidates into the annular space left behind by the caisson walls. At Dover AFB, interlocks were welded on the two side dividers (Figure 7-5). The first sheet pile of the funnel wall on either side of the gate was guided into this interlock and the joint was grouted to obtain a good seal. Also, during construction of a caisson, some soil compaction can occur along the walls of the caisson that can lower the permeability around the intended reactive cell. If the formation contains a significant amount of cobbles, the caisson may be deflected to an off-vertical position as it is pushed down, or it may even meet refusal. At one previous installation, highly consolidated sediments and cobbles created difficulties in driving in and pulling out the caisson (ETI, 1996). It also may be difficult to drive a caisson to depths greater than about 45 ft.



(a)



(b)

Figure 7-4. (a) Driving and (b) Excavation of a Caisson for Reactive Media Installation

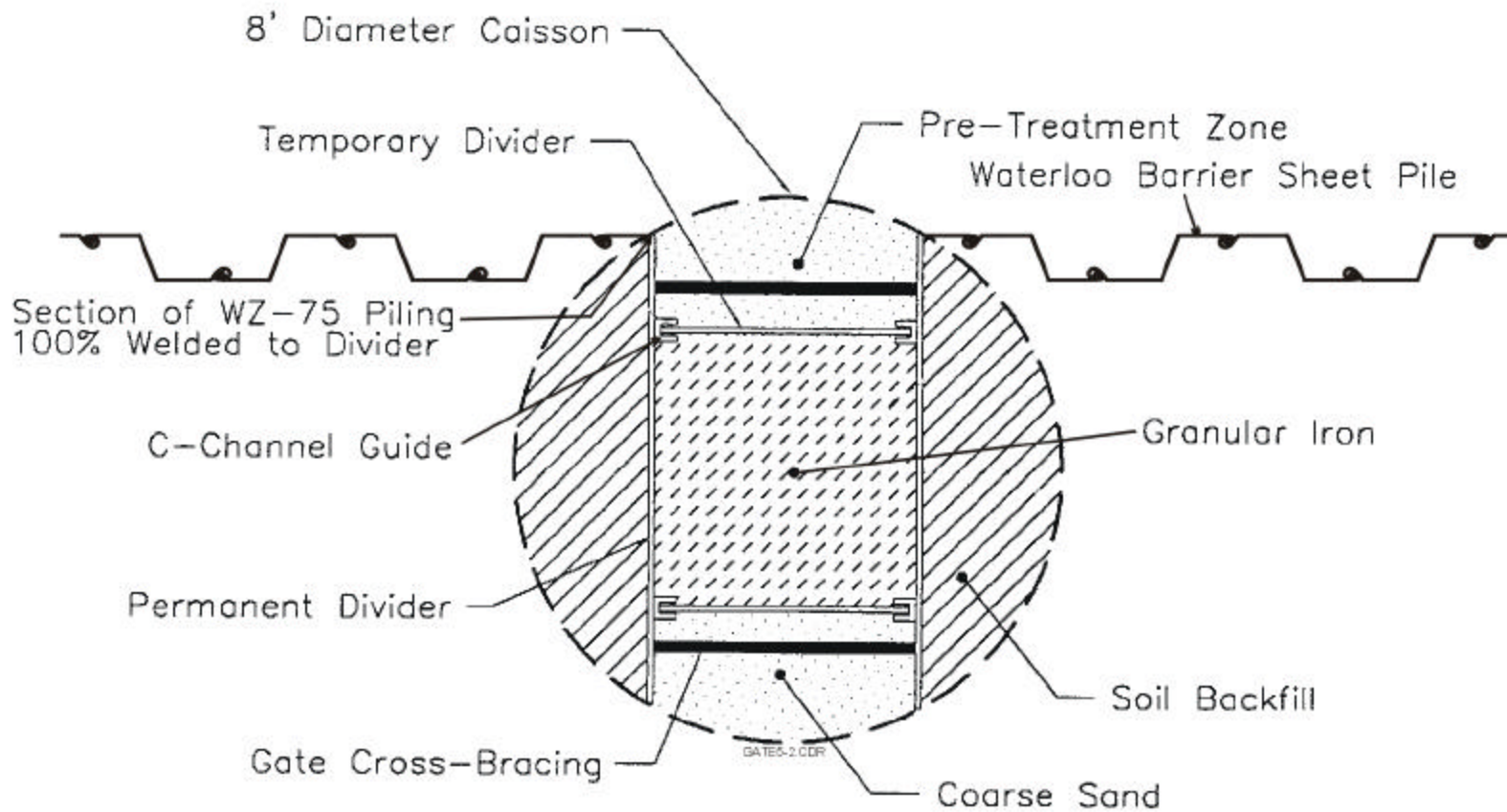

Figure 7-5. Plan View of a Caisson Gate

overhead hopper into the trailing end of the excavated trench. The hopper contains two compartments, one of which can install media up to gravel-size. The other compartment is capable of simultaneously unrolling a continuous sheet of HDPE liner if desired.

The trencher can excavate in a water-filled trench without having to dewater or install sheet piles to temporarily stabilize the trench walls. Because the boom is positioned almost vertically during excavation, a trench slope is not created and greatly minimizes the amount of generated trench spoils. One other advantage is a fast production rate. At the Elizabeth City, NC site, a reactive cell 150 ft long, 2 ft wide, and 26 ft deep was installed in one day (Schmithorst, 1996). Also, a trencher is ideal for working at sites with constrained working space, and it minimizes soil disturbance to allow for work in sensitive areas. Drawbacks include a shallow depth capability and problems with excavating wet, very unconsolidated materials, which may cause difficulties in bringing trench spoils to the surface. Obstructions such as large cobbles and boulders also can disrupt the sawing process. Quoted costs for this technique are between \$5 and \$12/ft² for construction, not including mobilization or reactive medium costs.

7.1.5 Use of a Biodegradable Slurry for Stabilizing a Trench

One variation to the conventional excavation techniques that appears promising for trench-type reactive cell construction is the use of a biodegradable slurry (Owaidat, 1996; Day et al., 1999). This technique was used to install a PRB at ORNL, TN in 1997. A biodegradable slurry, generally made of powdered guar bean, is introduced into the trench as it is excavated (Figure 7-7). The pressure of the slurry helps to retain the walls of the excavation. Granular iron is introduced into the trench through a tremie tube or by displacement over a gradually sloping side wall. The guar gum later biodegrades, leaving the iron behind. One advantage of this method is that no personnel are required to enter the excavation. Also, the continuity or settling of the iron in the trench is expected to be more uniform than in a conventional open trench installation.

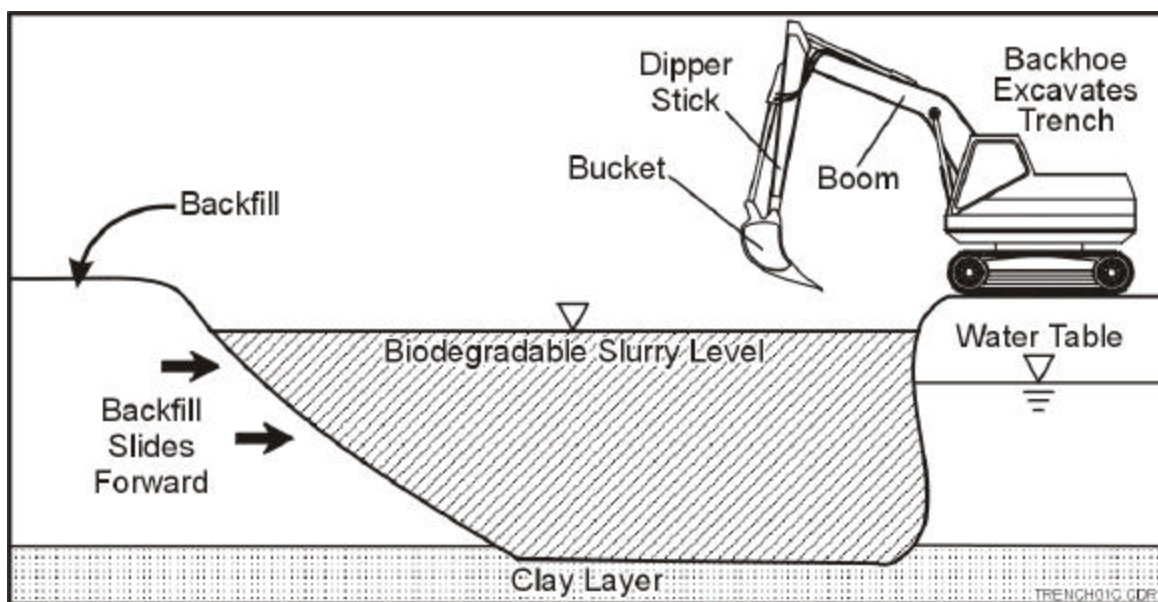

Figure 7-7. Use of a Biodegradable Slurry for Reactive Media Installation

7.1.6 Excavation with a Hollow-Stem Auger

In this method, a hollow-stem auger or a row of hollow-stem augers is used to drill holes up to 30 inches in diameter into the ground. When the desired PRB depth is reached, reactive medium is introduced through the stem as the auger is withdrawn. Alternately, the reactive medium can be mixed with a biodegradable slurry and pumped through the hollow stem. By drilling a series of overlapping holes, a continuous PRB can be installed. This method has been used to construct a 74-ft-wide PRB at a dry-cleaning site in Germany (ETI, 1999).

7.2 Direct Installation of Reactive Media Using Innovative Techniques

The construction methods discussed in Section 7.1 all involve the excavation of a trench to house the reactive medium. The economics of excavation methods are strongly correlated with the depth of the PRB installation: the deeper the excavation, the more costly the effort becomes. Innovative methods that introduce the reactive medium directly into the ground without first excavating a trench are being tested at some sites.

7.2.1 Hydraulic Fracturing

One promising technology for construction of deeper barriers is hydraulic fracturing, a technique that is currently being tested at a site in Cape Cod, MA. First, a series of wells is installed along the length of the proposed barrier. A controlled vertical fracture is initiated through the well with a special downhole tool inserted in each well (Hocking et al., 1998). The fracture can be oriented along the required azimuth and depth. The tool is withdrawn and a packer is installed in each well. An iron-gel mixture then is injected through the series of wells to form a reactive barrier. The propagated geometry of the fractures is monitored in real time to ensure that coalescence or overlap of the fractures takes place as desired. Monitoring is done by introducing electrical energy in the fractures and monitoring it through downhole resistivity sensors.

The gel used is a water-based cross-linked gel. Hydroxypropylguar, a polymer used in the food processing industry as a thickener, typically is used for this application. The viscosity of the cross-linked gel ensures that the granular iron remains suspended during mixing, handling, and subsequent pumping. When the gel degrades, a 3- to 4-inch thick reactive barrier is left behind in sandy soils. Some variability in barrier thickness can be expected if the advancing fracture encounters heterogeneities such as cobbles or consolidated sediments. To some extent this variability can be addressed in the design by injecting a slurry that provides a barrier thickness greater than the minimum required for treatment. Until more field experience is obtained with this technique, at least two parallel fracture reactive barriers may be considered (Hubble et al., 1997).

This technique also may be used for installation of an impermeable barrier (funnel) by injecting a soil-bentonite slurry instead of an iron-gel mixture.

7.2.2 Vibrating Beam

In this technique, an H-beam or mandrel with a sacrificial shoe at the bottom is used. The beam is driven into the ground with a vibratory hammer to create a void space. As the beam is raised, grout is injected into the void space through special nozzles at the bottom of the beam. An impermeable barrier is thus installed by driving at overlapping intervals.

This technique was tested at Cape Canaveral Air Station, FL to investigate its use for installing a PRB (Marchand et al., 1998). In the first test, dry iron was installed in the void space through a hollow mandrel driven with a vibratory hammer. The mandrel was used to create a 45-ft-deep, 4-inch-thick, 32-inch-long void space with each entry. A total of 32 overlapping panels were installed, and no spoils were generated. In the second test, a 36-inch I-beam with a high/low pressure nozzle was driven into the ground. Water was sprayed through the high pressure side of the nozzle to help create the void space. An iron-guar gum slurry was introduced into the void space through the low-pressure side of the nozzle as the beam was brought up. During the installation of 24 panels, approximately 24 tons of soil and 4,000 gallons of liquid were generated.

The vibrating beam technique also was used at a private site in Tifton, GA to install a 400-ft-wide funnel-and-gate system.

7.2.3 Jetting

Jet grouting has been used for infrastructure development in Japan and Europe since the 1970s. The technique is being increasingly used in the United States to reduce the permeability of soils for infrastructure development and to place impermeable barriers for remediation. More recently, there has been some interest in substituting the grout with an iron-guar gum slurry to install a PRB at deeper sites. This technique was field tested in a clean site at Dover AFB, DE (Landis, 1998) and in a contaminated site at Travis AFB, CA.

Jet grouting involves the injection of grout at high pressures into the ground. The high velocity jet erodes the soil and replaces some or all of it with grout. Jet grouting systems are classified into three types depending on the delivery mechanism. In a single-rod system, the fluid injected is grout. In a double-rod system, grout and compressed air are injected. The combined effect of the high-pressure grout and air results in a greater percentage of soil being removed and replaced with grout, and the remaining soil-grout mixture is called soilcrete. In a triple-rod system, grout, air, and water are jetted. This triple combination enables an even higher percentage of soil to be removed, and the system can be used for almost complete replacement of the soil with grout. The triple-rod system offers better control over injection rates and results in better quality of soilcrete. Although the single- and double-rod systems can be used in loose sandy soils, the triple-rod system can be used in most types of soil.

If the injection rod is rotated as it is brought up, a column of soilcrete can be installed. A continuous impermeable barrier can be created by installing a row, or multiple rows, of overlapping columns. Alternately, a thin panel of soilcrete can be installed by not rotating the rod. A continuous barrier, sometimes referred to as a thin diaphragm wall, is formed by installing a row of overlapping panels.

It is the triple rod system that is projected as being suitable for installing PRBs. Grout can be used to install impermeable sections or funnel. A slurry made of granular iron and guar gum is used to install the reactive section.

7.2.4 Injection with a Mandrel

In this method, a hollow steel shaft, or mandrel, is used to create a vertical void space in the ground for the purpose of emplacing reactive media. A sacrificial drive shoe is placed over the

bottom end of the mandrel prior to being hammered down through the subsurface using a vibratory hammer. Once the void space is created, it then can be filled with a reactive medium in one of two ways. One method uses a tremie tube to simply pour the media loosely down the hole. After a desired depth is reached, the mandrel is extracted, leaving the drive shoe and media. Another way to complete the cell is to install wick drains, geomembranes, or geofabrics in conjunction with reactive media. A 4-inch-thick test barrier with granular iron was installed using a mandrel at Cape Canaveral Air Station, FL (Marchand et al., 1998). The objective of this test was to investigate the injectability of the iron. The ability of the barrier to achieve a reactive cell thickness and continuity that would achieve cleanup targets was not investigated.

Some disadvantages to this technique include the limited size of the reactive cell, which is controlled by the size of the mandrel (typically 2 inches by 5 inches). Therefore, a series of mandrel-installed voids would constitute a reactive cell rather than a single insertion. Because the mandrel is hammered down using a vibratory hammer, it is possible that subsurface obstructions during installation could cause the mandrel to deviate from an intended vertical path. Also, compaction can occur around the individual voids as the mandrel is driven down, thereby lowering the permeability of the soil.

Mandrel-based construction does have some advantages. It is inexpensive (\$7/ft² including labor and equipment for 45 ft of depth), and no spoils are generated, which minimizes hazardous waste exposure and disposal. Also, reactive media of up to 1-inch particle diameter can potentially be installed.

7.2.5 Deep Soil Mixing

In deep soil mixing, two or three special augers equipped with mixing paddles are lined up in series. These augers penetrate the ground and mix up soil as they rotate (Figure 7-8), and a bentonite slurry is injected simultaneously through a hollow drill stem as the augers retreat back to the surface. An impermeable wall is formed by successive overlapping penetrations made with the deep soil mixer, resulting in a series of hardened soilcrete columns. Typically, 40 to 60% of each soilcrete column is composed of grout.

Depths of up to 120 ft can be obtained using this method, and permeabilities approaching 1×10^{-7} centimeters/second are attainable. This method generally is employed in situations where excavation of contaminated soils is not feasible because only a minimal amount of spoils are brought to the surface. It is best used in soft soils, yet special attention should be given so that injection does not cause hydrofracturing of the soil, which can easily occur in soft soils. Generally, deep soil mixing is less expensive than jet grouting and has a higher production rate. The same technique that has been used to create an impermeable wall has been proposed for use in reactive medium installation.

Although it has never been done commercially, it may be possible to use deep soil mixing to inject a reactive medium for the purpose of creating a reactive cell. However, because deep soil mixing does not completely replace soil with the reactive medium but rather mixes them together, only about 40 to 60% of the reactive medium is present in a completed column. Increased permeability occurs as the soil mixing process fluffs up the soil matrix, yet with time, compaction due to overburdening reduces it (Burke, 1996). The injected reactant could be

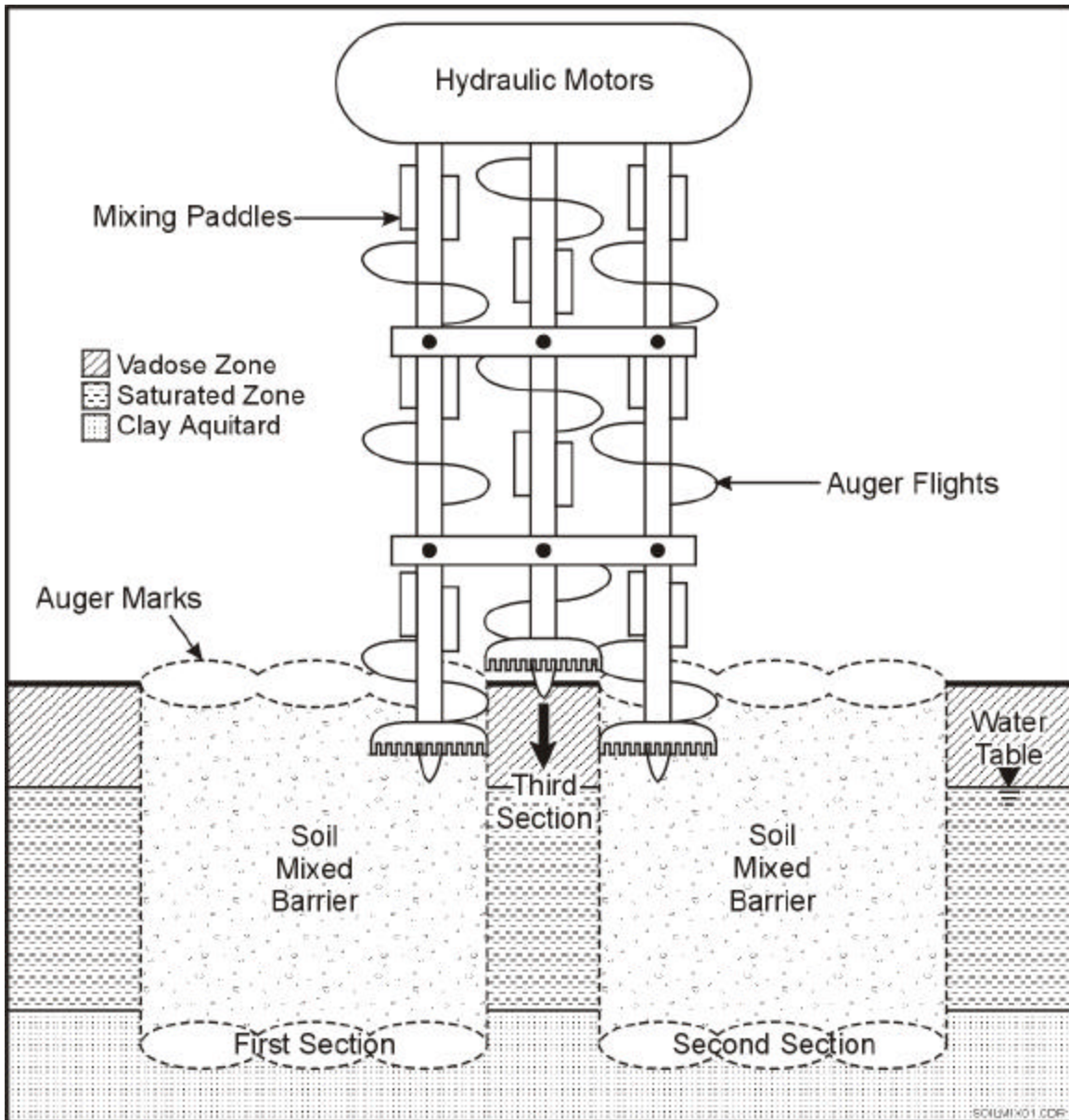

Figure 7-8. Deep Soil Mixing

equivalent to fine sand-sized particles, but would have to be suspended in a revert (biodegradable slurry) to be injected. Because the slurry is injected using piston-driven cylinder pumps, several factors should be considered when deciding on the reactant particle size. The abrasiveness of the reactant can cause considerable wear and tear on the pumps, which can increase O&M costs significantly. Also, the reactant needs to be in suspension if it is to be injected in an efficient manner.

7.3 Construction Methods for the Funnel

The design of some reactive cells may include flanking impermeable walls to aid in directing or funneling groundwater flow toward the permeable gate. The two most popular types of subsurface barriers are the steel sheet pile cutoff wall and the slurry trench cutoff wall. These subsurface

cutoffs are either keyed in a confining layer to prevent downward groundwater migration or, less commonly, installed as a hanging wall to contain floating contaminants.

7.3.1 Sheet Piles

Barriers made of a series of steel sheet piles driven into the ground have been used in the construction industry for retaining soil (Figure 7-9). To adapt this technique for remediation applications, where both soil and water movement must be restricted, the University of Waterloo, Ontario has patented a technique for sealing adjoining sheet piles by pouring grout into the joints. Figure 7-10 shows cross sections of a sealable-joint sheet pile barrier. Sheet pile barrier integrity can be maintained to depths of about 50 ft. Beyond this depth, the sheet piles can be driven in, but it is unclear how well the integrity of the sealed joints is maintained. Sheet piles that are about 40 to 45 ft long can be easily transported to the site. Beyond this length, sheet piles must be transported in sections to the site, and then welded together during installation.



Figure 7-9. Sheet Piles Installed Using a Vibrating Hammer

Sheet pile barriers can be installed relatively quickly at most sites. They are especially useful when the barrier must be installed under horizontal space limitations. Because sheet piles are relatively thin and can be driven straight down, this type of barrier was used at the Dover AFB site for the funnel sections because the funnel walls lay in close proximity to subsurface utility lines and a nearby road that needed to stay open during construction. In fact, one of the utility lines was cut and rejoined over the sheet pile wall after the barrier was completed. A 100-ft

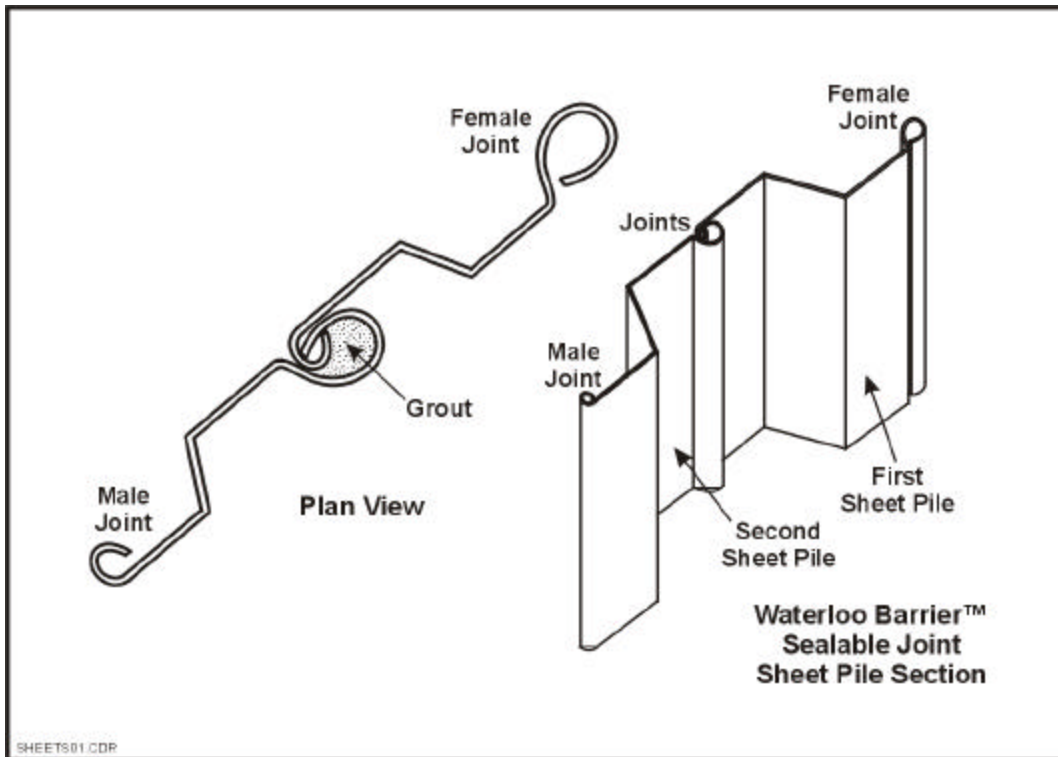

Figure 7-10. Cross Section of Sealable-Joint Sheet Piles (from Smith et al., 1995)

crane with a vibratory hammer was used to drive the sheet piles 45 ft into the ground with a 2-ft key in the aquitard. Another reason for choosing a sheet pile barrier instead of slurry wall at the Dover AFB site was because the sheet pile barrier generates much less spoils. Sheet piles also are useful as dividers when the reactive cell or gate has to be divided into sections to house different media. Sheet piles were used at the former NAS Moffett Field site to form the funnel for the barrier. For the former NAS Moffett Field PRB, sheet piles supported by cross bracing also were used to keep the trench (gate) open after excavation so that the iron medium could subsequently be emplaced.

Some uncertainties remain regarding the integrity of the joint as a sheet pile is being driven. A considerable amount of friction is produced during sheet pile installation and joint flanges could weaken or be damaged, especially if greater depths are desired (Breux, 1996). Also, the irregular shape of the individual sheet piles and the curved nature of the interlock could create some difficulties during installation. The spaces between corrugations in the sheet piles are not accessible with clamshell excavators, and this has resulted in construction personnel entering the trench to clear away these areas (Myller, 1996). The loose interlocks of connecting piles (prior to grouting) have made it difficult to drive piles in vertically without them pinching together.

As with conventional steel sheet piles, the sealable-joint sheet piles are limited to depths of 60 ft with confidence of maintaining sheet integrity and performance, but the sheets can be installed deeper. Rocky soils and consolidated/compacted sediments can damage sheet piles during installation and limit the types of geologic media through which the sheets can be safely driven.

Using sheet piles may be difficult in a funnel-and-gate system with caisson gates, although the difficulty of obtaining a proper seal between the funnel and reactive cell can be overcome through engineering modifications.

7.3.2 Slurry Walls

Slurry walls are the most common subsurface barrier used for diverting contaminated groundwater. Although slurry walls have been used in a variety of configurations, they are especially suited for installation as a funnel-and-gate system with caisson gates because of the ease with which the seal between the slurry wall and reactive cell can be achieved. They are constructed by first excavating a trench under a head of liquid slurry using either a backhoe or a clamshell, as described in Section 7.1. The slurry, which is usually a mixture of bentonite and water, helps maintain the integrity of the trench by forming a filter cake over the face of the wall. As a trench is excavated, it is quickly refilled with a mixture of cement-bentonite or a selected soil-bentonite backfill.

Careful planning is critical in the design of a slurry wall. Site-specific conditions will dictate which type of slurry wall is appropriate and which is most effective. Permeability, deformability, and performance are important factors that will determine the feasibility and performance life of a slurry cutoff wall. The more common slurry walls constructed are the soil-bentonite slurry wall and the cement-bentonite slurry wall. Another, but less common, type is the plastic concrete slurry wall. These and the composite barrier slurry wall are described in the following paragraphs:

- ❑ **Soil-Bentonite Slurry Wall.** Slurry walls comprised of a soil-bentonite mixture are by far the most commonly used cutoff walls for environmental applications. They are the least expensive to install, have very low permeabilities, and are chemically compatible for withstanding various dissolved-phase contaminants. The construction of the wall is fairly straightforward (Figure 7-11). The bentonite slurry is introduced into the trench as soon as excavation begins. Excavated backfill can be mixed with water and bentonite. Once the trench reaches the desired depth and a sufficient length has been excavated, mixed backfill is pushed back into the trench. It is important to ensure that the backfill is uniformly mixed and liquid enough to flow down the trench slope. The backfill should not flow past the trench slope where it could interfere with the ongoing excavation. However, if it does not flow enough, it can start to fold over and create pockets or void spaces of high permeability. It is necessary to have ample work space for adequate mixing of excavated backfill and the collection of unused trench spoils.
- ❑ **Cement-Bentonite Slurry Wall.** At field sites that have limited work space for mixing the excavated backfill, one option is a cement-bentonite slurry wall. Construction of the wall involves excavation of a trench under a head of slurry composed of water, bentonite, and cement. Instead of backfilling the trench with mixed soil, as in the case of a soil-bentonite wall, the slurry is left to harden and form a wall with the consistency of a stiff clay. The use of cement-bentonite slurry walls in environmental applications is limited for various reasons. First, these walls are more expensive to install than other slurry walls because a large amount of cement is needed to fill the trench. Also, because the excavated soil is not used as backfill, the wall will

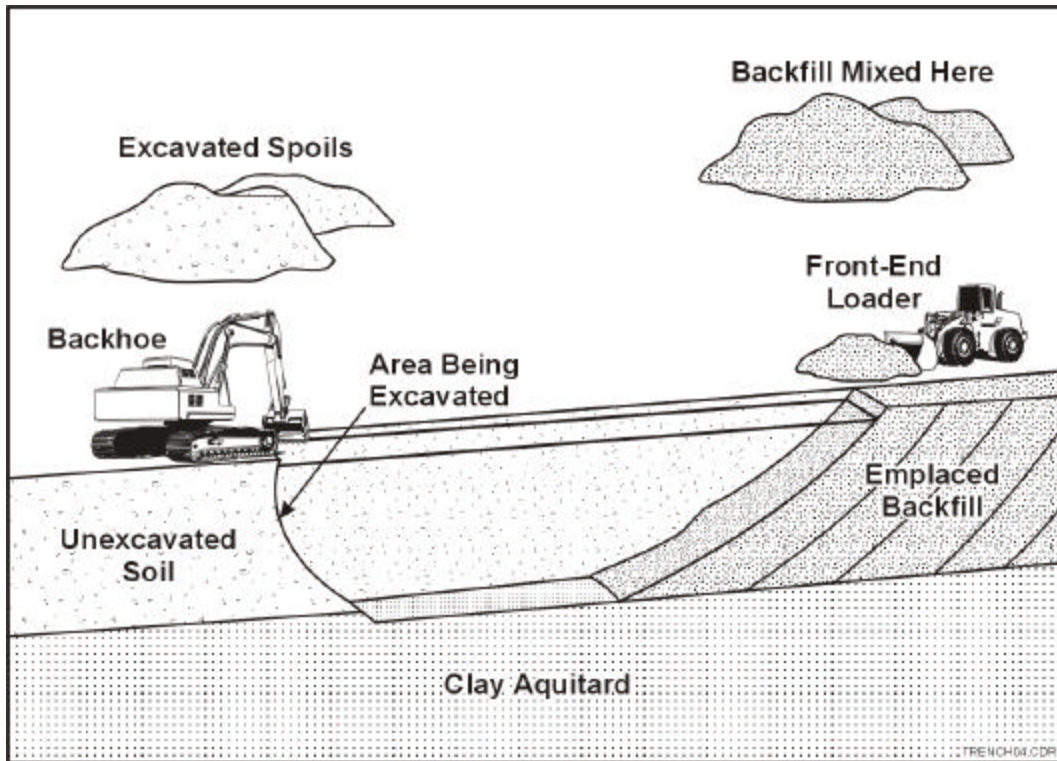

Figure 7-11. Cross Section of a Soil-Bentonite Slurry Trench, Showing Excavation and Backfilling Operations

need to be disposed of at additional cost. Moreover, because the cement-bentonite slurry wall does not contain many solids, the wall is composed mostly of water and therefore has a higher permeability and is more prone to permeation by contaminants. Advantages of the cement-bentonite slurry wall include greater strength and the ability to be installed in areas with extreme topography.

- ❑ **Plastic Concrete Slurry Wall.** The plastic concrete slurry wall is composed of a mixture of water, bentonite, cement, and aggregate that hardens to form a wall which has significantly greater shear strength yet remains flexible. The plastic concrete slurry wall is constructed in paneled sections that are individually excavated under a bentonite slurry. Once a panel is excavated, the plastic concrete is poured with a tremie pipe into the panel to replace the bentonite slurry and is left to harden. The plastic concrete slurry wall is used in applications where strength and deformability are desired. It has a relatively low permeability and, based on limited data, may be more resistant to permeation by contaminants.
- ❑ **Composite Barrier Slurry Wall.** This multiple-layer barrier offers three walls of defense, each with increasing chemical resistance and lower permeability. It is composed of an outer 1/8-inch-thick bentonite filter cake, a 1- to 2-ft-thick soil-bentonite, cement-bentonite, or plastic-concrete middle layer, and an inner 100-mil HDPE geomembrane. The HDPE has a permeability of 1×10^{-12} cm/sec. Installation of the

composite barrier starts with excavation of a trench under a bentonite and/or cement slurry. Because the slurry maintains trench wall stabilization, excavations greater than 100 ft are possible; however, the difficulty of emplacing the HDPE liner to those depths and the high cost of deep construction has resulted in restricting the use of HDPE to 50 ft depths (Cavalli, 1992). The geomembrane envelope then is installed vertically in sections into the slurry trench by either mounting it onto a detachable and removable frame, pulling it down using weights affixed to the membrane bottom, or “driving” it down using a pile driver. Once the HDPE is in place, the trench can be backfilled on either side of the membrane. The inside of the geomembrane then can be filled with a drainage system in which sampling points can be installed to monitor the performance of the system. Advantages of the composite barrier include a very low permeability, high resistance to degradation, option to install a monitoring system within the membrane, and ability to isolate and repair sections of the wall without removing the entire membrane envelope.

7.3.3 Innovative Construction Methods for PRBs

In addition to the construction techniques that have been used at PRB sites in the past, several techniques have been used in other geotechnical applications and may merit serious consideration for PRBs. Types of innovative construction techniques discussed include jetting, installed hydraulic fracturing, and deep soil mixing (these techniques have been described in Section 7.2 for direct installation of reactive medium in the ground). Because excavation equipment is not involved, these innovative techniques have considerable potential to minimize health and safety issues. However, because these techniques involve specialized equipment, they can be more expensive to operate and maintain than conventional techniques.

7.4 Other Innovative PRB Configurations and Construction Approaches

At some sites, unique PRBs have been designed that are significantly different from typical continuous reactive barrier (reactive cell only) or funnel-and-gate configurations. Some of these innovative PRB configurations are discussed in this section.

At the Rocky Flats Environmental Technology site in Golden, CO owned by DOE, a unique PRB design was used that is akin to a seep collection and treatment system (Rocky Mountain Remediation Services, 1999). The barrier consists of a 230-ft-long, single-membrane HDPE impermeable funnel, an upgradient collection trench (porous media and sump), and two treatment cells downgradient of the HDPE barrier. The 230-ft-long impermeable section is keyed into bedrock that occurs at depths ranging from 10 to 16 ft. Groundwater that collects in the sump is piped to the treatment cells. Both treatment cells contain iron as the reactive medium. Treated water is discharged back to the water table through a French drain on the downgradient side of the treatment cells. The French drain has an overflow line that discharges directly to surface water. This whole process is achieved passively. The Rocky Flats barrier is designed to capture the entire plume and is located within the boundaries of the plume. An excavator was used to create the collection trench. The trench and HDPE barrier are keyed into the bedrock.

CVOCs are destroyed by the iron in the treatment cells, whereas the radionuclides are reduced and deposit on the iron surfaces. The treatment cells are designed to provide easy access so that

the reactive medium can be changed periodically. The cells are plumbed so that a water blanket remains above the level of the iron at all times. The water enters from the top and is discharged at the bottom of the cell. Cleanup targets for the CVOCs are based on MCLs. In the most recently reported monitoring round (March 1999), the barrier met all cleanup targets. The barrier appears to be satisfactorily capturing the targeted plume.

Another PRB configuration that is being considered at several DOE sites is the use of replaceable reactive cells. Because PRBs at many DOE sites tend to be designed for remediation of radionuclide- or metal-type contaminants, the reactive medium cannot be permanently left in the ground, as with PRBs for organic contaminants (Korte, 1999). Even after the plume is dissipated, metals sequestered in the reactive medium could re-dissolve in the groundwater flow. Therefore, the reactive medium at these sites must be removed and disposed of at some point. At Y-12 Plant, Oak Ridge Reservation, TN for example, DOE has installed a specially-designed treatment vault to house the reactive medium (granular iron), which makes it easier to retrieve and, if required, replace the reactive medium. The contaminants at this site include uranium and nitrate.

A semipassive variation to a PRB is the GeoSiphon™/GeoFlow™ cell, a system developed by WSRC under a DOE EM-40-funded project (WSRC, 1999). WSRC has filed a patent application for this semipassive technique. In this variation of the PRB, significant natural head differences between two points at a site are used to induce higher flowrates through aboveground or underground reactive media or treatment systems. A siphon, open channel, or pressure flow is used to transport the water from one point to another. The reactive medium or treatment system can be placed at the inlet or outlet of the siphon or pipe, and also can be located aboveground or underground. Two such cells have been demonstrated, one for the treatment of a TCE plume and the other for the treatment of metals (iron, aluminum, nickel, and chromium). Granular iron was used as the reactive medium for TCE, and a combination of limestone, peroxides, and other bases was used as the reactive medium for the metals.

7.5 Construction Quality Control

The effectiveness and long-term performance of permeable and/or impermeable sections of a PRB depends on the level of construction quality control (CQC) that is implemented. For the permeable section (gate or continuous reactive barrier) of a PRB, the CQC issues relate to ensuring that the installed reactive cell provides the designed reactivity and hydraulic performance (porosity and permeability). Construction-related factors may cause the actual performance of the reactive cell to deviate from the design performance and should therefore be guarded against, and include the following:

- ❑ Low-permeability silt and clay materials may smear across the influent or effluent face of the reactive cell. Smearing is especially possible when the aquifer is composed of heterogeneous stratigraphic layers that smear during construction activities, such as backhoe or clamshell excavation, sheet pile driving, vibrating beam movement, and caisson driving.
- ❑ The soil matrix may densify where structural sections are driven into the ground. For example, during the driving of sheet piles, caissons, or vibrating beams, the soil

material that is pushed aside may pack more densely in the immediately adjoining slice of aquifer. Smearing or densification may reduce the overall permeability of the reactive cell, even though the reactive medium inside may be highly permeable. Generally, the probability of smearing or densification is lower in relatively homogeneous sandy aquifers, and the surrounding soil and reactive medium often collapses into the space left by the structural section (e.g., sheet pile, vibrating beam, or caisson) when it is pulled out of the ground across the influent and effluent faces of the reactive cell. Reactive medium placement techniques that do not require excavation, such as deep soil mixing, also may have the potential to create densification.

- Construction fluids or sealants may enter into the reactive cell or aquifer. For example, the grout used to seal the joints between sheet piles may seep into the surrounding aquifer or reactive cell. One CQC measure that can be taken to prevent this seepage is to keep an inventory of the grout poured into each joint and compare the volume of the grout to the volume of the joint. A measure taken at Dover AFB to prevent excessive seepage of grout into the aquifer was to inspect each joint (with a fiber optic camera) to ensure that adjoining sheet piles were aligned well before grouting. The deeper the aquifer, the greater the possibility of misalignment of sheet piles. Similar precautions should be taken during fluid injection with techniques such as jetting.
- Discontinuities in the reactive cell may occur, especially with innovative construction techniques such as jetting or hydraulic fracturing. Discontinuities may cause part of the flow to emerge untreated through the reactive cell. Adequate inspection procedures should be identified and implemented when reactive cell construction techniques are used that do not involve complete excavation and replacement of the aquifer soil with reactive medium. When funnel-and-gate configurations are used, care must be taken that the funnel materials, such as bentonite or cement, do not enter the reactive cell. Permanent dividers (such as structural steel plates) generally are installed between the funnel-and-gate sections to separate the two. Permanent dividers between funnel-and-gate sections or between the lateral edges of a continuous reactive barrier and the aquifer also prevent short-circuiting of flow through the sides of the reactive cell.
- Uneven placement of the reactive medium in the reactive cell may become an issue, even when conventional excavation and refilling techniques are used. If the reactive cell is more than 10 ft deep, it may be desirable to tremie the reactive medium into the excavation, rather than suspend bags of reactive medium above ground and release the reactive medium in an open stream into the excavation. An inordinate amount and distribution of void space in the reactive cell may lead to excessive channeling of flow and exhaustion of the reactivity of the medium along these preferential paths, while leaving the bulk of the medium unused. When using innovative techniques that do not involve excavation of the native soil, such as jetting or deep soil mixing, ensuring an even distribution of reactive medium is even more challenging.

There may not be any foolproof way to completely avoid these construction risks. However, with appropriate tracking and inspection procedures, their occurrence can be minimized and/or

recorded for future interpretation of PRB monitoring results. Post-construction monitoring can be conducted to verify reactive cell continuity by measuring field parameters indicative of medium reactivity. For example, lower ORP and DO and higher pH measured spatially along various flowpaths through the reactive cell may be indicative of continuity. For such measurements to be meaningful, flow through the PRB should have stabilized, a point that may not be reached for several weeks or months, and by that point the construction equipment will have been demobilized. Therefore, preconstruction planning and careful implementation are the best way of avoiding/minimizing construction deficiencies. When PRBs include impermeable sections (funnels), the following construction-related factors need to be guarded against, tracked, and recorded:

- ❑ Discontinuities may occur at joints in the impermeable barrier. For example, unless careful inspection of each and every joint is conducted, the joints between sheet piles may turn out to be misaligned, especially at greater depths. Discontinuities may occur in a slurry wall if the backfill is not well mixed. Ensuring that there are no discontinuities may be particularly difficult when impermeable barriers are installed with innovative construction techniques, such as jet grouting or deep soil mixing, where considerable care has to be taken to ensure that adjoining injected/mixed sections intersect at all depths.
- ❑ Improper seals between the funnel-and-gate sections may occur, leading to leakage at points where the funnel meets the reactive cell. Special joints may have to be installed between the funnel-and-gate sections.

Minor leakage through impermeable sections may be difficult to detect, unless target contaminants start showing up on the downgradient side of the funnel. However, even this is not a firm indicator, as groundwater (and contaminants) flowing around the edge of the funnel may flow close to the funnel along the downgradient side. Measuring water levels immediately upgradient and downgradient of the funnel may be a possible way to verify funnel continuity after flow stabilizes.

7.6 Health and Safety Issues

The success of any construction application can be attributed to having prior knowledge of any foreseeable hazards and taking careful steps to avoid them through the implementation of safety practices under the guidelines outlined by the Occupational Safety and Health Administration (OSHA). A formal health and safety plan structured to address potential site-specific hazards will be required prior to commencement of construction activities. The following are several health and safety issues that must be considered:

- ❑ Confined space entry
- ❑ Knowledge of location of existing utilities, including overhead or buried power lines, sewer lines, phone lines, and water pipes
- ❑ Types and concentrations of contaminants involved, which will dictate the type and level of personal protective equipment (PPE) required

- ❑ Use of heavy excavating equipment, which will require the use of a hard hat, steel-toed boots, safety glasses, gloves, and hearing protection
- ❑ Trench entry, which may be necessary for visual inspection of important CQC issues (for example, it may be necessary to check that the excavation is keyed into a confining layer correctly). Trench entry also may be required if buried utilities hinder use of mechanical excavation equipment. Trench entry also may be required to clear out the spaces inside the corrugations of sheet piles that are not reachable by clamshell excavators.

7.7 Waste Minimization

Exposure to contaminated trench spoils is likely to occur during the construction of a subsurface barrier. The generation of hazardous or nonhazardous waste can be minimized through careful selection of a construction technique that involves either no generation of contaminated spoils or generation of only minimal amounts. Sometimes design factors will dictate that a barrier be constructed in uncontaminated soil located downgradient from a contaminant plume, thereby eliminating the problem of dealing with hazardous waste. The opposite scenario also could occur, requiring excavation of soils within a contaminant plume. In any event, the amount of trenching and disposal of spoils should be planned for when selecting an appropriate construction technique.

8.0 Monitoring the Performance of a PRB

Once the PRB has been designed and constructed, the system must be monitored as long as the plume exists. The primary objective of contaminant monitoring is to verify that the groundwater quality downgradient of the PRB is in compliance with the target cleanup objectives agreed to by site managers and regulators. In other words, monitoring seeks to establish that the plume is being adequately captured and treated. Monitoring is accomplished through groundwater sampling and analysis for target contaminants. The type and frequency of monitoring required to achieve this objective usually are decided during discussions between the site manager and the regulators. Most site managers conduct contaminant monitoring on a quarterly schedule in keeping with general sitewide monitoring.

A secondary objective of monitoring is to determine whether the operating performance of the PRB is consistent with the design objectives. Two types of monitoring usually are required: *contaminant* monitoring seeks to verify the current operating status of the PRB, and *performance* monitoring seeks to evaluate whether the desired hydraulic and geochemical conditions are being created by the PRB to enable good performance currently and in the future. Performance monitoring is conducted to some degree at most sites because it can forewarn site managers of any problems that may occur in the future, before the problems are identified by contaminant monitoring (that is, before plume breakthrough or bypass actually occurs). Potential performance problems that could be identified after PRB construction include the following:

- ❑ Hydraulic flow conditions in the PRB and its vicinity are different from those predicted by site characterization, modeling, and design. These conditions could lead to inadequate plume capture or inadequate residence time in the reactive cell.
- ❑ Geochemical conditions developing in the reactive cell are not suitable for current or continued good performance of the PRB.

Performance monitoring generally involves measurement of water levels, field parameters (ORP, pH, DO, and conductivity), and inorganic constituents in the groundwater monitoring wells in the PRB and its vicinity. Water levels and field parameters are simple measurements to perform and most site managers conduct these on a quarterly basis, along with groundwater sampling for contaminants. Quarterly monitoring also indicates any seasonal changes in contaminant distribution, groundwater flow, or geochemistry. Certain inorganic constituents can contribute to the formation of chemical or biological byproducts, which may take place over several years (or several pore volumes of flow). Therefore, groundwater sampling for inorganic parameters is generally conducted on an annual or biannual schedule.

Other specialized hydraulic and geochemical measurements, such as direct hydraulic measurements with in situ probes, tracer tests for flow and residence time verification, and collection and analysis of core samples from the field reactive cell, have been conducted at some sites during the development of the PRB technology. However, at most sites these specialized measurements

may be needed only if routine or compliance monitoring indicates that the PRB is not performing as designed.

This section describes both contaminant monitoring and hydraulic and geochemical performance monitoring techniques. It is important to note that the successful use of post-construction monitoring data depends on the collection of detailed site characterization information in the vicinity of the PRB during the preconstruction (design) stage. Preconstruction contaminant, hydraulic, and geochemical characteristics of the site form the baseline for evaluation of PRB-induced changes in the affected aquifer.

8.1 Contaminant Monitoring Strategy

After installation of the PRB is complete, the site manager and regulators will need to know if the plume is being adequately captured and treated. From a compliance perspective, the monitoring is done to ensure that downgradient concentrations of the target contaminant (and any target byproduct) are below target cleanup levels. Contaminant monitoring involves watching for:

- ❑ Potential breakthrough of contaminants or environmentally deleterious byproducts through the reactive cell
- ❑ Potential contaminant bypass around, over, or beneath the barrier
- ❑ Potentially deleterious effects on groundwater quality due to the reactive medium itself.

A monitoring plan containing monitoring locations, frequencies, and parameters must be developed and agreed on by the site managers and regulators. Appropriate QA procedures should be followed in developing and implementing this plan to ensure that valid data are collected and analyzed.

8.1.1 Monitoring Locations and Frequencies

The monitoring locations and frequencies required for contaminant monitoring are likely to be very site-specific, although the ITRC's PRB Subgroup has recommended general guidelines for PRB monitoring (ITRC, 1997 and 1999). Figure 8-1 shows examples of monitoring well configurations that could be used, depending on site conditions, to monitor for breakthrough and/or bypass of contaminants.

In the Figure 8-1c and 8-1e configurations, monitoring is done in the downgradient aquifer using a row of long-screened wells. If the CVOC distribution in the aquifer is relatively homogeneous by depth or if the aquifer is relatively thin, long-screen wells are sufficient to monitor breakthrough and/or bypass. If the contaminant distribution in the plume is relatively heterogeneous with respect to depth, well clusters may be used instead of long-screen wells. Each well in a cluster is screened at a discrete depth interval of the aquifer and, together, the wells in the cluster provide a representative profile of the vertical distribution. However, the presence of elevated levels of target contaminants in the downgradient wells may make it difficult to differentiate between breakthrough and bypass. This is because modeling indicates that re-mixing of

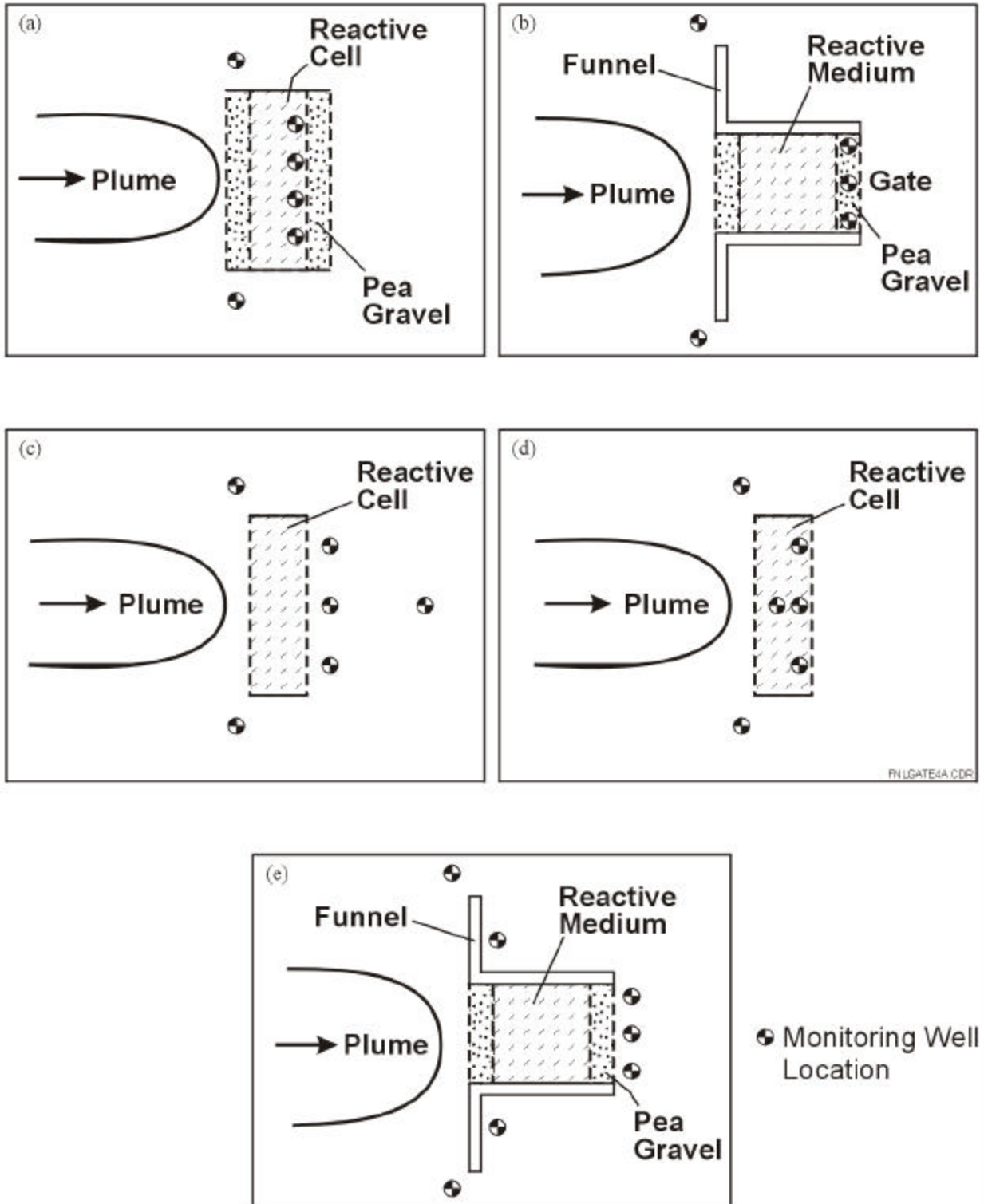

Figure 8-1. Various Monitoring Well Configurations for Contaminant Monitoring at a PRB

groundwater flowing through and around the PRB takes place very close to the downgradient edge of the PRB.

In the Figure 8-1a and 8-1d configurations, additional monitoring wells are placed a few inches inside the reactive medium to differentiate between potential breakthrough and bypass. If the PRB is located inside the plume instead of at the leading edge of the plume, monitoring wells in the downgradient aquifer may continue to show elevated contaminant concentrations for a long time after PRB construction, while the downgradient plume dissipates. Placing the monitoring wells within the reactive medium also provides a level of safety: if contaminant breakthrough is observed in these wells, there is still some reactive medium positioned beyond the well that can treat the contaminants further before the groundwater exits the reactive cell. Additional monitoring wells are placed at the two ends of the barrier to monitor for contaminant bypass that could result from inadequate flow capture. If there is potential for flow bypass beneath or around the barrier, this arrangement could provide more information. Flow bypass beneath the barrier would occur if the barrier is not properly keyed into the aquitard or if the aquitard itself has fractures. Flow bypass around the barrier could take place if the actual hydraulic capture zone becomes smaller than designed or if the plume shape changes over time.

The downgradient aquifer wells shown in Figure 8-1c also could be used to verify that the reactive medium itself is not releasing any environmentally deleterious products and that native geochemical parameters are being restored. Because mixing and rebound of geochemical parameters back to aquifer values may take place gradually, downgradient monitoring wells could be placed at increasing distances from the barrier.

It is essential to include one or multiple wells for monitoring CVOCs on the upgradient side of the PRB as well. Upgradient wells can provide an early warning of potential plume breakthrough if, over time, the plume develops in such a way that influent concentrations exceed those planned for in the design.

If there is any uncertainty regarding the imperviousness of the funnel, either because of geotechnical difficulties during installation or because innovative construction methods were used, additional wells could be installed immediately downgradient from the funnel (see Figure 8-1e) to monitor for breakthrough.

The required frequency of compliance monitoring is determined during discussions with the regulators. Quarterly monitoring usually is required for target contaminants at many sites. In general, the monitoring frequency for PRB installations need not be very high. As described in Section 1.0, the reactive medium is consumed slowly, over a time-scale of years. Quarterly monitoring would provide sufficient warning of any impending breakthrough of target contaminants. Quarterly intervals also are suitable for monitoring any seasonal changes in groundwater flow conditions.

Because monitoring costs constitute the only annual operating cost of the barrier for several years after construction, site managers will wish to optimize both the number of monitoring wells sampled and the information gained. Adequate site characterization in the vicinity of the proposed PRB location, as well as hydrologic modeling, can assist both site managers and

regulators in determining the appropriate number and locations of monitoring wells to install at a given site.

Monitoring wells may be constructed using 1- or 2-inch-diameter PVC casing for most types of contaminants and most types of reactive media. The diameter of the monitoring wells is determined based on the space available in the reactive cell and on the size of the measuring instruments that will be inserted during monitoring. Monitoring wells in the reactive cell generally are installed prior to placing the granular medium in the excavation, and are supported by metal frames. Figure 8-2 shows monitoring wells being installed in two types of reactive cells. Figure 8-2a shows monitoring wells supported in a trench-type reactive cell in the PRB at former NAS Moffett Field. Figure 8-2b shows monitoring wells supported by a frame being installed in a caisson-based excavation for a PRB at Dover AFB. Monitoring wells in the aquifer are installed by routine well installation techniques.

8.1.2 Sampling and Analysis for Contaminants and Byproducts

The chemical parameters that are typically measured in the monitoring wells include concentrations of contaminants (e.g., TCE and PCE) and potential toxic byproducts (e.g., *cis*-1,2-DCE and VC). Sampling and analytical techniques for monitoring wells located in the aquifer are similar to those for site characterization described in Section 3.0. Groundwater sampling generally can be done with an appropriate length of Teflon™ tubing and a peristaltic pump. However, special precautions may be required while sampling monitoring wells located within the reactive cell or gate.

When collecting groundwater samples from the reactive cell or gate, traditional methods that involve purging several well-casing volumes of water prior to collection should be avoided, because such practices may capture water that represents a significantly lower residence time in the reactive cell. Rapid withdrawal of a water sample by any sampling method (e.g., bailer) may draw water quickly from the upgradient direction, and such water may have been incompletely treated by the reactive medium. Analyzing a mixture of water from locations partially outside of the monitoring well screen could suggest higher levels of the target analytes than actually exist.

The main precaution in obtaining a representative sample is to avoid creating a strong disturbance in the well, for example, by purging with a bailer or inserting a sampling tube repeatedly or too quickly. An alternative sampling method known as “micropurging” is expected to be more suitable for groundwater sampling in the PRB and its vicinity and yield representative water samples, and has been discussed by Kearl et al. (1994). This sampling method involves the removal of small volumes of groundwater from the well at low flowrates. Small volumes help ensure that water samples are representative of conditions near the well. Flowrates should be low so that sampling creates minimum disturbance to the groundwater within the reactive cell. In general, flowrates should be less than 1 L/min, and in some cases less than 100 mL/min, depending on the transmissivity of the medium (Powell and Puls, 1997). A conservative rule to follow is that drawdown of the water level in the well being sampled should not exceed 0.05 ft. Because annular sand packs are not typically employed in reactive media wells, purge volumes can be made quite low. For example, if discrete-level monitoring wells are used with 2-inch-inside-diameter casings and 1-ft screen sections, the volume in the screen section will be about 0.6 L. Standard practice calls for purging three times the volume of the screen section, which



(a)



(b)

Figure 8-2. Monitoring Wells Being Installed in (a) Trench-Type and (b) Caisson-Type Reactive Cells

would require the removal of slightly less than 2 L of water. Monitoring the purge water for field parameters (pH, ORP, and conductivity) usually is desirable to confirm when they become stable and thus indicate that the water in the well has become representative of the water in the surrounding matrix.

8.2 Hydraulic Performance Monitoring Strategy

The goals of hydraulic performance monitoring are to evaluate the upgradient hydraulic capture zone induced by the PRB and to estimate the residence time available to the groundwater contaminants in the reactive cell.

8.2.1 Evaluating Hydraulic Capture Zone of the PRB

The capture zone evaluation strategy seeks to determine (a) whether or not the PRB is capturing groundwater and (b) the width and/or orientation of the capture zone.

Construction-related reasons why a PRB may not capture *any* water potentially include the smearing of fine-grained aquifer or construction materials around the face of the reactive cell and/or the densification of solids around the reactive cell. Site-related reasons why a PRB may not capture any water include transient flow reversal, as might occur at a site subject to tidal influences. The reasons why a PRB may be capturing water but not be achieving the designed width and/or orientation of the capture zone include unanticipated seasonal changes in groundwater flow velocity and direction.

Field techniques for determining the capture zones are similar to those for hydrogeologic site characterization; however, there may be some differences in their implementation. Capture zones can be evaluated using conventional techniques such as water-level measurements and tracer testing, or by emerging techniques such as in situ velocity probes, the HydroTechnics probe, or the colloidal borescope. These options are similar to those used for hydrogeologic site characterization and have previously been discussed in Section 3.0. Only the aspects pertinent to performance monitoring are discussed below. The main challenge in capture zone determination is that these investigations must be conducted over a small area at most PRB sites. Groundwater modeling may be used to determine the optimal placement of monitoring wells or velocity probes.

8.2.1.1 Evaluating Hydraulic Capture Zone with Hydraulic Gradient Measurements

The most common and effective approach for capture zone delineation is the determination of groundwater flow directions by measuring water levels in the PRB and its vicinity. The capture zone can be estimated by preparing a water-level map and plotting flow lines along the gradients indicated by the map. This strategy requires that a network of wells or piezometers be installed upgradient of the PRB. The number and configuration of the wells depends on the site-specific conditions and monitoring objectives. For example, if the only objective is to confirm that the groundwater is flowing into the PRB, then a few wells placed directly upgradient of the reactive cell may be sufficient. However, if the objective is to determine the width of the capture zone or to perform a detailed delineation of the part of the plume entering the reactive cell, then an extensive monitoring network is needed. The first objective (confirming flow into a PRB) generally can be met successfully in the field. The second objective (determining capture zone width or

plume delineation) generally is very difficult to accomplish because the water-level differences (hydraulic gradients) between adjacent wells in the vicinity of the PRB are too small for statistically significant measurements. The simulated flow lines generated from PRB design modeling (see Figure 6-2) show that the flow lines start converging toward the reactive gate just a few feet upgradient of the PRB. Therefore, the monitoring efforts must be focused on this rather small transition zone if the flow divide and capture zone width need to be delineated. Over this small area, the measurement uncertainty is generally greater than the actual hydraulic gradient, which results in non-conclusive data. Determining capture zone width is further complicated at heterogeneous sites where the capture zone can be non-symmetrical. Precise surveying of the well elevations and careful and consistent water-level monitoring are of utmost importance in reducing uncertainties.

Despite the uncertainties, water-level monitoring is probably the most convenient and cost-effective method for demonstrating the capture zone of the PRBs, especially at sites with a sufficiently high hydraulic gradient. This is because the water levels can be monitored inexpensively and frequently in a large number of wells over a long period of time. The water-level maps and hydraulic gradients provide a more representative picture of the overall hydraulic conditions at the site than the in situ probes, which are more localized.

An example of using water-level measurements to estimate the capture zone for the PRB at Dover AFB is shown in Figure 8-3. This figure shows a network of 15 monitoring wells upgradient of one of the reactive gates and a water-level map for a single monitoring event. As shown here, a steep gradient toward the gate exists immediately upgradient of the gate. From this data, flow lines can be easily identified pointing toward the gate, which confirms that the groundwater is being captured by the PRB. However, upgradient of the funnel wall, the water levels in most wells are within 0.01 ft of each other and there is no clear flow divide. Therefore, it is almost impossible at this site to determine the location of the flow divide or the width of the capture zone, because the low aquifer hydraulic gradient at this site and the short distances between wells make the capture zone delineation difficult. Figure 8-4 shows the water levels and capture zones for the pilot-scale PRB at former NAS Moffett Field, a site with a higher hydraulic gradient than the Dover AFB PRB site. In this case, it was possible to show that the groundwater is flowing into the reactive gate and to determine the approximate location of the flow divide based on water-level measurements and flowpaths.

8.2.1.2 Evaluating Hydraulic Capture Zone with In Situ Groundwater Velocity Sensors

HydroTechnics probes (see Section 3.1) can be used for long-term continuous monitoring of groundwater flow velocity and direction. These probes are installed permanently in the aquifer media (see Figure 8-5). Therefore, one probe is needed for each location to be monitored. Compared to water-level maps, the probes provide an estimate of velocity only in the immediate vicinity of the probe. However, because the monitoring is continuous, the probes are ideal for evaluating short-term or seasonal variations in flow patterns. Again, if the only objective is to monitor for groundwater flow into the reactive gate, a single probe installed just upgradient of the gate may be sufficient. However, detailed delineation of the flow patterns in the vicinity of the PRB may require several probes. For observation of the flow divide upgradient of the funnel wall, two or more probes should be installed that straddle the expected zone of flow divide.

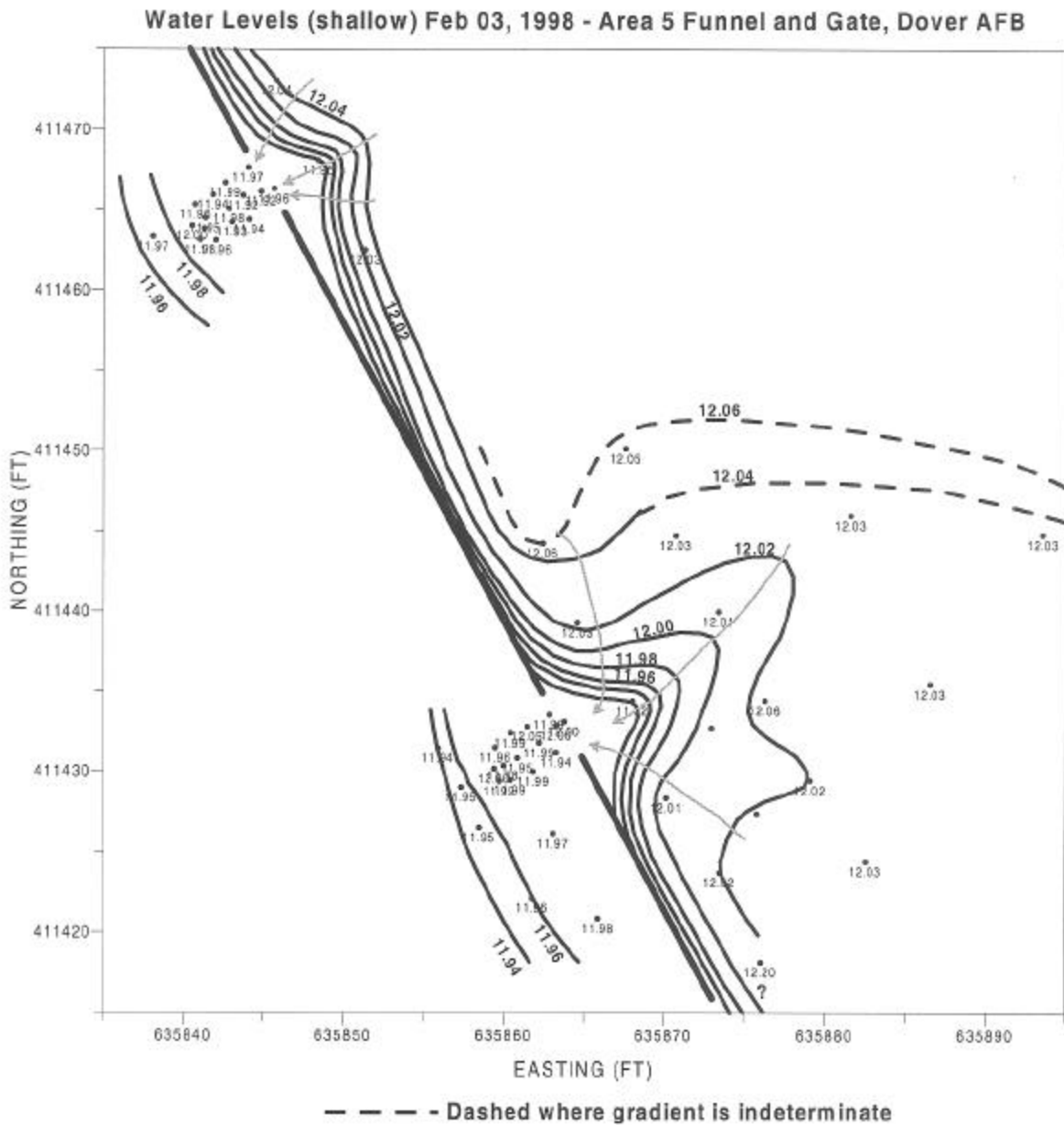

Figure 8-3. Water Levels and Capture Zone in Aquifer Near the PRB at Dover AFB (February 1998)

These probes should be placed as close as possible to the funnel walls because the modeling results show that the flow divide forms within only a few feet of the funnel walls. At PRB sites, the capture zones are expected to be wider than the width of the barrier. The placement of the probes at these sites for capture width monitoring should be based on the modeling results. Regional flow can be determined by installing the probes farther upgradient of the PRB. To date, these probes have been installed at several PRB sites for capture zone determination, including Dover AFB, Cape Canaveral Air Station Hangar 34, and former Lowry AFB.

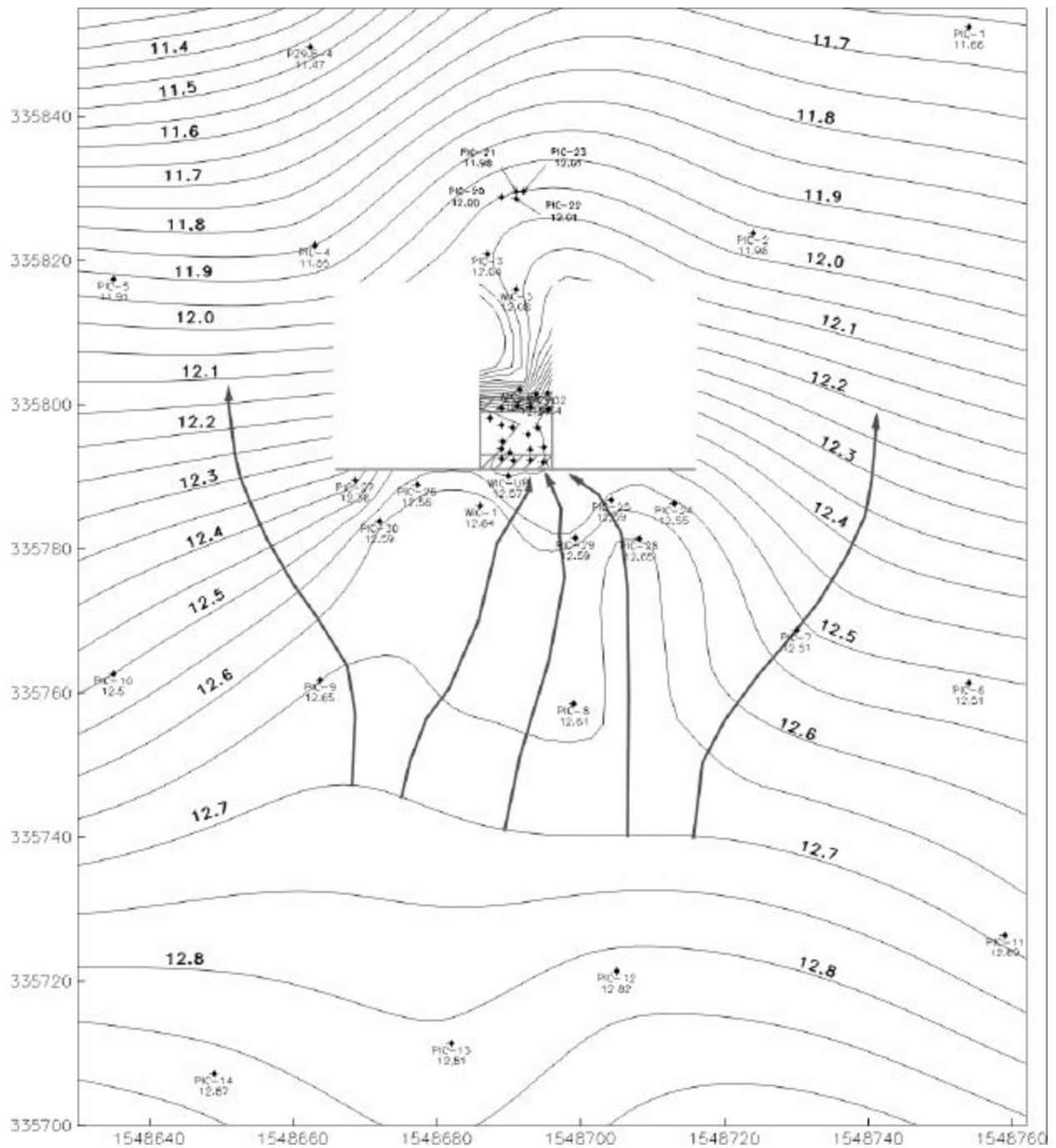
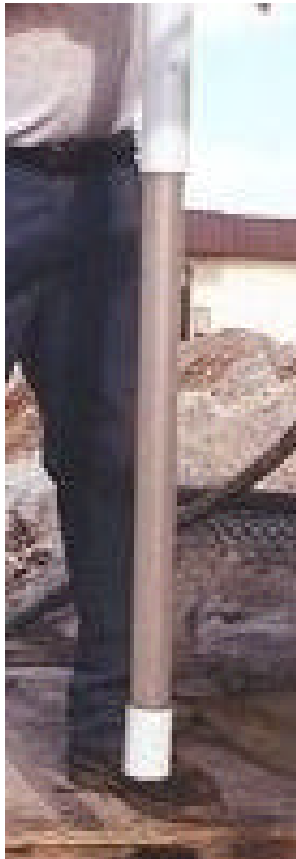

Figure 8-4. Water Levels and Capture Zone Near the Pilot-Scale PRB at Former NAS Moffett Field (May 1997)



(a)



(b)

Figure 8-5. Pictures of (a) an In Situ Groundwater Velocity Sensor and (b) Its Installation

8.2.1.3 Evaluating Hydraulic Capture Zone with a Colloidal Borescope

Colloidal borescopes (see Section 3.1) are an emerging tool for direct observation of flow in monitoring wells. These can be used in 2-inch-diameter completed wells with sand packs to delineate the flow patterns across the monitoring network. An evaluation of these probes is underway at former Lowry AFB and Dover AFB (Battelle, 2000). Preliminary results show that the probes work only in wells that have a stable colloidal flow pattern. Generally, long screen wells screened across the entire depth of the aquifer are desired because the probe can be used to locate zones with stable colloidal flow. However, the probes may work accurately in only the high flow zones within the aquifer. Currently, these probes should be considered experimental, but they may be a relatively economical option for mapping groundwater flow patterns at a site if proved successful. Mapping may be repeated several times during the performance monitoring to evaluate seasonal variations.

8.2.1.4 Evaluating Hydraulic Capture Zone with Tracer Tests

Tracer tests may be used to evaluate flow patterns in the vicinity of the PRBs. This form of testing is generally an expensive and time-consuming option for capture zone delineation. However, when successful, tracer tests can provide direct evidence of flow into the reactive gate. Tracer testing involves injection of a known amount of tracer, such as bromide, into an upgradient aquifer well and monitoring for concentrations in observation wells. The observation wells are located in the upgradient aquifer surrounding the injection well, in the reactive gate, and around the edges of the PRB. It is preferable to use selective ion electrodes for continuous monitoring of tracer to prevent the possibility of missing a tracer arrival in the observation wells. Selective manual sampling can be used to supplement and verify continuous probes.

As with water-level measurements, the strategy for tracer testing depends on the monitoring objective. If the only objective is to determine the flowpath of the groundwater from a specific location upgradient of the PRB, simple tracer tests may be conducted with injection in one upgradient well and monitoring for tracer arrival in the reactive cell. However, if detailed delineation of the capture zone upgradient of the PRB is required, then multiple tracer tests using different tracers and an extensive monitoring network are needed. Even with a very detailed tracer test, it is generally very difficult to account for the mass balance of the tracer and determine precise capture zone width. Tracer tests may not be economical at most sites, unless other methods fail to resolve the uncertainty in capture. Tracer tests in the upgradient aquifer for capture assessment have been performed on PRBs at former NAS Moffett Field (Battelle, 1998) and at Fry Canyon, UT (Piana et al., 1999).

8.2.2 Estimating Residence Time Distribution in the Reactive Cell

Degradation of contaminants in a PRB generally is controlled by rate-dependent processes taking place in the PRB. Therefore, residence time (the amount of time that the water is in contact with the reactive medium) affects the degree to which susceptible groundwater contaminants are degraded. Groundwater flow velocity measurements within the reactive cell provide information pertaining to residence time. In general, the strategies for estimating groundwater flow velocity in the PRB are the same as those for hydrogeologic site characterization (discussed in Section 3.1). The main options include the use of Darcy's Law, tracer tests, and in-well or in situ flow probes. Flow velocity monitoring includes an assessment of both spatial and temporal trends.

Special considerations are needed for monitoring flow within the PRB, most of which result from the very small area of investigation and the presence of heterogeneities. Most reactive barriers are only a few feet thick, which makes it difficult to delineate flow patterns with certainty. Heterogeneous flow can be caused by several factors, such as differential compaction of the iron fines, development of corrosion products on reactive medium surfaces, and precipitation of secondary minerals in the interstitial pore space. Heterogeneous flow also is caused by sharp conductivity differences between the aquifer and reactive cell media. Heterogeneity can decrease the overall effectiveness of the reactive cell by accelerating flow at preferential locations within the cell and thus decrease contact time between the groundwater and reactive medium. Heterogeneity increases hydrodynamic dispersion, which can promote breakthrough of contaminants. Due to the spatial and temporal variations, the field-estimated residence time is actually a range, at best more than half an order of magnitude, rather than a single value. The resulting uncertainty in the design can be reduced by making more precise parameter estimates and by incorporating appropriate safety factors. At most sites the incorporation of the safety factors has not been a problem because influent contaminant concentrations are low and contaminants are degraded as soon as they enter the PRB. However, at sites with very high expected chemical concentrations, the incorporation of sufficient safety factors may lead to unacceptably high costs.

The most common approach for calculation of flow velocity through the PRB is by using Darcy's Law. For example, this approach has been used for velocity determination at Dover AFB (Battelle, 2000) and former NAS Moffett Field (Battelle, 1998). Darcy's Law requires measuring the water levels and estimating the porosity and permeability of the reactive cell media. When gathering the required hydraulic data for flow velocity calculation, the following concerns should be taken into consideration:

- It is generally not practical to conduct pumping tests in the PRB. Therefore, slug tests and laboratory permeability tests (falling head or constant head column tests) are the main options for K determination. In addition, the field permeability may be significantly different than the laboratory permeability. Therefore, slug tests usually are the preferred method for K determination. In the PRB setting, the slug tests need to be conducted very carefully, because the high K of the iron or sand/gravel particles results in very quick recovery. The larger diameter wells with largest possible slug should be used. To the extent possible, site-specific slug testing should be conducted. Significant differences have been observed between the K values reported in the literature and those measured in the field using slug tests (Battelle, 2000).
- Similarly, recent experience at field sites has shown that the actual porosity of the reactive media may be as high as 0.7, which is much higher than the previously expected values.
- Water levels can be monitored in the wells installed in different zones at the PRB. These zones include immediate upgradient aquifer, upgradient pretreatment zone, the reactive media, downgradient pretreatment zone, and the downgradient aquifer. It is been observed through modeling as well as field monitoring (Battelle, 1998 and 2000) that the gradient across different zones differs considerably due to conductivity contrasts. Thus, as the water enters from the lower-K aquifer to higher-K reactive cell, there is a drop in water-level gradient. At the downgradient end, there is

generally some stagnation where water is moving from a very high K reactive cell to the lower-K aquifer. However, there is a steep gradient as soon as water leaves the exit zone. Overall, gradients generally are steep if water levels from upgradient to downgradient wells are used and are rather flat if only the wells within the PRB are used. The flatter gradients are generally balanced by the higher K in the reactive media. Therefore, theoretically, the overall flow balance is maintained. Continuous water-level monitoring may be performed in selected wells to supplement the periodic manual water-level measurements.

When using Darcy's Law with the above parameters, the geometric mean of K should be used. This calculated value for K can be further refined by weighting the thickness of the different media along the flowpath. Average and standard deviation of water levels from several monitoring events can be used to determine the range of possible flow velocities through the PRB.

8.2.2.1 Residence Time Estimation with In Situ Velocity Probes

In situ velocity probes from HydroTechnics, Inc. (see Section 3.1) can be installed in the PRBs during or after construction. The main advantage of these probes is that they provide continuous velocity data for about two years of operation. The limitations include the need to permanently install several probes in each PRB if an assessment of spatial variations is needed. This limitation is significant because velocity variations due to media heterogeneity and sharp contrasts in conductivity between reactive media and aquifer sediments have been observed at most sites. Another limitation is the potentially adverse effects of thermal and magnetic influences of the reactive media (such as iron) on the probe measurement; at a minimum, these influences result in the need for different calibration for the probes placed in the PRB, and should in any case be investigated further in future studies. An example of the velocity magnitude and direction monitoring data collected using a HydroTechnics probe installed in the PRB at Dover AFB (Battelle, 2000) is shown in Figure 8-6. At this site, the flow directions showed a good match with those determined from other methods. However, the velocity values were generally much lower than expected. It is not clear if the velocity values determined from the probe were correct or if they were affected by the thermal or magnetic influence of the reactive media.

A colloidal borescope (see Section 3.1) also may be used to measure groundwater flow velocity in the reactive cell. The borescope provides direct observations of flow in various zones within a monitoring well, and theoretically can be used to take several flow measurements in each monitoring well at different depths. Thus, borescopes can help determine vertical flow variations within each well. When repeated in several wells in the PRB, borescope measurements can be used to develop a 3-D understanding of flow velocity and directions. Furthermore, such measurements may be repeated over time to monitor for seasonal and long-term changes in flow patterns. As mentioned before, these probes are still experimental in nature. However, if they can provide accurate velocity estimates, then these probes may be the most useful option for evaluating flow patterns in the reactive cell.

8.2.2.2 Residence Time Estimation with Tracer Tests

Tracer tests involving a conservative tracer can be used to evaluate flow velocities and potential heterogeneities in the reactive cell. Many different tracers are available for this purpose, but they should be evaluated for potential retardation by the PRB reactive media. For example, sodium

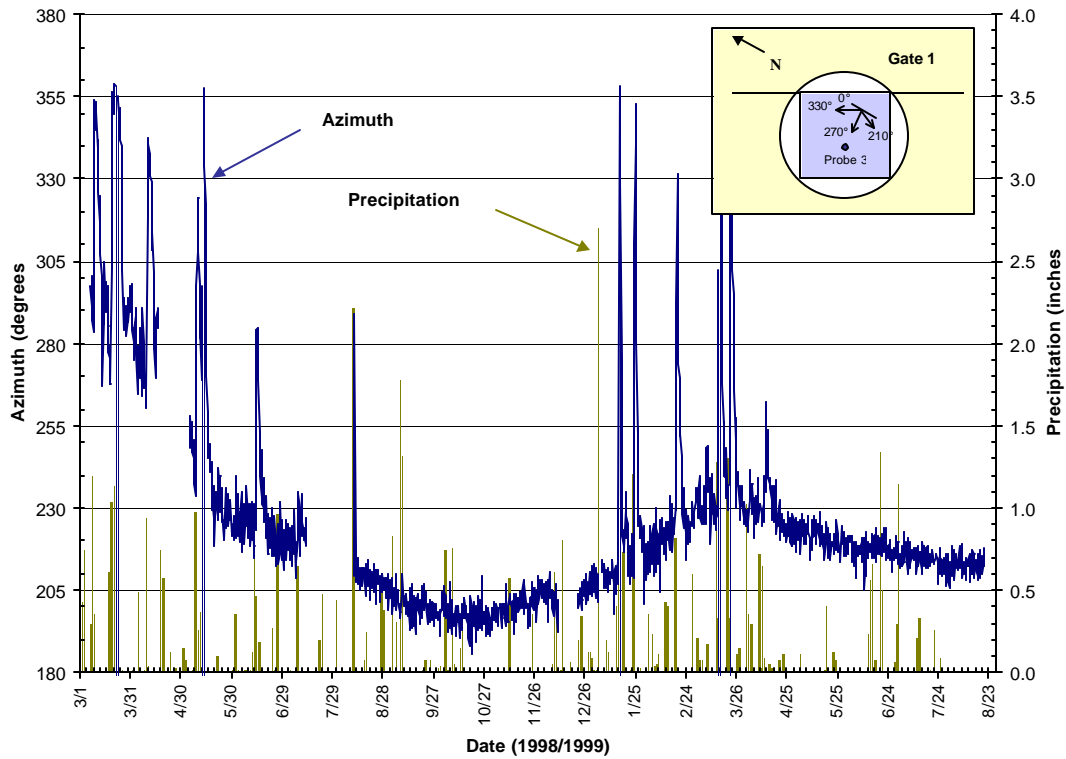
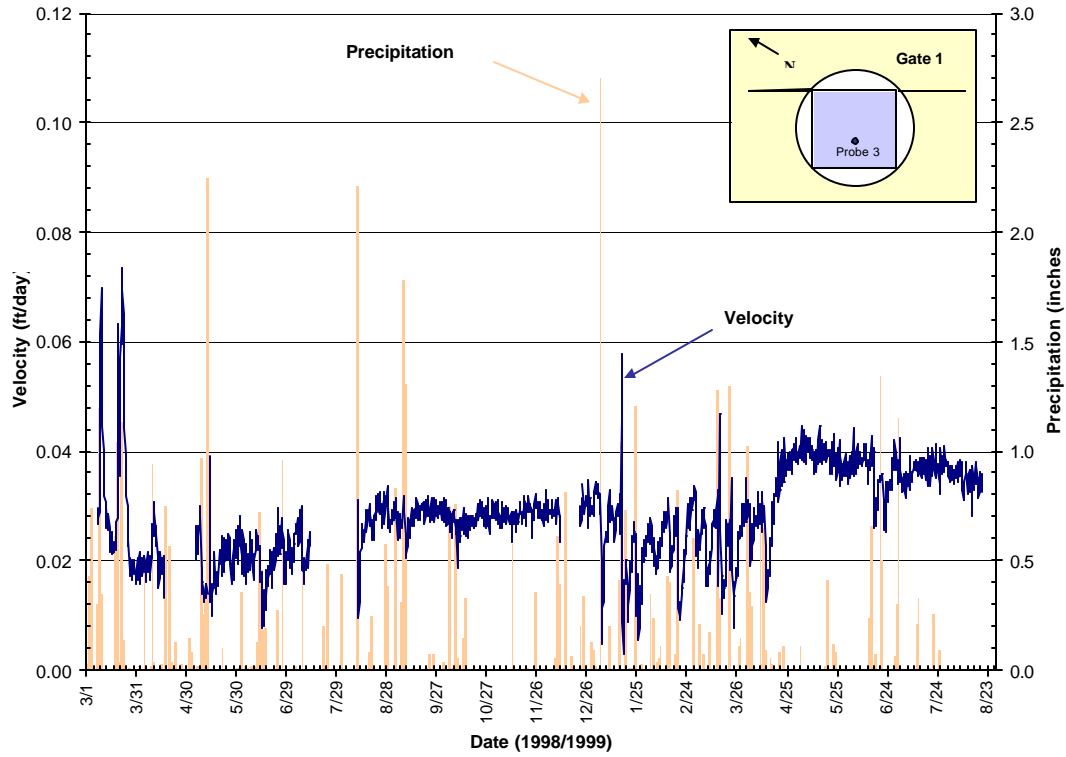

Figure 8-6. (a) Groundwater Velocity and (b) Direction Measured in the Reactive Cell of the PRB at Dover AFB Using an In Situ Velocity Probe

bromide has been found to work well in an iron reactive medium when a retardation factor of 1.2 is incorporated (Sivavec, 1996). During preliminary site characterization, the levels of tracer in the native groundwater should be measured. Elevated levels in the native groundwater would make the tracer test more difficult, because a larger concentration of injected tracer would be required. At high concentrations, the tracer may be subject to a density gradient as it travels through the aquifer or reactive cell. The resulting path of the tracer, then, may not be the same as that of the natural groundwater. One advantage of a tracer (such as bromide) is its ability to be continuously monitored using downhole, ion-selective electrodes. Continuous monitoring with such probes increases the probability of capturing the tracer peak and reduces labor costs. Ion-selective probes are expensive, but their cost could be justified by reduced labor requirements and increased chances of success. Field application of tracer tests for evaluating PRBs has not been very successful in the past for a variety of reasons (Focht et al., 1997). In particular, difficulties in ensuring the success of tracer tests occur as a result of the high cost involved in obtaining adequate sampling density (number of monitoring wells and frequency of sampling) and of the limitations of monitoring instruments. However, tracer tests within the PRB are more likely to be successful than those conducted in the aquifer for capture zone delineation, because the possible flowpaths in the PRB are relatively constrained by sheet piling on two sides.

An example tracer test in a PRB took place at the former NAS Moffett Field PRB site (Battelle, 1998). In this case, tracer was injected in a well in the upgradient pea gravel zone. It was observed that the tracer spreads laterally within the pretreatment zone before moving into the reactive zone (Figure 8-7), because the conductivity of the pea gravel in the pretreatment zone was greater than that of the reactive media. At this site, the tracer test showed that the flow was moving in the expected downgradient direction. It also showed that the actual flow through the reactive cell was highly heterogeneous. However, despite very extensive monitoring, it was not possible to achieve an acceptable mass balance for the tracer. Therefore, the presence of other pathways for flow could not be ruled out. Other examples of tracer testing for performance assessment at PRB sites are presented in Piana et al. (1999) for Fry Canyon, UT, and Devlin and Barker (1999) for monitoring of flushing through a PRB at the Borden site in Ontario, Canada.

8.3 Geochemical Performance Monitoring Strategy

Generally, monitoring the geochemical performance of a PRB is a secondary consideration, with contaminant degradation and hydraulic performance being the key short-term concerns. In the long term, however, site managers may want to evaluate how long the reactive medium will continue to provide the desired performance. Also, site managers may wish to determine how well the field PRB system matches the predictions of the geochemical evaluation done during the design stage (based on site characterization and column test information as described in Section 6.4).

There are three main methods available for monitoring the geochemistry of the PRB, and these range in cost and complexity:

- ❑ Groundwater monitoring for inorganic species
- ❑ Geochemical modeling
- ❑ Core extraction and analysis.

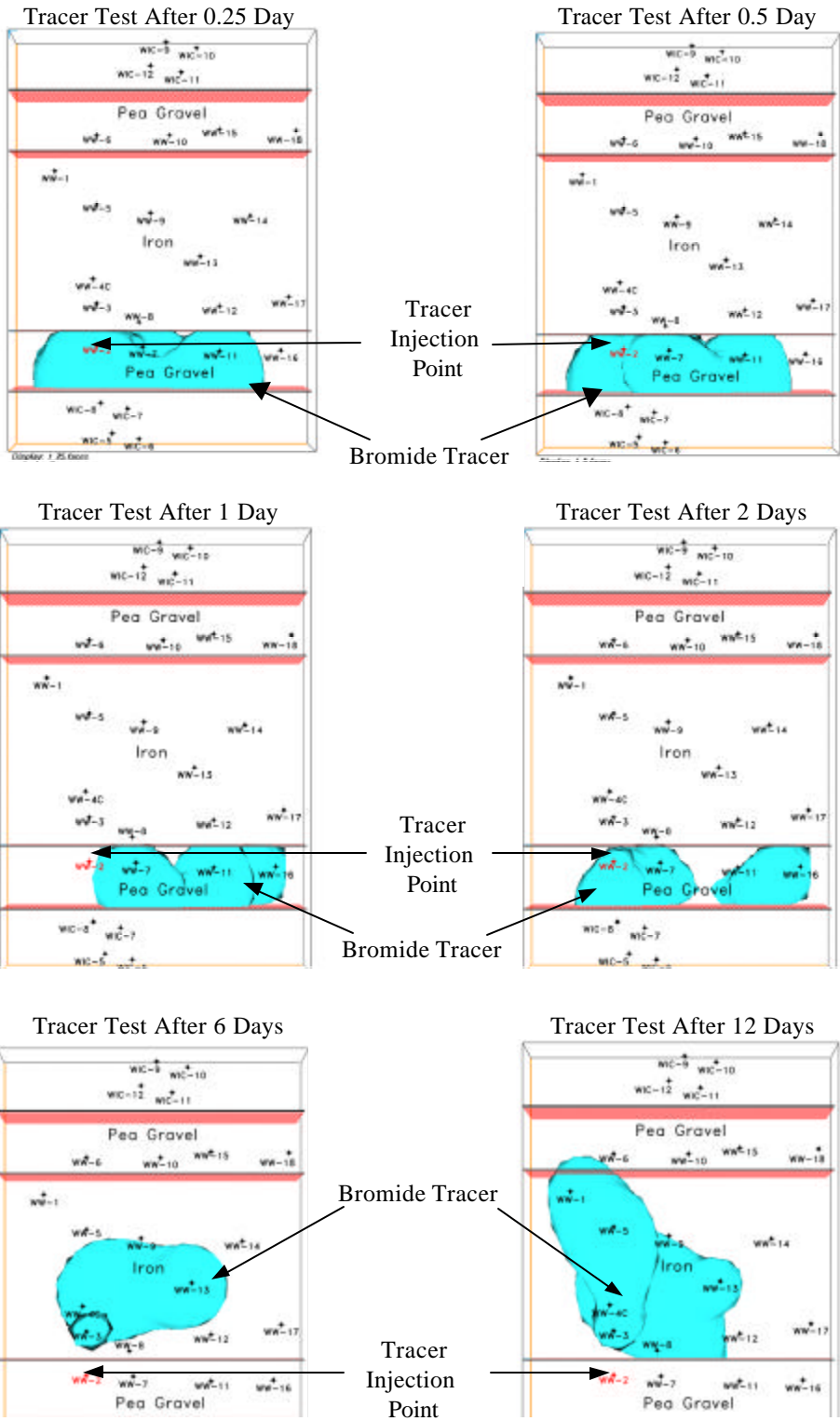

Figure 8-7. Movement of Bromide Tracer Plume through the PRB at Former NAS Moffett Field (Battelle, 1998)

Monitoring groundwater within the PRB for inorganic species is essential for understanding geochemical conditions and is a prerequisite for geochemical modeling. Inorganic analysis need not be performed as often as VOC sampling, but a comprehensive round of analyses could be done every one to two years. At this frequency of data collection it should be possible to detect any significant changes taking place within the barrier and have sufficient time to correct them before the barrier fails to meet compliance requirements. Generally, groundwater monitoring and data analysis is sufficient at most sites for evaluating geochemical interactions. Geochemical modeling and reactive medium core collection and analysis are specialized methods that could be undertaken for technology development purposes or for more detailed evaluation of the site geochemistry, if groundwater monitoring reveals any unusual patterns that could affect PRB performance.

Geochemical modeling requires high-quality measurements of field parameters and elemental concentrations that typically would be obtained during groundwater monitoring. Reliance on raw groundwater data alone is limited in two ways. First, subtle changes in groundwater chemistry may be overlooked in raw data; and second, there is no reference with which to compare raw data. However, with geochemical monitoring, subtle changes in groundwater chemistry may be more apparent in the modeling results; also, geochemical modeling results can be compared to theoretical equilibrium calculations, which would provide an important reference point for understanding the geochemical system through the monitoring data. It is important to note that the input data must include all parameters that relate to interactions in the barrier for geochemical modeling to produce meaningful results.

Finally, core sampling of the iron and surrounding media offers a direct way to observe geochemical behavior within these media. Core sampling is much more invasive than groundwater sampling and should only be performed at critical times. For example, if the performance of the barrier has degraded over time and this behavior seems to be related to either hydraulic factors (e.g., plume bypass) or a decline in reactivity (e.g., plume breakthrough), core sampling could provide important information about conditions within the barrier. If an opportunity arises to take core samples at an earlier stage (i.e., before any threat to the performance of the barrier is detected), the analysis data could serve as a baseline with which to compare observations at a later date. In addition, it is also a good idea to save some of the unused iron for comparison with core samples collected at a later time. The unused iron should be stored in an airtight container, preferably inside a desiccator.

8.3.1 Evaluating Geochemical Performance with Groundwater Monitoring

To monitor the processes taking place within a barrier, the following geochemical information should be collected on a routine basis (monitoring events could be incorporated into the compliance monitoring schedule):

- ❑ On-site field parameter measurements
- ❑ Inorganic chemical analysis of groundwater samples.

The primary purpose of taking field parameter measurements and analyzing groundwater samples for inorganic constituents is to ensure that the PRB maintains its ability to degrade halogenated contaminants or immobilize target metals. Another purpose may be to confirm that DO

is being scrubbed within a pretreatment zone, so that water entering the reactive cell is anoxic. On-site field parameter measurements should be used to track parameters such as DO, ORP, pH, conductivity, and temperature. Typical levels of DO in an aerobic aquifer can be measured using a DO probe. Usually, DO probes are effective when oxygen levels are between 0.5 mg/L and saturation (about 8 mg/L). They tend to give spurious readings when oxygen levels are below 0.5 mg/L and therefore are not suitable for measuring conditions within the reactive cell.

The strength of the reducing environment inside a reactive cell must be measured using a combination or pair of electrodes, consisting of a working electrode (usually a platinum wire) and a reference electrode (typically a AgCl/Ag cell). A more universal expression of ORP is the Eh, which refers to the standard hydrogen electrode (SHE) as the reference potential. ORP is easily converted to Eh by subtracting the reference cell potential. Redox measurements are often expressed in volt (V) or millivolt (mV) units. Another scale that can be used is the pe scale, which is related by $pe = Eh \text{ (mV)}/59.2$ at 25°C. Thus, for both scales, a zero value refers to the same potential, and the signs stay the same. ORP, Eh, and pe become more negative in reducing environments and more positive in oxidizing environments. Because other factors, including pH, affect redox measurements, there are no absolute values that indicate oxidizing or reducing conditions only, or serve as a divider between the two.

In most situations, field parameter measurements can be taken using probes that are either configured for downhole submersion or coupled to a flowthrough cell for aboveground use. Whichever type is used, it is important to record the readings after the probe has stabilized. Also, the water inside the probes must be protected against contact with ambient air, particularly so that DO and ORP readings are not biased. Downhole probes more easily assure that air contamination does not occur.

If all groundwater sampling is to be conducted during one event, the samples for volatile organic analytes should be collected before those for inorganic analytes in order to obtain the most representative samples for VOC analysis, as explained in Section 8.1.2. It is preferable to collect all samples for VOCs first, and then repeat the sampling schedule to collect samples for inorganic analysis. Analytical laboratories require different containers and preservation methods for metals and anion analysis. Recommended inorganic analytical requirements for groundwater samples are given in Table 8-1. Added to the list would be any substances that are either treated by the barrier (such as Cr), or substances that may have some indirect effect on the barrier (such as high concentrations of phosphate). Samples for metals analysis should be filtered in the field using 0.45- μm or smaller pore-size membranes immediately after collection. Filtering helps to exclude colloidal material and suspended iron fines from being collected with the water sample, which would be subsequently acid-digested and analyzed. Elimination of colloidal material from the sample is necessary because only the concentrations of dissolved species rather than total metals have bearing on mineral precipitation. Iron and manganese are the most problematic metals to analyze, due to their tendencies to adsorb onto colloidal material. If turbidity is very low, it may not be necessary to filter for main group metals, such as Na, K, Mg, and Ca. However, it is advisable to verify whether filtering should take place by taking filtered and unfiltered samples during one event and comparing the results. If metal concentrations are significantly higher in the unfiltered samples, then filtering should be considered necessary.

Table 8-1. Recommended Inorganic Analytical Requirements for Groundwater Samples

| Analytes | Analysis Method | Sample Volume | Storage Container | Preservation Method | Sample Holding Time |
|--|-----------------|---------------|-------------------|---------------------------------------|------------------------|
| <i>Cations</i> | | | | | |
| Na, Ca, Mg, Fe, and Mn | EPA 200.7 | 100 mL | Polyethylene | Filter, 4°C, pH<2 (HNO ₃) | 180 days |
| <i>Anions</i> | | | | | |
| NO ₃ , SO ₄ , and Cl | EPA 300.0 | 100 mL | Polyethylene | 4°C | 28 days ^(a) |
| Alkalinity | EPA 310.1 | 100 mL | Polyethylene | 4°C | 14 days ^(b) |
| <i>Neutrals</i> | | | | | |
| Dissolved silica | EPA 6010 | 250 mL | Polyethylene | None | 28 days |
| TDS | EPA 160.1 | 100 mL | Polyethylene | 4°C | 7 days |

- (a) Holding time for nitrate is 48 hours when unpreserved; holding time can be extended to 28 days when preserved with sulfuric acid.
- (b) Determination of alkalinity in the field using a titration method is preferred whenever there is concern over precipitation in the sample container during storage.

In addition, anions including nitrate, sulfate, chloride, and alkalinity should be analyzed because of their electroactivity (nitrate and sulfate), potential for precipitation (alkalinity and sulfide), and conservative reference (chloride). Other analytes that should be measured include dissolved silica, because of concern over iron passivation, and TDS, which can be correlated with conductivity and helps confirm that all major dissolved species have been analyzed.

Ionic charge balance should be calculated to provide a measure of inorganic data quality independent of routine analytical quality assurance/quality control (QA/QC). Charge balance is calculated as the percent difference in cation and anion milliequivalents (meq), as shown in the following equation:

$$\text{Charge balance} = 100 \times \frac{\text{meq cations} - \text{meq anions}}{\text{meq cations} + \text{meq anions}} \quad (8-1)$$

Electrolyte solutions are electrically neutral, so any charge balance calculated to be more or less than zero represents cumulative errors in analysis of the ionic species. Solutions that are within 10% cation-anion balance are considered adequately balanced for subsequent uses such as geochemical modeling. Figure 8-8 shows charge balance results from sampling at Dover AFB in June 1999. In this figure, the data are distributed near the charge balance line (heavy line), and most points fall within the ±10% envelope. This figure also illustrates that water in Gate 2 had a higher ionic concentration than water in Gate 1.

Analysis of the groundwater monitoring data is similar to the evaluation of inorganic parameter data from column tests, as described in Section 6.4.2. In addition to conducting a qualitative evaluation of the types of precipitates that may be expected, a quantitative evaluation can be conducted by comparing the groundwater influent and effluent levels of inorganic parameters (e.g., Ca, Mg, and alkalinity). Tables 6-2 and 6-3 in Section 6.4 show how differences between the influent and effluent concentrations can be used to estimate the groundwater losses of these

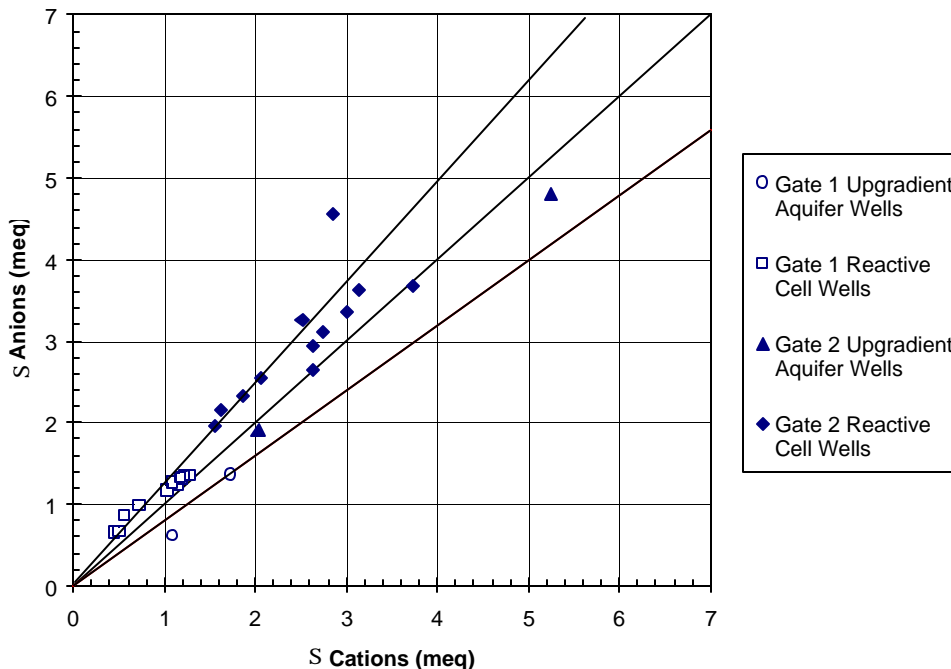

Figure 8-8. Ionic Charge Balance for Selected Wells at the PRB at Dover AFB (June 1999)

parameters due to precipitation. However, as also mentioned in that section, the difficulty in linking groundwater losses of these constituents to any losses in the reactive and hydraulic performance of the PRB lies with the inability to link mass of precipitate to loss of reactive surface sites. Currently, it is unclear how these precipitates account for a loss in reactive sites on the reactive medium. For example, if the precipitates form a thin mono-layer on the reactive medium surface, very little precipitate mass may be needed to consume all available reactive sites; on the other hand, it is not clear whether or not the precipitates occupy the same reactive sites as the contaminants. Also, if the precipitates either tend to form multiple layers on the reactive medium surface, settle in bulk at the bottom of the reactive cell, or are transported out of the reactive cell as colloidal particles, the PRB could sustain a considerable mass of precipitate before reactive and/or hydraulic performance starts declining. Evaluating the longevity of a PRB is an area requiring further research, especially given its potential influence on PRB performance and economics.

8.3.2 Evaluating Geochemical Performance with Geochemical Modeling

Geochemical modeling can be used to simulate reactions between a native groundwater and the reactive medium, such as iron. This modeling can be useful for understanding the mechanisms of various kinds of precipitates that can form. Two types of computer models are commonly used for this purpose: equilibrium models and inverse models. Both are described in Appendix D and contain examples from PRB sites.

8.3.3 Evaluating Geochemical Performance with Reactive Medium Core Sampling

Reactive medium core sampling and analysis are specialized techniques that may not be required at most PRB field sites. However, core analysis provides important geochemical information for

evaluating the longevity of the reactive medium. If problems with field PRB performance relating either to hydraulics or to degradation of contaminants of concern are detected, it may be desirable to investigate the cause by examining the reactive medium directly. This can be done by collecting core samples of the reactive medium and analyzing them for the following:

- ❑ Evidence of chemical and mineralogical changes
- ❑ Signs of any unusual microbial activity (aquifer soil samples should be analyzed too).

When performing core sampling, possible changes in the reactive medium near the interfaces with the adjoining sections are of particular interest, because these interfacial regions are the places where plugging could be most pronounced. The upgradient interface also is very important because this is where the most sudden change in chemical environments occurs. To examine these interfaces, vertical core samples of medium should be taken as close as possible to the adjoining upgradient section (i.e., pea gravel or aquifer). If possible, angled cores also should be placed into the upgradient interface of the medium. Vertical cores are easily taken by various kinds of direct push equipment. Taking angled cores, on the other hand, requires more versatile equipment. Angled cores can be very useful because they expose greater surface area and can cut across the interface of the medium and aquifer or pretreatment zone. Core samples of granular iron medium have been collected from some existing PRBs and examined for signs of the corrosion and precipitation as predicted by the groundwater analysis and geochemical modeling. Figure 8-9 shows a vertical core being extracted at the Dover AFB PRB site, and Figure 8-10 shows an angled core being taken at the former NAS Moffett Field PRB.

Coring locations should be chosen to provide specimens over a large area of the permeable barrier and also to include aquifer samples both upgradient and downgradient of the permeable barrier for microbiological analysis. However, precedence should be given to the upgradient



Figure 8-9. Core Sampler Extracting Vertical Core at Dover AFB



Figure 8-10. Enviro-Core™ Sampler Extracting Angled Core at Former NAS Moffett Field

portion of the reactive cell, where more precipitation is likely to occur. At least three cores should be taken in the reactive cell so that spatial information about the iron is available.

The sampler itself should be designed for coring at discrete depth intervals, so that depth information can be incorporated into the analysis. Core barrels are typically fitted with several short (6-inch-long) stainless steel or brass sleeves, or one long clear plastic sleeve. Multiple sleeves allow shipment of samples from a comparable depth interval to be shipped to various locations without the need for sub-sampling.

After sample sleeves are removed from the core barrel, the sleeves should be fitted with tight-fitting plastic caps to contain the sample and restrict air. It is important to minimize air contact with the samples after they are collected. Several storage approaches have been reported in the literature, as summarized in Table 8-2. The approach used at Dover AFB and former Lowry AFB has been to place the sample sleeves into Tedlar™ bags that contain packets of oxygen scavenging material, as shown in Figure 8-11. The bags then are purged with nitrogen gas, as shown in Figure 8-12, and refrigerated until they are shipped to an analytical laboratory. Samples for microbiological analysis should be shipped in an airtight container to the designated laboratory. Samples for inorganic analysis should be vacuum-dried using a vacuum oven without heat. Core samples then should be placed in a nitrogen-filled chamber for sub-sampling and storage until needed.

Table 8-2. Survey of Core Sampling and Preparation Methods

| Location | Sampling/Drilling ^(a) | Storage/Shipping ^(a) | Sample Processing ^(a) |
|--|---|--|--|
| Former NAS Moffett Field, CA; and former Lowry AFB, CO | <p>Enviro-core dual-tube sampling, vibrated into the ground. Poor core recovery at former Lowry AFB (with a “catcher.”)</p> <p>Polybutyrate liners used initially because they were denser; currently use three 6-inch-long stainless steel sleeves inside 18-inch-long barrel. Obtain three subsamples per barrel. Sleeves are placed in a Tedlar™ bag that has previously been purged with inert gas. Oxygen scrubber is put on the bag. Samples are shipped cold.</p> <p>Interface between reactive iron and pea gravel difficult to distinguish due to clogging of the sampling system when the pea gravel was encountered.</p> | <p>Refrigerated immediately and shipped on blue ice to an off-site laboratory where samples were placed in a glove box and purged with ultrapure nitrogen.</p> | <p>Sleeves were transferred to a heated vacuum dessicator. The tape was removed but it was unnecessary to remove the caps. Vacuum drying was conducted at 125°F and required up to 72 hrs. Core samples then were returned to the glove box.</p> <p>Sleeve end caps were removed from the dried core while inside the nitrogen glove box and 1 inch of material on each end was discarded. The remaining sample was put into glass jars and mixed to homogenize. Subsamples were prepared in small glass vials and sealed in nitrogen.</p> |
| Dover AFB | <p>A direct-push CPT sampler was used for vertical core collection. Three 6-inch-long stainless steel sleeves were fitted into the core barrel for each push. Recovery of iron was less than 50%.</p> | <p>Refrigerated immediately and shipped on blue ice to an off-site laboratory where samples were placed in a glove box and purged with ultrapure nitrogen.</p> | <p>Sleeves were transferred to a heated vacuum dessicator. The tape was removed but it was unnecessary to remove the caps. Vacuum drying was conducted at 125°F and required up to 72 hrs. Core samples then were returned to the glove box.</p> <p>Sleeve end caps were removed from the dried core while inside the nitrogen glove box and 1 inch of material on each end was discarded. The remaining sample was put into glass jars and mixed to homogenize. Subsamples were prepared in small glass vials and sealed in nitrogen.</p> |
| Somersworth landfill site, NH | <p>Geoprobe® was used; there was a problem of pea gravel mixing with the Fe and biasing carbonate results.</p> | <p>Shipped on ice</p> <p>Shipped overnight</p> | <p>XRD and SEM/EDS performed. Iron grains were gently washed with nitrogen-purged acetone in a nitrogen glove box. Grains were filtered, washed repeatedly with additional acetone, and then vacuum-dried in a dessicator.^(b)</p> <p>A single acetone rinse is insufficient, multiple rinses are needed.</p> |

Table 8-2. Survey of Core Sampling and Preparation Methods (Continued)

| Location | Sampling/Drilling | Storage/Shipping | Sample Processing |
|---|--|---|--|
| ORNL, TN | Geoprobe [®] used for angle coring, samples collected in polyurethane tubes. Attempted to obtain 4 ft samples but only retrieved ~2 ft because of compaction and spillage. | After removal, cores purged with argon and sealed with rubber stoppers. During the period between sampling and preparation (2-3 weeks), the storage tubes were purged with nitrogen twice per week. Other samples preserved with acetone. | Representative samples were washed with acetone prior to mineralogical analysis. Remainder of sample was air-dried, ground and mixed. |
| Kansas City Plant, KS; and Fry Canyon, UT | Geoprobe [®] used for angle coring, samples collected in PTEG sleeves. No problems obtaining complete core with intact interface. | After removal, cores purged with argon and sealed with rubber stoppers. During the period between sampling and preparation (2-3 weeks), the storage tubes were purged with nitrogen twice per week. Other samples preserved with acetone. | Kansas City Plant: Samples frozen, awaiting processing. Fry Canyon: USGS processing/no information available. |
| Elizabeth City, NC | Geoprobe [®] used. | Polycarbonate sleeves, cut and seal the sleeves with plastic electrical tape and quick freeze with liquid nitrogen in the field. Ship overnight on dry ice for processing in glove boxes. Also performing acetone treatment in field. | Geochemical analyses: replaced pore water with acetone to eliminate oxidative effects. Microbiology “freeze dry and store” frozen until analysis. |
| Others | Collected at Kansas City Plant and Fry Canyon sites. | Samples packed in ice with 50% ethanol in one set and a 2% solution of gluteraldehyde (stored anaerobically). | Microbiological analyses only. |

(a) Sources: Korte, 1999; Battelle, 1998 and 2000.

(b) Comparison testing demonstrated that vacuum dried samples had additional oxidation relative to samples processed with acetone.

USGS = United States Geological Survey.

Samples should be analyzed by a laboratory that can perform the kinds of analyses recommended in Table 8-3. Many materials science or geology laboratories have instruments for inorganic non-biological analysis. Microbiological samples should be sent to a laboratory equipped to perform heterotrophic plate counts and phospholipid fatty acid (PLFA) profiles of microbial



Figure 8-11. Photograph of Core Sleeves Being Placed into Tedlar™ Bags that Contain Packets of Oxygen Scavenging Material



Figure 8-12. Tedlar™ Bags Flushed with Nitrogen Gas Before Sealing

Table 8-3. Recommended Characterization Techniques for Coring Samples

| Analysis Method | Description |
|--|---|
| Total Carbon Analysis Combustion furnace used to quantify total organic and inorganic (carbonate) carbon | Quantitative determination of total carbon. Useful for determining fraction of carbonates in core profile. |
| Raman Spectroscopy Confocal imaging Raman microprobe | Semiquantitative characterization of amorphous and crystalline phases. Suitable for identifying iron oxides and hydroxides, sulfides, and carbonates. |
| Fourier Transform Infrared Spectroscopy (FTIR) FTIR coupled with auto-image microscopy | Attenuated total internal reflection (ATR) spectra were collected using a germanium internal reflection element. |
| Scanning Electron Microscopy Secondary electron images (SEI) Energy-dispersive spectroscopy (EDS) | High-resolution visual and elemental characterization of amorphous and crystalline phases. Useful for identifying morphology and composition of precipitates and corrosion materials. |
| X-Ray Diffraction (XRD) Powder diffraction | Qualitative determination of crystalline phases. Useful for identifying minerals such as carbonates, magnetite, and goethite. |
| Microbiological Analysis Heterotrophic plate count PLFA profiling | Identification of microbial population within the cored material. Useful for determining the presence or absence of iron-oxidizing or sulfate-reducing bacteria. |

strains. The main intent of the non-biological analysis is to determine physical and chemical changes that have taken place in the iron due to exposure to site groundwater. The microbiological analysis is intended to determine if microbiological activity is occurring in the iron or downgradient aquifer, because buildup of and fouling by biomass is a potential concern.

9.0 PRB Economics

The potential long-term economic benefit of PRBs has been an important driving force behind the interest in this technology. At sites with groundwater contaminants, such as chlorinated solvents, that could persist for several years or decades, a passive technology (namely, PRB) that has no recurring operating labor or energy requirement beyond quarterly monitoring has a potential long-term cost advantage over a conventional P&T system. Key variables that affect PRB economics are the length of time that a given installed reactive medium will retain its reactive and hydraulic performance and, consequently, the type and frequency of the maintenance required to replace and/or regenerate the reactive medium. Because the PRB technology has undergone field application only in the last five years or so, there is no historical experience or data which can be relied on to make a clear judgement about the longevity of a PRB, and any cost evaluation should take this uncertainty into account.

Because PRB application costs need to be evaluated in the context of a competing technology, PRB and P&T costs are used to illustrate the costs evaluation in this section. Other alternatives to P&T, such as air sparging or bioremediation, also may be used as the competing technology with a similar evaluation approach.

The two main categories of costs for any technology are capital investment and O&M costs. These two categories of costs are addressed in this section for the PRB and P&T technologies. For long-term applications, O&M costs are spread over several years or decades. A PV analysis that takes into account the time value of money is described in this section to evaluate PRB and P&T costs. Finally, the intangible costs and benefits of the competing technologies (both PRB and P&T) are taken into account for a final economic decision on whether to implement a PRB at a given site. Appendix B provides an example of a cost evaluation conducted for a full-scale PRB application for a CVOC plume at Dover AFB, based on a pilot project completed recently (Battelle, 2000). Another useful reference for cost analysis of long-term projects is the document titled "Standard Life-Cycle Cost-Savings Analysis Methodology for Deployment of Innovative Technologies," published by the DOE Office of Environmental Management (DOE, 1998).

The cost evaluation described in this section can be conducted to varying degrees at two stages in the design of a PRB. First, a preliminary cost evaluation may be conducted during the preliminary assessment to determine the suitability of a site for PRB application. This evaluation would compare the cost of a PRB application at the site to the cost of using a competing technology, such as P&T. Although a detailed cost evaluation may not be possible at the preliminary assessment stage, rough estimates for capital investment and O&M costs for the two options (PRB and P&T) may be developed during initial discussions with reactive medium suppliers and construction contractors. This early process of contacting construction contractors also helps to identify the most cost-effective PRB construction technique for a given aquitard depth and other site features involved. If the preliminary cost evaluation turns out to be favorable for the PRB, site managers could proceed to additional site characterization, laboratory testing, modeling and engineering design, and monitoring plan preparation, as described in Section 2.0. Once the draft

design is ready, reactive medium suppliers and construction contractors can be contacted again, this time to obtain detailed cost estimates, and a detailed cost analysis then can be conducted.

At both stages of the cost evaluation, a major uncertainty in the cost evaluation is the longevity of the reactive medium (i.e., the period of time over which the reactive medium can sustain the desired reactive and hydraulic performance). The longevity of the reactive medium determines the frequency at which the reactive medium may need to be regenerated or replaced, and therefore determines the long-term O&M costs of the PRB. In the absence of a reasonably accurate prediction of the longevity of the PRB, the methodology of developing multiple longevity scenarios described in Section 9.3 is suggested. These longevity scenarios indicate the minimum life expectancy of the reactive medium that will make the PRB a cost-effective investment.

9.1 Capital Investment

Capital investment in a technology refers to the funds required to cover the initial non-recurring cost involved in acquiring and installing the technology to the point where it is ready for its intended use. Using the PRB installed at Dover AFB as an example, Table 9-1 illustrates the items that constitute the capital investment in a PRB. The capital investment for installing a PRB includes the following major items:

- ❑ Preconstruction costs
- ❑ Materials and construction costs.

Most sites with PRBs so far have reported materials and construction costs only as the total cost of a PRB, probably because materials and construction costs are easier to identify, track, and estimate than are preconstruction costs. However, preconstruction costs are generally significant enough that they should be considered for the economic evaluation. Appendix B contains an illustration of the capital investment requirements estimated for a PRB at Dover AFB, as well as the capital investment estimated for an equivalent P&T system for comparison. An equivalent P&T system is one capable of capturing the same amount of water as the PRB.

9.1.1 Preconstruction Costs

Preconstruction costs are those incurred for the activities leading up to initiation of PRB construction at the site. This category includes items such as preliminary site assessment, site characterization, laboratory testing, PRB modeling and design, procurement of materials and construction contractors, and regulatory review. Preconstruction costs are not inconsequential and can constitute as much as 50% of the total capital investment in the PRB.

Site characterization is usually the largest component of preconstruction costs, whether for a PRB or a P&T system. Given the fact that the PRB is a more or less permanent structure that is difficult to expand and/or modify, adequate site characterization is all the more important for understanding the local contaminant and groundwater flow features of the site on the scale of the planned PRB. The degree of site characterization required at a site may vary depending on the complexity of the contaminant distribution and/or hydrogeologic environment and on the amount of existing information available from previous RFI or RI/FS studies.

Table 9-1. Illustration for Estimating Capital Investment Based on the Projections for Operating a Full-Scale PRB at Dover AFB

| Item | Description | Basis | Cost |
|--|--|--|------------------|
| <i>Phase 1: Preconstruction Activities</i> | | | |
| Preliminary site assessment | Historical site data evaluation | RI/FS, other reports procurement and evaluation; site meeting | \$15,000 |
| Site characterization | Characterization Plan, fieldwork, laboratory analysis | CPT pushes for geologic mapping and temporary wells; analysis of water samples for CVOCs; select samples for geotechnical analysis; slug tests; ground-penetrating radar survey ^(a) | \$200,000 |
| Column tests | Two column tests; Area 5 groundwater | Column tests ^(a) and laboratory analysis of water samples; report | \$50,000 |
| Design, procurement of subcontractors, and regulatory review | Data evaluation, modeling, engineering design, Design Plan; procurement of subcontractors; interactions with regulators | Characterization/column test data evaluation; hydrogeologic modeling; geochemical evaluation; engineering design; report; procurement process; regulatory interactions | \$100,000 |
| Subtotal | | | \$365,000 |
| <i>Phase 2: PRB Construction Activities</i> | | | |
| Site preparation | Utilities clearances; arrangements for equipment/media storage and debris disposal | Coordination with regulators and Base facilities staff | \$10,000 |
| Reactive media procurement | Connelly iron, shipping | Iron: 108 tons @ \$360/ton Shipping: \$9,000 | \$48,000 |
| PRB Construction | Mobilization/demobilization; Installation of four 8-ft-diameter caisson gates to 40-ft depth; 120-ft-long sheet pile funnel; asphalt parking lot restoration | Mob./demob.: \$60,000 Gates: \$266,000 Monitoring wells: \$25,000 Funnel: \$102,000 Surface restoration: \$34,000 | \$487,000 |
| Monitoring system construction | Thirty-four PVC aquifer wells installed for monitoring the pilot-scale PRB | Aquifer wells: \$37,000 | \$37,000 |
| Subtotal | | | \$582,000 |
| TOTAL | | | \$947,000 |

(a) All cost items may not be necessary or applicable at other sites. A lower level of these activities may be sufficient at some sites.

Design and modeling, procurement of materials and construction contractors, and regulatory review are important preconstruction activities that may require some effort and cost. Design and modeling generally include the analysis conducted to interpret the laboratory test data and site characterization data in order to determine the location, orientation, configuration, and dimensions of the PRB.

Selection and procurement of a suitable reactive medium also may require some effort, especially if a medium other than the more common variety of granular iron is used. Procurement of a suitable construction contractor is a key activity that may take a few weeks, especially if

construction techniques other than standard backhoe excavation are needed. Most contractors are capable of conducting backhoe excavation (for the gate or for a continuous reactive barrier) and slurry wall construction (for the funnel, if required). Any other construction technique may involve a limited number of contractors, and extensive review both of different construction options offered by different vendors, and of the technical suitability and cost of these options for a given site. Generally, relatively deep aquifers (more than 30 ft deep) require evaluation of special alternative methods of construction (see Section 7.0). Even for relatively shallow aquifers, new technologies such as the continuous trencher (Section 7.1.4) should be considered as a way of reducing costs, if technically feasible. A site visit should be arranged before receiving final bids to provide interested construction contractors an opportunity to see the site and talk to site personnel. Construction contractors may identify unusual site features (e.g., site access or overhead utilities) that could make construction more difficult and affect the cost of implementing their particular technologies. Once the construction contractor has been selected, a preconstruction meeting generally is required to discuss preparations and arrangements for construction. Site managers have to provide sufficient storage and working space around the PRB location, arrange for traffic diversion during construction, and/or arrange for the disposal of spoils/groundwater removed from the ground during construction.

9.1.2 PRB Materials and Construction Costs

Table 9-1 illustrates the materials and construction components of capital investment required for a PRB. The reactive medium itself can be a significant cost item. The unit cost of the reactive medium depends on the type of medium selected. Granular iron is the cheapest and most well-understood of the currently available reactive metal media, and therefore has been preferred for most PRB applications so far. Although initial field applications are reported to have paid up to \$650/ton for the granular iron, identification of additional sources has reduced the unit cost of iron available to approximately \$300-350/ton. At least three suppliers of granular iron in the desired form are available. If the selected reactive medium is patented, licensing costs may be involved.

The total cost of the reactive medium is driven not only by the unit cost of the reactive metal, but also by the amount of reactive metal required. The amount of reactive metal required depends on the following site-specific factors:

- ❑ **Type and Concentrations of the Chlorinated Contaminants.** Contaminants that have longer half-lives require a larger flowthrough thickness of the reactive cell, and therefore higher cost.
- ❑ **Regulatory Treatment Criteria.** The more stringent the treatment criteria that the PRB has to meet, the greater is the required residence time; and the greater the residence time, the greater is the required thickness of the reactive cell, which increases the cost accordingly.
- ❑ **Groundwater Velocity.** The higher the groundwater velocity, the greater the thickness of the reactive cell required to obtain a certain residence time, which increases the cost accordingly.

- ❑ **Groundwater Flow and Contaminant Distribution.** At sites where the distribution of groundwater flow or contaminants is very heterogeneous, a continuous reactive barrier of uniform thickness and extent can lead to an inefficient use of reactive medium. Construction of the reactive cell in zones of higher permeability or the use of funnel-and-gate configurations and pea gravel-lined cells are some of the ways in which the contaminant loading on the reactive medium may be made more homogeneous. On the other hand, continuous reactive barriers are easier to design and build, and they generate less complex hydraulic flow patterns.

The unit costs of construction depend on the type of technique selected, which, in turn, depends on the depth of the installation. Table 7-1 (in Section 7.0) summarizes the construction techniques available, the maximum depth possible for each technique, and some representative unit costs obtained from several geotechnical contractors. Although some variability in the cost of each technique represents differences in vendors, the range of unit costs is more likely driven by depth. The total cost of construction is based on three main factors:

- ❑ **Plume and Aquifer Depth.** For a given construction technique, the upper part of the cost range generally applies to the greater depths in its range.
- ❑ **Plume Width.** The greater the width of the plume, the wider the PRB is required to be in order to capture it.
- ❑ **Geotechnical Considerations.** The presence of rocks or highly consolidated sediments, underground/overhead utilities, or other structures in the vicinity may make it harder to drive the construction equipment (e.g., sheet piles or caissons) into the ground.

Given the cost difference between the construction techniques for a funnel versus those for a reactive cell in Table 7-1 (Section 7.0), there may be a cost trade-off between selecting a funnel-and-gate system versus a continuous reactive barrier. Disposal of spoils generated during construction is another cost that may vary based on the construction technique selected. For example, construction of slurry walls generates more spoils than does construction of sheet pile barriers. Disposal of spoils could be more costly if the barrier must be located within the plume, in which case the spoils may have to be disposed of as hazardous waste. Restoration of the site surface may include returning it to grade or repaving the surface for built-up sites.

Monitoring wells are a cost component for both PRB and P&T options. The number and distribution of monitoring wells generally is determined by regulatory guidance and the need to collect performance data (see Section 8.0 on monitoring).

9.1.3 Capital Investment for an Equivalent P&T System

The materials and construction components required for a P&T system generally include extraction wells, pumps, piping and instrumentation, an air stripper (for VOCs) or ion exchange unit (for metallic contaminants), a carbon polishing unit for the liquid effluent, and an air treatment unit (if the air discharge from the stripper exceeds local regulatory limits for a point source). In recent years, low-profile (tray type) air strippers have been used as a cheaper and less space-consuming (higher capacity) alternative to bulkier packed towers for VOC treatment. In

general, a P&T system comparable to the PRB described in this subsection would have to capture the same volume of groundwater as the full-scale PRB. Because of possible capture inefficiencies with extraction wells, the P&T system may generally be designed to capture groundwater from an aquifer region larger than the extent of the plume.

9.2 Operating and Maintenance Costs

The O&M costs of a technology are the recurring or periodic costs incurred during the operating life of the system. Using the PRB at Dover AFB as an example, the O&M cost components of a PRB are illustrated in Table 9-2.

Table 9-2. Illustration for Estimating O&M Costs Based on the Projections for Operating a Full-Scale PRB at Dover AFB

| Item | Description | Basis | Cost |
|--|---|--|------------------|
| <i>Annual Monitoring Activities</i> | | | |
| Groundwater sampling | Quarterly, labor, materials, travel | 40 wells | \$80,000 |
| CVOC analysis | Quarterly, 40 wells | 44 per quarter @ \$120/sample | \$20,000 |
| Inorganic analysis | Annual, 20 wells | 22 @ \$200/sample | \$4,000 |
| Water-level survey | Quarterly, labor | 40 wells per quarter | \$4,000 |
| Data analysis; report; regulatory review | Quarterly, labor | 4 times per year | \$40,000 |
| Annual operating cost | | | \$148,000 |
| <i>Maintenance Activities (once every 10 years assumed)</i> | | | |
| Site preparation | Permitting, clearances | Labor | \$10,000 |
| Reactive media procurement | Connelly iron, shipping | Iron: 108 tons @ \$360/ton Shipping: \$9,000 | \$48,000 |
| Removal/replace-ment of gates | Mobilization/demobilization; installation of four 8-ft-diameter caisson gates to 39-ft depth; asphalt parking lot restoration | Mob./demob.: \$38,000 Gates: \$266,000 Monitoring wells: \$25,000 Surface restoration: \$34,000 | \$363,000 |
| Periodic maintenance cost (once every 10 years assumed) | | | \$421,000 |

- ❑ **Contaminant Monitoring Costs.** These costs may vary from site to site depending on regulatory requirements, number of monitoring wells, and frequency of sampling. These costs include sampling, laboratory analysis, and reporting.
- ❑ **Performance Monitoring Costs.** If additional monitoring is desired by site managers to achieve other performance evaluation objectives (see Section 8.2), additional monitoring costs may be incurred. These costs will vary depending on the objectives of site managers at a given site.
- ❑ **Periodic Maintenance Costs.** Maintenance may be required if inorganic precipitates build up to a point where either the reactivity or the hydraulic conductivity of the reactive cell is significantly affected. The reactive medium may have to be regenerated or replaced. Table 9-2 assumes that the reactive medium in the gates will be

removed and replaced every 30 years. Another alternative that has been mentioned is to install a second PRB near the first one after the reactive medium in the first PRB is exhausted. Any of these regeneration/replacement options are likely to be relatively expensive and the expectation from the PRB technology is that such maintenance will be infrequent. Although various rules-of-thumb have been proposed in the past, the best approach may be to develop multiple economic scenarios, as described in Section 9.3, to assess the impact of the longevity of the reactive medium on the economic suitability of the PRB.

The O&M costs of a P&T system include operating labor, energy, and maintenance. The labor and energy requirements for operating the P&T system are a major driver of O&M cost. In addition to this recurring operating cost, a P&T system often requires frequent maintenance to replace moving parts, replace the carbon in a carbon polishing unit, or replace the catalyst in a catalytic oxidation unit. Appendix B contains an example of the O&M costs estimated for a PRB and a P&T system for a CVOC plume at Dover AFB.

9.3 Present Value Analysis

Although this may not be the case at every site, the P&T system at Dover AFB (see Appendix B) was estimated to require a lower initial capital investment as compared to the PRB. On the other hand, the P&T system has higher O&M costs, primarily because of the recurring annual labor and energy requirements to operate the P&T system (Battelle, 2000). The P&T system requires more frequent routine maintenance (e.g., replacement of pumps and seals) and periodic maintenance in the form of carbon and catalyst replacement. Because the PRB and P&T system require maintenance at different points in time and because the contamination (and the associated operating/monitoring costs) is expected to last for several years or decades, a PV analysis is required to consolidate the capital investment and long-term O&M costs into a total long-term cost in today's dollars.

Typically, PV or discounted cashflow analysis is used to determine the life cycle cost of a technology. PV cost represents the amount of money that would have to be set aside today to cover all the capital investment and O&M costs occurring in the present and future.

$$PV_{\text{technology}} = \text{Capital Investment} + PV_{\text{annual O\&M costs over life of the new technology}} \quad (9-1)$$

In the above equation, capital investment does not have to be discounted back to the present because this investment occurs immediately (time $t=0$). The term $PV_{\text{annual O\&M costs over life of the new technology}}$ represents the annual O&M costs (and savings realized, if any) over several years of operation, adjusted for the time value of money. This adjustment is done by dividing each year's O&M costs by a factor that incorporates a discount rate (r), as shown in Equations 9-2 and 9-3. The discount rate incorporates the combined effect of inflation, productivity, and risk. In other words, the discount rate accounts for the fact that any cost postponed into future years frees up money which can be put to productive use and which provides a rate of return equal to the discount rate (r).

$$PV_{\text{annual O\&M costs}} = \sum \frac{\text{O \& M cost in Year } t}{(1+r)^t} \quad (9-2)$$

$$PV_{\text{annual O\&M costs}} = \frac{\text{O \& M cost in Year 1}}{(1+r)^1} + \frac{\text{O \& M cost in Year 2}}{(1+r)^2} + \dots + \frac{\text{O \& M cost in Year n}}{(1+r)^n} \quad (9-3)$$

Another way of interpreting Equation 9-3 is that, because O&M costs are incurred gradually over several years, a smaller amount of money can be set aside today (for example, in a bank deposit that provides a rate of return, *r*) to cover future O&M costs. The further into the future (i.e., the greater the *t*), the greater is the denominator for the relevant *t*, and the lesser is the PV of that year's O&M cost. That is, fewer dollars must be set aside today (in a separate investment that provides a rate of return, *r*) to cover the O&M costs of the future. Herein lies the potential advantage of a PRB over a P&T system: whereas P&T systems incur a continuous O&M cost for labor, maintenance, and energy requirements, O&M costs for a PRB are postponed until the reactive medium performance starts declining. Indications from existing PRBs are that these PRBs could operate without any O&M costs for several years. Note that both P&T systems and PRBs require routine monitoring to verify regulatory compliance; this is the only recurring annual cost for the PRB.

A total time period of 30 years (*n* = 30) typically is used for the long-term evaluation of remediation costs. A real discount rate of 2.9% is currently recommended in the PV analysis, as per the 1999 update to the U.S. EPA Office of Management and Budget (OMB) circular (U.S. EPA, 1993).

Table 9-3 illustrates the PV analysis based on the projections for a full-scale PRB at Dover AFB (Battelle, 2000) and the estimated cost for an equivalent P&T system, over a 30-year period (see Appendix B for details). In this illustration, it is assumed that the PRB will maintain its reactivity and hydraulic performance over 10 years of operation, after which time the reactive medium in the four gates will have to be removed and replaced. An initial capital investment of \$947,000 is estimated for the PRB and \$502,000 for an equivalent P&T system to capture and treat a 100-ft-wide CVOC plume. The O&M cost of the PRB in Year 10 includes the annual monitoring cost of \$148,000, plus the reactive medium replacement cost of \$421,000 (cost to remove and re-install four gates containing iron). The P&T system incurs an annual O&M cost of \$214,000, except in years that require periodic maintenance to replace the polishing carbon and/or the catalyst in the effluent air oxidizer. The PVs of the capital investment and annual O&M costs are listed in columns 2 and 5 of Table 9-3 (for the PRB and P&T system, respectively), and indicate that the further back in time that the cost occurs, the lower is its PV. Columns 3 and 6 list the cumulative PV at the end of each year; the cumulative PV includes the capital investment and the PV of all the O&M costs up to that year. The year in which the cumulative PV cost of the PRB is equal to or below cumulative PV cost of the P&T system is the payback period or break-even point for the PRB.

As shown in Table 9-3, there are two potential break-even times for the PRB (indicated by the shaded cells in the table). In Year 8, the cumulative or total PV cost of the PRB is lower than the PV cost of the P&T system, indicating the first potential break-even point. However, in Year 10, the nonroutine maintenance cost of replacing the iron in the four gates is incurred, which makes the total cost of the PRB slightly higher again than the P&T system. In Year 14, the total PV cost of the PRB again becomes lower, and this is the true break-even point. In other words, over

**Table 9-3. Illustration of a PV Analysis of PRB and P&T Systems for Dover AFB
Assuming 10-Year Life of PRB**

| Year | PRB | | | P&T System | | |
|------|--------------------------------|----------------------------------|---|----------------------------|----------------------------------|---|
| | Annual Cost ^(a) | PV of Annual Cost ^(b) | Cumulative PV of Annual Cost ^(c) | Annual Cost ^(a) | PV of Annual Cost ^(b) | Cumulative PV of Annual Cost ^(c) |
| 0 | \$947,000 ^(d) | \$947,000 | \$947,000 | \$502,000 ^(d) | \$502,000 | \$502,000 |
| 1 | \$148,000 ^(e) | \$143,829 | \$1,090,829 | \$214,000 ^(e) | \$207,969 | \$709,969 |
| 2 | \$148,000 | \$139,775 | \$1,230,604 | \$214,000 | \$202,108 | \$912,077 |
| 3 | \$148,000 | \$135,836 | \$1,366,441 | \$214,000 | \$196,412 | \$1,108,489 |
| 4 | \$148,000 | \$132,008 | \$1,498,449 | \$214,000 | \$190,876 | \$1,299,365 |
| 5 | \$148,000 | \$128,288 | \$1,626,736 | \$235,000 | \$203,700 | \$1,503,065 |
| 6 | \$148,000 | \$124,672 | \$1,751,408 | \$214,000 | \$180,269 | \$1,683,334 |
| 7 | \$148,000 | \$121,159 | \$1,872,567 | \$214,000 | \$175,189 | \$1,858,523 |
| 8 | \$148,000 | \$117,744 | \$1,990,311 | \$214,000 | \$170,251 | \$2,028,774 |
| 9 | \$148,000 | \$114,426 | \$2,104,737 | \$214,000 | \$165,453 | \$2,194,228 |
| 10 | \$569,000^(f) | \$427,522 | \$2,532,259 | \$242,000 | \$181,828 | \$2,376,056 |
| 11 | \$148,000 | \$108,067 | \$2,640,326 | \$214,000 | \$156,259 | \$2,532,315 |
| 12 | \$148,000 | \$105,021 | \$2,745,347 | \$214,000 | \$151,855 | \$2,684,170 |
| 13 | \$148,000 | \$102,061 | \$2,847,408 | \$214,000 | \$147,575 | \$2,831,745 |
| 14 | \$148,000 | \$99,185 | \$2,946,593 | \$214,000 | \$143,416 | \$2,975,162 |
| 15 | \$148,000 | \$96,390 | \$3,042,983 | \$235,000 | \$153,051 | \$3,128,213 |
| 16 | \$148,000 | \$93,673 | \$3,136,656 | \$214,000 | \$135,446 | \$3,263,659 |
| 17 | \$148,000 | \$91,033 | \$3,227,690 | \$214,000 | \$131,629 | \$3,395,289 |
| 18 | \$148,000 | \$88,468 | \$3,316,158 | \$214,000 | \$127,920 | \$3,523,208 |
| 19 | \$148,000 | \$85,974 | \$3,402,132 | \$214,000 | \$124,314 | \$3,647,523 |
| 20 | \$569,000^(f) | \$321,222 | \$3,723,354 | \$242,000 | \$136,618 | \$3,784,141 |
| 21 | \$148,000 | \$81,197 | \$3,804,550 | \$242,000 | \$132,768 | \$3,916,908 |
| 22 | \$148,000 | \$78,908 | \$3,883,459 | \$214,000 | \$114,097 | \$4,031,006 |
| 23 | \$148,000 | \$76,685 | \$3,960,143 | \$214,000 | \$110,882 | \$4,141,887 |
| 24 | \$148,000 | \$74,523 | \$4,034,667 | \$214,000 | \$107,757 | \$4,249,644 |
| 25 | \$148,000 | \$72,423 | \$4,107,090 | \$235,000 | \$114,996 | \$4,364,641 |
| 26 | \$148,000 | \$70,382 | \$4,177,472 | \$214,000 | \$101,769 | \$4,466,409 |
| 27 | \$148,000 | \$68,399 | \$4,245,871 | \$214,000 | \$98,901 | \$4,565,310 |
| 28 | \$148,000 | \$66,471 | \$4,312,341 | \$214,000 | \$96,113 | \$4,661,423 |
| 29 | \$148,000 | \$64,598 | \$4,376,939 | \$214,000 | \$93,405 | \$4,754,827 |
| 30 | \$569,000^(f) | \$241,352 | \$4,618,291 | \$242,000 | \$102,649 | \$4,857,476 |

- (a) Annual cost is equal to the capital investment in Year 0 and the O&M cost in subsequent years.
- (b) PV cost is the annual cost divided by a discount factor term based on a 2.9% discount rate.
- (c) Cumulative PV cost is the sum of annual PV costs in each year and previous years.
- (d) Initial capital investment.
- (e) Annual O&M cost.
- (f) Annual monitoring cost of \$148,000, plus maintenance/replacement of gates for \$421,000.

14 years, the lower annual operating cost (passive operation) of this PRB makes it a worthwhile investment. At the end of the analysis period of 30 years, the PV of the total savings from implementing a PRB versus a P&T system in this illustration is \$239,000 (that is, the difference between the cumulative costs of \$4,618,291 and \$4,857,476 for the PRB and P&T system at the

end of 30 years). If the plume persists for 50 or more years, the estimated savings will be even greater, as seen in Table 9-4.

Because the break-even point is sensitive to the assumption on the life of the PRB, the PV analysis shown in Table 9-3 can be repeated assuming that the life of the reactive medium is 5, 10, 20, and 30 years (see Tables B-8 to B-11 in Appendix B). Table 9-4 summarizes the results of running these longevity scenarios. The same longevity scenarios can be represented pictorially as shown in Figure 9-1. As seen in Table 9-4 and Figure 9-1, if the reactive medium lasts only 5 years, and the gates must be replaced every 5 years, then the P&T system is less expensive (i.e., there is no break-even point because the PV cost of the PRB is always higher than the PV cost of the P&T system). If the PRB lasts at least 10 years, it is less expensive than a P&T system. The longer the reactive medium performance lasts, the greater are the savings at the end of 30+ years. The longer the duration of the project (that is, the longer the plume persists at the site), the greater are the potential savings. In Table 9-4, when the project duration increases to 50 years, the potential savings realized are greater than \$1 million (see Table B-12 in Appendix B).

Table 9-4. Illustration of the Break-Even Point and Savings by Using a PRB Instead of a P&T System at Dover AFB

| Life of Reactive Medium | Break-Even Point | PV of Savings Over the Duration of the Project | Duration of Project |
|-------------------------|------------------|--|---------------------|
| 5 | None | -\$603,000 | 30 years |
| 10 years | 14 years | \$239,000 | 30 years |
| 20 years | 8 years | \$734,000 | 30 years |
| 30 years | 8 years | \$793,000 | 30 years |
| 30 years | 8 years | \$1,251,000 | 50 years |

These same simulations are described graphically in Figure 9-1. In this figure, the break-even point is the point at which the two lines (solid line for PRB cost and dashed line for P&T cost) intersect. When periodic maintenance (replacement of iron) is required every 5 years, the PRB cost is always greater than the P&T cost, as indicated by the fact that the two lines do not intersect. If the reactive medium lasts 10 years or longer without replacement, there is a break-even point.

The estimated saving or cost advantage of using a PRB at Dover AFB, although substantial over a long period of time, is not as great as that reported at some other sites. One reason for the cost difference is that in many previous studies, higher discount rates (8 to 15%) have been used. For example, using a discount rate of 8%, the PV of the savings for the PRB at former NAS Moffett Field was estimated at \$14 million after 30 years (Battelle, 1998). However, the PV estimate for the PRB at Dover AFB is calculated with a much lower discount rate of 2.9%, which is based on the most recent (1999) update to the U.S. EPA guidance (U.S. EPA, 1993). This year's low discount rate reflects the current low-inflation environment of the U.S. economy. In a low-inflation (low-discount rate) environment, future savings appear to be less attractive than in a high-inflation (high-discount rate) environment.

At many sites, a continuous reactive barrier (no funnel) may be more economical than a funnel-and-gate system, especially for relatively shallow PRBs that can be installed with cost-effective techniques such as continuous trenching. Innovative construction techniques, such as jetting and hydrofracturing, offer the potential for additional cost reduction in deeper aquifers.

In the absence of reasonably accurate predictions of the life of the reactive medium, the multiple longevity scenarios shown in Table 9-4 provide a way of understanding the performance expectations of the reactive medium. In the example in Table 9-4, indications are that the PRB at this site would have to retain its reactive and hydraulic performance for at least 10 years, before the long-term O&M savings realized are large enough to offset the higher initial capital invested in the PRB (as compared to a P&T system). At other sites, the break-even point for the PRB may occur in earlier or later years, depending on the differences in capital investment and O&M costs between a PRB and a competing technology (such as P&T).

9.4 Cost-Benefit Evaluation

The cost analysis in Section 9.3 takes into account only the more tangible costs (and savings) of the two groundwater treatment options (PRB and P&T system). An economic decision on which of the two technologies to adopt should be based on a cost-benefit analysis that includes less tangible and/or intangible costs and benefits of the two technologies. An example of a less tangible benefit of the PRB is continued productive use of the PRB site because of the absence of above-ground structures (as in a P&T system). For example, at Dover AFB and former NAS Moffett Field, the sites are still being used as parking lots. It is difficult to assign a dollar value to this benefit; however, it is a benefit that adds to the savings realized by implementing a PRB instead of a P&T system. At the private Intersil site in California, site owners were able to lease the property to a new tenant because of the absence of aboveground structures and lack of O&M requirements besides monitoring (Yamane et al., 1995). In addition, PRBs are not prone to the high down time and labor/maintenance/waste disposal requirements of a P&T system.

9.5 Computerized Cost Models

The Remedial Action Cost Engineering and Requirements (RACER) System is an environmental costing program developed by the U.S. Air Force. It can estimate costs for various phases of a remediation project:

- ❑ Site characterization studies
- ❑ Remedial action (including O&M activities)
- ❑ Site work and utilities.

The program's framework is based on actual engineering solutions gathered from historical project information, construction management companies, government laboratories, vendors, and contractors. It is designed to factor in specific project conditions and requirements based on minimal user input in order to generate a cost estimate. RACER Version 3.2 has a cost database created mostly from the U.S. Army Corps of Engineers' Unit Price Book and supplemented by vendor and contractor quotes. Version 3.2 has been adapted especially for PRB applications.

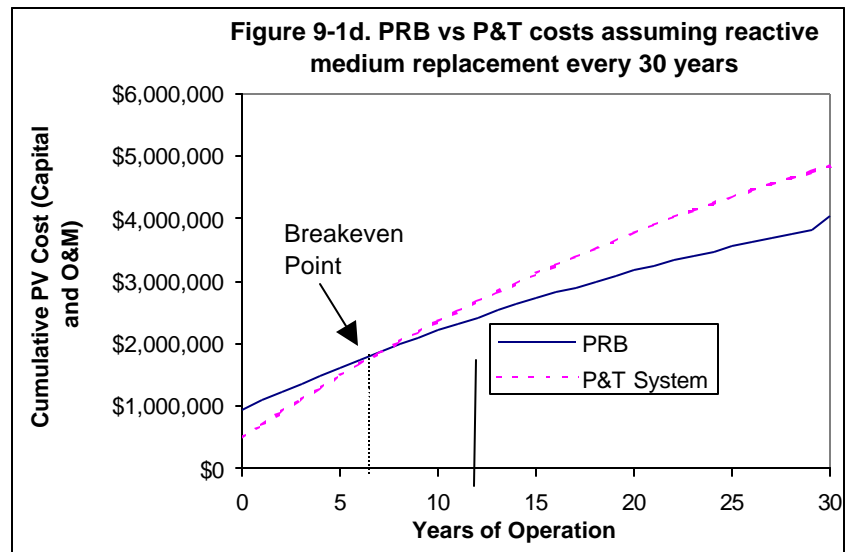
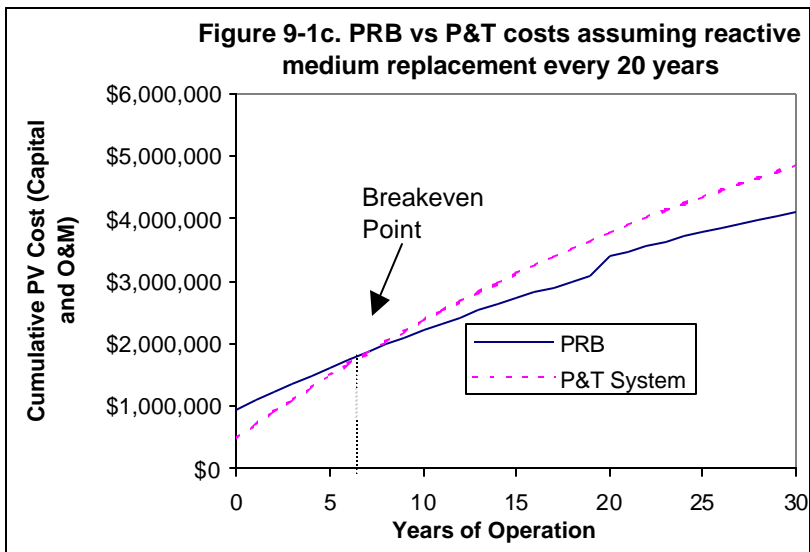
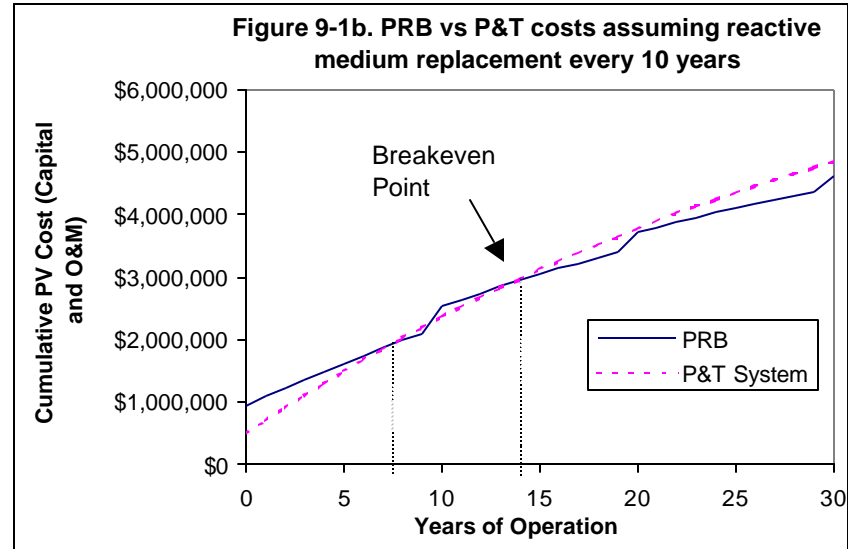
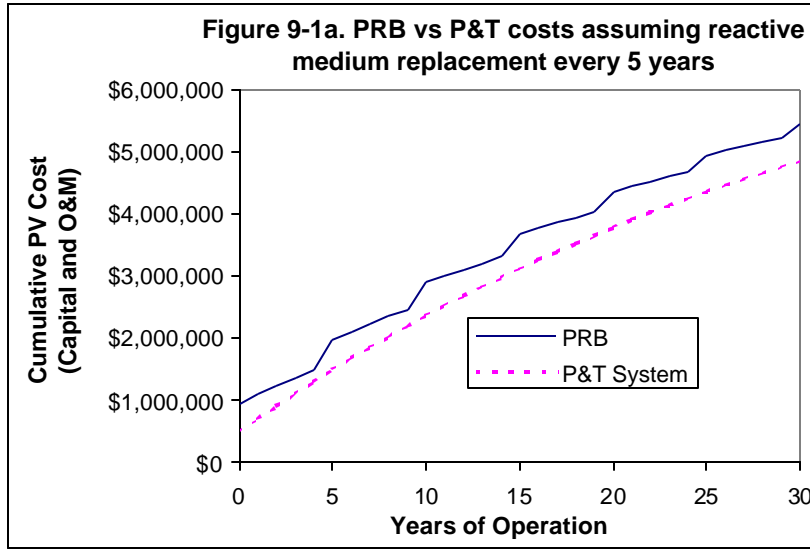

Figure 9-1. Illustration of How Break-Even Point or Payback Period Varies with Expected Life of the Reactive Medium

10.0 Current Status of the PRB Technology

This section reviews the technical, economic, and regulatory experience at various sites where the PRB technology has been applied.

10.1 Existing PRB Applications

Tables 10-1 and 10-2 (which appear at the end of this section) summarize the site characteristics, PRB features, and monitoring updates at the sites where PRBs have been applied. Although the lists are not exhaustive, these sites offer a good distribution of contaminants, reactive media, hydrogeologic characteristics, PRB configurations and dimensions, construction methods, and costs. Some noteworthy trends in these applications are listed below:

- ❑ To date, most of the PRBs have used granular iron medium and have been applied to address CVOC contaminants. CVOC degradation by iron has been demonstrated at several sites. The tendency of CVOCs to persist in the environment for several years or decades makes them an obvious target for a passive technology.
- ❑ Metals amenable to precipitation, under the reducing conditions created by the common iron medium, have been the next most common targets. Examples of these metals include hexavalent chromium and uranium. One concern is that, unlike CVOCs, metals do not degrade but instead accumulate in the reactive medium. At some point in time, the reactive medium (containing the precipitated metals) may have to be removed and disposed of. With CVOCs, even after the PRB performance has declined, it is possible that the reactive medium can just be left in the ground.
- ❑ Although many initial applications were pilot-scale PRBs, most recent applications have been full scale, indicating that confidence in this technology has grown.
- ❑ At many sites, the target cleanup levels have been MCLs. At some sites, state/local regulations have required more stringent cleanup levels for some contaminants, such as VC.
- ❑ At sites where target cleanup levels have not been achieved in the downgradient aquifer, the reason has generally been the inability of the PRB to achieve the designed plume capture or residence time, rather than the inability of the reactive medium to replicate laboratory-measured reactivity (contaminant half-lives) in the field. Inadequate hydraulic capture and/or inadequate residence time has been observed at some sites with either funnel-and-gate systems (Denver Federal Center and former NAS Alameda) or continuous reactive barriers (DOE Kansas City Plant). At one site (former NAS Alameda), plume heterogeneities appear to have contributed to higher-than-expected contaminant concentrations at the influent to and effluent from the reactive cell (Einarson et al., 2000).

- ❑ PRBs have been applied at sites with groundwater velocities (in the aquifer) reported at 0.0003 to 2.8 ft/day. No monitoring data are available for the two sites that represent the extreme ends of the range. Although 2.8 ft/day is a velocity that could be handled with a reasonable thickness of the reactive cell, it is unclear how efficiently the groundwater moving at 0.0003 ft/day would passively contact the reactive medium.
- ❑ Although most PRB applications used iron as the reactive medium during the initial use of this technology, the use of other innovative media has been investigated in recent years at some sites.
- ❑ More of the recent applications have been configured as continuous reactive barriers rather than funnel-and-gate systems. One reason for this is that the unit cost of iron medium has declined from \$650/ton to about \$300/ton, plus shipping and handling. Although, in theory, the same amount of iron should be required for a given mass of plume contaminants, the heterogeneous distribution of the contaminant concentrations in the plume makes the amount of iron required in a uniformly thick continuous reactive barrier somewhat inefficient. However, the lower cost of iron and other benefits make continuous reactive barriers more attractive. Benefits of continuous reactive barriers include easier design and construction, and a propensity to generate less complex flow patterns.
- ❑ Although initial use of this technology involved conventional construction techniques (such as backhoe excavation, sheet pile, and/or slurry wall), innovative construction techniques (such as caissons, continuous trenching, jetting, and hydrofracturing) are being explored at more recent PRB sites. These techniques offer the potential to access greater depths with lower construction costs.

Additional information and updates on some of these PRB sites can be obtained from the RTDF Web site at www.rtdf.com.

10.2 Guidance from Government Agencies

In an effort to promote more regular consideration of newer, less costly, and more effective technologies to address the problems associated with hazardous waste sites, the U.S. EPA has published six In Situ Remediation Technology Status Reports, one of which deals with PRBs (U.S. EPA, 1995). This Technology Status Report briefly describes demonstrations, field applications, and research on PRBs. A more detailed report by the U.S. EPA on PRB technology application also is available (U.S. EPA, 1998). As shown in Table 10-2, federal drinking water standards or MCLs have been the cleanup targets at many sites. However, at some sites, state environmental agencies have imposed more stringent cleanup goals for individual compounds, such as VC.

In addition to these federal government efforts, individual states have formed the ITRC group to build a consensus among the states on regulatory issues surrounding innovative remediation technologies. The ITRC has formed a PRBs subgroup. This subgroup first convened at a meeting in Philadelphia on September 25, 1996, and includes members from environmental regulatory agencies in 29 states, as well as other interested parties such as environmental groups, the

U.S. military, industry, and environmental consulting firms. The subgroup has developed consensus documents for the states that enhance the regulatory acceptance of the PRB technology and provide guidance on compliance monitoring requirements (ITRC, 1997 and 1999). Although these documents represent a general regulatory consensus on PRBs, individual states may decide to add on their own specific requirements.

At many existing PRB sites to date, regulatory requirements for design, construction, and monitoring have been determined on a case-by-case basis, under the general guidance of the ITRC documents. Regulatory agencies suggest that for a prospective site there should be (1) compelling reasons why a PRB is the best choice for that site and (2) data to show why the PRB is expected to work as planned. As field data from a growing number of PRB applications becomes available, acceptance of this technology by regulators is expected to increase.

Intersil, the site in Sunnyvale, CA that implemented the first full-scale PRB application, was in many ways an ideal situation from a technical feasibility and regulatory viewpoint. It was an underutilized property, was run by a cooperative potentially responsible party (PRP), and posed no excessive human health threat. Furthermore, it had shallow groundwater, poor (brackish) water quality, a competent aquitard, and a relatively shallow aquifer. A pilot study conducted at the site showed that the PRB would work and that the total cost was estimated as half that of a P&T system over 30 years (Kilfe, 1996). The cost analysis for this site assumed that the iron medium would not require replacement and included the benefit of being able to lease the property, an option that was enabled by the passive long-term nature of the technology. Although the plume had moved off the property at Intersil, regulators allowed placement of the PRB within property lines based on indications that natural attenuation of the chlorinated contaminants, which was occurring downgradient, would take care of the off-site portion of the plume.

Other sites may be more difficult from an application viewpoint. At one potential site where a full-scale PRB was being considered, the approval process was made difficult by the fact that there is already a ROD with 30 signatories (PRPs) in place for installing a P&T system to clean up a regional plume. Obtaining a consensus for modifying the ROD with 30 PRPs proved difficult. Another difficulty that could be encountered is if the plume has moved off the property and the PRB needs to be installed outside the property boundaries; obtaining site access when the prospective site is beyond the property boundary may be difficult.

One important trend is that regulators are increasingly open to discussion of cleanup costs. There is a growing willingness in the regulatory community to consider cost an important factor in selecting alternatives for cleanup. If a significant benefit-to-cost ratio can be shown for the PRB versus a P&T system (or any other competing technology), it would be a considerable factor in favor of a PRB. It is recommended that site managers confer with regulators as early as possible in the design stage to promote better understanding of the technical, cost, and regulatory concerns of all stakeholders.

10.3 Future Challenges for the PRB Technology

As shown in Table 10-2, for many CVOC contaminants, the most common target for PRB applications so far, the ability of granular iron medium to degrade the contaminants to MCLs has been adequately demonstrated at several different sites (Battelle, 1998 and 2000; Blowes et al., 1997;

Yamane et al., 1995; U.S. EPA, 1998). Demonstrating the reactive capabilities of granular iron with CVOC plumes is now a fairly routine matter that can be addressed by suitable column tests. As common reactive media (e.g., granular iron) are increasingly standardized by various suppliers, and these media are applied at multiple sites for common contaminants (such as TCE), it may be possible to forgo many features of treatability testing (column tests) in favor of published contaminant half-life values with appropriate safety factors. Proceeding with PRB application without site-specific treatability tests for some common contaminants would have to be approved by the concerned regulators. In general, site-specific treatability tests are helpful, especially if the groundwater exhibits unusual geochemistry (e.g., high levels of DOC, nitrate, or alkalinity) or the construction method involves mixing of the reactive medium with another material (e.g., biodegradable slurry).

Three key technical factors – plume capture, residence time, and geochemistry (longevity) – are the main challenges that need to be addressed in designing a PRB. A PRB should be designed to provide the required plume capture and sufficient residence time in the reactive medium to degrade the contaminants to target levels at a particular site. Also, on a long-term basis, the reactive medium-groundwater geochemistry should be suitable for sustaining the reactive and hydraulic performance of the PRB over long periods of time. For non-CVOC contaminants (e.g., RCRA metals and/or radionuclides) and reactive media other than the commonly-used granular iron, demonstrating the reactive capabilities of the PRB-groundwater system with treatability tests on a site-specific basis is still important because of the limited history of PRBs.

There are two reasons why hydraulic issues (plume capture and residence time) pose a design challenge. First, site characterization conducted at some sites may not be adequate to obtain a good understanding of the hydraulic flow characteristics of the site. Second, even at sites which have undergone substantial characterization, hydrogeologic heterogeneities (variability in gradients and conductivities), plume heterogeneities (variability in contaminant concentrations), and seasonal variability in flow magnitude and direction can pose a challenge for PRB design. To address these hydraulic issues, the authors of this document recommend that technology users conduct adequate site characterization, simulate multiple groundwater flow scenarios, and incorporate adequate safety factors in the design dimensions and orientation of the PRB.

Assessing longevity, or the ability of the reactive medium to sustain the reactive and hydraulic performance of the PRB over time, also is a challenge. Although much progress has been made at several sites in using inorganic analysis of groundwater, iron coring, and geochemical modeling to evaluate precipitation potential in the reactive medium, predicting the life of the reactive medium has proved difficult. In the absence of reasonable estimates of the life of the reactive medium, the authors of this document recommend the use of multiple longevity scenarios (see Section 9.3) to evaluate the cost/savings expectations from a PRB application.

An interagency initiative supported by several government agencies, including DoD, DOE, U.S. EPA, and ITRC, is making an effort to address the three issues of plume capture, residence time, and longevity (Battelle, 1999). The DoD effort, funded by Strategic Environmental Research and Development Program/Environmental Security Technology Certification Program (SERDP/ESTCP), is being led by the Naval Facilities Engineering Service Center (NFESC) and Battelle, with AFRL, ITRC, the U.S. Army Corps of Engineers, and the U.S. Air Force Center for

Environmental Excellence as partners. Field data from several PRBs at DoD sites are being reviewed and supplemented with additional focused monitoring, where required, to address the three important issues discussed above. ORNL (for U.S. DOE) and the U.S. EPA are conducting similar efforts with the PRBs at DOE and U.S. EPA sites.

Innovative PRB construction techniques that do not involve trenching (e.g., jetting and hydraulic fracturing) are being demonstrated at various sites. As more field data from these demonstrations are published, and as the ability of these techniques to ensure the desired continuity and thickness of the reactive cell is verified, depth may no longer be a significant limitation for the PRB technology. This improvement is expected to increase the applicability of the technology.

Table 10-1. Update on Design, Construction, and Cost of PRBs

| PRB Site | PRB Type | Depth to Aquitard (ft bgs) | Reactive Cell Thickness (ft) | Amount of Reactive Medium (tons) | Gate or CRB Width (ft) | Funnel Width (ft) | Gate or CRB Construction Method | Funnel Construction Method | PRB Cost |
|--|---------------------|----------------------------|------------------------------|----------------------------------|--|-------------------|---|----------------------------|--|
| Elizabeth City, NJ | CRB | 25 ^(a) | 2 | 450 | 150 | | Continuous trenching | | \$500,000 total |
| DOE facility, Kansas City, MO | CRB | 30 | 6 | 666 | 130 | | Cofferdam | | \$1,300,000 total installation |
| Watervliet Arsenal, NY | CRB with 2 trenches | 10-15 | 2.5 | 166 | Trench A 205; Trench B 83 | | Trench box | | \$257,000 total |
| Former manufacturing site, NJ | CRB | 15-23 | 5 | 720 | 127 | | Cofferdam | | \$725,000 installation |
| Seneca Army depot activity, NY | CRB | 8 to 10 | 1 | 203 | 650 | | Continuous trenching | | \$250,000 iron and construction |
| Industrial site, SC | CRB | | 1 | 400 | 325 | | Continuous trenching | | \$350,000 installation |
| Caldwell Trucking, NJ | CRB with 2 trenches | | 0.25 | 250 | 150 and 90 | | Vertical hydraulic fracturing technique | | \$670,000 for 90 ft and \$450,000 for 150 ft |
| Private electronics firm, Mountainview, CA | CRB | | | 90 | | | | | \$80,000-\$100,000 total |
| Dry cleaning site, Germany | CRB | | | 69 iron 85 iron sponge | 74 (33 granular iron & 41 iron sponge) | | Overlapping boreholes | | \$93,000 total |
| Bardowie Farm, Cambridge, NZ | CRB | | 5 | | 115 | | Continuous trenching | | |
| Massachusetts military reservation | CRB | | 0.28 | 44 | 48 | | Vertical hydraulic fracturing technique | | \$160,000 installation |

Table 10-1. Update on Design, Construction, and Cost of PRBs (Continued)

| PRB Site | PRB Type | Depth to Aquitard (ft bgs) | Reactive Cell Thickness (ft) | Amount of Reactive Medium (tons) | Gate or CRB Width (ft) | Funnel Width (ft) | Gate or CRB Construction Method | Funnel Construction Method | PRB Cost |
|--|------------------------------------|-----------------------------------|-------------------------------------|---|---|--------------------------|--|-----------------------------------|--|
| Belfast, Northern Ireland | Funnel-and-gate | | | | | 80 to 100 | In situ reaction vessel | Bentonite cement slurry walls | \$20,000 iron \$350,000 construction |
| Industrial facility, NY | Funnel-and-gate | 20 | 3.5 | 45 | 12 | 15 | Cofferdam | Sheet piling | \$30,000 iron \$250,000 construction |
| Industrial facility, NY | CRB (2 walls) | 18 | 1 | 742 | Trench A = 120 ft; trench B = 370 ft | | Continuous trenching | | \$797,000 installation |
| Intersil, Sunnyvale, CA | Funnel-and-gate | | 4 | 220 | 36 | 535 (300 and 235 gates) | Cofferdam | Cement-bentonite slurry wall | \$170,000 iron \$720,000 construction |
| Canadian Forces Base, Borden, Canada | CRB | 20 | 5 | | 5 | | Clamshell excavation, sheet pile box for shoring | | \$25,000- \$30,000 total |
| Denver Federal Center | Funnel-and-gate (with 4 gates) | 23-30 | 2 to 6 | | 160 (40 ft × 4) | 1,040 | Cofferdam | Sealable-joint sheet piling | \$1,000,000 total |
| Former NAS Moffett Field | Funnel-and-gate | 25 | 6 | 75 | 10 | 40 (20 × 2) | Backhoe excavation, sheet pile box for shoring | Sealable-joint sheet piling | \$323,000 installation |
| Somersworth Sanitary Landfill Superfund Site | Funnel-and-gate | 40 | 4 | | | 30 | Caisson | Bentonite slurry walls | \$175,000 total construction |
| Somersworth Sanitary Landfill Superfund Site | CRB | 40 | 2.3 | 100 | 21 | | Bioslurry trench | | \$175,000 construction |
| Former Lowry AFB, CO | Funnel-and-gate with angled funnel | 17 | 5 | | 10 | 28 (14 × 2) | Cofferdam | Sealable-joint sheet piling | \$530,000 installation |

Table 10-1. Update on Design, Construction, and Cost of PRBs (Continued)

| PRB Site | PRB Type | Depth to Aquitard (ft bgs) | Reactive Cell Thickness (ft) | Amount of Reactive Medium (tons) | Gate or CRB Width (ft) | Funnel Width (ft) | Gate or CRB Construction Method | Funnel Construction Method | PRB Cost |
|--|--|----------------------------|------------------------------|----------------------------------|------------------------|-------------------|---|----------------------------|---|
| Portsmouth gaseous diffusion plant, OH | Above ground | 32 | | | | | | | \$4,000,000 total |
| ORNL, TN | Funnel-and-gate | | | | | | Concrete treatment canisters | | \$1,000,000 for both barriers |
| ORNL, TN | CRB | | 2 | 80 | 26 | 225 | Continuous trenching, guar gum slurry for shoring | | \$1,000,000 for both barriers |
| East Garrington gas plant, Canada | Trench with 2 gates | | | | 6 | 290 (145 × 2) | Vertical culverts | Trench sealed with liner | \$67,200 construction |
| Fry Canyon site, UT | Funnel-and-gate with 3 barriers | | 3 | | 7 | | | | \$140,000 installation \$30,000 design |
| Private site, Tifton, GA | Funnel-and-gate | | | | | 400 | | Vibrating beam | \$520,000 construction and reactive media |
| Former NAS Alameda, CA | Funnel-and-gate; compound gate with 2 reactive cells in series | | 10 | | 15 | 20 (10 × 2) | Trench with concrete pad on bottom | | \$400,000 construction |
| Public school, Ontario, Canada | Funnel-and-gate | | 6 | | 6 | 32 (16 × 2) | | Sealable sheet pilings | \$5,000 construction |
| Tonolli Superfund Site, PA | Groundwater trench | | 3 | | 1,100 | | Continuous trench | | |

Table 10-1. Update on Design, Construction, and Cost of PRBs (Continued)

| PRB Site | PRB Type | Depth to Aquitard (ft bgs) | Reactive Cell Thickness (ft) | Amount of Reactive Medium (tons) | Gate or CRB Width (ft) | Funnel Width (ft) | Gate or CRB Construction Method | Funnel Construction Method | PRB Cost |
|-----------------------------------|---------------------------------|----------------------------|------------------------------|----------------------------------|---------------------------------|------------------------------|---|----------------------------|--|
| Nickel Rim Mine, Canada | Funnel-and-gate | | 12 | | 50 | | Cut-and-fill Technique | Coarse sand buffer zone | \$30,000 total cost |
| Aircraft maintenance facility, OR | Funnel-and-gate with 2 gates | 24 | 1.5' gate 1 and 3' gate 2 | | Gate 1, 50 ft and gate 2, 50 ft | 650 | Continuous trencher and trackhoe and drag box | Soil-bentonite slurry | \$600,000 construction |
| Industrial site, KS | Funnel-and-gate | 30 | 3 | 70 | 20 | 980 (490 × 2) | Cofferdam | Soil bentonite slurry | \$400,000 installation |
| Cape Canaveral Air Station, FL | CRB (2 walls) | 43 | 1 ft (mandrel) | 98 (mandrel) 107 JAG | 70 | 100.5 (51.5 and 49 barriers) | Mandrel and JAG emplacement | | \$279,000 mandrel system \$238,000 JAG system |
| Dover AFB, DE | Funnel-and-gate with 2 gates | 40-45 | 4 | 54 iron 5 pyrite | 8 (2 gates, 4 ft each) | 60 | Caissons | Sealable sheet piles | \$22,000 iron \$25,000 pyrite \$327,000 construction |
| Rocky Flats, Golden, CO | Collection and treatment system | 5 to 16 | | | | 230 | Gravity-fed reaction vessel | Collection trenches | |
| Manufactured gas plant, Germany | Funnel-and-gate with 2 gates | 49 | | | 79 | | | | |
| Wood-treating facility, NH | Funnel-and-gate | | | | 30 | 650 | | Sealable sheet piles | |
| 100D Area, Hanford site, WA | In situ redox manipulation | 85 | 50 | | 150 | | Injecting sodium dithionite into existing wells | | \$480,000 construction |
| Savannah River site, Aiken, SC | Geosiphon cell | | | | | | | | \$26,400 iron \$119,115 total costs |

Table 10-1. Update on Design, Construction, and Cost of PRBs (Continued)

| PRB Site | PRB Type | Depth to Aquitard (ft bgs) | Reactive Cell Thickness (ft) | Amount of Reactive Medium (tons) | Gate or CRB Width (ft) | Funnel Width (ft) | Gate or CRB Construction Method | Funnel Construction Method | PRB Cost |
|------------------------------|---|----------------------------|------------------------------|----------------------------------|---------------------------------------|-------------------|---|----------------------------|------------------------|
| DoD facility, SC | CRB | NA | 1 | | 275 (4 parallel walls 275 ft wide) | | Continuous trenching | | \$400,000 total |
| Industrial facility, LA | CRB | 23 | 1 | 616.5 | 720 | | Continuous trenching | | \$260,000 total |
| DoD facility, Warren, AFB | CRB | 28-38 | 4 | 1680 | 565 | | Trench box | | \$1,000,000 total |
| DoD facility, Pease AFB, NH | CRB | 33 | 2.5 | | 150 | | Bioslurry trench | | \$300,000 total |
| Industrial facility, MA | CRB | 17 | 2.5 | | 180 | | Sheet pile "box" | | \$420,000 total |
| Industrial facility, OH | CRB | 20 | 1 | 72 | 200 | | Open trench excavation | | \$70,000 total |
| DoD facility, Travis AFB, CA | CRB | 50 | 4-5 | 300 | 80 | | Jetting | | \$360,000 construction |
| NASA facility, LA | Granular iron placed around leaking manhole | | | 22.5 | | | Sheet pile box | | |
| Maxwell AFB, AL | CRB | 75 | 0.08-0.3 | 40 | | | Vertical hydraulic fracturing technique | | |

(a) PRB is not keyed in to aquitard.
 CRB = Continuous reactive barrier.
 JAG = Jet-assisted grouting.

Table 10-2. Update on PRB Site Characteristics and Monitoring

| PRB Site (Installation Date) | Scale of PRB | Target Contaminants | Reactive Medium | Target Cleanup Levels | Groundwater Velocity in Aquifer (ft/day) | Monitoring Update and Remarks |
|---|---------------------|--|--------------------------------|---|--|---|
| Elizabeth City, NC (June 1996) | Full ^(a) | Cr ⁺⁶ (3,430 ug/L) TCE (4,320 ug/L) <i>cis</i> -DCE (12 mg/L) VC (0.1 mg/L) | Granular iron | MCLs: Cr (50 µg/L) TCE (5 µg/L) | | MCLs met in reactive cell; plume migration below hanging PRB possible. ^(a) |
| DOE facility, Kansas City, MO (April 1998) | Full | <i>cis</i> -DCE (1,500 µg/L) VC (291 µg/L) | Granular iron | MCLs: <i>cis</i> -DCE (70 µg/L) VC (2 µg/L) | 0.025 in clay zone; 1.13 in gravel zone | Possible plume bypass around south end of PRB. MCLs met in reactive cell. |
| Watervliet Arsenal, NY (October 1998) | Full | PCE (1,100 µg/L) TCE (1,500 µg/L) <i>cis</i> -DCE (4,200 µg/L) <i>trans</i> -DCE (11 µg/L) VC (1,700 µg/L) | Granular iron and sand mixture | PCE, TCE, <i>cis</i> -DCE, <i>trans</i> -DCE (5 µg/L) VC (2 µg/L) | 0.15 | |
| Former manufacturing site, NJ (September 1998) | Full | 1,1,1-TCA (1,200 ppb) PCE (19 ppb) TCE (110 ppb) | Granular iron and sand mixture | PCE, TCE (1 µg/L) 1,1,1-TCA (30 µg/L) VC (5 µg/L) | 0.6 | |
| Seneca Army depot activity, NY (December 1998) | Full | TCE (4 to 190 µg/L) DCE (43 to 150 µg/L) | Granular iron and sand mixture | TCE, <i>cis</i> -DCE (5 µg/L) VC (2 µg/L) | 0.17 | |
| Industrial site, SC (November 1997) | Full | TCE (25 mg/L) <i>cis</i> -DCE (3.5 mg/L) VC (0.9 mg/L) | Granular iron and sand mixture | MCLs: TCE (5 µg/L) <i>cis</i> -DCE (70 µg/L) VC (2 µg/L) | 0.14 | |
| Caldwell Trucking, NJ (April 1998) | Full | TCE (6,000-8,000 µg/L) | Granular iron | 50 µg/L TCE | 1.1 | |
| Private electronics firm, Mountainview, CA | Pilot | <i>cis</i> -DCE (5-10 mg/L) TCE (1 mg/L) VC (5-50 mg/L) | Granular iron | | | |
| Drycleaning site, Germany | Full | PCE (20 mg/L) <i>cis</i> -DCE (0.5 mg/L) | Granular iron and iron sponge | | 2.8 | |
| Bardowie Farm, Cambridge, NZ | Full | Nitrate (50 mg/L) | Native soil and sawdust | | | |

Table 10-2. Update on PRB Site Characteristics and Monitoring (Continued)

| PRB Site (Installation Date) | Scale of PRB | Target Contaminants | Reactive Medium | Target Cleanup Levels | Groundwater Velocity in Aquifer (ft/day) | Monitoring Update and Remarks |
|---|-----------------|--|--|--|--|---|
| Massachusetts military reservation (June 1998) | Pilot | TCE (15 µg/L) PCE (300 µg/L) | Granular iron suspended in a guar gum slurry | MCLs: PCE, TCE (5 µg/L) | 1 | |
| Belfast, Northern Ireland (December 1995) | Full | TCE (390 mg/L) | Granular Iron | TCE (500 µg/L) | | 99.7% reduction in TCE and <i>cis</i> -DCE. Low levels (<100 µg/L) of <i>cis</i> -DCE have been detected. VC has not been detected. |
| Industrial facility, NY (May 1995) | Pilot | TCE (300 µg/L) <i>cis</i> -DCE (500 µg/L) VC (80 µg/L) | Granular iron | MCLs: TCE (5 µg/L) <i>cis</i> -DCE (70 µg/L) VC (2 µg/L) | 1 | MCLs met within 1.5 ft of travel through the reactive media |
| Industrial facility, NY (December 1997) | Full | TCE (200-1,280 µg/L) <i>cis</i> -DCE (300-1,800 µg/L) VC (26-53 µg/L) | Granular iron | MCLs: TCE, DCE (5 µg/L) VC (2 µg/L) | 0.6 | Wall constructed over top of pilot system. MCLs met in iron zone. Relic VOCs in down- gradient aquifer wells. |
| Intersil, Sunnyvale, CA (February 1995) | Full | TCE (50-200 µg/L) <i>cis</i> -DCE (450-1,000 µg/L) VC (500 µg/L) Freon [®] 113 (60 µg/L) | Granular iron | TCE (5 µg/L) <i>cis</i> -DCE (6 µg/L) VC (0.5 µg/L) Freon [®] (1,200 µg/L) | 1 | MCLs being met after 5 years of operation. |
| Canadian Forces Base, Borden, Canada | Pilot | PCE (43 mg/L) TCE (250 mg/L) | Granular iron and sand mixture | MCLs: PCE, TCE (5 µg/L) | 0.3 | 90% TCE removed and 88% PCE removed. MCLs not met. |

Table 10-2. Update on PRB Site Characteristics and Monitoring (Continued)

| PRB Site (Installation Date) | Scale of PRB | Target Contaminants | Reactive Medium | Target Cleanup Levels | Groundwater Velocity in Aquifer (ft/day) | Monitoring Update and Remarks |
|---|----------------------|--|--------------------------------|--|--|--|
| Denver Federal Center (October 1996) | Full | TCE (600 µg/L) TCA (200 µg/L) <i>cis</i> -DCE (470 µg/L) 1,1-DCE (230 µg/L) VC (15 µg/L) | Granular iron | TCA (200 µg/L) TCE (5 µg/L) <i>cis</i> -DCE (70 µg/L) 1,1-DCE (7 µg/L) VC (2 µg/L) 1,1-DCA (5 µg/L) | 0.5 | Cleanup targets met in iron, except 1,1-DCA (8 µg/L) in gate effluent. Upgradient mounding may be causing plume bypass over or around the PRB. CVOC concentrations increasing in the groundwater flowing around the south end of barrier. Also, plume potentially may be moving under the barrier. |
| Former NAS Moffett Field (April 1996) | Pilot ^(a) | TCE (1,300 µg/L) <i>cis</i> -DCE (230 µg/L) | Granular iron | MCLs: TCE (5 µg/L) <i>cis</i> -DCE (70 µg/L) | 0.2-0.5 | MCLs met in reactive cell. Plume underflow possible through intentional gap between thin aquitard and base of PRB. ^(a) |
| Somersworth Sanitary Landfill Superfund Site (November 1996) | Pilot | TCE, <i>cis</i> -DCE, VC (<300 µg/L) | Granular iron and sand mixture | MCLs: TCE (5 µg/L) <i>cis</i> -DCE (70 µg/L) VC (2 µg/L) | 0.5 to 2.0 | Constructability test using bioslurry trench completed in October 1999, prior to full-scale application. |

Table 10-2. Update on PRB Site Characteristics and Monitoring (Continued)

| PRB Site (Installation Date) | Scale of PRB | Target Contaminants | Reactive Medium | Target Cleanup Levels | Groundwater Velocity in Aquifer (ft/day) | Monitoring Update and Remarks |
|--|--------------|---|--|--|--|--|
| Former Lowry AFB, CO (December 1995) | Pilot | TCE (1,400 µg/L) | Granular iron | MCLs: TCE (5 µg/L) <i>cis</i> -DCE (70 µg/L) | 1 | MCLs met |
| Portsmouth gaseous diffusion plant, OH | Pilot | TCE (70-150 µg/L) | Granular iron in canisters | MCL (5 µg/L) | | MCLs met |
| ORNL, TN | Full | HNO ₃ , uranium, technetium | Granular iron | | | |
| East Garrington gas plant, Canada | Pilot | BTEX (12 mg/L) | None | | | |
| Fry Canyon Site, UT | Full | Uranium (20,700 µg/L) | Bone char phosphate, foamed zero-valent iron, and amorphous ferric oxide | | 1.5 | |
| Private Site, Tifton, GA | Full | Pesticides and VOCs | Activated carbon | | | |
| Former NAS Alameda, CA (December 1996) | Pilot | <i>cis</i> -DCE (250 mg/L) VC (70,000 mg/L) Toluene (9 mg/L) | Granular iron in first reactive cell; biosparging in following cell | | 0.42-1.25 | Breakthrough of CVOCs due to higher-than-expected CVOC concentrations in gate influent. Residence time in iron reactive cell inadequate. |
| Public school, Ontario, Canada | Pilot | Phosphate (1.0 mg/L) Nitrate (23 to 82 mg/L) | 6% iron and Ca-oxides, 9% Ca limestone, and 85% sand | | 0.9 | |
| Tonolli Superfund Site, PA | Full | Pb (328 ppb) Cd (77 ppb) As (313 ppb) Zn (1,130 ppb) Cu (140 ppb) | Limestone | | | |

Table 10-2. Update on PRB Site Characteristics and Monitoring (Continued)

| PRB Site (Installation Date) | Scale of PRB | Target Contaminants | Reactive Medium | Target Cleanup Levels | Groundwater Velocity in Aquifer (ft/day) | Monitoring Update and Remarks |
|--|--------------|--|---|--|--|---|
| Nickel Rim Mine, Canada | Full | Sulfate (2,400-3,800 mg/L) Fe (740-1,000 mg/L) Ni (10 mg/L) | Municipal compost, leaf compost, and wood chips | | 0.13 | |
| Aircraft maintenance facility, OR (March 1998) | Full | VOCs (500 µg/L) | Granular iron | | 3.0 | MCLs met in iron zone. |
| Industrial Site, KS (January 1996) | Full | TCE (400 µg/L) 1,1,1-TCA (100 µg/L) | Granular iron | | 0.2 | Two additional gates and 3,200 ft of slurry wall were added to system in November 1999. |
| Cape Canaveral Air Station, FL (November 1997) | Pilot | TCE (90 mg/L) DCE (170 mg/L) VC (7 mg/L) | Granular iron | | 0.1 to 0.5 | |
| Dover AFB, DE (January 1998) | Pilot | PCE (5,617 µg/L) TCE (549 µg/L) <i>cis</i> -DCE (529 µg/L) | Granular iron (pretreatment zones containing iron-sand or iron-pyrite mixtures) | MCLs: PCE, TCE (5 µg/L) <i>cis</i> -1,2-DCE (70 µg/L) VC (2 µg/L) | 0.06-0.3 | MCLs met. |
| Rocky Flats, Golden, CO (July 1998) | Full | PCE (528,000 µg/L) TCE (18,000 µg/L) | Granular iron | | 0.5 to 2 | |
| Manufactured gas plant, Germany | Full | PAHs (>100 µg/L) | Granular activated carbon | | | |
| Wood-treating facility, NH | Pilot | Nonaqueous-phase liquid | | | | |
| 100D Area, Hanford site, WA | Full | Chromate (2 mg/L) | Chemical reducing agent | | | |
| Savannah River site, Aiken, SC (July 1997) | Pilot | TCE (200-250 µg/L) <i>cis</i> -DCE (20-50 µg/L) NO ₃ (10-70 mg/L) | Granular iron | MCLs: PCE, TCE (5 µg/L) <i>cis</i> -1,2-DCE (70 µg/L) VC (2 µg/L) | Controlled flowrate | MCLs met in iron zone of Geosiphon. |

Table 10-2. Update on PRB Site Characteristics and Monitoring (Continued)

| PRB Site (Installation Date) | Scale of PRB | Target Contaminants | Reactive Medium | Target Cleanup Levels | Groundwater Velocity in Aquifer (ft/day) | Monitoring Update and Remarks |
|--|--------------|--|--|--|--|---|
| DoD facility, SC (November 1998) | Full | 1,1,1-TCE (6,000 µg/L) 1,1-DCA (10,000 µg/L) <i>cis</i> -DCE (1,400 µg/L) 1,1-DCE (450 µg/L) VC (240 µg/L) | Granular iron | MCLs: 1,1,1-TCE (200µg/L) 1,1-DCE (7 µg/L) <i>cis</i> -DCE (70 µg/L) VC (2 µg/L) | 1.5 | Thin iron zones, desorption of VOCs from aquifer strongly influenced results. |
| Industrial facility, LA (November 1998) | Full | TCE (10,000 µg/L) PCE (260,000 µg/L) <i>cis</i> -DCE (66,000 µg/L) VC (32,000 µg/L) TCE (5,000 µg/L) | Granular iron | PCE (25µg/L) TCE (210 µg/L) <i>cis</i> -DCE (116,000 µg/L) VC (358 µg/L) | 0.0003 | Very low flow velocity. |
| DoD facility, WY (August 1999) | Full | TCE (21,000) <i>cis</i> -DCE (560) VC (120) | One segment granular iron; two segments granular iron sand mixture | MCLs: TCE (5 µg/L) <i>cis</i> -DCE (70 µg/L) VC (2 µg/L) | 1.33 | |
| DoD facility, NH (August 1999) | Full | TCE (4,700 µg/L) <i>cis</i> -DCE (10,000 µg/L) VC (1,700 µg/L) | Granular iron and sand mixture | MCLs: TCE (5 µg/L) <i>cis</i> -DCE (70 µg/L) VC (2 µg/L) | 0.03 | |
| Industrial facility, MA (August, 1999) | Full | PCE (17,000 µg/L) TCE (100 µg/L) <i>cis</i> -DCE (100 µg/L) VC (20 µg/L) | Granular iron | MCLs: TCE (5 µg/L) <i>cis</i> -DCE (70 µg/L) VC (2 µg/L) | | |
| Industrial facility, OH (November, 1999) | Full | TCE (8,000 µg/L) <i>cis</i> -DCE (50 µg/L) <i>trans</i> -DCE (50 µg/L) VC (30 µg/L) | Granular iron and sand mixture | MCLs: TCE, PCE (5 µg/L) <i>cis</i> -DCE (70 µg/L) VC (2 µg/L) 1,1-DCE (7 µg/L) | 0.01 | |

Table 10-2. Update on PRB Site Characteristics and Monitoring (Continued)

| PRB Site (Installation Date) | Scale of PRB | Target Contaminants | Reactive Medium | Target Cleanup Levels | Groundwater Velocity in Aquifer (ft/day) | Monitoring Update and Remarks |
|--|---------------------|--|--|--|---|--------------------------------------|
| DoD facility, Travis AFB, CA (July 1999) | Pilot | TCE (10,000 µg/L) <i>cis</i> -DCE (300 µg/L) 1,1-DCE (700 µg/L) <i>cis</i> -DCE (23,200 µg/L) | Fine grained granular iron mixed with aquifer material | MCLs: TCE, PCE (5 µg/L) <i>cis</i> -DCE (70 µg/L) VC (2 µg/L) 1,1-DCE (7 µg/L) | 0.2 | |
| NASA Facility, LA (August 1999) | Pilot | TCE (22,500 µg/L) VC (6,810 µg/L) <i>cis</i> -DCE (23,200 µg/L) | Granular iron | TCE (2,600 µg/L) VC (4,500 µg/L) <i>cis</i> -DCE (70,300 µg/L) | | |
| Maxwell AFB, AL (July 1998) | Pilot | TCE (720 µg/L) PCE (<1 µg/L) | Granular iron suspended in a guar gum slurry | | 0.07-0.2 | |

(a) PRB is not keyed in to aquitard.

11.0 References

- Agrawal, A., and P.G. Tratnyek. 1994. "Abiotic Remediation of Nitro-Aromatic Groundwater Contaminants by Zero-Valent Iron." *Proceedings of the 207th ACS National Meeting, San Diego, CA*, 34(1): 492-494.
- Agrawal, A., and P.G. Tratnyek. 1996. "Reduction of Nitro Aromatic Compounds by Zero-Valent Iron Metal." *Environ. Sci. Technol.*, 30(1): 153-160.
- Appleton, E.L. 1996. "A Nickel-Iron Wall Against Contaminated Groundwater." *Environmental Science and Technology*, 30(12): 536A-539A.
- Ballard, S. 1996. "The In-Situ Permeable Flow Sensor: A Ground-Water Flow Velocity Meter." *Ground Water*, 34(2): 231-240.
- Battelle. 1997a. *Design Guidance for Application of Permeable Barriers to Remediate Dissolved Chlorinated Solvents*. Prepared for AFRL, Tyndall AFB. February.
- Battelle. 1997b. *Design/Test Plan: Permeable Barrier Demonstration at Area 5, Dover AFB*. Prepared for Air Force Research Laboratory, Tyndall AFB. November 14.
- Battelle. 1998. *Performance Evaluation of a Pilot-Scale Permeable Reactive Barrier at Former Naval Air Station Moffett Field, Mountain View, California*. Prepared for Naval Facilities Engineering Service Center, Port Hueneme, CA. November 20.
- Battelle. 1999. *Final Permeable Reactive Barriers (PRBs) Survey Report*. Prepared for the Naval Facilities Engineering Service Center, Port Hueneme, CA. November 19.
- Battelle. 2000. *Design, Construction, and Monitoring of the Permeable Reactive Barrier in Area 5 at Dover Air Force Base*. Final. Prepared for Tyndall Air Force Base, FL. March 31.
- Benner, S.G., D.W. Blowes, and C.J. Ptacek. 1997. "A Full-Scale Porous Reactive Wall for Prevention of Acid Mine Drainage." *Ground Water Monitor Remediation*, 17(4): 99-108.
- Blowes, D.W., R.W. Puls, T.A. Bennett, R.W. Gillham, C.J. Hanton-Fong, and C.J. Ptacek. 1997. "In-Situ Porous Reactive Wall for Treatment of Cr(VI) and Trichloroethylene in Groundwater." *Proceedings of the International Containment Technology Conference*. St. Petersburg, FL. February 9-12. pp. 851-857.
- Blowes, D.W., C.J. Ptacek, S.G. Benner, C.W.T. McRae, and R.W. Puls. 1998. In International Association of Hydrological Sciences (Publication No. 250), *Groundwater Quality: Remediation*

and Protection. pp. 483-490. Proceedings of the Groundwater Quality Conference, Tubingen, Germany, September 1998.

Borden, R.C., R.T. Goin, and C.-M. Kao. 1997. "Control of BTEX Migration Using a Biologically Enhanced Permeable Barrier." *Ground Water Monitor Remediation*, 17(1): 70-81.

Boronina, T., K.J. Klabunde, and G. Sergeev. 1995. "Destruction of Organohalides in Water Using Metal Particles: Carbon Tetrachloride/Water Reactions with Magnesium, Tin and Zinc." *Environ. Sci. Technol.*, 29: 1511-1517.

Bostick, W.D., R.J. Jarabek, W.A. Slover, J.N. Fiedor, J. Farrell, and R. Heferich. 1996. *Zero-Valent Iron and Metal Oxides for the Removal of Soluble Regulated Metals in Contaminated Groundwater at a DOE Site, K/TSO-35-P*. Lockheed Martin Energy Systems, Inc., Oak Ridge, TN.

Breaux, B. 1996. Personal communication from B. Breaux of Envirowall, Belle Chase, LA, with Battelle.

Burke, G.K. 1996. Personal communication from G.K. Burke of Hayward Baker, Inc., Odneton, MD with Battelle.

Burris, D.R., T.J. Campbell, and V.S. Manoranjan. 1995. "Sorption of Trichloroethylene and Tetrachloroethylene in a Batch Reactive Metallic Iron-Water System." *Environ. Sci. Technol.* 29(11): 2850-2855.

Cantrell, K.J., and Kaplan, D.I. 1996. "Zero-Valent Iron Colloid Construction in Sand Columns." *J. Environ. Eng.* (In press).

Cantrell, K.J., Kaplan, D.I., and Gilmore, T.J. 1997. "Injection of Colloidal Fe⁰ Particles in Sand Columns with Shearthinning Fluids." *J. Environ. Eng.* (Submitted).

Carlson, L. and U. Schwertmann. 1987. "Iron and Manganese Oxides in Finnish Ground Water Treatment Plants." *Water Research*, 21: 165-170.

Cavalli, N.J. 1992. "Composite Barrier Slurry Wall." In D.B. Paul, R.R. Davidson, and N.J. Cavalli (Eds.), *Slurry Walls: Design, Construction and Quality Control, ASTM STP 1129*. American Society for Testing and Materials, Philadelphia, PA.

Chapelle, F.H. 1993. *Ground-Water Microbiology & Geochemistry*. John Wiley & Sons, New York.

Chiu, P.C., and D.K. Cha. 2000. "Characterizing a Culture that Dechlorinates TCE with Fe(0)." Abstract for *Remediation of Chlorinated and Recalcitrant Compounds: The Second International Conference*. Monterey, CA. May 22-25, 2000.

- Clark, D.K., D.F. Darling, T.L. Hineline, and P.H. Hayden. 1997. "Field Trial of the Biowall Technology at a Former Manufactured Gas Plant Site." In *Proceedings of the Mid-Atlantic Industrial Waste Conference*. Technomic Publishing Co., Lancaster, PA. pp. 397-403.
- Czekalla, C., W. Mevius, and H. Hanna. 1985. "Quantitative Removal of Iron and Manganese by Microorganisms in Rapid Sand Filters (In Situ Investigations)." *Water Supply*, 3: 111-123.
- Day, S. 1996. Personal Communication with S. Day of Geo-Con, Inc., Denver, CO.
- Day, S.R., S.F. O'Hannesin, and L. Marsden. 1999. "Geotechnical Techniques for the Construction of Reactive Barriers." *Journ. Haz. Mat.*, 67: 285-297.
- Deng, B., T.J. Campbell, and D.R. Burris. 1997. "Hydrocarbon Formation in Metallic Iron/Water Systems." *Environ. Sci. Technol.*, 31(4): 1185-1190.
- Devlin, J.F. and J.F. Barker. 1999. Field Demonstration of Permeable Wall Flushing for Biostimulation of a Shallow Sandy Aquifer. *Groundwater Monitoring and Remediation*, 19(1): 75-83.
- DOE, see United States Department of Energy.
- Domenico, P.A., and F. W. Schwartz. 1990. *Physical and Chemical Hydrogeology*. John Wiley & Sons, Inc., New York.
- Einarson, M.D., R.L. Langdon, and J.F. Barker. 2000. *Draft Hydraulic Performance of a Funnel-and-Gate Treatment System in a Shallow Tidally-Affected Aquifer: Site 1, Alameda Point, Alameda, California*. Prepared for Naval Facilities Engineering Command under Contract No. N47408-98-C-2210. January.
- EnviroMetal Technologies, Inc. 1996. Personal communication from J. Vogan, EnviroMetal Technologies, Inc., Guelph, Ontario, Canada, with Battelle.
- EnviroMetal Technologies, Inc. 1997. Personal communication from J. Vogan and S. O'Hannesin, EnviroMetal Technologies, Inc., Guelph, Ontario, Canada, with Battelle.
- EnviroMetal Technologies, Inc. 1999. Personal communication from J. Vogan, EnviroMetal Technologies, Inc., Waterloo, Ontario, Canada, with Battelle. November.
- ETI, see EnviroMetal Technologies, Inc.
- Fetter, C.W. 1994. *Applied Hydrogeology*, 3rd ed. Merrill Publishing Company: Columbus, OH.

- Focht, R.M. 1994. "Bench-Scale Treatability Testing to Evaluate the Applicability of Metallic Iron for Above-Ground Remediation of 1,2,3-Trichloropropane Contaminated Groundwater." M.Sc. Thesis, Department of Earth Sciences, University of Waterloo, Ontario, Canada. p. 58.
- Focht, R.M., J.L. Vogan, and S.F. O'Hannesin. 1997. "Hydraulic Studies of In-Situ PRBs." Unpublished paper, University of Waterloo, Ontario, Canada.
- Fruchter, J.S., C.R. Cole, M.D. Williams, V.R. Vermeul, S.S. Teel, J.E. Amonette, J.E. Szecsody, and S.B. Yabusaki. 1997. "Creation of a Subsurface Permeable Reactive Barrier Using In Situ Redox Manipulation." *Proceedings of International Containment Technology Conference and Exhibition*. St. Petersburg, FL, February 9-12. pp. 704-710.
- Gavaskar, A.R., B.M. Sass, E. Drescher, L. Cumming, D. Giammar, and N. Gupta. 1998. "Enhancing the Reactivity of Permeable Barrier Media." In G.B. Wickramanayake and R.E. Hinchee (Eds.), *Designing and Applying Treatment Technologies: Remediation of Chlorinated and Recalcitrant Compounds*, vol. C1-6. Proceedings of the First International Conference on Remediation of Chlorinated and Recalcitrant Compounds, Battelle Press.
- Gavaskar, A.R. 1999. "Design and Construction Techniques for Permeable Reactive Barriers." *Journ. Haz. Mat.*, 68: 41-71.
- Gillham, R.W. 1993. Cleaning Halogenated Contaminants from Groundwater. U.S. Patent No. 5,266,213. November 30.
- Gillham, R.W. 1996. "In Situ Treatment of Groundwater: Metal-Enhanced Degradation of Chlorinated Organic Contaminants." In M.M. Aral (Ed.), *Advances in Groundwater Pollution Control and Remediation*, pp. 249-274. Kluwer Academic Publishers, New York, NY.
- Gillham, R.W., D.W. Blowes, C.J. Ptacek, and S.F. O'Hannesin. 1994. "Use of Zero-Valent Metals in In-Situ Remediation of Contaminated Ground Water." In G.W. Gee and N.R. Wing (Eds.), *In-Situ Remediation: Scientific Basis for Current and Future Technologies*. Battelle Press, Columbus, OH. pp. 913-930.
- Gillham, R.W., and S.F. O'Hannesin. 1992. "Metal-Catalyzed Abiotic Degradation of Halogenated Organic Compounds." *IAH Conference: Modern Trends in Hydrogeology*. Hamilton, Ontario, May 10-13. pp. 94-103.
- Gillham, R.W., and S.F. O'Hannesin. 1994. "Enhanced Degradation of Halogenated Aliphatics by Zero-Valent Iron." *Ground Water*, 32: 958-967.
- Gillham, R.W., S.F. O'Hannesin, and W.S. Orth. 1993. "Metal Enhanced Abiotic Degradation of Halogenated Aliphatics: Laboratory Tests and Field Trials." Paper presented on March 9-11, HazMat Central Conference, Chicago, IL.

- Hardy, L.I., and R.W. Gillham. 1996. "Formation of Hydrocarbons from the Reduction of Aqueous CO₂ by Zero-Valent Iron." *Environ. Sci. Technol.*, 30(1): 57-65.
- Hayes, J.J., and D.L. Marcus. 1997. "Design of a Permeable Reactive Barrier In Situ Remediation System, Vermont Site." In *Proceedings of the In Situ Remediation of the Geoenvironment Conference*, 12: 56-67. American Society of Civil Engineers, Minneapolis, MN, October 5-8.
- Herbert, R.B., S.G. Benner, and D.W. Blowes. 1998. "Reactive Barrier Treatment of Groundwater Contaminated by Acid Mine Drainage: Sulphur Accumulation and Sulphide Formation." In International Association of Hydrological Sciences (Publication No. 250), *Groundwater Quality: Remediation and Protection*. pp. 451-457. Proceedings of the Groundwater Quality Conference, Tübingen, Germany, September 1998.
- Hocking, G., S.L. Wells, and R.I. Ospina. 1998. "Design and Construction of Vertical Hydraulic Fracture Placed Iron Reactive Walls." *Proceedings of the First International Conference on Remediation of Chlorinated and Recalcitrant Compounds*, vol. C1-6. Battelle Press. Monterey, CA. May 18-21. pp. 103-108.
- Holser, R.A., S.C. McCutcheon, and N.L. Wolfe. 1995. "Mass Transfer Effects on the Dehalogenation of Trichloroethene by Iron/Pyrite Mixtures." *Extended Abstracts from the 209th ACS National Meeting, Anaheim, Cal.*, 35(1): 788-791. Anaheim, CA. Div. Of Environ. Chem., Am. Chem. Soc., Washington, D.C.
- Hubble, D.W., R.W. Gillham, and J.A. Cherry. 1997. "Emplacement of Zero-Valent Metal for Remediation of Deep Contaminant Plumes." *Proceedings of the International Containment Technology Conference*. St. Petersburg, FL. February 9-12. pp. 872-878.
- Interstate Technology and Regulatory Cooperation Working Group. 1997. *Regulatory Guidance for Permeable Barrier Walls Designed to Remediate Dissolved Chlorinated Solvents*. Prepared by ITRC Work Group Permeable Barriers Work Team.
- Interstate Technology and Regulatory Cooperation Working Group. 1999. *Regulatory Guidance for Permeable Reactive Barriers Designed to Remediate Inorganic and Radionuclide Contamination*. Draft. Prepared by ITRC Work Group Permeable Barrier Walls Work Team. January 29.
- ITRC, see Interstate Technology and Regulatory Cooperation Working Group.
- Jeffers, P.M., L.M. Ward, L.M. Woytowitch, and N.L. Wolfe. 1989. "Homogeneous Hydrolysis Rate Constants for Selected Chlorinated Methanes, Ethanes, Ethenes and Propanes." *Environ. Sci. Technol.*, 23(8): 965-969.
- Kaplan, D.I., K.J. Cantrell, T.W. Wietsma, and M.A. Potter. 1996. "Formation of a Chemical Barrier with Zero-Valent Iron Colloids for Groundwater Remediation." *J. Environ. Qual.*, 25: 1086-1094.

- Kearl, P.M. 1997. "Observations of Particle Movement in a Monitoring Well Using the Colloidal Borescope." *Journal of Hydrology* (200): 323-344.
- Kearl, P.M., N.E. Korte, M. Stites, and J. Baker. 1994. "Field Comparison of Micropurging vs. Traditional Ground Water Sampling." *Ground Water Monitoring and Remediation*, 14(4): 183-190.
- Kershaw, D.S., and S. Pamukcu. 1997. "Ground Rubber: Reactive Permeable Barrier Sorption Media." In *Proceedings of the American Society of Civil Engineers Conference on In Situ Remediation of the Geoenvironment*: 26-40.
- Kilfe, H. 1996. Personal communication from H. Kilfe, Water Resources Control Engineer, California Regional Water Quality Control Board, with Battelle.
- Korte, N.E. 1999. Personal communication from N.E. Korte, Oak Ridge National Laboratory, Grand Junction, CO, with Battelle. October.
- Korte, N.E., L. Liang, and J. Clausen. 1995. "The Use of Palladized Iron as a Means of Treating Chlorinated Contaminants." *Emerging Technologies in Hazardous Waste Management VII, Extended Abstracts for the Special Symposium*. Atlanta, GA. pp. 42-45.
- Kriegman-King, M.R., and M. Reinhard. 1991. "Reduction of Hexachloroethane and Carbon Tetrachloride at Surfaces of Biotite, Vermiculite, Pyrite, and Marcasite." In R.A. Baker (Ed.), *Organic Substances and Sediments in Water*, Vol. 2. Lewis Publishers, Chelsea, MI.
- Kriegman-King, M.R., and M. Reinhard. 1994. "Transformation of Carbon Tetrachloride by Pyrite in Aqueous Solution." *Environ. Sci. Technol.*, 28: 692-700.
- Kruseman, G.P., and N.A. de Ridder. 1991. *Analysis and Evaluation of Pumping Test Data*, 2nd ed. (completely revised). International Institute for Land Reclamation and Improvement, Wageningen, The Netherlands, Publication 47.
- Landis, R. 1998. "Potential Use of Jetting to Emplace Permeable Reactive Barriers." Presentation Materials for the *RTDF Permeable Reactive Barriers Action Team Meeting*. Beaverton, OR. April 15-16. pp. 51.
- Lipczynska-Kochany, E., S. Harms, R. Milburn, G. Sprah, and N. Nadarajah. 1994. "Degradation of Carbon Tetrachloride in the Presence of Iron and Sulphur Containing Compounds." *Chemosphere*, 29: 1477-1489.
- Lütters-Czekalla, S. 1990. "Lithoautotrophic Growth of the Iron Bacterium *Gallionella ferruginea* with Thiosulfate or Sulfide as Energy Source." *Archives of Microbiology*, 154: 417-421.

- Mackenzie, P.D., S.S. Baghel, G.R. Eykholt, D.P. Horney, J.J. Salvo, and T.M. Sivavec. 1995. "Pilot-Scale Demonstration of Reductive Dechlorination of Chlorinated Ethenes by Iron Metal." Presented at the 209th ACS National Meeting, Anaheim, CA, April 2-6.
- Mackenzie, P.D., D.P. Horney, and T.M. Sivavec. 1999. "Mineral Precipitation and Porosity Losses in Granular Iron Columns." *Journal of Hazardous Materials*, 68: 1-17.
- Marchand, E.G., P.A. Shirley, K.A. McNelis, and T.L. Fiorillo. 1998. "New Installation Techniques in Side-by-Side Demonstrations at Cape Canaveral Air Station." Presentation Materials for the *RTDF Permeable Reactive Barriers Action Team Meeting*. Beaverton, OR. April 15-16. pp. 23-24.
- Matheson, L.J., and P.G. Tratnyek. 1994. "Reductive Dehalogenation of Chlorinated Methanes by Iron Metal." *Environ. Sci. Technol.*, 28: 2045-2053.
- Morkin, M., J. Barker, R. Devlin, and M. McMaster. 1998. "In Situ Sequential Treatment of a Mixed Organic Plume Using Granular Iron, O₂, and CO₂ Sparging." In G.B. Wickramanayake and R.E. Hinchee (Eds.), *Proceedings of the First International Conference on Remediation of Chlorinated and Recalcitrant Compounds: Designing and Applying Treatment Technologies* (Vol C1-6). Battelle Press, Columbus, OH. Conference held in Monterey, CA, May 18-21, 1998.
- Muftikian, R., Q. Fernando, and N. Korte. 1995. "A Method for the Rapid Dechlorination of Low Molecular Weight Chlorinated Hydrocarbons in Water." *Water Res.*, 29: 2434.
- Myller, B. 1996. Personal communication from B. Myller of Dames and Moore, with Battelle.
- National Research Council. 1994. *Alternatives for Ground Water Clean Up*. National Academy Press, Washington, DC.
- O'Hannesin, S.F. 1993. A Field Demonstration of a Permeable Reaction Wall for the In Situ Abiotic Degradation of Halogenated Aliphatic Organic Compounds. Unpublished M.S. thesis, University of Waterloo, Ontario, Canada.
- Orth, R.G., and D.E. McKenzie. 1995. "Reductive Dechlorination of Chlorinated Alkanes and Alkenes by Iron Metal and Metal Mixtures." *Extended Abstracts from the Special Symposium Emerging Technologies in Hazardous Waste Management VII*. American Chemical Society, Atlanta, GA. p. 50.
- Orth, W.S., and R.W. Gillham. 1995. "Chloride and Carbon Mass Balances for Iron-Enhanced Degradation of Trichloroethene." Presented at the 209th ACS National Meeting, Anaheim, CA, April 2-6.
- Orth, W.S., and R.W. Gillham. 1996. "Dechlorination of Trichloroethene in Aqueous Solution Using Fe(0)." *Environ. Sci. Technol.*, 30(1): 66-71.

Owaidat, L. 1996. Personal communication from L. Owaidat of Geo. Con., Inc., Rancho Cordova, CA, with Battelle.

Piana, M.J., G.W. Freethey, D.L. Naftz, C.C. Fuller, and J.A. Davis. 1999. "Investigation of Flow Through a Permeable Reactive Barrier Using Ionic Tracers and Groundwater Modeling." *Eos, Transactions, AGU*, 80(46): F325. November 16.

Powell, R.M. and R.W. Puls, 1997. "Hitting the Bull's-Eye in Groundwater Sampling." *Pollution Engineering*, June: 51-54.

PRC, see PRC Environmental Management, Inc.

PRC Environmental Management, Inc. 1996. *Naval Air Station Moffett Field, California, Iron Curtain Area Groundwater Flow Model*. June.

Puls, R.W., R.M. Powell, and C.J. Paul. 1995. "In Situ Remediation of Ground Water Contaminated with Chromate and Chlorinated Solvents Using Zero-Valent Iron: A Field Study." *Extended Abstracts from the 209th ACS National Meeting Anaheim, CA*, 35(1): 788-791. Anaheim, CA. Div. of Environ. Chem., Am. Chem. Soc., Washington, DC.

Reardon, E.J. 1995. "Anaerobic Corrosion of Granular Iron: Measurement and Interpretation of Hydrogen Evolution Rates." *Environ. Sci. Technol.*, 29(12): 2936-2945.

Reynolds, G.W., J.T. Hoff, and R.W. Gillham. 1990. "Sampling Bias Caused by Materials Used to Monitor Halocarbons in Groundwater." *Environ. Sci. Technol.*, 24(1): 135-142.

Roberts, A.L., L.A. Totten, W.A. Arnold, D.R. Burris, and T.J. Campbell. 1996. "Reductive Elimination of Chlorinated Ethylenes by Zero-Valent Metals." *Environ. Sci. Technol.*, 30(8): 2654-2659.

Rocky Mountain Remediation Services. 1999. Draft Mound Site Plume Project Completion Report, Fiscal Year 1998. January.

Schmithorst, B. 1996. Personal communication from B. Schmithorst of Parsons Engineering Science, with Battelle.

Schreier, C.G., and M. Reinhard. 1994. "Transformation of Chlorinated Organic Compounds by Iron and Manganese Powders in Buffered Water and in Landfill Leachate." *Chemosphere*, 29: 1743-1753.

Senzaki, T. 1988. "Removal of Chlorinated Organic Compounds from Wastewater by Reduction Process: III. Treatment of Tetrachloroethane with Iron Powder II." *Kogyo Yosui*, 391: 29-35 (in Japanese).

Senzaki, T., and Y. Kumagai. 1988a. "Removal of Chlorinated Organic Compounds from Wastewater by Reduction Process: Treatment of 1,1,2,2-Tetrachloroethane with Iron Powder." *Kogyo Yosui*, 357: 2-7 (in Japanese).

Senzaki, T., and Y. Kumagai. 1988b. "Removal of Chlorinated Organic Compounds from Wastewater by Reduction Process: II. Treatment of Tetrachloroethane with Iron Powder." *Kogyo Yosui*, 369: 19-25 (in Japanese).

Shikaze, S. 1996. *3D Numerical Modeling of Groundwater Flow in the Vicinity of Funnel-and-Gate Systems*. ARA-TR-96-5286-1. Prepared by Applied Research Associates, Inc. for U.S. Air Force, Tyndall Air Force Base, April.

Sivavec, T.M. 1996. Personal communication from T.M. Sivavec, General Electric Corporate Research and Development, Schenectady, NY., with Battelle.

Sivavec, T.M. 1997. Personal communication from T.M. Sivavec, General Electric Corporate Research and Development, Schenectady, NY., with Battelle.

Sivavec, T.M. 1999. Personal communication from T.M. Sivavec, General Electric Corporate Research and Development, Schenectady, NY with Bruce Sass of Battelle.

Sivavec, T.M., and D.P. Horney. 1995. "Reductive Dechlorination of Chlorinated Ethenes by Iron Metal." Presented at the 209th ACS National Meeting, Anaheim, CA. April 2-6.

Sivavec, T.M., P.D. Mackenzie, D.P. Horney, and S.S. Baghel. "Redox-Active Media for Permeable Reactive Barriers." *Proceedings of the 1997 International Containment Technology Conference and Exhibition*, St. Petersburg, FL: 9-12.

Smith, D., J. Cherry, and R. Jowett. 1995. "Sealable Joint Steel Sheet Piling for Groundwater Pollution Control." In *Proceedings of ER '95: Committed to Results*. U.S. Department of Energy, Denver, CO.

Starr, R.C., and J.A. Cherry. 1994. "In Situ Remediation of Contaminated Ground Water: The Funnel-and-Gate System." *Ground Water*, 32(3): 465-476.

Su, C., and R.W. Puls. 1998. "Temperature Effect on Reductive Dechlorination of Trichloroethene by Zero-Valent Metals." In G.B. Wickramanayake and R.E. Hinchee (Eds.), *Proceedings of the First International Conference on Remediation of Chlorinated and Recalcitrant Compounds: Physical, Chemical, and Thermal Technologies* (Vol. C1-5). Battelle Press, Columbus, OH. Conference held in Monterey, CA, May 18-21, 1998.

Sweeny, K.H. 1981a. "The Reductive Treatment of Industrial Wastewaters: I. Process Description." In G.F. Bennett (Ed.), *American Institute of Chemical Engineers, Symposium Series, Water-1980*, 77(209): 67-71.

Sweeny, K.H. 1981b. "The Reductive Treatment of Industrial Wastewaters: II. Process Description." In G.F. Bennett (Ed.), *American Institute of Chemical Engineers, Symposium Series, Water-1980*, 77(209): 72-88.

Sweeny, K.H. 1983. Treatment of Reducible Halohydrocarbons Containing Aqueous Stream. U.S. Patent 4,382,865.

Sweeny, K.H., and J.R. Fischer. 1972. Reductive Degradation of Halogenated Pesticides. U.S. Patent No. 3,640,821. February 8.

Thombre, M.S., B.M. Thomson, and L.L. Barton. 1997. "Use of a Permeable Biological Reaction Barrier for Groundwater Remediation at a Uranium Mill Tailings Remedial Action (UMTRA) Site." In DOE's *Proceedings of the International Containment Technology Conference and Exhibition*. Conference held at St. Petersburg, FL, February 9-12, 1997.

Tuhela, L., L. Carlson, and O.H. Tuovinen. 1992. "Ferrihydrite in Well Water Samples and Bacterial Enrichment Cultures." *Water Research*, 26: 1159-1162.

Tuhela, L., S.A. Smith, and O.H. Tuovinen. 1993. "Microbiological Analysis of Iron-Related Biofouling in Water Wells and a Flow-Cell Apparatus for Field and Laboratory Investigations." *Ground Water*, 31: 982-988.

United States Department of Energy. 1998. *Standard Life-Cycle Cost-Savings Analysis Methodology for Deployment of Innovative Technologies*. DOE Office of Environmental Management, Federal Energy Technology Center. October 30.

United States Environmental Protection Agency. 1993. Revisions to OMB Circular A-94 on Guidelines and Discount Rates for Benefit-Cost Analysis. Revised annually at <http://www.whitehouse.gov/OMB/circulars/a094/a094.html#ap-c>.

United States Environmental Protection Agency. 1995. *In Situ Remediation Technology Status Report: Treatment Walls*. EPA 542-K-94-004. U.S. EPA, Office of Solid Waste and Emergency Response. April.

United States Environmental Protection Agency. 1997. Selection of Media for the Dover AFB Field Demonstration of Permeable Barriers to Treat Groundwater Contaminated with Chlorinated Solvents. Preliminary Report to U.S. Air Force for SERDP Project 107. August 4.

United States Environmental Protection Agency. 1998. *Permeable Reactive Barrier Technologies for Contaminant Remediation*. EPA 600-R-98-125.

U.S. EPA, see United States Environmental Protection Agency.

Venhuis, M., S. Lesage, K.R. Millar, and A.S. Crowe. 1999. "Evaluation of Polyalkastylene Absorbent Beads for the Remediation of PCE in Groundwater." *Water Quality Research Journal of Canada*, 34(3): 455-468.

Waybrant, K.R., D.W. Blowes, and C.J. Ptacek. 1998. "Selection of Reactive Mixtures for Use in Permeable Reactive Walls for Treatment of Mine Drainage." *Environ. Sci. Technol.*, 32(13): 1972-1979.

Werner, P. 1998. "Impact of Microbial Processes on the Efficiency of Reactive Walls." In International Association of Hydrological Sciences (Publication No. 250), *Groundwater Quality: Remediation and Protection*. pp. 497-500. Proceedings of the Groundwater Quality Conference, Tubingen, Germany, September 1998.

Westinghouse Savannah River Company. 1999. *GeoSiphon™ /GefLow™ Technology, Subsurface Contaminants Focus Area*. June.

WSRC, see Westinghouse Savannah River Company.

Yamane, C.L., S.D. Warner, J.D. Gallinati, F.S. Szerdy, T.A. Delfino, D.A. Hankins, and J.L. Vogan. 1995. "Installation of a Subsurface Groundwater Treatment Wall Composed of Granular Zero-Valent Iron." Preprinted of paper presented at the *209th ACS National Meeting*, Anaheim, CA. April 2-7. *Proceedings*, 35(1): 793-795.

Appendix A
Points of Contact

Appendix A Points of Contact

AFRL Project Officer

Alison Lightner
Air Force Research Laboratory (AFRL)
139 Barnes Drive, Suite 2
Tyndall AFB, FL 32403
Tel: (850) 283-6303
Fax: (850) 283-6064
E-Mail: alison.lightner@tyndall.af.mil

Technical Information Center

Tel: (850) 283-6285
E-Mail: andrew.poulis@tyndall.af.mil

Battelle Project Manager

Arun R. Gavaskar
Battelle
505 King Avenue
Columbus, OH 43201
Tel: (614) 424-3403
Fax: (614) 424-3667
E-Mail: gavaskar@battelle.org

SERDP Contact

Catherine Vogel
SERDP Program Office
901 North Stuart Street, Suite 303
Arlington, VA 22203
Tel: (703) 696-2118
Fax: (703) 696-2114
E-Mail: vogelc@acq.osd.mil

DoD Contact for Tri-Agency PRB Initiative

Charles Reeter
Naval Facilities Engineering Service Center (NFESC)
1100 23rd Street
Port Hueneme, CA 93043
Tel: (805) 982-4991
Fax: (805) 982-4304
E-Mail: reetercv@nfesc.navy.mil

Appendix B
Cost Evaluation of a PRB at Dover AFB

B.1 Capital Investment

B.2 Scaleup

B.3 Projected Operating and Maintenance Costs

B.4 Present Value Analysis of PRB and P&T Options

Appendix B Cost Evaluation of a PRB at Dover AFB

The cost evaluation of the permeable reactive barrier (PRB) in Area 5 at Dover Air Force Base (AFB) includes the actual capital investment required for the pilot-scale PRB installed in December 1997 (Figure B-1) and the estimated capital investment for a proposed scaleup (Figure B-2). Also, annual operating and maintenance (O&M) costs are projected for the scaled-up PRB only. Finally, a present value (PV) analysis is provided which compares the long-term costs of a PRB and an equivalent pump-and-treat (P&T) system.

B.1 Capital Investment

Table B-1 lists the capital investment incurred in installing a pilot-scale PRB in Area 5. This PRB is a funnel-and-gate system with two gates. Each gate is 4 ft wide and is keyed into the aquitard at a depth of 39 ft. Each gate has a 4-ft thickness of iron and incorporates a pretreatment zone (PTZ) and an exit zone. The funnel is 60 ft wide, giving a total barrier width of 68 ft. The PRB is estimated to capture about 50-ft width of plume in an aquifer that is approximately 25 ft thick. The various items in Table B-1 include the costs incurred by Battelle and its construction subcontractor (C³ Environmental), as well as broad estimates of relevant costs incurred by Dover AFB staff for site arrangements and by the United States Environmental Protection Agency's National Exposure Research Laboratory (U.S. EPA-NERL) for the on-site column tests.

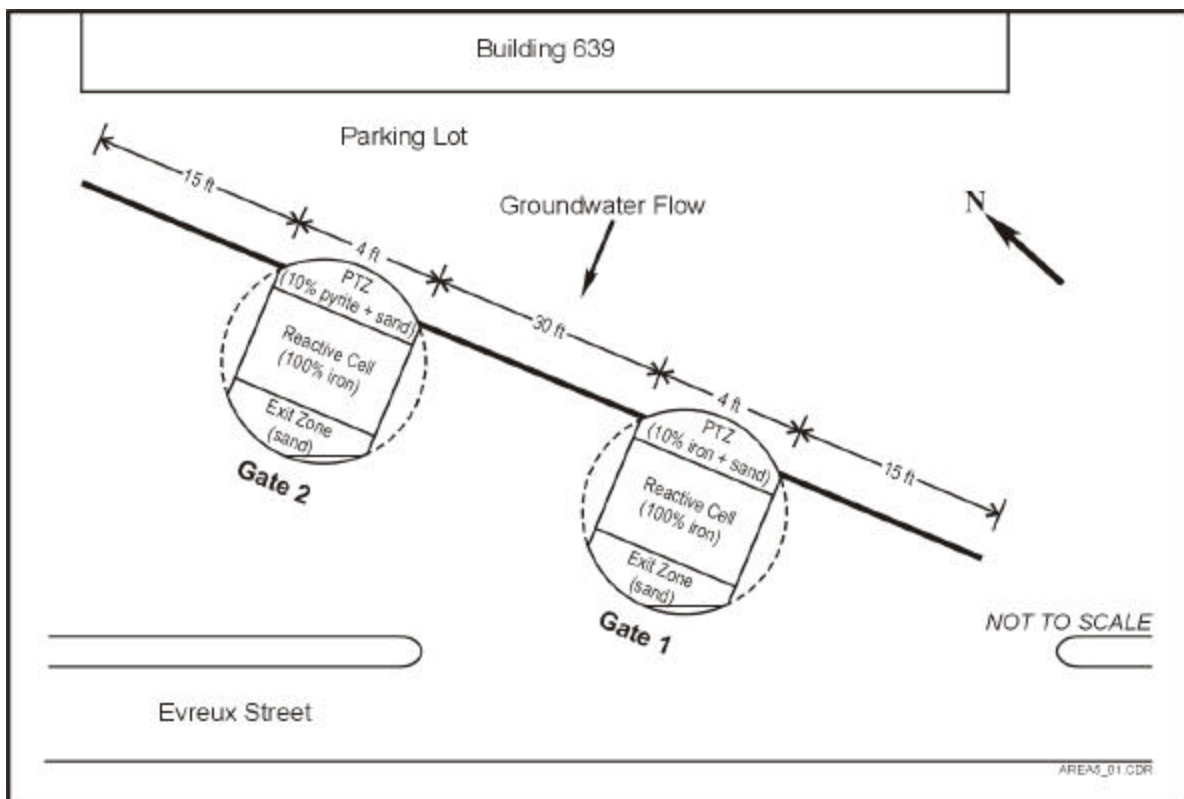

Figure B-1. Schematic of the Pilot-Scale PRB in Area 5 at Dover AFB

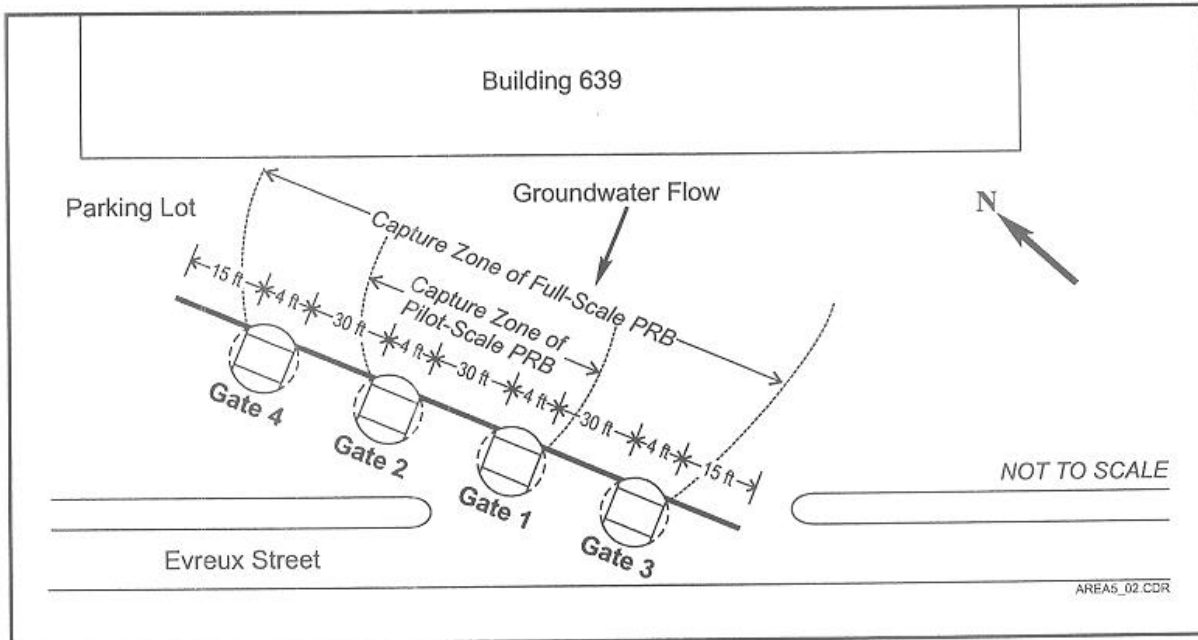

Figure B-2. Schematic of the Scaleup of the PRB

Table B-1 lists the capital investment costs for the pilot-scale PRB in two categories: preconstruction activities and PRB construction activities. Site characterization was a key cost driver in the preconstruction category. Because the PRB is an in situ structure, it is all the more important that the chlorinated volatile organic compound (CVOC) distribution and aquifer characteristics be well defined. In a P&T system, site characterization and design deficiencies can be corrected after system installation by adding additional wells or adjusting the aboveground treatment system. However, once a PRB has been installed, making system adjustments or expansions can be relatively expensive. Another factor driving the characterization cost at Area 5 was that the bulk of the plume was not in the area identified by data from regional wells as reported in the existing Remedial Investigation/Feasibility Study (RI/FS) documents. Characterization activities were redirected after data from temporary wells pushed during additional site characterization activities (June 1997) became available.

The column test costs in Table B-1 illustrate the type of long-term on-site tests conducted for the Dover AFB pilot-scale effort on reactive media selection and degradation rate estimation. For a full-scale application, much less rigorous column tests are required, with a concomitantly lower cost.

The design, procurement, and regulatory review costs include activities such as site characterization, data evaluation, hydrologic and geochemical modeling, draft and final design/test plan preparation, evaluation and procurement of reactive media suppliers and construction subcontractors, and regulatory review. Procurement of a commercial source of pyrite proved to be particularly challenging, because pyrite is no longer the primary source for sulfuric acid production in the chemical industry. Procuring a construction subcontractor involved solicitation of bids, arrangement of a site visit for prospective vendors, and selection of the best technical and cost

Table B-1. Capital Investment Incurred in Installing the Field Pilot-Scale PRB in Area 5

| Item | Description | Basis | Cost^(a) |
|--|--|---|---------------------------|
| <i>Phase 1: Preconstruction Activities</i> | | | |
| Preliminary site assessment | Historical site data evaluation | RI/FS, other reports procurement and evaluation; site meeting | \$15,000 |
| Site characterization | Characterization plan, fieldwork, laboratory analysis | Cone penetrometer test (CPT) pushes for geologic mapping and temporary wells; analysis of water samples for CVOCs; select samples for geotechnical analysis; slug tests; ground-penetrating radar survey ^(b) | \$150,000 |
| Column tests | Two columns for two reactive media combinations; Area 5 groundwater | Three-month on-site test and laboratory analysis of water samples ^(b) ; report | \$100,000 ^(b) |
| Design; procurement; regulatory review | Data evaluation, modeling, engineering design, Design/Test Plan; construction subcontractor procurement; regulatory interactions | Characterization, column test data evaluation; hydrogeologic modeling; geochemical evaluation; engineering design; report; procurement process; regulatory approvals; preconstruction meeting | \$100,000 |
| Subtotal | | | \$365,000 |
| <i>Phase 2: PRB Construction Activities</i> | | | |
| Site preparation | Utilities clearances; arrangement for equipment/media storage and debris disposal | Coordination with Base facilities staff | \$10,000 |
| Reactive media procurement | Connelly iron, shipping; pyrite source identification, procurement; pyrite chunks, crushing, sizing, shipping. | Iron: 54 tons @ \$360/ton Pyrite: 5 tons @ \$1,400/ton Pyrite preparation: \$12,000 Shipping: \$9,000 | \$47,000 |
| PRB Construction | Mobilization/demobilization; installation of two 8-ft-diameter caisson gates to 40-ft depth and one 60-ft-long sheet pile funnel; restoration of asphalt parking lot | Mob./demob.: \$38,000 Gates: \$133,000 Monitoring wells: \$25,000 Funnel: \$51,000 Surface restoration: \$17,000 | \$264,000 |
| Monitoring system construction | Thirty-four polyvinyl chloride (PVC) aquifer wells installed for monitoring the pilot-scale PRB (fewer wells would be required for a full-scale system); four in situ groundwater velocity sensors | Aquifer wells: \$37,000 Velocity sensors: \$16,000 | \$53,000 |
| Subtotal | | | \$374,000 |
| TOTAL | | | \$739,000 |

(a) Includes costs incurred for labor and materials by Battelle and its construction subcontractor C³ Environmental, as well as broad estimates of relevant costs incurred by Dover AFB staff for site arrangements and by U.S. EPA-NERL for the on-site column tests. Some cost items in this table may not be applicable at other sites.

(b) This level of testing was done for demonstration purposes and may be excessive for full-scale application.

bid. The PRB design was finalized only after discussion of several alternative designs and construction techniques with various bidders and a preconstruction meeting with the winning bidder.

Site preparation involved acquisition of clearances from the Base utilities office, arrangements to receive reactive media and construction equipment shipments, and arrangements to dispose of the construction debris. On a per ton basis, the pyrite was costlier than iron, especially after pyrite processing costs were included. It is presumed that if pyrite use for PRB applications grow, less expensive sources of pyrite may become available over time.

PRB construction costs at this site were driven by the cost of installing the caisson gates. However, this method of installation was found to be less costly compared with other alternatives. Also, caisson gates were easier to install in the midst of multiple utility lines that crisscross Area 5. Note that the mobilization/demobilization costs at this site are probably lower than at other sites, because the construction subcontractor used a local partner in Dover, DE to supply most of the heavy equipment and operators, such as the 100-ton crane, 5-ft-diameter auger, and the pile driver. Having this equipment locally available also significantly minimized the time periods that this equipment had to be retained on site. Most of the heavy equipment and operators were requisitioned only on the days that the equipment was actually used. These advantages may not be available at other sites.

Because of the research needs of the demonstration, more monitoring wells were installed than would be required for full-scale application. The monitoring system also includes the installation of the four velocity sensors.

B.2 Scaleup

Although the PRB in Area 5 is considered pilot-scale, its relatively large size (68 ft wide and 39 ft deep) makes its economics easily scalable to a full-scale PRB. CVOC contamination at Area 5 of Dover AFB is fairly widespread, with elevated CVOC concentrations identified in wells on both the north and south sides of Building 639. During additional site characterization in June 1997, an effort was made to identify the most contaminated portion of the plume for this demonstration; however, the boundaries of the entire plume were not mapped. Also, CVOC concentrations at Area 5 tend to vary sharply in both horizontal and vertical planes, indicating the presence of multiple sources of contamination. Lastly, the aquifer region under Building 639 remains unsampled and the CVOC distribution in that region is unknown.

Dover AFB is considering expanding the current pilot-scale PRB to capture more of the plume. In that event, additional site characterization to delineate more of the plume would be required. Based on the CVOC data from monitoring points on the fringes of the demonstration area, it is suspected that the plume may be at least 100 ft wide. The local gradients that drive the movement of this larger plume would have to be evaluated during additional characterization. Local gradients, on the scale of the parking lot at Area 5, will determine whether an extended PRB would continue along a straight line along the current orientation or would be angled from the edges of the current funnel. Based on regulatory and cost considerations, a decision will have to be made as to how much of the larger plume would need to be captured and treated.

To capture a 100-ft width of the plume with the current configuration, two more gates would have to be added to double the capture zone, as the current pilot system captures a 40- to 50-ft-width of the plume. The two additional gates could be installed with caissons, and the funnel could be extended using additional sheet piles. The scaled-up system is shown in Figure B-2. The costs of this extended barrier are listed Table B-2. The costs have been estimated as if the full-scale barrier had been installed right at the beginning, instead of installing the pilot-scale barrier and then extending it.

In Table B-2, Phase 1 costs remain mostly the same as in Table B-1. One difference is that \$50,000 has been added to reflect the cost of additional site characterization to locate the

Table B-2. Capital Investment Projected for Installing a Full-Scale PRB at Dover AFB

| Item | Description | Basis | Cost |
|--|---|---|------------------|
| <i>Phase 1: Preconstruction Activities</i> | | | |
| Preliminary site assessment | Historical site data evaluation | RI/FS, other reports procurement and evaluation; site meeting | \$15,000 |
| Site characterization | Characterization Plan, fieldwork, laboratory analysis | CPT pushes for geologic mapping and temporary wells; analysis of water samples for CVOCs; select samples for geotechnical analysis; slug tests | \$200,000 |
| Column tests | Two column tests; Area 5 groundwater | Column tests and laboratory analysis of water samples; report | \$50,000 |
| Design, procurement of subcontractors, and regulatory review | Data evaluation, modeling, engineering design, Design Plan; procurement of subcontractors; interactions with regulators | Characterization, column test data evaluation; hydrogeologic modeling; geochemical evaluation; engineering design; report; procurement process; regulatory interactions | \$100,000 |
| Subtotal | | | \$365,000 |
| <i>Phase 2: PRB Construction Activities</i> | | | |
| Site preparation | Utilities clearances; arrangements for equipment/media storage and debris disposal | Coordination with regulators and Base facilities staff | \$10,000 |
| Reactive media procurement | Connelly iron, shipping | Iron: 108 tons @ \$360/ton Shipping: \$9,000 | \$48,000 |
| PRB Construction | Mobilization/demobilization; Installation of four 8-ft-diameter caisson gates to 40-ft depth, and one 120-ft-long sheet pile funnel; restoration of asphalt parking lot | Mob./demob.: \$60,000 Gates: \$266,000 Monitoring wells: \$25,000 Funnel: \$102,000 Surface restoration: \$34,000 | \$487,000 |
| Monitoring system construction | Thirty-four PVC aquifer wells installed for monitoring the pilot-scale PRB | Aquifer wells: \$37,000 | \$37,000 |
| Subtotal | | | \$582,000 |
| TOTAL | | | \$947,000 |

boundaries of the plume and assess the geology along a longer length. Another difference is that the column test costs have been reduced to reflect the less rigorous tests required for the full-scale application. In Phase 2, several of the items change. Assuming that only iron is used in the gates (no pyrite), the reactive media cost does not change significantly because the additional iron required costs much less than the small amounts of pyrite that it replaces.

In the category of PRB construction, mobilization/demobilization costs have been increased compared to the pilot system in order to reflect transportation of additional sheet piles and other materials. For a full-scale system, the same number of wells as currently installed for the pilot-scale system could be redistributed over the four gates; a higher number of wells was used for demonstration purposes for the pilot system. The costs for the gates, funnel, and surface restoration have been doubled to reflect the addition of two more gates and another 60 ft of funnel. The aquifer monitoring system cost was kept the same, based on the assumption that the same number of wells could be spread over a larger area. Also, the HydroTechnics velocity meters have been eliminated.

B.3 Projected Operating and Maintenance Costs

The expected O&M costs of the full-scale barrier over the next several years consist of:

- ❑ **Annual monitoring cost.** This item relates to the groundwater sampling and analysis and water-level measurements that would be required to verify acceptable capture and treatment of the plume.
- ❑ **Periodic maintenance cost.** Assuming that the reactivity and/or hydraulic performance of the reactive cell may decline before the plume (or the possible DNAPL source) dissipates, it is probable that some maintenance would be required to regenerate or replace the reactive medium.

It is presumed that groundwater sampling for CVOC analysis would have to be conducted on a quarterly basis, consistent with the regulatory sampling conducted on the rest of the Base. Water levels also could be measured on a quarterly basis to track seasonal flow conditions. Groundwater sampling for inorganic analysis may be required only once a year or once in two years to track the geochemical environment. Other measurements, such as iron core evaluation, may be considered only if required. Table B-3 provides the projected cost of such a monitoring schedule.

Estimating the maintenance cost of the PRB is more difficult. First, the frequency at which such maintenance would be required is unknown. PRBs are a fairly new technology; the longest-running PRB has been in the ground for about 5 years. Long-term column tests at accelerated flowrates have been conducted, but extrapolating the results to field conditions has proved difficult. A rule-of-thumb approximation has been proposed and used in the past at some sites to project the cost of long-term maintenance. This approximation suggests a maintenance requirement that 25% of the iron medium would have to be replaced every 5 or 10 years, depending on the level of dissolved solids (or potential for precipitation) in the groundwater. However, there are no data to really drive such projections.

Table B-3. O&M Costs Projected for Operating a Full-Scale PRB in Area 5

| Item | Description | Basis | Cost |
|--|--|--|------------------|
| <i>Annual Monitoring Activities</i> | | | |
| Groundwater sampling | Quarterly, labor, materials, travel | 40 wells | \$80,000 |
| CVOC analysis | Quarterly, 40 wells | 44 per quarter @ \$120/sample | \$20,000 |
| Inorganic analysis | Annual, 20 wells | 22 per year @ \$200/sample | \$4,000 |
| Water-level survey | Quarterly, labor | 40 wells per quarter | \$4,000 |
| Data analysis; report; regulatory review | Quarterly, labor | 4 times per year | \$40,000 |
| Annual operating cost | | | \$148,000 |
| <i>Periodic Maintenance Activities (once every 10 years)</i> | | | |
| Site preparation | Permitting, clearances | Labor | \$10,000 |
| Reactive media procurement | Connelly iron, shipping | Iron: 108 tons @ \$360/ton Shipping: \$9,000 | \$48,000 |
| Removal/replacement of gates | Mobilization/demobilization; installation of four 8-ft-diameter caisson gates to 39-ft depth; restoration of asphalt parking lot | Mob./demob.: \$38,000 Gates: \$266,000 Monitoring wells: \$25,000 Surface restoration: \$34,000 | \$363,000 |
| Periodic maintenance cost (once every 10 years) | | | \$421,000 |

Also, it is unclear as to what physical means would be applied to remove and replace the reactive medium. Presumably, the contents of the gates could be removed with an auger after installing temporary sheet piles along the upgradient and downgradient edges of the reactive cells to retain the sides of the excavation. However, such removal activities may not be easy given that the shape of the reactive cell is square, and that augering probably would be impeded by the presence of monitoring wells. After gate removal, fresh iron then could be installed in a manner similar to that for the new installation. All the costs in the construction category in Table B-2 would be incurred, except for the funnel cost. This assumes that all reactive media in the gate is to be replaced; partial removal and replacement would be much more difficult.

Based on these assumptions for monitoring and maintenance, Table B-3 shows the projected O&M costs for the PRB over the long term. Table B-3 assumes that PRB maintenance will be required once every 10 years. Maintenance is assumed to involve replacement of all the iron in the gates. Maintenance costs are assumed to be similar to the construction costs of the original gates. The funnel cost and the aquifer monitoring system costs in Table B-2 have been dropped from Table B-3. Additional scenarios involving periodic maintenance requirements of every 5, 10, 20, or 30 years are discussed in Section B.4. Because the longevity of the reactive medium cannot be predicted with certainty, these multiple scenarios show the dependency of the economics of the PRB on the longevity of the reactive medium.

B.4 Present Value Analysis of PRB and P&T Options

The PRB technology is an innovative alternative to conventional P&T systems. As compared with a P&T system, a PRB offers the benefits of passive operation (no external energy input

required for operation) and absence of aboveground structures. A long-term comparison of these two technology options for Area 5 is presented in this section. For this comparison, the capital investment and O&M cost of an equivalent P&T system were estimated, and are summarized in Tables B-4 and B-5. The estimated P&T system costs for Area 5 are based on a similar system designed, built, and tested in a CVOC plume in a different area at Dover AFB (Battelle, 1994).

A comparable P&T system for plume migration control would have to capture the same volume of groundwater as the full-scale PRB with four gates. At the maximum flowrate of 4.1 ft/day through each gate, the PRB is expected to capture the equivalent of approximately 10 gallons per minute (gpm) of flow. Because of possible capture inefficiencies with extraction wells, the P&T system is designed to capture and treat twice as much, or 20 gpm. As described in Table B-4, the investment in the P&T system includes three extraction wells, an air stripper to transfer CVOCs to air, a catalytic oxidizer to treat the air effluent from the stripper, and polishing carbon to remove any residual CVOCs down to maximum contaminant levels (MCLs).

Projected O&M costs of the P&T system consist of an annual operating cost to keep the system running, an annual groundwater monitoring cost, and periodic maintenance costs. The periodic maintenance costs involve replacement of the carbon every 10 years and replacement of the catalyst every 5 years. Tables B-4 and B-5 indicate that the P&T system requires a lower initial capital investment as compared to the PRB, but incurs higher O&M costs, primarily because of the labor and energy requirements to operate the P&T system. The P&T system requires more frequent periodic maintenance in the form of carbon and catalyst replacement. Because the PRB and P&T system require maintenance at different points in time and because the CVOC plume is expected to last for several years or decades, a PV analysis is required to consolidate the capital investment and long-term O&M costs into a total (cumulative) cost in today's dollars.

Table B-6 shows the discounted cash flow (i.e., PV) analysis of the capital investment and O&M costs over 30 years for both PRB and P&T system options. A real discount rate of 2.9% is used in the analysis, as per the 1999 update to the U.S. EPA Office of Management and Budget's circular (U.S. EPA, 1993). It is assumed that the PRB will maintain its reactivity and hydraulic performance over 10 years of operation, after which all four gates will have to be removed and replaced (at an estimated total cost of \$421,000, as shown in Table B-3). The PVs of the capital investment and annual O&M costs are listed in columns 2 and 5 of Table B-6 (for the PRB and P&T system, respectively), and indicate that the further back in time that the cost occurs, the lower its PV. Columns 3 and 6 list the cumulative PV at the end of each year; the cumulative PV includes the capital investment and the PV of all O&M costs up to that year. The year in which the cumulative PV cost of the PRB is equal to or below cumulative PV cost of the P&T system is the payback period or break-even point for the PRB.

As shown in Table B-6, there are two potential break-even times for the PRB (indicated by the shaded cells in the table). In Year 8, the cumulative or total PV cost of the PRB is lower than the PV cost of the P&T system, indicating the first potential break-even point (see shaded cells in Table B-6). However, in Year 10, the nonroutine maintenance cost of replacing the iron in the four gates is incurred (see bold numbers in Table B-6), which makes the total cost of the PRB slightly higher again than the pump-and-treat system. In Year 14, the total PV cost of the PRB again becomes lower, and this is the true break-even point. In other words, over 14 years, the lower

Table B-4. Capital Investment Projected for Installing a P&T System at Dover AFB

| Item | Description | Basis | Cost^(a) |
|---|---|---|---------------------------|
| <i>Phase 1: Preconstruction Activities</i> | | | |
| Preliminary site assessment | Historical site data evaluation | RI/FS, other reports procurement and evaluation; site meeting | \$15,000 |
| Site characterization | Characterization Plan, fieldwork, laboratory analysis | CPT pushes for geologic mapping and temporary wells; analysis of water samples for CVOCs and inorganics; slug tests in existing wells | \$200,000 |
| Design; procurement; regulatory review | Data evaluation, modeling, engineering design, Design Plan; procurement; regulatory interactions | Characterization data analysis; hydrogeologic modeling; engineering design; report; procurement; regulatory review | \$100,000 |
| Subtotal | | | \$315,000 |
| <i>Phase 2: P&T System Construction Activities</i> | | | |
| Site preparation | Utilities clearances; arrangements for equipment storage | Coordination with regulators and Base facilities staff | \$10,000 |
| P&T system construction | Installation of three 4-inch-diameter extraction wells; pumps; air stripper; catalytic oxidizer; polishing carbon; shed; piping | 20-gpm groundwater extraction and treatment system | \$145,000 |
| Monitoring system construction | Thirty PVC aquifer wells installed for monitoring plume movement | Aquifer wells: \$32,000 | \$32,000 |
| Subtotal | | | \$187,000 |
| TOTAL | | | \$502,000 |

(a) Based on a similar P&T system designed, built, and tested for a CVOC plume in a different area at Dover AFB (Battelle, 1994). Details are in Section B.4.

Table B-5. O&M Costs Projected for Operating a P&T System at Dover AFB

| Item | Description | Basis | Cost^(a) |
|--|---|--|---------------------------|
| <i>Annual System O&M (includes routine maintenance)</i> | | | |
| System operation | Keeping P&T system operational | Labor, energy consumption, materials replacement, waste handling, routine maintenance/replacement of pumps | \$66,000 |
| Groundwater monitoring | Quarterly, 40 wells; CVOC, inorganics, water levels | Labor, materials, analytical | \$148,000 |
| Annual operating cost | | | \$214,000 |
| <i>Periodic Maintenance (once every 10 years)</i> | | | |
| Carbon replacement | Polishing carbon for liquid | Used carbon disposal, new carbon installation | \$7,000 |
| <i>Periodic Maintenance (once every 5 years)</i> | | | |
| Catalyst replacement | Oxidizer catalysts for effluent air treatment | Used catalyst disposal, new catalyst installation | \$21,000 |

(a) Based on a similar P&T system designed, built, and tested for a CVOC plume in a different area at Dover AFB (Battelle, 1994). Details are in Section B.4.

**Table B-6. Present Value Analysis of PRB and P&T Systems in Area 5 at Dover AFB
Assuming 10-Year Life of PRB**

| Year | PRB | | | P&T System | | |
|------|--------------------------------|----------------------------------|---|----------------------------|----------------------------------|---|
| | Annual Cost ^(a) | PV of Annual Cost ^(b) | Cumulative PV of Annual Cost ^(c) | Annual Cost ^(a) | PV of Annual Cost ^(b) | Cumulative PV of Annual Cost ^(c) |
| 0 | \$947,000 ^(d) | \$947,000 | \$947,000 | \$502,000 ^(d) | \$502,000 | \$502,000 |
| 1 | \$148,000 ^(e) | \$143,829 | \$1,090,829 | \$214,000 ^(e) | \$207,969 | \$709,969 |
| 2 | \$148,000 | \$139,775 | \$1,230,604 | \$214,000 | \$202,108 | \$912,077 |
| 3 | \$148,000 | \$135,836 | \$1,366,441 | \$214,000 | \$196,412 | \$1,108,489 |
| 4 | \$148,000 | \$132,008 | \$1,498,449 | \$214,000 | \$190,876 | \$1,299,365 |
| 5 | \$148,000 | \$128,288 | \$1,626,736 | \$235,000 ^(g) | \$203,700 | \$1,503,065 |
| 6 | \$148,000 | \$124,672 | \$1,751,408 | \$214,000 | \$180,269 | \$1,683,334 |
| 7 | \$148,000 | \$121,159 | \$1,872,567 | \$214,000 | \$175,189 | \$1,858,523 |
| 8 | \$148,000 | \$117,744 | \$1,990,311 | \$214,000 | \$170,251 | \$2,028,774 |
| 9 | \$148,000 | \$114,426 | \$2,104,737 | \$214,000 | \$165,453 | \$2,194,228 |
| 10 | \$569,000^(f) | \$427,522 | \$2,532,259 | \$242,000 ^(g) | \$181,828 | \$2,376,056 |
| 11 | \$148,000 | \$108,067 | \$2,640,326 | \$214,000 | \$156,259 | \$2,532,315 |
| 12 | \$148,000 | \$105,021 | \$2,745,347 | \$214,000 | \$151,855 | \$2,684,170 |
| 13 | \$148,000 | \$102,061 | \$2,847,408 | \$214,000 | \$147,575 | \$2,831,745 |
| 14 | \$148,000 | \$99,185 | \$2,946,593 | \$214,000 | \$143,416 | \$2,975,162 |
| 15 | \$148,000 | \$96,390 | \$3,042,983 | \$235,000 ^(g) | \$153,051 | \$3,128,213 |
| 16 | \$148,000 | \$93,673 | \$3,136,656 | \$214,000 | \$135,446 | \$3,263,659 |
| 17 | \$148,000 | \$91,033 | \$3,227,690 | \$214,000 | \$131,629 | \$3,395,289 |
| 18 | \$148,000 | \$88,468 | \$3,316,158 | \$214,000 | \$127,920 | \$3,523,208 |
| 19 | \$148,000 | \$85,974 | \$3,402,132 | \$214,000 | \$124,314 | \$3,647,523 |
| 20 | \$569,000^(f) | \$321,222 | \$3,723,354 | \$242,000 ^(g) | \$136,618 | \$3,784,141 |
| 21 | \$148,000 | \$81,197 | \$3,804,550 | \$242,000 | \$132,768 | \$3,916,908 |
| 22 | \$148,000 | \$78,908 | \$3,883,459 | \$214,000 | \$114,097 | \$4,031,006 |
| 23 | \$148,000 | \$76,685 | \$3,960,143 | \$214,000 | \$110,882 | \$4,141,887 |
| 24 | \$148,000 | \$74,523 | \$4,034,667 | \$214,000 | \$107,757 | \$4,249,644 |
| 25 | \$148,000 | \$72,423 | \$4,107,090 | \$235,000 ^(g) | \$114,996 | \$4,364,641 |
| 26 | \$148,000 | \$70,382 | \$4,177,472 | \$214,000 | \$101,769 | \$4,466,409 |
| 27 | \$148,000 | \$68,399 | \$4,245,871 | \$214,000 | \$98,901 | \$4,565,310 |
| 28 | \$148,000 | \$66,471 | \$4,312,341 | \$214,000 | \$96,113 | \$4,661,423 |
| 29 | \$148,000 | \$64,598 | \$4,376,939 | \$214,000 | \$93,405 | \$4,754,827 |
| 30 | \$569,000^(f) | \$241,352 | \$4,618,291 | \$242,000 ^(g) | \$102,649 | \$4,857,476 |

- (a) Annual cost is equal to the capital investment in Year 0 and the O&M cost in subsequent years.
- (b) Present value cost is the annual cost divided by a discount factor term based on a 2.9% discount rate, as described in Section 9.3.
- (c) Cumulative present value cost is the sum of annual present value costs in each year and previous years.
- (d) Initial capital investment.
- (e) Annual routine O&M cost.
- (f) Annual monitoring cost of \$148,000, plus maintenance/replacement of gates for \$421,000, as described in Table B-3.
- (g) Periodic (nonroutine) maintenance to replace catalyst and/or carbon, as described in Table B-5.

annual operating cost (passive operation) of the PRB makes it a worthwhile investment. At the end of the analysis period of 30 years, the PV of the total savings from implementing a PRB versus a P&T system in this illustration is \$239,000 (that is, the difference between the cumulative costs of \$4,618,291 and \$4,857,476 for the PRB and P&T system at the end of 30 years). Table B-7 shows the summarized results of additional scenarios. Because the break-even point is sensitive to the assumption on the life of the PRB, the PV analysis was repeated assuming that the life of the PRB is 5, 10, 20, and 30 years (see Tables B-8 to B-11). In addition, Table B-12 shows a similar scenario extended for a project duration of 50 years.

Table B-7. Break-Even Point and Savings by Using a PRB Instead of a P&T System in Area 5 at Dover AFB

| Life of Reactive Medium | Break-Even Point | PV of Savings Over the Duration of the Project | Duration of Project |
|--------------------------------|-------------------------|---|----------------------------|
| 5 years | None | -\$603,000 | 30 years |
| 10 years | 14 years | \$239,000 | 30 years |
| 20 years | 8 years | \$734,000 | 30 years |
| 30 years | 8 years | \$793,000 | 30 years |
| 30 years | 8 years | \$1,251,000 | 50 years |

Table B-7 summarizes the results of these economic scenarios. As seen in this table, if the PRB lasts only 5 years, and the gates have to be replaced every 5 years, the P&T system is less expensive. If the PRB lasts at least 10 years, it is less expensive than a P&T system. The longer the PRB lasts, the greater the savings at the end of 30 or 50 years. These same cost scenarios, which are discussed in Section 9.3, are depicted in Figure B-3.

Note that this PV cost analysis only takes into account the more tangible costs of the two options. A significant intangible benefit of using a PRB in Area 5 at Dover AFB is that there are no aboveground structures involved, and the site can still be used as a parking lot. With a P&T system, there would be some loss of space for housing the piping and aboveground treatment equipment. The ability of site owners to use, lease, or sell the space that would have been taken up by a P&T system, and to improve the attractiveness of the property as a whole, is a significant benefit of PRB technology. In addition, previous and/or new owners of the property would not have to deal with the high level of maintenance and waste handling during P&T operations.

**Table B-8. PV Analysis of PRB and P&T Systems for Area 5 at Dover AFB
Assuming 5-Year Life of PRB**

| Year | PRB | | | P&T System | | |
|------|------------------|-------------------|------------------------------|-------------|-------------------|------------------------------|
| | Annual Cost | PV of Annual Cost | Cumulative PV of Annual Cost | Annual Cost | PV of Annual Cost | Cumulative PV of Annual Cost |
| 0 | \$947,000 | \$947,000 | \$947,000 | \$502,000 | \$502,000 | \$502,000 |
| 1 | \$148,000 | \$143,829 | \$1,090,829 | \$214,000 | \$207,969 | \$709,969 |
| 2 | \$148,000 | \$139,775 | \$1,230,604 | \$214,000 | \$202,108 | \$912,077 |
| 3 | \$148,000 | \$135,836 | \$1,366,441 | \$214,000 | \$196,412 | \$1,108,489 |
| 4 | \$148,000 | \$132,008 | \$1,498,449 | \$214,000 | \$190,876 | \$1,299,365 |
| 5 | \$569,000 | \$493,214 | \$1,991,663 | \$235,000 | \$203,700 | \$1,503,065 |
| 6 | \$148,000 | \$124,672 | \$2,116,335 | \$214,000 | \$180,269 | \$1,683,334 |
| 7 | \$148,000 | \$121,159 | \$2,237,493 | \$214,000 | \$175,189 | \$1,858,523 |
| 8 | \$148,000 | \$117,744 | \$2,355,237 | \$214,000 | \$170,251 | \$2,028,774 |
| 9 | \$148,000 | \$114,426 | \$2,469,663 | \$214,000 | \$165,453 | \$2,194,228 |
| 10 | \$569,000 | \$427,522 | \$2,897,185 | \$242,000 | \$181,828 | \$2,376,056 |
| 11 | \$148,000 | \$108,067 | \$3,005,252 | \$214,000 | \$156,259 | \$2,532,315 |
| 12 | \$148,000 | \$105,021 | \$3,110,273 | \$214,000 | \$151,855 | \$2,684,170 |
| 13 | \$148,000 | \$102,061 | \$3,212,335 | \$214,000 | \$147,575 | \$2,831,745 |
| 14 | \$148,000 | \$99,185 | \$3,311,520 | \$214,000 | \$143,416 | \$2,975,162 |
| 15 | \$569,000 | \$370,580 | \$3,682,099 | \$235,000 | \$153,051 | \$3,128,213 |
| 16 | \$148,000 | \$93,673 | \$3,775,773 | \$214,000 | \$135,446 | \$3,263,659 |
| 17 | \$148,000 | \$91,033 | \$3,866,806 | \$214,000 | \$131,629 | \$3,395,289 |
| 18 | \$148,000 | \$88,468 | \$3,955,274 | \$214,000 | \$127,920 | \$3,523,208 |
| 19 | \$148,000 | \$85,974 | \$4,041,248 | \$214,000 | \$124,314 | \$3,647,523 |
| 20 | \$569,000 | \$321,222 | \$4,362,470 | \$242,000 | \$136,618 | \$3,784,141 |
| 21 | \$148,000 | \$81,197 | \$4,443,667 | \$242,000 | \$132,768 | \$3,916,908 |
| 22 | \$148,000 | \$78,908 | \$4,522,575 | \$214,000 | \$114,097 | \$4,031,006 |
| 23 | \$148,000 | \$76,685 | \$4,599,260 | \$214,000 | \$110,882 | \$4,141,887 |
| 24 | \$148,000 | \$74,523 | \$4,673,783 | \$214,000 | \$107,757 | \$4,249,644 |
| 25 | \$569,000 | \$278,438 | \$4,952,221 | \$235,000 | \$114,996 | \$4,364,641 |
| 26 | \$148,000 | \$70,382 | \$5,022,603 | \$214,000 | \$101,769 | \$4,466,409 |
| 27 | \$148,000 | \$68,399 | \$5,091,001 | \$214,000 | \$98,901 | \$4,565,310 |
| 28 | \$148,000 | \$66,471 | \$5,157,472 | \$214,000 | \$96,113 | \$4,661,423 |
| 29 | \$148,000 | \$64,598 | \$5,222,070 | \$214,000 | \$93,405 | \$4,754,827 |
| 30 | \$569,000 | \$241,352 | \$5,463,422 | \$242,000 | \$102,649 | \$4,857,476 |

**Table B-9. PV Analysis of PRB and P&T Systems for Area 5 at Dover AFB
Assuming 10-Year Life of PRB**

| Year | PRB | | | P&T System | | |
|------|------------------|-------------------|------------------------------|-------------|-------------------|------------------------------|
| | Annual Cost | PV of Annual Cost | Cumulative PV of Annual Cost | Annual Cost | PV of Annual Cost | Cumulative PV of Annual Cost |
| 0 | \$947,000 | \$947,000 | \$947,000 | \$502,000 | \$502,000 | \$502,000 |
| 1 | \$148,000 | \$143,829 | \$1,090,829 | \$214,000 | \$207,969 | \$709,969 |
| 2 | \$148,000 | \$139,775 | \$1,230,604 | \$214,000 | \$202,108 | \$912,077 |
| 3 | \$148,000 | \$135,836 | \$1,366,441 | \$214,000 | \$196,412 | \$1,108,489 |
| 4 | \$148,000 | \$132,008 | \$1,498,449 | \$214,000 | \$190,876 | \$1,299,365 |
| 5 | \$148,000 | \$128,288 | \$1,626,736 | \$235,000 | \$203,700 | \$1,503,065 |
| 6 | \$148,000 | \$124,672 | \$1,751,408 | \$214,000 | \$180,269 | \$1,683,334 |
| 7 | \$148,000 | \$121,159 | \$1,872,567 | \$214,000 | \$175,189 | \$1,858,523 |
| 8 | \$148,000 | \$117,744 | \$1,990,311 | \$214,000 | \$170,251 | \$2,028,774 |
| 9 | \$148,000 | \$114,426 | \$2,104,737 | \$214,000 | \$165,453 | \$2,194,228 |
| 10 | \$569,000 | \$427,522 | \$2,532,259 | \$242,000 | \$181,828 | \$2,376,056 |
| 11 | \$148,000 | \$108,067 | \$2,640,326 | \$214,000 | \$156,259 | \$2,532,315 |
| 12 | \$148,000 | \$105,021 | \$2,745,347 | \$214,000 | \$151,855 | \$2,684,170 |
| 13 | \$148,000 | \$102,061 | \$2,847,408 | \$214,000 | \$147,575 | \$2,831,745 |
| 14 | \$148,000 | \$99,185 | \$2,946,593 | \$214,000 | \$143,416 | \$2,975,162 |
| 15 | \$148,000 | \$96,390 | \$3,042,983 | \$235,000 | \$153,051 | \$3,128,213 |
| 16 | \$148,000 | \$93,673 | \$3,136,656 | \$214,000 | \$135,446 | \$3,263,659 |
| 17 | \$148,000 | \$91,033 | \$3,227,690 | \$214,000 | \$131,629 | \$3,395,289 |
| 18 | \$148,000 | \$88,468 | \$3,316,158 | \$214,000 | \$127,920 | \$3,523,208 |
| 19 | \$148,000 | \$85,974 | \$3,402,132 | \$214,000 | \$124,314 | \$3,647,523 |
| 20 | \$569,000 | \$321,222 | \$3,723,354 | \$242,000 | \$136,618 | \$3,784,141 |
| 21 | \$148,000 | \$81,197 | \$3,804,550 | \$242,000 | \$132,768 | \$3,916,908 |
| 22 | \$148,000 | \$78,908 | \$3,883,459 | \$214,000 | \$114,097 | \$4,031,006 |
| 23 | \$148,000 | \$76,685 | \$3,960,143 | \$214,000 | \$110,882 | \$4,141,887 |
| 24 | \$148,000 | \$74,523 | \$4,034,667 | \$214,000 | \$107,757 | \$4,249,644 |
| 25 | \$148,000 | \$72,423 | \$4,107,090 | \$235,000 | \$114,996 | \$4,364,641 |
| 26 | \$148,000 | \$70,382 | \$4,177,472 | \$214,000 | \$101,769 | \$4,466,409 |
| 27 | \$148,000 | \$68,399 | \$4,245,871 | \$214,000 | \$98,901 | \$4,565,310 |
| 28 | \$148,000 | \$66,471 | \$4,312,341 | \$214,000 | \$96,113 | \$4,661,423 |
| 29 | \$148,000 | \$64,598 | \$4,376,939 | \$214,000 | \$93,405 | \$4,754,827 |
| 30 | \$569,000 | \$241,352 | \$4,618,291 | \$242,000 | \$102,649 | \$4,857,476 |

**Table B-10. PV Analysis of PRB and P&T Systems for Area 5 at
Dover AFB Assuming 20-Year Life of PRB**

| Year | PRB | | | P&T System | | |
|------|------------------|-------------------|------------------------------|-------------|-------------------|------------------------------|
| | Annual Cost | PV of Annual Cost | Cumulative PV of Annual Cost | Annual Cost | PV of Annual Cost | Cumulative PV of Annual Cost |
| 0 | \$947,000 | \$947,000 | \$947,000 | \$502,000 | \$502,000 | \$502,000 |
| 1 | \$148,000 | \$143,829 | \$1,090,829 | \$214,000 | \$207,969 | \$709,969 |
| 2 | \$148,000 | \$139,775 | \$1,230,604 | \$214,000 | \$202,108 | \$912,077 |
| 3 | \$148,000 | \$135,836 | \$1,366,441 | \$214,000 | \$196,412 | \$1,108,489 |
| 4 | \$148,000 | \$132,008 | \$1,498,449 | \$214,000 | \$190,876 | \$1,299,365 |
| 5 | \$148,000 | \$128,288 | \$1,626,736 | \$235,000 | \$203,700 | \$1,503,065 |
| 6 | \$148,000 | \$124,672 | \$1,751,408 | \$214,000 | \$180,269 | \$1,683,334 |
| 7 | \$148,000 | \$121,159 | \$1,872,567 | \$214,000 | \$175,189 | \$1,858,523 |
| 8 | \$148,000 | \$117,744 | \$1,990,311 | \$214,000 | \$170,251 | \$2,028,774 |
| 9 | \$148,000 | \$114,426 | \$2,104,737 | \$214,000 | \$165,453 | \$2,194,228 |
| 10 | \$148,000 | \$111,201 | \$2,215,937 | \$242,000 | \$181,828 | \$2,376,056 |
| 11 | \$148,000 | \$108,067 | \$2,324,004 | \$214,000 | \$156,259 | \$2,532,315 |
| 12 | \$148,000 | \$105,021 | \$2,429,026 | \$214,000 | \$151,855 | \$2,684,170 |
| 13 | \$148,000 | \$102,061 | \$2,531,087 | \$214,000 | \$147,575 | \$2,831,745 |
| 14 | \$148,000 | \$99,185 | \$2,630,272 | \$214,000 | \$143,416 | \$2,975,162 |
| 15 | \$148,000 | \$96,390 | \$2,726,662 | \$235,000 | \$153,051 | \$3,128,213 |
| 16 | \$148,000 | \$93,673 | \$2,820,335 | \$214,000 | \$135,446 | \$3,263,659 |
| 17 | \$148,000 | \$91,033 | \$2,911,369 | \$214,000 | \$131,629 | \$3,395,289 |
| 18 | \$148,000 | \$88,468 | \$2,999,836 | \$214,000 | \$127,920 | \$3,523,208 |
| 19 | \$148,000 | \$85,974 | \$3,085,811 | \$214,000 | \$124,314 | \$3,647,523 |
| 20 | \$569,000 | \$321,222 | \$3,407,032 | \$242,000 | \$136,618 | \$3,784,141 |
| 21 | \$148,000 | \$81,197 | \$3,488,229 | \$242,000 | \$132,768 | \$3,916,908 |
| 22 | \$148,000 | \$78,908 | \$3,567,138 | \$214,000 | \$114,097 | \$4,031,006 |
| 23 | \$148,000 | \$76,685 | \$3,643,822 | \$214,000 | \$110,882 | \$4,141,887 |
| 24 | \$148,000 | \$74,523 | \$3,718,346 | \$214,000 | \$107,757 | \$4,249,644 |
| 25 | \$148,000 | \$72,423 | \$3,790,769 | \$235,000 | \$114,996 | \$4,364,641 |
| 26 | \$148,000 | \$70,382 | \$3,861,151 | \$214,000 | \$101,769 | \$4,466,409 |
| 27 | \$148,000 | \$68,399 | \$3,929,549 | \$214,000 | \$98,901 | \$4,565,310 |
| 28 | \$148,000 | \$66,471 | \$3,996,020 | \$214,000 | \$96,113 | \$4,661,423 |
| 29 | \$148,000 | \$64,598 | \$4,060,618 | \$214,000 | \$93,405 | \$4,754,827 |
| 30 | \$148,000 | \$62,777 | \$4,123,395 | \$242,000 | \$102,649 | \$4,857,476 |

**Table B-11. PV Analysis of PRB and P&T Systems for Area 5 at Dover AFB
Assuming 30-Year Life of PRB**

| Year | PRB | | | P&T System | | |
|------|------------------|-------------------|------------------------------|-------------|-------------------|------------------------------|
| | Annual Cost | PV of Annual Cost | Cumulative PV of Annual Cost | Annual Cost | PV of Annual Cost | Cumulative PV of Annual Cost |
| 0 | \$947,000 | \$947,000 | \$947,000 | \$502,000 | \$502,000 | \$502,000 |
| 1 | \$148,000 | \$143,829 | \$1,090,829 | \$214,000 | \$207,969 | \$709,969 |
| 2 | \$148,000 | \$139,775 | \$1,230,604 | \$214,000 | \$202,108 | \$912,077 |
| 3 | \$148,000 | \$135,836 | \$1,366,441 | \$214,000 | \$196,412 | \$1,108,489 |
| 4 | \$148,000 | \$132,008 | \$1,498,449 | \$214,000 | \$190,876 | \$1,299,365 |
| 5 | \$148,000 | \$128,288 | \$1,626,736 | \$235,000 | \$203,700 | \$1,503,065 |
| 6 | \$148,000 | \$124,672 | \$1,751,408 | \$214,000 | \$180,269 | \$1,683,334 |
| 7 | \$148,000 | \$121,159 | \$1,872,567 | \$214,000 | \$175,189 | \$1,858,523 |
| 8 | \$148,000 | \$117,744 | \$1,990,311 | \$214,000 | \$170,251 | \$2,028,774 |
| 9 | \$148,000 | \$114,426 | \$2,104,737 | \$214,000 | \$165,453 | \$2,194,228 |
| 10 | \$148,000 | \$111,201 | \$2,215,937 | \$242,000 | \$181,828 | \$2,376,056 |
| 11 | \$148,000 | \$108,067 | \$2,324,004 | \$214,000 | \$156,259 | \$2,532,315 |
| 12 | \$148,000 | \$105,021 | \$2,429,026 | \$214,000 | \$151,855 | \$2,684,170 |
| 13 | \$148,000 | \$102,061 | \$2,531,087 | \$214,000 | \$147,575 | \$2,831,745 |
| 14 | \$148,000 | \$99,185 | \$2,630,272 | \$214,000 | \$143,416 | \$2,975,162 |
| 15 | \$148,000 | \$96,390 | \$2,726,662 | \$235,000 | \$153,051 | \$3,128,213 |
| 16 | \$148,000 | \$93,673 | \$2,820,335 | \$214,000 | \$135,446 | \$3,263,659 |
| 17 | \$148,000 | \$91,033 | \$2,911,369 | \$214,000 | \$131,629 | \$3,395,289 |
| 18 | \$148,000 | \$88,468 | \$2,999,836 | \$214,000 | \$127,920 | \$3,523,208 |
| 19 | \$148,000 | \$85,974 | \$3,085,811 | \$214,000 | \$124,314 | \$3,647,523 |
| 20 | \$148,000 | \$83,551 | \$3,169,362 | \$242,000 | \$136,618 | \$3,784,141 |
| 21 | \$148,000 | \$81,197 | \$3,250,559 | \$242,000 | \$132,768 | \$3,916,908 |
| 22 | \$148,000 | \$78,908 | \$3,329,468 | \$214,000 | \$114,097 | \$4,031,006 |
| 23 | \$148,000 | \$76,685 | \$3,406,152 | \$214,000 | \$110,882 | \$4,141,887 |
| 24 | \$148,000 | \$74,523 | \$3,480,676 | \$214,000 | \$107,757 | \$4,249,644 |
| 25 | \$148,000 | \$72,423 | \$3,553,099 | \$235,000 | \$114,996 | \$4,364,641 |
| 26 | \$148,000 | \$70,382 | \$3,623,481 | \$214,000 | \$101,769 | \$4,466,409 |
| 27 | \$148,000 | \$68,399 | \$3,691,879 | \$214,000 | \$98,901 | \$4,565,310 |
| 28 | \$148,000 | \$66,471 | \$3,758,350 | \$214,000 | \$96,113 | \$4,661,423 |
| 29 | \$148,000 | \$64,598 | \$3,822,948 | \$214,000 | \$93,405 | \$4,754,827 |
| 30 | \$569,000 | \$241,352 | \$4,064,300 | \$242,000 | \$102,649 | \$4,857,476 |

**Table B-12. PV Analysis of PRB and P&T Systems for Area 5 at Dover AFB
Assuming 50-Year Life of PRB**

| Year | PRB | | | P&T System | | |
|------|------------------|-------------------|------------------------------|-------------|-------------------|------------------------------|
| | Annual Cost | PV of Annual Cost | Cumulative PV of Annual Cost | Annual Cost | PV of Annual Cost | Cumulative PV of Annual Cost |
| 0 | \$947,000 | \$947,000 | \$947,000 | \$502,000 | \$502,000 | \$502,000 |
| 1 | \$148,000 | \$143,829 | \$1,090,829 | \$214,000 | \$207,969 | \$709,969 |
| 2 | \$148,000 | \$139,775 | \$1,230,604 | \$214,000 | \$202,108 | \$912,077 |
| 3 | \$148,000 | \$135,836 | \$1,366,441 | \$214,000 | \$196,412 | \$1,108,489 |
| 4 | \$148,000 | \$132,008 | \$1,498,449 | \$214,000 | \$190,876 | \$1,299,365 |
| 5 | \$148,000 | \$128,288 | \$1,626,736 | \$235,000 | \$203,700 | \$1,503,065 |
| 6 | \$148,000 | \$124,672 | \$1,751,408 | \$214,000 | \$180,269 | \$1,683,334 |
| 7 | \$148,000 | \$121,159 | \$1,872,567 | \$214,000 | \$175,189 | \$1,858,523 |
| 8 | \$148,000 | \$117,744 | \$1,990,311 | \$214,000 | \$170,251 | \$2,028,774 |
| 9 | \$148,000 | \$114,426 | \$2,104,737 | \$214,000 | \$165,453 | \$2,194,228 |
| 10 | \$148,000 | \$111,201 | \$2,215,937 | \$242,000 | \$181,828 | \$2,376,056 |
| 11 | \$148,000 | \$108,067 | \$2,324,004 | \$214,000 | \$156,259 | \$2,532,315 |
| 12 | \$148,000 | \$105,021 | \$2,429,026 | \$214,000 | \$151,855 | \$2,684,170 |
| 13 | \$148,000 | \$102,061 | \$2,531,087 | \$214,000 | \$147,575 | \$2,831,745 |
| 14 | \$148,000 | \$99,185 | \$2,630,272 | \$214,000 | \$143,416 | \$2,975,162 |
| 15 | \$148,000 | \$96,390 | \$2,726,662 | \$235,000 | \$153,051 | \$3,128,213 |
| 16 | \$148,000 | \$93,673 | \$2,820,335 | \$214,000 | \$135,446 | \$3,263,659 |
| 17 | \$148,000 | \$91,033 | \$2,911,369 | \$214,000 | \$131,629 | \$3,395,289 |
| 18 | \$148,000 | \$88,468 | \$2,999,836 | \$214,000 | \$127,920 | \$3,523,208 |
| 19 | \$148,000 | \$85,974 | \$3,085,811 | \$214,000 | \$124,314 | \$3,647,523 |
| 20 | \$148,000 | \$83,551 | \$3,169,362 | \$242,000 | \$136,618 | \$3,784,141 |
| 21 | \$148,000 | \$81,197 | \$3,250,559 | \$242,000 | \$132,768 | \$3,916,908 |
| 22 | \$148,000 | \$78,908 | \$3,329,468 | \$214,000 | \$114,097 | \$4,031,006 |
| 23 | \$148,000 | \$76,685 | \$3,406,152 | \$214,000 | \$110,882 | \$4,141,887 |
| 24 | \$148,000 | \$74,523 | \$3,480,676 | \$214,000 | \$107,757 | \$4,249,644 |
| 25 | \$148,000 | \$72,423 | \$3,553,099 | \$235,000 | \$114,996 | \$4,364,641 |
| 26 | \$148,000 | \$70,382 | \$3,623,481 | \$214,000 | \$101,769 | \$4,466,409 |
| 27 | \$148,000 | \$68,399 | \$3,691,879 | \$214,000 | \$98,901 | \$4,565,310 |
| 28 | \$148,000 | \$66,471 | \$3,758,350 | \$214,000 | \$96,113 | \$4,661,423 |
| 29 | \$148,000 | \$64,598 | \$3,822,948 | \$214,000 | \$93,405 | \$4,754,827 |
| 30 | \$569,000 | \$241,352 | \$4,064,300 | \$242,000 | \$102,649 | \$4,857,476 |
| 31 | \$148,000 | \$61,008 | \$4,125,307 | \$214,000 | \$88,214 | \$4,945,690 |
| 32 | \$148,000 | \$59,288 | \$4,184,596 | \$214,000 | \$85,728 | \$5,031,418 |
| 33 | \$148,000 | \$57,617 | \$4,242,213 | \$214,000 | \$83,312 | \$5,114,730 |
| 34 | \$148,000 | \$55,994 | \$4,298,207 | \$214,000 | \$80,964 | \$5,195,694 |
| 35 | \$148,000 | \$54,416 | \$4,352,623 | \$235,000 | \$86,403 | \$5,282,097 |
| 36 | \$148,000 | \$52,882 | \$4,405,505 | \$214,000 | \$76,465 | \$5,358,561 |
| 37 | \$148,000 | \$51,392 | \$4,456,896 | \$214,000 | \$74,310 | \$5,432,871 |
| 38 | \$148,000 | \$49,943 | \$4,506,840 | \$214,000 | \$72,215 | \$5,505,086 |
| 39 | \$148,000 | \$48,536 | \$4,555,375 | \$214,000 | \$70,180 | \$5,575,267 |
| 40 | \$148,000 | \$47,168 | \$4,602,543 | \$242,000 | \$77,126 | \$5,652,392 |
| 41 | \$148,000 | \$45,839 | \$4,648,382 | \$242,000 | \$74,952 | \$5,727,345 |
| 42 | \$148,000 | \$44,547 | \$4,692,929 | \$214,000 | \$64,412 | \$5,791,757 |
| 43 | \$148,000 | \$43,291 | \$4,736,220 | \$214,000 | \$62,597 | \$5,854,354 |
| 44 | \$148,000 | \$42,071 | \$4,778,291 | \$214,000 | \$60,833 | \$5,915,187 |
| 45 | \$148,000 | \$40,886 | \$4,819,177 | \$235,000 | \$64,920 | \$5,980,106 |
| 46 | \$148,000 | \$39,733 | \$4,858,910 | \$214,000 | \$57,452 | \$6,037,558 |
| 47 | \$148,000 | \$38,613 | \$4,897,524 | \$214,000 | \$55,833 | \$6,093,391 |
| 48 | \$148,000 | \$37,525 | \$4,935,049 | \$214,000 | \$54,259 | \$6,147,651 |
| 49 | \$148,000 | \$36,468 | \$4,971,517 | \$214,000 | \$52,730 | \$6,200,381 |
| 50 | \$148,000 | \$35,440 | \$5,006,956 | \$242,000 | \$57,949 | \$6,258,330 |

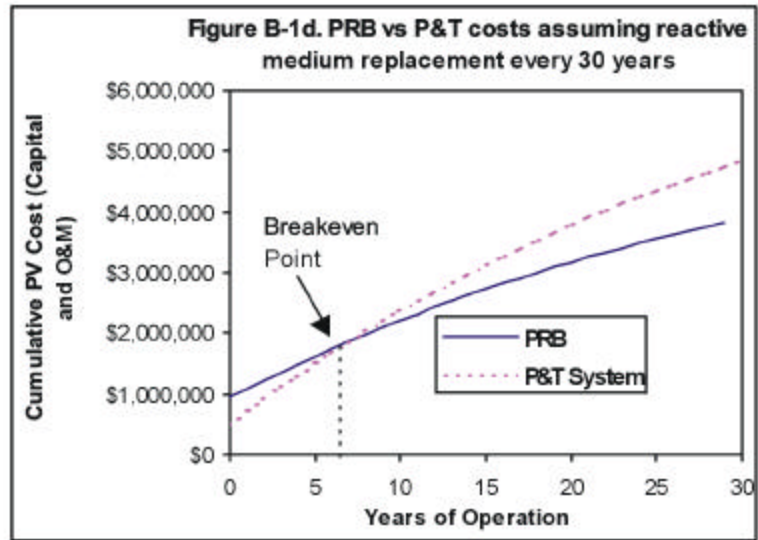
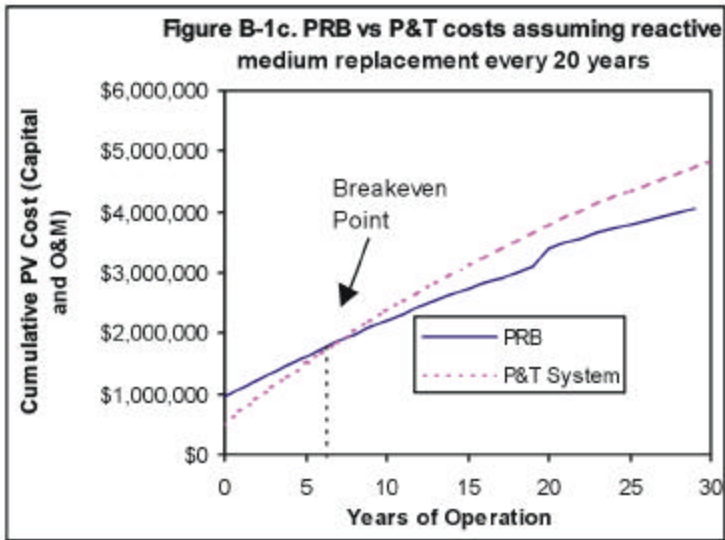
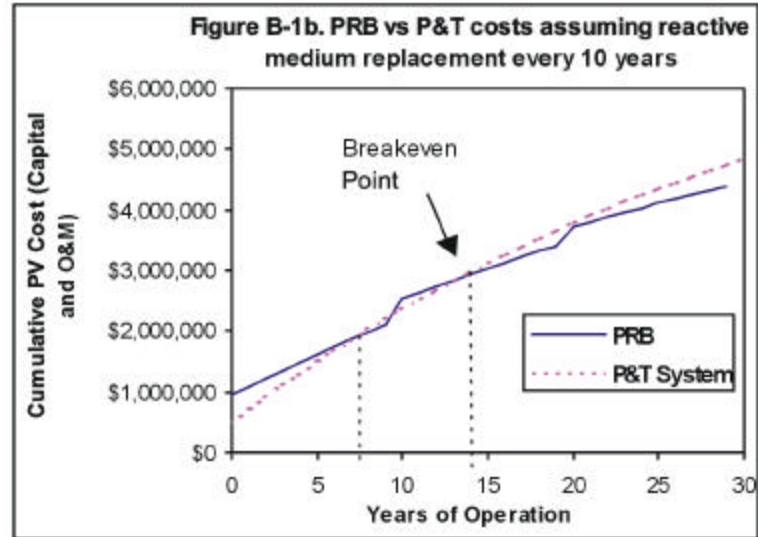
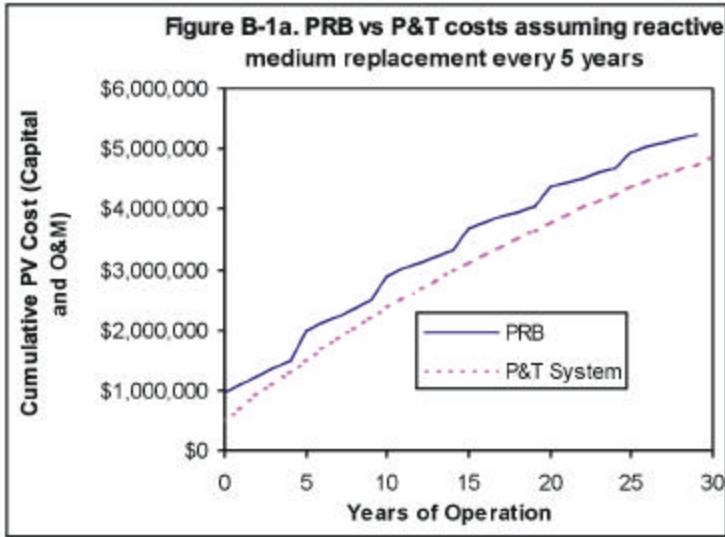

Figure B-3. Illustration of How Break-Even Point or Payback Period Varies with Expected Life of the Reactive Medium

B.5 References

Battelle. 1994. *Final Report: Crossflow Air Stripping with Catalytic Oxidation*. Prepared by Battelle, Columbus, OH for Environics Directorate, Armstrong Laboratory, Tyndall AFB, FL. September.

United States Environmental Protection Agency. 1993. Revisions to OMB Circular A-94 on Guidelines and Discount Rates for Benefit-Cost Analysis. Revised annually at <http://www.whitehouse.gov/OMB/circulars/a094/a094.html#ap-c>.

U.S. EPA, see United States Environmental Protection Agency.

Appendix C

Groundwater Flow Model Review

- C.1 Groundwater Flow Modeling Concepts**
- C.2 PRB Simulation Models**
- C.3 Previous Modeling Studies for PRB Applications**
- C.4 Hydraulic Evaluation of Funnel-and-Gate Systems**
- C.5 References**

Appendix C

Groundwater Flow Model Review

This appendix presents the general concepts of groundwater flow modeling and describes several modeling codes that may be used in designing and evaluating permeable reactive barrier (PRB) systems.

C.1 Groundwater Flow Modeling Concepts

To aid in the design of a PRB system and the interpretation of the resulting flow field, it is recommended that a groundwater flow model be constructed using the site-specific geologic and hydrogeologic data collected as part of the site characterization effort. The model can be used to assess the area of influence, optimize the design, and design the performance monitoring network for the PRB system. A complete description of groundwater flow modeling and the mathematics involved is provided in Wang and Anderson (1982) and Anderson and Woessner (1992). The steps involved in model construction and execution are discussed in the following subsections.

C.1.1 Conceptual Model Development

The first step in any modeling effort is the development of the conceptual model. The conceptual model is a three-dimensional (3-D) representation of the groundwater flow and transport system based on all available geologic, hydrogeologic, and geochemical data for the site. A complete conceptual model will include geologic and topographic maps of the site, cross sections depicting the site geology/hydrogeology, a description of the physical and chemical parameters associated with the aquifer(s), and contaminant concentration and distribution maps. The purpose of the conceptual model is the integration of the available data into a coherent representation of the flow system to be modeled. The conceptual model is used to aid in model selection, model construction, and interpretation of model results.

C.1.2 Model Selection

To be used to simulate the flow at PRBs, the groundwater flow model requires several special features/capabilities. The most important requirements derive from the need to simulate sharp hydraulic conductivity (K) contrasts at the intersection of the aquifer and the funnel walls. The specific requirements and recommendations for the PRB simulation models include the following:

- ❑ Two-dimensional (2-D) or 3-D groundwater flow models may be used to simulate the flow system of a site under consideration. A 3-D modeling approach is recommended so that the possibility of underflow or overflow and of interactions between the adjacent aquifer can be examined at the PRB and its vicinity. Vertical-flow velocities and travel times will be of critical significance in the design of systems at sites with significant vertical-flow gradients or in cases where the barriers are not keyed into the underlying confining layer.
- ❑ The groundwater flow codes should be able to simulate large contrasts in K at the funnel walls. Most of the PRB designs include a reactive cell with K higher than that of the aquifer and flanking funnel walls with extremely low permeability. The

funnels may consist of the slurry wall, which can be several feet wide, or the sheet piles, which are usually less than an inch in width. Therefore, at the intersection of the aquifer and the reactive cells, large K contrasts are developed, and many models are unable to solve these problems due to numerical instabilities. In most cases, the funnel walls are simulated by assigning a very low conductivity to the model cells representing the funnel locations. For accurate simulations, the size of the slurry walls should be the same size as the funnel walls, which will result in a very small cell size and a large number of cells in the model. However, the size of the funnel walls can reduce further if the sizes of the sheet piles (which are even thinner than the slurry walls) are taken into account. A practical compromise strategy is to simulate large areas with sufficient resolution at locations near the funnels, but to increase the cell dimensions at locations further away from the funnels. Models capable of incorporating grid blocks of variable size are recommended. Some alternative approaches have been devised to simulate the low-K funnel walls. These are discussed with the appropriate model descriptions in Section C.2, “PRB Simulation Models.”

- ❑ Many sites have significant heterogeneities, which result in the development of preferential pathways through which most of the groundwater movement occurs. The PRB design itself imparts heterogeneity to the subsurface system. The simulation of these effects requires models that can handle heterogeneity. Most general-purpose analytical models are based on the assumption of homogeneity, but most numerical models can incorporate heterogeneities.
- ❑ Many sites have features such as streams, drains, tunnels, or wells in the vicinity of the PRB sites. For example, at some sites, pump-and-treat (P&T) remediation systems may be active in the vicinity of the PRBs. These situations require the use of models that can simulate the effects of these internal sinks or sources on the PRB systems.
- ❑ The results of the model should be amenable to use with the particle-tracking programs so that the capture zones of the PRBs can be evaluated. It also should be possible to calculate volumetric flow budgets for the reactive cells.

Many groundwater flow modeling codes currently on the market meet the above requirements. A comprehensive description of nonproprietary and proprietary flow and transport modeling codes can be found in the United States Environmental Protection Agency (U.S. EPA) document titled *Compilation of Ground-Water Models* (van der Heijde and Elnawawy, 1993). Depending on the project’s needs, the designer of a PRB system may want to apply a contaminant transport code that can use the calculated hydraulic-head distribution and flow field from the flow-modeling effort. If flow and transport in the vadose zone are of concern, a coupled or uncoupled, unsaturated/saturated flow and transport model should be considered. The codes that meet most of the requirements for simulation of PRB systems are discussed in Section C.2, “PRB Simulation Models.”

C.1.3 Model Construction and Calibration

Model construction consists primarily of converting the conceptual model into the input files for the numerical model. The hydrostratigraphic units defined in the conceptual model can be used to define the physical framework or grid mesh of the numerical model. In both finite-difference

models (such as MODFLOW) and finite-element models (such as FRAC3DVS), a model grid is constructed to discretize the lateral and vertical space that the model is to represent. The different hydrostratigraphic units are represented by model layers, each of which is defined by an array of grid cells. Each grid cell is defined by hydraulic parameters (e.g., K, storativity, cell thickness, cell top, and cell bottom) that control the flow of water through the cells.

Model boundaries are simulated by specifying boundary conditions that define the head or flux of water that occurs at the model grid boundaries or edges. These boundary conditions describe the interaction between the system being modeled and its surroundings. Three types of boundary conditions generally are used to describe groundwater flow: specified-head (Dirichlet), specified-flux (Neumann), and head-dependent flux (Cauchy) (Anderson and Woessner, 1992). Internal boundaries or hydrologic stresses, such as wells, rivers, drains, and recharge, also may be simulated using these conditions. Boundary conditions are used to include the effects of the hydrogeologic system outside the area being modeled and also to make possible isolation of the desired model domain from the larger hydrogeologic system.

Calibration of a groundwater flow model refers to the demonstration that the model is capable of producing field-measured heads and flows, which are used as the calibration values or targets. Calibration is accomplished by finding a set of hydraulic parameters, boundary conditions, and stresses that can be used in the model to produce simulated heads and fluxes that match field-measured values within a preestablished range of error (Anderson and Woessner, 1992). Model calibration can be evaluated through statistical comparison of field-measured and simulated conditions.

Model calibration often is difficult because values for aquifer parameters and hydrologic stresses typically are known in relatively few locations and their estimates are influenced by uncertainty. The uncertainty in a calibrated model and its input parameters can be evaluated by performing a sensitivity analysis in which the aquifer parameters, stresses, and boundary conditions are varied within an established range. The impact of these changes on the model output (or hydraulic heads) provides a measure of the uncertainty associated with the model parameters, stresses, and boundary conditions used in the model. To ensure a reasonable representation of the natural system, it is important to calibrate with values that are consistent with the field-measured heads and hydraulic parameters. Calibration techniques and the uncertainty involved in model calibration are described in detail in Anderson and Woessner (1992).

C.1.4 Model Execution

After a model has been calibrated to observed conditions, it can be used for interpretive or predictive simulations. In a predictive simulation, the parameters determined during calibration are used to predict the response of the flow system to future events, such as the decrease in K over time or the effect of pumping in the vicinity of the PRB. The predictive requirements of the model will determine the need for either a steady-state simulation or a transient simulation, which would accommodate changing conditions and stresses through time. Model output and hydraulic heads can be interpreted through the use of a contouring package and should be applied to particle-tracking simulations in order to calculate groundwater pathways, travel times, and fluxes through the cell. Establishing travel times through the cell is a key modeling result that can be used to determine the thickness of the permeable cell.

C.2 PRB Simulation Models

This section describes the various computer simulation codes that meet the minimum requirements for simulations of groundwater flow and particle movement at PRB sites. Some of the codes already have been used at PRB sites. Nearly all are readily available from the authors or their sponsoring agencies or through resellers. Proprietary codes are included only if they have been applied at a PRB site. Not discussed are advanced programs, such as HST3D (Kipp, 1987), that can simulate the groundwater flow in the vicinity of PRBs, but which in fact are designed for simulation of more complex processes.

C.2.1 MODFLOW and Associated Programs

The perhaps most versatile, widely used, and widely accepted groundwater modeling code is the United States Geological Survey's (USGS's) modular, 3-D, finite-difference groundwater flow model, commonly referred to as MODFLOW (McDonald and Harbaugh, 1988). MODFLOW simulates 2-D and quasi- or fully 3-D, transient groundwater flow in anisotropic, heterogeneous, layered aquifer systems. MODFLOW calculates piezometric head distributions, flowrates, and water balances, and it includes modules for flow toward wells, through riverbeds, and into drains (other modules handle evapotranspiration and recharge). Various textual and graphical pre- and postprocessors are available on the market that make it easy to use the code and analyze the simulation results. These include GMS (Groundwater Modeling System) (Brigham Young University, 1996), ModelCad³⁸⁶ (Rumbaugh, 1993), Visual MODFLOW (Waterloo Hydrogeologic, Inc., 1999b), and Groundwater Vistas (Environmental Simulations, Inc., 1994).

Additional simulation modules are available through the authors and third parties. One of these is the Horizontal Flow Barrier (HFB) package (Hsieh and Freckleton, 1993). This module is especially useful in simulating the funnel-and-gate design. In normal cases, slurry walls must be simulated by very small cells of low K, which increases significantly the number of cells in the model. The HFB package permits the user to assign the sides of certain cells as planes of low K, while still using a larger cell size at the funnel walls. The low-conductivity HFB planes restrict the flow of water into the cells across the faces representing slurry walls or sheet piles. Another useful addition is the ZONEBUDGET (Harbaugh, 1990) package, which allows the user to determine the flow budget for any section of the model. This package may be used to evaluate the volumetric flow through the cell for various design scenarios.

The results from MODFLOW can be used in particle-tracking codes, such as MODPATH (Pollock, 1989) and PATH3D (Zheng, 1989), to calculate groundwater paths and travel times. MODPATH is a postprocessing package used to compute 3-D groundwater path lines based on the output from steady-state simulations obtained with the MODFLOW modeling code. MODPATH uses a semianalytical particle-tracking scheme, based on the assumption that each directional velocity component varies linearly within a grid cell in its own coordinate direction. PATH3D is a general particle-tracking program for calculating groundwater paths and travel times in transient 3-D flow fields. The program includes two major segments: a velocity interpolator, which converts hydraulic heads generated by MODFLOW into a velocity field; and a fourth-order Runge-Kutta numerical solver with automatic time-step size adjustment, which tracks the movement of fluid particles (van der Heijde and Elnawawy, 1993). A proprietary code, RWLK3D[®], developed by Battelle (Naymik and Gantos, 1995), also has been used in conjunction with MODFLOW to simulate the particle movement for the pilot-scale reactive cell

installed at former Naval Air Station (NAS) Moffett Field (Battelle, 1996) and for the PRB at Dover Air Force Base (AFB) (Battelle, 1997). This is a 3-D transport and particle-tracking code based on the Random Walk approach to solute transport simulation.

C.2.2 FLOWPATH

FLOWPATH II (Waterloo Hydrogeologic, Inc., 1999a) is a 2-D steady-state groundwater flow and pathline model. The code can simulate confined, unconfined, or leaky aquifers in heterogeneous and anisotropic media. Complex boundary conditions can be simulated. The program output includes simulated hydraulic heads, pathlines, travel times, velocities, and water balances. The funnel walls can be simulated by constructing a model grid with very small cell size in the vicinity of the permeable cells. Because of its user-friendly graphical interface, this program can be used to quickly simulate the flow fields for a number of design options. Therefore, this program has been used for several PRB sites. However, this program cannot be used if the groundwater flow at a site is very complex due to vertical fluxes or if transient flow fields are to be simulated. These situations are possible if there is a potential for vertical underflow or if the permeable wall is not keyed into the confining layer.

C.2.3 FRAC3DVS

FRAC3DVS is a 3-D, finite-element model for simulating steady-state or transient, saturated or variably saturated, groundwater flow and advective-dispersive solute transport in porous or discretely fractured porous media. The code was developed at the University of Waterloo (Therrien, 1992; Therrien and Sudicky, 1995) and is being marketed by Waterloo Hydrogeologic, Inc. The code includes preprocessors for grid mesh and input file generation, and post-processors for visualization of the simulation results. This program has many advanced features that generally are not required for simple PRB designs. However, the program is included here because the code has been used by Shikaze (1996) to simulate a hypothetical funnel-and-gate design. Further, the solute transport features of this code include the ability to simulate the multispecies transport of straight or branching decay chains. This feature may be used to simulate the reaction progress and daughter product generation in the sequential decay of chlorinated solvents in the permeable cells.

In the work by Shikaze, the impermeable cutoff walls are implemented as 2-D planes within the 3-D computational domain. This is done by adding "false nodes" wherever impermeable nodes are desired. As a consequence, at the impermeable walls, two nodes exist at the same spatial location. These two nodes are connected to elements on the opposite sides of the wall, essentially breaking the connection between two adjacent elements. The net result is an impermeable wall simulated as a 2-D plane within the 3-D domain. These simulations assume that the funnel walls are fully impermeable. This may not be a realistic assumption for very long-term simulations, especially for slurry walls.

C.2.4 GROWFLOW

GROWFLOW is an innovative PRB simulation program being developed by Applied Research Associates, Inc. (Everhart, 1996) for the United States Air Force (USAF). The program is based on the Lagrangian smooth particle hydrodynamics (SPH) concepts traditionally used in the astrophysical simulations. SPH is a continuum-dynamics solution methodology in which all hydrodynamic and history information is carried on particles. In that sense, GROWFLOW is

similar to the particle-tracking codes commonly used to display the flowpaths calculated by the numerical models. The particles in GROWFLOW are Lagrangian interpolation points that interact through the use of a smoothing kernel. The kernel defines a region of influence for each particle and permits approximations to spatial derivatives to be obtained without a mesh. The spatial derivatives are obtained from each particle using an explicit time-integration method.

GROWFLOW is a fully 3-D, saturated-unsaturated code that can handle complex geometry. The model domain and the PRB are simulated using exterior and interior flow control panels that contain and direct flow. No model grid is required. Instead, the initial particle locations serve as the integration points for spatial derivatives. The flow control panels form an impermeable boundary that restricts flow across the external model boundaries or across the internal panels that represent funnel walls. The external boundaries are simulated by assigning constant head or constant velocity source models. These source models are panels that control flow into the model domain. The flow out of the model domain is provided by a volume for the fluid to flow into; that is, the model domain is increased.

GROWFLOW input consists of the model domain parameters, the material properties, the elevation head direction, the panel locations, the saturation vs. head relationship, time-step information, the saturation vs. conductivity relationship, initial locations of all particles in the system, and particle volume. In addition, information also is needed for the smoothing length (region of influence) for the particles. The output includes a listing of the input parameters, particle locations, and heads at specified time intervals. The output can be plotted to show heads as contour maps and particle movement as pathlines.

GROWFLOW is an innovative, flexible, and versatile code for simulation and optimization of PRB systems. However, the code is experimental and several issues need to be addressed. Most importantly, the code needs to be validated against the existing analytical or numerical codes and against field data to verify its numerical accuracy. There appears to be no clear method for simulating internal sources or sinks such as wells and rivers. At many sites, these features may form a significant part of the hydrologic budgets. In addition, there appears to be no provision to check mass or volume balance in the simulations.

C.2.5 Funnel-and-Gate Design Model (FGDM)

FGDM is a multicomponent, steady-state, analytical program for funnel-and-gate design and cost-optimization. It was developed by Applied Research Associates, Inc. (Hatfield, 1996) for the USAF. Program input includes the initial concentrations and first-order reaction rates and the required water quality standards, which then are used to determine the required residence times for water in the permeable cell. The critical residence times are used with input plume-to-gate-width ratios by the program to develop several funnel-and-gate designs. Finally, the cost minimization model is used to find the minimum cost design scenario based on the input unit costs for funnel walls, gate walls, reactive media, and land. The Lagrangian cost minimization is based on a modified Newton-Raphson algorithm for solution of nonlinear equations. Because the accuracy of cost minimization is based partly on the initial estimates for the minimum cost design, it is important to have a preliminary estimate of the low-cost configuration. Additional input parameters include the funnel width, hydraulic gradient, aquifer thickness, aquifer conductivity, gate porosity, ratio of K_{aquifer} to K_{cell} , and depth of system walls. The funnel width, which

is the total width of funnel walls and the gate, is estimated in advance assuming a capture efficiency of 80%. For example, for a plume width of 80 ft, a funnel width of 100 ft is suggested. This assumption may need to be validated by further modeling or field studies. FGDM is a useful tool for a quick evaluation of several design scenarios in a simple setting. However, it cannot be used for complex settings such as heterogeneous media, or for evaluating the flow-paths through the permeable cell.

C.2.6 FLONET

FLONET (Guiguer et al., 1992) is a 2-D, steady-state flow model distributed by Waterloo Hydrogeologic, Inc. The program calculates potentials, streamlines, and velocities and can be used to generate flownets (maps showing flowlines and hydraulic heads) for heterogeneous, anisotropic aquifers. The funnel walls and the gate can be specified by assigning lower K to elements representing these features. The program was used by Starr and Cherry (1994) to evaluate several design scenarios for funnel-and-gate systems.

C.3 Previous Modeling Studies for PRB Applications

A review of the information available from PRB sites under investigation showed that MODFLOW (McDonald and Harbaugh, 1988), in conjunction with particle tracking with codes such as MODPATH (Pollock, 1989), is the code most commonly used to simulate PRB technology. Other programs such as FLONET (Guiguer et al., 1992), FRAC3DVS (Therrien and Sudicky, 1995), FLOWPATH (Waterloo Hydrogeologic, Inc., 1996), and RWLK3D[®] (Naymik and Gantos, 1995) also have been used at some sites. Two new codes, GROWFLOW (Everhart, 1996) and FGDM (Hatfield, 1996), have been developed recently for the USAF to simulate and optimize the funnel-and-gate systems. However, these new codes have not been applied at any sites to date. The sites that used MODFLOW include Dover AFB; the Sunnyvale, CA site, former NAS Moffett Field, CA (PRC, 1996; Battelle, 1996); the Sommersworth Sanitary Landfill, NH; an industrial facility in Kansas; and General Electric Co. Appliances, WI. FLOWPATH has been used to evaluate the design at Belfast, Northern Ireland; Fairchild AFB, WA; and the United States Department of Energy (DOE) Kansas City, KS site. General modeling evaluations of PRB technology are those by Gupta and Fox (1999), Starr and Cherry (1994), and Shikaze (1996). These papers evaluate the effects of various parameters on the design and performance of typical funnel-and-gate configurations, although some of the conclusions are applicable to continuous reactive barriers as well.

Starr and Cherry (1994) used FLONET (Guiguer et al., 1992) to illustrate the effects of funnel-and-gate geometry (design) and reactive cell hydraulic conductivity (K_{cell}) on the size and shape of capture zone, the discharge groundwater flow volume through the gate, and the residence time in the reactive cell. Only the configurations with barriers keyed into the underlying confining layer were simulated. The hanging wall systems were not simulated using FLONET because 3-D simulations describe them best. The simulated system had properties similar to those of the surficial aquifer at Canadian Forces Base Borden, Ontario, Canada. The simulated aquifer was isotropic, with a homogeneous aquifer hydraulic conductivity (K_{aquifer}) of 28.3 ft/day and a hydraulic gradient of 0.005. The funnel walls were assumed to be 1-m- (3.28-ft-) thick slurry walls, with a K equal to 0.0028 ft/day. The K of the reactive cell was 283 ft/day, the maximum laboratory-measured value for 100% iron, in the base case. The range of values for K_{cell}

indicates differences in the source of granular iron, as well as variability of the K measurement itself. A porosity of 0.33 was used for all materials.

The following conclusions were made based on the simulation of several scenarios.

- For systems with funnel walls at 180 degrees (straight funnel), the discharge through the gate and the hydraulic capture zone width increases as the funnel width increases. However, the increase in discharge is not directly proportional to funnel width. In fact, the relative discharge (ratio of discharge through the aquifer with PRB versus discharge with no PRB) through the gate decreases dramatically as the funnel width increases.
- For a constant funnel width, the absolute and relative discharge through the gate (and the capture zone width) increase with an increase in gate width. Therefore, it is desirable to have a gate as wide as is practical.
- For a given funnel-and-gate design, the discharge through the gate increases with increase in K_{cell} relative to the K_{aquifer} . However, there is relatively little increase in discharge when the K_{cell} is more than 10 times higher than the K_{aquifer} . This result implies that, although a reactive cell conductivity higher than the K_{aquifer} is desirable, K_{cell} does not have to be much higher than K_{aquifer} . This is a useful result, because the large grain sizes required for very high- K_{cell} values would result in a low total surface area for reactions and lower residence times.
- For all orientations to the regional flow gradient, the maximum absolute discharge occurs at apex angles (the angles between the two funnel walls) of 180 degrees (straight barrier). However, for apex angles between 127 and 233 degrees, there is little effect on discharge. Outside this range, the discharge drops rapidly. This result implies that there is no significant advantage of a slightly angled funnel-and-gate system over a straight barrier (and vice versa).
- For all apex angles, the maximum discharge occurs when the funnel is perpendicular to the regional flow gradient.
- The groundwater flow models can be used effectively to design the funnel-and-gate systems at sites with special design requirements due to complex flow fields, seasonal fluctuations, or access restrictions. These may include systems with angled funnels, multiple gates, asymmetrical funnels, or U-shaped funnel-and-gates.
- A balance between maximizing the capture zone of the gate and maximizing the residence times of contaminated water in the gate should be achieved. The discharge and residence times are inversely proportional. The residence time generally can be increased without affecting the capture zone by increasing the width of the gate.

Shikaze (1996) used the FRAC3DVS code to examine 3-D groundwater flow in the vicinity of a partially penetrating (hanging wall) funnel-and-gate system for 16 different combinations of parameters. All simulations were for steady-state, fully saturated groundwater flow. The 16 simulations consisted of variations in four dimensionless parameters: the ratio of K_{cell} to

K_{aquifer} ; the ratio of width of a single funnel wall to the depth of the funnel-and-gate; the ratio of total funnel wall width to the gate width; and the hydraulic gradient. The following conclusions were drawn from these simulations:

- ❑ Absolute discharge through the gate increases as the hydraulic gradient increases. However, there is almost no effect of hydraulic gradient on the relative discharge or on the size of the relative capture zone (hydraulic capture zone width/total width of funnel-and-gate).
- ❑ For higher values of K_{cell} vs. K_{aquifer} , there is an increase in absolute and relative discharge through the gate as well as in the relative size of the capture zone. Thus, a higher K_{cell} tends to draw more flow toward the gate.
- ❑ Higher values for the ratio of width of the single funnel wall (one wing) to the depth of the funnel-and-gate system result in lower absolute and relative discharge, and in smaller capture zones. This is because, for cases of wide but shallow funnel walls, there is an increase in the flow component that is diverted under the barrier rather than through the gate.
- ❑ Higher values for the ratio of total funnel wall width to the width of the gate result in higher absolute discharge but lower relative discharge and smaller hydraulic capture zones. This result implies that, for wider funnel walls, the increase in the discharge through the gate is not proportional to the increase in the funnel wall area.

C.4 Hydraulic Evaluation of Funnel-and-Gate Systems

The section includes a detailed hydraulic evaluation of a typical funnel-and-gate configuration in a homogeneous setting. It also illustrates a modeling approach that may be used to design the location, configuration, and dimensions of such a PRB and determine the appropriate monitoring configuration. MODFLOW can be used to develop a steady-state numerical approximation of the groundwater flow field and to calculate flow budgets through the gate. Particle tracking techniques under advective flow conditions only can be used to delineate capture zones and travel times in the vicinity of the funnel-and-gate. RWL3D[®] (Prickett et al., 1981) or any similar particle-tracking code could be used to simulate particle pathways. The model simulations can be performed to aid in both the design phase and the evaluation phase of PRB systems for the containment and remediation of contaminated groundwater. These simulations can build upon previous modeling efforts conducted by Starr and Cherry (1994). Specific objectives can include determining how changes in gate conductivity over time affected capture zone width, retention times for groundwater moving through the reactive cell, and flow volumes through the gate.

The model domain and grid size typically is determined based on the site-specific conditions. The primary criteria are that the domain should be large enough so that the boundary conditions do not affect flow in the vicinity of the PRB. Further, the model cell size in the vicinity of the PRB should be small enough to provide sufficient resolution for retention time calculations. The funnel-and-gate configuration modeled in this illustration is the pilot-scale PRB at former NAS Moffett Field (see Figure C-1). The funnel consists of two 20-ft lengths of sheet piling oriented perpendicular to flow on either side of a 10-ft by 10-ft reactive cell representing the gate. The reactive cell is bounded on its sides by 10-ft lengths of sheet piling. The gate itself consists of

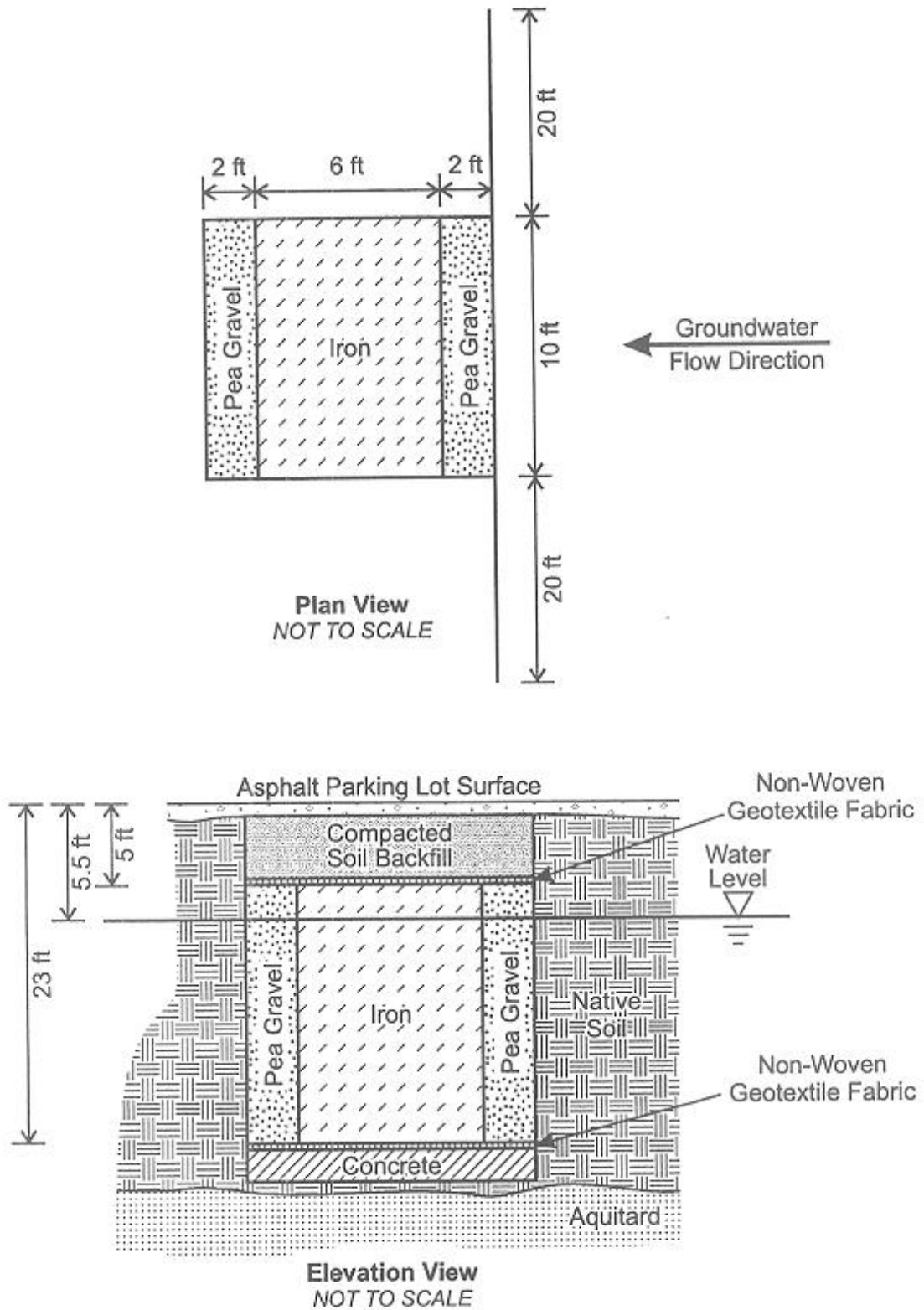

Figure C-1. Pilot-Scale Funnel-and-Gate System Installed at Former NAS Moffett Field, CA (Courtesy of PRC, 1996)

2 ft of ¾-inch pea gravel located on both the upgradient and downgradient ends of the reactive cell, which has a 6-ft flowthrough thickness of iron.

For this model of a funnel-and-gate system, the domain consisted of a single layer that is 500 ft long and 300 ft wide. The grid had 98 rows and 106 columns, resulting in a total of 10,388 nodes. Grid nodes were 10 ft by 10 ft at their maximum (in the general domain area) and 0.5 ft by 0.5 ft in the region of the gate itself. Specified head nodes were set along the first and last rows of the model to establish a gradient of 0.006. No flow conditions were set along the first and last columns of the model.

The funnel (sheet piling) was simulated as a horizontal flow barrier having a K of 2.0×10^{-6} ft/day. For the continuous reactive barrier configuration, the funnel may be excluded from the model. The pea gravel was assigned a K of 2,830 ft/d. The reactive cell consisting of granular iron was assigned a K of 283 ft/d, the maximum laboratory-measured value for 100% iron. It should be noted that in some modeling studies (e.g., Thomas et al., 1995), a reactive cell with K of 142 ft/d has been used for 100% iron. In general, the K value for the reactive medium should be determined from laboratory permeability testing. Porosity was held constant at 0.30 for all materials in each of the simulations.

For this illustration, simulated K_{aquifer} was varied among 0.5, 1, 2, 5, 10, 20, 50, and 100 ft/d to represent low- and high-permeability aquifers. Once this base scenario was established, simulations were conducted to evaluate reductions in K_{cell} over time that could potentially be caused by buildup of precipitates. To determine the effects of decreased permeability of the gate over a period of operation, K_{cell} was reduced in 10% increments from the initial 283 ft/d to 28.3 ft/d for each value of K_{aquifer} . An additional set of simulations was performed with K_{cell} reduced by 95% to 14.15 ft/d, resulting in a total of 11 simulations for each value of K_{aquifer} . For each individual simulation, a single value for K_{aquifer} was used. The effects of geologic heterogeneities were not considered in these simulations. The results from the 88 simulations were used to evaluate the impact of variations in K_{cell} and K_{aquifer} on capture zone width, flow volumes, and travel times through (retention times in) the reactive cell.

Table C-1 lists the model run number, reactive cell conductivity, aquifer conductivity, ratio of reactive cell to aquifer conductivity, capture zone width, residence time within the reactive cell, and groundwater discharge through the reactive cell. Capture zone width in each of the simulations was determined by tracking particles forward through the reactive cell. Two hundred particles (1 particle every 0.5 ft) were initiated along a 100-ft-long line source upgradient from the PRB. The location of the flow divides between particles passing through the reactive cell and those passing around the ends of the funnel were used to determine capture zone width. Residence time within the reactive cell for each simulation was determined from the length of time required for the particles to pass through it. Figure C-2 illustrates the determination of flow divides and travel times for simulation number 57, which had an aquifer conductivity of 20 ft/d and a reactive cell conductivity of 283 ft/d. Particle pathlines have been overlain onto the calculated water-table surface. Particle pathlines and intermediate time steps within the reactive cell are also shown. In some cases, there may be significant variation in residence times at the edges of the reactive cell and at its center. For example, Vogan et al. (1994) showed that

Table C-1. Summary of Funnel-and-Gate Model Runs

| Run # | K_{cell} (ft/day) | K_{aquifer} (ft/day) | Ratio of K_{cell}· K_{aquifer} | Capture Width (ft) | Discharge (ft³/day) | Residence Time (days) | Relative Discharge |
|--------------|--------------------------------------|---|---|-----------------------------------|---|--------------------------------------|-------------------------------|
| 1 | 283 | 0.1 | 2,830.00 | NA | NA | NA | NA |
| 2 | 283 | 0.5 | 566.00 | 34 | 2.356 | 219.0 | 1.000 |
| 3 | 255 | 0.5 | 509.40 | NA | 2.356 | 220.0 | 1.000 |
| 4 | 226 | 0.5 | 452.80 | NA | 2.355 | 218.0 | 1.000 |
| 5 | 198 | 0.5 | 396.20 | NA | 2.355 | 219.0 | 1.000 |
| 6 | 170 | 0.5 | 339.60 | NA | 2.354 | 220.0 | 0.999 |
| 7 | 142 | 0.5 | 283.00 | NA | 2.354 | 219.0 | 0.999 |
| 8 | 113 | 0.5 | 226.40 | NA | 2.353 | 218.0 | 0.999 |
| 9 | 85 | 0.5 | 169.80 | NA | 2.352 | 220.0 | 0.998 |
| 10 | 57 | 0.5 | 113.20 | NA | 2.350 | 220.0 | 0.998 |
| 11 | 28 | 0.5 | 56.60 | NA | 2.344 | 220.0 | 0.995 |
| 12 | 14 | 0.5 | 28.30 | NA | 2.334 | NA | 0.991 |
| 13 | 283 | 1 | 283.00 | 32.75 | 4.732 | 107.0 | 1.000 |
| 14 | 255 | 1 | 254.70 | NA | 4.732 | 107.5 | 1.000 |
| 15 | 226 | 1 | 226.40 | NA | 4.730 | 107.5 | 1.000 |
| 16 | 198 | 1 | 198.10 | NA | 4.729 | 107.5 | 0.999 |
| 17 | 170 | 1 | 169.80 | NA | 4.727 | 107.5 | 0.999 |
| 18 | 142 | 1 | 141.50 | NA | 4.725 | 107.5 | 0.998 |
| 19 | 113 | 1 | 113.20 | NA | 4.721 | 107.5 | 0.998 |
| 20 | 85 | 1 | 84.90 | NA | 4.716 | 107.5 | 0.997 |
| 21 | 57 | 1 | 56.60 | NA | 4.705 | 108.0 | 0.994 |
| 22 | 28 | 1 | 28.30 | NA | 4.672 | 108.5 | 0.987 |
| 23 | 14 | 1 | 14.15 | NA | 4.603 | 110.0 | 0.973 |
| 24 | 283 | 2 | 141.50 | NA | 9.475 | 52.5 | 1.000 |
| 25 | 255 | 2 | 127.35 | NA | 9.472 | 52.5 | 1.000 |
| 26 | 226 | 2 | 113.20 | NA | 9.468 | 52.5 | 0.999 |
| 27 | 198 | 2 | 99.05 | NA | 9.462 | 52.5 | 0.999 |
| 28 | 170 | 2 | 84.90 | NA | 9.455 | 52.5 | 0.998 |
| 29 | 142 | 2 | 70.75 | NA | 9.446 | 52.5 | 0.997 |
| 30 | 113 | 2 | 56.60 | NA | 9.432 | 53.0 | 0.995 |
| 31 | 85 | 2 | 42.45 | NA | 9.408 | 53.0 | 0.993 |
| 32 | 57 | 2 | 28.30 | NA | 9.362 | 53.5 | 0.988 |
| 33 | 28 | 2 | 14.15 | NA | 9.223 | 54.5 | 0.973 |
| 34 | 14 | 2 | 7.08 | NA | 8.954 | 56.0 | 0.945 |
| 35 | 283 | 5 | 56.60 | 32.17 | 23.613 | 21.0 | 1.000 |
| 36 | 255 | 5 | 50.94 | NA | 23.593 | 20.9 | 0.999 |
| 37 | 226 | 5 | 45.28 | NA | 23.568 | 21.0 | 0.998 |
| 38 | 198 | 5 | 39.62 | NA | 23.535 | 21.1 | 0.997 |
| 39 | 170 | 5 | 33.96 | NA | 23.493 | 21.1 | 0.995 |
| 40 | 142 | 5 | 28.30 | NA | 23.432 | 21.1 | 0.992 |
| 41 | 113 | 5 | 22.64 | NA | 23.344 | 21.3 | 0.989 |
| 42 | 85 | 5 | 16.98 | NA | 23.197 | 21.4 | 0.982 |

Table C-1. Summary of Funnel-and-Gate Model Runs (Continued)

| Run # | K_{cell} (ft/day) | K_{aquifer} (ft/day) | Ratio of K_{cell}· K_{aquifer} | Capture Width (ft) | Discharge (ft³/day) | Residence Time (days) | Relative Discharge |
|--------------|--------------------------------------|---|---|-----------------------------------|---|--------------------------------------|-------------------------------|
| 43 | 57 | 5 | 11.32 | NA | 22.909 | 21.6 | 0.970 |
| 44 | 28 | 5 | 5.66 | NA | 22.082 | 22.6 | 0.935 |
| 45 | 14 | 5 | 2.83 | NA | 20.597 | 24.0 | 0.872 |
| 46 | 283 | 10 | 28.30 | 32.17 | 46.407 | 10.6 | 1.000 |
| 47 | 255 | 10 | 25.47 | 32.17 | 46.328 | 10.6 | 0.998 |
| 48 | 226 | 10 | 22.64 | 32.17 | 46.169 | 10.8 | 0.995 |
| 49 | 198 | 10 | 19.81 | 32.33 | 46.040 | 10.7 | 0.992 |
| 50 | 170 | 10 | 16.98 | 32.33 | 45.870 | 10.9 | 0.988 |
| 51 | 142 | 10 | 14.15 | 32.5 | 45.628 | 10.9 | 0.983 |
| 52 | 113 | 10 | 11.32 | 31.5 | 45.274 | 11.0 | 0.976 |
| 53 | 85 | 10 | 8.49 | 31.67 | 44.763 | 11.0 | 0.965 |
| 54 | 57 | 10 | 5.66 | 31.83 | 43.566 | 11.4 | 0.939 |
| 55 | 28 | 10 | 2.83 | 32.17 | 40.562 | 12.3 | 0.874 |
| 56 | 14 | 10 | 1.42 | NA | 35.630 | 13.9 | 0.768 |
| 57 | 283 | 20 | 14.15 | 31.81 | 91.493 | 5.4 | 1.000 |
| 58 | 255 | 20 | 12.74 | NA | 91.239 | 5.4 | 0.997 |
| 59 | 226 | 20 | 11.32 | NA | 91.331 | 5.5 | 0.998 |
| 60 | 198 | 20 | 9.91 | NA | 89.890 | 5.6 | 0.982 |
| 61 | 170 | 20 | 8.49 | NA | 89.262 | 5.6 | 0.976 |
| 62 | 142 | 20 | 7.08 | NA | 88.379 | 5.6 | 0.966 |
| 63 | 113 | 20 | 5.66 | NA | 86.708 | 5.7 | 0.948 |
| 64 | 85 | 20 | 4.25 | NA | 84.126 | 5.8 | 0.919 |
| 65 | 57 | 20 | 2.83 | NA | 78.681 | 6.3 | 0.860 |
| 66 | 28 | 20 | 1.42 | NA | 73.403 | 6.7 | 0.802 |
| 67 | 14 | 20 | 0.71 | NA | 59.502 | 8.3 | 0.650 |
| 68 | 283 | 50 | 5.66 | 31.5 | 221.445 | 2.3 | 1.000 |
| 69 | 255 | 50 | 5.09 | NA | 219.770 | 2.3 | 0.992 |
| 70 | 226 | 50 | 4.53 | NA | 217.730 | 2.3 | 0.983 |
| 71 | 198 | 50 | 3.96 | NA | 215.185 | 2.4 | 0.972 |
| 72 | 170 | 50 | 3.40 | NA | 211.925 | 2.4 | 0.957 |
| 73 | 142 | 50 | 2.83 | NA | 207.005 | 2.4 | 0.935 |
| 74 | 113 | 50 | 2.26 | NA | 200.755 | 2.5 | 0.907 |
| 75 | 85 | 50 | 1.70 | NA | 190.560 | 2.6 | 0.861 |
| 76 | 57 | 50 | 1.13 | NA | 173.695 | 2.9 | 0.784 |
| 77 | 28 | 50 | 0.57 | NA | 136.155 | 3.7 | 0.615 |
| 78 | 14 | 50 | 0.28 | NA | 94.409 | 5.8 | 0.426 |
| 79 | 283 | 100 | 2.83 | 30.38 | 410.105 | 1.3 | 1.000 |
| 80 | 255 | 100 | 2.55 | NA | 404.240 | 1.2 | 0.986 |
| 81 | 226 | 100 | 2.26 | NA | 397.135 | 1.2 | 0.968 |
| 82 | 198 | 100 | 1.98 | NA | 388.355 | 1.3 | 0.947 |
| 83 | 170 | 100 | 1.70 | NA | 377.240 | 1.3 | 0.920 |
| 84 | 142 | 100 | 1.42 | NA | 362.735 | 1.4 | 0.884 |

Table C-1. Summary of Funnel-and-Gate Model Runs (Continued)

| Run # | K_{cell} (ft/day) | K_{aquifer} (ft/day) | Ratio of K_{cell}· K_{aquifer} | Capture Width (ft) | Discharge (ft³/day) | Residence Time (days) | Relative Discharge |
|--------------|--------------------------------------|---|---|-----------------------------------|---|--------------------------------------|-------------------------------|
| 85 | 113 | 100 | 1.13 | NA | 343.060 | 1.5 | 0.837 |
| 86 | 85 | 100 | 0.85 | NA | 314.455 | 1.6 | 0.767 |
| 87 | 57 | 100 | 0.57 | NA | 268.935 | 1.8 | 0.656 |
| 88 | 28 | 100 | 0.28 | NA | 188.075 | 2.7 | 0.459 |
| 89 | 14 | 100 | 0.14 | NA | 116.935 | 4.2 | 0.285 |
| 90 | 283 | 200 | 1.42 | NA | NA | NA | NA |

NA = Not applicable.

simulated residence times in a funnel-and-gate system (with caisson gates) varied from 29 hours at the edges to 82 hours in the center of the reactive cell.

Discharge through the reactive cell was determined from the MODFLOW-calculated, cell-by-cell flow file using the MODUTILITY code zone budget (Harbaugh, 1990). Correlation between $K_{aquifer}$ and K_{cell} , retention time, discharge, and capture zone width were determined by plotting the results of the 88 simulations against one another. Some basic relationships are readily apparent.

Figure C-3 illustrates the correlation between $K_{aquifer}$, retention time, and discharge through the gate. There is an inverse relationship between $K_{aquifer}$ and retention time. As aquifer conductivity increases, the retention time within the reactive cell decreases. As aquifer conductivity increases, the total discharge through the gate increases. Finally, Figure C-3 shows a very strong inverse correlation between the total discharge through the gate and the retention time within the reactive cell. Therefore, aquifers having high hydraulic conductivities may require a greater reactive cell flowthrough thickness to meet residence time requirements so that contaminant levels can be reduced to regulatory limits.

The conductivities of both the aquifer and the reactive cell were plotted against capture zone width. A general correlation exists between an increase in K (and discharge through the gate) and capture-zone width. As K increased, the capture-zone width generally increased. However, the capture zone width appeared to be more sensitive to the length of the funnel walls and was generally observed to occur at just over half of the funnel wall length on either side of the gate. Capture zone widths ranged from roughly 0.2 to 2 ft beyond the midpoint of the funnel wall. Figure C-4 is a plot showing the reduction in discharge (due to potential buildup of precipitate) through the gate that results from decreasing K_{cell} at aquifer conductivities of 0.5, 10, and 100 ft/d. In each of the plots shown in Figure C-4, K_{cell} decreases from 283 ft/d to 14.15 ft/d. Reductions in K_{cell} were simulated to represent the potential clogging of the reactive cell by precipitation. The percent decline in discharge through the gate was determined for each decline in K_{cell} . When aquifer conductivity is 0.5 ft/d, the reactive cell conductivity is much greater than the aquifer conductivity for each of the 11 simulations performed, and the percent decline in discharge through the gate is very small. Decreasing reactive cell conductivity from 283 ft/d to

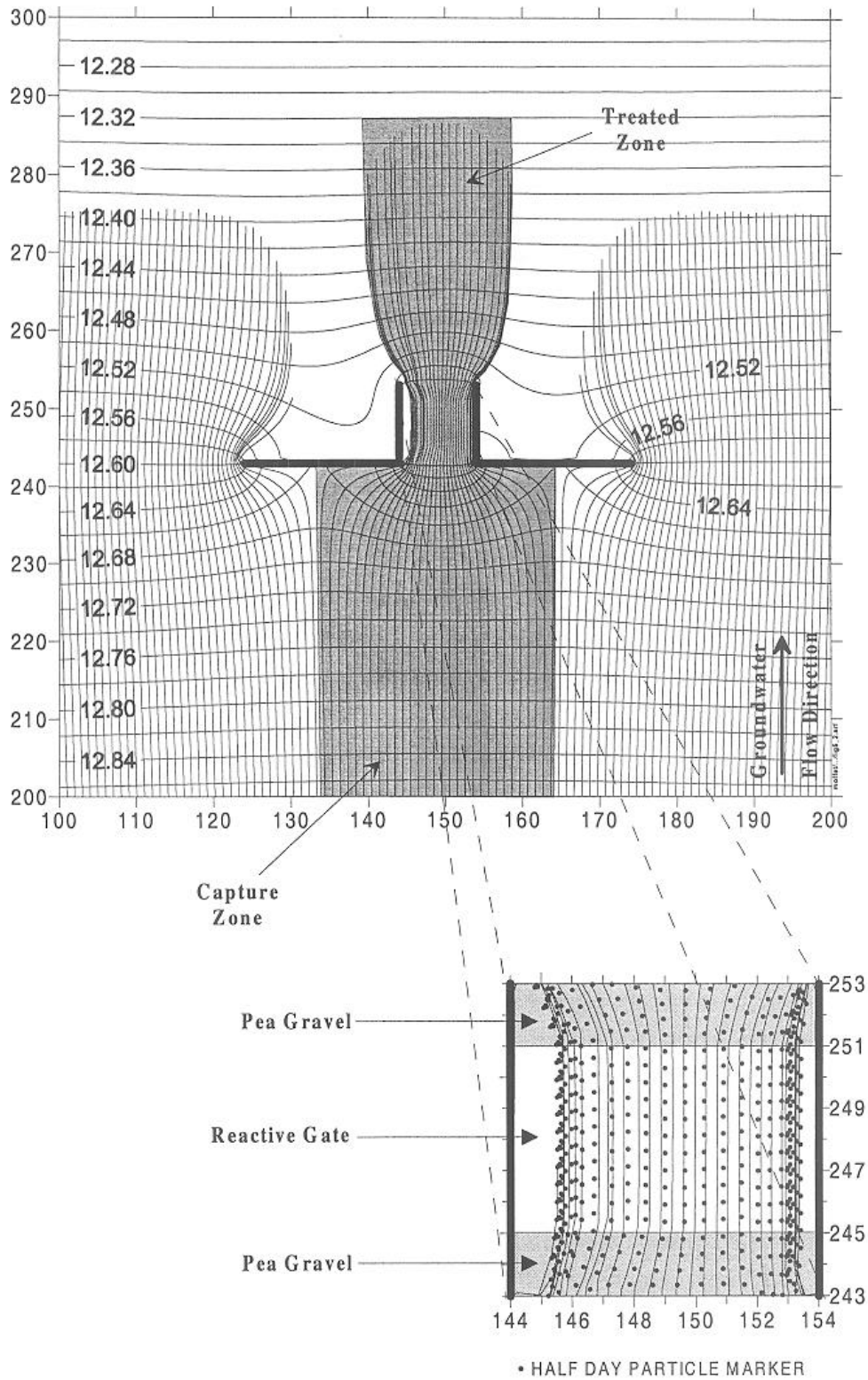
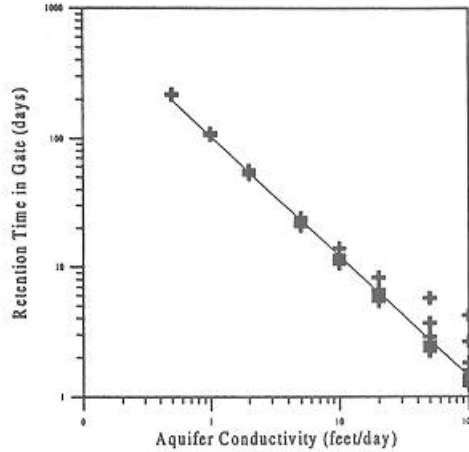
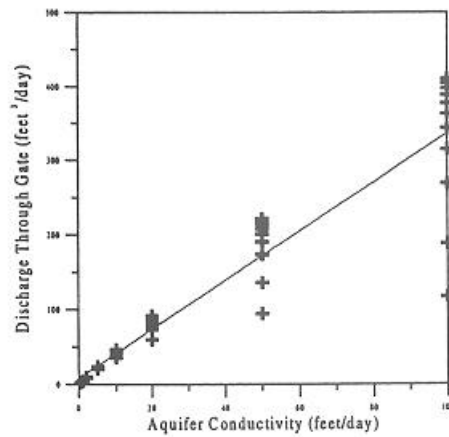

Figure C-2. Simulated Particle Pathlines Overlain upon Water Table Including Zoomed in View of Gate Area

(a) K_{aquifer} versus retention time



(b) K_{aquifer} versus discharge



(c) Retention time versus discharge

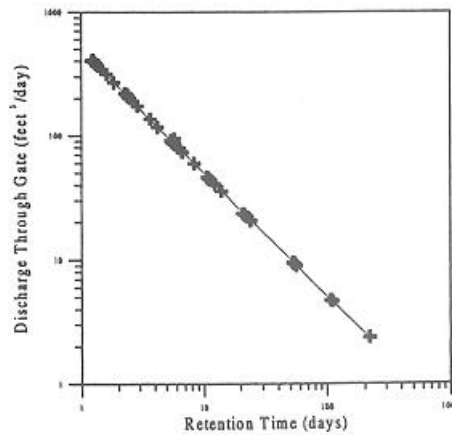

Figure C-3. Correlation Between K_{aquifer} , Discharge, and Travel Time Through the Gate for a Homogeneous, One-Layer Scenario

14.15 ft/d resulted in only a 1% decline in the discharge through the gate. As aquifer conductivity was increased, a larger reduction in discharge through the gate occurred as the reactive cell conductivity decreased. For aquifer conductivities of 10 and 100 ft/d, discharge through the gate decreased by roughly 27 and 71%, respectively, over the same decline in gate conductivity. In

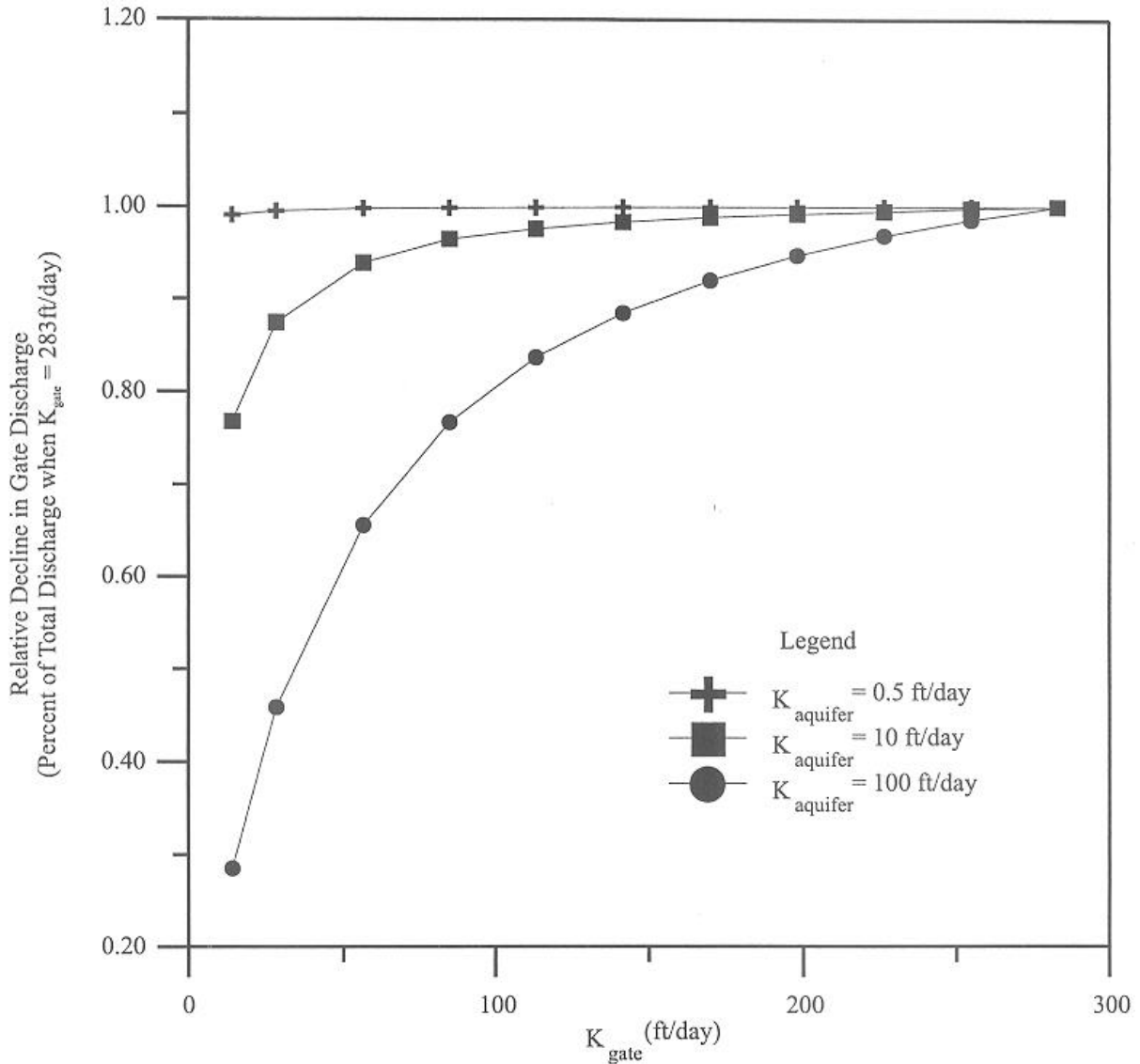

Figure C-4. Correlation Between K_{cell} and Discharge at $K_{aquifer}$ of 0.5, 10, and 100 ft per day K_{cell} Varied Between 283 and 14.15 ft per day

both cases, the ratio of K_{cell} to $K_{aquifer}$ approaches or becomes less than 1 as K_{cell} decreases. Therefore, the effects of precipitate buildup in the reactive cell are likely to be felt earlier in high-permeability aquifers. However, as discussed below, there is considerable leeway before such effects are noticed.

Figure C-5 is a plot of the ratio of K_{cell} to $K_{aquifer}$ versus discharge through the gate for the 88 simulations. The plot indicates that declines in reactive cell conductivity due to clogging have very little influence on the volume of groundwater passing through the gate as long as the reactive cell conductivity is roughly 5 times the conductivity of the aquifer. In these instances, discharge through the gate remained at roughly 95% of the simulated discharge when the gate

conductivity was 283 ft/d. Because discharge is relatively unaffected, residence times and capture zone width will remain relatively unchanged for a given aquifer conductivity. As the ratio between K_{cell} and K_{aquifer} declines below 5, the relative decrease in discharge becomes greater and results in decreased capture zone widths and increased retention times. Thus, as long as the hydraulic conductivity of a freshly installed reactive cell is designed to be one or two orders of magnitude greater than the hydraulic conductivity of the aquifer, there is considerable flexibility for precipitates to build up without significantly affecting the hydraulic capture zone.

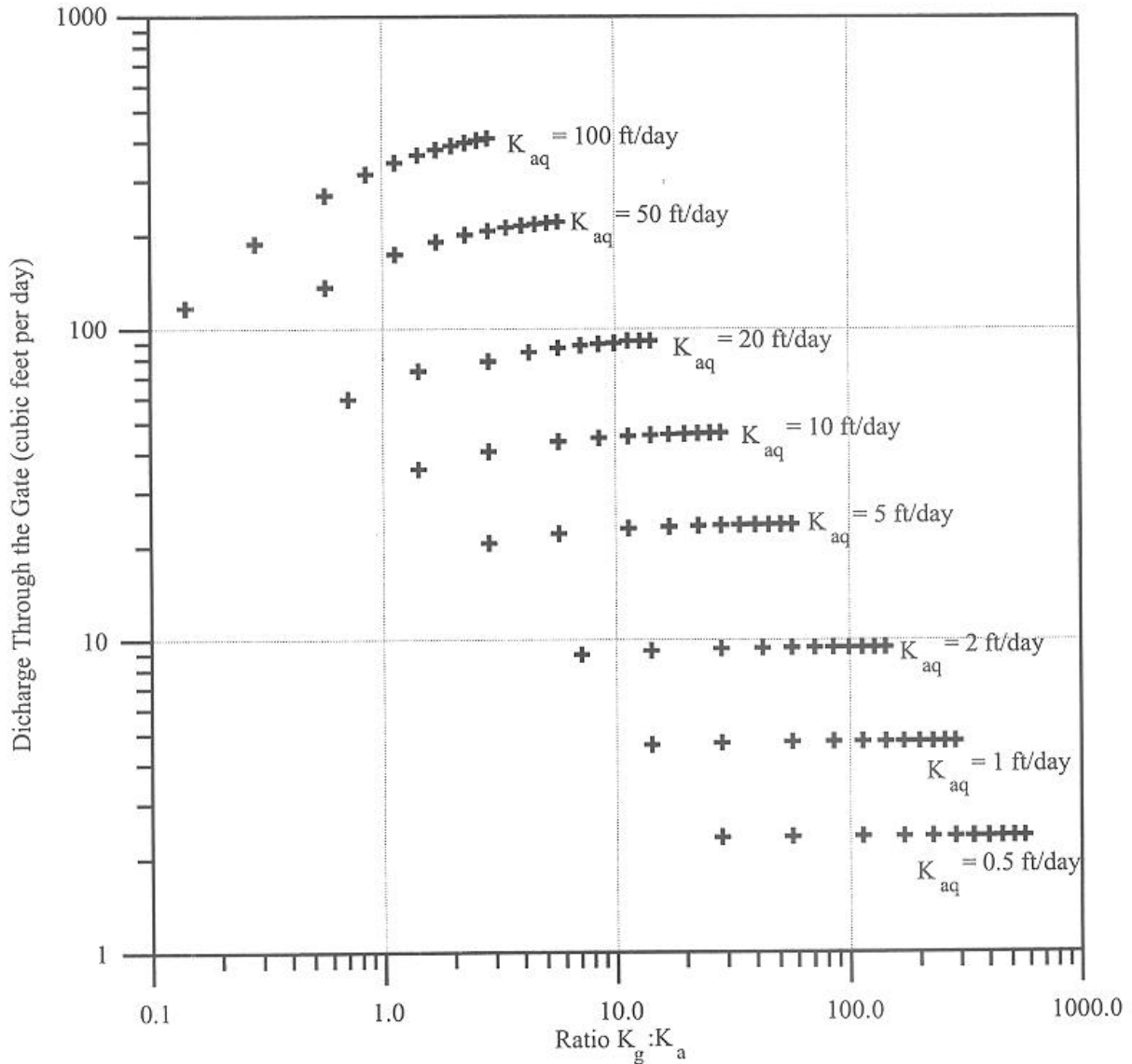

Figure C-5. Correlation Between Ratio of K_{cell} to K_{aquifer} Versus Discharge Through the Gate for a Homogeneous, One-Layer Scenario

C.5 References

- Anderson, M.P. and W.W. Woessner. 1992. *Applied Groundwater Modeling: Simulation of Flow and Advective Transport*. Academic Press, NY.
- Battelle. 1996. *Draft Evaluation of Funnel-and-Gate Pilot Study at Moffett Federal Airfield with Groundwater Modeling*. Prepared for the U.S. Department of Defense, Environmental Security Technology Certification Program and Naval Facilities Engineering Services Center, Port Hueneme, CA. September 11.
- Battelle. 1997. *Design/Test Plan: Permeable Barrier Demonstration at Area 5, Dover AFB*. Prepared for Air Force Research Laboratory, Tyndall AFB. November 14.
- Brigham Young University. 1996. *GMS: Department of Defense Groundwater Modeling System, Version 2.0*.
- Environmental Simulations, Inc. 1996. *Groundwater Vistas*.
- Everhart, D. 1996. *Theoretical Foundations of GROWFLOW*. ARA-TR-96-5286-3. Prepared by Applied Research Associates, Inc. for U.S. Air Force, Tyndall Air Force Base. April.
- Guiguer, N., J. Molson, E.O. Frind, and T. Franz. 1992. *FLONET—Equipotential and Streamlines Simulation Package*. Waterloo Hydrogeologic Software and the Waterloo Center for Groundwater Research, Waterloo, Ontario.
- Gupta, N., and T.C. Fox. 1999. “Hydrogeologic Modeling for Permeable Reactive Barriers.” *Journal of Hazardous Materials*, 68: 19-39.
- Harbaugh, A.W. 1990. *A Computer Program for Calculating Subregional Water Budgets Using Results from the U.S. Geological Survey Modular Three-Dimensional Finite-Difference Ground-Water Flow Model*. United States Geological Survey Open-File Report 90-392.
- Hatfield, K. 1996. *Funnel-and-Gate Design Model*. ARA-TR-96-5286-4. Prepared by Applied Research Associates, Inc. for U.S. Air Force, Tyndall Air Force Base. April.
- Hsieh, P.A., and J.R. Freckleton. 1993. *Documentation of a Computer Program to Simulate Horizontal-Flow Barriers Using the U.S. Geological Survey Modular Three-Dimensional Finite-Difference Ground-Water Flow Model*. United States Geological Survey Open-File Report 92-477.
- Kipp, Jr., K.L. 1987. *HST3D: A Computer Code for Simulation of Heat and Solute Transport in Three-Dimensional Groundwater Flow Systems*. WRI 86-4095. United States Geological Survey, Denver, CO.
- McDonald, M.G., and A.W. Harbaugh. 1988. *A Modular Three-Dimensional Finite-Difference Ground-Water Flow Model: Techniques of Water-Resources Investigations of the United States Geological Survey*. Book 6.

Naymik, T.G., and N.J. Gantos. 1995. Solute Transport Code Verification Report for RWLK3D, Internal Draft. Battelle Memorial Institute, Columbus, OH.

Pollock, D.W. 1989. *Documentation of Computer Programs to Compute and Display Pathlines Using Results from the U.S. Geological Survey Modular Three-Dimensional Finite-Difference Ground-Water Flow Model*. United States Geological Survey Open-File Report 89-381.

PRC, see PRC Environmental Management, Inc.

PRC Environmental Management, Inc. 1996. *Naval Air Station Moffett Field, California, Iron Curtain Area Groundwater Flow Model*. June.

Prickett, T.A., T.G. Naymik, and C.G. Lounquist. 1981. *A "Random Walk" Solute Transport Model for Selected Groundwater Quality Evaluations*. Illinois Department of Energy and Natural Resources, Illinois State Water Survey, Bulletin 65.

Rumbaugh, J.O., III. 1993. ModelCad³⁸⁶: *Computer-Aided Design Software for Groundwater Modeling, Version 2.0*. Geraghty & Miller, Inc., Reston, VA.

Shikaze, S. 1996. *3D Numerical Modeling of Groundwater Flow in the Vicinity of Funnel-and-Gate Systems*. ARA-TR-96-5286-1. Prepared by Applied Research Associates, Inc. for U.S. Air Force, Tyndall Air Force Base. April.

Starr, R.C., and J.A. Cherry. 1994. "In Situ Remediation of Contaminated Ground Water: The Funnel-and-Gate System." *Groundwater*, 32(3): 465-476.

Therrien, R. 1992. "Three-Dimensional Analysis of Variably-Saturated Flow and Solute Transport in Discretely-Fractured Porous Media." Ph.D. thesis, Dept. of Earth Science, University of Waterloo, Ontario, Canada.

Therrien, R., and E. Sudicky. 1995. "Three-Dimensional Analysis of Variably-Saturated Flow and Solute Transport in Discretely-Fractured Porous Media." *Jour. of Contaminant Hydrology*, 23: 1-44.

Thomas, A.O., D.M. Drury, G. Norris, S.F. O'Hannesin, and J.L. Vogan. 1995. "The In-Situ Treatment of Trichloroethene-Contaminated Groundwater Using a Reactive Barrier-Result of Laboratory Feasibility Studies and Preliminary Design Considerations." In Brink, Bosman, and Arendt (Eds.), *Contaminated Soil '95*, pp. 1083-1091. Kluwer Academic Publishers.

van der Heijde, P.K.M., and O.A. Elnaway. 1993. *Compilation of Groundwater Models*. EPA/600/2-93/118. U.S. EPA's R.S. Kerr Environmental Research Laboratory, Ada, OK.

Vogan, J.L., J.K. Seaberg, B.G. Gnabasik, and S. O'Hannesin. 1994. "Evaluation of In-Situ Groundwater Remediation by Metal Enhanced Reductive Dehalogenation Laboratory Column Studies and Groundwater Flow Modeling." 87th Annual Meeting and Exhibition of the Air and Waste Association, Cincinnati, OH, June 19-24, 1994.

Wang, H.F., and M.P. Anderson. 1982. *Introduction to Groundwater Modeling: Finite Difference and Finite Element Methods*. W.H. Freeman and Company, NY.

Waterloo Hydrogeologic, Inc. 1999a. *FLOWPATH II for Windows 95/NT*.

Waterloo Hydrogeologic, Inc. 1999b. *Visual MODFLOW User's Manual*.

Zheng, C. 1989. *PATH3D*. S.S. Papadopoulos and Assoc., Rockville, MD.

Appendix D

Geochemical Modeling

D.1 Equilibrium Modeling

D.2 Forward Equilibrium Modeling

D.3 Inverse Modeling

D.4 References

Appendix D

Geochemical Modeling

D.1 Equilibrium Modeling

Equilibrium modeling can be conducted using only site characterization data; influent and effluent analysis of groundwater from a column test is not required. Equilibrium geochemical modeling has been used in a few cases to make predictions about mineral precipitation in PRBs at former Naval Air Station (NAS) Moffett Field, CA; Dover Air Force Base (AFB), DE; and former Lowry AFB, CO (Battelle, 1998; Battelle, 1999; Sass and Gavaskar, 1999). The primary disadvantage of equilibrium modeling is that reaction kinetics and nonequilibrium behavior are not taken into account. Therefore, although equilibrium modeling may serve as a qualitative tool to indicate the type of precipitates that may form in a given system, the results should not be taken as a quantitative assessment of all the processes that would be occurring inside a PRB.

Reaction path modeling is one form of equilibrium modeling that can serve a useful predictive purpose when one of the components is not in equilibrium with the system. (It is assumed that the other components reach equilibrium at each step of the reaction.) The geochemical modeling code PHREEQC (Parkhurst 1995) was used to conduct these simulations. Thermodynamic data were obtained from the MINTEQ database (Allison et al., 1991). Selected equilibrium constants that are relevant to this study are shown in Table D-1. To illustrate this approach, a simulation was run using native groundwater near the former NAS Moffett Field PRB. The groundwater was allowed to react incrementally with pure iron until equilibrium was reached. This approach was used because iron is unlikely to react completely with the groundwater and the extent of reaction cannot be determined *a priori* (i.e., without experimental data for a particular type of iron under site-specific conditions). Results of the reaction path model are shown in Figures D-1 to D-4.

Figure D-1 shows that pH increases until a plateau is reached at about pH 11.2. This plateau begins after approximately 1 gram of iron has dissolved per liter of pore water (g Fe/L). The plateau continues to about 2.7 g Fe/L have dissolved, at which point the pH increases somewhat further. Equilibrium is reached with respect to the iron after approximately 3.4 g Fe/L have dissolved. Also shown in Figure D-1 is the trend in redox potential (Eh), which is symmetrical to the pH behavior. At the plateau region, Eh is approximately -520 millivolts (mV). At equilibrium, the Eh decreases to almost -700 mV. It should be emphasized that true equilibrium with respect to the iron may not actually be reached in a real system. The kinetics of the iron reaction may be affected by the groundwater constituents, some of which may cause the iron surface to become passivated.

Figure D-2 shows that a number of iron-rich solids may precipitate, and in some cases dissolve, as the iron continues to react with the groundwater. The first phases to form are ferrous siderite (FeCO_3) and marcasite (FeS_2). As the reaction progresses, marcasite becomes unstable and is replaced by mackinawite (FeS), which contains a more reduced form of sulfur. Also, siderite later dissolves and the ferric compounds $\text{Fe}(\text{OH})_3$ and “green rust” form. In this example, green rust appears to account for a small loss of Cl ions. Note that $\text{Fe}(\text{OH})_2$ does not form during any of the quasi-equilibrium steps, which is a result that contrasts with the expected appearance of

Table D-1. Mineral Equilibrium Reactions Used in Geochemical Modeling Calculations

| Mineral | Reaction | Log K | delta H (kcal/mol) |
|--------------|--|---------|--------------------|
| Anhydrite | $\text{CaSO}_4 \rightleftharpoons \text{Ca}^{+2} + \text{SO}_4^{-2}$ | -4.637 | -3.769 |
| Aragonite | $\text{CaCO}_3 \rightleftharpoons \text{Ca}^{+2} + \text{CO}_3^{-2}$ | -8.36 | -2.615 |
| Brucite | $\text{Mg}(\text{OH})_2 + 2\text{H}^+ \rightleftharpoons \text{Mg}^{+2} + 2\text{H}_2\text{O}$ | 16.792 | -25.84 |
| Calcite | $\text{CaCO}_3 \rightleftharpoons \text{Ca}^{+2} + \text{CO}_3^{-2}$ | -8.475 | -2.585 |
| Dolomite | $\text{CaMg}(\text{CO}_3)_2 \rightleftharpoons \text{Ca}^{+2} + \text{Mg}^{+2} + 2\text{CO}_3^{-2}$ | -17.0 | -8.29 |
| Fe metal | $\text{Fe} \rightleftharpoons \text{Fe}^{+2} + 2\text{e}^-$ | 15.114 | -21.3 |
| Ferrihydrite | $\text{Fe}(\text{OH})_3 + 3\text{H}^+ \rightleftharpoons \text{Fe}^{+3} + 3\text{H}_2\text{O}$ | 4.891 | 0.0 |
| Goethite | $\text{FeOOH} + 3\text{H}^+ \rightleftharpoons \text{Fe}^{+3} + 2\text{H}_2\text{O}$ | 0.5 | -14.48 |
| Green Rust | $\text{Fe}(\text{OH})_{2.7}\text{Cl}_{0.3} + 2.7\text{H}^+ \rightleftharpoons \text{Fe}^{+3} + 2.7\text{H}_2\text{O} + 0.3\text{Cl}^-$ | -3.04 | 0.0 |
| Gypsum | $\text{CaSO}_4 \cdot 2\text{H}_2\text{O} \rightleftharpoons \text{Ca}^{+2} + \text{SO}_4^{-2} + 2\text{H}_2\text{O}$ | -4.848 | 0.261 |
| Mackinawite | $\text{FeS} + \text{H}^+ \rightleftharpoons \text{Fe}^{+2} + \text{HS}^-$ | -4.648 | 0.0 |
| Magnesite | $\text{MgCO}_3 \rightleftharpoons \text{Mg}^{+2} + \text{CO}_3^{-2}$ | -8.029 | -6.169 |
| Marcasite | $\text{FeS}_2 + 2\text{H}^+ + 2\text{e}^- \rightleftharpoons \text{Fe}^{+2} + 2\text{HS}^-$ | -18.177 | 11.1 |
| Melanterite | $\text{FeSO}_4 \cdot 7\text{H}_2\text{O} \rightleftharpoons \text{Fe}^{+2} + \text{SO}_4^{-2} + 7\text{H}_2\text{O}$ | -2.47 | 2.86 |
| Portlandite | $\text{Ca}(\text{OH})_2 + 2\text{H}^+ \rightleftharpoons \text{Ca}^{+2} + 2\text{H}_2\text{O}$ | 22.675 | -30.69 |
| Siderite | $\text{FeCO}_3 \rightleftharpoons \text{Fe}^{+2} + \text{CO}_3^{-2}$ | -10.55 | -5.328 |

Source: Allison et al. (1991).

$\text{Fe}(\text{OH})_2$ during column testing (Mackenzie et al., 1999). Research conducted at the University of Waterloo and at EnviroMetal Technologies, Inc. (ETI) also suggests that noncarbonate iron precipitates in granular iron are composed mostly of $\text{Fe}(\text{OH})_2$ which is converted over time to magnetite (Odziemkowski et al., 1998). However, the presence of sulfate in former NAS Moffett Field groundwater, which becomes converted to sulfide, is probably the reason that $\text{Fe}(\text{OH})_2$ has no stability region in this water.

Figure D-3 shows the precipitation trends for non-ferrous phases. Note that the predicted order of precipitation is aragonite (or calcite), followed by magnesite, then brucite. The CaCO_3 phase remains stable until about 3.0 g Fe/L have dissolved. Magnesite is stable for only a portion of the reaction, and then dissolves and allows brucite to predominate. Figure D-4 shows the concentrations of various species that form at different pH values. In this figure, pH is dependent on the reaction steps illustrated in Figure D-1.

Another form of equilibrium modeling known as inverse modeling also can be used to evaluate the types and degree of precipitation, and is described in Section D.3. Inverse modeling can be conducted with column test data as well, but may be more suitable for evaluating monitoring data from a field PRB system.

D.2 Forward Equilibrium Modeling

In general, forward equilibrium modeling involves calculating speciation of dissolved constituents and saturation relative to minerals that can exist in the chemical system defined by the input parameters (field parameters and elemental concentrations). The speciation routine simply

Geochemical Modeling of WIC-1 January 1997

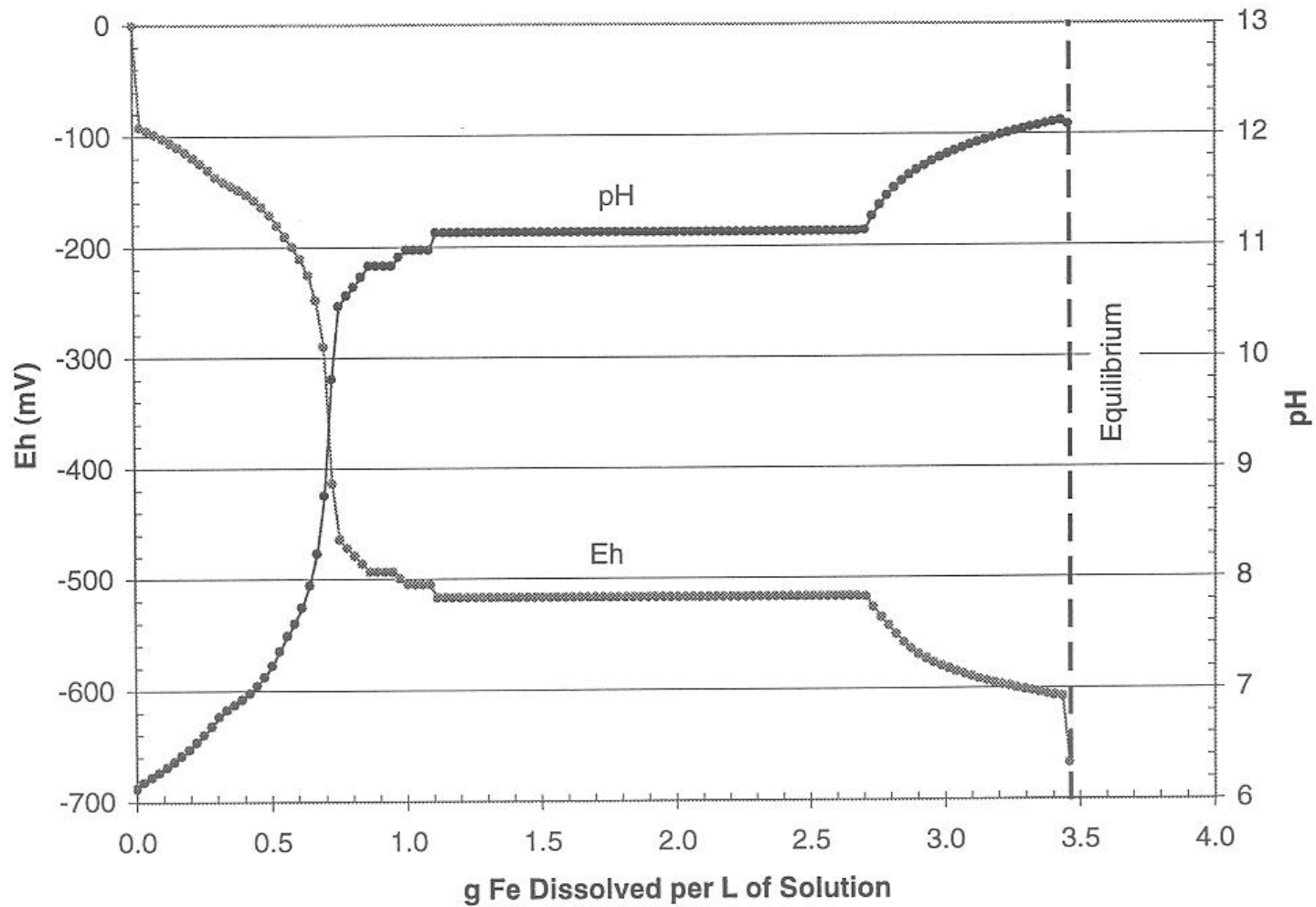

D-3

Figure D-1. pH and Eh Results from Reaction Path Modeling for the Former NAS Moffett Field PRB

Geochemical Modeling of WIC-1 January 1997

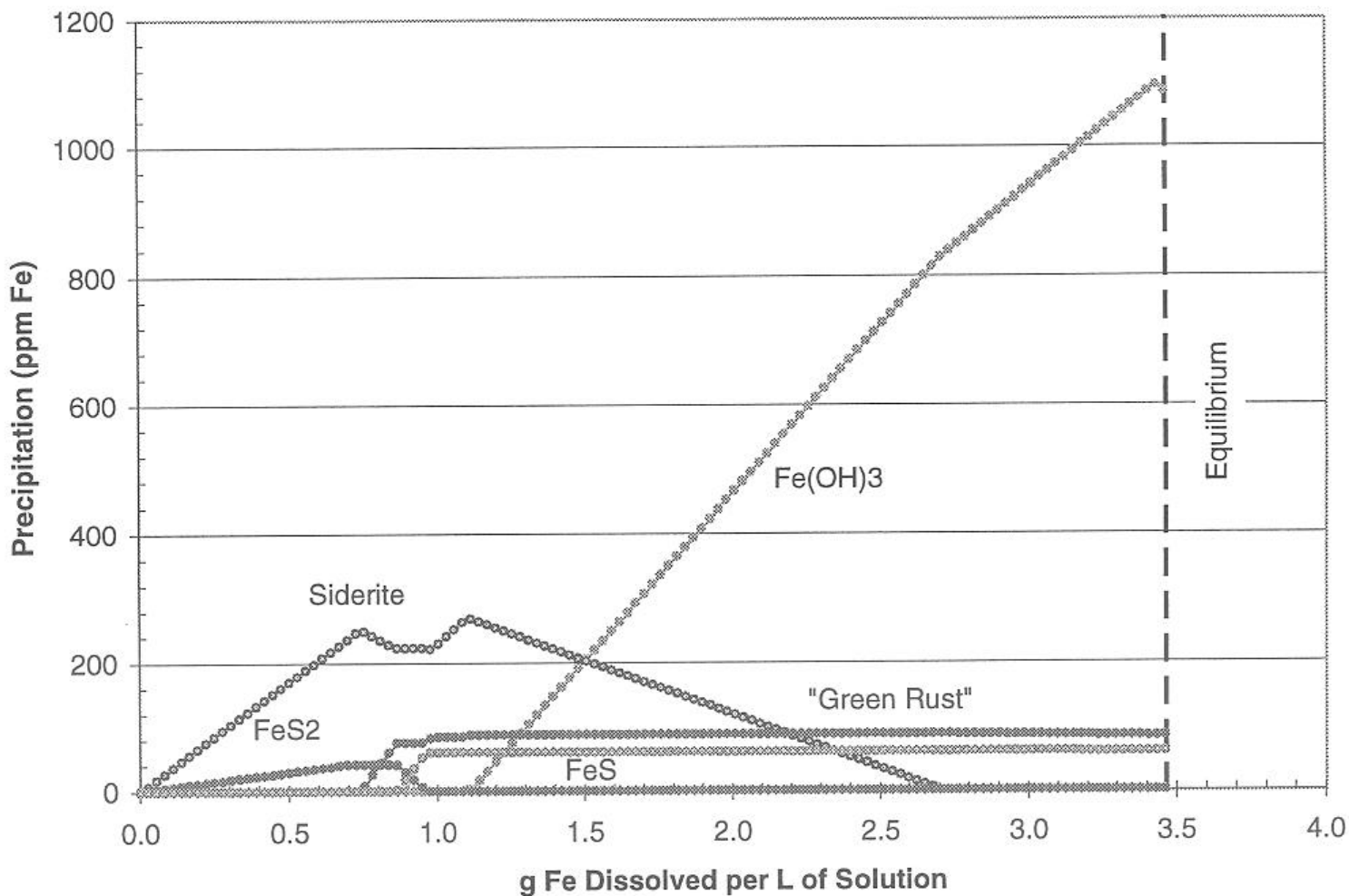

D-4

Figure D-2. Precipitation Trends for Ferrous Solids Determined from Reaction Path Modeling for the Former NAS Moffett Field PRB

Geochemical Modeling of WIC-1 January 1997

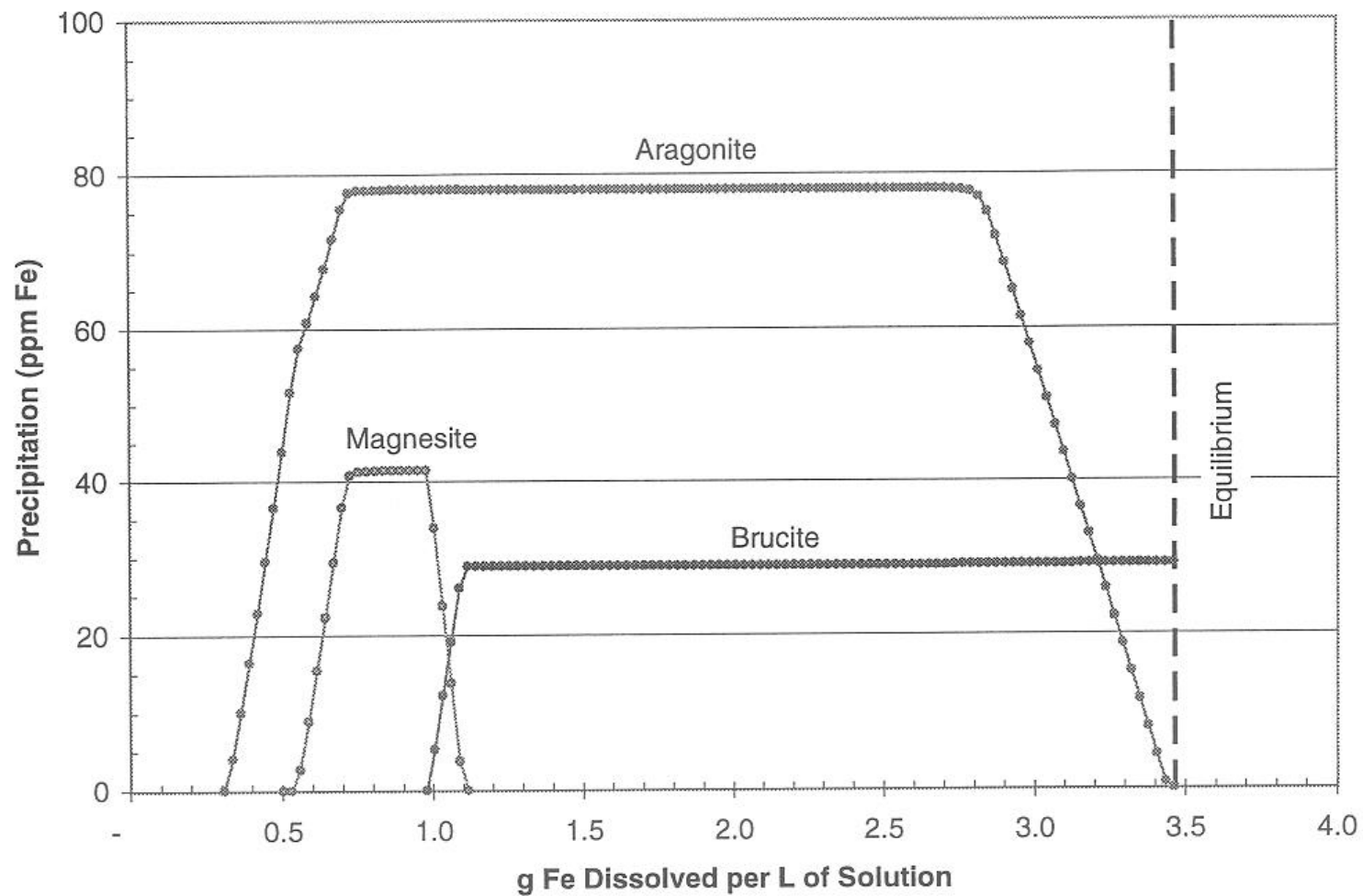

D-5

Figure D-3. Precipitation Trends for Non-Ferrous Solids Determined from Reaction Path Modeling for the Former NAS Moffett Field PRB

Geochemical Modeling of WIC-1 January 1997

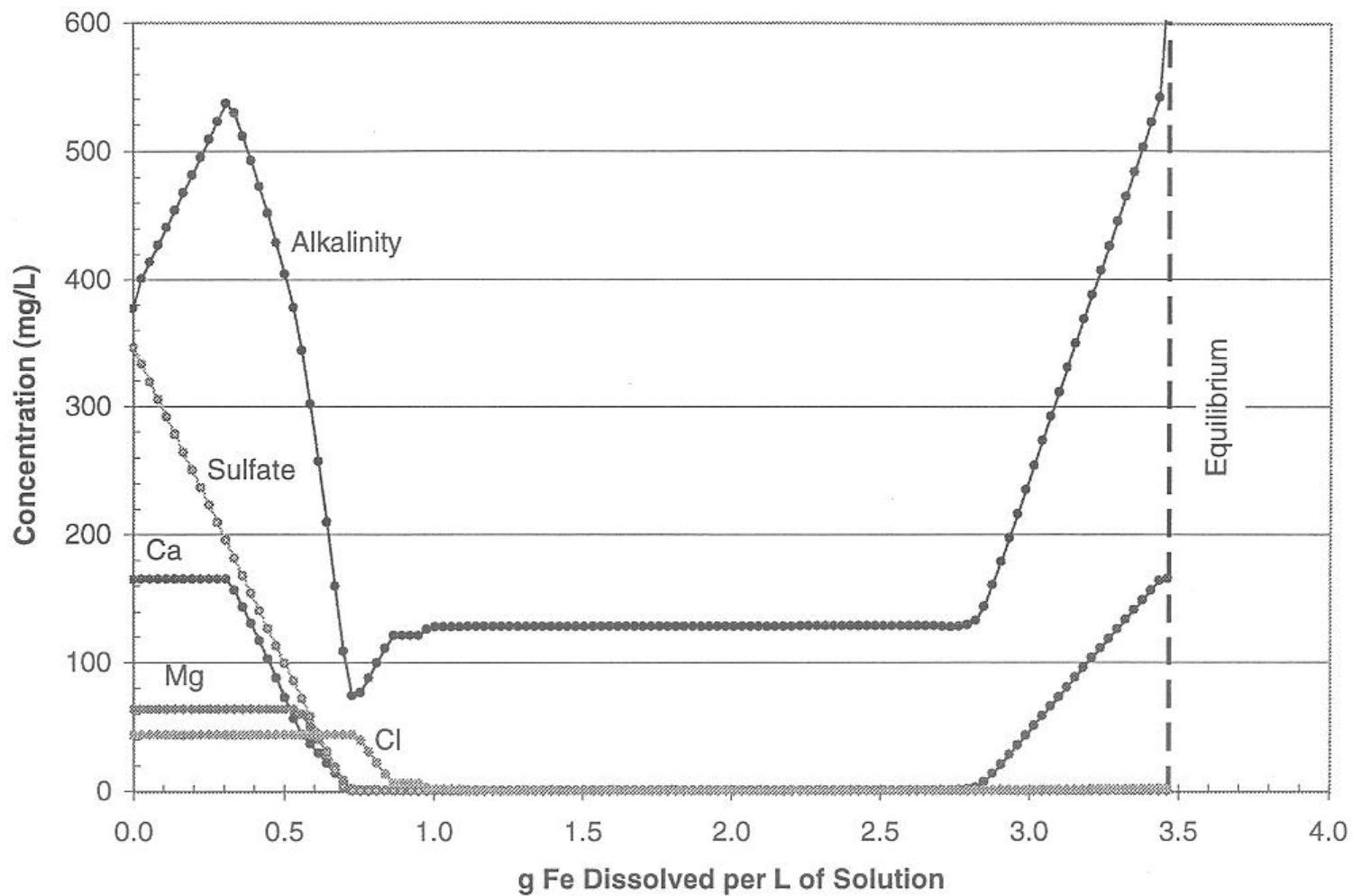

D-6

Figure D-4. Inorganic Indicator Parameter Results from Reaction Path Modeling for the Former NAS Moffett Field PRB

calculates concentrations of all aqueous complexes for which the model has thermodynamic data. Mineral saturation is defined by a saturation index (SI) given by $SI = \log(IAP/K)$, where IAP is ion activity product and K is the thermodynamic equilibrium constant for a mineralogical reaction. When $SI = 0$, the mineral and groundwater are considered to be in equilibrium; negative values imply undersaturation of the mineral phase and positive values imply oversaturation. In practice, mineral equilibrium may be assumed when $SI = \pm 0.20$.

An example of forward equilibrium modeling is described here using monitoring data from former NAS Moffett Field collected in April 1997 (see Table D-2 for a partial list of input data). Calculations of mineral saturation indices were made using the geochemical modeling code PHREEQC (Parkhurst, 1995), and are presented in Table D-3. Values greater than -0.20 in Table D-2 are bolded, indicating probable saturation or oversaturation with respect to the mineral phase.

The data in Table D-3 indicate that saturation indices vary spatially for most minerals within the former NAS Moffett Field PRB. For example, calcite (CaCO_3) is close to equilibrium in the upgradient aquifer and upgradient pea gravel. Calcite becomes slightly oversaturated in the upgradient portion of the reactive cell, then rapidly falls below saturation in the downgradient portion of the reactive cell, as shown in Figure D-5. The horizontal lines in the figure at $SI = \pm 0.20$ indicate a typical saturation range. Aragonite, which has a similar trend of SI values, is metastable with respect to calcite in groundwater environments, but has been observed to precipitate in column tests during prior research. These transitions probably arise due to the abrupt change in pH after the groundwater enters the reactive cell. The SI calculations suggest that water becomes oversaturated with respect to calcite (or aragonite) in the first one or two feet of the reactive cell. The transition to undersaturation indicates that alkalinity or calcium content of the water (or both) decreases to such an extent that CaCO_3 becomes unstable. In other words, when the $SI < 0.2$, insufficient Ca^{+2} and CO_3^{-2} is available to precipitate a solid. This instability could arise because CaCO_3 and other carbonate or calcic minerals have precipitated inside the transition zone.

It may be significant that the transition zone appears to exist a foot or two downgradient of the pea gravel-iron interface, rather than at the interface itself. Because water is flowing through the cell, the apparent lag time suggests that reaction kinetics for precipitation are slow relative to residence time inside the reactive cell (i.e., time-scale is in days). Thus, filling of pore space by precipitates may be distributed over some range in the cell, rather than concentrated along the upgradient face of the reactive cell. Distributing the precipitate buildup over a longer distance may delay the eventual decline in permeability caused by clogging of the pore space.

Magnesite (MgCO_3) and brucite [$\text{Mg}(\text{OH})_2$] show similar trends as calcite: both are undersaturated in the aquifer and upgradient pea gravel, then become oversaturated in the upgradient portion of the reactive cell and undersaturated further downgradient (see Figures D-6 and D-7). Figure D-6 shows that there are no data points in the magnesite stability field, suggesting that magnesite either is oversaturated or undersaturated, but may never actually precipitate. Brucite, on the other hand, does seem to be stable in the upgradient portion of the PRB, like calcite (SI between -0.2 and 0.2), and for this reason may precipitate (see Figure D-7).

Table D-2. Selected Results of Field Parameter Measurements at the Former NAS Moffett Field PRB (April 1997)

| Well ID | pH | Temp (°C) | ORP (mV) ^(a) | Eh (mV) ^(b) | Deep DO (mg/L) ^(c) | Shallow DO (mg/L) ^(d) |
|---|------|-----------|-------------------------|------------------------|-------------------------------|----------------------------------|
| <i>Upgradient A1 Aquifer Zone Wells</i> | | | | | | |
| WIC-1 | 6.8 | 19.9 | 177.2 | 374.2 | < 0.1 | < 0.1 |
| 5 | 7.1 | 20.2 | 144.3 | 341.3 | < 0.1 | 8.8 |
| 6 | 8.8 | 20.2 | 92.2 | 289.2 | < 0.1 | 4.3 |
| 7 | 7.0 | 20.1 | 155.5 | 352.5 | < 0.1 | 0.5 |
| 8 | 7.1 | 20.1 | 157.8 | 354.8 | < 0.1 | 0.7 |
| <i>Upgradient Pea Gravel Wells</i> | | | | | | |
| WW-7A | 7.1 | 20.6 | 101.6 | 298.6 | 0.3 | 2.2 |
| 7B | 7.1 | 20.7 | 122.5 | 319.5 | < 0.1 | 0.7 |
| 7C | 7.1 | 20.5 | 117.1 | 314.1 | < 0.1 | 1.8 |
| 7D | 7.4 | 20.3 | 110.4 | 307.4 | < 0.1 | 1.1 |
| <i>Reactive Cell Wells</i> | | | | | | |
| WW-8A | 10.2 | 20.8 | -343.4 | -146.4 | < 0.1 | 0.3 |
| 8B | 10.2 | 20.9 | -327.5 | -130.5 | < 0.1 | 0.3 |
| 8C | 9.9 | 20.4 | -309.0 | -112.0 | < 0.1 | 0.8 |
| 8D | 11.2 | 20.4 | -359.3 | -162.3 | < 0.1 | 0.7 |
| WW-9A | 10.4 | 20.9 | -626.2 | -429.2 | < 0.1 | 0.2 |
| 9B | 10.4 | 21.1 | -634.8 | -437.8 | < 0.1 | 0.3 |
| 9C | 10.3 | 21.1 | -507.6 | -310.6 | < 0.1 | 0.2 |
| 9D | 11.3 | 20.8 | -665.6 | -468.6 | < 0.1 | 0.3 |
| <i>Downgradient Pea Gravel Wells</i> | | | | | | |
| WW-10A | 9.9 | 20.9 | -554.6 | -357.6 | < 0.1 | < 0.1 |
| 10B | 9.0 | 20.8 | -433.8 | -236.8 | < 0.1 | 0.3 |
| 10C | 9.0 | 20.6 | -351.9 | -154.9 | < 0.1 | 0.3 |
| 10D | 10.5 | 20.7 | -364.5 | -167.5 | < 0.1 | 1.0 |
| <i>Downgradient A1 Aquifer Zone Wells</i> | | | | | | |
| WIC-3 | 6.9 | 20.1 | 62.1 | 259.1 | < 0.1 | 1.8 |
| 9 | 7.1 | 20.4 | -16.4 | 180.6 | 0.2 | 8.6 |
| 10 | 8.4 | 20.4 | -149.7 | 47.3 | < 0.1 | 0.1 |
| 11 | 12.0 | 20.3 | -245.0 | -48.0 | < 0.1 | 4.5 |
| 12 | 7.0 | 20.2 | 9.6 | 206.6 | < 0.1 | 1.0 |
| <i>Downgradient A2 Aquifer Zone Well</i> | | | | | | |
| WIC-4 | 7.1 | 19.9 | 85.1 | 282.1 | < 0.1 | 4.6 |

(a) In situ oxidation-reduction potential (ORP) measured against Ag/AgCl reference electrode.

(b) Eh calculated by adding 197 mV to the ORP measurement.

(c) Dissolved oxygen (DO) measurement at mid-screen or 15 ft below ground surface (bgs).

(d) DO measurement just below water level (~6 ft bgs).

Table D-3. Results of PHREEQC Calculation of Groundwater Saturation Indices^(a)

| Well ID | Anhydrite | Aragonite | Brucite | Calcite | Dolomite | Fe(OH) ₃ | Goethite | Gypsum | Melanterite | Portlandite | Siderite |
|---|-----------|-------------|-------------|-------------|-------------|---------------------|-------------|--------|-------------|-------------|-------------|
| <i>Upgradient A1 Aquifer Zone Wells</i> | | | | | | | | | | | |
| WIC-1 | ! 1.17 | ! 1.14 | ! 7.85 | ! 1.00 | ! 2.13 | ! 5.83 | 0.01 | ! 0.93 | ! 6.86 | ! 13.67 | ! 2.22 |
| WIC-5 | ! 1.13 | ! 3.06 | ! 11.33 | ! 2.91 | ! 6.00 | ! 10.07 | ! 4.21 | ! 0.90 | ! 7.22 | ! 17.08 | ! 4.50 |
| WIC-6 | ! 1.29 | 1.88 | 0.02 | 2.03 | 4.06 | 0.92 | 6.78 | ! 1.06 | ! 16.65 | ! 5.87 | ! 8.82 |
| WIC-8 | ! 1.21 | ! 2.39 | ! 10.24 | ! 2.25 | ! 4.62 | ! 8.72 | ! 2.86 | ! 0.97 | ! 7.43 | ! 16.04 | ! 3.98 |
| <i>Upgradient A2 Aquifer Zone Well</i> | | | | | | | | | | | |
| WIC-2 | ! 1.24 | ! 0.61 | ! 6.54 | ! 0.46 | ! 1.12 | ! 3.27 | 2.58 | ! 1.01 | ! 6.61 | ! 12.29 | ! 1.35 |
| <i>Upgradient Pea Gravel Wells</i> | | | | | | | | | | | |
| WW-2 | ! 1.16 | ! 0.21 | ! 5.98 | ! 0.06 | ! 0.24 | ! 5.49 | 0.36 | ! 0.92 | ! 7.44 | ! 11.80 | ! 1.85 |
| WW-7A | ! 1.19 | ! 0.03 | ! 5.57 | 0.12 | 0.14 | ! 2.64 | 3.21 | ! 0.95 | ! 7.02 | ! 11.42 | ! 1.23 |
| WW-7B | ! 1.17 | ! 0.32 | ! 6.17 | ! 0.17 | ! 0.44 | ! 4.52 | 1.33 | ! 0.94 | ! 7.41 | ! 11.98 | ! 1.91 |
| WW-7C | ! 1.19 | ! 0.31 | ! 5.93 | ! 0.16 | ! 0.41 | 1.23 | 7.10 | ! 0.96 | ! 7.37 | ! 11.74 | ! 1.83 |
| WW-7D | ! 2.70 | ! 1.55 | ! 5.00 | ! 1.41 | ! 1.66 | ! 3.76 | 2.10 | ! 2.47 | ! 7.82 | ! 12.06 | ! 2.03 |
| WW-11 | ! 1.20 | ! 0.21 | ! 5.92 | ! 0.06 | ! 0.22 | ! 3.30 | 2.56 | ! 0.96 | ! 6.65 | ! 11.73 | ! 1.01 |
| WW-16A | ! 1.31 | ! 0.58 | ! 6.28 | ! 0.43 | ! 0.88 | ! 3.39 | 2.46 | ! 1.07 | ! 6.79 | ! 12.20 | ! 1.43 |
| WW-16B | ! 1.23 | ! 0.40 | ! 6.29 | ! 0.25 | ! 0.59 | ! 3.27 | 2.58 | ! 0.99 | ! 6.66 | ! 12.14 | ! 1.20 |
| WW-16C | ! 1.20 | ! 0.08 | ! 5.69 | 0.07 | 0.02 | ! 2.35 | 3.51 | ! 0.96 | ! 6.42 | ! 11.51 | ! 0.67 |
| WW-16D | ! 1.18 | 0.39 | ! 4.68 | 0.54 | 0.98 | ! 2.10 | 3.76 | ! 0.95 | ! 6.79 | ! 10.50 | ! 0.57 |
| <i>Reactive Cell Wells</i> | | | | | | | | | | | |
| WW-1B | ! 1.62 | ! 0.45 | ! 0.57 | ! 0.31 | ! 0.65 | ! 2.99 | 2.85 | ! 1.38 | ! 7.56 | ! 6.49 | ! 1.77 |
| WW-1C | ! 2.49 | ! 0.94 | ! 0.72 | ! 0.80 | ! 0.63 | ! 2.14 | 3.71 | ! 2.25 | ! 7.54 | ! 7.62 | ! 1.36 |
| WW-3 | ! 2.68 | ! 0.17 | ! 1.09 | ! 0.02 | 1.23 | ! 0.85 | 5.01 | ! 2.44 | ! 6.74 | ! 8.29 | 0.41 |
| WW-4A | ! 2.12 | ! 0.94 | ! 3.26 | ! 0.79 | ! 0.93 | ! 4.54 | 1.31 | ! 1.88 | ! 7.15 | ! 9.87 | ! 1.35 |
| WW-4B | ! 2.46 | ! 0.53 | ! 2.37 | ! 0.38 | 0.16 | ! 2.77 | 3.08 | ! 2.22 | ! 7.45 | ! 9.22 | ! 0.89 |
| WW-4C | ! 2.94 | ! 1.15 | ! 3.47 | ! 1.01 | ! 0.69 | ! 5.25 | 0.61 | ! 2.70 | ! 7.46 | ! 10.71 | ! 1.04 |
| WW-4D | ! 1.18 | 1.17 | ! 3.08 | 1.31 | 2.53 | ! 5.23 | 0.63 | ! 0.94 | ! 7.72 | ! 8.90 | ! 0.73 |
| WW-5 | ! 2.57 | ! 1.05 | ! 3.11 | ! 0.90 | ! 1.02 | ! 4.49 | 1.37 | ! 2.33 | ! 7.81 | ! 9.81 | ! 1.65 |
| WW-8A | ! 2.12 | ! 0.31 | ! 2.54 | ! 0.16 | 0.49 | ! 2.85 | 3.00 | ! 1.89 | ! 6.81 | ! 9.28 | ! 0.36 |
| WW-8B | ! 2.48 | 0.05 | ! 1.24 | 0.20 | 1.51 | ! 1.28 | 4.57 | ! 2.24 | ! 7.10 | ! 8.28 | 0.06 |
| WW-8C | ! 2.75 | ! 0.37 | ! 1.94 | ! 0.22 | 0.86 | ! 0.66 | 5.21 | ! 2.52 | ! 7.03 | ! 9.14 | 0.01 |
| WW-8D | ! 2.28 | 0.29 | 0.61 | 0.43 | 1.41 | ! 0.38 | 5.48 | ! 2.04 | ! 8.28 | ! 5.85 | ! 1.08 |
| WW-9A | ! 1.91 | ! 0.84 | ! 2.64 | ! 0.69 | ! 0.93 | ! 4.56 | 1.29 | ! 1.68 | ! 7.02 | ! 9.02 | ! 1.32 |
| WW-9B | ! 2.78 | ! 0.94 | ! 2.14 | ! 0.79 | ! 1.00 | ! 4.09 | 1.76 | ! 2.54 | ! 6.88 | ! 8.69 | ! 0.43 |

Table D-3. Results of PHREEQC Calculation of Groundwater Saturation Indices (Continued)

| Well ID | Anhydrite | Aragonite | Brucite | Calcite | Dolomite | Fe(OH) ₃ | Goethite | Gypsum | Melanterite | Portlandite | Siderite |
|---|-----------|-------------|-------------|-------------|-------------|---------------------|-------------|--------|-------------|-------------|----------|
| <i>Reactive Cell Wells (continued)</i> | | | | | | | | | | | |
| WW-9C | ! 2.71 | ! 1.02 | ! 1.37 | ! 0.87 | ! 0.73 | ! 2.71 | 3.14 | ! 2.47 | ! 7.48 | ! 8.33 | ! 1.16 |
| WW-9D | ! 1.31 | 1.02 | ! 2.88 | 1.17 | 1.26 | ! 5.27 | 0.59 | ! 1.07 | ! 7.95 | ! 7.72 | ! 0.98 |
| WW-12 | ! 2.15 | ! 1.71 | ! 6.06 | ! 1.57 | ! 2.30 | ! 2.14 | 3.71 | ! 1.92 | ! 5.81 | ! 12.83 | ! 0.75 |
| WW-13A | ! 2.11 | ! 2.56 | ! 6.12 | ! 2.42 | ! 4.14 | ! 3.29 | 2.56 | ! 1.87 | ! 6.86 | ! 12.76 | ! 2.69 |
| WW-13B | ! 2.25 | ! 0.60 | ! 1.83 | ! 0.45 | ! 0.09 | ! 4.71 | 1.13 | ! 2.01 | ! 7.52 | ! 8.60 | ! 1.25 |
| WW-13C | ! 2.95 | ! 0.97 | ! 1.37 | ! 0.82 | ! 0.48 | ! 3.53 | 2.32 | ! 2.72 | ! 7.59 | ! 8.45 | ! 0.96 |
| WW-14 | ! 2.05 | ! 0.49 | ! 1.12 | ! 0.34 | ! 0.21 | ! 1.98 | 3.87 | ! 1.81 | ! 6.62 | ! 7.52 | ! 0.42 |
| WW-17A | ! 2.21 | ! 0.19 | ! 1.60 | ! 0.05 | 0.76 | ! 3.75 | 2.10 | ! 1.98 | ! 7.83 | ! 8.39 | ! 1.18 |
| WW-17B | ! 2.42 | ! 2.28 | ! 6.18 | ! 2.13 | ! 3.40 | ! 3.36 | 2.48 | ! 2.18 | ! 7.03 | ! 12.99 | ! 2.27 |
| WW-17C | ! 2.84 | ! 0.56 | ! 0.78 | ! 0.41 | 0.20 | ! 2.62 | 3.24 | ! 2.60 | ! 7.74 | ! 7.72 | ! 0.82 |
| WW-17D | ! 1.94 | ! 1.96 | ! 6.55 | ! 1.81 | ! 3.61 | ! 3.54 | 2.31 | ! 1.70 | ! 7.19 | ! 12.50 | ! 2.59 |
| <i>Downgradient Pea Gravel Zone Wells</i> | | | | | | | | | | | |
| WW-10A | ! 1.57 | ! 0.39 | ! 2.37 | ! 0.25 | ! 0.47 | 1.50 | 7.34 | ! 1.33 | ! 7.97 | ! 8.34 | ! 2.18 |
| WW-10B | ! 1.71 | ! 1.45 | ! 5.22 | ! 1.30 | ! 3.03 | ! 6.39 | ! 0.54 | ! 1.47 | ! 7.54 | ! 10.74 | ! 2.66 |
| WW-10C | ! 1.64 | ! 1.96 | ! 6.23 | ! 1.82 | ! 4.04 | ! 2.79 | 3.05 | ! 1.41 | ! 7.00 | ! 11.77 | ! 2.70 |
| WW-10D | ! 1.63 | ! 1.83 | ! 5.86 | ! 1.69 | ! 3.71 | ! 7.23 | ! 1.37 | ! 1.40 | ! 7.61 | ! 11.44 | ! 3.16 |
| WW-15 | ! 1.98 | ! 2.41 | ! 6.66 | ! 2.27 | ! 4.68 | ! 8.21 | ! 2.35 | ! 1.74 | ! 7.77 | ! 12.42 | ! 3.56 |
| WW-18A | ! 1.66 | ! 0.77 | ! 3.31 | ! 0.62 | ! 1.29 | ! 4.53 | 1.32 | ! 1.43 | ! 6.67 | ! 9.21 | ! 1.15 |
| WW-18B | ! 1.55 | ! 0.07 | ! 2.11 | 0.08 | ! 0.45 | ! 2.97 | 2.88 | ! 1.31 | ! 6.99 | ! 7.43 | ! 0.87 |
| WW-18C | ! 1.95 | 1.49 | 0.29 | 1.64 | 1.68 | ! 0.65 | 5.21 | ! 1.72 | ! 12.05 | ! 4.03 | ! 3.96 |
| WW-18D | ! 1.43 | 0.92 | ! 1.40 | 1.06 | ! 1.15 | ! 1.13 | 4.73 | ! 1.19 | ! 9.04 | ! 4.05 | ! 2.05 |
| <i>Downgradient A1 Aquifer Zone Wells</i> | | | | | | | | | | | |
| WIC-3 | ! 1.17 | ! 0.31 | ! 6.12 | ! 0.16 | ! 0.47 | ! 2.81 | 3.04 | ! 0.94 | ! 6.83 | ! 11.91 | ! 1.33 |
| WIC-9 | ! 1.62 | ! 0.87 | ! 6.42 | ! 0.72 | ! 1.64 | ! 3.99 | 1.86 | ! 1.38 | ! 7.84 | ! 12.16 | ! 2.46 |
| WIC-10 | ! 1.63 | ! 1.02 | ! 4.80 | ! 0.88 | ! 2.39 | 0.68 | 6.53 | ! 1.40 | ! 8.03 | ! 10.11 | ! 2.80 |
| WIC-12 | ! 1.26 | ! 0.40 | ! 5.90 | ! 0.25 | ! 0.68 | ! 3.58 | 2.28 | ! 1.02 | ! 7.48 | ! 11.64 | ! 1.98 |
| <i>Downgradient A2 Aquifer Zone Well</i> | | | | | | | | | | | |
| WIC-4 | ! 1.27 | ! 0.32 | ! 5.92 | ! 0.17 | ! 0.54 | ! 2.39 | 3.45 | ! 1.03 | ! 6.76 | ! 11.67 | ! 1.19 |

(a) Bold values are nonnegative, indicating saturation or oversaturation with respect to the referenced mineral phase.

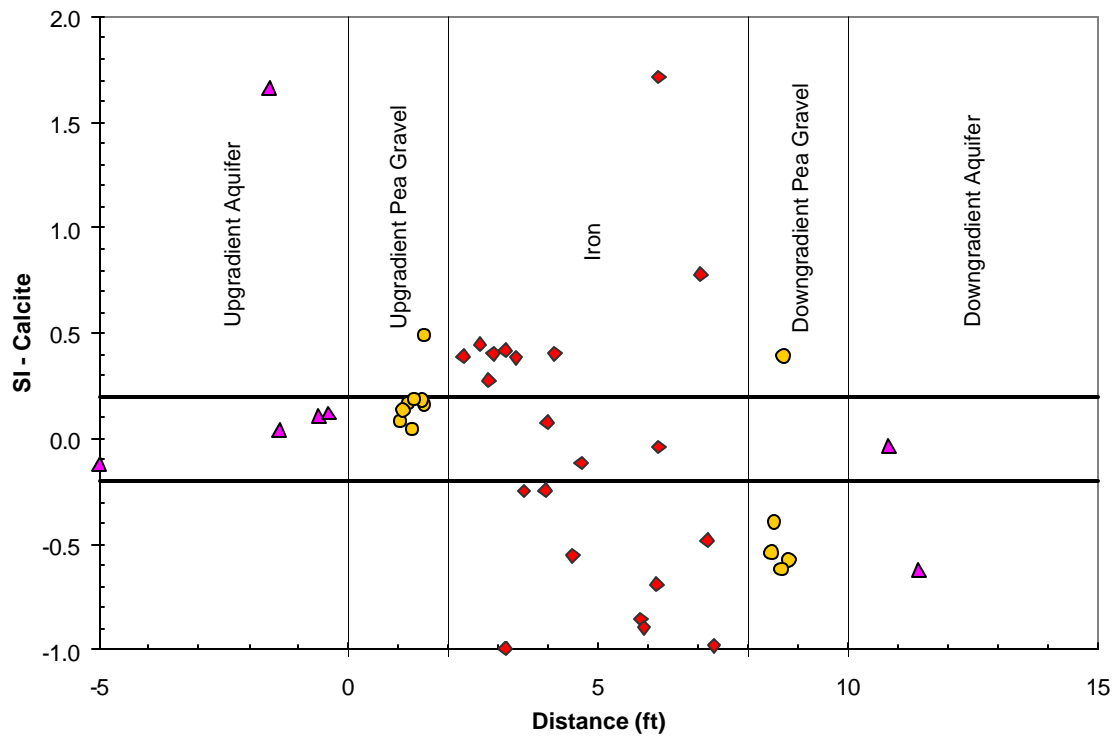

Figure D-5. Calcite Saturation Indices in Former NAS Moffett Field PRB

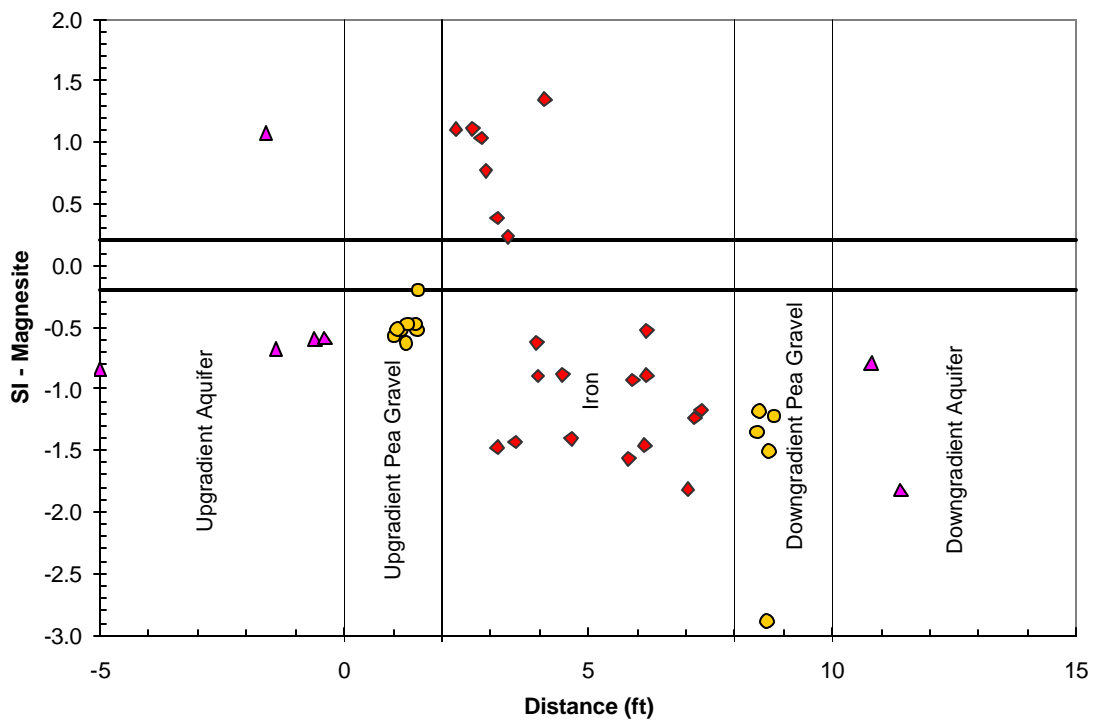

Figure D-6. Saturation Indices for Magnesite in Former NAS Moffett Field PRB

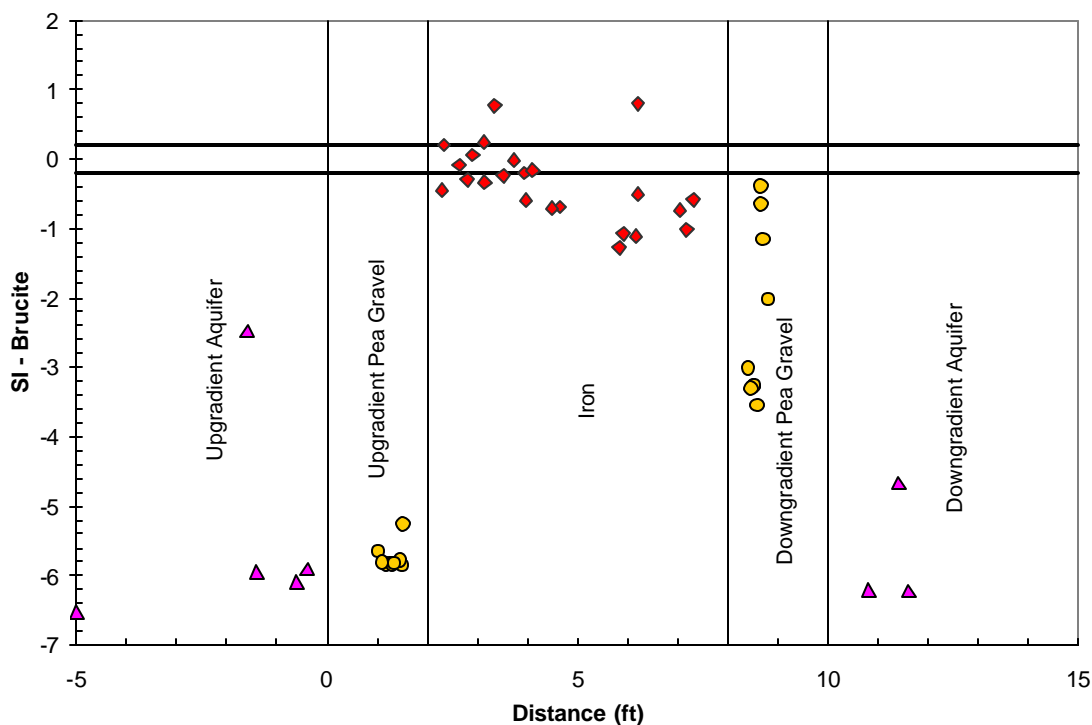

Figure D-7. Brucite Saturation Indices in Former NAS Moffett Field PRB

Siderite (FeCO_3), a ferrous carbonate mineral, is below saturation throughout most of the PRB (see Table D-3). However, data for iron are rather scant due to difficulty in detecting low concentrations (see Table D-2). Another ferrous mineral, melanterite ($\text{FeSO}_4 \cdot 7\text{H}_2\text{O}$), also was evaluated and determined to be undersaturated at all locations in the PRB. The stabilities of three ferric minerals were evaluated in a few cases where sufficient data for soluble iron are available. Goethite ($\alpha\text{-FeOOH}$) and “green rust” (not shown in Table D-3) tend to be oversaturated throughout the PRB, and amorphous ferric hydroxide [$\text{Fe}(\text{OH})_3$] tends to be undersaturated. Intermediate SI values between amorphous and crystalline phases may indicate that $\text{Fe}(\text{OH})_3$ is transforming to goethite over time.

Both gypsum ($\text{CaSO}_4 \cdot 2\text{H}_2\text{O}$) and melanterite are undersaturated at all locations, which suggests that the decline in sulfate levels in the reactive cell are not due to precipitation of sulfate minerals. A more likely explanation is that sulfate is reduced to sulfide due to low Eh. Additional calculations show that water in the reactive cell could be in equilibrium with marcasite (FeS_2) or mackinawite (FeS). SI calculations for sulfides could not be performed because sulfide was below detection in nearly all water samples.

D.3 Inverse Modeling

Equilibrium modeling indicates the type of precipitates that may form in the reactive medium. What is not known from field investigations is (1) how much of these precipitates are formed given the residence time (kinetics) of the groundwater in the reactive medium, and (2) how much of the precipitates formed stay in the reactive cell, as opposed to being transported away by the

flow. Inverse modeling attempts to answer the first question on how much of each type of precipitate is likely to be formed at the geochemical and flow (kinetic) conditions at a given PRB site. Inverse modeling conducted at the design stage requires both site characterization and column test data (i.e., inorganic parameter levels in column influent and effluent). Inverse modeling also may be conducted to interpret groundwater monitoring data for inorganic parameters (influent and effluent to the PRB) after the PRB is constructed.

PHREEQC (Parkhurst, 1995) was selected for inverse modeling because it contains a large set of mass-balance equations, allows redox processes to be modeled, and accounts for uncertainties in the analytical data. One mode of operation finds the minimum number of inverse models needed to satisfy all of the constraints. Another mode of operation finds all sets of minerals that can satisfy the constraints, even if they are not minimal. Optionally, for each inverse model, minimum and maximum mole transfers that are consistent with the uncertainties are computed individually for each mineral in the inverse model.

In general usage, a flowpath is assumed to exist between two wells where concentration measurements would be taken (Plummer and Back, 1980). The water at the upgradient end of the flowpath is assumed to react with minerals, or in this case metallic iron, to produce the observed composition in the downgradient water. Using the difference in elemental concentrations between the two aqueous solutions, the model calculates the amounts of minerals, and in some cases gases, that either dissolved or precipitated along the flowpath.

Based on results of water-level measurements, downhole groundwater velocity measurements, and tracer tests at former NAS Moffett Field, water flows continuously from south to north (see Figure D-8). Although there may be localized flow patterns in individual wells, which may vary over time, it is assumed that on a time average water flows through the reactive cell in a south to north direction. Therefore, inverse models were run for two wells that are aligned along the flow direction. The wells selected for inverse modeling were located along the center line of the PRB. The upgradient pea gravel was represented by WW-7C and the reactive cell was represented by WW-8C, which is located approximately 0.5 ft into the iron zone (see Figure D-8). The elevations of both wells were the same (3.5 ft above mean sea level) for consistency.

The input parameters for wells WW-7C and WW-8C are given in Table D-2. Allowed phase transfers are listed in Table D-4. Note that zero-valent iron is only allowed to dissolve while all other phases are only allowed to precipitate. Methane is included as a sink for reduced-carbonate carbon. Chemical reduction of carbonate species to methane may not occur to a significant extent under the conditions that exist inside a PRB (i.e., without methanogenic bacteria present) (Drever, 1997). However, methane was considered as a possible sink because it was detected in some of the groundwater samples. In addition, other phases could have been included in the model runs, but were excluded to simplify the output.

Modeling results presented in Table D-5 indicate that four independent scenarios (i.e., models) could explain the data equally well. All four models are minimum sets which contain the fewest number of compounds needed to perform the calculations. Model 1 calls for dissolving 368 mg Fe/L of groundwater (mean value; see Table D-5 for minimum and maximum calculations).

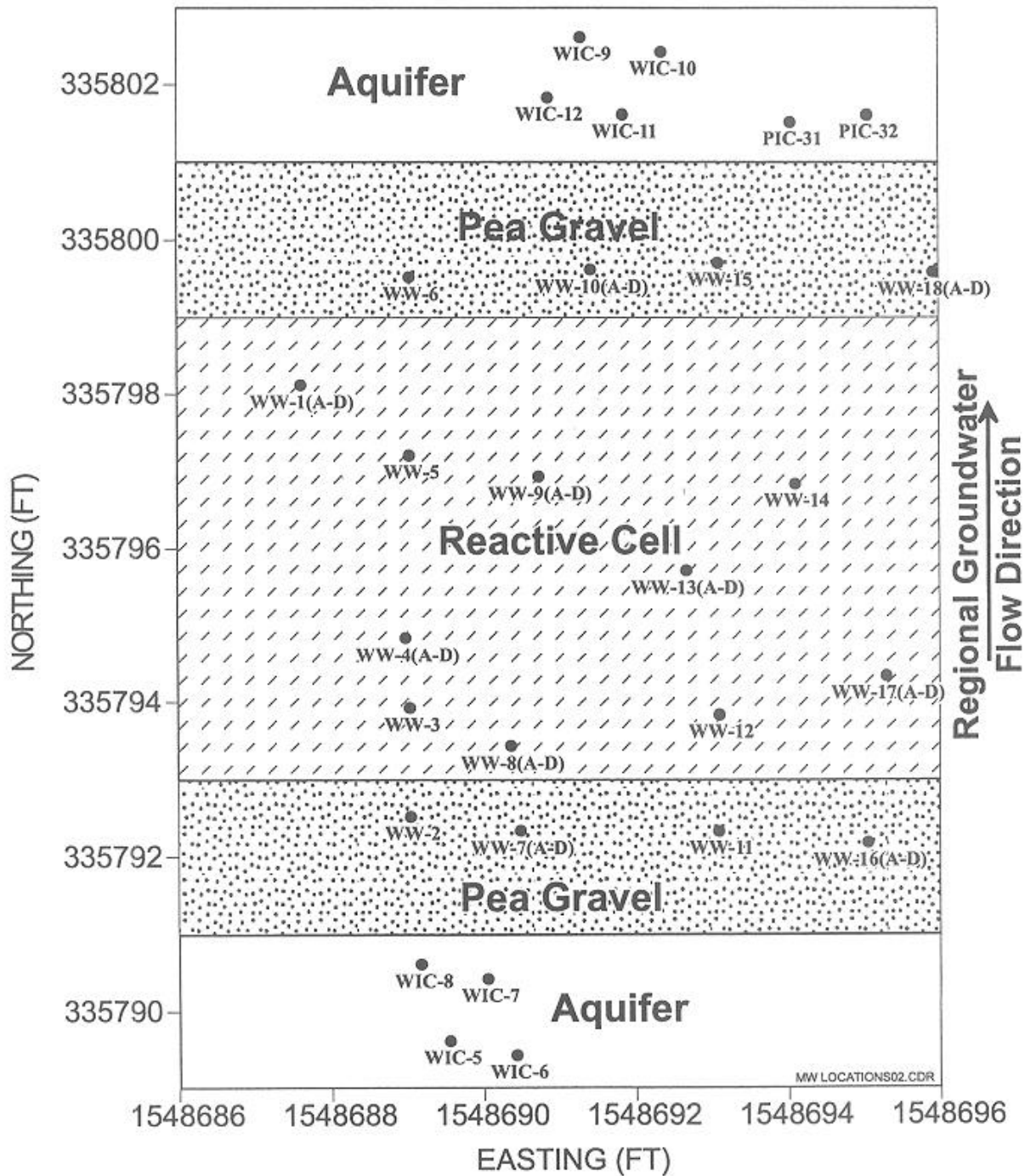

* Easting and Northing coordinates correspond to the California State Plane Coordinate System for zone 403.

Figure D-8. Locations of Monitoring Wells Within and Near the Former NAS Moffett Field PRB

Table D-4. Phase Transfers Allowed in Inverse Modeling Run

| Phase | Allowed Transfer |
|---------------------|------------------|
| Fe Metal | dissolve |
| Fe(OH) ₃ | precipitate |
| Siderite | precipitate |
| Marcasite | precipitate |
| Brucite | precipitate |
| Aragonite | precipitate |
| Magnesite | precipitate |
| CH ₄ | precipitate |

Table D-5. Results of Inverse Modeling Along a Flowpath Between the Pretreatment Zone and the Interface with the Reactive Cell at the Former NAS Moffett Field PRB

| Mineral | Fe Metal | Ferric Hydroxide | Siderite | Marcasite | Brucite | Aragonite | Magnesite | Methane |
|----------------|----------|---------------------|-------------------|------------------|---------------------|-------------------|-------------------|-----------------|
| Formula | Fe | Fe(OH) ₃ | FeCO ₃ | FeS ₂ | Mg(OH) ₂ | CaCO ₃ | MgCO ₃ | CH ₄ |
| <i>Model 1</i> | | | | | | | | |
| Mean | 368 | -299 | -306 | -137 | -62 | -367 | NA | NA |
| Minimum | 348 | -336 | -325 | -137 | -67 | -371 | NA | NA |
| Maximum | 371 | -267 | -247 | -131 | -62 | -366 | NA | NA |
| <i>Model 2</i> | | | | | | | | |
| Mean | 348 | -375 | -183 | -137 | NA | -367 | -89 | NA |
| Minimum | 328 | -412 | -202 | -137 | NA | -371 | -98 | NA |
| Maximum | 351 | -343 | -124 | -131 | NA | -366 | -89 | NA |
| <i>Model 3</i> | | | | | | | | |
| Mean | 554 | -939 | NA | -137 | NA | -367 | -90 | -25 |
| Minimum | 478 | -986 | NA | -137 | NA | -371 | -98 | -28 |
| Maximum | 579 | -793 | NA | -131 | NA | -367 | -89 | -17 |
| <i>Model 4</i> | | | | | | | | |
| Mean | 713 | -1,242 | NA | -137 | -62 | -367 | NA | -42 |
| Minimum | 636 | -1,289 | NA | -137 | -68 | -371 | NA | -45 |
| Maximum | 737 | -1,095 | NA | -131 | -62 | -367 | NA | -34 |

NA = not applicable, because the species was not considered in the model.

Concentrations are in mg/L.

Positive numbers imply dissolution; negative numbers imply precipitation.

Concomitant to dissolution and oxidation of the iron, different amounts of ferric hydroxide, siderite, marcasite, brucite, and aragonite precipitate. The relationship between the amount of iron dissolved and the total amount of iron present can be calculated if values for porosity and density of iron are known. Using an estimated porosity of 0.65 and density of 8 g/mL, the fraction of dissolved iron in Model 1 (368 mg Fe/L) is equivalent to 85 mg Fe dissolved per kilogram iron metal (i.e., 85 ppm).

The other three models differ by substitutions with one or two compounds. Model 2 requires magnesite to precipitate instead of brucite and consumes slightly less iron than Model 1. Model 3 does not require either siderite or brucite to precipitate, but calls for formation of methane. Similarly, Model 4 also forms methane, but differs from Model 3 by precipitating brucite instead of magnesite. Siderite is absent in both Model 3 and Model 4. Normally, the model chosen as the “most correct” would be based on actual observations of precipitates in core samples. In reducing environments, analysis of methane in water samples also would be an indicator. Due to the low abundance of precipitates in the core samples, the analyses do not definitively confirm or refute several predictions invoked by inverse modeling. First, corrosion of the iron is not obvious from microscopic inspection of the iron grains. Also, iron oxides (or oxyhydroxides) are ubiquitous in the core samples as well as in the virgin iron and therefore it is difficult to confirm whether precipitation of ferric hydroxide has occurred. In a few samples, $\text{Fe}(\text{OH})_3$ and FeOOH were suspected. Sulfur compounds thought to be present in reduced form such as FeS_2 were suspected in the upgradient iron. Aragonite was confirmed by x-ray diffraction. However, siderite, brucite, and magnesite were not confirmed by any analysis methods. Magnesium was believed to be associated with calcium, which could imply precipitation of high-Mg calcite along with pure calcium-aragonite. Methane was detected in the reactive cell, but concentrations did not tend to exceed 2 mg/L, which is substantially below the values predicted in Models 3 and 4 (25 mg/L and 42 mg/L, respectively; see Table D-5). It should be noted that the solubility limit of methane in water is 25 mg/L (at 1 atm partial pressure). Therefore, Model 4 can be rejected on the grounds that the methane generated would exceed saturation and such high levels are not borne out by field measurements. Results from the forward modeling (Section D.2) tend to support the possibility of aragonite (or calcite), brucite, magnesite, and methane. Due to the paucity of iron data, forward modeling was not able to calculate saturation indices for any of the iron compounds. Because none of the predicted species shown in Table D-5 can be ruled out, it must be assumed that Models 1, 2, and 3 provide plausible explanations for the evolution of groundwater inside the reactive cell.

In addition to the kinds of minerals that potentially precipitate within the reactive cell, it is useful to predict the impact that precipitation would have on the porosity of the granular iron. Table D-6 shows the results of volume calculations based on the mass balance calculations in Table D-5. The net porosity change is a loss of approximately 0.028% based on Models 1 and 2, and a porosity loss of approximately 0.035%, based on Model 3. These porosity changes are based on one pore volume of water. To estimate the total accumulation of particulate inside the PRB over time, the recharge rate within the precipitation zone must be calculated. (It is assumed that the precipitation takes place within the first 0.5 ft of the reactive cell.) Groundwater flow-rate in the PRB was estimated to be between 0.2 and 0.5 ft/d (Battelle, 1998). Therefore, this zone takes between 1 day and 2.5 days to recharge. If the precipitation rate is 0.030% of the initial pore volume per recharge period, then the loss of pore space is between 4 and 11% per year. In contrast, core sampling at former NAS Moffett Field after 16 months of operation did not reveal very significant levels of precipitation. The amount of aragonite precipitated was calculated to be 0.2% during the operational period (Battelle, 1998). Because mineral matter did not seem to be accumulating in the iron, it is possible that colloidal-size precipitates are either migrating downgradient with the flow, or gravity-settling within the PRB. If the level of precipitate accumulation were to be as high as predicted by inverse modeling, the effect on hydraulic

Table D-6. Results of Inverse Modeling Along a Flowpath Between the Pretreatment Zone and the Interface with the Reactive Cell at the Former NAS Moffett Field PRB

| Mineral | Fe Metal | Ferric Hydroxide | Siderite | Marcasite | Brucite | Aragonite | Magnesite | Net Change in Porosity |
|----------------|----------|------------------|----------|-----------|---------|-----------|-----------|------------------------|
| Density (g/mL) | 8 | ~4 | 3.96 | 4.89 | 2.39 | 2.95 | 3.0 | NA |
| <i>Model 1</i> | | | | | | | | |
| Mean | 46 | -75 | -77 | -28 | -26 | -125 | NA | -0.028% |
| Minimum | 43 | -84 | -82 | -28 | -28 | -126 | NA | -0.030% |
| Maximum | 46 | -67 | -62 | -27 | -26 | -124 | NA | -0.026% |
| <i>Model 2</i> | | | | | | | | |
| Mean | 44 | -94 | -46 | -28 | NA | -125 | -30 | -0.028% |
| Minimum | 41 | -103 | -51 | -28 | NA | -126 | -33 | -0.030% |
| Maximum | 44 | -86 | -31 | -27 | NA | -124 | -30 | -0.025% |
| <i>Model 3</i> | | | | | | | | |
| Mean | 69 | -235 | NA | -28 | NA | -125 | -30 | -0.035% |
| Minimum | 60 | -246 | NA | -28 | NA | -126 | -33 | -0.037% |
| Maximum | 72 | -198 | NA | -27 | NA | -124 | -30 | -0.031% |

NA = not applicable, because the species was not considered in the model.

Concentrations are in μL per liter of pore space, or parts per million by volume (ppmv).

Positive numbers imply dissolution (increased pore space); negative numbers imply precipitation (loss of pore space).

conductivity could be measurable. Hydrologic modeling has shown that hydraulic conductivity of the reactive cell has to reduce by more than half before any significant hydrologic change occurs (Battelle, 1998).

The rate of iron corrosion calculated by the inverse model also can be compared directly to experimental work by Reardon (1995). In Reardon's study, corrosion rates were measured by monitoring hydrogen pressure increases inside sealed vessels containing granular iron (Master Builders), water, and several salts. After an initial rise in hydrogen pressure, steady state rates began to develop, which were found to depend on the solution composition. Average long-term corrosion rates were close to 0.5 mmol/kg/d, or 30 mg/kg/d. For comparison, Model 1 in this study predicts that 85 mg/kg are corroded along a flowpath in the former NAS Moffett Field reactive cell. If it is again assumed that the groundwater flowrate is between 0.2 and 0.5 ft/d in the reactive cell, then the corrosion rate predicted by inverse modeling is between 34 and 85 mg/kg/d. Thus, the modeling results in this section and Reardon's experimental data agree at the lower flowrate estimate. However, there are a number of differences between the conditions in the former NAS Moffett Field PRB and the Reardon experiment that may make this agreement coincidental. Most notable is that the PRB at former NAS Moffett Field contains Peerless iron, whereas Master Builders iron was used in Reardon's (1995) study. In addition, particle sizes of the iron were somewhat different and solution temperature and composition were different. Nevertheless, the fact that corrosion rates determined by modeling field data and the experimental study are close could suggest that the fundamental corrosion processes affecting each study are related.

Inverse modeling thus is able to provide a method for quantification of how much precipitate is likely to be formed in the reactive medium over time. The question that still remains unanswered is how much of this precipitate stays in the reactive cell and how much is carried away with the groundwater flow. Additional research is required in this area to be able to make accurate longevity predictions for a PRB system.

D.4 References

Allison, J.D., D.S. Brown, and K.J. Novo-Gradac. 1991. *MINTEQA2/PRODEFA2, A Geochemical Assessment Model for Environmental Systems: Version 3.0 User's Manual*. EPA/600/3-91/021. U.S. Environmental Protection Agency, Office of Research and Development, Washington, DC. 106 pp.

Battelle. 1998. *Performance Evaluation of a Pilot-Scale Permeable Reactive Barrier at Former Naval Air Station Moffett Field, Mountain View, California*. Prepared for Naval Facilities Engineering Service Center, Port Hueneme, CA. November 20.

Battelle. 1999. *Draft Final Report: Design, Construction, and Monitoring of the Permeable Reactive Barrier in Area 5 at Dover Air Force Base*. Prepared for Tyndall Air Force Base, FL. November 8.

Drever, J.I. 1997. *The Geochemistry of Natural Waters: Surface and Groundwater Environments*, 3rd ed. Prentice-Hall, Inc., New York, NY.

Mackenzie, P.D., D.P. Horney, and T.M. Sivavec. 1999. "Mineral Precipitation and Porosity Losses in Granular Iron Columns." *Journal of Hazardous Materials*, 68: 1-17.

Odziemkowski, M.S., T.T. Schuhmacher, R.W. Gillham, and E.J. Reardon. 1998. "Mechanism of Oxide Film Formation on Iron in Simulating Groundwater Solutions: Raman Spectral Studies." *Corrosion Studies*, 40(2/3): 371-389.

Parkhurst, D.L. 1995. *User's Guide to PHREEQC - A Computer Program for Speciation, Reaction-Path, Advective-Transport, and Inverse Geochemical Calculations*. USGS 95-4227 Lakewood, CO.

Plummer, L.N., and W. Back. 1980. "The Mass Balance Approach: Applications to Interpreting the Chemical Evolution of Hydrologic Systems." *American Journal of Science*, 280: 130-142.

Reardon, E.J. 1995. "Anaerobic Corrosion of Granular Iron: Measurement and Interpretation of Hydrogen Evolution Rates." *Environ. Sci. Technol.*, 29(12): 2936-2945.

Sass, B., and A. Gavaskar. 1999. "Evaluation of Longevity Factors at Three Permeable Barrier Sites Based on Geochemical Characteristics." Abstract for the *Second International Conference on Remediation of Chlorinated and Recalcitrant Compounds*. Monterey, CA, May 22-25, 2000. Abstract submitted August 9.