

Temporal Variation of VOCs in Soils from Groundwater to the Surface/Subslab

APM 349

Temporal Variation of VOCs in Soils from Groundwater to the Surface/Subslab

APM 349

EPA Contract No. EP-C-05-061

Task Order No.85

Prepared by

Tetra Tech EM Inc.
1230 Columbia Street
Suite 1000
San Diego, CA 92101

Prepared for

Dr. Brian A. Schumacher, Task Order Project Officer
U.S. Environmental Protection Agency
Office of Research and Development
National Exposure Research Laboratory
Characterization and Monitoring Branch
Las Vegas, NV 89119

Although this work was reviewed by EPA and approved for publication, it may not necessarily reflect official Agency policy. Mention of trade names and commercial products does not constitute endorsement or recommendation for use.

FOREWORD

The U.S. Environmental Protection Agency (EPA) is charged by Congress with protecting the nation's natural resources. Under the mandate of national environmental laws, the EPA strives to formulate and implement actions leading to a compatible balance between human activities and the ability of natural systems to support and nurture life. To meet this mandate, the EPA's Office of Research and Development (ORD) provides data and scientific support that can be used to solve environmental problems, build the scientific knowledge base needed to manage ecological resources wisely, understand how pollutants affect public health, and prevent or reduce environmental risks.

The National Exposure Research Laboratory (NERL) is the Agency's center for investigation of technical and management approaches for identifying and quantifying exposures to human health and the environment. Goals of the laboratory's research program are to (1) develop and evaluate methods and technologies for characterizing and monitoring air, soil, and water; (2) support regulatory and policy decisions; and (3) provide the scientific support needed to ensure effective implementation of environmental regulations and strategies.

This report presents the activities, results, findings, and recommendations associated with monitoring the variations in active soil vapor sample results near and under a slab over a one-year period. The experimental program was conducted adjacent to Building 170 at Naval Air Station Lemoore (NAS) Installation Restoration Program (IRP) Site 14 from November 2008 through October 2009. The work described in this report is the follow up investigation to *Vertical Distribution of VOCs in Soils from Groundwater to the Surface/Subslab* (EPA 2009). This report was co-authored by Mr. James Elliot and Dr. Greg Swanson of Tetra Tech and Dr. Blayne Hartman of H&P Mobile Geochemistry. The authors acknowledge the tremendous support of Mr. Frank Nielson and Mr. Mike Quesada, the Navy personnel in charge of NAS Lemoore environmental operations, who facilitated access to IRP Site 14 to conduct the testing and provided logistical support and ongoing assistance with operations during the field sampling activities. The authors also acknowledge the effective field support and technical oversight provided by the EPA task order project officers, Dr. Brian Schumacher and Mr. John Zimmerman.

NOTICE

The information in this document has been funded wholly by the United States Environmental Protection Agency under contract #EP-C-05-061 to Tetra Tech EM, Inc. It has been subjected to the Agency's peer and administrative review and has been approved for publication as an EPA document. Mention of trade names or commercial products does not constitute endorsement or recommendation by EPA for use.

EXECUTIVE SUMMARY

Tetra Tech EM, Inc. (Tetra Tech EMI) was contracted by the U.S. Environmental Protection Agency (EPA) to assess the temporal variation of volatile organic compounds (VOCs) in soils from groundwater to the surface/subslab over a one-year period and to develop a database of paired macro-purge and micro-purge soil gas sample measurements. In addition, a study was conducted to assess the effect of purging parameters (purge rate, purge volume, sample volume) on measured VOC concentrations in soil vapor samples.

The field study was conducted at Installation Restoration Program (IRP) Site 14 on Naval Air Station (NAS) Lemoore, California. IRP Site 14 is located in the operations area of NAS Lemoore and consists of maintenance buildings, hangars, and aircraft parking areas. Chlorinated VOCs are the primary contaminants that have been found in soil, soil gas, and groundwater at IRP Site 14 near the Building 180 hangar, the adjacent aircraft parking area, and Building 170, where this investigation was conducted. The plume of chlorinated VOCs at IRP Site 14 is composed primarily of trichloroethene (TCE) and 1,1-dichloroethene (DCE), with minor amounts of 1,2-DCE, 1,1-dichloroethane (DCA), 1,2-DCA, and tetrachloroethene (PCE). Two discernable VOC plumes are present at IRP Site 14: one emanating from the Building 180 area, and one located south and east of Building 170. Two sets of six macro-purge (standard 1/8 inch tubing size) soil gas monitoring wells were installed along two lines (transects) during a previous EPA-sponsored investigation at the site. The transects were oriented approximately east-west, with a southern (primary) transect and a northern (secondary) transect. The southern transect was later augmented by the installation of three additional vapor sampling locations and the construction of groundwater monitoring wells at eight locations. Because the historical releases of chlorinated VOCs at IRP Site 14 were from known point sources, and the transects were not proximate to any of these sources, the measured soil vapor concentrations within these transects can be considered as deriving from a groundwater source.

For this study, only the southern transect was sampled. The eastern most soil gas monitoring well was excluded from the study due to consistent non-detect (ND) results. Thus, for this study, four soil gas monitoring wells were located on an approximately 6-inch thick concrete slab, and the remaining four wells were east of the slab, where the ground surface is not covered. At each soil gas monitoring well, soil vapor probes were installed at 2, 4, 7, and 10 feet below ground surface (bgs). At the four well locations on the concrete slab, a soil vapor probe was also located immediately beneath the concrete (a "sub-slab" probe). Collocated micro-purge (0.01-inch tubing size) sampling locations were also installed along the transect.

The macro-purge and micro-purge vapor probes and the groundwater monitoring wells were sampled on a monthly basis from November 2008 through October 2009. Soil vapor samples were analyzed on-site in a mobile laboratory using EPA SW-846 Method 8021. Groundwater samples were analyzed off-site at a fixed laboratory using EPA SW-846 Method 8260B.

The results of this study demonstrate that at this site, the near-slab environment is in a steady state, or dynamic equilibrium, governed by diffusive mass transfer. Beneath the slab, vapor- and aqueous-phase VOC concentrations were approximately in equilibrium and the rate-limiting step governing mass transfer was the movement of vapors laterally out from under the slab. In the uncovered area, the rate-limiting step was the transfer of VOCs from deep groundwater up and across the groundwater/soil gas interface; once in the vapor phase, the VOCs diffused relatively quickly upward and escaped through the uncovered ground surface. Because the rate of diffusive mass transfer is much slower in the aqueous phase than in the vapor phase, this process appears to have led to depletion of VOCs in the shallow groundwater beneath the uncovered area while groundwater concentrations beneath the slab remained quite elevated.

Monthly sampling indicated that groundwater concentrations were relatively stable over the course of the 12-month study period. Vapor concentrations under the slab generally varied by less than a factor of 4, while the variability in vapor concentrations in the uncovered area was much higher. The variability in vapor concentrations was not strongly linked to changes in groundwater concentrations, suggesting that other factors had a greater effect on vapor concentrations.

The paired micro-purge and macro-purge soil gas samples were not well correlated. Statistical analyses indicated an overall coefficient of determination (r^2) based on a linear regression of less than 0.5. Examination of the depth-specific subdivisions of the data indicated that the correlation between macro-purge and micro-purge vapor samples decreased with depth. It is suspected that the poor correlation was due in large part to challenges in collecting representative samples using the micro-purge technique; specifically, the resistance to gas flow through the 0.01-inch diameter micro-purge tubing results in a vacuum in the sampling train that may draw in ambient air.

The results of the sampling parameters study are presented in Appendix B of this report and indicate that purge rate, purge volume, and sample volume had no significant effect on measured VOC concentrations in soil vapor samples. Vadose zone soils at the NAS Lemoore study site comprise relatively low permeability silts and clays, and the results of the purging parameter study are consistent with the results of a similar study conducted at Vandenberg Air Force Base at a site underlain by homogenous, highly permeable dune sands.

CONTENTS

<u>Section</u>	<u>Page</u>
FOREWORD	i
EXECUTIVE SUMMARY	ii
LIST OF ACRONYMS AND ABBREVIATIONS.....	vi
1.0 INTRODUCTION	1-1
2.0 SITE BACKGROUND AND PROBE LAYOUT	2-1
2.1 IRP SITE 14 SETTING AND BACKGROUND	2-1
2.1.1 Geology and Hydrogeology.....	2-1
2.1.2 Chlorinated Solvent Plume Conditions.....	2-7
2.1.3 Selection of IRP Site 14.....	2-7
2.2 SOIL VAPOR PROBE TRANSECTS	2-7
2.2.1 Macro-Purge Vapor Probes	2-7
2.2.2 Micro-Purge Vapor Probes.....	2-9
2.2.3 Groundwater Monitoring Wells.....	2-9
2.3 EXPERIMENTAL DESIGN	2-10
3.0 EQUIPMENT AND METHODS	3-1
3.1 SAMPLE COLLECTION.....	3-1
3.1.1 Soil Samples	3-1
3.1.2 Soil Vapor Samples	3-1
3.1.3 Groundwater Samples.....	3-1
3.2 MOBILE LABORATORY.....	3-2
3.2.1 Analytical Method	3-2
3.2.2 Equipment.....	3-3
3.2.3 Detection Limits	3-3
3.3 QUALITY ASSURANCE/QUALITY CONTROL	3-3
3.3.1 Field Quality Control Protocols.....	3-3
3.3.2 Mobile Laboratory Quality Control Protocols.....	3-6
3.3.3 Project QAPP Deviations and Additions	3-7
4.0 RESULTS AND DISCUSSION	4-1
4.1 DATA SUMMARY.....	4-1
4.1.1 Soil Sample Results	4-1
4.1.2 Groundwater Sample Results.....	4-1
4.1.3 Soil Gas Samples	4-4
4.2 DISCUSSION.....	4-13
4.2.1 Distribution of VOCs in the Subsurface	4-13
4.2.2 Temporal Variability.....	4-15
4.2.3 Macro-Purge versus Micro-Purge Sampling	4-17
4.2.4 Sampling Parameters Study	4-22
5.0 CONCLUSIONS	5-1
6.0 RECOMMENDATIONS.....	6-1
7.0 REFERENCES	7-1

CONTENTS (Continued)

Page

APPENDICES

- A Sampling Trip Report
- B Purging Parameters Study
- C Example Chromatograms and Laboratory Data
- D Groundwater Sample Data
- E Soil Vapor Sample Data
- F Soil Vapor Profiles
- G Statistical Analyses

Figures

2-1	Detailed Site Map, IRP Site 14, NAS Lemoore, California.....	2-2
2-2	Groundwater Contours, A Zone, January 2007	2-4
2-3	Trichloroethene Plume in the A Zone, April 2009	2-6
2-4	Soil Vapor Probe Transects and April 2009 Groundwater TCE Concentrations.....	2-8
2-5	Soil vapor Probe Construction Schematic	2-11
4-1	South Transect Detail.....	4-3
4-2	Groundwater TCE Concentrations.....	4-5
4-3	Groundwater Levels.....	4-6
4-4	Macro-Purge Vapor Probe TCE Concentrations	4-12
4-5	Micro-Purge Vapor Probe TCE Concentrations	4-12
4-6	Schematic Isoconcentration Contours (January 2009 macro-purge data).....	4-14
4-7	Temporal Trends in Soil Vapor Concentrations Under the Slab	4-16
4-8	Temporal Trends in Soil Vapor Concentrations in Uncovered Locations	4-16
4-9	Schematic Isoconcentration Contours (June 2009 macro-purge data).....	4-18
4-10	Plot of Micro-Purge versus Macro-Purge TCE Concentrations	4-19
4-11	Plots of Micro-Purge versus Macro-Purge TCE Concentrations by Depth	4-20
4-12	Linear Plot of Purge Rate Experiment Data.....	4-23
4-13	Linear Plot of Purge Volume Experiment Data	4-24
4-14	Linear Plot of Sample Volume Experiment Data	4-24

Tables

2-1	Typical Physical Properties of the A Clay	2-3
2-2	Typical Physical Properties of the Vadose Zone and A-zone Aquifer	2-5
2-3	Macro-Purge Soil Gas Probe Installation Details	2-10
3-1	Summary of Monthly Sampling Rounds	3-2
3-2	Summary of Soil Gas and Groundwater TCE Duplicate Results	3-4
4-1	Summary of TCE Concentrations in Soil (µg/kg)	4-1
4-2	Summary of TCE Concentrations in Groundwater (µg/L)	4-2
4-3	Decrease in TCE Concentration per Foot (percent/distance).....	4-2
4-4	Summary of Groundwater Level Measurements (feet bTOC).....	4-5
4-5	Summary of TCE and PCE Concentrations in Macro-Purge Vapor Samples, January 2009.....	4-6
4-6	Summary of TCE and PCE Concentrations in Micro-Purge Vapor Samples January 2009.....	4-7
4-7	Comparison of TCE Concentrations in Macro-Purge and Micro-Purge Vapor Samples	4-8
4-8	Statistical Parameters for Regression Curve $Y = a + bX$	4-19
4-9	Statistical Parameters for Regression Curve $Y = bX$	4-21

LIST OF ACRONYMS AND ABBREVIATIONS

AETL	American Environmental Testing Laboratory
bgs	Below ground surface
Cal/EPA	California Environmental Protection Agency
° C	Degrees centigrade
DCA	Dichloroethane
DCE	Dichloroethene
DFA	1,1-difluoroethane
DTSC	Department of Toxic Substances Control
ECD	Electron capture detector
EPA	U.S. Environmental Protection Agency
GC/MS	Gas chromatograph/mass spectrometry
HPMG	H&P Mobile Geochemistry
ID	Internal diameter
IRP	Installation Restoration Program
LCS	Laboratory control sample
µg/m ³	Micrograms per cubic meter
µg/L	Micrograms per liter
mg/L	Milligrams per liter
mL	Milliliter
mL/min	Milliliters per minute
NAS	Naval Air Station
ND	Non-detect
NERL	National Exposure Research Laboratory
ORD	Office of Research and Development
PCE	Tetrachloroethene
PID	Photoionization detector
ppbV	Part per billion by volume
PVC	Polyvinyl chloride
QA	Quality Assurance
QAPP	Quality assurance project plan
RPD	Relative percent difference
Tetra Tech EMI	Tetra Tech, EM Incorporated
TCE	Trichloroethene
TO	Task Order
UST	Underground storage tank
VOC	Volatile organic compound

1.0 INTRODUCTION

Soil vapor data are widely used in site investigation and remediation projects to delineate volatile organic compound (VOC) vapor plumes, as a screening tool to refine soil and groundwater sampling efforts, to track the progress of soil remediation, and to assess the vapor intrusion pathway. Vapor intrusion is of particular concern, as it can be the primary grounds for remediation at VOC sites. A critical issue in assessing the vapor intrusion pathway is understanding the distribution and migration of VOCs from the subsurface source to the near surface environment.

It is commonly held that VOCs in a groundwater plume will migrate from groundwater through the vadose zone and either disperse to the atmosphere if the surface is uncovered, or potentially migrate into the indoor air of an overlying structure (i.e. vapor intrusion). Numerical models have been developed to describe the migration of VOCs in the subsurface environment and to assess the effects of a building foundation or slab (Abreu and Johnson 2005); however, these models incorporate a variety of simplifying assumptions. Overall, few data are available to document the behavior and distribution of VOC vapors through the soil column from groundwater to the surface/subslab environment and the variability in that distribution over time.

Variation in sampling methods, field conditions, and analytical methods may result in variability in soil vapor measurements. These sources of variation are essentially “noise” in the data, making it difficult to reach a clear understanding of the migration of VOCs in soils. A critical element in obtaining usable soil vapor data is the collection of representative samples. A variety of sample collection techniques are commonly used in the industry, but little data exist to evaluate the relative merits of the different methods.

The two primary objectives of this investigation were to: (1) measure the distribution of VOCs in the vadose zone and shallow groundwater in order to improve our understanding of the mechanisms of vapor migration and intrusion and (2) monitor the distribution of VOCs over the course of a year to assess the temporal variability. Secondary objectives included comparison of sampling results obtained from industry standard vapor probe implants (referred to here as “macro-purge” probes) and a new “micro-purge” methodology, and assessment of the effect of sampling parameters (i.e., purge rate, purge volume, and sample volume) on measured soil vapor concentrations.

2.0 SITE BACKGROUND AND PROBE LAYOUT

The field sampling and analysis portion of this project was conducted at Installation Restoration Program (IRP) Site 14, on Naval Air Station (NAS) Lemoore. NAS Lemoore is located in the California Central Valley, approximately 40 miles south of Fresno and 180 miles northwest of Los Angeles (Figure 2-1).

2.1 IRP SITE 14 SETTING AND BACKGROUND

Site 14 is located in the operations area of NAS Lemoore and consists of maintenance buildings, hangars, and aircraft parking areas (Figure 2-1). Chlorinated VOCs are the primary contaminants that have been found in soil, soil vapor, and groundwater at IRP Site 14 near the Building 180 hangar, the adjacent aircraft parking area, and near Buildings 188 and 170. The plume of chlorinated VOCs at IRP Site 14 is composed primarily of trichloroethene (TCE) and 1,1-dichloroethene (DCE), with minor amounts of 1,2-DCE, 1,1-dichloroethane (DCA), 1,2-DCA, and tetrachloroethene (PCE). Fuel residuals are also commingled with the chlorinated solvents; specific VOCs associated with the fuel residuals include trace amounts of benzene, toluene, ethylbenzene, and xylenes. Other VOCs detected at IRP Site 14 include chloroform and trichlorotrifluoroethane (Freon-113). Two coalesced VOC plumes are present at IRP Site 14: one emanating from the Building 180 area, and one located south of Building 170 (Figure 2-1).

There are several suspected source areas including industrial wastewater lines, storm drains, a manhole, a wash rack, and six former underground storage tanks (USTs). There are also possible spills or releases to uncovered areas or aircraft parking areas as a result of various practices associated with aircraft maintenance. All industrial waste water lines have been repaired or replaced, and all USTs at IRP Site 14 have been removed. Thus, soil gas VOC concentrations at the site are driven by groundwater concentrations in all locations except immediately adjacent to historical point release points.

2.1.1 Geology and Hydrogeology

2.1.1.1 Regional Geologic Setting

NAS Lemoore is located in the San Joaquin Valley, the southern half of California's Central Valley, a 400-mile-long structural basin that borders the Sierra Nevada Mountain Range. The Central Valley is underlain by a large fault block that tilted down toward the west as the basement rock rose to the east to form the Sierra Nevada.

The valley has continuously subsided throughout the Pleistocene and Holocene periods. Subsidence steepened the gradients of rivers that emerge from the Sierra Nevada, promoting the development of alluvial fan deposits and their subsequent preservation. The fans themselves consist largely of coarse-grained channel deposits, as finer-grained sediments are discharged by floodwaters that spill out onto the plain beyond the toe of the fan. A similar process was active on the slopes of the Coast Ranges that borders the valley to the west.

NAS Lemoore is located immediately west of the trough of the valley. The trough is the lowest and most level portion of the valley. The ground surface elevation at NAS Lemoore is approximately 230 feet above mean sea level. Lakes and playas have occupied the trough repeatedly throughout Quaternary time, leaving behind lacustrine deposits. Lacustrine deposits at NAS Lemoore primarily consist of clay. The three most extensive lacustrine clays have all been mapped beneath NAS Lemoore; they are referred to as A Clay, C Clay, and E Clay. The A Clay underlies NAS Lemoore at a depth of approximately 50 feet below ground surface (bgs).



R:\Navy\Lemoore\4306\301060303\Fig1_Detail_Site_Map.dwg 03/30/2007 deborah.ford DN

NAS Lemoore - Site14
 U.S. Navy, NAVFAC Southwest, San Diego, California

FIGURE 2-1
DETAILED SITE MAP
 STREAMSTO 85

Tetra Tech EM Inc.

NAS Lemoore is also located near the outer edge of the Kings River alluvial fan. As a result, alluvial deposits interfinger with lacustrine clays beneath NAS Lemoore. Alluvial deposits are typically olive brown to olive gray in color and contain sporadic cemented horizons. In contrast to lacustrine deposits, alluvium is heterogeneous and contains stringers and lens-shaped sand channel deposits that grade laterally to silty floodplain deposits.

Sediments at IRP Site 14 have the characteristics of both alluvial and lacustrine environments, indicating pulses of alluvial deposition into a closed, possibly ephemeral lacustrine environment. Lacustrine environments generally dominate in periods of cooler, wetter climates, such as during periods of glaciation, the last of which occurred about the time the A Clay was deposited.

2.1.1.2 IRP Site 14 Geology and Hydrogeology

Geologic deposits beneath IRP Site 14 consist of an alluvial aquifer composed of sand, silty sand, and sandy silt interfingered with less permeable deposits of clayey silt and silty clay. The alluvial assemblage is interrupted by clay interbeds of lacustrine origin at various intervals.

Several groundwater zones are identified beneath IRP Site 14. The uppermost (shallow) groundwater body is designated as the A aquifer zone. The A-Clay underlies the A-zone at a depth of approximately 45 to 50 feet, forming a semi-impermeable barrier that the A-zone groundwater is perched on. The depth to A-zone groundwater ranges from 10 to 14 feet bgs. The predominant site-wide groundwater flow in the A-zone is to the east/northeast, with a gradient on the order of 0.004 (Figure 2-2).

The A-Clay appears to be laterally continuous across the site between depths of 45 and 50 feet (~35 feet below the groundwater table). Several cores through the A-Clay have been obtained for the IRP investigation at Site 14 and it is typically logged as a stiff clay with low plasticity but does not appear reduced. Geotechnical samples collected in this interval exhibited a relatively high fraction of organic carbon (f_{oc}) of between 1 and 2 percent (Table 2-1).

**Table 2-1
Typical Physical Properties of the A Clay**

PARAMETER	RESULT
Clay (%)	21.72
Dry Bulk Density (lbs/ft ³)	96.77
Bulk Density (lbs/ft ³)	123.81
Moisture Content (%)	27.94
Fraction Organic Carbon (%)	1.40
Percent Gravel (%)	0.00
Percent Sand (%)	9.15
Percent Silt Or Percent Clay (%)	90.85
Porosity, Effective	0.03
Porosity, Total	0.40
USCS Classification (field)	clayey silt
Geotechnical Analysis Classification	lean clay

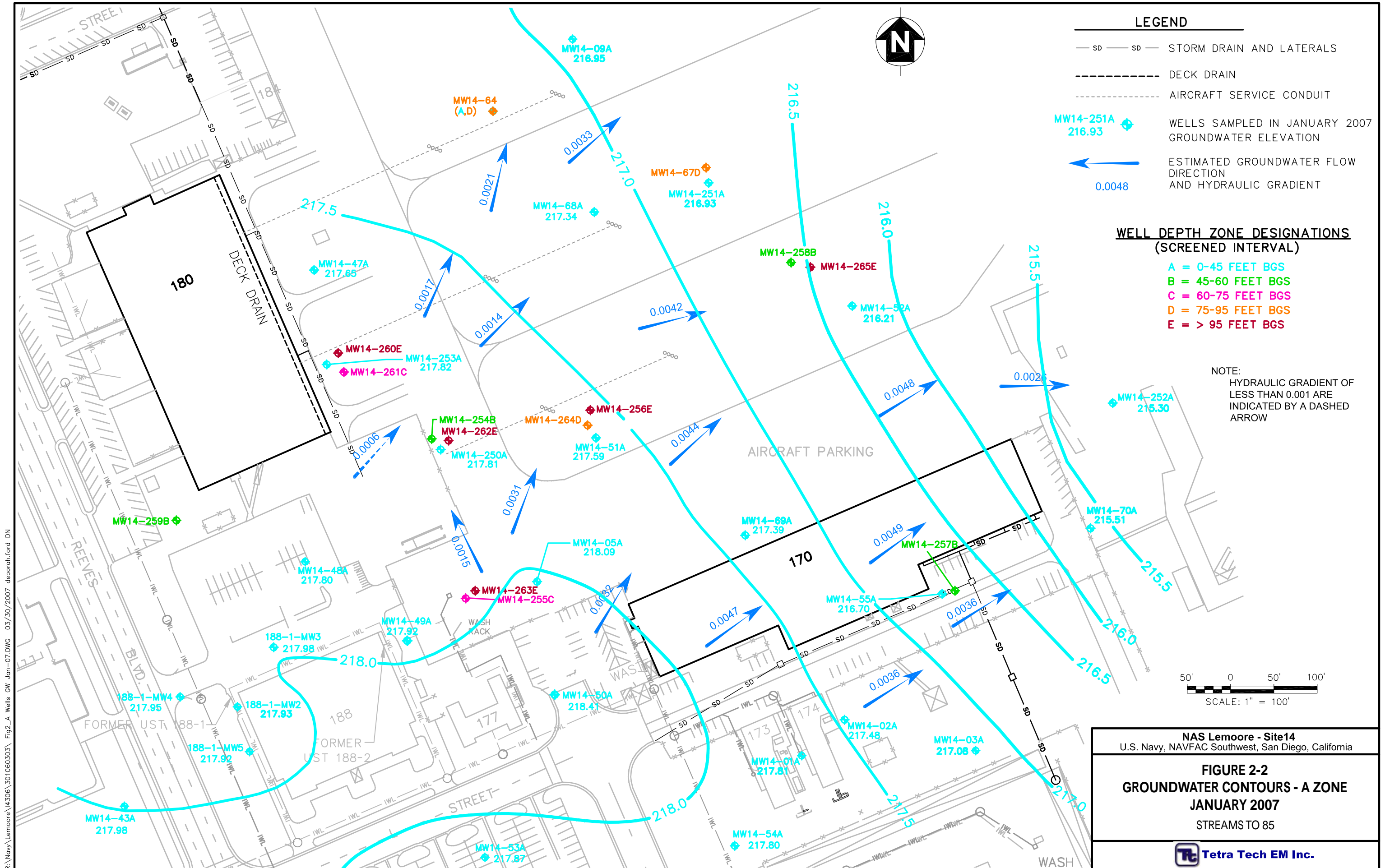

LEGEND

- SD — SD — STORM DRAIN AND LATERALS
- DECK DRAIN
- AIRCRAFT SERVICE CONDUIT

- MW14-251A 216.93 ◆ WELLS SAMPLED IN JANUARY 2007 GROUNDWATER ELEVATION
- ← 0.0048 ESTIMATED GROUNDWATER FLOW DIRECTION AND HYDRAULIC GRADIENT

WELL DEPTH ZONE DESIGNATIONS (SCREENED INTERVAL)

- A = 0-45 FEET BGS
- B = 45-60 FEET BGS
- C = 60-75 FEET BGS
- D = 75-95 FEET BGS
- E = > 95 FEET BGS

NOTE:
HYDRAULIC GRADIENT OF LESS THAN 0.001 ARE INDICATED BY A DASHED ARROW

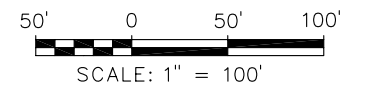

NAS Lemoore - Site14
U.S. Navy, NAVFAC Southwest, San Diego, California

FIGURE 2-2
GROUNDWATER CONTOURS - A ZONE
JANUARY 2007
STREAMS TO 85



R:\Navy\Lemoore\4306\301060303\Fig2_A_Wells_GW_Jan-07.DWG 03/30/2007 deborah.ford DN

Alluvium in the A-zone (~12 to 45 feet bgs) consists largely of granular alluvium (predominantly sands), especially in the vicinity of the apparent TCE source locations. This granular alluvium appears to pinch out to the northeast of Site 14. Geotechnical samples collected below the water table in the 20- to 24-foot bgs range consisted of 70 to 80 percent sand with relatively high effective porosities (15 to 18 percent); however, these sandy soils are not representative of soils in the Site 14 vadose zone, where the vapor probes for this investigation were installed. Rather, the vadose zone predominantly consists of silts and clays. Limited soil physical property data for the vadose zone and A-zone (aquifer) soils at Site 14 are presented in Table 2-2.

**Table 2-2
Typical Physical Properties of the Vadose Zone and A-zone Aquifer**

PARAMETER	RESULT	
	Vadose zone	A-zone
Clay (%)		4.2 – 6.1
Dry Bulk Density (lbs/ft ³)		95.5 – 95.9
Bulk Density (lbs/ft ³)		113.4 – 113.5
Moisture Content (%)	12 – 37	18.3 – 18.8
Fraction Organic Carbon (%)	0.28 – 0.48	0.80 – 0.90
Percent Gravel (%)		0.0 – 0.6
Percent Sand (%)		73 – 80
Percent Silt Or Percent Clay (%)		19.7 – 27.1
Porosity, Effective		0.15 – 0.18
Porosity, Total	0.45 – 0.60	0.40 – 0.41
Permeability, Effective (millidarcy)	4.3 – 3.7	
USCS Classification (field)	Clay and silt	medium sand
Geotechnical Analysis Classification		silty sand

Note:

lbs/ft³ – pounds per cubic foot

Beneath the A-zone are the B-, C-, D- and E-zones. Thick sand deposits are found in the B-, C-, and D-zones, particularly in the center of Site 14. The other two extensive clay layers beneath the site are the C- and E-Clays. The C-Clay is about 250 feet bgs and the E-Clay about 680–720 feet bgs. The E-Clay extends throughout the central valley and is also called the Corcoran Clay. The E-Clay is the major confining unit in the valley and separates the two regionally defined aquifers: the Lower Confined aquifer and the Upper Unconfined to Semi-confined aquifer. The C- and E-Clay are not discussed further as they lie well below the depth of interest to this study. The A-zone groundwater is the uppermost groundwater in the Upper Unconfined to Semi-confined aquifer. All three of the clay layers are lacustrine.

In general, the hydrogeology of the shallow-upper aquifer beneath IRP Site 14 (the A-zone) can be characterized as a heterogeneous alluvial aquifer with a relatively flat water table and limited vertical connection to underlying aquifer zones.

The quality of the shallow groundwater is generally poor because of elevated salinity that is likely a result of irrigation practices in an arid environment. For example, sulfate concentrations above 10,000 milligrams per liter (mg/L) are not uncommon at NAS Lemoore.

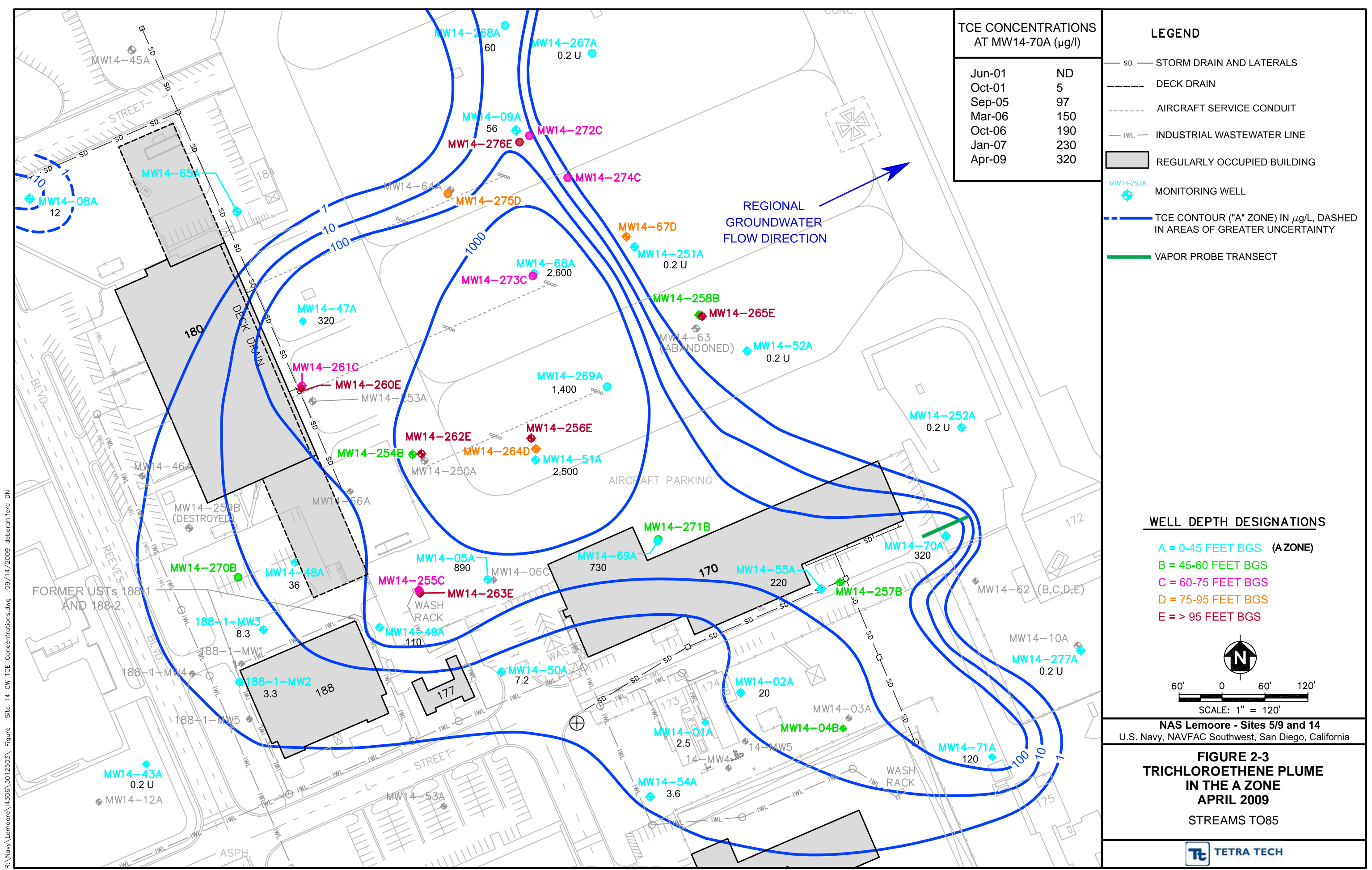

TCE CONCENTRATIONS AT MW14-70A (µg/l)

Jun-01	ND
Oct-01	5
Sep-05	97
Mar-06	150
Oct-06	190
Jan-07	230
Apr-09	320

LEGEND

- SD — STORM DRAIN AND LATERALS
- DECK DRAIN
- AIRCRAFT SERVICE CONDUIT
- IWL — INDUSTRIAL WASTEWATER LINE
- █ REGULARLY OCCUPIED BUILDING
- MW14-252A MONITORING WELL
- TCE CONTOUR ("A" ZONE) IN µg/L, DASHED IN AREAS OF GREATER UNCERTAINTY
- VAPOR PROBE TRANSECT

WELL DEPTH DESIGNATIONS

- A = 0-45 FEET BGS (A ZONE)
- B = 45-60 FEET BGS
- C = 60-75 FEET BGS
- D = 75-95 FEET BGS
- E = > 95 FEET BGS

North arrow and scale bar.

SCALE: 1" = 120'

NAS Lemoore - Sites 5/9 and 14
U.S. Navy, NAVFAC Southwest, San Diego, California

FIGURE 2-3
TRICHLOROETHENE PLUME
IN THE A ZONE
APRIL 2009
STREAMS TO85



R:\Navy\Lemoore\4306\3012503\Figure_14_GW_TCE_Concentrations.dwg 09/14/2009 deborah.ford DN

2.1.2 Chlorinated Solvent Plume Conditions

Groundwater monitoring results for TCE obtained in April 2009 are presented on Figure 2-3. TCE is the primary chemical of concern in groundwater. The most significant concentrations (above 1,000 micrograms per liter [$\mu\text{g/L}$]) are found adjacent to and east of Building 180; however, this is a high-traffic area used for aircraft parking and consists of an excessively thick (18 to 24 inches) concrete slab; both of these factors rendered the area unsuitable for this study. The area used for this investigation was adjacent to and southeast of Building 170. TCE was measured in groundwater from monitoring well MW14-70A, located in the study area, at a concentration of 320 $\mu\text{g/L}$ in April 2009, continuing a trend of increasing concentrations observed since June 2001 (Figure 2-3). TCE concentrations in samples from groundwater wells installed along the sampling transect used for this investigation ranged from non-detect to 830 $\mu\text{g/L}$ from November 2008 to October 2009. The locations of well MW14-70A and the sampling locations for this study (designated ST-1 through ST-9) are shown on Figure 2-4.

2.1.3 Selection of IRP Site 14

Site 14 was previously selected as a suitable location to conduct an investigation of soil vapor profiles under Task Order (TO) 65 for the following reasons: (1) it provides a study area over a well-defined, shallow, chlorinated-solvent plume in groundwater, (2) a variety of buildings with slab-on-grade foundations are present at the site, and (3) Tetra Tech has an established working relationship with the environmental program staff at NAS Lemoore. This investigation was an extension of the work conducted under TO 65.

2.2 SOIL VAPOR PROBE TRANSECTS

The following paragraphs summarize the installation of the soil gas probe array at IRP Site 14. Details of the drilling and probe installation activities are presented in the TO 65 project report (EPA 2009) and the *Sampling Trip Report* (Appendix A).





Two transects of six soil vapor sampling probes were installed for TO 65 in January and February 2008. The transects were designated as the south (primary) transect and north (secondary) transect, with the sampling locations designated ST-1 through ST-6 and NT-1 through NT-6, respectively (Figure 2-4). The transects were placed such that locations ST-1, ST-2, NT-1, and NT-2 were on the concrete slab adjacent to Building 170, and the remaining locations were in the uncovered area to the east. In October 2008, three additional sampling locations (ST-7 through ST-9) were established to provide additional data at key locations (Figure 2-4). For this investigation, only south transect locations ST-1 through ST-5 and ST-7 through ST-9 were used. VOCs were not detected at location ST-6 during the TO 65 investigation; therefore, it was excluded from this study. At each of the sampling locations, soil vapor probes were installed at 2, 4, 7, and 10 feet bgs. At locations ST-1, ST-2, ST-7, and ST-8, subslab soil vapor probes were installed immediately below the concrete pad.

Two types of vapor probes were installed and utilized for this investigation. These are referred to here as “macro-purge” vapor probes and “micro-purge” vapor probes as discussed below.

2.2.1 Macro-Purge Vapor Probes

The macro-purge probes were installed in pilot holes advanced to 10 feet bgs, or to groundwater at depths between 10.7 and 11.5 feet bgs, using a direct push rig. Soils encountered in the pilot holes consisted primarily of silty sands, clayey sands, and clays. Soil samples were collected at the vapor probe depths of 2, 4, 7, and 10 feet bgs in each of the three pilot holes drilled in October 2008 (ST-7 through ST-9).

LEGEND

- NT-5  SOIL VAPOR PROBE LOCATION (NOT USED FOR THIS STUDY)
- ST-4  SOIL VAPOR PROBE WITH COLLOCATED GROUNDWATER WELL (GROUNDWATER TCE CONCENTRATION IN PARENTHESES)
-  IRP GROUNDWATER WELL (GROUNDWATER TCE CONCENTRATION IN PARENTHESES)
- X— FENCE LINE
-  UNPAVED AREA

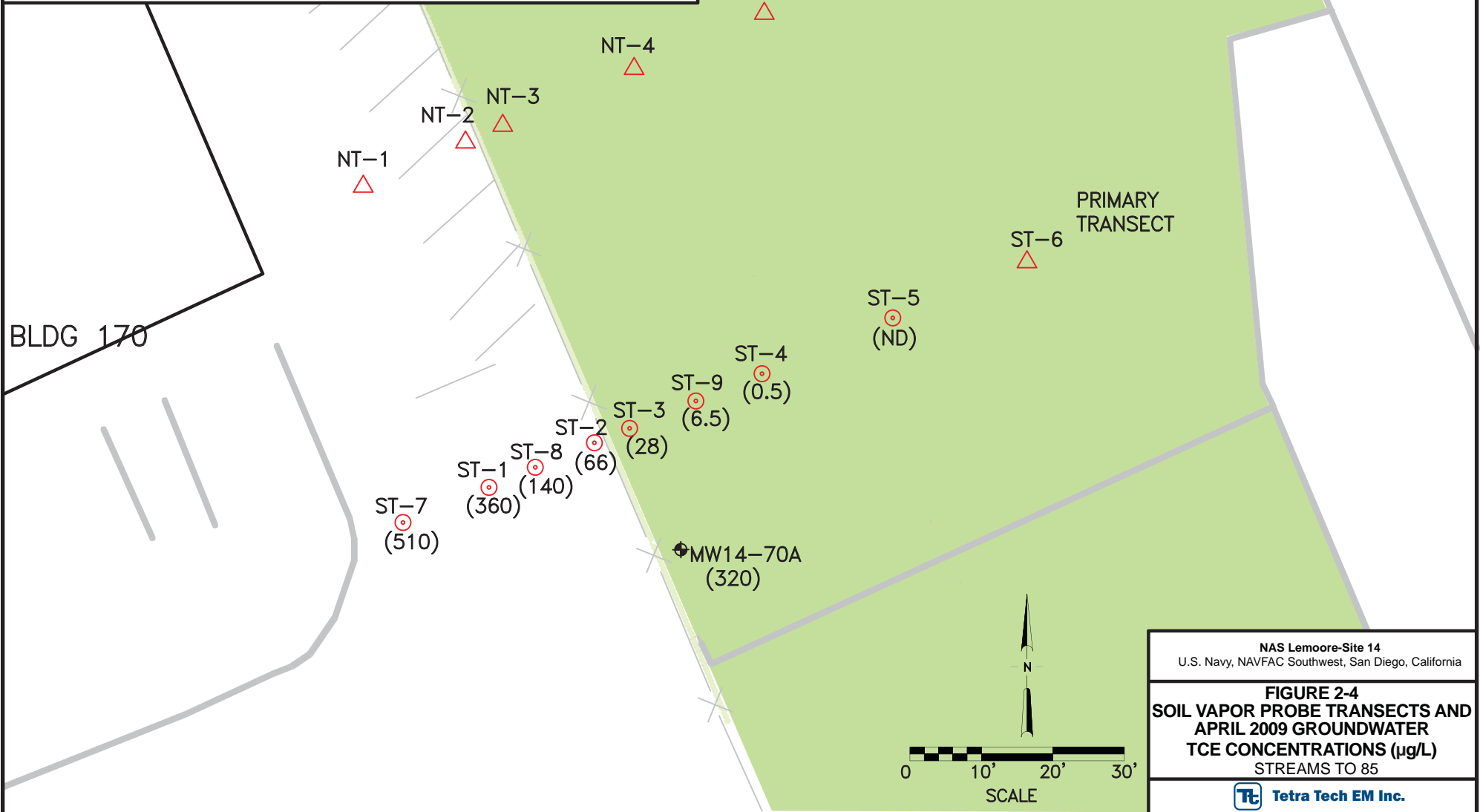

NAS Lemoore-Site 14
U.S. Navy, NAVFAC Southwest, San Diego, California

FIGURE 2-4
SOIL VAPOR PROBE TRANSECTS AND
APRIL 2009 GROUNDWATER
TCE CONCENTRATIONS (µg/L)
STREAMS TO 85

 Tetra Tech EM Inc.

Macro-purge soil vapor probes were constructed as follows. Approximately 3 inches of #2/12 sand was poured into the bottom of the pilot holes. A 1-inch long gas-permeable membrane sampling probe, attached to 1/8-inch diameter Nylaflow tubing, was then lowered through the drill rod to the top of the sand. Additional sand was then poured around the sampling probe until it extended approximately 2 inches above the membrane to form an approximately 6-inch long sand pack around the sampling probe. Approximately 12 inches of dry bentonite was then placed on top of the sand pack, followed by hydrated bentonite to approximately 3 inches below the next sampling depth (i.e. 7 feet bgs). This process was repeated to install four nested soil vapor probes, at depths of 2, 4, 7, and 10 feet bgs, in each pilot hole. At locations on the concrete pad, the subslab vapor probes were installed in the same way, but in a separate, 1-inch diameter hole that was drilled through the concrete with an electric hammer drill. A total of 36 vapor probes were used for this investigation (four subslab probes and 32 deep probes). The sampling probes were completed at the surface with approximately 18 inches of Nylaflow tubing extending out of the ground and a luer valve fitted to the end of the tubing. A schematic diagram of the probe installations is provided in Figure 2-5.

The individual probes were identified by the location ID and the depth separated by a dash (e.g., the probe installed at 4 feet bgs at location ST-1 is designated ST1-4). The subslab probes were identified with the location ID and "SS" (e.g. ST1-SS). Table 2-3 provides a summary of the probe installation details.

2.2.2 Micro-Purge Vapor Probes

Concurrently with the installation of the macro-purge vapor probes, EPA installed micro-purge vapor probes. Micro-purge vapor probes were collocated with the macro-purge vapor wells at locations ST-1 through ST-4, and ST-7 through ST-9 at depths of 2, 4, 7, and 10 feet bgs (total of 28 probes). The lateral distance between micro-purge probes and the corresponding nested macro-purge probes varied between approximately 6 inches and 2 feet. Subslab micro-purge vapor wells were not installed. The micro-purge vapor probes consisted of 0.01-inch inner diameter (ID) stainless steel tubing epoxied into steel point holders. The stainless steel tubing was threaded through the drill-rods, which were driven to the target sampling depth using the EPA-operated direct-push rig. Upon reaching the target depth, the drill rod was pulled up approximately 1 inch to expose the drop-off point to the vadose zone. The drill rods were left in place during sampling in order to seal out ambient air; thus micro-purge probes at multiple depths were installed in separate boreholes, rather than being nested in a single boring, and the probe rods were left in place for the duration of the project.

2.2.3 Groundwater Monitoring Wells

For this investigation, groundwater monitoring wells were installed immediately adjacent to vapor probe locations ST-1 through ST-5 and ST-7 through ST-9. The wells were installed in boreholes drilled approximately 2 feet below the water table using a direct-push drill rig. The wells were constructed using 0.75-inch diameter polyvinylchloride (PVC) well casing and screen. The screen and casing was placed in the open borehole so that approximately 1 foot of well screen was above the water table and 2 feet were below. Clean #2/12 sand was then poured down the annular space to form a filter pack to approximately 1 foot above the well screen. The wells were sealed to the surface with hydrated bentonite and completed at the surface in flush-mount, traffic rated well boxes. The relatively short (i.e., 3 feet long) well screens were used in order to obtain groundwater samples that are representative of the conditions near the top of the water column.

**Table 2-3
Macro-Purge Soil Gas Probe Installation Details**

Location ID	Probe ID	Installation Date	Easting	Northing	Probe Depth (feet bgs)	Length of Sand pack (inches)	System Volume (mL)
ST-1	ST1-SS	February 11, 2008	6283734.19	2002852.99	Subslab	2	2
	ST1-2				2	6	3
	ST1-4				4	6	5
	ST1-7				7	6	8
	ST1-10				10	6	11
ST-2	ST2-SS	February 11, 2008	6283748.25	2002859.41	Subslab	2	2
	ST2-2				2	6	3
	ST2-4				4	6	5
	ST2-7				7	6	8
	ST2-10				10	6	11
ST-3	ST3-2	January 18, 2008	6283753.98	2002860.26	2	6	3
	ST3-4				4	6	5
	ST3-7				7	6	8
	ST3-10				10	6	11
ST-4	ST4-2	January 22, 2008	6283771.04	2002870.24	2	6	3
	ST4-4				4	6	5
	ST4-7				7	6	8
	ST4-10				10	6	11
ST-5	ST5-2	January 22, 2008	6283789.04	2002878.29	2	6	3
	ST5-4				4	6	5
	ST5-7				7	6	8
	ST5-10				10	6	11
ST-7	ST7-SS	October 22, 2008	6283723.72	2002848.69	Subslab	2	2
	ST7-2				2	6	3
	ST7-4				4	6	5
	ST7-7				7	6	8
	ST7-10				10	6	11
ST-8	ST8-SS	October 22, 2008	6283739.86	2002857.26	Subslab	2	2
	ST8-2				2	6	3
	ST8-4				4	6	5
	ST8-7				7	6	8
	ST8-10				10	6	11
ST-9	ST9-2	October 22, 2008	6283761.65	2002866.30	2	6	3
	ST9-4				4	6	5
	ST9-7				7	6	8
	ST9-10				10	6	11

Definitions:

bgs - below ground surface
mL - milliliters

2.3 EXPERIMENTAL DESIGN

The primary objectives of this investigation were to: (1) assess the vertical distribution of VOCs in soils from groundwater to the subslab/near-surface environment, and (2) assess the long-term variability in the distribution of VOCs. Secondary objectives were to compare data obtained from the macro-purge probes to data obtained from the micro-purge probes and to evaluate the effect of sampling parameters (e.g. purge rate, purge volume, and sample volume) on measured VOC concentrations.

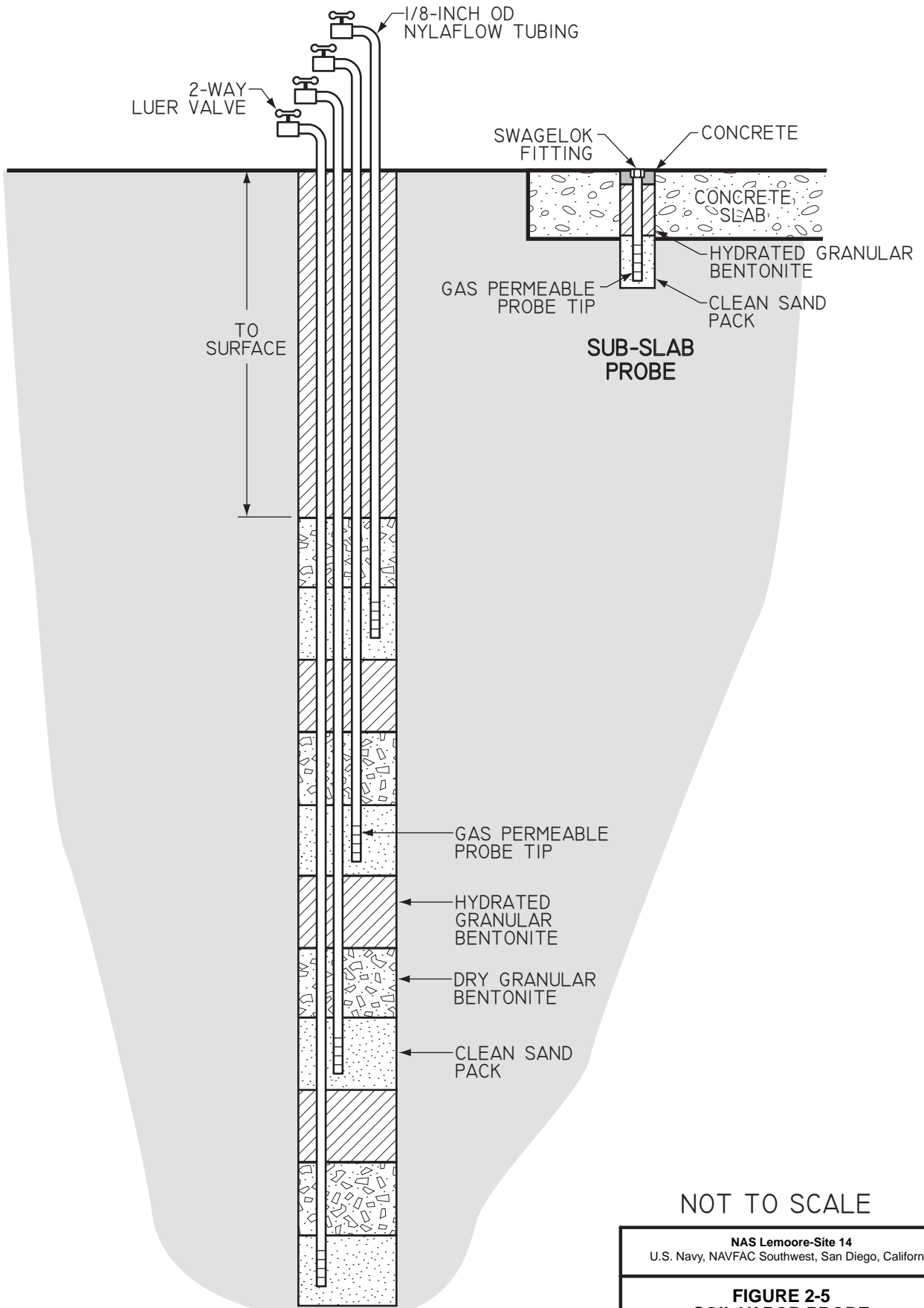

NESTED SOIL-GAS PROBES

NOT TO SCALE

NAS Lemoore-Site 14
U.S. Navy, NAVFAC Southwest, San Diego, California

FIGURE 2-5
SOIL VAPOR PROBE
CONSTRUCTION SCHEMATIC

STREAMS TO 85

To achieve the project objectives, the macro- and micro-purge soil gas probes and the groundwater monitoring wells described in Section 2.2 were sampled on a monthly basis from November 2008 through October 2009. Thus, approximately 36 macro-purge vapor samples, 28 micro-purge vapor samples, and eight groundwater samples were collected each month for 12 months. This provided a large database of measured VOC concentrations in groundwater and soil vapor to assess the distribution of VOCs, examine the variability of VOC concentrations over the course of a year, and compare measurements from collocated macro-purge and micro-purge vapor probes.

In addition, during the May 2009 sampling round, a subset of the macro-purge probes were used to evaluate the effect of sampling parameters on measured VOC concentrations. For this study, multiple samples were collected from a single probe while varying the purge rate, purge volume, or sample volume. Details of the methodology and the results of the sampling parameters evaluation are presented in Appendix B.

3.0 EQUIPMENT AND METHODS

The following sections describe the sampling and analysis procedures used during the investigation.

3.1 SAMPLE COLLECTION

3.1.1 Soil Samples

Intact soil cores were retrieved from the ST-7 through ST-9 pilot boreholes in clear, acetate sleeves used as liners in the drill rod. Soil sample aliquots for VOC analyses were collected from the acetate sleeves and transferred directly to VOA vials containing methanol and sodium bisulfate preservatives in accordance with EPA SW-846 Method 5035 (EPA 1996). Soil samples were submitted to American Environmental Testing Laboratory, Inc. (AETL), located in Burbank, California for VOC analysis via EPA SW-846 Method 8260B (EPA 1997).

3.1.2 Soil Vapor Samples

Active soil gas sample collection consists of two primary components. The first is purging the probe to remove ambient air and any other gases not representative of subsurface conditions at the target sampling depth. The second is collection of the soil gas sample into an appropriate container for transfer to the analytical instrument. Based on the results of purge tests conducted at the probes during the TO 65 investigation (EPA 2009) and the results of the TO 05 investigation (EPA 2007), the volume of gas removed from each probe prior to sampling (the purge volume) was set at three system volumes. A system volume is the volume of the gas permeable tip plus the tubing but not the sand pack. The sand pack was excluded from the system volume calculation because the probes had ample time (minimum of 3 weeks) to equilibrate, and so it was assumed the sand pack pore space was in equilibrium with the surrounding native soils. The system volumes for the macro-purge probes are provided in Table 2-3. Probes were purged at a rate of approximately 200 milliliters per minute (mL/min). The sample volume from macro-purge probes was set at 20 mL, and the samples were collected in 60-mL glass syringes.

Samples from micro-purge soil gas probes were collected in 10-mL glass syringes. System volumes of the micro-purge probes were 2.025 mL for the 2-foot probes, 2.075 mL for the 4-foot probes, 2.125 mL for the 7-foot probes, and 2.150 mL for the 10-foot probes. Three system volumes were purged from each micro-purge soil gas probe prior to collecting a 2.5-mL sample. Soil gas samples were analyzed on-site in a mobile laboratory operated by H&P Mobile Geochemistry (HPMG).

Samples were collected on a monthly basis from the probes as outlined in Table 3-1. During each monthly sampling round, an attempt was made to collect a vapor sample from each of the probes (36 macro-purge probes and 28 micro-purge probes); however, during the course of the investigation, some of the micro-purge probes became clogged and could no longer be sampled (Table 3-1).

Following the monthly sampling round in May 2009, the sampling parameters study was conducted. For this study, a subset of the probes was sampled using varying purge rate, purge volume, and sample volume to assess whether these parameters affect the measured VOC concentrations. Details of the sampling approach are provided in Appendix B.

3.1.3 Groundwater Samples

Groundwater samples were collected during each monthly sampling round from each of the eight monitoring wells installed along the transect, with the exception of the August 2009 sampling round, when wells ST-4 and ST-5 were dry (Table 3-1). The wells were purged using a peristaltic pump at a rate

of approximately 100 mL/min until either three well volumes were removed or the well went dry. The samples were then collected using 0.5-inch diameter disposable bailers and transferred to hydrochloric acid preserved volatile organic analysis vials and sent to the HPMG fixed laboratory in Carlsbad, California for VOC analysis using EPA SW-846 Method 8260B.

**Table 3-1
Summary of Monthly Sampling Rounds**

Round	Dates	Number of Macro-Purge Samples	Number of Micro-Purge Samples	Number of Groundwater Samples
November 2008	11/12 – 11/14	33	28	8
December 2008	12/15 – 12/17	36	26	8
January 2009	1/19 – 1/20	36	28	8
February 2009	2/17 – 2/18	36	28	8
March 2009	3/16 – 3/18	36	28	8
April 2009	4/22 – 4/23	35	27	8
May 2009	5/18	34	26	8
June 2009	6/15 – 6/16	33	25	8
July 2009	7/14 – 7/15	29	22	8
August 2009	8/11 – 8/12	25	22	6
September 2009	9/15	23	22	8
October 2009	10/13 – 10/14	19	21	8

Notes:

Numbers of samples do not include quality control duplicates

3.2 MOBILE LABORATORY

Soil gas samples collected for this investigation were analyzed on-site using a mobile laboratory operated by HPMG. Details of the analytical method, equipment, and detection limit (DL) are provided below.

3.2.1 Analytical Method

Soil gas samples were analyzed by direct injection using a modified version of EPA SW-846 Method 8021 (EPA 1996). Method 8021 is a gas chromatography method using a photoionization detector (PID) and a Hall Detector (electrolytic conductivity detector). The modification for this program was replacement of the Hall Detector with an electron capture detector (ECD). This method is faster, more sensitive, and has a larger linear dynamic operating range than gas chromatography/mass spectrometry (GC/MS) methods. The contaminants of concern at IRP Site 14 (i.e., TCE and PCE) had been previously identified based on IRP investigation data (Section 2.1.2); therefore, the compound identification advantages of GC/MS were not warranted. The target compound list for this project was limited to TCE and PCE.

EPA Method TO-14/TO-15 was not suitable for this investigation because the minimal flow rates and sample volumes required for the micro-purge probes precluded the use of the TO methods. The TO methods require the use of Summa canisters and the smallest readily available Summa canisters have a volume of 500 mL. As the sample volumes collected from the micro-purge probes were approximately 2.5-mL, it would not have been possible to sample with Summa canisters. In addition, the experimental design called for the analysis of approximately 70 vapor samples a month (including duplicates). Using Method 8021, with an analysis time of approximately 3 minutes, this was achievable in two field days on-site. Typical costs for TO-15 analysis at a commercial laboratory are on the order of \$250/sample,

including Summa rental. Collection and analysis of 70 vapor samples would have; therefore, been prohibitively expensive.

Soil gas samples collected during this investigation were flushed through a 1 cc gas sampling valve and direct injected into the instrument. The sample syringes were flushed several times with clean air and allowed to aerate between samples.

The analyses were performed following EPA SW-846 Method 8000 protocols, modified for soil gas. Modifications from the EPA method consisted of the project-specific analyte list, absence of matrix spike samples and surrogates, and changes in calibration protocols as discussed in Section 3.3.2.

1.1.1 Equipment

The following equipment was utilized by the mobile laboratory for this project.

- **Instrument:** SRI 8610 Gas Chromatograph.
- **Column:** 30 meter DB-61, megabore capillary.
- **Carrier flow:** Nitrogen at 10 mL/min.
- **Detectors:** PID and ECD.
- **Column oven:** 80° C isothermal.

1.1.2 Detection Limits

The detection limit for the target compounds was 5 µg/m³.

1.2 QUALITY ASSURANCE/QUALITY CONTROL

1.2.1 Field Quality Control Protocols

A subset of the soil vapor sampling probes were leak checked during the TO 65 investigation by placing a cloth rag in a plastic bag, saturating the rag with 1,1-difluoroethane (DFA), placing the bag over the surface completion of the probe, and then purging the probe normally and collecting a sample. None of the probes failed the leak test; therefore, because all probes were installed using the same procedures, it was assumed that all probes were sufficiently sealed.

Purge volume tests were conducted to determine the optimum volume of gas to purge from each probe prior to sample collection. Purge tests were conducted on probes ST1-10, ST2-10, and ST3-10. The purge tests consisted of purging one or two system volumes and then collecting a sample, purging another one or two system volumes (for a total of two or three) and collecting a sample, and purging another two or three system volumes (for a total of five), and collecting a sample. The results of the purge volume tests did not convincingly indicate that any tested purge volume was superior to the others. Therefore, the default 3 system volume purge was used for subsequent sampling.

Field duplicate vapor samples were collected to measure the reproducibility and precision of the total sampling system. Field duplicate samples were collected at a rate of approximately 9 percent. Of the 67 field duplicate vapor samples collected during the program, only seven exceeded the Quality Assurance Project Plan (QAPP) (Tetra Tech 2008a, b) specified criterion of ±40 relative percent difference (RPD). A summary of the duplicate results for soil gas samples is provided in Table 3-2.

**Table 3-2
Summary of Soil Gas and Groundwater TCE Duplicate Results**

Round	Collection Date	Sample ID	Primary Concentration	Duplicate Concentration	RPD
Macro-Purge Samples ($\mu\text{g}/\text{m}^3$)					
November 2008	13-Nov-08	ST1-7	56,000	49,000	13%
November 2008	13-Nov-08	ST7-SS	4,400	4,000	10%
November 2008	13-Nov-08	ST3-10	60	46	26%
November 2008	13-Nov-08	ST1-4	37,600	38,400	2%
December 2008	17-Dec-08	ST4-10	ND	ND	
December 2008	17-Dec-08	ST5-10	48	21	78%
December 2008	17-Dec-08	ST1-10	103,000	93,000	10%
December 2008	17-Dec-08	ST2-2	71	74	4%
January 2009	20-Jan-09	ST1-4	30,000	49,000	48%
January 2009	20-Jan-09	ST4-10	ND	ND	
January 2009	20-Jan-09	ST7-7	130,000	140,000	7%
February 2009	18-Feb-09	ST1-10	5,3000	52,000	2%
February 2009	18-Feb-09	ST4-10	ND	ND	
February 2009	18-Feb-09	ST7-7	130,000	130,000	0%
March 2009	17-Mar-09	ST2-10	3,100	3,100	0%
March 2009	17-Mar-09	ST2-4	1,200	1,200	0%
March 2009	17-Mar-09	ST3-2	ND	ND	
March 2009	17-Mar-09	ST8-2	12,000	12,000	0%
March 2009	18-Mar-09	ST7-4	130,000	136,000	5%
April 2009	22-Apr-09	ST3-10	87	77	12%
April 2009	22-Apr-09	ST2-SS	ND	ND	
May 2009	18-May-09	ST7-SS	4,000	3,800	5%
May 2009	18-May-09	ST9-7	21	23	9%
May 2009	18-May-09	ST1-10	66,000	71,000	7%
June 2009	16-Jun-09	ST7-2	100,000	100,000	0%
June 2009	16-Jun-09	ST8-4	34,000	32,000	6%
June 2009	16-Jun-09	ST7-10	170,000	150,000	13%
June 2009	16-Jun-09	ST3-7	520	520	0%
June 2009	16-Jun-09	ST2-10	2,400	2,200	9%
July 2009	14-Jul-09	ST3-7	1,100	1,090	1%
July 2009	14-Jul-09	ST4-10	ND	ND	
July 2009	14-Jul-09	ST2-SS	83	22	116%
July 2009	14-Jul-09	ST9-10	206	230	11%
July 2009	14-Jul-09	ST7-SS	114	39	98%
August 2009	12-Aug-09	ST9-4	63	65	3%
August 2009	12-Aug-09	ST3-10	530	490	8%
September 2009	15-Sep-09	ST3-10	2,000	2,300	14%
October 2009	14-Oct-09	ST2-SS	1,100	1,100	0%
October 2009	14-Oct-09	ST3-10	1,100	1,300	17%
October 2009	14-Oct-09	ST4-10	24	110	128%
October 2009	14-Oct-09	ST8-2	19,000	14,000	30%

Table 3-2 (continued)

Round	Collection Date	Sample ID	Primary Concentration	Duplicate Concentration	RPD
Micro-Purge Samples ($\mu\text{g}/\text{m}^3$)					
November 2008	14-Nov-08	ST7MP-7	87,000	108,000	22%
November 2008	14-Nov-08	ST7MP-10	53,000	56,000	6%
December 2008	16-Dec-08	ST7MP-7	27,500	26,600	3%
December 2008	17-Dec-08	ST8MP-2	2,400	2,600	8%
December 2008	17-Dec-08	ST9MP-7	28	32	13%
January 2009	20-Jan-09	ST8MP-4	7,600	7,900	4%
January 2009	20-Jan-09	ST2MP-7	1,220	1,320	8%
January 2009	20-Jan-09	ST3MP-4	ND	ND	
February 2009	18-Feb-09	ST7MP-2	26,000	29,000	11%
February 2009	18-Feb-09	ST9MP-7	ND	ND	
February 2009	18-Feb-09	ST8MP-10	11,000	11,200	2%
February 2009	18-Feb-09	ST2MP-10	105	168	46%
February 2009	18-Feb-09	ST3MP-7	135	132	2%
March 2009	18-Mar-09	ST1MP-7	94,000	110,000	16%
March 2009	17-Mar-09	ST4MP-2	10	15	40%
March 2009	17-Mar-09	ST9MP-2	14	33	81%
May 2009	18-May-09	ST3MP-10	99	110	11%
April 2009	22-Apr-09	ST4MP-2	ND	ND	
April 2009	22-Apr-09	ST4MP-10	11	ND	200%
April 2009	22-Apr-09	ST7MP-10	22,000	16,000	32%
May 2009	18-May-09	ST7MP-10	46,000	52,000	12%
May 2009	18-May-09	ST8MP-10	7,800	8,400	7%
April 2009	22-Apr-09	ST9MP-4	ND	ND	
June 2009	16-Jun-09	ST2MP-4	2,700	3,500	26%
June 2009	16-Jun-09	ST4MP-10	ND	ND	
June 2009	16-Jun-09	ST8MP-2	4,800	4,400	9%
June 2009	16-Jun-09	ST8MP-10	2,800	3,200	13%
September 2009	15-Sep-09	ST3MP-7	3,000	3,500	15%
Groundwater Samples ($\mu\text{g}/\text{L}$)					
November 2008	13-Nov-08	ST4-GW	0.81J	ND	NA
December 2008	15-Dec-08	ST7-GW	470	490	4%
January 2009	19-Jan-09	ST7-GW	460	450	2%
February 2009	17-Feb-09	ST7-GW	460	450	2%
March 2009	16-Mar-09	ST7-GW	380	340	11%
April 2009	23-Apr-09	ST7-GW	510	440	15%
June 2009	15-Jun-09	ST7-GW	670	480	33%
July 2009	15-Jul-09	ST7-GW	830	830	0%
August 2009	11-Aug-09	ST7-GW	640	690	8%
September 2009	15-Sep-09	ST7-GW	490	360	31%

Definitions:

J	-estimated concentration	RPD	-relative percent difference
$\mu\text{g}/\text{L}$	-micrograms per liter	TCE	-trichloroethene
$\mu\text{g}/\text{m}^3$	-micrograms per cubic meter		
NA	-not applicable		
ND	-not detected; result is less than the detection level		

A total of 94 groundwater samples plus 10 duplicates were collected over the 12 sampling rounds. All of the RPD results for the duplicates were within the QAPP specified criterion of ± 40 RPD (Table 3-2).

One field duplicate soil sample was analyzed for the set of 12 field samples analyzed. The only analyte detected in the soil sample was TCE. The RPD between the primary and duplicate samples was 22 percent.

3.3.2 Mobile Laboratory Quality Control Protocols

Example calibration data and chromatograms are provided in Appendix C. The laboratory data packages for the entire project are on file at the HPMG offices.

3.3.2.1 Laboratory Data Logs

The field chemist maintained analytical records, including date and time of analysis, sampler's name, chemist's name, sample identification number, concentrations of compounds detected, calibration data, and any unusual conditions.

3.3.2.2 Instrument Calibration

An initial 4-point calibration curve was performed at the start of each monthly sampling round. EPA method 8000 requires the use of five levels for an initial calibration curve; however, existing soil gas guidance from the California Environmental Protection Agency (Cal/EPA) Department of Toxic Substances Control (DTSC 2003) only requires three calibration levels. A linearity check of the calibration curve for each compound was performed by computing a correlation coefficient and an average response factor.

Continuing calibration verification samples were analyzed a minimum of once per sampling day as specified in the QAPP (Tetra Tech 2008a, b). These standards were prepared from a traceable source at the middle concentration of the calibration curve. Acceptable continuing calibration agreement was set at ± 20 percent to the average response factor from the calibration curve.

A significant spike in both TCE and PCE concentrations was observed in the September 2009 soil vapor data; therefore, the calibration data from the September 2009 sampling round were reviewed to determine if the observed spike might be related to a problem with the calibration. The response factors from the calibration standards for the PID in September were about 2.5 times lower than the average of the August and October sampling rounds. The August and October response factors agreed within 30 percent. PIDs are extremely stable detectors so a shift in response of 2 to 3 times from one month to the next and then back again is atypical. It was subsequently determined that the working calibration standards for September were not made from the source calibration gas cylinder as was done for all the other rounds. Rather, an aliquot of the source standard was down-filled into a smaller container and transported to the on-site lab. The working standards were then made using the calibration gas from the smaller canister. While this procedure should have been satisfactory, there was no analysis of the concentration of the gas in the smaller canister after it was filled and; hence, it is possible that the concentration was not at the source concentration of 1000 parts per billion by volume (ppbV) for TCE and PCE. If this was the case, a lower concentration standard would yield lower response factors. Lower response factors yield higher reported concentrations for the same sample concentration. Since the increase in concentrations reported in the September sampling round were approximately a factor of 2 to 3, it raises doubt over the accuracy of the data for this round.

3.3.2.3 *Blanks*

Laboratory blanks were analyzed at the start of each sampling day. All of the blank sample results were non-detect for all compounds.

3.3.3 **Project QAPP Deviations and Additions**

During the course of implementing the program, several deviations occurred from the specifications in the QAPP (Tetra Tech 2008a, b). Specific deviations are listed below.

- The primary deviation from the QAPP was the analysis of soil vapor samples on-site using the mobile laboratory rather than sending the samples to an off-site laboratory. The QAPP stated that the soil vapor samples would be collected in evacuated head-space vials and shipped to HPMG's fixed laboratory for analysis. However, it was subsequently determined that the samples could be analyzed on-site in the mobile laboratory as a cost effective and technically superior alternative. This change was made with the prior approval of EPA and resulted in significantly better data as it eliminated potential concerns related to holding times and also allowed for the re-collection/re-analysis of samples when anomalous results were obtained.
- The QAPP stated that a total of 68 soil vapor probes would be sampled each month. This was based on the assumption that there would be collocated micro-purge probes with each macro-purge probe (with the exception of the sub-slab probes). However, due to the consistent non-detect results at ST-5, EPA removed the micro-purge probes from this location; therefore, a total of 64 probes (36 macro-purge and 28 micro-purge) were sampled each month.
- The QAPP stated that matrix spike/matrix spike duplicate (MS/MSD) groundwater samples would be analyzed every other month; however, MS/MSDs were run every month.

4.0 RESULTS AND DISCUSSION

4.1 DATA SUMMARY

4.1.1 Soil Sample Results

Soil samples were collected on October 22, 2008 from locations ST-7, ST-8, and ST-9 at depths of 2, 4, 7, and 10 feet bgs and analyzed for VOCs. TCE was detected in the samples from locations ST-7 and ST-8, but not in any of the samples from ST-9. The results are summarized in Table 4-1 with the collocated vapor sample concentrations measured in November 2008. While there was a general tendency for higher vapor concentrations to be associated with higher soil concentrations, the correlation was not a strong or predictive one.

Table 4-1
Summary of TCE Concentrations in Soil ($\mu\text{g}/\text{kg}$)

Location	Depth (ft bgs)	Sample	Soil Result	DL	Vapor ¹ $\mu\text{g}/\text{m}^3$
ST-7	2	ST7-2	25.1	0.5	40,000
ST-7	4	ST7-4	62.2	0.5	60,000
ST-7	4	ZDUP 10	50	0.5	NA
ST-7	7	ST7-7	16.7	0.5	92,000
ST-7	10	ST7-10	36.8	0.5	165,000
ST-8	2	ST8-2	4.8	0.5	4,450
ST-8	4	ST8-4	13.8	0.5	8,300
ST-8	7	ST8-7	2.9	0.5	14,700
ST-8	10	ST8-10	13.7	0.5	30,000
ST-9	2	ST9-2	ND	0.5	24
ST-9	4	ST9-4	ND	0.5	46
ST-9	7	ST9-7	ND	0.5	44
ST-9	10	ST9-10	ND	0.5	315

Notes:

- 1 – Vapor sample collected 11/13/2008, results in $\mu\text{g}/\text{m}^3$
- DL – detection level
- ft bgs – feet below ground surface
- $\mu\text{g}/\text{kg}$ – micrograms per kilogram
- $\mu\text{g}/\text{m}^3$ – micrograms per cubic meter
- NA – not applicable
- ND – not detected
- TCE - trichloroethene

4.1.2 Groundwater Sample Results

Groundwater samples were collected from each well on a monthly basis from November 2008 through October 2009 with the exception of wells ST-4 and ST-5, which did not contain sufficient water to sample in August 2009. TCE, PCE, 1,1-DCA, 1,1-DCE, *cis*-1,2-DCE, benzene, toluene, naphthalene, chloroform, and chloromethane were detected in groundwater samples; however, of these, only TCE and *cis*-1,2-DCE were detected at concentrations above 10 $\mu\text{g}/\text{L}$, and the maximum measured concentration of *cis*-1,2-DCE was 26 $\mu\text{g}/\text{L}$. In contrast, TCE was measured at concentrations up to 830 $\mu\text{g}/\text{L}$. The complete groundwater sample results are provided in Appendix D and the TCE concentrations are summarized in Table 4-2.

Table 4-2
Summary of TCE Concentrations in Groundwater (µg/L)

Sample Date	Monitoring Well Location ¹								
	RL	ST-7	ST-1	ST-8	ST-2	ST-3	ST-9	ST-4	ST-5
13-Nov-08	1.0	500	310	190	82	40	12	0.81J	ND
15-Dec-08	1.0	470	420	190	85	45	9.6	0.84J	ND
19-Jan-09	1.0	460	420	150	67	32	8.7	0.69J	ND
17-Feb-09	1.0	460	310	150	74	34	7.6	0.6J	ND
16-Mar-09	1.0	380	320	110	66	32	5.9	0.5J	ND
23-Apr-09	1.0	510	360	140	66	28	6.5	0.5J	ND
18-May-09	1.0	510	330	160	67	35	7.7	0.6J	ND
15-Jun-09	1.0	670	390	160	75	32	7.0	0.6J	ND
15-Jul-09	1.0	830	430	210	93	37	7.0	0.4J	ND
11-Aug-09	1.0	640	280	70	52	28	5.7	NS	NS
15-Sep-09	1.0	490	300	130	56	27	7.6	0.6J	ND
13-Oct-09	1.0	400	360	130	35	22	5.8	0.5J	ND

Notes:

- 1 – Well locations arranged from west to east
- J – The result is an estimated concentration below the reporting limit.
- µg/L – micrograms per liter
- ND – not detected
- NS – not sampled
- RL – reporting limit
- TCE - trichloroethene

Table 4-2 is arranged with the sampling locations listed from west to east. Locations ST-1, ST-2, ST-7, and ST-8 are on the concrete slab, while the remaining locations are on uncovered ground (Figure 4-1). The groundwater concentrations decrease along the transect from west to east. Table 4-3 shows the percent difference in TCE concentrations between adjacent sampling locations divided by the distance between the locations in feet. The rate of decrease (i.e., the decrease in concentration per foot) generally increases toward the east; although the decrease from ST-1 to ST-8 is anomalously steep (Table 4-3).

Table 4-3
Decrease in TCE Concentration per Foot

Location	ST-7 – ST-1	ST-1 – ST-8	ST-8 – ST-2	ST-2 – ST-3	ST-3 – ST-9	ST-9 – ST-4
Separation (feet)	13	6.7	8.75	5.7	9.7	10.25
	percent/foot					
13-Nov-08	3.6	7.2	9.1	12.2	11.1	17.0
15-Dec-08	0.9	11.3	8.7	10.9	13.4	16.4
19-Jan-09	0.7	14.2	8.7	12.5	11.8	16.6
17-Feb-09	3.0	10.4	7.8	13.1	13.1	16.7
16-Mar-09	1.3	14.7	5.7	12.2	14.2	16.5
23-Apr-09	2.7	13.2	8.2	14.3	12.9	16.7
18-May-09	3.3	10.4	9.4	11.1	13.2	16.7
15-Jun-09	4.1	12.5	8.3	14.2	13.3	16.4
15-Jul-09	4.9	10.3	8.8	15.2	14.1	17.4
11-Aug-09	6.0	18.0	3.4	10.6	13.7	NA
15-Sep-09	3.7	11.9	9.1	12.3	11.6	16.7
13-Oct-09	0.8	14.1	13.2	8.0	12.1	16.4
Average	2.92	12.4	8.37	12.2	12.9	16.7

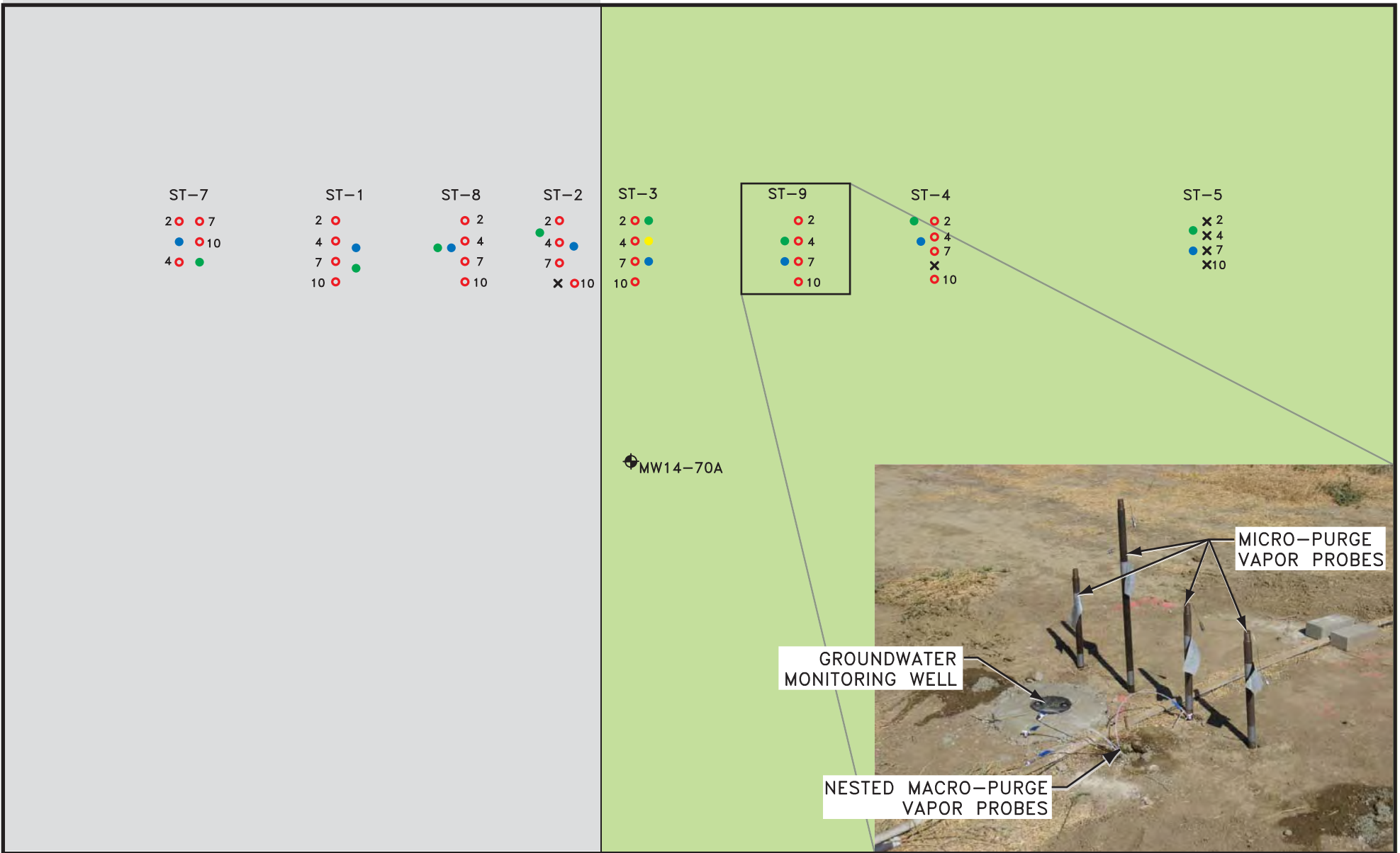

LEGEND

- NESTED MACRO-PURGE VAPOR PROBES
- 2 ○ MICRO-PURGE VAPOR PROBE WITH DEPTH INDICATED
- GROUNDWATER MONITORING WELL
- TUBING TYPE CLUSTER
- × ABANDONED MICRO-PURGE PROBE
- ⊕ IRP GROUNDWATER MONITORING WELL

PAVED AREA
 UNPAVED AREA

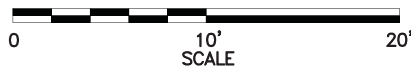

NAS Lemoore-Site 14
 U.S. Navy, NAVFAC Southwest, San Diego, California

**FIGURE 4-1
 SOUTH TRANSECT DETAIL**

STREAMS TO 85

It is noteworthy that TCE concentrations measured in well ST-3, which has a 2-foot screen across the water table, ranged from 22 to 45 µg/L, while the concentration in well MW14-70A, which has a 15-foot screen with approximately 12 feet below the water table, was measured at 320 µg/L in April 2009. Well ST-3 is located approximately 18 feet north of MW14-70A, and both wells are approximately 4 feet east of the slab edge (Figure 4-1). TCE concentrations in well MW14-70A have been increasing since June 2001.

A plot of the groundwater TCE concentrations measured over the course of the investigation is presented in Figure 4-2. The groundwater concentrations were relatively stable for most of the study period, with concentrations varying by a factor of 3 or less (factor of 2 or less for the higher concentration wells). However, a spike in concentrations measured in samples collected beneath the concrete slab occurred in June through August 2009. The reason for this transient increase in concentrations is not clear; however, it does not appear to be a sampling/analytical artifact, as it was observed in multiple wells, over three sampling rounds.

Static groundwater levels were measured at each well prior to each sampling event. The groundwater elevations generally decreased (i.e., depths increased) steadily over the course of the study, which had the effect of increasing the distance from the groundwater source to the vapor probes (Table 4-4, Figure 4-3). A modest rise in groundwater levels was observed in February and March 2009, corresponding to the winter rains received in January through March; however, as groundwater levels were only measured monthly, direct correlation with specific rainfall events is not possible.

An increase in groundwater elevations was observed in September 2009, at the end of the dry summer months. The reason for this transient rise in the groundwater table is not known; however, it was likely related to fire fighter training exercises that are conducted on the aircraft parking area to the north of the study transect. Runoff water from the training exercises flows from the paved aircraft parking area along a drainage ditch that runs south between locations ST-4 and ST-5. Percolation of this runoff water may result in temporarily raised groundwater levels. The wells with the greatest increase in water level from August to September were ST-4, ST-5, and ST-9 (the closest wells to the drainage ditch), which supports the conclusion that the September rise in water levels was likely related to fire fighter training exercises.

4.1.3 Soil Gas Samples

4.1.3.1 Macro-Purge Probes

Thirty six macro-purge probes were included in the study. An attempt was made to sample each probe every month; however, two probes were found to be clogged and were not sampled in November 2008. The probes were replaced and included in the sampling program starting in December 2008. Over the course of the study, some additional probes became clogged and could not be sampled. TCE and PCE were the only compounds measured in soil gas samples. TCE was typically detected at concentrations an order of magnitude or more higher than the corresponding PCE concentrations in the same sample. Many samples with measurable TCE concentrations did not contain measurable PCE; therefore, this report focuses on the TCE data. The complete data set for all months is provided in Appendix E. TCE and PCE concentrations detected in macro-purge vapor samples in January 2009 are summarized in Table 4-5. The January 2009 data are representative of the monthly sampling data.

4.1.3.2 Micro-Purge Probes

Micro-purge probes were collocated with the 2-, 4-, 7-, and 10-foot macro-purge probes at locations ST-1 through ST-9 (excluding ST-6). No sub-slab micro-purge probes were installed. Thirty-two micro-purge probes were included in the November and December sampling rounds. EPA removed the micro-purge

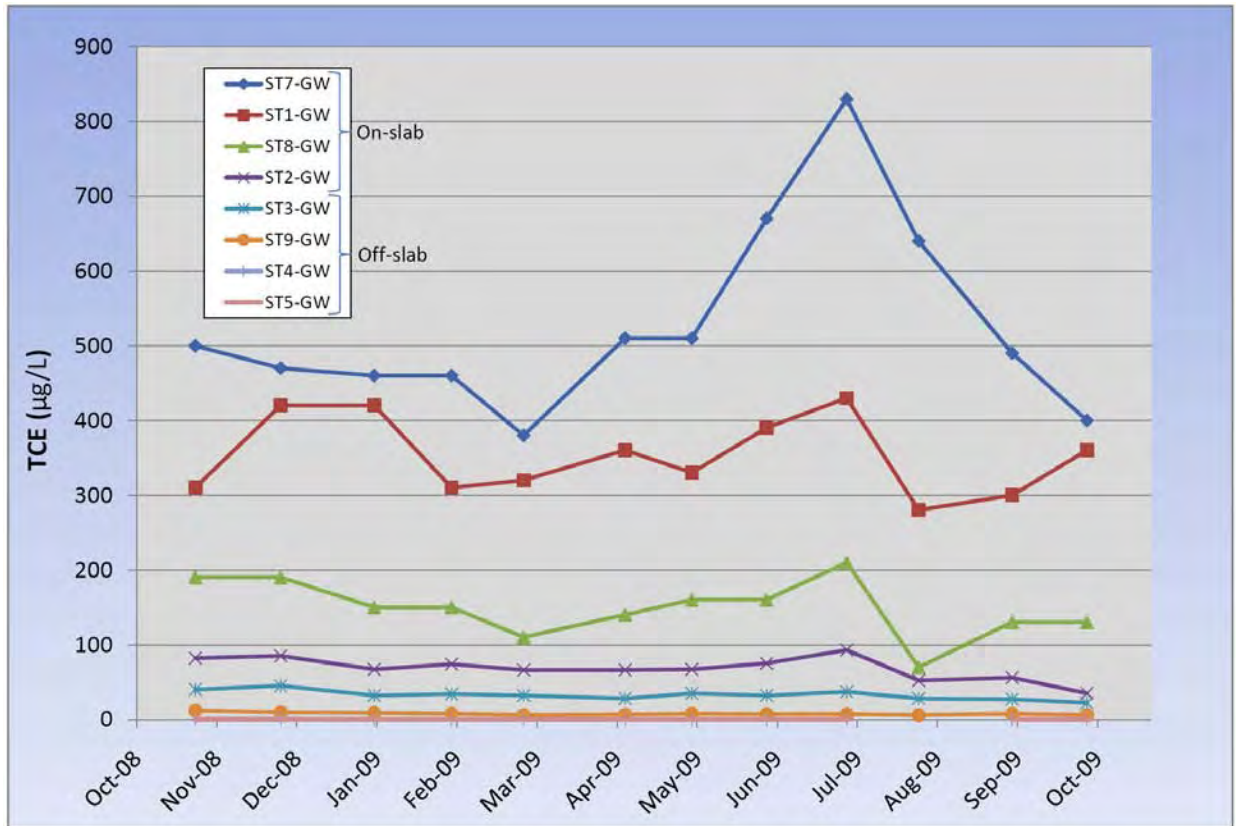

Figure 4-2 Groundwater TCE Concentrations

Table 4-4
Summary of Groundwater Level Measurements (feet bTOC)

Sample Date	Monitoring Well Location ¹							
	ST-7	ST-1	ST-8	ST-2	ST-3	ST-9	ST-4	ST-5
November 2008	12.18	12.01	12.05	11.82	11.42	11.58	11.79	11.06
December 2008	12.29	12.11	12.12	11.92	11.50	11.68	11.43	11.10
January 2009	12.20	11.99	12.05	11.79	11.45	11.62	11.48	11.10
February 2009	12.30	11.86	11.76	11.55	11.19	11.10	10.86	10.42
March 2009	11.86	11.80	11.66	11.36	11.18	11.26	11.09	10.76
April 2009	12.26	12.10	12.18	11.95	11.65	11.83	11.66	11.33
May 2009	12.34	12.25	12.27	12.05	11.68	11.79	11.66	11.29
June 2009	12.47	12.28	12.33	12.06	11.72	11.88	11.76	11.39
July 2009	12.80	12.63	12.65	12.45	12.10	12.32	12.16	11.86
August 2009	12.97	12.84	12.92	12.71	12.39	12.57	12.31	12.11
September 2009	13.00	12.75	12.79	12.46	12.00	12.04	11.81	11.37
October 2009	13.26	13.12	13.15	12.95	12.52	12.60	12.30	12.05

Notes:

- 1 – Well locations arranged from west to east
- bTOC –below top of casing

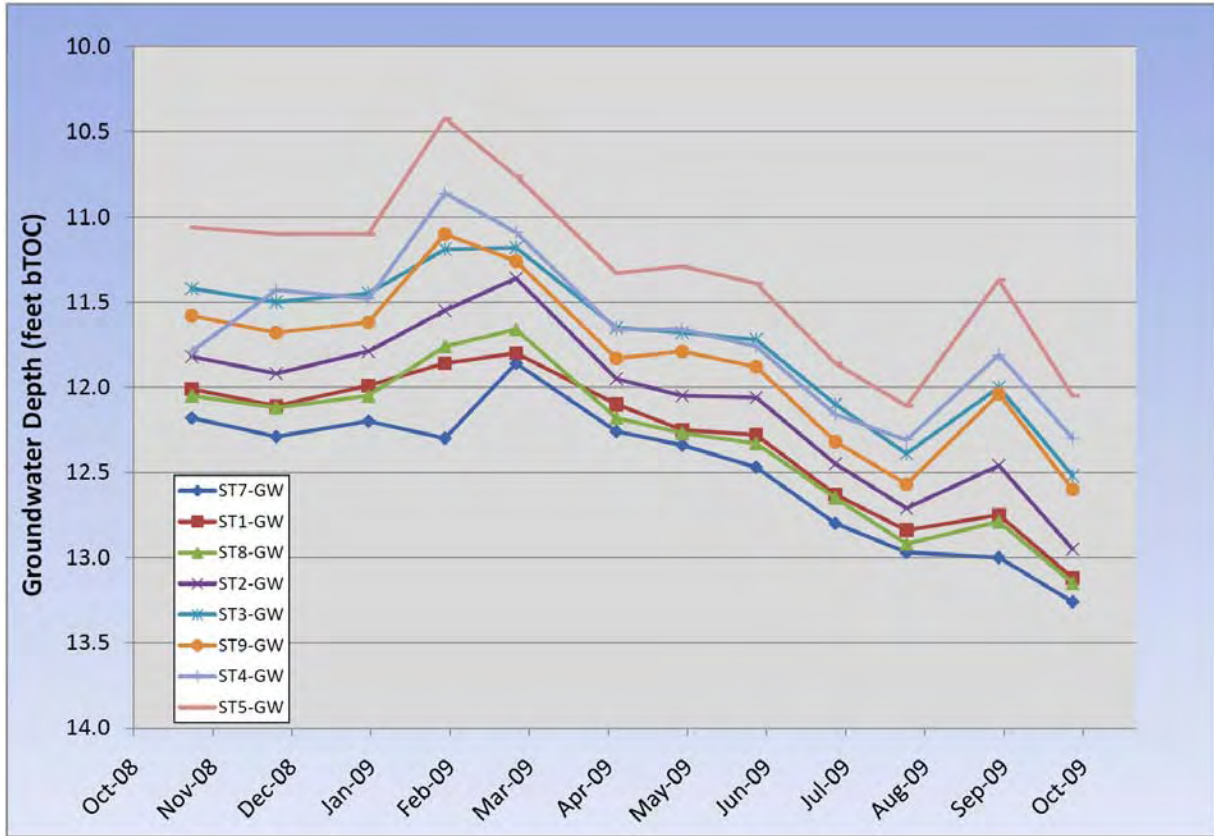

Figure 4-3 Groundwater Levels

Table 4-5
Summary of TCE and PCE Concentrations in Macro-Purge Vapor Samples
January 2009 ($\mu\text{g}/\text{m}^3$)

Sample Depth (ft bgs)	Vapor Probe Location ¹									
	TCE									
	DL	ST-7	ST-1	ST-8	ST-2	ST-3	ST-9	ST-4	ST-5	
SS	5.0	4,100	660	290	33	NA	NA	NA	NA	
2	5.0	57,000	9,100	6,700	95	44	ND	ND	ND	
4	5.0	97,000	30,000	23,000	1,200	93	20	ND	ND	
7	5.0	130,000	64,000	30,000	2,600	230	34	ND	ND	
10	5.0	200,000	84,000	52,000	2,700	83	260	ND	ND	
		PCE								
SS	5.0	58	ND	ND	ND	NA	NA	NA	NA	
2	5.0	1,000	140	130	ND	ND	ND	ND	ND	
4	5.0	1,700	450	340	42	ND	ND	ND	ND	
7	5.0	3,400	1,100	490	90	39	19	ND	ND	
10	5.0	4,700	1,450	820	140	61	44	ND	ND	

Notes:

1 – Probe locations arranged from west to east
 DL – detection level
 ft bgs – feet below ground surface
 $\mu\text{g}/\text{m}^3$ – micrograms per cubic meter
 NA – not applicable

ND – not detected
 PCE - tetrachloroethene
 SS – sub-slab
 TCE – trichloroethene

probes at location ST-5 after the December 2008 sampling round and at location ST-4 after the June 2009 sampling round. Therefore, the January through June rounds included only 28 micro-purge probes and the July through October rounds included only 24 micro-purge probes.

TCE and PCE were the only compounds measured in the micro-purge soil gas samples. Like the macro-purge samples, TCE was typically measured at concentrations an order of magnitude or more higher than the corresponding PCE concentrations in the same sample. The complete data set for all months is provided in Appendix E. TCE and PCE concentrations detected in micro-purge vapor samples in January 2009 are summarized in Table 4-6.

Table 4-6
Summary of TCE and PCE Concentrations in Micro-Purge Vapor Samples
January 2009 ($\mu\text{g}/\text{m}^3$)

Sample Depth (ft bgs)	Vapor Probe Location ¹							
	TCE							
	DL	ST-7	ST-1	ST-8	ST-2	ST-3	ST-9	ST-4
2	5.0	32,000	2,500	1,100	170	20	ND	ND
4	5.0	110,000	39,000	7,600	1,470	ND	25	ND
7	5.0	57,000	46,000	9,600	1,220	300	27	ND
10	5.0	78,000	66,000	12,100	960	250	67	ND
	PCE							
2	5.0	610	64	48	ND	ND	ND	ND
4	5.0	2,900	640	70	58	ND	ND	ND
7	5.0	1,340	890	160	56	38	16	ND
10	5.0	2,400	1,400	216	130	46	ND	ND

Notes:

1 – Probe locations arranged from west to east
 DL – detection level
 ft bgs – feet below ground surface
 $\mu\text{g}/\text{m}^3$ – micrograms per cubic meter
 NA – not applicable

ND – not detected
 PCE - tetrachloroethene
 SS – sub-slab
 TCE – trichloroethene

A comparison of TCE concentrations detected in macro-purge probes versus the corresponding collocated micro-purge probe is presented in Table 4-7.

Plots of the macro-purge and micro-purge sample results for TCE are presented in Figures 4-4 and 4-5, respectively. The plots show that, with the exception of the September 2009 data, the variability in TCE concentrations was generally limited to less than a factor of 2. A significant spike in concentrations was observed in the September 2009 data, particularly in the macro-purge samples. This spike in concentrations is suspected of being related to a possible calibration error (Section 3.3.2.2); therefore, the September soil vapor data are considered suspect.

4.1.3.3 Sampling Parameters Study

Three parameters were evaluated for the Sampling Parameters Study: purge rate, purge volume, and sample volume. The experimental approach was to hold two of these parameters constant while varying the third to assess the impact on measured VOC concentrations. For each of the parameters, five separate probes were selected and a minimum of five samples were collected from each of the five probes. For the purge rate experiment, purge volume and sample volume were held at 3 system volumes and 20 mL, respectively, and purge rate was varied from 100 to 4,000 mL/min. For the purge volume experiment,

Table 4-7
Comparison of TCE Concentrations in Macro-purge and Micro-purge Vapor Samples

Sampling Round	Location	Depth (feet bgs)	Macro-purge Result	Micro-purge Result	Percent Difference	Factor
November 2008	ST-1	2	8,350	8,900	-6.38%	1.07
November 2008	ST-1	4	37,600	64,000	-51.97%	1.70
November 2008	ST-1	7	56,000	210	198.51%	267
November 2008	ST-1	10	90,000	38	199.83%	2368
November 2008	ST-2	2	200	280	-33.33%	1.40
November 2008	ST-2	4	1,000	1,900	-62.07%	1.90
November 2008	ST-2	7	2,700	3,100	-13.79%	1.15
November 2008	ST-2	10	2,500	1,400	56.41%	1.79
November 2008	ST-3	7	197	330	-50.47%	1.68
November 2008	ST-3	10	60	300	-133.33%	5.00
November 2008	ST-7	2	40,000	66,000	-49.06%	1.65
November 2008	ST-7	4	60,000	158,000	-89.91%	2.63
November 2008	ST-7	7	92,000	87,000	5.59%	1.06
November 2008	ST-7	10	165,000	53,000	102.75%	3.11
November 2008	ST-8	2	4,450	6,900	-43.17%	1.55
November 2008	ST-8	4	8,300	4,100	67.74%	2.02
November 2008	ST-8	7	14,700	8,600	52.36%	1.71
November 2008	ST-8	10	30,000	7,300	121.72%	4.11
November 2008	ST-9	7	44	15	98.31%	2.93
November 2008	ST-9	10	315	35	160.00%	9.00
December 2008	ST-1	2	9,800	6,700	37.58%	1.46
December 2008	ST-1	4	52,000	38,000	31.11%	1.37
December 2008	ST-2	2	71	210	-98.93%	2.96
December 2008	ST-2	4	1,600	1,140	33.58%	1.40
December 2008	ST-2	7	4,250	2,700	44.60%	1.57
December 2008	ST-2	10	4,200	1,300	105.45%	3.23
December 2008	ST-3	2	62	22	95.24%	2.82
December 2008	ST-3	7	315	270	15.38%	1.17
December 2008	ST-3	10	93	270	-97.52%	2.90
December 2008	ST-7	2	55,000	30,000	58.82%	1.83
December 2008	ST-7	4	130,000	96,000	30.09%	1.35
December 2008	ST-7	7	190,000	27,500	149.43%	6.91
December 2008	ST-7	10	350,000	114,000	101.72%	3.07
December 2008	ST-8	2	7,400	2,400	102.04%	3.08
December 2008	ST-8	4	24,500	8,200	99.69%	2.99
December 2008	ST-8	7	41,000	9,500	124.75%	4.32
December 2008	ST-8	10	55,000	9,400	141.61%	5.85
December 2008	ST-9	2	23	12	62.86%	1.92
December 2008	ST-9	4	34	44	-25.64%	1.29
December 2008	ST-9	7	41	28	37.68%	1.46
December 2008	ST-9	10	370	35	165.43%	10.57
January 2009	ST-1	2	9,100	2,500	113.79%	3.64
January 2009	ST-1	4	30,000	39,000	-26.09%	1.30
January 2009	ST-1	7	64,000	46,000	32.73%	1.39
January 2009	ST-1	10	84,000	66,000	24.00%	1.27
January 2009	ST-2	2	95	170	-56.60%	1.79
January 2009	ST-2	4	1,200	1,470	-20.22%	1.23
January 2009	ST-2	7	2,600	1,220	72.25%	2.13
January 2009	ST-2	10	2,700	960	95.08%	2.81
January 2009	ST-3	2	44	20	75.00%	2.20
January 2009	ST-3	7	230	300	-26.42%	1.30
January 2009	ST-3	10	83	250	-100.30%	3.01
January 2009	ST-7	2	57,000	32,000	56.18%	1.78
January 2009	ST-7	4	97,000	110,000	-12.56%	1.13
January 2009	ST-7	7	130,000	57,000	78.07%	2.28
January 2009	ST-7	10	200,000	78,000	87.77%	2.56

Table 4-7
Comparison of TCE Concentrations in Macro-purge and Micro-purge Vapor Samples

Sampling Round	Location	Depth (feet bgs)	Macro-purge Result	Micro-purge Result	Percent Difference	Factor
January 2009	ST-8	2	6,700	1,100	143.59%	6.09
January 2009	ST-8	4	23,000	7,600	100.65%	3.03
January 2009	ST-8	7	30,000	9,600	103.03%	3.13
January 2009	ST-8	10	52,000	12,100	124.49%	4.30
January 2009	ST-9	4	20	25	-22.22%	1.25
January 2009	ST-9	7	34	27	22.95%	1.26
January 2009	ST-9	10	260	67	118.04%	3.88
February 2009	ST-1	2	9,500	3,500	92.31%	2.71
February 2009	ST-1	4	22,000	28,500	-25.74%	1.30
February 2009	ST-1	7	54,000	32,000	51.16%	1.69
February 2009	ST-1	10	53,000	44,000	18.56%	1.20
February 2009	ST-2	2	186	86	73.53%	2.16
February 2009	ST-2	4	1,600	1,240	25.35%	1.29
February 2009	ST-2	7	2,900	1,500	63.64%	1.93
February 2009	ST-2	10	2,840	105	185.74%	27.05
February 2009	ST-3	7	210	135	43.48%	1.56
February 2009	ST-3	10	77	98	-24.00%	1.27
February 2009	ST-7	2	44,000	26,000	51.43%	1.69
February 2009	ST-7	4	85,000	110,000	-25.64%	1.29
February 2009	ST-7	7	130,000	75,000	53.66%	1.73
February 2009	ST-7	10	150,000	47,000	104.57%	3.19
February 2009	ST-8	2	7,700	2,300	108.00%	3.35
February 2009	ST-8	4	26,000	7,100	114.20%	3.66
February 2009	ST-8	7	27,000	7,900	109.46%	3.42
February 2009	ST-8	10	34,000	11,000	102.22%	3.09
February 2009	ST-9	10	165	16	164.64%	10.31
March 2009	ST-1	2	6,547	2,000	106.40%	3.27
March 2009	ST-1	4	53,000	81,000	-41.79%	1.53
March 2009	ST-1	7	65,000	94,000	-36.48%	1.45
March 2009	ST-1	10	83,000	130,000	-44.13%	1.57
March 2009	ST-2	2	53	58	-9.01%	1.09
March 2009	ST-2	4	1,200	1,400	-15.38%	1.17
March 2009	ST-2	7	2,800	1,900	38.30%	1.47
March 2009	ST-2	10	3,100	200	175.76%	15.50
March 2009	ST-3	7	110	100	9.52%	1.10
March 2009	ST-3	10	38	110	-97.30%	2.89
March 2009	ST-7	2	69,000	55,000	22.58%	1.25
March 2009	ST-7	4	130,000	200,000	-42.42%	1.54
March 2009	ST-7	7	136,000	150,000	-9.79%	1.10
March 2009	ST-7	10	126,000	79,000	45.85%	1.59
March 2009	ST-8	2	12,000	3,000	120.00%	4.00
March 2009	ST-8	4	28,000	9,300	100.27%	3.01
March 2009	ST-8	7	33,000	21,000	44.44%	1.57
March 2009	ST-8	10	34,000	20,000	51.85%	1.70
March 2009	ST-9	10	75	30	85.71%	2.50
April 2009	ST-1	4	53000	72000	-30.40%	1.36
April 2009	ST-1	7	74000	83000	-11.46%	1.12
April 2009	ST-1	10	76000	51000	39.37%	1.49
April 2009	ST-2	4	1900	1800	5.41%	1.06
April 2009	ST-2	7	3500	2000	54.55%	1.75
April 2009	ST-2	10	3200	1000	104.76%	3.20
April 2009	ST-3	7	290	140	69.77%	2.07
April 2009	ST-3	10	87	80	8.38%	1.09

Table 4-7
Comparison of TCE Concentrations in Macro-purge and Micro-purge Vapor Samples

Sampling Round	Location	Depth (feet bgs)	Macro-purge Result	Micro-purge Result	Percent Difference	Factor
April 2009	ST-7	2	110000	65000	51.43%	1.69
April 2009	ST-7	4	212000	190000	10.95%	1.12
April 2009	ST-7	7	210000	160000	27.03%	1.31
April 2009	ST-7	10	210000	22000	162.07%	9.55
April 2009	ST-8	2	17000	5000	109.09%	3.40
April 2009	ST-8	4	39000	16000	83.64%	2.44
April 2009	ST-8	7	38000	18000	71.43%	2.11
April 2009	ST-8	10	41000	12000	109.43%	3.42
April 2009	ST-9	10	110	14	154.84%	7.86
May 2009	ST-1	4	41000	52000	-23.66%	1.27
May 2009	ST-1	10	66000	47000	33.63%	1.40
May 2009	ST-2	4	2500	2800	-11.32%	1.12
May 2009	ST-2	7	4000	2800	35.29%	1.43
May 2009	ST-2	10	3400	1300	89.36%	2.62
May 2009	ST-3	2	48	13	114.75%	3.69
May 2009	ST-3	7	700	300	80.00%	2.33
May 2009	ST-3	10	280	99	95.51%	2.83
May 2009	ST-7	2	120000	66000	58.06%	1.82
May 2009	ST-7	4	230000	190000	19.05%	1.21
May 2009	ST-7	7	220000	160000	31.58%	1.38
May 2009	ST-7	10	220000	46000	130.83%	4.78
May 2009	ST-8	2	4700	5000	-6.19%	1.06
May 2009	ST-8	4	32000	7500	124.05%	4.27
May 2009	ST-8	7	34000	15000	77.55%	2.27
May 2009	ST-8	10	31000	7800	119.59%	3.97
May 2009	ST-9	7	21	10	70.97%	2.10
June 2009	ST-1	7	67,000	27,000	85.11%	2.48
June 2009	ST-1	10	78,000	25,000	102.91%	3.12
June 2009	ST-2	4	1,800	2,700	-40.00%	1.50
June 2009	ST-2	7	3,100	1,800	53.06%	1.72
June 2009	ST-2	10	2,400	1,100	74.29%	2.18
June 2009	ST-3	2	130	48	92.13%	2.71
June 2009	ST-3	7	520	480	8.00%	1.08
June 2009	ST-3	10	350	290	18.75%	1.21
June 2009	ST-7	2	100,000	28,000	112.50%	3.57
June 2009	ST-7	4	180,000	82,000	74.81%	2.20
June 2009	ST-7	7	190,000	49,000	117.99%	3.88
June 2009	ST-7	10	170,000	6,800	184.62%	25.00
June 2009	ST-8	2	16,000	4,800	107.69%	3.33
June 2009	ST-8	4	34,000	8,500	120.00%	4.00
June 2009	ST-8	7	33,000	7,300	127.54%	4.52
June 2009	ST-8	10	35,000	2,800	170.37%	12.50
June 2009	ST-9	4	35	26	29.51%	1.35
June 2009	ST-9	7	24	19	23.26%	1.26
June 2009	ST-9	10	260	30	158.62%	8.67
July 2009	ST-1	10	95,000	26,000	114.05%	3.65
July 2009	ST-2	7	5,800	3,700	44.21%	1.57
July 2009	ST-2	10	4,000	2,600	42.42%	1.54
July 2009	ST-3	2	100	59	51.57%	1.69
July 2009	ST-3	7	1,100	960	13.59%	1.15
July 2009	ST-3	10	600	560	6.90%	1.07
July 2009	ST-7	4	230,000	103,000	76.28%	2.23
July 2009	ST-7	7	270,000	66,000	121.43%	4.09
July 2009	ST-7	10	300,000	20,000	175.00%	15.00

Table 4-7
Comparison of TCE Concentrations in Macro-purge and Micro-purge Vapor Samples

Sampling Round	Location	Depth (feet bgs)	Macro-purge Result	Micro-purge Result	Percent Difference	Factor
July 2009	ST-8	2	18,000	15,000	18.18%	1.20
July 2009	ST-8	4	48,000	5,000	162.26%	9.60
July 2009	ST-8	7	50,000	8,500	141.88%	5.88
July 2009	ST-8	10	46,000	7,000	147.17%	6.57
July 2009	ST-9	4	47	29	47.37%	1.62
July 2009	ST-9	7	44	25	55.07%	1.76
July 2009	ST-9	10	206	75*	93.24%	2.75
August 2009	ST-2	7	4,500	4,100	9.30%	1.10
August 2009	ST-2	10	3,900	1,400	94.34%	2.79
August 2009	ST-3	2	150	72	70.27%	2.08
August 2009	ST-3	7	1,030	1,040	-0.97%	1.01
August 2009	ST-3	10	530	540	-1.87%	1.02
August 2009	ST-7	4	180,000	77,000	80.16%	2.34
August 2009	ST-7	7	230,000	54,000	123.94%	4.26
August 2009	ST-7	10	220,000	23,000	162.14%	9.57
August 2009	ST-8	2	11,000	11,000	0.00%	1.00
August 2009	ST-8	4	35,000	4,000	158.97%	8.75
August 2009	ST-8	7	42,000	7,400	140.08%	5.68
August 2009	ST-8	10	39,000	4,500	158.62%	8.67
August 2009	ST-9	4	63	21	100.00%	3.00
August 2009	ST-9	7	31	44	-34.67%	1.42
August 2009	ST-9	10	290	76	116.94%	3.82
September 2009	ST-2	10	21,000	4,300	132.02%	4.88
September 2009	ST-3	2	430	750	-54.24%	1.74
September 2009	ST-3	10	2,000	3,000	-40.00%	1.50
September 2009	ST-7	7	710,000	180,000	119.10%	3.94
September 2009	ST-7	10	680,000	120,000	140.00%	5.67
September 2009	ST-8	2	36,000	16,000	76.92%	2.25
September 2009	ST-8	4	110,000	12,000	160.66%	9.17
September 2009	ST-8	7	110,000	32,000	109.86%	3.44
September 2009	ST-8	10	110,000	25,000	125.93%	4.40
September 2009	ST-9	4	120	29	122.15%	4.14
September 2009	ST-9	7	150	24	144.83%	6.25
September 2009	ST-9	10	790	150	136.17%	5.27
October 2009	ST-2	10	5,800	2,200	90.00%	2.64
October 2009	ST-3	2	120	150	-22.22%	1.25
October 2009	ST-3	10	1,100	790	32.80%	1.39
October 2009	ST-7	7	300,000	82,000	114.14%	3.66
October 2009	ST-7	10	330,000	50,000	147.37%	6.60
October 2009	ST-8	2	19,000	7,900	82.53%	2.41
October 2009	ST-8	4	41,000	14,000	98.18%	2.93
October 2009	ST-8	7	48,000	15,000	104.76%	3.20
October 2009	ST-8	10	51,000	12,000	123.81%	4.25
October 2009	ST-9	7	160	51	103.32%	3.14
October 2009	ST-9	10	360	100	113.04%	3.60
				Minimum:	-133.33%	1.00
				Maximum:	199.83%	2368

Definitions:

bgs - below ground surface
TCE - trichloroethene

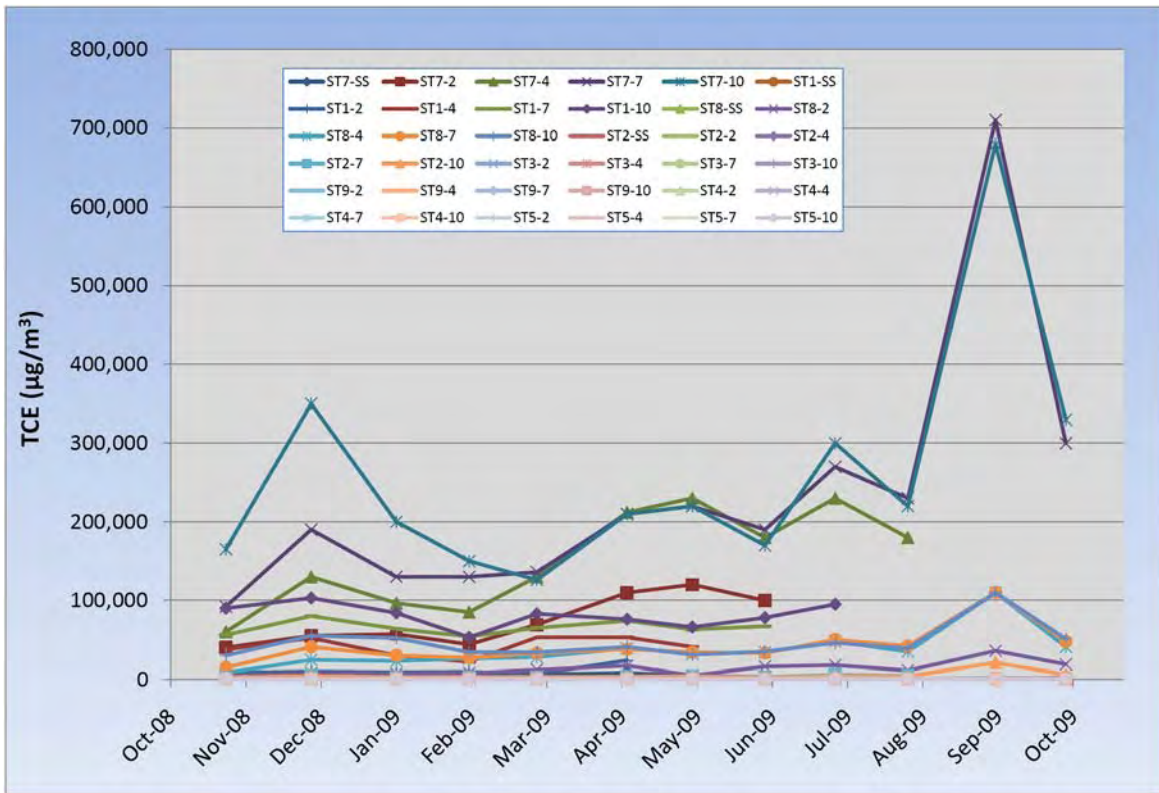

Figure 4-4 Macro-Purge Vapor Probe TCE Concentrations

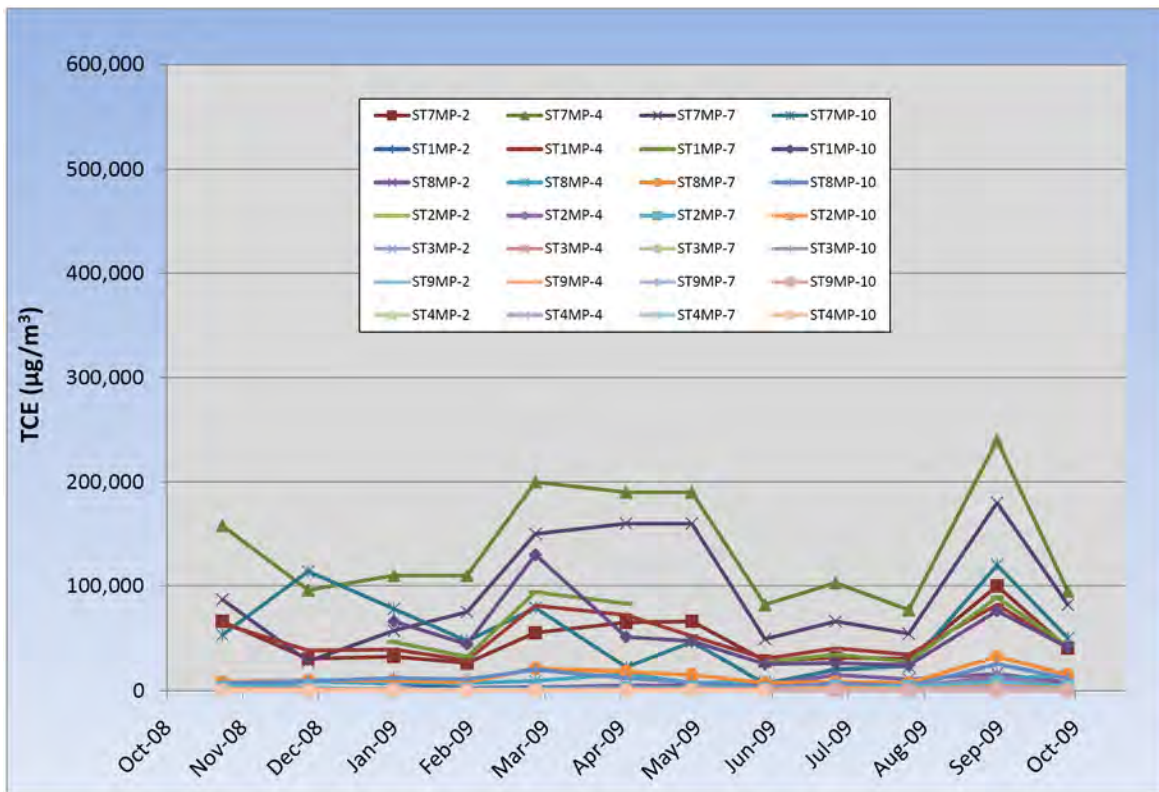

Figure 4-5 Micro-Purge Vapor Probe TCE Concentrations

purge rate and sample volume were held at 200 mL/min and 20 mL, respectively, and purge volume was varied from 1 to 67 system volumes. For the sample volume experiment, purge rate and volume were held at 200 mL/min and 3 system volumes, respectively, and sample volume was varied from 10 to 6,000 mL. Tables of results from the sampling parameters study are provided in Appendix B.

4.2 DISCUSSION

4.2.1 Distribution of VOCs in the Subsurface

Figure 4-6 presents a schematic representation of the distribution of TCE along the primary (south) transect based on the January 2009 macro-purge vapor sample concentrations (corresponding schematic diagrams based on additional sampling rounds are presented in Appendix F). In viewing these profiles, it is important to note that the distribution and movement of gas phase VOCs through the vadose zone is dominated by diffusion processes, which are driven by concentration gradients and not by pressure or density gradients.

As expected, vapor concentrations decreased with increasing distance from the groundwater source (Figure 4-6). This observation is consistent with the physical principles of subsurface vapor diffusion from a groundwater source. Vapor concentrations also decreased horizontally moving out from under the slab. This observation is consistent with the physical effect of the slab trapping soil vapor and preventing it from being released to the atmosphere.

TCE concentrations in the top 1 to 2 feet of the groundwater column also decreased moving out from under the slab. This observation was unexpected based on IRP groundwater sampling data for Site 14. The TCE concentration in samples from groundwater monitoring well MW14-70A, located off-slab and immediately south of the vapor sampling transect (Figure 2-3), has been increasing since 2001 and was measured at 320 $\mu\text{g/L}$ in April 2009. Thus, TCE concentrations measured along the sampling transect were expected to be on the order of 300 $\mu\text{g/L}$. However, concentrations measured immediately off-slab (location ST-3) were an order of magnitude lower than the MW14-70A concentrations and decreased to less than 1 $\mu\text{g/L}$ at ST-4, approximately 20 feet east of the slab edge (Figure 4-6 and Table 4-2).

The Henry's Law equilibrium vapor concentrations calculated from the measured groundwater concentrations (assuming a groundwater temperature of 21° C, which is typical of the groundwater temperatures that were measured during sampling) are in parentheses (Figure 4-6). By comparing the measured 10-foot bgs vapor concentrations to the calculated equilibrium vapor concentrations, the calculated equilibrium concentrations were approximately the same as the measured concentrations under the slab at locations ST-7, ST-1, and ST-8, but were at least an order of magnitude higher than the measured concentrations from ST-2 through ST-4. This observation indicates that the concentration gradient across the groundwater-vapor interface was significantly lower beneath the slab than in the uncovered area. This is likely due to differences in the rate of diffusion in the vapor phase versus the aqueous phase and the trapping effect of the slab. In the paved area, vapors are trapped at the surface and must diffuse laterally out from under the slab. This results in higher vapor concentrations throughout the soil column, with concentrations close to equilibrium at the groundwater-vapor interface. In the uncovered area, VOCs can quickly diffuse vertically through the vadose zone to the surface and escape to the atmosphere; thus, VOC mass transfer out of the groundwater and into the soil vapor appears to be the rate-limiting step. As a result, the vapor concentrations just above the groundwater table in the uncovered area are relatively low compared to the calculated equilibrium concentrations.

The data presented in Figure 4-6 (and Appendix F) also illustrate how concentration gradients exist at this site to drive VOC mass from the groundwater source up and out from underneath the slab so that it can

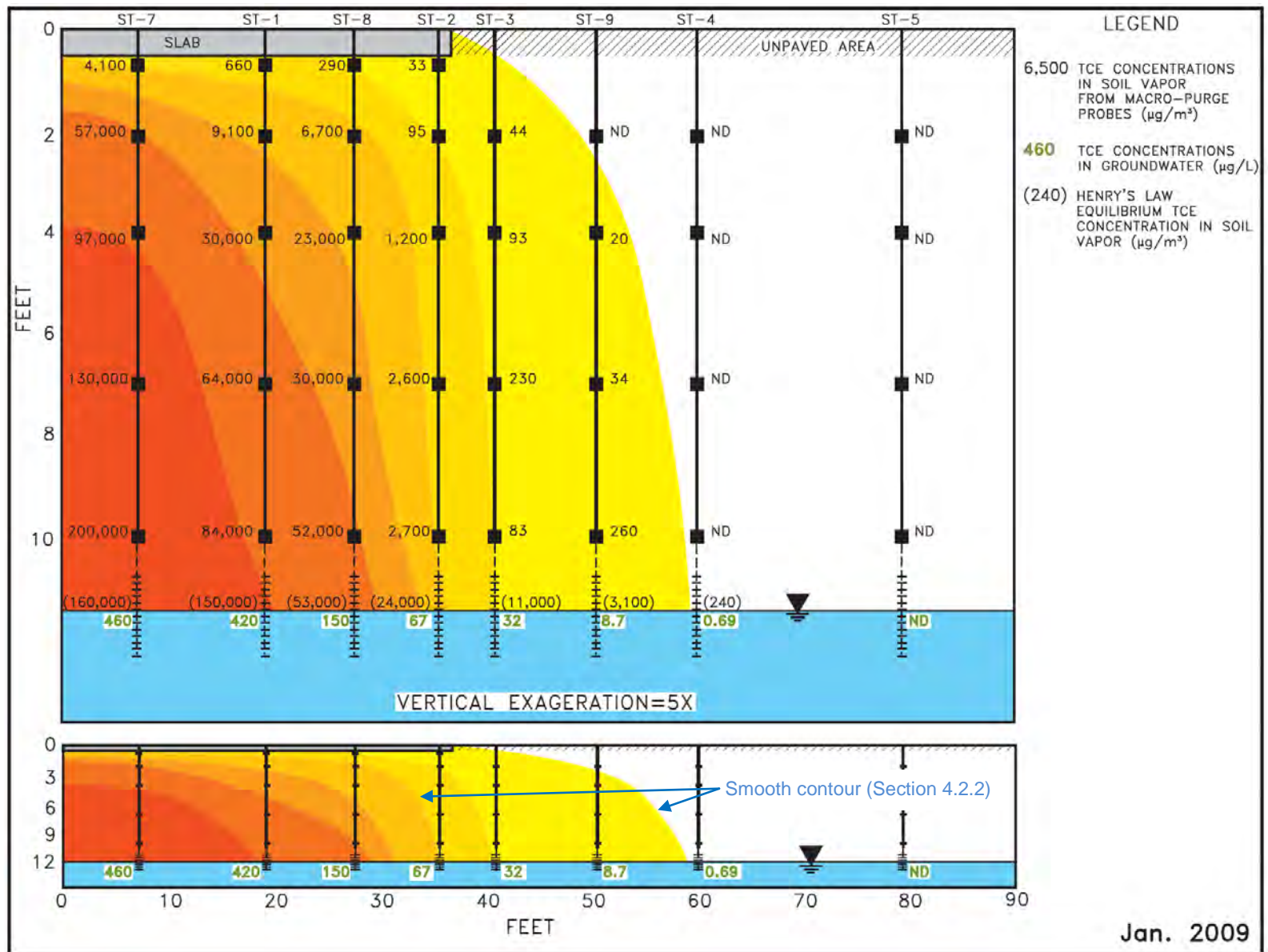

Figure 4-6 Schematic Isoconcentration Contours (January 2009 macro-purge data)

escape to the atmosphere. Specifically, vertical concentration gradients in the vadose zone drive VOC mass up from the groundwater source toward the slab or the uncovered ground surface. Horizontal concentration gradients drive VOC mass in the vapor phase out from under the slab so that it can escape to the atmosphere. Horizontal gradients also exist in the shallow groundwater to drive VOC mass out from under the slab; however, it is important to note that the process of diffusive mass transfer occurs more slowly in the aqueous phase than in the vapor phase. Concentration gradients across the groundwater-vapor interface drive VOC mass out of the groundwater and into the vapor phase.

Taken together, these observations indicate that the near-slab environment is in a steady state, or dynamic equilibrium, governed by diffusive mass transfer. Beneath the slab, vapor- and aqueous-phase VOC concentrations are approximately in equilibrium and the rate limiting step governing mass transfer is the movement of vapors laterally out from under the slab so that they can escape to the atmosphere. In the uncovered area, the rate limiting step is the transfer of VOC mass up from deeper groundwater and out of the groundwater into the vapor phase. Once in the vapor phase, the VOCs diffuse relatively quickly toward the ground surface. Because the rate of diffusive mass transfer is much slower in the aqueous phase than in vapor, this process apparently led to depletion of VOCs in the shallow groundwater beneath the uncovered area. Thus, the presence or absence of a slab may impact VOC concentrations not only in the vapor phase but also in the shallow groundwater.

4.2.2 Temporal Variability

In general, excluding the September 2009 data (see Section 3.3.2.2), the variability in TCE concentrations over the 12-month study period was less than a factor of 4 for probes installed under the slab (Figure 4-7). The variability in concentrations for probes installed in the uncovered areas was higher, generally ranging from a factor of 4 to approximately 30, but the concentrations in the uncovered areas were lower and thus subject to more variability (Figure 4-8). Overall, concentrations increased modestly over the study period.

Comparison of the groundwater concentration data (Figure 4-2) to the vapor measurements (Figures 4-7 and 4-8) indicates that variability in vapor concentrations was not strongly linked to changes in groundwater concentrations. TCE concentrations in groundwater were relatively stable over the 12 month study period, with a modest spike observed in July 2009. Soil vapor concentrations also exhibited a modest spike in July 2009, particularly under the slab. However, a more pronounced spike in vapor concentrations was observed in the December 2008 data, with no corresponding spike in groundwater concentrations. The depth to groundwater at each monitoring well increased over the course of the study (Figure 4-3), which effectively increased the distance between the vapor probes and the groundwater source of VOCs. This change to the depth of the groundwater would be expected to cause a decrease in vapor concentrations with time. However, as noted above, the vapor concentrations increased with time, indicating that factors other than groundwater concentrations and depth to the groundwater source have a greater effect on variations in the vapor concentrations. The explanation for the steady increase in vapor concentrations is unclear from the available data; however, the observations that measured groundwater concentrations beneath the transect remained relatively stable and the depth to groundwater increased suggests that there may be variability in the soil vapor or groundwater concentrations to the west, or out of the plane of the study transect, that are affecting transect concentrations. For example, an increase in vapor concentrations to the west of the transect would likely result in an increase in mass flux toward the east.

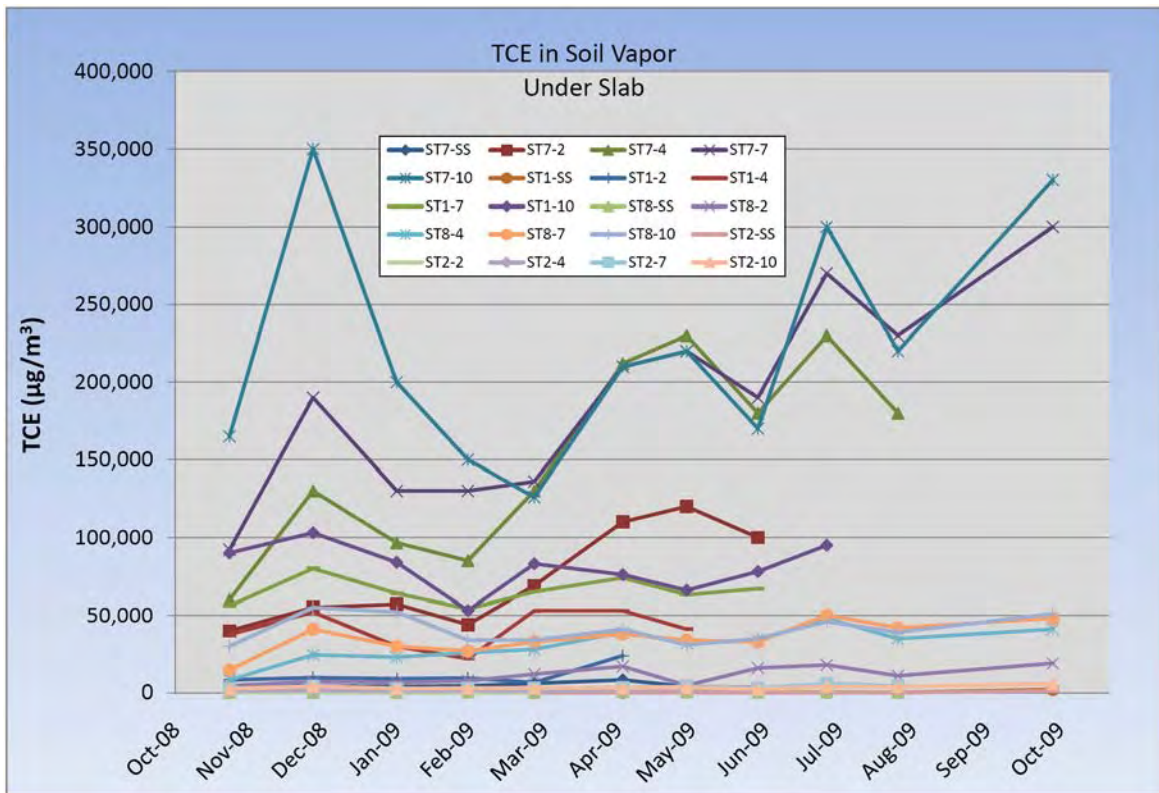

Figure 4-7 Temporal Trends in Soil Vapor Concentrations Under the Slab

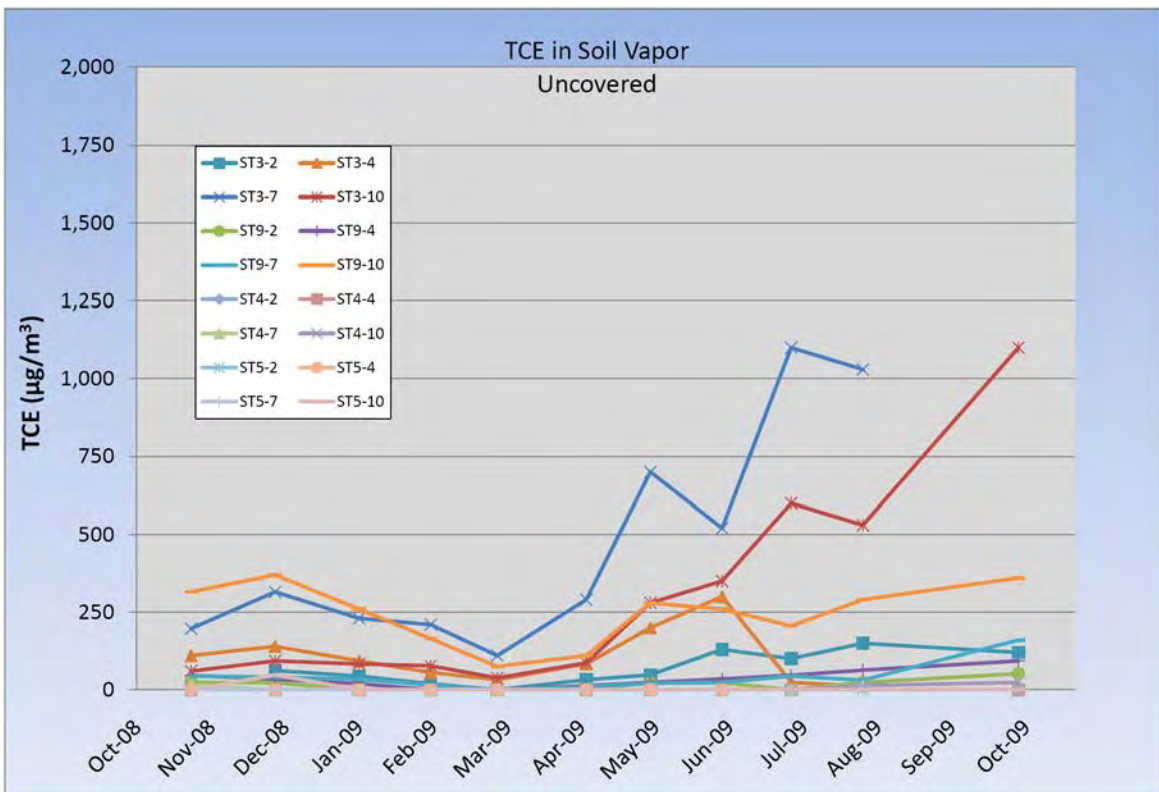

Figure 4-8 Temporal Trends in Soil Vapor Concentrations in Uncovered Locations

Review of the schematic isoconcentration contour diagrams presented in Figure 4-6 and Appendix F indicate that there was no significant seasonal variability in the distribution of TCE in soil vapor; rather, the diagrams reflect the steady overall increase in concentration with time, as shown more directly in Figures 4-7 and 4-8. Some subtle variation in the shape of the contours was observed but these are not believed to be significant.

It should be emphasized that the diagrams presented in Figures 4-6 and 4-9 and Appendix F are schematic only; therefore, caution is needed in drawing conclusions from the diagrams. Nevertheless, some observations can be made. Comparison of the contours without vertical exaggeration, as shown for January 2009 (Figure 4-6) and June 2009 (Figure 4-9), suggests there are two common “shapes” observed in the contours. The contours for the January data are generally smooth, with lines that steadily steepen toward the groundwater table. In comparison, the contours for the June data show a stepped shape, with steep lines in approximately the 3- to 6-foot bgs range, and slightly flatter lines below. Review of all the profile diagrams in Appendix F suggests that the smooth shaped contours correspond to the wetter months of January, February, and March, while the stepped contours correspond to drier months of November and May through August. December and April may be transitional between the two patterns.

The stepped shape indicates that shallow, relatively high concentrations are extending to the east, effectively creating a shallow zone of anomalously high concentrations relative to the smooth contour profiles. This suggests that there is a shallow zone of relatively high mass transfer (higher rate of diffusion) out from under the slab and toward the unpaved area. Nothing was observed in the transect data that readily explains why there might be this variability in the rate of diffusion, but it is likely a result of factors outside the plane of the transect. It is also not readily apparent what the relationship to seasons (i.e., dry versus wet months) might be, particularly considering that the paving extends hundreds or more feet to the north and west of the sampling transect, which should limit any effects of precipitation on the underlying soils.

The variability in TCE concentrations measured in micro-purge probes was generally greater than in the macro-purge probes, and the variability was similar in under-slab probes versus probes from uncovered areas. Over the 12-month study period, micro-purge concentrations under the slab varied by factors of 3 to 35, while for the probes in the uncovered area the variability ranged from a factor of 2 to 30. It is suspected that the variability observed in micro-purge samples is in-part due to difficulties in the purging and sampling process. This is discussed further in Section 4.2.3.

4.2.3 Macro-Purge versus Micro-Purge Sampling

Paired macro-purge and micro-purge soil vapor samples were collected over the course of the 12-month study. When collecting paired samples, the micro-purge sample was always collected first, followed by the collocated macro-purge sample. The rationale was that the volume of soil gas removed from the micro-purge probes was trivial (less than 10 mL) in relation to the volume removed from the macro-purge probes (~30 to 60 mL); therefore, it was assumed that purging and sampling the micro-purge probes was unlikely to effect the results obtained from the macro-purge probes, whereas the reverse might not be true.

The percent difference between paired micro-purge and macro-purge samples ranged from 200 to -133 percent and the factors between paired concentrations (i.e., the higher concentration divided by the lower) ranged from 1 to 2,368 (Table 4-7). However, excluding two outlier results from ST-1 at 7 and 10 feet bgs in November 2008, the differences ranged from 186 to -133 percent and the factors ranged from 1 to 27. The micro-purge probes at 7 and 10 feet bgs at location ST-1 were found to be damaged in November 2008, and were replaced in December 2008; therefore, it is reasonable to exclude these two outliers from the November data set.

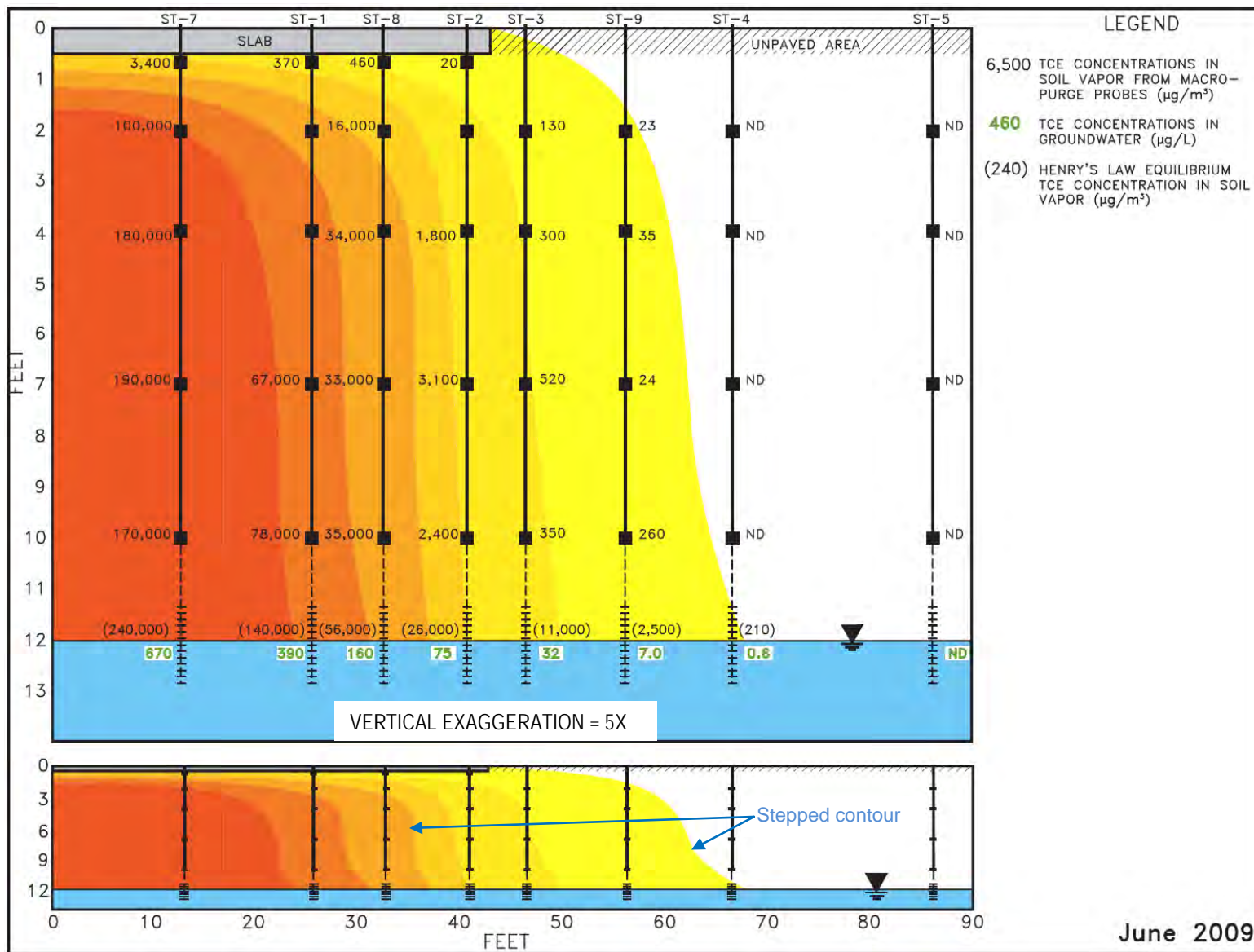

Figure 4-9 Schematic Isoconcentration Contours (June 2009 macro-purge data)

To assess the comparability of the two sampling methodologies, the paired results (excluding non-detect results and the two November 2008 outliers at ST-1 from 7 and 10 feet bgs) were plotted in X-Y space (Figure 4-10). It can be seen by visual inspection that the correlation between measurement types is poor, and that generally, the micro-purge probes yielded lower concentrations than the corresponding macro-purge probes. Statistical analyses were performed to quantitatively evaluate the correlation between the paired data points and to determine whether sub-dividing the data based on a variety of criteria would yield a better correlation. The data were evaluated by depth, by location, and by month. Plots of these sub-divisions of the data set are presented in Appendix G.

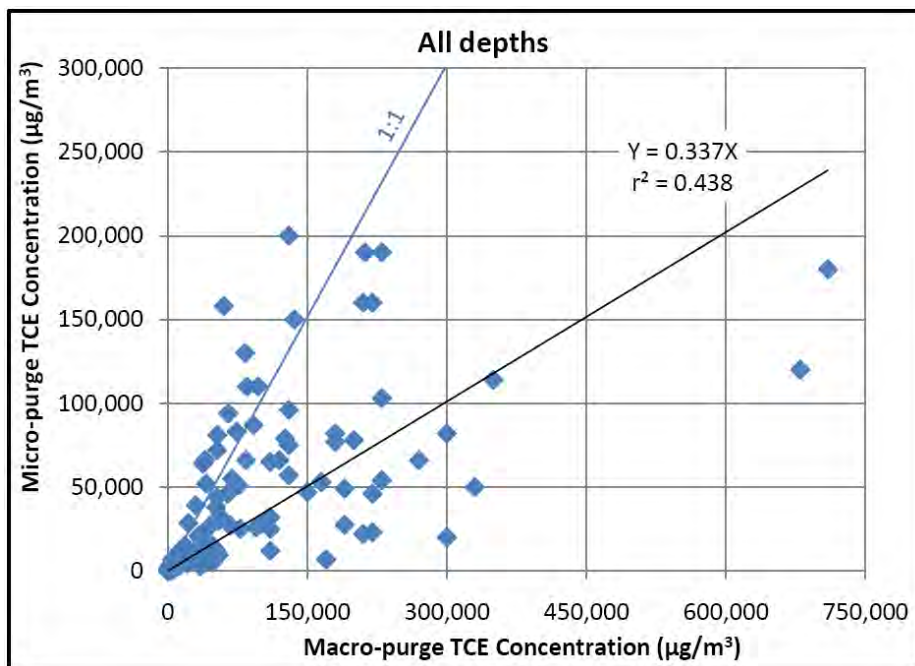

Figure 4-10 Plot of Micro-Purge versus Macro-Purge TCE Concentrations

Table 4-8 lists the coefficient of determination, the fitted regression coefficients **a** and **b** for the linear regression curve $Y = a + bX$, and the lower and upper 95% confidence limits for the fitted regression coefficients **a** and **b**. The term **X** refers to the macro-purge result and **Y** refers to the micro-purge result.

**Table 4-8
Statistical Parameters for Regression Curve $Y = a + bX$**

Depth (feet bgs)	r^2	Fitted a	Lower a	Upper a	Fitted b	Lower b	Upper b
2	0.784	923	-2,650	4,500	0.547	0.452	0.643
4	0.637	4,970	-9,040	18,900	0.698	0.532	0.864
7	0.626	8,260	-143	16,700	0.310	0.246	0.374
10	0.533	5,680	-245	11,600	0.194	0.148	0.239
All depths	0.473	8,830	4,060	13,600	0.298	0.254	0.341

Notes:

- bgs – below ground surface
- r^2 – coefficient of determination
- X – macro-purge TCE concentrations
- Y – micro-purge TCE concentrations

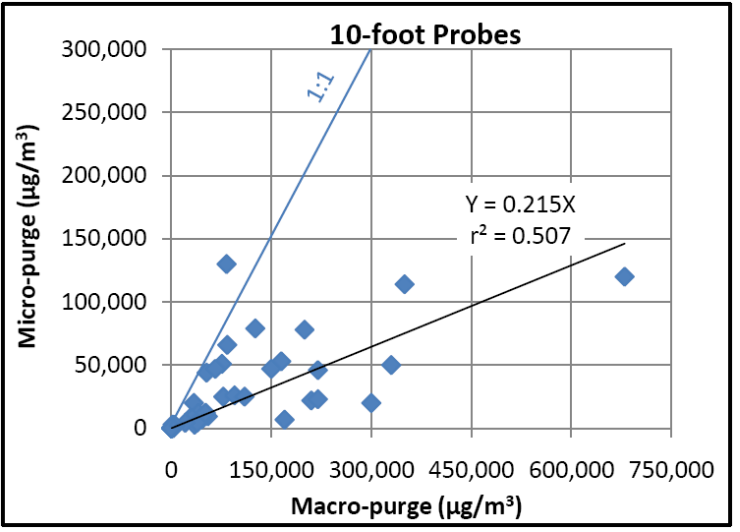
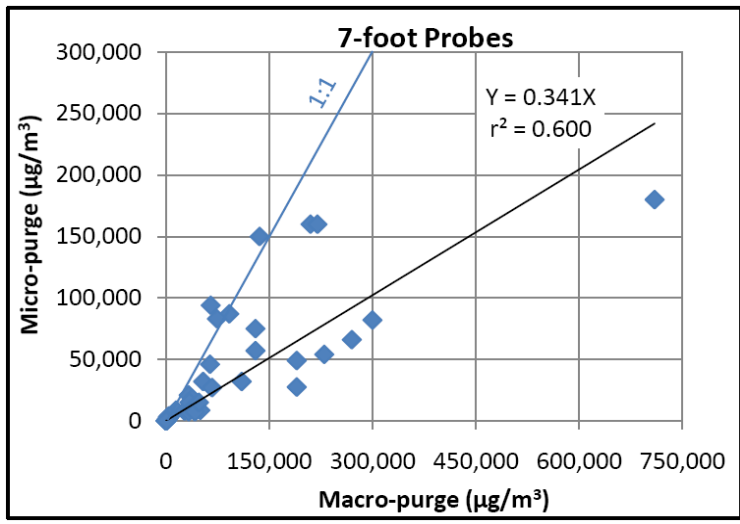
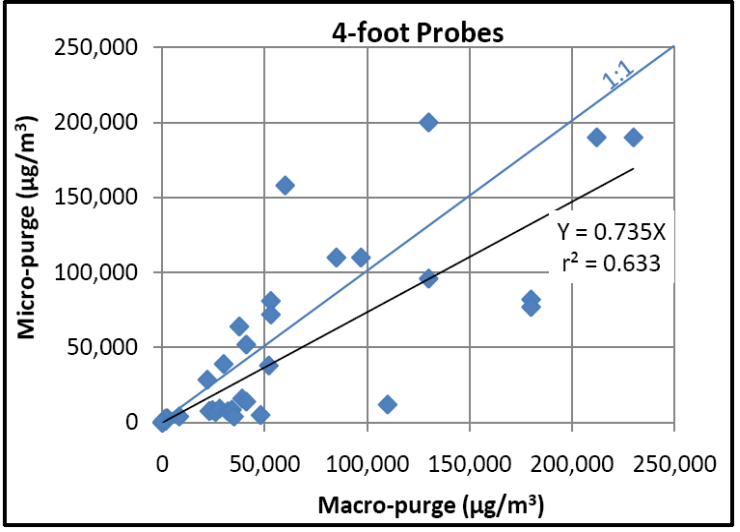
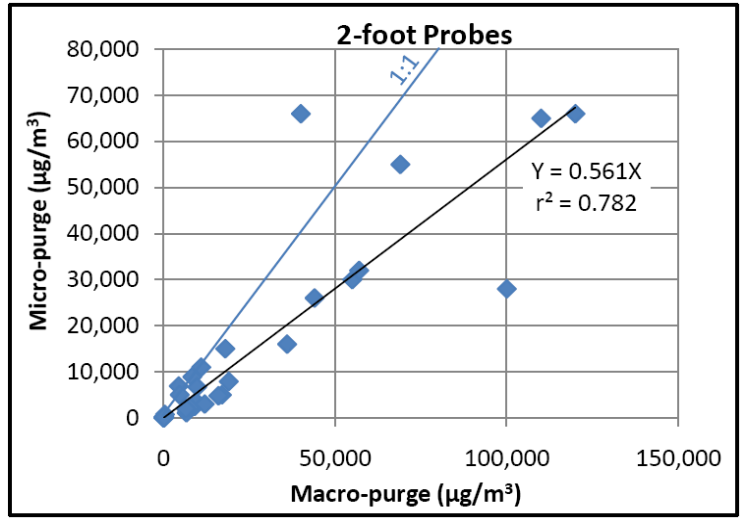

Figure 4-11 Plots of Micro-Purge versus Macro-Purge TCE Concentrations by Depth

It is clear that the r^2 of the linear regression models decrease with depth, with the worst correlation occurring when all of the data are modeled with one expression (Table 4-8, Figure 4-11). Note that the 95% lower confidence limit for coefficient **a** is negative valued and the 95% upper confidence limit is positive valued when fitting individual depth division data. This indicates that coefficient **a** can be zero valued and; hence, can be eliminated from the regression equation without significant loss of accuracy.

Table 4-9 lists the coefficient of determination, the fitted regression coefficient **b** for the curve **Y = bX** (i.e. **a** forced to zero), and the lower and upper 95% confidence limits for the fitted regression coefficient **b**.

Table 4-9
Statistical Parameters for Regression Curve Y = bX

Depth (feet bgs)	r^2	Fitted b	Lower b	Upper b
2	0.782	0.561	0.462	0.640
4	0.633	0.735	0.607	0.863
7	0.600	0.341	0.263	0.398
10	0.507	0.215	0.175	0.255
All depths	0.438	0.337	0.298	0.376

Notes:

- bgs – below ground surface
- r^2 – coefficient of determination
- X – macro-purge TCE concentrations
- Y – micro-purge TCE concentrations

A comparison between the r^2 of the corresponding **Y = a+bX** (Table 4-8) and **Y = bX** (Table 4-9) regressions clearly indicates that no significant loss of accuracy occurs by dropping coefficient **a**.

The paired micro-purge and macro-purge probes were installed at the same depths but due to drilling equipment constraints are separated laterally by approximately 1 foot. Therefore, the differences observed between paired micro-purge and macro-purge sample results could be attributable in part to heterogeneities in actual soil gas concentrations over short distances in the subsurface. However, the consistent low bias in the micro-purge data when compared to the macro-purge suggests other factors are more important.

It is suspected that a significant portion of the discrepancy between the micro-purge and macro-purge sample results is due to challenges in sample collection using the micro-purge technique. The very narrow bore (0.01-inch) of the micro-purge tubing results in significant resistance to flow during purging, which leads to a vacuum in the sampling train. The vacuum created during sampling may result in ambient air leaking into the samples which would dilute the TCE and lead to erratic results. This conclusion is supported by the observation that the comparability between results (i.e. the coefficient of determination, r^2) decreases with increasing depth (Table 4-8, Figure 4-11). The deeper probes have longer tubing lengths through which the samples must be drawn, and the longer tubing lengths result in increased resistance to flow, which results in a greater vacuum during sampling and increased probability of ambient air leaking into the samples.

4.2.4 Sampling Parameters Study

The data from the purge rate, purge volume, and sample volume experiments are detailed in Appendix B. The range in TCE concentrations across the probes used for the sampling parameters study spanned two orders of magnitude; therefore, two concentration scales (vertical axes) are shown on each of the plots in Figures 4-12 through 4-14. On each plot, both vertical axes show measured TCE concentrations in $\mu\text{g}/\text{m}^3$, with the left axis for relatively high concentrations and the right axis for low concentrations.

4.2.4.1 Purge Rate Experiment

Changing the rate of purging from 100 to 4,000 mL/min had little if any effect on the measured TCE concentrations (Figure 4-12). The probe with the highest concentrations, ST1-7, showed some irregular variability; however, this was likely due to errors introduced during dilutions. The other four probes showed no significant change in concentration.

The vacuum induced by purging was monitored for purge rates above 200 mL/min. The maximum induced vacuum was measured at 6 inches of mercury, which is within the allowable range commonly cited in guidance documents (e.g., DTSC 2003, ITRC 2007). The silts and clays at NAS Lemoore Site 14 have relatively low permeability (Table 2-2); nevertheless, it is possible that at sites with lower permeability soils, high purge rates could result in higher induced vacuums which could affect the measured VOC concentrations. Also, probe construction techniques that do not use sand filter packs, such as post-run tubing, might also result in higher vacuum at high purge rates because use of a filter pack increases the surface area of native soils from which vapors can be drawn.

4.2.4.2 Purge Volume Experiment

The measured TCE concentrations generally show a nominal increase in concentrations from 1 to 10 purge volumes; however, the variability is generally within analytical error (Figure 4-13). For one probe, ST2-7, concentrations decreased from 1 to 3 purge volumes before rising again after 6 and 10 purge volumes. Overall, purge volume did not appear to have a significant effect on measured TCE concentrations.

4.2.4.3 Sample Volume Experiment

TCE concentrations showed irregular variability with sample volumes ranging from 10 to 1,000 mL (Figure 4-14). The only consistent trend observed was that the lowest concentration measured at each probe was associated with the 6,000 mL sample, suggesting that 6-liter Summa canisters may not be the best option for soil gas sampling.

4.2.4.4 Summary of Sampling Parameters Study

Overall, the results of this study suggests that purge rate, purge volume, and sample volume have little to no significant effect on measured VOC concentrations in soil gas samples. The only consistent trend observed amongst all three experiments was that the 6,000-mL samples consistently yielded the lowest concentrations from the sample volume experiment.

These findings are consistent with the results from experiments conducted at Vandenberg AFB in a dune sand environment (EPA 2007). At the Vandenberg site, purge rate and purge volume were also found to have little to no significant effect on TCE concentrations. Sample volume was also found to have little significant effect; however, similar to this study, samples collected in 6-liter Summa canisters generally yielded lower concentrations than smaller volume samples.

The results of this study corroborate the similar findings obtained from the study conducted at Vandenberg AFB (EPA 2007). Together, these studies indicate that for soil types ranging from the highly permeable dune sands at Vandenberg AFB to the relatively low permeability soils at NAS Lemoore IRP Site 14, the sampling parameters purge rate and purge volume have no significant effect on measured VOC concentrations in soil gas samples. The study results further indicate that sample volume has no significant effect up to approximately 1-liter. However, 6-liter samples consistently yielded somewhat lower concentrations suggesting that 6-liter Summa canisters may not be appropriate for soil gas sampling.

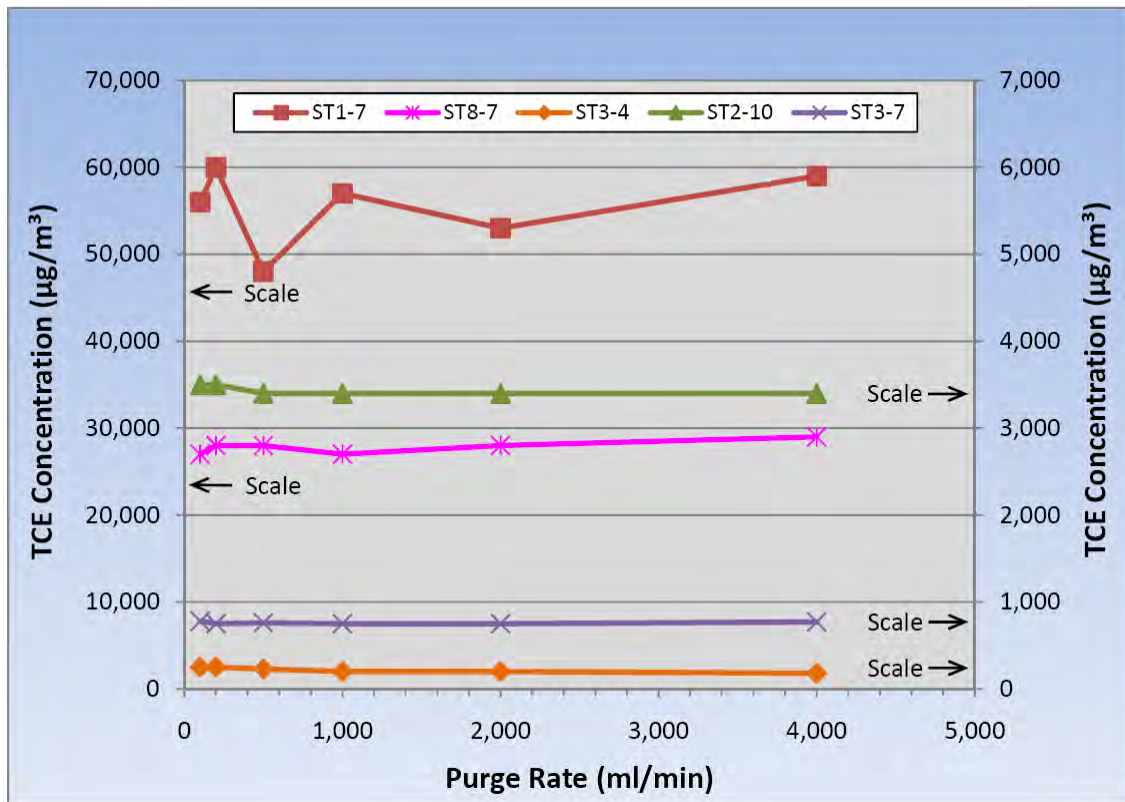

Figure 4-12 Linear Plot of Purge Rate Experiment Data

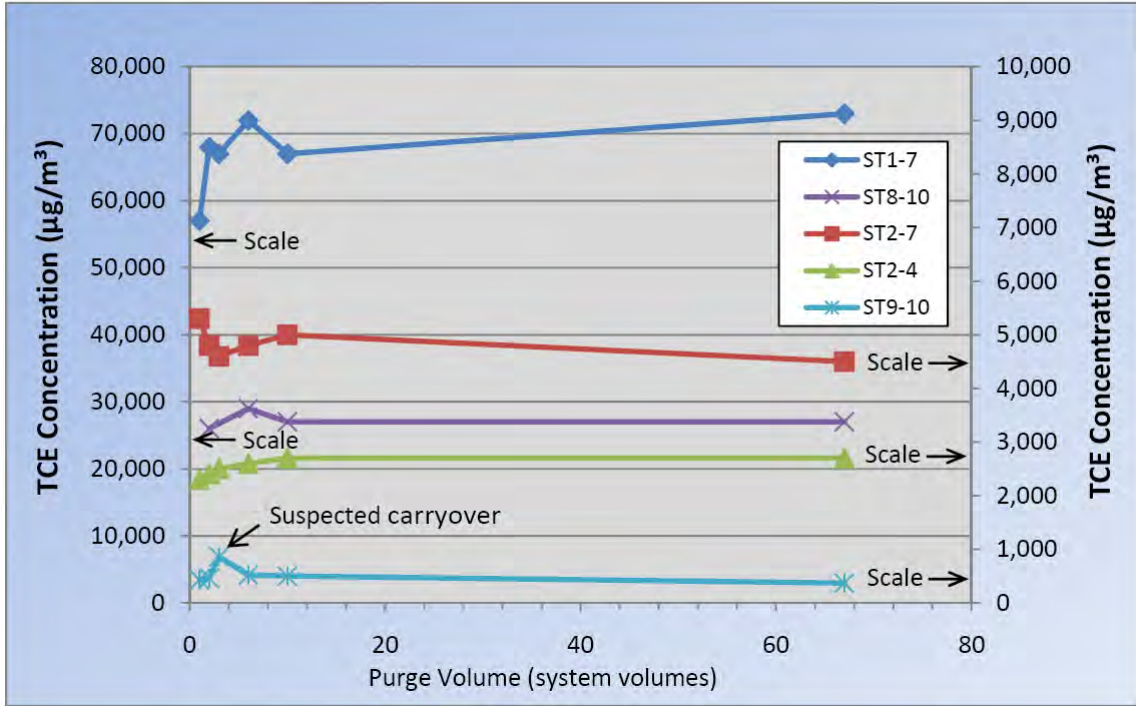

Figure 4-13 Linear Plot of Purge Volume Experiment Data

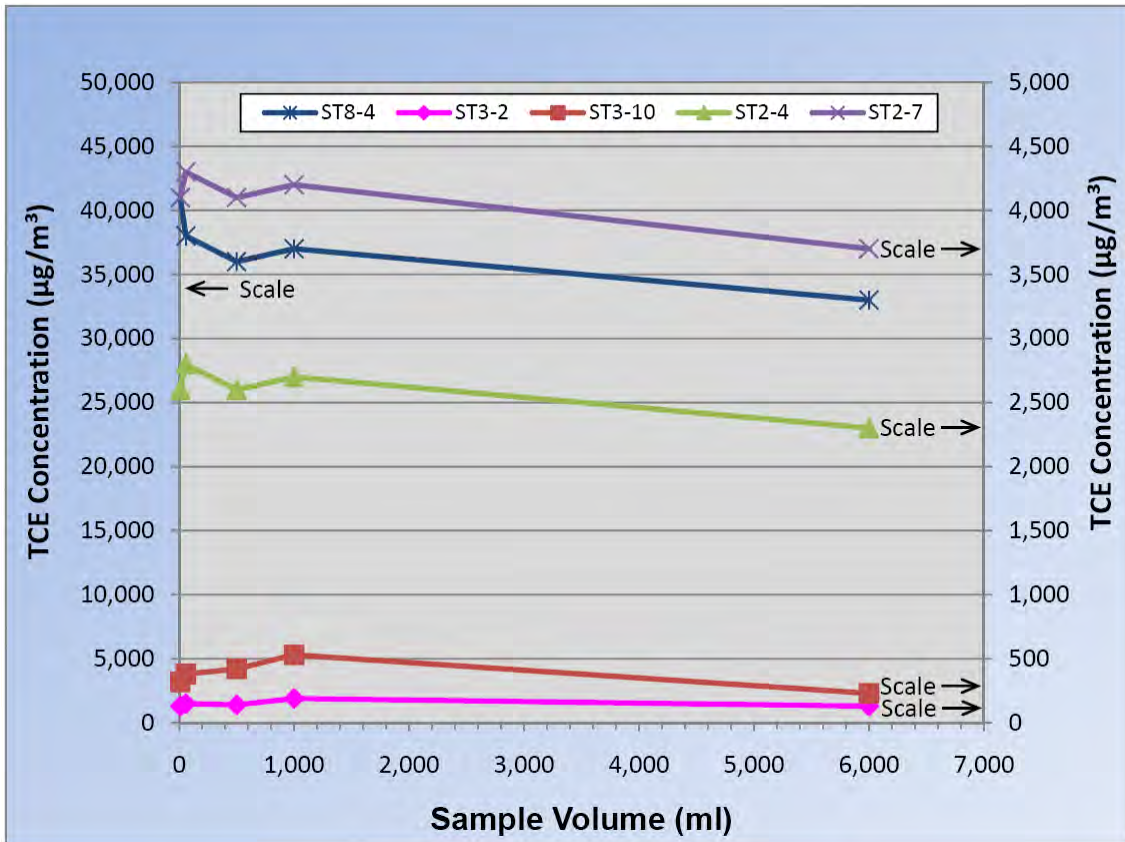

Figure 4-14 Linear Plot of Sample Volume Experiment Data

5.0 CONCLUSIONS

The two primary objectives of this investigation were to: (1) measure the distribution of VOCs in the vadose zone and shallow groundwater in order to improve understanding of the mechanisms of vapor migration and intrusion and (2) monitor temporal trends in the VOC distribution over the course of a year. Secondary objectives included comparison of sampling results obtained from industry standard vapor probe implants (referred to here as “macro-purge” probes) and a new “micro-purge” methodology, and assessment of the effect of sampling parameters (i.e., purge rate, purge volume, and sample volume) on measured soil vapor concentrations. Conclusions relating to each of these objectives are listed under separate headings below.

Distribution of VOCs in the Vadose Zone and Shallow Groundwater

At the NAS Lemoore study site, the following observations were made with respect to the distribution of VOCs in the shallow subsurface environment:

- Vapor concentrations decrease with increasing distance from the groundwater source and also decrease moving laterally out from under the slab. Thus, there are vertical and horizontal concentration gradients that drive VOC mass up toward the slab and the uncovered ground and also laterally out from under the slab. These observations are consistent with basic physical principles of diffusive mass-transfer.
- Equilibrium concentrations of TCE in soil vapor calculated from the groundwater concentrations using the Henry’s constant were similar to the measured 10-foot bgs vapor concentrations under the slab, but were approximately an order of magnitude higher than the measured concentrations in the uncovered area. This indicates that the concentration gradient across the groundwater-vapor interface is much greater in the uncovered area than under the slab.
- TCE concentrations in the top 1 to 2 feet of the groundwater column decrease along the transect from west to east. The rate of decrease (i.e., the decrease in concentration as a percentage per foot) generally increases toward the east.

These observations indicate that the near-slab environment is in a steady state, or dynamic equilibrium, governed by diffusive mass transfer. Beneath the slab, vapor- and aqueous-phase VOC concentrations are approximately in equilibrium and the rate-limiting step governing mass transfer is the movement of vapors laterally out from under the slab so that they can escape to the atmosphere. In the uncovered area, the rate-limiting step is the transfer of VOC mass out of groundwater and into the vapor phase. Once in the vapor phase, the VOCs diffuse relatively quickly toward the ground surface. Since the rate of diffusive mass transfer is much slower in the aqueous phase than in vapor, this process may lead to depletion of VOCs in the shallow groundwater beneath uncovered areas. Thus, the presence or absence of a slab may impact VOC concentrations not only the vapor phase but also the shallow groundwater.

Further research is warranted to evaluate whether the near-slab vapor profile observed at NAS Lemoore IRP Site 14 is typical. In particular, an important question is whether a similar vapor profile would develop at a site with different soil types. At NAS Lemoore IRP Site 14, the vadose zone soils are primarily low permeability silts and clays. A site with relatively high permeability sandy soils might develop a different vapor profile due to differences in rates of diffusion in the different soil types as compared to NAS Lemoore IRP Site 14.

Temporal Trends in VOC Distribution

- Groundwater concentrations were relatively stable throughout the study period varying by a factor of 3 or less (factor of 2 or less for the higher concentration wells). A modest spike in groundwater concentrations was observed in the June through August sampling data. Given the overall weather patterns observed at Lemoore NAS (i.e., relatively cool weather in December through March with above average rainfall and hot, dry weather for the rest of the year), it does not appear that the observed spike in concentrations, which occurred in the middle of the dry summer months, is a seasonal effect.
- Soil vapor concentrations under the slab generally varied by a factor of less than 4.
- Soil vapor concentrations in the uncovered area were much more variable, with the difference between the maximum and minimum concentrations varying by a factor of 4 to 30.
- Overall, soil vapor TCE concentrations increased during the study period throughout the study area.
- The variability in soil vapor concentrations was not strongly linked to changes in groundwater concentrations.

Schematic isoconcentration contour profiles, presented in Appendix F, suggest there may be two general shapes to the contours: smooth contours observed during January through March and stepped contours observed in May through August. While the profiles are schematic drawings only, they suggest a slightly different distribution of TCE in the soil vapor during the wet months as compared to the rest of the year. An explanation for these differences is not readily apparent; however, the shape of the contours suggests that during the drier months, there is an increased rate of lateral diffusion toward the east in the shallow (~3 to 6 feet bgs) vadose zone.

Overall, these observations indicate that VOC concentrations under the slab, both in groundwater and soil vapor, were fairly stable and further sampling rounds would not yield a significant improvement in the characterization of this site. Vapor concentrations in the uncovered area were more variable and multiple monitoring rounds may be warranted to fully characterize subsurface conditions there.

Macro-purge versus Micro-Purge

- Comparison of the TCE soil vapor concentrations from the micro-purge and macro-purge probes showed a poor correlation between the two sampling methodologies.
- The micro-purge data generally exhibited a low bias relative to the corresponding macro-purge data.
- The discrepancy observed between micro-purge and macro-purge soil vapor concentrations may in part be due to heterogeneities in *in-situ* concentrations over short distances, but is likely largely due to difficulties in obtaining representative samples using the micro-purge probes due to the very small tubing diameter.

Effect of Sampling Parameters on Soil Vapor Concentrations

- For a wide range of soil types, from high-permeability dune sands to low permeability silts and clays, the sampling parameters purge rate and purge volume have no significant effect on measured VOC concentrations in soil gas samples.
- Sample volume has no significant effect up to about 1-liter. However, 6-liter samples yielded somewhat lower concentrations suggesting that 6-liter Summa canisters may not be appropriate for soil gas sampling.

6.0 RECOMMENDATIONS

This study provides important insights into the behavior of VOCs in the vadose zone and shallow groundwater, but also raises additional questions. The following are recommendations for further research.

- After 2 years of study, the near slab environment at the NAS Lemoore IRP site 14 is well characterized. The most pressing question is whether the findings from this site are generally applicable to other sites or if this site is unique. Similar studies at other sites, particularly sites with different vadose zone soil types, would shed light on the broad applicability of the findings. As an interim measure, some insight might be gained by conducting a careful review of existing data for sites where vapor sampling has been conducted in the near-slab environment.
- Discrete depth groundwater sampling at the NAS Lemoore IRP site 14 would provide data on potential vertical stratification of VOCs in groundwater to support or refute the premise that VOC mass transfer out of the vadose zone in the uncovered area is affecting shallow groundwater concentrations.
- Further evaluation of the micro-purge sampling technique is warranted to understand the weak correlation between macro-purge and micro-purge vapor sampling results. As discussed, it is suspected that the ability to obtain representative samples using the micro-purge technique may be impacted by the resistance to flow through the 0.01-inch diameter tubing, which has the effect of creating a vacuum in the sampling train during purging and might lead to leaks of ambient air into the samples. This issue might be resolved by using tubing with a somewhat larger internal diameter.

7.0 REFERENCES

Abreu and Johnson

2005 *Effect of Vapor Source-Building Separation and Building Construction on Soil Vapor Intrusion as Studied with a Three-Dimensional Numerical Model*. Environmental Science and Technology. Volume 39, No. 12. Pages 4,550-4,561.

California Environmental Protection Agency (Cal/EPA) Department of Toxic Substances Control (DTSC)

2003 *Advisory Active Soil Gas Investigations*. January.

Interstate Technology & Regulatory Council (ITRC)

2007 *Vapor Intrusion Pathway: A Practical Guideline*. January

Tetra Tech EM, Inc. (Tetra Tech)

2008a *Quality Assurance Project Plan, for the Investigation of the Vertical Distribution of VOCs in Soils From Groundwater to the Surface/Subslab*. January.

Tetra Tech EM, Inc. (Tetra Tech)

2008b *Quality Assurance Project Plan Addendum, for the Investigation of the Vertical Distribution of VOCs in Soils From Groundwater to the Surface/Subslab*. October.

U.S. Environmental Protection Agency (EPA)

2007 *Final Project Report for Development of Active Soil Gas Sampling Method*. Office of Research and Development, National Exposure Research Laboratory, Las Vegas, Nevada. EPA/600/R-07/076.

U.S. Environmental Protection Agency (EPA)

2009 *Vertical Distribution of VOCs in Soils from Groundwater to the Surface/Subslab*. Office of Research and Development, National Exposure Research Laboratory, Las Vegas, NV. EPA/600/R-09/073.

Appendix A
Sampling Trip Report

SAMPLING TRIP REPORT

for

Temporal Variation of VOCs in Soils from Groundwater to the Surface/Subslab

Prepared by:

**Tetra Tech EM Inc.
1230 Columbia Street
Suite 1000
San Diego, CA 92101**

**EPA Contract #EP-C-05-061
Task Order No. 85**

February 2010

Prepared for:

**Brian A. Schumacher, Task Order Project Officer
National Exposure Research Laboratory
Office of Research and Development
U.S. Environmental Protection Agency
Las Vegas, NV 89114**



1.0 INTRODUCTION

This Trip Report provides a summary of the sampling activities that were conducted between October 20, 2008 and October 14, 2009 at Naval Air Station (NAS) Lemoore Installation Restoration Program (IRP) Site 14. The sampling was conducted on behalf of the U.S. Environmental Protection Agency (EPA), Office of Research and Development, in support of the project titled *Temporal Variation of VOCs in Soils from Groundwater to the Surface/Subslab*, conducted under EPA Contract Number EP-C-05-061, Task Order Number 85 (TO 85).

NAS Lemoore is located in the California Central Valley, approximately 40 miles south of Fresno and 180 miles northwest of Los Angeles. IRP Site 14 is located in the operations area of NAS Lemoore and consists of maintenance buildings, hangars, and aircraft parking areas (Figure 1).

The primary contracted project field team included environmental consultants from Tetra Tech (John Felts, Matt Houlahan, Joachim Eberharter, and James Elliot) and H&P Mobile Geochemistry (Blayne Hartman, Tom Scherbart, Janis Villarreal, Kurt Schindler, and Amilcar Sanchez). In addition to contractor personnel, the project field team included the EPA Task Order Project Officer (Brian Schumacher) and EPA scientist (John Zimmerman). Mr. Frank Nielson, from the NAS Lemoore IRP office, provided logistical support and was often on-site.

The field investigation for TO 85 was completed over 13 mobilizations. Geophysical clearance for groundwater monitoring well and additional soil vapor probe locations was conducted on October 20, 2008 by Precision Locating. Concrete coring for monitoring wells and probe locations on the concrete slab was conducted on October 20, 2008 by Penhall Company (Penhall). Drilling and groundwater monitoring well installation was conducted on October 21 and 22 by H&P Mobile Geochemistry (HPMG). Soil gas probes were installed by HPMG at new locations ST-7, ST-8, and ST-9, on October 22. Monthly groundwater and soil vapor sampling was conducted over the next 12 months from November 12, 2008 through October 14, 2009.

2.0 GROUNDWATER WELL AND VAPOR PROBE INSTALLATION

Soil vapor probe installation, soil sampling, and groundwater well installation was conducted in accordance with the procedures detailed in the QAPP (Tetra Tech 2008a, c).

On October 21, 2008, groundwater monitoring wells were installed at locations ST-1, ST-4, ST-5, ST-7, and ST-9, and on October 22 groundwater wells were installed at locations ST-2, ST-3, and ST-8 (Figure 2, Table 1). Also on October 22, soil vapor probes were installed at 2, 4, 7, and 10 feet bgs at locations ST-7, ST-8, and ST-9 and subslab at locations ST-7 and ST-8. Soil samples were collected from 2, 4, 7, and 10 feet bgs at locations ST-7, ST-8, and ST-9.

For this investigation, groundwater monitoring wells were installed immediately adjacent to vapor probe locations ST-1 through ST-5 and ST-7 through ST-9. The wells were installed in boreholes drilled approximately 2 feet below the water table using a direct-push drill rig. Groundwater was encountered at a depth of approximately 12 to 13 feet bgs at each location. The wells were constructed using 0.75-inch diameter polyvinylchloride (PVC) well casing and screen. The screen and casing was placed in the open borehole so that approximately 1 foot of well screen was above the water table and 2 feet were below. Clean #2/12 sand was then poured down the annular space to form a filter pack to approximately 1 foot above the well screen. The wells were sealed to the surface with hydrated bentonite and completed at the surface in flush-mount, traffic rated well boxes. The relatively short (i.e. 3 feet long) well screens were used in order to obtain groundwater samples that are representative of the conditions near the top of the

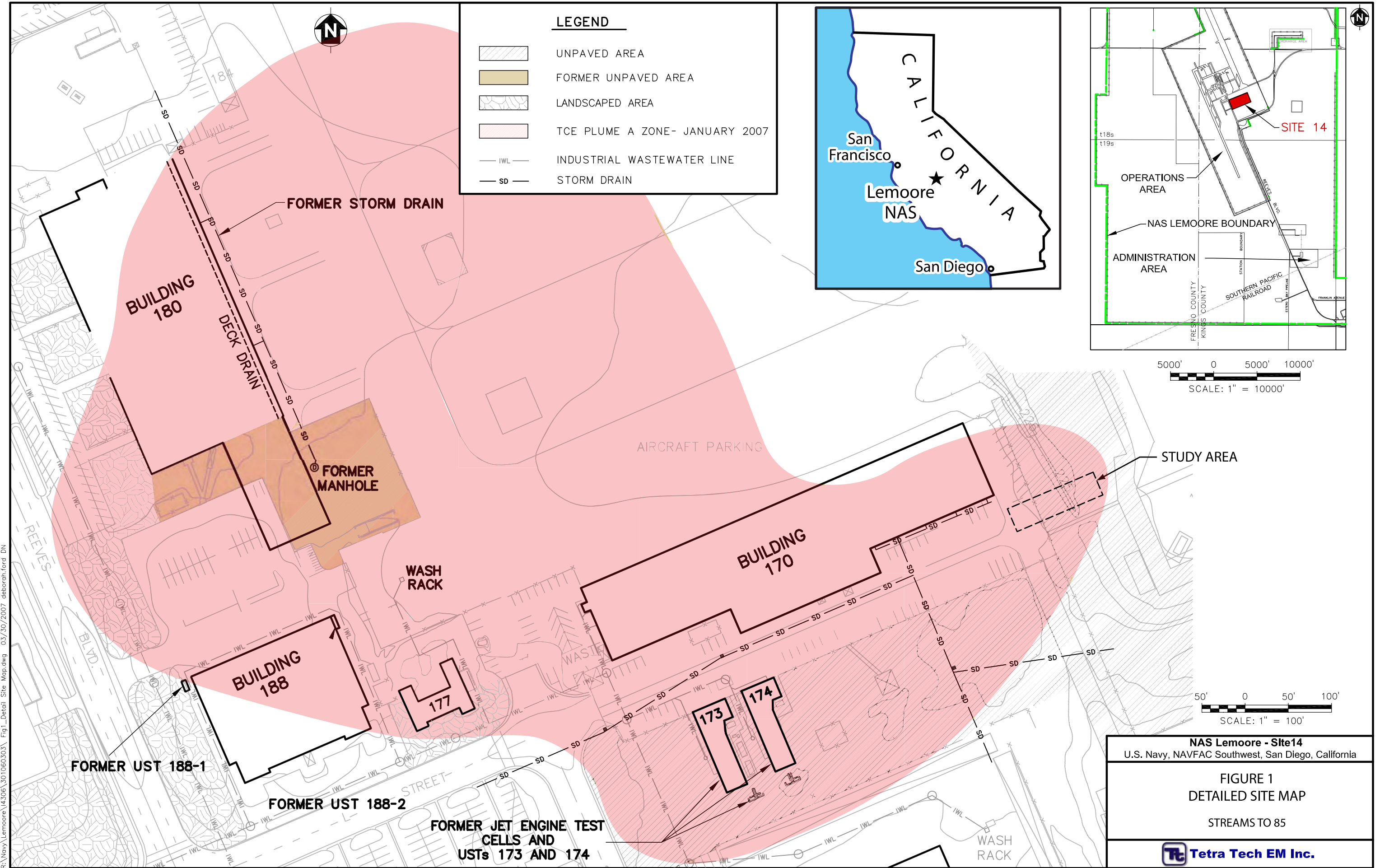

RA:\Naval\Lemoore\14306\301060303\Fig1_Detail_Site_Map.dwg 03/30/2007 deborah.ford DN





NAS Lemoore - Site 14
 U.S. Navy, NAVFAC Southwest, San Diego, California

FIGURE 1
 DETAILED SITE MAP

STREAMS TO 85

Tetra Tech EM Inc.

LEGEND

- NT-5  SOIL VAPOR PROBE LOCATION (NOT USED FOR THIS STUDY)
- ST-4  SOIL VAPOR PROBE WITH COLLOCATED GROUNDWATER WELL
-  EXISTING GROUNDWATER WELL
- X— FENCE LINE
-  UNPAVED AREA

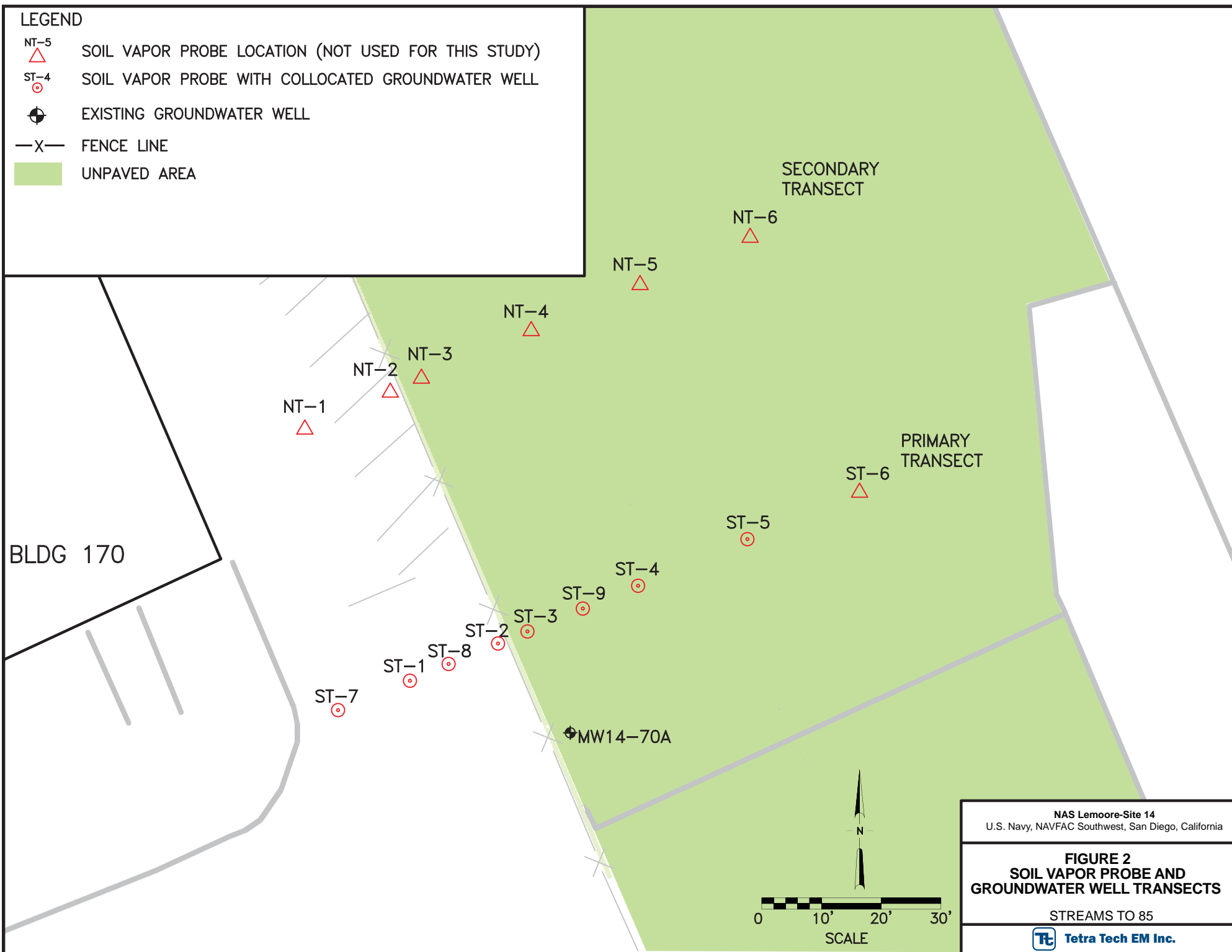

NAS Lemoore-Site 14
U.S. Navy, NAVFAC Southwest, San Diego, California

FIGURE 2
SOIL VAPOR PROBE AND
GROUNDWATER WELL TRANSECTS

STREAMS TO 85

 Tetra Tech EM Inc.

water column, at the groundwater-vadose zone interface. The monitoring wells were identified by the location ID appended with “MW” to indicate a monitoring well.

Table 1
Groundwater Sample Summary

Location	Well ID	Total Depth (feet bgs)	Installation Date
ST-1	ST1-MW	14.0	10/21/08
ST-2	ST2-MW	13.5	10/22/08
ST-3	ST3-MW	13.7	10/22/08
ST-4	ST4-MW	12.8	10/21/08
ST-5	ST5-MW	12.6	10/21/08
ST-7	ST7-MW	14.2	10/21/08
ST-8	ST8-MW	14.1	10/22/08
ST-9	ST9-MW	13.3	10/21/08

The vapor probes were installed in pilot holes advanced to 10 feet bgs using a direct push rig. Soils encountered in the pilot holes consisted primarily of silty sands, clayey sands, and clays. Soil samples were collected at the vapor probe depths of 2, 4, 7, and 10 feet bgs in each of the three pilot holes drilled on October 22 (ST-7 through ST-9).

Soil vapor probes were constructed as follows. Approximately 3 inches of #2/12 sand was poured into the bottom of the pilot holes. A 1-inch long gas-permeable probe tip attached to 1/8-inch diameter Nylaflow tubing was then lowered through the drill rod to the top of the sand. Additional sand was poured around the sampling probe until it extended approximately 2 inches above the probe to form an approximately 6-inch long sand pack around the sample point. Approximately 12 inches of dry bentonite was then placed on top of the sand pack, followed by hydrated bentonite to approximately 3 inches below the next sampling depth (i.e. 7 feet bgs). This process was repeated to install four nested soil vapor probes in each pilot hole, at depths of 2, 4, 7, and 10 feet bgs. At locations on the concrete pad, the subslab vapor probes were installed in the same way, but in a separate, 1-inch diameter hole that was drilled through the concrete with an electric hammer drill. The sampling probes were completed at the surface with approximately 18 inches of Nylaflow tubing extending out of the ground and a luer valve fitted to the end of the tubing. A schematic diagram of the probe installations is provided in Figure 3.

The individual probes were identified by the location ID and the depth separated by a dash (e.g., the probe installed at 4 feet bgs at location ST-1 is designated ST1-4). The subslab probes were identified with the location ID and “SS” (e.g. ST1-SS). Table 2 provides a summary of the probe installation details.

Concurrently with the installation of the above vapor probes, which are referred to as “macro-purge” vapor probes, EPA installed “micro-purge” vapor probes. Micro-purge vapor probes were collocated with the macro-purge vapor wells at locations ST-1 through ST-4, and ST-7 through ST-9 at depths of 2, 4, 7, and 10 feet bgs. Subslab micro-purge vapor wells were not installed. The micro-purge vapor probes consisted of 0.01-inch inner diameter (ID) stainless steel tubing epoxied into steel point holders. The stainless steel tubing was threaded through the drill-rods, which were driven to the target sampling depth using the EPA-operated direct-push rig. Upon reaching the target depth, the drill rod was pulled up approximately 1 inch to expose the drop-off point to the vadose zone. The drill rods were left in place during sampling in order to seal out ambient air; thus micro-purge probes at multiple depths were installed in separate boreholes, rather than being nested in a single boring.

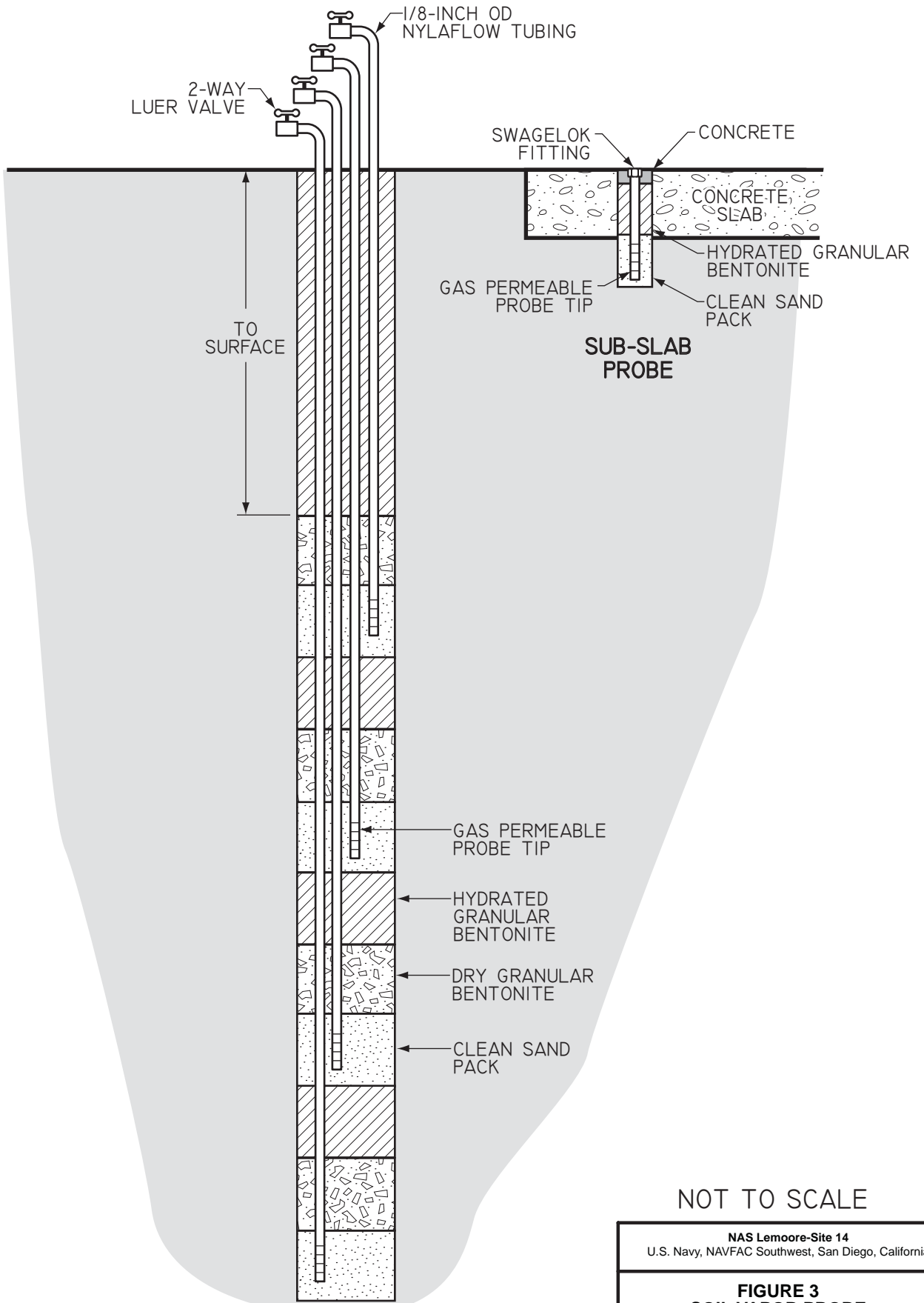

NESTED SOIL-GAS PROBES

NOT TO SCALE

NAS Lemoore-Site 14
U.S. Navy, NAVFAC Southwest, San Diego, California

FIGURE 3
SOIL VAPOR PROBE
CONSTRUCTION SCHEMATIC

STREAMS TO 85

A summary of the probe installation details is provided in Table 2, along with the geographic coordinates for each location. It was determined in July 2009 that a malfunction in the GPS receiver had resulted in incorrect coordinates being reported for probe locations ST-1 through ST-6 and NT-1 and NT-6 in the TO 65 Trip Report (Tetra Tech 2008b); therefore, Table 2 below includes the corrected coordinates for all probes installed under the STREAMS program at NAS Lemoore.

Table 2
Soil Vapor Probe Installation Details and Coordinates

Location ID	Macro Probe ID	Installation Date	Probe Depth (feet bgs)	Coordinates (Easting)	Coordinates (Northing)
ST-1	ST1-SS	February 11, 2008	Sub-Slab	6283734.19	2002852.99
	ST1-2		2		
	ST1-4		4		
	ST1-7		7		
	ST1-10		10		
ST-2	ST2-SS	February 11, 2008	Sub-Slab	6283748.25	2002859.41
	ST2-2		2		
	ST2-4		4		
	ST2-7		7		
	ST2-10		10		
ST-3	ST3-2	January 18, 2008	2	6283753.98	2002860.26
	ST3-4		4		
	ST3-7		7		
	ST3-10		10		
ST-4	ST4-2	January 22, 2008	2	6283771.04	2002870.24
	ST4-4		4		
	ST4-7		7		
	ST4-10		10		
ST-5	ST5-2	January 22, 2008	2	6283789.04	2002878.29
	ST5-4		4		
	ST5-7		7		
	ST5-10		10		
ST-6	ST6-2	January 18, 2008	2	6283807.32	2002885.52
	ST6-4		4		
	ST6-7		7		
	ST6-10		10		
ST-7	ST7-SS	October 22, 2008	Sub-Slab	6283723.72	2002848.69
	ST7-2		2		
	ST7-4		4		
	ST7-7		7		
	ST7-10		10		

Table 2 (cont.)

Location ID	Macro Probe ID	Installation Date	Probe Depth (feet bgs)	Coordinates (Easting)	Coordinates (Northing)
ST-8	ST8-SS	October 22, 2008	Sub-Slab	6283739.86	2002857.26
	ST8-2		2		
	ST8-4		4		
	ST8-7		7		
	ST8-10		10		
ST-9	ST9-2	October 22, 2008	2	6283761.65	2002866.30
	ST9-4		4		
	ST9-7		7		
	ST9-10		10		
NT-1	NT1-SS	February 12, 2008	Sub-Slab	6283718.98	2002883.21
	NT1-2		2		
	NT1-4		4		
	NT1-7		7		
	NT1-10		10		
NT-2	NT2-SS	February 12, 2008	Sub-Slab	6283733.55	2002890.65
	NT2-2		2		
	NT2-4		4		
	NT2-7		7		
	NT2-10		10		
NT-3	NT3-2	January 22, 2008	2	6283736.84	2002892.46
	NT3-4		4		
	NT3-7		7		
	NT3-10		10		
NT-4	NT4-2	January 18, 2008	2	6283757.85	2002902.04
	NT4-4		4		
	NT4-7		7		
	NT4-10		10		
NT-5	NT5-2	February 12, 2008	2	6283773.38	2002910.10
	NT5-4		4		
	NT5-7		7		
	NT5-10		10		
NT-6	NT6-2	February 12, 2008	2	6283791.38	2002917.53
	NT6-4		4		
	NT6-7		7		
	NT6-10		10		

Notes:

bgs below ground surface

3.0 SOIL GAS AND GROUNDWATER SAMPLING AND ANALYSES

Once installation was completed in October 2008, monthly groundwater and soil gas sampling began in November 2008 and was finished in October 2009. Groundwater sampling was conducted by purging

each well dry, from least contaminated to most contaminated, and allowing the well to recharge with groundwater. During the first two rounds of sampling, equilibrium purging of the groundwater wells was attempted; however, the recharge rate was too slow and the wells consistently purged dry. While purging, groundwater temperature, electrical conductivity, pH, dissolved oxygen, and oxidation reduction potential were measured using YSI instrument and turbidity was measured using a Hach Turbidity meter. Groundwater samples were collected using disposable polyethylene bailers and submitted to the HPMG fixed laboratory in Carlsbad, California for volatile organic compound (VOC) analysis via EPA method SW8260B. Unless otherwise specified every groundwater well was sampled during each monthly round in the following order ST5-MW, ST4-MW, ST9-MW, ST3-MW, ST2-MW, ST8-MW, ST1-MW, and ST7-MW.

Soil gas samples were analyzed in an on-site mobile laboratory operated by HPMG. Macro-purge soil gas probes were purged using disposable 60-ml polypropylene syringes attached to 3-way luer valves and samples were collected in glass syringes after purging. Three system volumes were purged from each macro-purge probe followed by collection of a 20-ml sample. System volumes for macro-purge probes were calculated as 6, 11, 17, 26, and 35 ml.

Micro-purge soil gas probes were purged and sampled using glass syringes provided by EPA. Three system volumes were purged from each micro-purge probe followed by collection of a 2.5-ml sample. System volumes for the micro-purge probes were estimated to be 2.0, 2.1, 2.1, and 2.2 ml for the 2-, 4-, 7-, and 10-foot deep probes, respectively. Dilution was used at location ST-7, ST-1, and ST-8 due to high concentrations. Unless otherwise specified every micro-purge and macro-purge probe was sampled during each monthly round.

3.1 November 2008 Sampling Round

The week of November 12, 2008 marked the first round of sampling of the new groundwater monitoring wells and soil gas probes. After arriving on site the team setup on location ST-5 to begin purging each of the groundwater wells. A peristaltic pump was used to purge the wells. Specific tubing lengths were cut for each well depending on their total depth. These well-specific tubing lengths were used each month to purge the wells.

On November 12 wells ST5-MW, ST4-MW, ST9-MW, and ST3-MW were purged dry. Due to the limited volume of water in each well, only a single YSI and turbidity meter reading could be recorded for each well. After all the wells had been purged dry they were allowed to recharge and then sampled. At the end of the day Blayne Hartman arrived on site to set up the mobile laboratory and gas chromatograph (GC).

On November 13, groundwater wells ST1-MW, ST2-MW, ST7-MW, and ST8-MW were purged dry and sampled upon recharge. Vapor sampling was started in the afternoon after the GC instrument was set up and calibrated. Macro-purge soil gas sampling was completed for all probes except ST1-SS, ST2-SS, and ST3-2. These probes were plugged and needed to be reinstalled.

On November 14, micro-purge vapor samples were collected from all locations and the plugged probes identified the previous day were reinstalled. The stainless steel tubing in micro-purge probe ST1-MP-7 was found to be loose and in need of replacement. By the end of the day, all the macro-purge and micro-purge soil vapor probes had been sampled.

3.2 December 2008 Sampling Round

On December 15, 2008 each of the groundwater monitoring wells were purged dry and sampled following the procedures outlined at the beginning of this section. One YSI and turbidity reading was recorded for each location.

Vapor sampling began on December 16 at location ST-7, but was quickly halted due to rain. Vapor sampling was completed on December 17. The following micro-purge probes developed a vacuum during purging: ST7-MP-10, ST5-MP-4, ST5-MP-7, ST4-MP-7, and ST4-MP-10. These probes were successfully sampled by using an extremely slow purge rate. Micro-purge probes ST1-MP-7 and ST-MP-10 were not sampled because the stainless steel tubing was found to be loose and the probes needed to be replaced.

Penhall was mobilized to the site to core additional holes in the concrete slab so that the loose micro-purge probes could be replaced and to provide additional core holes for future probe installations. Penhall cored three holes at ST-1, one hole at ST-8, and one hole at ST-2.

Following completion of the regular monthly sampling round, the auto-sampler system was set up and launched. Table 3 lists the probes that were incorporated into the auto-sampler system.

Table 3
Auto-sampler Configuration

Auto-sampler Port	Soil Gas Probe	Notes
1	Cal Gas	
2	ST8-SS	
3	ST8-2	Outside air after January 20
4	ST8-4	
5	ST8-7	
6	Outside air	
7	ST3-7	
8	ST3-4	
9	ST3-2	
10	ST9-7	
11	ST9-4	
12	ST9-2	
13	ST2-SS	
14	ST2-2	
15	ST2-4	
16	ST2-7	

On December 22 and 23, EPA removed the micro-purge probes at ST-5 and replaced probes ST1-MP-7 and ST1-MP-10

3.3 January 2009 Sampling Round

On January 19, 2009 each of the groundwater monitoring wells were purged dry and sampled following the procedure outlined at the beginning of this section. One YSI and turbidity reading was recorded for each well. By the end of the day, each of the groundwater wells was sampled, progressing from the least to the most contaminated.

The following day, January 20, vapor probe sampling was performed at all locations. The sub-slab probe at ST-2 was found to be clogged, so it was replaced with a new probe installed adjacent to the original.

In early January, the auto-sampler was malfunctioning due to a problem with the purge pump and due to water being drawn into the system from probe ST8-2. After the regular sampling round was completed, the purge pump was replaced and probe ST8-2 was disconnected from the system (Table 3). In addition, the new ST2-SS probe was incorporated in the auto-sampler at Port 13.

3.4 February 2009 Sampling Round

On February 17, 2009 each of the groundwater monitoring wells were purged dry and sampled following the procedure outlined at the beginning of this section. One YSI and turbidity reading were recorded for each location.

The auto-sampler was shut off on the morning of February 18 and the regular monthly vapor sampling was conducted. All of the probes were successfully sampled. After completion of the monthly sampling round, the auto-sampler was restarted.

3.5 March 2009 Sampling Round

On March 16, 2009 each of the groundwater monitoring wells were purged dry and sampled following the procedure outlined at the beginning of this section. One YSI and turbidity reading were recorded for each location.

The auto-sampler was shut off and the regular monthly vapor sampling was started on March 17. The probes at locations ST-5, ST-4, ST-9, ST-3, ST-2, and ST-8 at all depths were sampled. The remaining soil vapor probes were sampled on March 18. It was determined that micro-purge probe ST7-MP-10 had a loose fitting septa that needed to be replaced.

3.6 April 2009 Sampling Round

Vapor probe sampling was conducted on April 22. A slight vacuum was noticed at ST3-MP-4 as well as ST8-2. Micro-purge probe ST1-MP-2 was found to be clogged and water was observed in the syringe during purging; therefore, this probe was not sampled. In addition, macro-purge probe ST2-2 was found to be clogged and no sample was taken.

Groundwater samples were collected on April 23. Each of the groundwater monitoring wells was purged dry and sampled following the procedure outlined at the beginning of this section. One YSI and turbidity reading was recorded for each well.

3.7 May 2009 Sampling Round

On May 18, 2009 each of the groundwater monitoring wells were purged dry and sampled following the procedure outlined at the beginning of this section. One YSI and turbidity reading was recorded for each well. The regular monthly vapor sampling round was also conducted on May 18. During vapor probe sampling it was noted that there were strong vacuums in probes ST2-MP-7, ST8-2, and ST1-4, and that probes ST1-2, ST2-2, ST1-MP-2, and ST1-MP-7 were all clogged.

During May 19 and 20, experiments were conducted to evaluate the effect of purge rate, purge volume, and sample volume on soil vapor results. The experiments were conducted similarly to the experiments conducted at Vandenberg AFB under STREAMS TO 05 (EPA 2007).

3.8 June 2009 Sampling Round

On June 15, 2009 each of the groundwater monitoring wells were purged dry and sampled following the procedure outlined at the beginning of this section. One YSI and turbidity reading was recorded for each well.

Vapor sampling was conducted on June 16. During vapor sampling it was noted that probes ST1-2, ST1-4, ST2-2, and ST3-MP-4 were clogged, and that ST1-MP-2 still draws water. With the exception of these five probes, all of the vapor probes were successfully sampled.

Geophysical utility clearance for the equilibration study scheduled for July was conducted on June 17. Doug Young from Precision Locating conducted the work and cleared four separate proposed locations for the study. The four locations were on the unpaved ground, immediately adjacent to the concrete slab. The locations were marked with spray paint so that they could be easily identified in July.

3.9 July 2009 Sampling Round

During the week of July 13, 2009, groundwater and vapor sampling was completed as usual and a study of probe equilibration time was conducted under STREAMS TO-65. The equilibration study consisted of installing several new locations of nested macro-purge and micro-purge soil gas probes and sampling the probes periodically until the measured TCE concentrations stabilized. The purpose of the study was to determine the time required for newly installed soil gas probes to stabilize. The study lasted the whole week and ran in conjunction with the regularly scheduled groundwater monitoring well and soil vapor probe sampling.

The equilibration study consisted of intensive sampling of the newly installed probes over the first three days (July 13 through 15), which resulted in the GC instrument being operating at capacity; therefore, only equilibration study samples were collected and analyzed during this time period.

By July 16, the rate of sampling necessary for the equilibration study had decreased and so the regular monthly vapor sampling round was conducted. A number of probes were found to be clogged during the July round: ST1-2, ST1-4, ST1-7, ST2-2, ST2-4, ST5-4, ST7-2, and ST1-MP-2. In addition, EPA removed the micro-purge probes at location ST-4; therefore, starting with the July round, no micro-purge samples were collected from this location.

The following day, July 17, each of the groundwater monitoring wells was purged dry and sampled following the procedure outlined at the beginning of this section. One YSI and turbidity reading was recorded for each location.

The equilibrium study was concluded at the end of the day on July 17.

3.10 August 2009 Sampling Round

On August 11, 2009 each of the groundwater monitoring wells were purged dry and sampled following the procedure outlined at the beginning of this section. One YSI and turbidity reading were recorded for each location. After purging, ST4-GW and ST5-GW did not recharge with enough water to allow sampling. These two wells were allowed to recharge through the following day and still did not contain sufficient water; therefore, no groundwater samples were collected from ST4-GW and ST5-GW during the August round.

Vapor sampling was conducted on August 12. Macro-purge probes ST1-2, ST1-4, ST1-7, ST1-10, ST2-2, ST2-4, ST4-2, ST4-4, ST5-4, ST7-SS, and ST7-2 and micro-purge probes ST1-MP-2 and ST3-MP-4 were found to be clogged and were not sampled. All of the other probes were successfully sampled.

3.11 September 2009 Sampling Round

On September 15, 2009 each of the groundwater monitoring wells were purged dry and sampled following the procedure outlined at the beginning of this section. One YSI and turbidity reading were recorded for each location. Vapor sampling was also started on September 15 while waiting for the groundwater wells to recharge.

Vapor sampling was completed on September 16. Macro-purge probes ST1-2, ST1-4, ST1-7, ST1-10, ST2-2, ST2-4, ST2-7, ST3-4, ST3-7, ST7-SS, ST7-2, and ST7-4 and micro-purge probes ST1-MP-2 and ST3-MP-4 were found to be clogged and were not sampled. Probes ST4-2, ST4-4, and ST5-4, which were clogged during the August sampling round were found to purge adequately in September and were sampled.

3.12 October 2009 Sampling Round

On October 13, 2009 each of the groundwater monitoring wells were purged dry and sampled following the procedure outlined at the beginning of this section. One YSI and turbidity reading were recorded for each location.

Soil gas sampling was conducted on October 14. Macro-purge probes ST1-2, ST1-4, ST1-7, ST1-10, ST2-2, ST2-4, ST2-7, ST3-4, ST3-7, ST4-2, ST4-7, ST5-4, ST5-7, ST7-SS, ST7-2, ST7-4, and ST8-SS and micro-purge probes ST1-MP-2, ST3-MP-4, and ST9-MP-4 were found to be clogged and were not sampled. All of the other probes were successfully sampled.

4.0 FIELD QUALITY CONTROL

A sub-set of the soil vapor sampling probes were leak checked during the TO 65 investigation by placing a cloth rag in a plastic bag, saturating the rag with 1,1-difluoroethane (DFA), placing the bag over the surface completion of the probe, and then purging the probe normally and collecting a sample. None of the probes failed the leak test; since all probes were installed using the same procedures, it was assumed that all probes were sufficiently sealed.

Field duplicate vapor samples were collected to measure the reproducibility and precision of the total sampling system. Field duplicate samples were collected at a rate of approximately 9 percent. Of the 67 field duplicate vapor samples collected during the program, only seven exceeded the Quality Assurance Project Plan (QAPP) (Tetra Tech 2008a, c) specified criterion of ± 40 relative percent difference (RPD).

A total of 94 groundwater samples plus 10 duplicates were collected over the 12 sampling rounds. All of the RPD results for the duplicates were within the QAPP specified criterion of ± 40 RPD.

One field duplicate soil sample was analyzed for the set of 12 field samples analyzed. The only analyte detected in the soil samples was TCE. The RPD between the primary and duplicate sample TCE concentrations was 22, well within the QAPP criterion of ± 40 .

5.0 HEALTH AND SAFETY

Each field team member was required to sign a form acknowledging they had received and understood the site-specific health and safety plan. Each day of field work began with a Tailgate Health and Safety meeting followed by equipment checking and preparation. The daily health and safety meetings were conducted by the Tetra Tech site supervisor and covered site-specific health and safety concerns including physical, chemical, and biological hazards.

There were no accidents or other health and safety incidents during the field program.

6.0 REFERENCES

Tetra Tech EM, Inc. (Tetra Tech)

2008a Quality Assurance Project Plan, for the Investigation of the Vertical Distribution of VOCs in Soils From Groundwater to the Surface/Subslab. January.

Tetra Tech EM, Inc. (Tetra Tech)

2008b Sampling Trip Report, Vertical Distribution of VOCs in Soils from Ground Water to the Surface/Subslab. May

Tetra Tech EM, Inc. (Tetra Tech)

2008c Quality Assurance Project Plan Addendum, for the Investigation of the Vertical Distribution of VOCs in Soils From Groundwater to the Surface/Subslab. October.

U.S. Environmental Protection Agency (EPA). 2007. *Final Project Report for the Development of an Active Soil Gas Sampling Method*. Office of Research and Development, National Exposure Research Laboratory, Las Vegas, NV. EPA/600/R-07/076.

Appendix B

Purging Parameters Study

APPENDIX B

Evaluation of the Effect of Sampling Parameters on VOC Concentrations in Soil Vapor Samples

Prepared by:

**Tetra Tech EM Inc.
1230 Columbia Street
Suite 1000
San Diego, CA 92101**

**EPA Contract #EP-C-05-061
Task Order No. 85**

July 2010

Prepared for:

**Dr. Brian A. Schumacher, Task Order Project Officer
National Exposure Research Laboratory
Office of Research and Development
U.S. Environmental Protection Agency
Las Vegas, NV 89119**



CONTENTS

<u>Section</u>	<u>Page</u>
1.0 INTRODUCTION	B-1
2.0 METHODOLOGY	B-1
3.0 RESULTS AND DISCUSSION	B-2
4.0 SUMMARY	B-3
5.0 CONCLUSION	B-3
6.0 REFERENCES	B-9

Figures

B-1 Detailed Site Map, IRP Site 14, NAS Lemoore, California.....	B-7
B-2 Groundwater Contours, A Zone, January 2007	B-7
B-3 Trichloroethene Plume in the A Zone Aquifer, January 2007	B-8

Tables

B-1 Macro-Purge Soil Gas Probe Installation Details	B-2
B-2 Purge Rate Experiment Sample Summary	B-4
B-3 Purge Volume Experiment Sample Summary	B-5
B-4 Sample Volume Experiment Sample Summary.....	B-6

1.0 INTRODUCTION

In May 2009, Tetra Tech conducted experiments to evaluate the effect of purge rate, purge volume, and sample volume (referred to here as the principal parameters) on measured volatile organic compound (VOC) concentrations in soil gas samples. Similar experiments were conducted in October 2006 at Installation Restoration Program (IRP) Site 15 on Vandenberg Air Force Base (AFB). The results of the Vandenberg AFB study are reported in *Final Project Report for Development of Active Soil Gas Sampling Method* (U.S. EPA 2007). The vadose zone at the Vandenberg AFB study site consisted of homogeneous, highly permeable dune sands. The objective of the study at NAS Lemoore IRP Site 14 was to repeat the experiments in relatively heterogeneous and low permeability silts and clays to evaluate whether soil type would affect the findings.

2.0 METHODOLOGY

The experiments were conducted using a sub-set of the existing, south transect, macro-purge soil vapor probes. Probes were selected to provide a range of baseline trichloroethene (TCE) concentrations (i.e. the concentrations previously measured at a given probe) and a range of probe depths (i.e. tubing lengths). The probes used for this study were constructed in the same way as those used for the Vandenberg AFB study with the exception that at NAS Lemoore the Nylaflo tubing used was 1/8-inch diameter, while at Vandenberg AFB 1/4-inch tubing was used.

The overall approach was to collect multiple samples from the same vapor probe while varying one of the principal parameters and holding the others at a constant setting, referred to as the baseline setting. The baseline settings were chosen to be consistent with the experiments conducted at Vandenberg AFB and industry standard sampling procedures. The baseline principal parameter settings were as follows:

- Purge Rate: 200 milliliters per minute (ml/min)
- Purge Volume: 3 system volumes
- Sample Volume: 20 milliliters (ml)

A system volume was considered the volume of the 1/8-inch Nylaflo tubing plus the volume of the probe. The tubing volume was estimated as 1 ml per foot of tubing. Calculated system volumes for each probe are shown in Table B-1.

The principal parameter settings were varied as follows:

- Purge Rate: 100 milliliters to 4,000 ml/min
- Purge Volume: 1 to 67 system volumes
- Sample Volume: 10 to 6,000 ml

For purge rates of 200 ml/minute or less, probes were purged using a 60-ml syringe equipped with a three-way valve. For purge rates of 500 ml/min and higher, a portable electric pump was used. Samples up to 60-ml were collected in glass syringes. Samples greater than 60 and up to 1,000 ml were collected in Tedlar bags. The 6,000-ml samples were collected in 6-liter Summa canisters.

Table B-1
Macro-Purge Soil Gas Probe Installation Details

Location ID	Probe ID	Installation Date	Easting	Northing	Probe Depth (feet bgs)	Length of Sandpack (inches)	System Volume (ml)
ST-1	ST1-7	February 11, 2008	6283734.19	2002852.99	7	6	9
ST-2	ST2-4	February 11, 2008	6283748.25	2002859.41	4	6	6
	ST2-7				7	6	9
	ST2-10				10	6	12
ST-3	ST3-2	January 18, 2008	6283753.98	2002860.26	2	6	4
	ST3-4				4	6	6
	ST3-7				7	6	9
	ST3-10				10	6	12
ST-8	ST8-4	October 22, 2008	6283739.86	2002857.26	4	6	6
	ST8-7				7	6	9
	ST8-10				10	6	12
ST-9	ST9-10	October 22, 2008	6283761.65	2002866.30	10	6	12

Definitions:

bgs - below ground surface
ml - milliliters

All of the samples were analyzed on-site in the H&P Mobile Geochemistry (HPMG) laboratory using EPA method SW8021. The analyses were performed following EPA method 8000 protocols, modified for soil gas. The instrument used was an SRI 8610 gas chromatograph equipped with a photoionization detector (PID) and an electron capture detector (ECD). The detection level was 5 micrograms per cubic meter ($\mu\text{g}/\text{m}^3$). Samples collected in glass syringes were directly injected into the analytical instrument. Samples collected in Tedlar bags and Summa canisters were sub-sampled with a syringe and injected.

3.0 RESULTS AND DISCUSSION

The experimental data for the purge rate, purge volume, and sample volume experiments are summarized on Tables B-2, B-3, and B-4 respectively, and linear plots are presented on Figures B-1, B-2, and B-3. As shown on the tables, there was a two order of magnitude range in TCE concentrations across the probes; therefore, two concentrations scales (vertical axes) are shown on each of the plots in Figures B-1 through B-3. On each plot, both vertical axes show measured TCE concentrations in $\mu\text{g}/\text{m}^3$, with the left axis for relatively high concentrations and the right axis for low concentrations.

Purge Rate Experiment

The TCE concentrations observed during the purge rate experiment are summarized in Table B-2 and linear plots of the purge rate experiment data are shown in Figure B-1. It is clear from these data presentations that purge rate had little if any effect on the measured TCE concentrations. The probe with the highest concentrations, ST1-7, showed some irregular variability; however, this was likely due to errors introduced during dilutions. The other four probes showed no significant change in concentration.

The vacuum induced by purging was monitored for purge rates above 200 ml/min (Table B-2). The maximum induced vacuum was 6 inches of mercury, which is within the allowable range commonly cited in guidance (e.g., DTSC 2003, ITRC 2007). At other sites with lower permeability soils, it is possible that high purge rates could result in higher induced vacuums, which could affect the resulting measured VOC concentrations.

Purge Volume Experiment

The TCE concentrations observed during the purge volume experiment are summarized in Table B-3 and linear plots of the purge volume experiment data are shown in Figure B-2. The measured TCE concentrations generally show a nominal increase in concentrations from 1 to 10 purge volumes; however, the variability is generally within analytical error. Furthermore, for one probe (ST2-7), concentrations decreased from 1 to 3 purge volumes before rising again after 6 and 10 purge volumes. Overall, purge volume did not appear to have a significant effect on measured TCE concentrations.

Sample Volume Experiment

The TCE concentrations observed during the sample volume experiment are summarized in Table B-4 and linear plots of the sample volume experiment data are shown in Figure B-3. TCE concentrations showed irregular variability with sample volumes ranging from 10 to 1,000 ml. The only consistent trend observed was that the lowest concentration measured at each probe was associated with the 6,000 ml sample, suggesting that 6-liter Summa canisters may not be the best option for soil gas sampling.

4.0 SUMMARY

Overall, the results of this study suggests that purge rate, purge volume, and sample volume have little to no significant effect on measured VOC concentrations in soil gas samples. The only consistent trend observed amongst all three experiments was that the 6,000-ml samples consistently yielded the lowest concentrations.

These findings are consistent with the results from the experiments conducted at Vandenberg AFB in a dune sand environment (EPA 2007). At the Vandenberg site, purge rate and purge volume were also found to have little to no significant effect on TCE concentrations. Sample volume was also found to have little significant effect; however, similarly to this study, samples collected in 6-liter Summa canisters generally yielded lower concentrations than smaller volume samples.

5.0 CONCLUSION

The results of this study corroborate the similar findings obtained from the study conducted at Vandenberg AFB. Together, these studies indicate that For soil types ranging from the highly permeable dune sands at Vandenberg AFB to the relatively low permeability soils at NAS Lemoore Site 14,, the sampling parameters purge rate and purge volume have no significant effect on measured VOC concentrations in soil gas samples. The study results further indicate that sample volume has no significant effect up to approximately 1-liter; however, 6-liter samples consistently yielded somewhat lower concentrations, suggesting that 6-liter Summa canisters may not be appropriate for soil gas sampling.

Table B-2
Purge Rate Experiment Sample Summary

Location	Sample ID	Purge Rate (ml/min)	Sample Time	TCE ($\mu\text{g}/\text{m}^3$)	Vacuum (inHg)	Purge Method	Notes
ST3-4	ST3-4-PR100	100	13:47	250	NA	Syringe	
	ST3-4-PR200	200	14:12	250	NA	Syringe	
	ST3-4-PR500	500	14:42	230	1	Syringe	
	ST3-4-PR1000	1000	15:15	200	1	Pump	
	ST3-4-PR2000	2000	15:39	200	1.5	Pump	
	ST3-4-PR4000	4000	16:29	180	2.5	Pump	10 second purge
	ST3-4-PR4000	4000	16:33	117	2.5	Pump	90 second purge
		Average		218			
		StDev		26.7			
	%RSD		12.2%				
ST1-7	ST1-7-PR100	100	14:02	56000	NA	Syringe	
	ST1-7-PR200	200	14:24	60000	NA	Syringe	
	ST1-7-PR500	500	15:02	48000	1	Syringe	
	ST1-7-PR1000	1000	15:33	57000	2	Pump	
	ST1-7-PR2000	2000	16:01	53000	3.5	Pump	
	ST1-7-PR4000	4000	16:55	59000	5.5	Pump	10 second purge
	ST1-7-PR4000	4000	16:59	53000	5.5	Pump	90 second purge
		Average		55143			
		StDev		3833.3			
	%RSD		7.0%				
ST2-10	ST2-10-PR100	100	13:43	3500	NA	Syringe	
	ST2-10-PR200	200	14:08	3500	NA	Syringe	
	ST2-10-PR500	500	14:53	3400	1	Syringe	
	ST2-10-PR1000	1000	15:23	3400	2	Pump	
	ST2-10-PR2000	2000	15:51	3400	3	Pump	
	ST2-10-PR4000	4000	16:45	3400	6	Pump	
		Average		3433		Pump	
		StDev		47.1			
	%RSD		1.4%				
ST3-7	ST3-7-PR100	100	13:51	780	NA	Syringe	
	ST3-7-PR200	200	14:16	750	NA	Syringe	
	ST3-7-PR500	500	14:48	760	1	Syringe	
	ST3-7-PR1000	1000	15:19	750	1.5	Pump	
	ST3-7-PR2000	2000	15:44	750	2	Pump	
	ST3-7-PR4000	4000	16:41	770	4	Pump	
		Average		760			
		StDev		11.5			
	%RSD		1.5%				
ST8-7	ST8-7-PR100	100	13:57	27000	NA	Syringe	
	ST8-7-PR200	200	14:20	28000	NA	Syringe	
	ST8-7-PR500	500	14:57	28000	1	Syringe	
	ST8-7-PR1000	1000	15:27	27000	1.5	Pump	
	ST8-7-PR2000	2000	15:57	28000	2.5	Pump	
	ST8-7-PR4000	4000	16:49	29000	2	Pump	
		Average		27833			
		StDev		687.2			
	%RSD		2.5%				

Definitions

inHg - inches of mercury
 $(\mu\text{g}/\text{m}^3)$ - micrograms per cubic meter
ml/min - milliliters per minute
NA - not applicable
%RSD - percent relative standard deviation
StDev - standard deviation

Notes:

Purge volume was set at 3 system volumes
Sample volume was set at 20 ml
Samples collected 19 May 2009

Table B-3
Purge Volume Experiment Sample Summary

Location	Sample ID	Purge Volume (system volumes)	Purge Volume (ml)	Sample Time	TCE ($\mu\text{g}/\text{m}^3$)	Notes
ST1-7	ST1-7-PV1	1	8	10:08	57000	
	ST1-7-PV2	2	16	10:13	68000	
	ST1-7-PV3	3	24	10:19	67000	
	ST1-7-PV6	6	48	10:23	72000	
	ST1-7-PV10	10	80	10:28	67000	
	ST1-7-PV67	67	500	10:43	73000	
				Average	67333	
				StDev	5185	
			%RSD	7.7%		
ST2-7	ST2-7-PV1	1	8	10:51	5300	
	ST2-7-PV2	2	16	10:57	4800	
	ST2-7-PV3	3	24	11:02	4600	
	ST2-7-PV6	6	48	11:06	4800	
	ST2-7-PV10	10	80	11:10	5000	
	ST2-7-PV67	67	500	11:15	4500	
				Average	4833	
				StDev	262	
			%RSD	5.4%		
ST2-4	ST2-4-PV1	1	5	11:37	2300	
	ST2-4-PV2	2	10	11:42	2400	
	ST2-4-PV3	3	15	11:46	2500	
	ST2-4-PV6	6	30	11:50	2600	
	ST2-4-PV10	10	50	11:55	2700	
	ST2-4-PV67	67	500	11:59	2700	
				Average	2533	
				StDev	149	
			%RSD	5.9%		
ST8-10	ST8-10-PV1	1	11	12:12	-	Exceeded calibration range
	ST8-10-PV2	2	22	12:17	26000	
	ST8-10-PV3	3	33	12:23	-	Exceeded calibration range
	ST8-10-PV6	6	66	12:27	29000	
	ST8-10-PV10	10	110	12:32	27000	
	ST8-10-PV67	67	500	12:36	27000	
				Average	27250	
				StDev	1090	
			%RSD	4.0%		
ST9-10	ST9-10-PV1	1	11	12:55	430	
	ST9-10-PV2	2	22	13:01	460	
	ST9-10-PV3	3	33	13:07	860	Suspected carryover
	ST9-10-PV6	6	66	13:15	520	
	ST9-10-PV10	10	110	13:19	500	
	ST9-10-PV67	67	500	13:23	370	
				Average	523	
				StDev	158	
			%RSD	30.2%		

Definitions

inHg - inches of mercury
 $(\mu\text{g}/\text{m}^3)$ - micrograms per cubic meter
ml/min - milliliters per minute
%RSD - percent relative standard deviation
StDev - standard deviation

Notes:

Purge rate was set at 200 ml/min
Sample volume was set at 20 ml
Samples collected 19 May 2009

Table B-4
Sample Volume Experiment Sample Summary

Location	Sample ID	Sample Volume (ml)	Sample Time	TCE (µg/m³)	Sample Container
ST3-2	ST3-2-SV10	10	8:57	130	Syringe
	ST3-2-SV60	60	9:23	150	Syringe
	ST3-2-SV500	500	10:37	140	Tedlar bag
	ST3-2-SV1000	1000	11:01	190	Tedlar bag
	ST3-2-SV6000	6000	12:53	130	Summa
			Average	148	
			StDev	22	
			%RSD	15.0%	
ST3-10	ST3-10-SV10	10	9:02	320	Syringe
	ST3-10-SV60	60	9:58	380	Syringe
	ST3-10-SV500	500	10:42	420	Tedlar bag
	ST3-10-SV1000	1000	11:06	530	Tedlar bag
	ST3-10-SV6000	6000	12:36	230	Summa
			Average	376	
			StDev	100	
		%RSD	26.6%		
ST2-4	ST2-4-SV10	10	9:07	2600	Syringe
	ST2-4-SV60	60	10:02	2800	Syringe
	ST2-4-SV500	500	10:46	2600	Tedlar bag
	ST2-4-SV1000	1000	11:11	2700	Tedlar bag
	ST2-4-SV6000	6000	13:02	2300	Summa
			Average	2600	
			StDev	167	
		%RSD	6.4%		
ST2-7	ST2-7-SV10	10	9:11	4100	Syringe
	ST2-7-SV60	60	10:07	4300	Syringe
	ST2-7-SV500	500	10:51	4100	Tedlar bag
	ST2-7-SV1000	1000	11:16	4200	Tedlar bag
	ST2-7-SV6000	6000	13:08	3700	Summa
			Average	4080	
			StDev	204	
		%RSD	5.0%		
ST8-4	ST8-4-SV10	10	9:17	41000	Syringe
	ST8-4-SV60	60	10:14	38000	Syringe
	ST8-4-SV500	500	10:56	36000	Tedlar bag
	ST8-4-SV1000	1000	11:21	37000	Tedlar bag
	ST8-4-SV6000	6000	13:16	33000	Summa
			Average	37000	
			StDev	2608	
		%RSD	7.0%		

Definitions

inHg - inches of mercury
(µg/m³) - micrograms per cubic meter
ml/min - milliliters per minute
%RSD - percent relative standard deviation
StDev - standard deviation

Notes:

Purge rate was set at 200 ml/min
Purge volume was set at 3 system volumes
Sampls collected 20 May 2009



Figure B-1 Linear Plot of Purge Rate Experiment Data

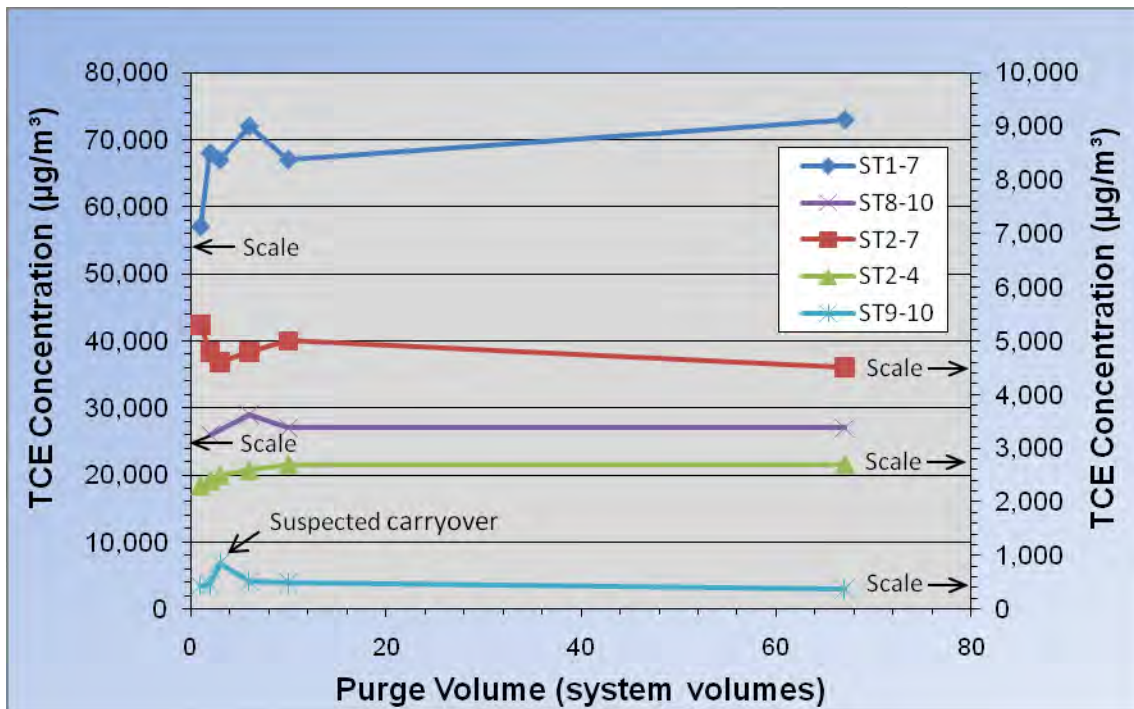

Figure B-2 Linear Plot of Purge Volume Experiment Data

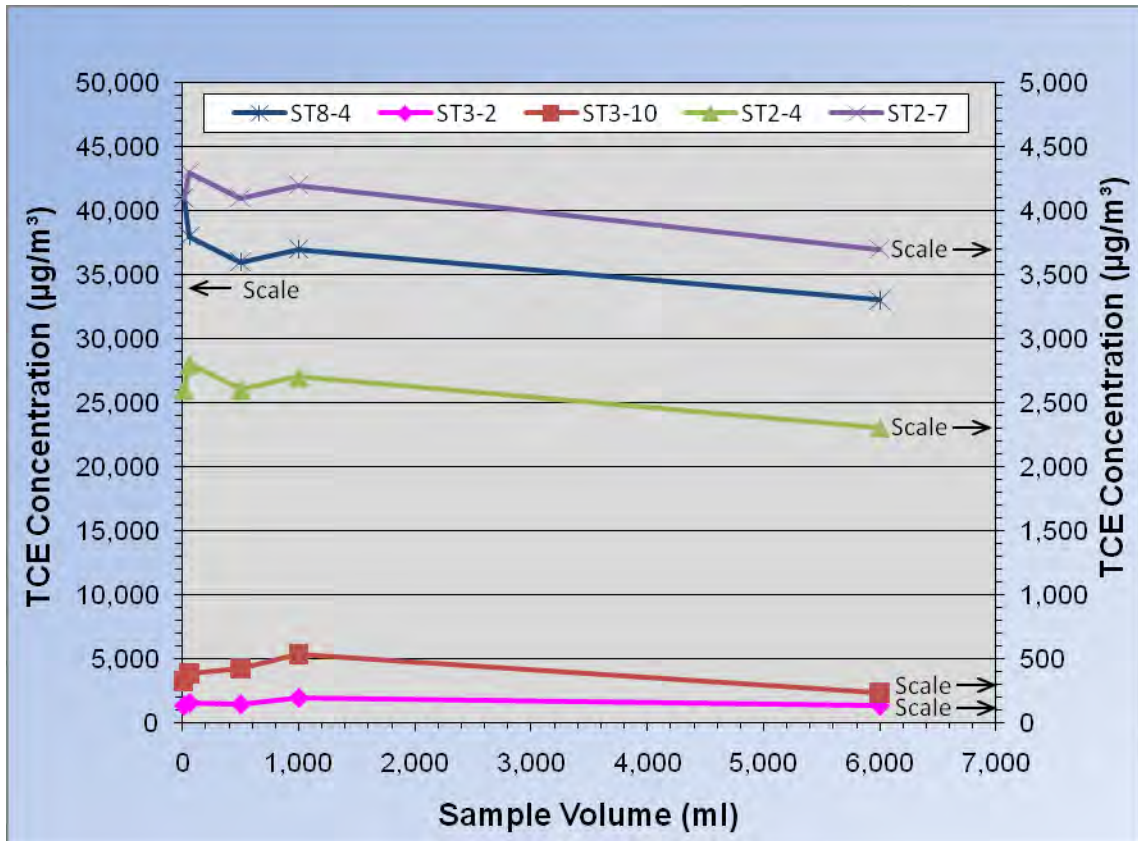

Figure B-3 Linear Plot of Sample Volume Experiment Data

6.0 REFERENCES

California Environmental Protection Agency (Cal/EPA) Department of Toxic Substances Control (DTSC)

2003 *Advisory Active Soil Gas Investigations*. January.

Interstate Technology & Regulatory Council (ITRC)

2007 *Vapor Intrusion Pathway: A Practical Guideline*. January

U.S. Environmental Protection Agency (EPA)

2007 *Final Project Report for Development of Active Soil Gas Sampling Method*. Office of Research and Development, National Exposure Research Laboratory, Las Vegas, Nevada. EPA/600/R-07/076.

Appendix C

Example Chromatograms and Laboratory Data

Calibration files for ECD/PID for Lemoore 12/17/2008

PID	TCE			PCE	
	conc (ppbv)	area	area/conc	area	area/conc
	1000	129	0.129	105	0.105
	200	25	0.125	21.5	0.108
	100	13.4	0.134	13.3	0.133
		%RSD=	2.80%	%RSD=	11.00%
ECD	TCE			PCE	
	conc (ppbv)	area	area/conc	area	area/conc
	100	2257	22.6	7681	76.8
	50	1444	28.9	5581	112
	25	857	34.3	3304	132
		%RSD=	16.70%	%RSD=	21.40%

Lab name: H&P
 Client: TETRA TECH
 Client ID: TO-85
 Analysis date: 12/17/2008 11:15:27
 Method: Syringe Injection
 Lab ID: TT121608-T2
 Description: CHANNEL 1 - PID
 Data file: 121608P-59.CHR ()
 Sample: 100 PPBV
 Operator: Hartman

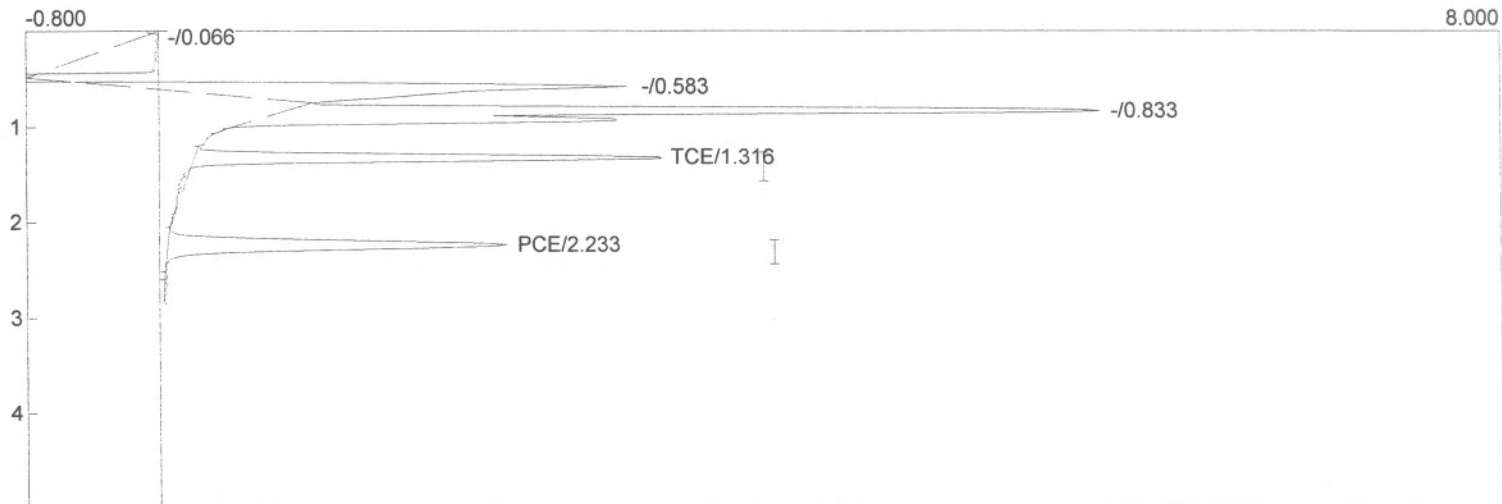

Component	Retention	Area	External	Internal	Units
-	0.066	29.1260	0.0000	0.0000	
-	0.583	27.9640	0.0000	0.0000	
-	0.833	32.4800	0.0000	0.0000	
TCE	1.316	13.4400	128.4895	706.6922	ug/m3
PCE	2.233	13.3020	151.8493	1050.7973	ug/m3
		116.3120	280.3388	1757.4894	

Lab name: H&P
 Client: TETRA TECH
 Client ID: TO-85
 Analysis date: 12/17/2008 11:35:49
 Method: Syringe Injection
 Lab ID: TT121608-T2
 Description: CHANNEL 1 - PID
 Data file: 121608P-63.CHR ()
 Sample: 200 PPBV
 Operator: Hartman

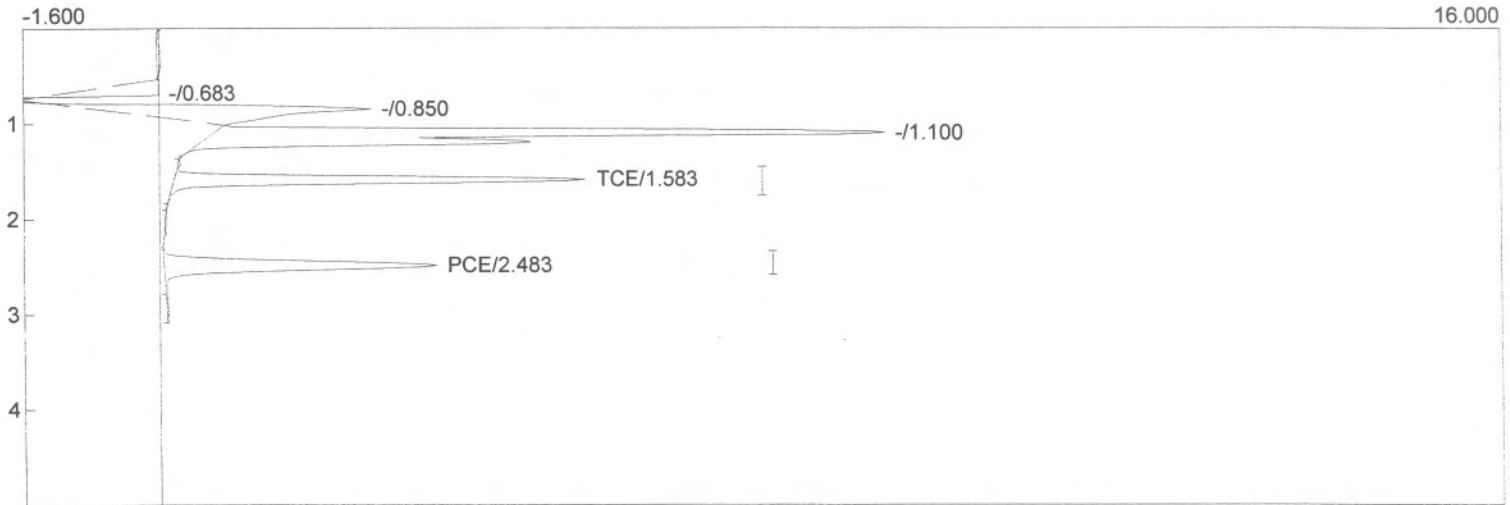

Component	Retention	Area	External	Internal	Units
-	0.683	11.1160	0.0000	0.0000	
-	0.850	25.6140	0.0000	0.0000	
-	1.100	56.0150	0.0000	0.0000	
TCE	1.583	24.9620	238.6424	1312.5335	ug/m3
PCE	2.483	21.5300	245.7763	1700.7717	ug/m3
		139.2370	484.4187	3013.3052	

Lab name: H&P
 Client: TETRA TECH
 Client ID: TO-85
 Analysis date: 12/17/2008 11:29:57
 Method: Syringe Injection
 Lab ID: TT121608-T2
 Description: CHANNEL 1 - PID
 Data file: 121608P-62.CHR ()
 Sample: 1000 PPBV
 Operator: Hartman

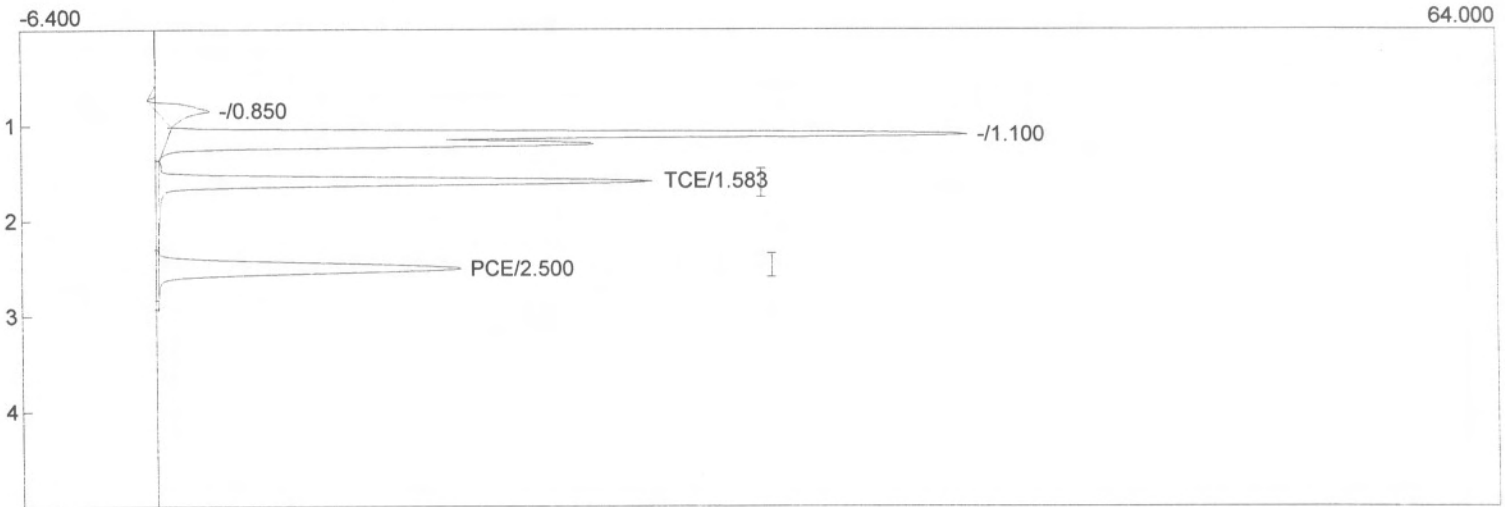

Component	Retention	Area	External	Internal	Units
-	0.850	19.7670	0.0000	0.0000	
-	1.100	279.8510	0.0000	0.0000	
TCE	1.583	128.6300	1229.7323	6763.5277	ug/m3
PCE	2.500	105.3280	1202.3744	8320.4311	ug/m3
		533.5760	2432.1067	15083.9588	

Lab name: H&P
 Client: tetra Tech
 Client ID: TO-85
 Analysis date: 12/17/2008 14:01:41
 Method: SYRINGE
 Lab ID: TT121608-T2
 Description: CHANNEL 2 - ECD
 Data file: 121608E-86.CHR ()
 Sample: 25 PPBV
 Operator: Hartman

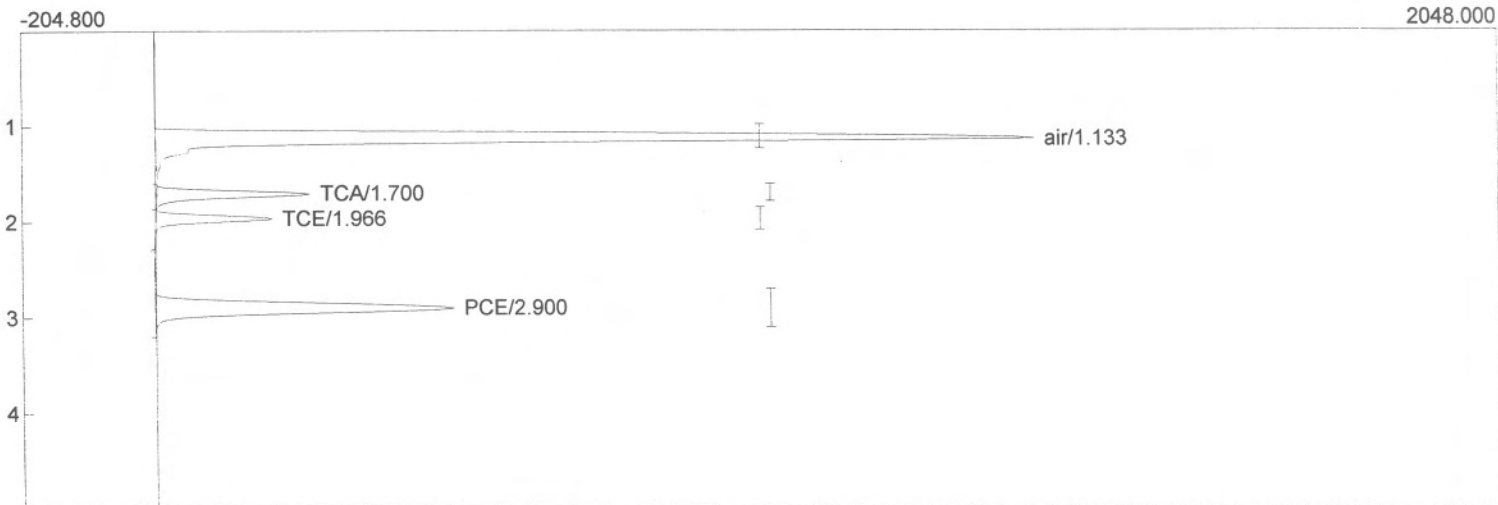

Component	Retention	Area	External	Internal	Units
air	1.133	8396.9700	0.0000	0.0000	
TCA	1.700	1162.5500	0.0000	0.0000	
TCE	1.966	856.6880	29.2952	161.1234	ug/m3
PCE	2.900	3304.5260	29.4049	203.4821	ug/m3
		13720.7340	58.7001	364.6055	

Lab name: H&P
 Client: tetra Tech
 Client ID: TO-85
 Analysis date: 12/17/2008 14:06:06
 Method: SYRINGE
 Lab ID: TT121608-T2
 Description: CHANNEL 2 - ECD
 Data file: 121608E-87.CHR ()
 Sample: 50 PPBV
 Operator: Hartman

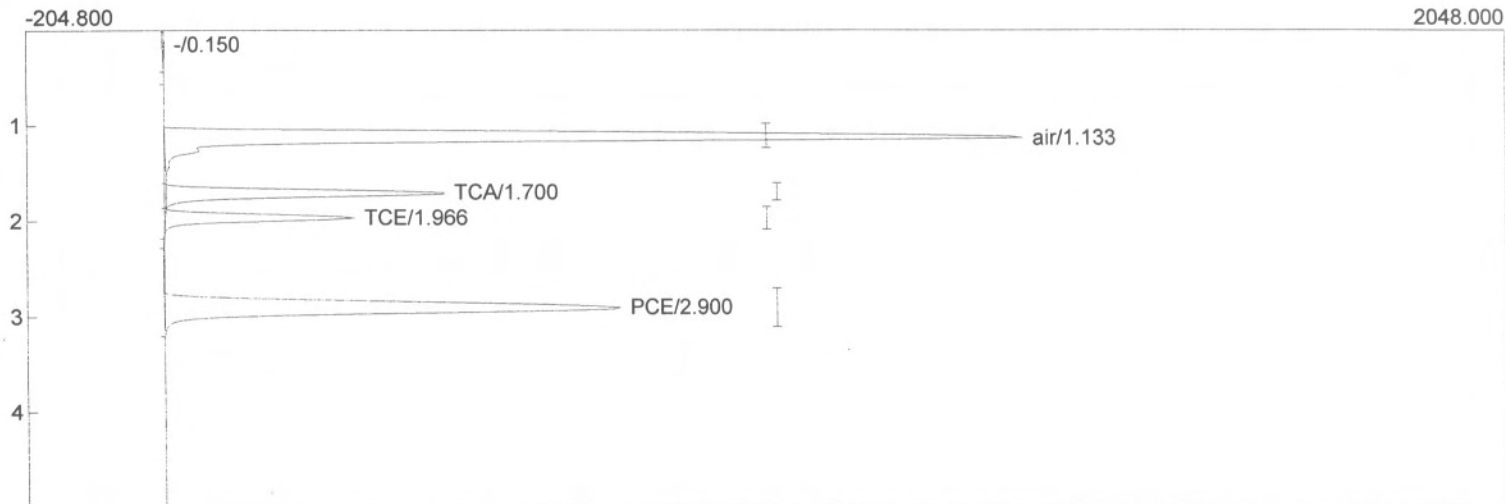

Component	Retention	Area	External	Internal	Units
-	0.150	44.5790	0.0000	0.0000	
air	1.133	8207.7100	0.0000	0.0000	
TCA	1.700	2303.5140	0.0000	0.0000	
TCE	1.966	1444.1330	49.3833	271.6083	ug/m3
PCE	2.900	5581.1400	49.6631	343.6687	ug/m3
		17581.0760	99.0464	615.2770	

Lab name: H&P
 Client: tetra Tech
 Client ID: TO-85
 Analysis date: 12/17/2008 14:10:06
 Method: SYRINGE
 Lab ID: TT121608-T2
 Description: CHANNEL 2 - ECD
 Data file: 121608E-88.CHR ()
 Sample: 100 PPBV
 Operator: Hartman

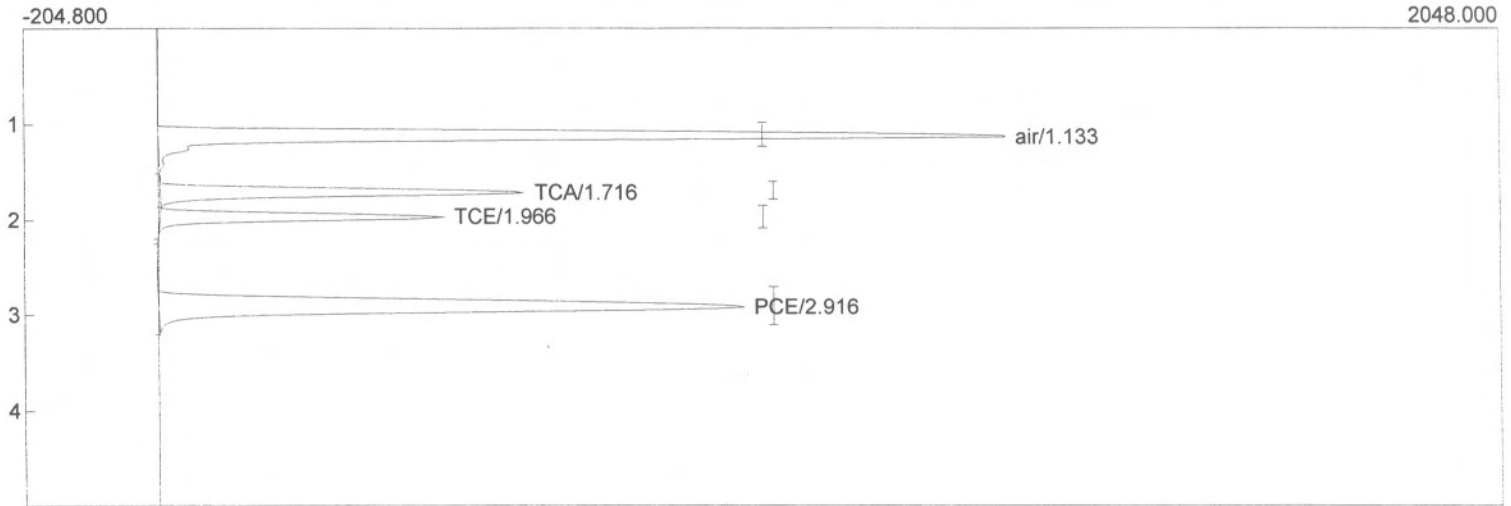

Component	Retention	Area	External	Internal	Units
air	1.133	8065.8460	0.0000	0.0000	
TCA	1.716	3081.1660	0.0000	0.0000	
TCE	1.966	2257.8260	77.2082	424.6453	ug/m3
PCE	2.916	7681.5670	68.3535	473.0063	ug/m3
		21086.4050	145.5617	897.6515	

Lab name: H&P
 Client: tetra Tech
 Client ID: TO-85
 Analysis date: 12/17/2008 11:29:58
 Method: SYRINGE
 Lab ID: TT121608-T2
 Description: CHANNEL 2 - ECD
 Data file: 121608E-62.CHR ()
 Sample: 1000 ppbv
 Operator: Hartman

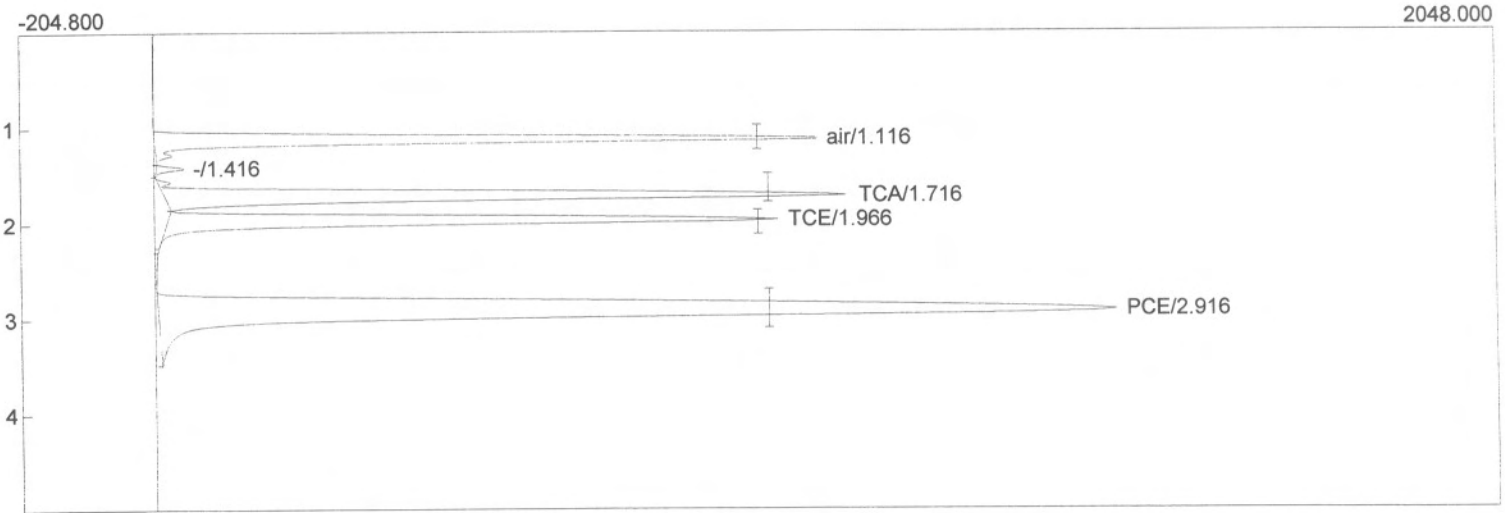

Component	Retention	Area	External	Internal	Units
air	1.116	5477.5520	0.0000	0.0000	
-	1.416	126.8180	0.0000	0.0000	
TCA	1.716	6713.4590	0.0000	0.0000	
TCE	1.966	5607.3240	398.9558	2194.2570	ug/m3
PCE	2.916	15647.9480	207.3262	1434.6976	ug/m3
		33573.1010	606.2821	3628.9546	

Lab name: H&P
 Client: TETRA TECH
 Client ID: Streams TO
 Analysis date: 11/14/2008 12:51:12
 Description: CHANNEL 1 - PID
 Data file: PID-111408-40.CHR ()
 Sample: ST2MP-7
 Operator: Hartman

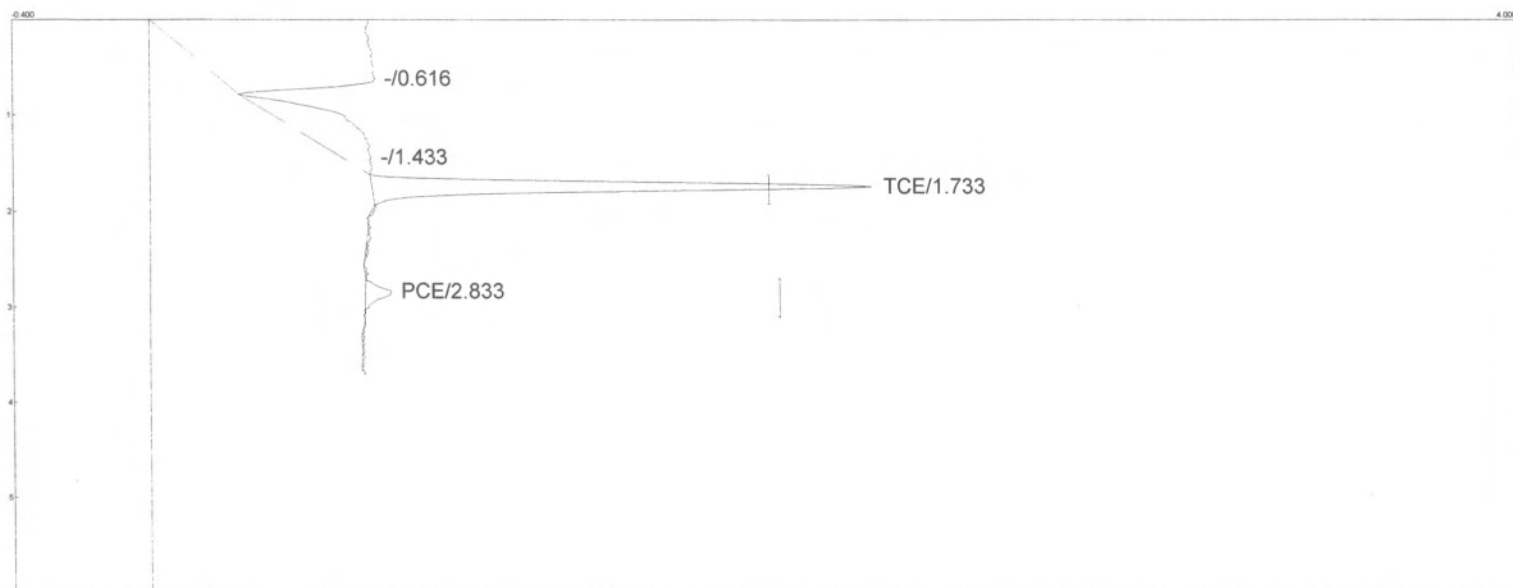

Component	Retention	Area	External	Internal	Units
TCE	1.733	9.5150	566.3690	3115.0298	ug/m3
PCE	2.833	0.6840	19.7688	136.8000	ug/m3
		10.1990	586.1378	3251.8298	

Lab name: H&P T3
 Client: Tetra tech
 Client ID: Streams TO
 Analysis date: 11/14/2008 12:51:12
 Description: CHANNEL 2 - ECD
 Data file: ECD-111408-40.CHR ()
 Sample: ST2MP-7
 Operator: Hartman

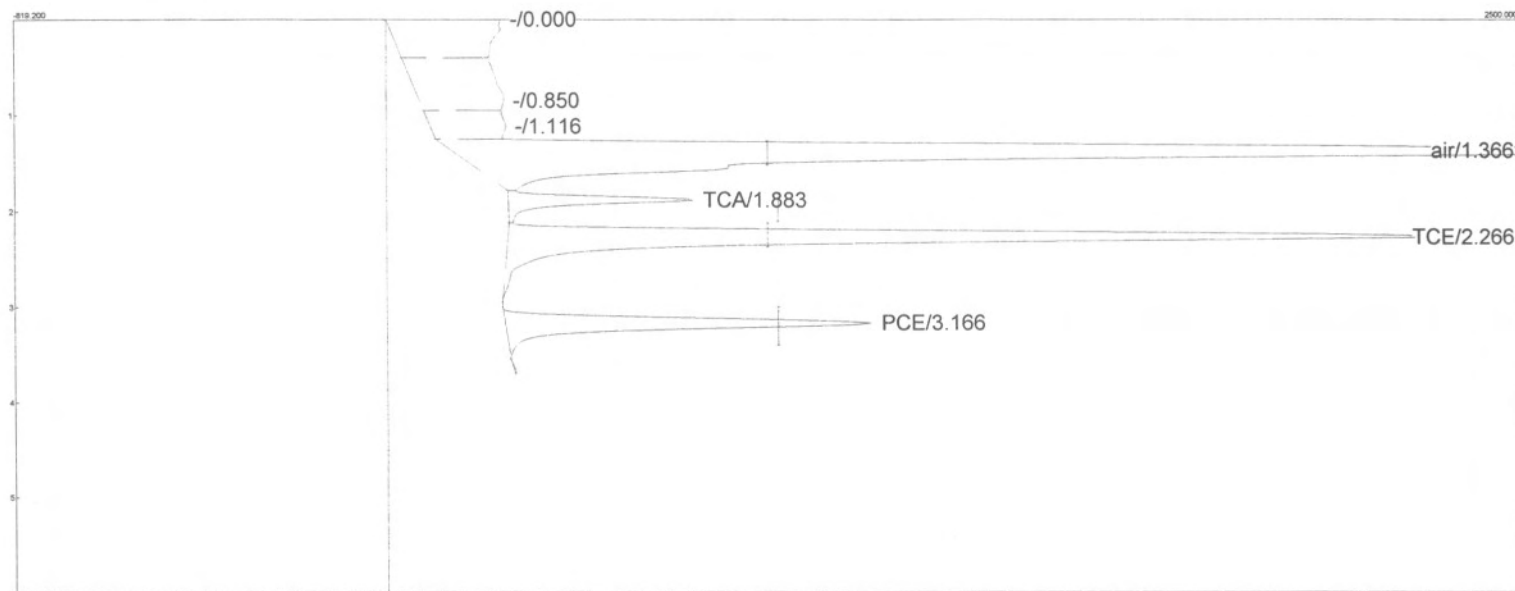

Component	Retention	Area	External	Internal	Units
air	1.366	29691.1440	0.0000	0.0000	
TCA	1.883	2361.7620	0.0000	0.0000	
TCE	2.266	16744.5910	201.9773	1110.8751	ug/m3
PCE	3.166	6376.8300	42.6444	295.0992	ug/m3
		55174.3270	244.6217	1405.9744	

Lab name: H&P
 Client: TETRA TECH
 Client ID: TO-85
 Analysis date: 01/20/2009 16:29:22
 Method: Syringe Injection
 Lab ID: TT121608-T2
 Description: CHANNEL 1 - PID
 Data file: 012009P-67.chr ()
 Sample: ST1-2'
 Operator: Hartman

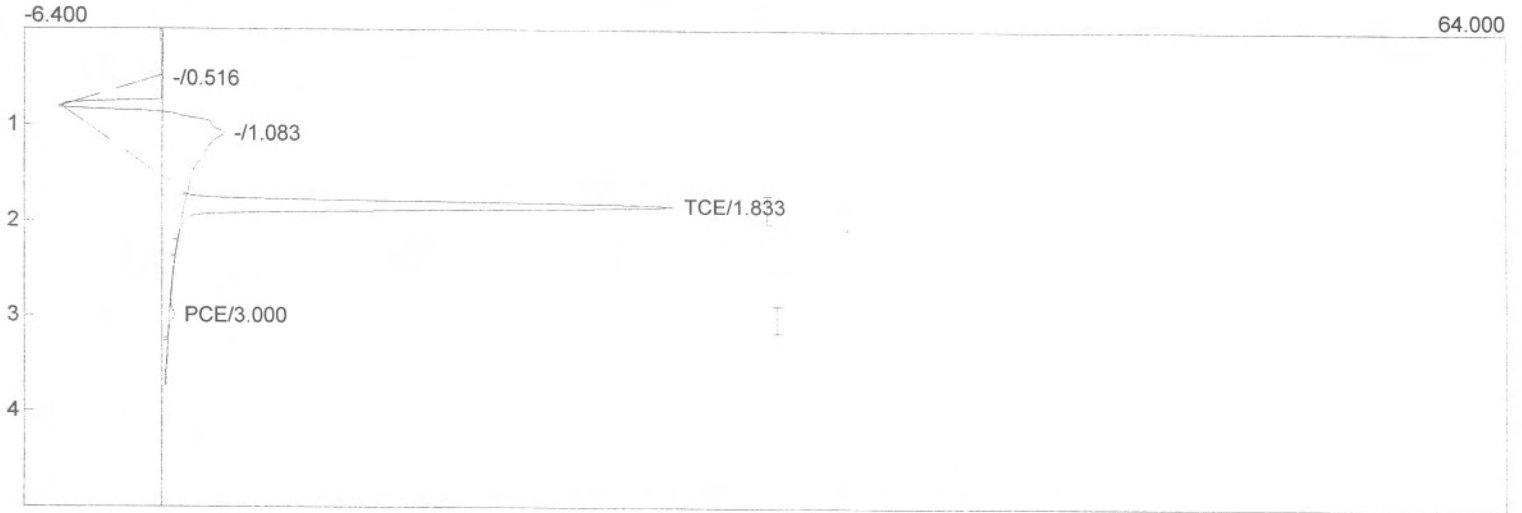

Component	Retention	Area	External	Internal	Units
TCE	1.833	141.4420	1661.5800	9138.6902	ug/m3
PCE	3.000	2.2910	26.9134	186.2405	ug/m3
		143.7330	1688.4934	9324.9306	

Lab name: H&P
 Client: tetra Tech
 Client ID: TO-85
 Analysis date: 01/20/2009 16:29:22
 Method: SYRINGE
 Lab ID: TT121608-T2
 Description: CHANNEL 2 - ECD
 Data file: 012009E-67.CHR ()
 Sample: ST1-2'
 Operator: Hartman

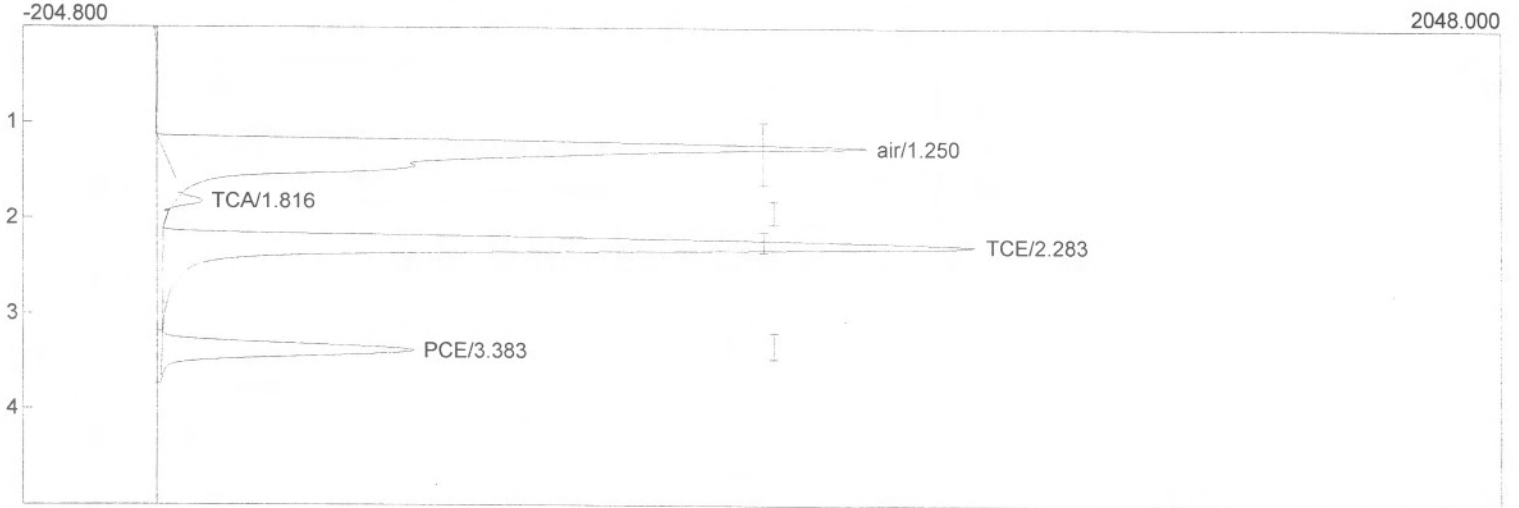

Component	Retention	Area	External	Internal	Units
air	1.250	13445.7610	0.0000	0.0000	
TCA	1.816	229.8160	0.0000	0.0000	
TCE	2.283	12286.8700	537.1395	2954.2674	ug/m3
PCE	3.383	3424.1050	20.5627	142.2941	ug/m3
		29386.5520	557.7022	3096.5614	

Lab name: H&P
 Client: TETRA TECH
 Client ID: TO-85
 Analysis date: 03/17/2009 13:40:04
 Method: Syringe Injection
 Lab ID: TT121608-T2
 Description: CHANNEL 1 - PID
 Data file: 031709P-44.CHR ()
 Sample: ST2-4 DUP
 Operator: Russ

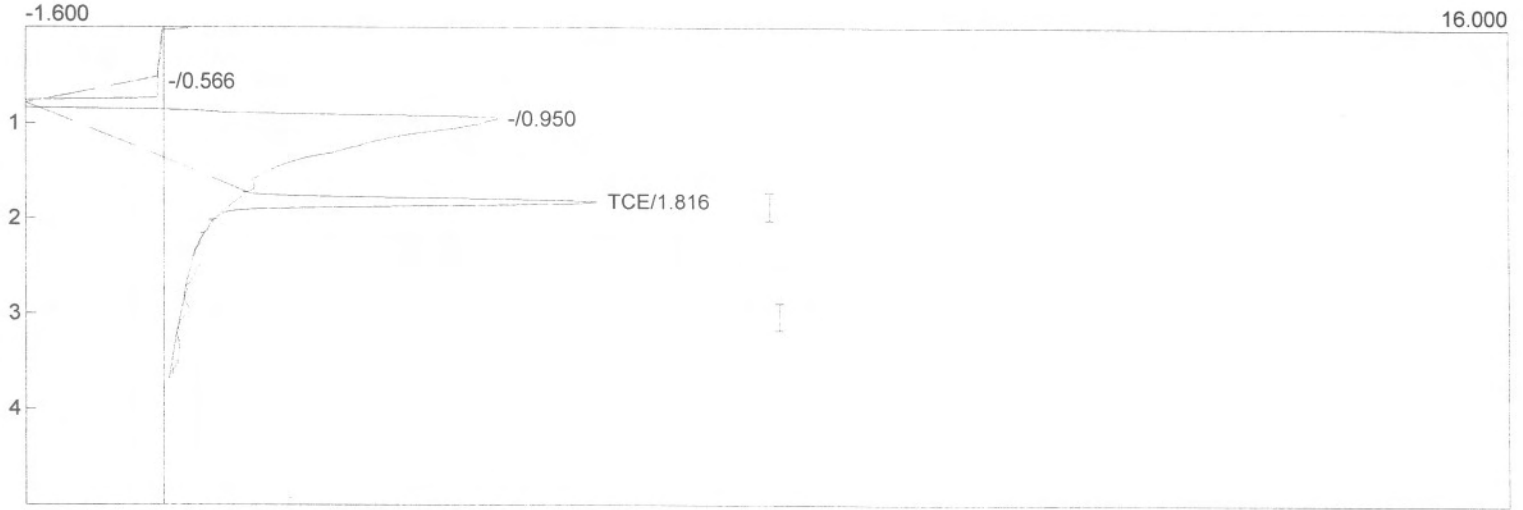

Component	Retention	Area	External	Internal	Units
TCE	1.816	24.4200	226.5306	1245.9184	ug/m3
		24.4200	226.5306	1245.9184	

Lab name: H&P
 Client: tetra Tech
 Client ID: TO-85
 Analysis date: 03/17/2009 13:40:04
 Method: SYRINGE
 Lab ID: TT121608-T2
 Description: CHANNEL 2 - ECD
 Data file: 031709E-44.CHR ()
 Sample: ST2-4 DUP
 Operator: Russ

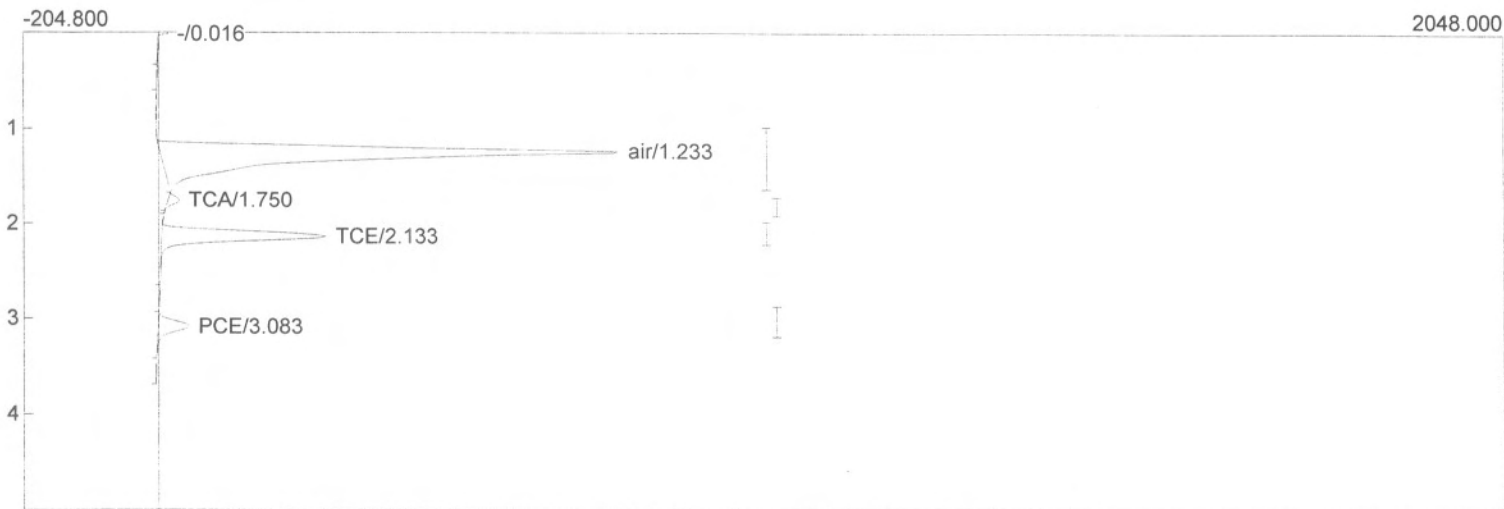

Component	Retention	Area	External	Internal	Units
air	1.233	6162.9730	0.0000	0.0000	
TCA	1.750	99.9280	0.0000	0.0000	
TCE	2.133	1719.4700	62.8275	345.5511	ug/m3
PCE	3.083	379.9850	3.2956	22.8057	ug/m3
		8362.3560	66.1231	368.3568	

Lab name: H&P
 Client: tetra Tech
 Analysis date: 04/22/2009 14:34:06
 Method: SYRINGE
 Lab ID: TT121608-T2
 Description: CHANNEL 2 - ECD
 Data file: 0422ECDA40.chr (C:/PEAK329/042209)
 Sample: st3mp-10
 Operator: JV

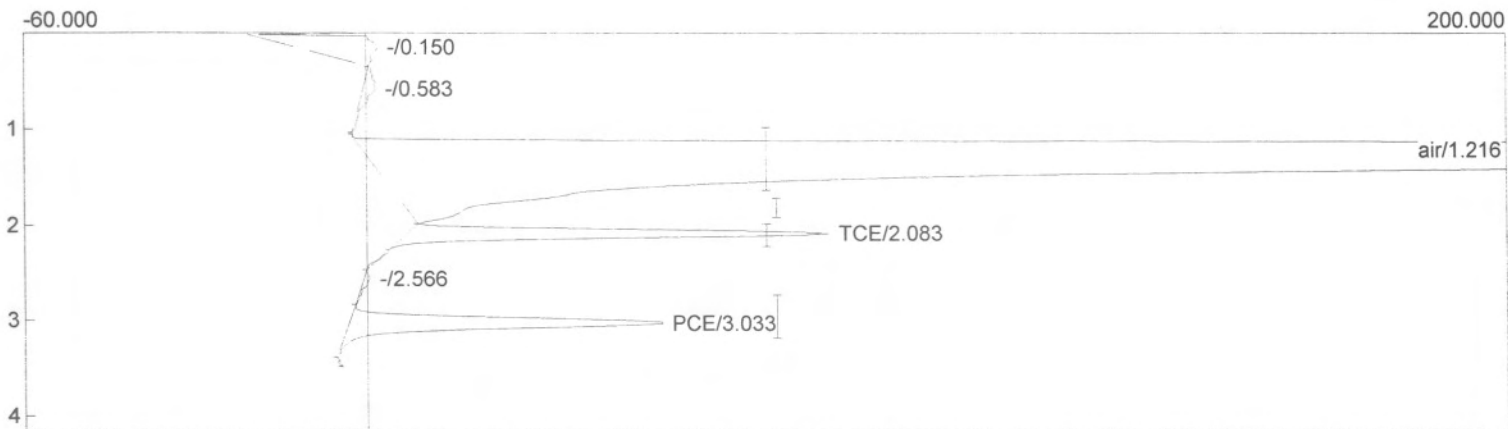

Component	Retention	Area	External	Internal	Units
air	1.216	10400.8080	0.0000	0.0000	
TCE	2.083	439.5200	14.5711	80.1409	ug/m3
PCE	3.033	430.6570	2.8351	19.6191	ug/m3
		11270.9850	17.4062	99.7600	

Lab name: H&P
 Client: TETRA TECH
 Analysis date: 04/22/2009 14:34:06
 Method: Syringe Injection
 Lab ID: TT121608-T2
 Description: CHANNEL 1 - PID
 Data file: 0422PIDa40.CHR (C:/PEAK329/042209)
 Sample: st3mp-10
 Operator: JV

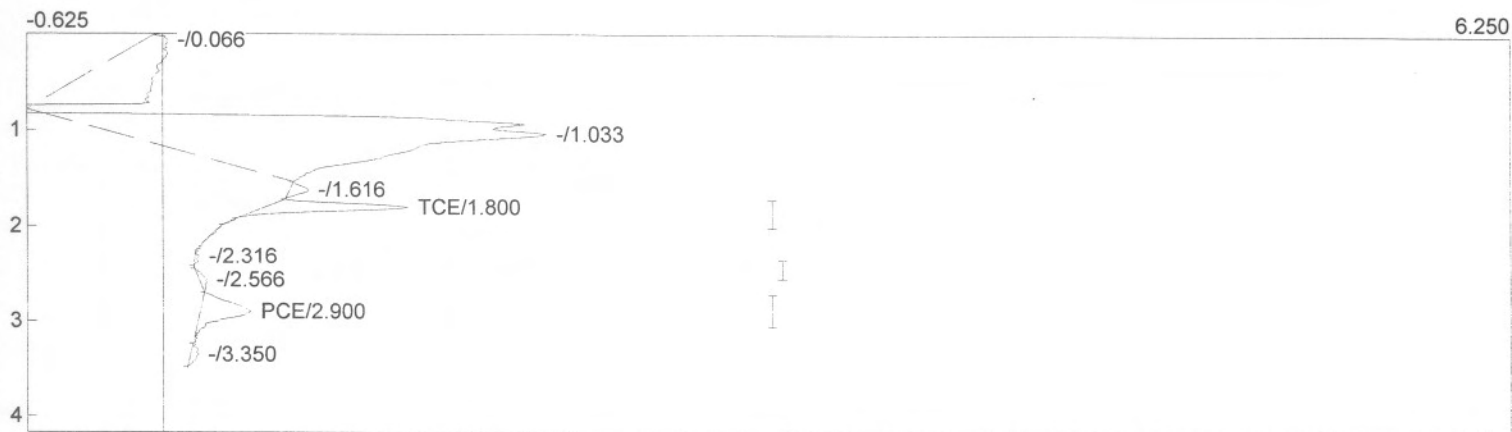

Component	Retention	Area	External	Internal	Units
TCE	1.800	3.5740	33.1540	182.3469	ug/m3
PCE	2.900	2.8180	25.3874	175.6807	ug/m3
		6.3920	58.5414	358.0277	

Lab name: H&P
 Client: tetra Tech
 Analysis date: 06/16/2009 12:39:07
 Method: SYRINGE
 Lab ID: TT121608-T2
 Description: CHANNEL 2 - ECD
 Data file: 0616ECD-46.CHR (C:/)
 Sample: ST3-2'
 Operator: ts

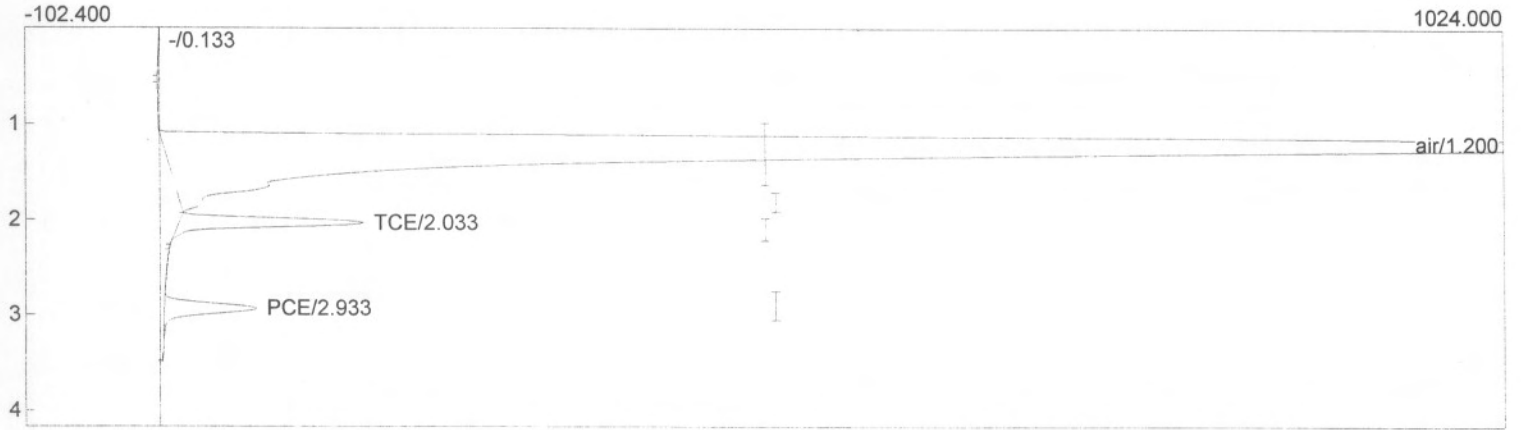

Component	Retention	Area	External	Internal	Units
air	1.200	18063.7700	0.0000	0.0000	
TCE	2.033	871.8420	23.3567	128.4620	ug/m3
PCE	2.933	530.5000	2.5603	17.7175	ug/m3
		19466.1120	25.9171	146.1794	

Lab name: H&P
 Client: TETRA TECH
 Analysis date: 06/16/2009 12:39:07
 Method: Syringe Injection
 Lab ID: TT121608-T2
 Description: CHANNEL 1 - PID
 Data file: 061609PID-46.chr (C:/)
 Sample: ST3-2'
 Operator: TS



Component	Retention	Area	External	Internal	Units
TCE	1.800	2.1360	13.7540	75.6471	ug/m3
Unknown	2.516	0.5820	0.0000	0.0000	
		2.7180	13.7540	75.6471	

Lab name: H&P
 Client: TETRA TECH
 Analysis date: 08/12/2009 12:58:13
 Method: Syringe Injection
 Lab ID: TT121608-T2
 Description: CHANNEL 1 - PID
 Data file: C:\Peak329\0812PID-46.CHR ()
 Sample: ST8-MP-2'
 Operator: T.S.
 QC batch:

DF = 5

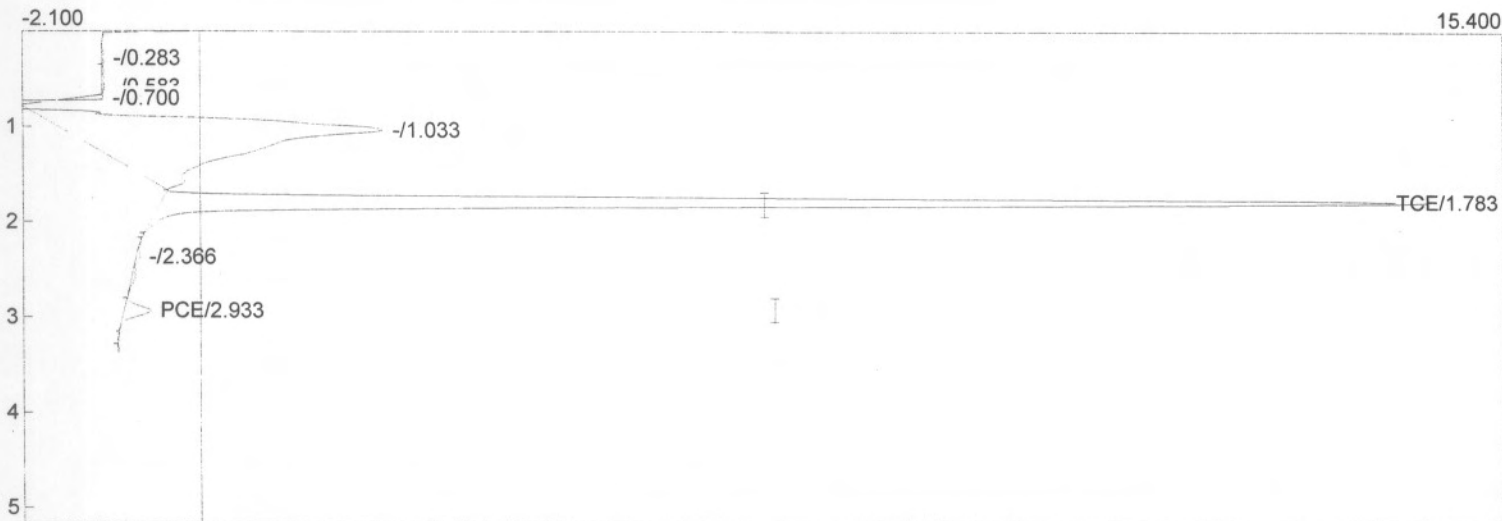

Component	Retention	Area	External	Internal	Units
TCE	1.783	90.5390	402.4403	2213.4215	ug/m3 + 5 = 11065
PCE	2.933	2.4400	10.7953	10.7953	ppbv
		92.9790	413.2355	2224.2168	

Lab name: H&P
 Client: tetra Tech
 Analysis date: 08/12/2009 12:58:13
 Method: SYRINGE
 Lab ID: TT121608-T2
 Description: CHANNEL 2 - ECD
 Data file: 0812ECD-46.chr ()
 Sample: ST8-MP-2'
 Operator: T.S.
 QC batch:

DF = 5

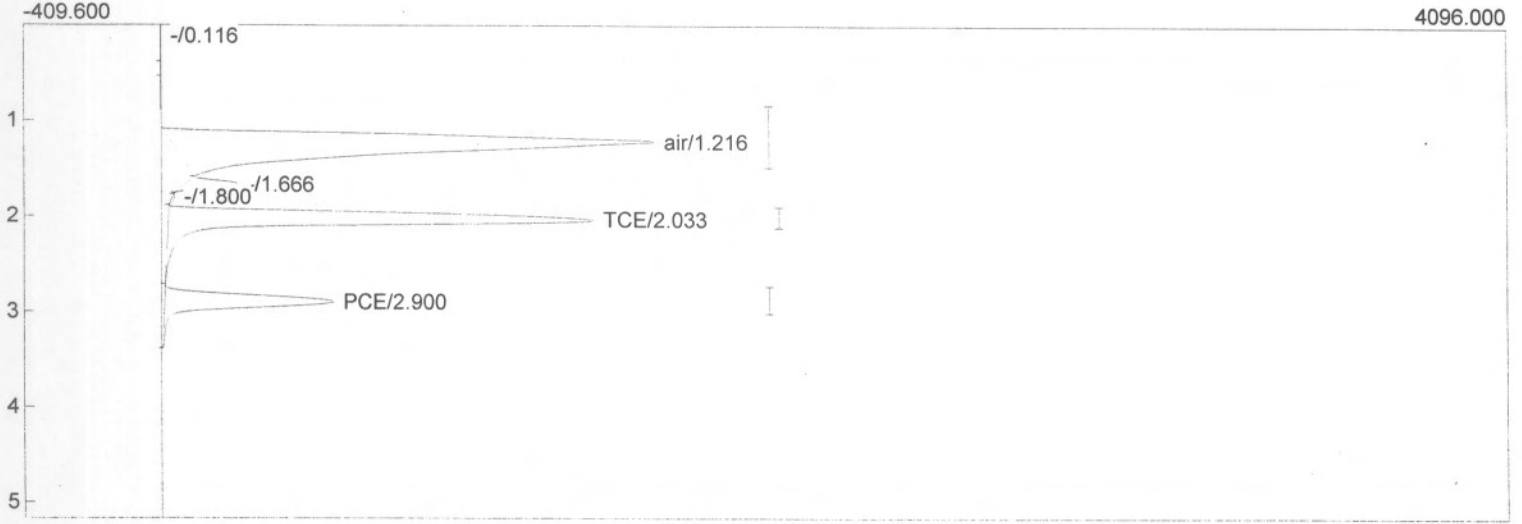

Component	Retention	Area	External	Internal	Units
air	1.216	18095.0450	558.3167	558.3167	
TCE	2.033	11045.6780	389.2755	2141.0151	ug/m3
PCE	2.900	4379.2220	16.1197	111.5482	ug/m3
		33519.9450	963.7119	2810.8800	

+5 = 555

Lab name: H&P
 Client: TETRA TECH
 Analysis date: 10/14/2009 11:27:50
 Method: Syringe Injection
 Lab ID: TT121608-T2
 Description: CHANNEL 1 - PID
 Data file: C:\Peak329\1014PID-26.CHR ()
 Sample: ST3-MP-10'
 Operator: T.S.
 QC batch:



Component	Retention	Area	External	Internal	Units
TCE	1.800	22.8000	143.2836	788.0597	ug/m3
PCE	3.016	3.9540	21.7133	21.7133	ppbv
		26.7540	164.9969	809.7730	

Lab name: H&P
 Client: tetra Tech
 Analysis date: 10/14/2009 11:27:50
 Method: SYRINGE
 Lab ID: TT121608-T2
 Description: CHANNEL 2 - ECD
 Data file: C:\Peak329\1014ECD-26.CHR ()
 Sample: ST3-MP-10'
 Operator: T.S.
 QC batch:

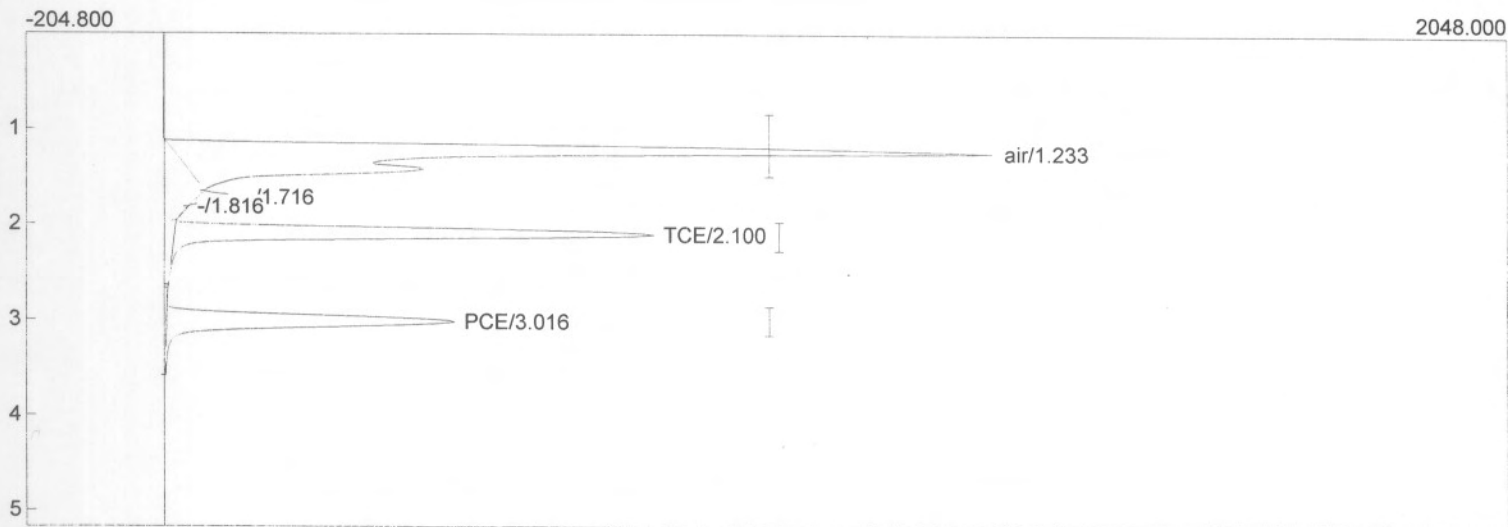

Component	Retention	Area	External	Internal	Units
air	1.233	11629.8640	358.8357	358.8357	
TCE	2.100	5207.9640	183.2187	1007.7031	ug/m3
PCE	3.016	3691.7460	13.0763	90.4883	ug/m3
		20529.5740	555.1308	1457.0270	

Appendix D

Groundwater Sample Data

Appendix D
Groundwater Sample Results Summary
(µg/L)

Sampling Round	Sample ID	TCE	PCE	1,1-DCA	1,1-DCE	cis -1,2-DCE	Benzene	Toluene	Naphthalene	Chloroform	Chloromethane	All other VOCs
November 2008	ST1-GW	310	1.0	2.2	4.1	5.4	ND	ND	ND	3.3	ND	ND
November 2008	ST2-GW	82	ND	ND	ND	ND	ND	ND	ND	1.5	ND	ND
November 2008	ST3-GW	40	ND	ND	ND	ND	ND	ND	ND	ND	ND	ND
November 2008	ST4-GW	0.81	ND	ND	ND	ND	ND	ND	ND	ND	ND	ND
November 2008	ST4-GWdup	ND	ND	ND	ND	ND	ND	ND	ND	ND	ND	ND
November 2008	ST5-GW	ND	ND	ND	ND	ND	ND	ND	ND	ND	ND	ND
November 2008	ST7-GW	500	2.8	3.4	3.7	16	ND	ND	ND	4.8	ND	ND
November 2008	ST8-GW	190	ND	ND	1.8	1.0	ND	ND	ND	2.0	1.0	ND
November 2008	ST9-GW	12	ND	ND	ND	ND	ND	ND	ND	ND	ND	ND
December 2008	ST1-GW	420	1.4	2.9	7.2	7.0	ND	ND	ND	3.8	ND	ND
December 2008	ST2-GW	85	ND	ND	ND	ND	ND	ND	ND	1.4	ND	ND
December 2008	ST3-GW	45	ND	ND	ND	ND	ND	ND	ND	ND	ND	ND
December 2008	ST4-GW	0.84	ND	ND	ND	ND	ND	ND	ND	ND	ND	ND
December 2008	ST5-GW	ND	ND	ND	ND	ND	ND	ND	ND	ND	ND	ND
December 2008	ST7-GW	470	2.6	3.2	4.0	15	ND	ND	ND	4.4	ND	ND
December 2008	ST7-GWdup	490	2.7	3.5	4.4	18	ND	ND	ND	4.9	ND	ND
December 2008	ST8-GW	190	ND	ND	2.0	ND	ND	ND	ND	1.9	ND	ND
December 2008	ST9-GW	9.6	ND	ND	ND	ND	ND	ND	ND	ND	ND	ND
January 2009	ST1-GW	420	1.2	3.4	7.8	7.2	ND	ND	ND	4.1	ND	ND
January 2009	ST2-GW	67	ND	ND	ND	ND	ND	ND	ND	1.2	ND	ND
January 2009	ST3-GW	32	ND	ND	ND	ND	ND	ND	ND	ND	ND	ND
January 2009	ST4-GW	0.69	ND	ND	ND	ND	ND	ND	ND	ND	ND	ND
January 2009	ST5-GW	ND	ND	ND	ND	ND	ND	ND	ND	ND	ND	ND
January 2009	ST7-GW	460	1.9	2.9	3.2	13	ND	ND	ND	4.3	ND	ND
January 2009	ST7-GWdup	450	2.1	2.9	3.3	13	ND	ND	ND	4.2	ND	ND
January 2009	ST8-GW	150	ND	ND	1.1	ND	ND	ND	ND	1.7	ND	ND
January 2009	ST9-GW	8.7	ND	ND	ND	ND	ND	ND	ND	ND	ND	ND
February 2009	ST1-GW	310	0.9	2.0	4.6	4.3	ND	ND	ND	3.0	ND	ND
February 2009	ST2-GW	74	0.4	ND	ND	ND	ND	ND	ND	1.1	ND	ND
February 2009	ST3-GW	34	ND	ND	ND	ND	ND	ND	ND	ND	ND	ND
February 2009	ST4-GW	0.6	ND	ND	ND	ND	ND	ND	ND	ND	ND	ND
February 2009	ST5-GW	ND	ND	ND	ND	ND	ND	ND	ND	ND	ND	ND
February 2009	ST7-GW	460	2.3	2.8	4.3	13	ND	ND	ND	4.0	ND	ND
February 2009	ST7-GWdup	450	2.4	2.7	3.8	13	ND	ND	ND	4.1	ND	ND
February 2009	ST8-GW	150	0.5	ND	1.2	ND	ND	ND	ND	1.7	ND	ND
February 2009	ST9-GW	7.6	ND	ND	ND	ND	ND	ND	ND	ND	ND	ND
March 2009	ST1-GW	320	1.1	2.1	4.6	4.5	ND	ND	ND	2.9	ND	ND
March 2009	ST2-GW	66	0.4	ND	ND	ND	ND	0.5	ND	1.2	ND	ND
March 2009	ST3-GW	32	ND	ND	ND	ND	ND	ND	ND	ND	ND	ND
March 2009	ST4-GW	0.5	ND	ND	ND	ND	ND	ND	ND	ND	ND	ND
March 2009	ST5-GW	ND	ND	ND	ND	ND	ND	ND	ND	ND	ND	ND
March 2009	ST7-GW	380	2.3	2.2	3.2	11	ND	ND	ND	3.5	ND	ND
March 2009	ST7-GWdup	340	2.4	2.2	3.4	11	ND	ND	ND	3.5	ND	ND
March 2009	ST8-GW	110	0.5	ND	ND	ND	ND	ND	ND	1.6	ND	ND
March 2009	ST9-GW	5.9	ND	ND	ND	ND	ND	ND	ND	ND	ND	ND
April 2009	ST1-GW	360	1.4	2.1	4.4	4.7	0.2	0.3	ND	3.4	ND	ND
April 2009	ST2-GW	66	0.6	ND	0.8	ND	ND	0.4	ND	1.5	ND	ND
April 2009	ST3-GW	28	0.2	ND	ND	ND	ND	0.5	ND	ND	ND	ND
April 2009	ST4-GW	0.5	ND	ND	ND	ND	ND	ND	ND	ND	ND	ND
April 2009	ST5-GW	ND	ND	ND	ND	ND	ND	0.5	ND	ND	ND	ND
April 2009	ST7-GW	510	3.1	3.2	4.6	15	0.4	0.4	ND	4.8	ND	ND
April 2009	ST7-GWdup	440	2.5	2.8	3.5	14	0.3	0.3	ND	4.4	ND	ND
April 2009	ST8-GW	140	0.8	0.5	1.5	0.8	0.2	0.4	ND	1.9	ND	ND
April 2009	ST9-GW	6.5	ND	ND	ND	ND	ND	0.5	ND	ND	ND	ND
May 2009	ST1-GW	330	0.8	ND	2.5	3.4	ND	ND	ND	3.1	ND	ND
May 2009	ST2-GW	67	0.4	ND	ND	ND	ND	ND	ND	1.1	ND	ND
May 2009	ST3-GW	35	ND	ND	ND	ND	ND	ND	ND	ND	ND	ND
May 2009	ST4-GW	0.6	ND	ND	ND	ND	ND	ND	ND	ND	ND	ND
May 2009	ST5-GW	ND	ND	ND	ND	ND	ND	ND	ND	ND	ND	ND
May 2009	ST7-GW	510	2.7	3.0	3.0	14	ND	ND	ND	4.5	ND	ND
May 2009	ST8-GW	160	0.6	ND	1.3	ND	ND	ND	ND	1.8	ND	ND
May 2009	ST9-GW	7.7	ND	ND	ND	ND	ND	ND	ND	ND	ND	ND
June 2009	ST1-GW	390	1.1	2.6	4.2	4.9	ND	ND	ND	4.1	ND	ND
June 2009	ST2-GW	75	ND	ND	ND	ND	ND	ND	ND	1.5	ND	ND
June 2009	ST3-GW	32	ND	ND	ND	ND	ND	ND	ND	ND	ND	ND
June 2009	ST4-GW	0.6	ND	ND	ND	ND	ND	ND	ND	ND	ND	ND
June 2009	ST5-GW	ND	ND	ND	ND	ND	ND	ND	ND	ND	ND	ND
June 2009	ST7-GW	670	3.8	3.9	4.2	18	ND	ND	ND	6.1	ND	ND
June 2009	ST7-GWdup	480	2.2	3.6	2.9	17	ND	ND	ND	5.2	ND	ND
June 2009	ST8-GW	160	0.5	ND	1.1	ND	ND	ND	ND	2.0	ND	ND
June 2009	ST9-GW	7.0	ND	ND	ND	ND	ND	ND	ND	ND	ND	ND

Appendix D
Groundwater Sample Results Summary
(µg/L)

Sampling Round	Sample ID	TCE	PCE	1,1-DCA	1,1-DCE	cis -1,2-DCE	Benzene	Toluene	Naphthalene	Chloroform	Chloromethane	All other VOCs
July 2009	ST1-GW	430	1.4	2.5	5.2	5.0	ND	ND	ND	3.7	ND	ND
July 2009	ST2-GW	93	0.5	ND	ND	ND	ND	ND	ND	1.6	ND	ND
July 2009	ST3-GW	37	ND	ND	ND	ND	ND	ND	ND	ND	ND	ND
July 2009	ST4-GW	0.4	ND	ND	ND	ND	ND	ND	ND	ND	ND	ND
July 2009	ST5-GW	ND	ND	ND	ND	ND	ND	ND	ND	ND	ND	ND
July 2009	ST7-GW	830	4.2	4.4	6.1	23	ND	ND	ND	6.1	ND	ND
July 2009	ST7-GWdup	830	4.4	4.9	7.2	26	ND	ND	ND	6.5	ND	ND
July 2009	ST8-GW	210	0.8	ND	1.3	ND	ND	ND	ND	2.1	ND	ND
July 2009	ST9-GW	7.0	ND	ND	ND	ND	ND	ND	ND	ND	ND	ND
August 2009	ST1-GW	280	1.7	3.4	8.0	6.8	ND	ND	ND	4.4	ND	ND
August 2009	ST2-GW	52	0.4	ND	ND	ND	ND	ND	ND	1.5	ND	ND
August 2009	ST3-GW	28	0.2	ND	ND	ND	ND	ND	ND	ND	ND	ND
August 2009	ST7-GW	640	3.8	3.9	4.5	20	ND	ND	ND	5.2	ND	ND
August 2009	ST7-GWdup	690	3.6	4.2	5.0	22	ND	ND	ND	5.5	ND	ND
August 2009	ST8-GW	70	0.3	ND	ND	ND	ND	ND	ND	1.0	ND	ND
August 2009	ST9-GW	5.7	ND	ND	ND	ND	ND	ND	ND	ND	ND	ND
September 2009	ST1-GW	300	1.4	2.6	6.7	6.0	ND	ND	ND	3.7	ND	ND
September 2009	ST2-GW	56	0.4	ND	ND	ND	ND	ND	ND	1.3	ND	ND
September 2009	ST3-GW	27	ND	ND	ND	ND	ND	ND	ND	ND	ND	ND
September 2009	ST4-GW	0.6	ND	ND	ND	ND	ND	ND	ND	ND	ND	ND
September 2009	ST5-GW	ND	ND	ND	ND	ND	ND	ND	ND	ND	ND	ND
September 2009	ST7-GW	490	3.8	3.6	4.8	21	ND	ND	ND	5.2	ND	ND
September 2009	ST7-GWdup	360	2.4	2.7	2.8	17	ND	ND	ND	4.2	ND	ND
September 2009	ST8-GW	130	0.6	ND	1.8	ND	ND	ND	ND	2.0	ND	ND
September 2009	ST9-GW	7.6	ND	ND	ND	ND	ND	ND	ND	ND	ND	ND
October 2009	ST1-GW	360	1.4	2.5	5.3	5.8	ND	ND	ND	3.6	ND	ND
October 2009	ST2-GW	35	ND	ND	ND	ND	ND	ND	ND	1.4	ND	ND
October 2009	ST3-GW	22	ND	ND	ND	ND	ND	ND	1.4	ND	ND	ND
October 2009	ST4-GW	0.5	ND	ND	ND	ND	ND	ND	ND	ND	ND	ND
October 2009	ST5-GW	ND	ND	ND	ND	ND	ND	ND	ND	ND	ND	ND
October 2009	ST7-GW	400	3.6	3.9	4.4	23	ND	ND	ND	5.4	ND	ND
October 2009	ST8-GW	130	0.8	ND	1.2	1.1	ND	ND	ND	2.1	ND	ND
October 2009	ST9-GW	5.8	ND	ND	ND	ND	ND	ND	ND	ND	ND	ND

Definitions:

- µg/L - micrograms per liter
- DCA - dichloroethane
- DCE - dichloroethene
- ND - not detected
- PCE - tetrachloroethene
- TCE - trichloroethene

Appendix E

Soil Vapor Sample Data

Appendix E
Soil Vapor Sample Results Summary
($\mu\text{g}/\text{m}^3$)

Sampling Round	Location	Depth	Macro TCE	Micro TCE	Macro PCE	Micro PCE
November 2008	ST-1	SS	PLUGGED	NA	PLUGGED	NA
November 2008	ST-1	2	8,350	8,900	180	310
November 2008	ST-1	4	37,600	64,000	780	1,700
November 2008	ST-1	7	56,000	210	1,400	ND
November 2008	ST-1	10	90,000	38	2,500	22
November 2008	ST-2	SS	PLUGGED	NA	PLUGGED	NA
November 2008	ST-2	2	200	280	40	90
November 2008	ST-2	4	1,000	1,900		200
November 2008	ST-2	7	2,700	3,100	170	300
November 2008	ST-2	10	2,500	1,400	215	180
November 2008	ST-3	2	PLUGGED	36	PLUGGED	19
November 2008	ST-3	4	110	ND	70	ND
November 2008	ST-3	7	197	330	90	130
November 2008	ST-3	10	60	300	165	130
November 2008	ST-4	2	ND	ND	ND	ND
November 2008	ST-4	4	ND	ND	ND	ND
November 2008	ST-4	7	16	ND	39	ND
November 2008	ST-4	10	ND	ND	60	ND
November 2008	ST-5	2	ND	ND	ND	ND
November 2008	ST-5	4	ND	ND	ND	ND
November 2008	ST-5	7	ND	ND	ND	ND
November 2008	ST-5	10	ND	ND	ND	ND
November 2008	ST-7	SS	4,400	NA	ND	NA
November 2008	ST-7	2	40,000	66,000	900	2,400
November 2008	ST-7	4	60,000	158,000	1,300	5,100
November 2008	ST-7	7	92,000	87,000	3,500	3,400
November 2008	ST-7	10	165,000	53,000	4,500	2,700
November 2008	ST-8	SS	230	NA	ND	NA
November 2008	ST-8	2	4,450	6,900	150	450
November 2008	ST-8	4	8,300	4,100	260	230
November 2008	ST-8	7	14,700	8,600	370	230
November 2008	ST-8	10	30,000	7,300	800	170
November 2008	ST-9	2	24	ND	12	ND
November 2008	ST-9	4	46	ND	30	74
November 2008	ST-9	7	44	15	40	30
November 2008	ST-9	10	315	35	110	30
December 2008	ST-1	SS	460	NA	13	NA
December 2008	ST-1	2	9,800	6,700	185	200
December 2008	ST-1	4	52,000	38,000	1,000	940
December 2008	ST-1	7	80,000	NO SAMPLE	1,900	NO SAMPLE
December 2008	ST-1	10	103,000	NO SAMPLE	2,300	NO SAMPLE
December 2008	ST-2	SS	72	NA	ND	NA
December 2008	ST-2	2	71	210	13	32
December 2008	ST-2	4	1,600	1,140	100	100
December 2008	ST-2	7	4,250	2,700	170	145
December 2008	ST-2	10	4,200	1,300	290	130
December 2008	ST-3	2	62	22	17	18
December 2008	ST-3	4	140	ND	50	ND
December 2008	ST-3	7	315	270	110	80
December 2008	ST-3	10	93	270	165	83
December 2008	ST-4	2	ND	ND	ND	ND
December 2008	ST-4	4	ND	ND	ND	16
December 2008	ST-4	7	ND	ND	19	16
December 2008	ST-4	10	ND	ND	25	18
December 2008	ST-5	2	ND	ND	ND	ND
December 2008	ST-5	4	ND	ND	ND	ND
December 2008	ST-5	7	ND	ND	ND	ND
December 2008	ST-5	10	48	ND	47	ND
December 2008	ST-7	SS	4,300	NA	70	NA
December 2008	ST-7	2	55,000	30,000	1,100	930
December 2008	ST-7	4	130,000	96,000	2,700	2,700
December 2008	ST-7	7	190,000	27,500	5,600	950
December 2008	ST-7	10	350,000	114,000	11,000	4,250
December 2008	ST-8	SS	290	NA	18	NA
December 2008	ST-8	2	7,400	2,400	175	80
December 2008	ST-8	4	24,500	8,200	520	110
December 2008	ST-8	7	41,000	9,500	1,000	300
December 2008	ST-8	10	55,000	9,400	1,250	320

Appendix E
Soil Vapor Sample Results Summary
($\mu\text{g}/\text{m}^3$)

Sampling Round	Location	Depth	Macro TCE	Micro TCE	Macro PCE	Micro PCE
December 2008	ST-9	2	23	12	24	36
December 2008	ST-9	4	34	44	43	100
December 2008	ST-9	7	41	28	65	60
December 2008	ST-9	10	370	35	110	34
January 2009	ST-1	SS	660	NA	ND	NA
January 2009	ST-1	2	9,100	2,500	140	64
January 2009	ST-1	4	30,000	39,000	450	640
January 2009	ST-1	7	64,000	46,000	1,100	890
January 2009	ST-1	10	84,000	66,000	1,450	1,400
January 2009	ST-2	SS	33	NA	ND	NA
January 2009	ST-2	2	95	170	ND	ND
January 2009	ST-2	4	1,200	1,470	42	58
January 2009	ST-2	7	2,600	1,220	90	56
January 2009	ST-2	10	2,700	960	140	130
January 2009	ST-3	2	44	20	ND	ND
January 2009	ST-3	4	93	ND	ND	ND
January 2009	ST-3	7	230	300	39	38
January 2009	ST-3	10	83	250	61	46
January 2009	ST-4	2	ND	ND	ND	ND
January 2009	ST-4	4	ND	ND	ND	ND
January 2009	ST-4	7	ND	ND	ND	ND
January 2009	ST-4	10	ND	ND	ND	ND
January 2009	ST-5	2	ND	Probe removed	ND	Probe removed
January 2009	ST-5	4	ND	Probe removed	ND	Probe removed
January 2009	ST-5	7	ND	Probe removed	ND	Probe removed
January 2009	ST-5	10	ND	Probe removed	ND	Probe removed
January 2009	ST-7	SS	4,100	NA	58	NA
January 2009	ST-7	2	57,000	32,000	1,000	610
January 2009	ST-7	4	97,000	110,000	1,700	2,900
January 2009	ST-7	7	130,000	57,000	3,400	1,340
January 2009	ST-7	10	200,000	78,000	4,700	2,400
January 2009	ST-8	SS	290	NA	ND	NA
January 2009	ST-8	2	6,700	1,100	130	48
January 2009	ST-8	4	23,000	7,600	340	70
January 2009	ST-8	7	30,000	9,600	490	160
January 2009	ST-8	10	52,000	12,100	820	216
January 2009	ST-9	2	ND	ND	ND	ND
January 2009	ST-9	4	20	25	ND	ND
January 2009	ST-9	7	34	27	19	16
January 2009	ST-9	10	260	67	44	ND
February 2009	ST-1	SS	820	NA	ND	NA
February 2009	ST-1	2	9,500	3,500	165	68
February 2009	ST-1	4	22,000	28,500	230	530
February 2009	ST-1	7	54,000	32,000	940	750
February 2009	ST-1	10	53,000	44,000	1,100	1,100
February 2009	ST-2	SS	125	NA	ND	NA
February 2009	ST-2	2	186	86	18	10
February 2009	ST-2	4	1,600	1,240	57	34
February 2009	ST-2	7	2,900	1,500	87	60
February 2009	ST-2	10	2,840	105	210	10
February 2009	ST-3	2	19	ND	ND	ND
February 2009	ST-3	4	56	ND	14	ND
February 2009	ST-3	7	210	135	42	20
February 2009	ST-3	10	77	98	71	20
February 2009	ST-4	2	ND	ND	ND	ND
February 2009	ST-4	4	ND	ND	ND	ND
February 2009	ST-4	7	ND	ND	11	ND
February 2009	ST-4	10	ND	ND	19	ND
February 2009	ST-5	2	ND	Probe removed	ND	Probe removed
February 2009	ST-5	4	ND	Probe removed	ND	Probe removed
February 2009	ST-5	7	ND	Probe removed	ND	Probe removed
February 2009	ST-5	10	ND	Probe removed	ND	Probe removed
February 2009	ST-7	SS	4,500	NA	80	NA
February 2009	ST-7	2	44,000	26,000	1,000	570
February 2009	ST-7	4	85,000	110,000	2,300	3,000
February 2009	ST-7	7	130,000	75,000	4,300	2,600
February 2009	ST-7	10	150,000	47,000	5,000	1,900

Appendix E
Soil Vapor Sample Results Summary
($\mu\text{g}/\text{m}^3$)

Sampling Round	Location	Depth	Macro TCE	Micro TCE	Macro PCE	Micro PCE
February 2009	ST-8	SS	510	NA	ND	NA
February 2009	ST-8	2	7,700	2,300	150	41
February 2009	ST-8	4	26,000	7,100	400	73
February 2009	ST-8	7	27,000	7,900	450	110
February 2009	ST-8	10	34,000	11,000	570	190
February 2009	ST-9	2	ND	ND	ND	ND
February 2009	ST-9	4	ND	ND	15	ND
February 2009	ST-9	7	15	ND	23	10
February 2009	ST-9	10	165	16	47	ND
March 2009	ST-1	SS	270	NA	ND	NA
March 2009	ST-1	2	6,547	2,000	43	26
March 2009	ST-1	4	53,000	81,000	490	600
March 2009	ST-1	7	65,000	94,000	550	710
March 2009	ST-1	10	83,000	130,000	780	1,300
March 2009	ST-2	SS	17	NA	ND	NA
March 2009	ST-2	2	53	58	ND	ND
March 2009	ST-2	4	1,200	1,400	24	20
March 2009	ST-2	7	2,800	1,900	40	26
March 2009	ST-2	10	3,100	200	74	21
March 2009	ST-3	2	ND	13	ND	ND
March 2009	ST-3	4	32	ND	10	ND
March 2009	ST-3	7	110	100	22	12
March 2009	ST-3	10	38	110	33	22
March 2009	ST-4	2	ND	10	ND	ND
March 2009	ST-4	4	ND	ND	ND	ND
March 2009	ST-4	7	ND	ND	ND	ND
March 2009	ST-4	10	ND	12	11	ND
March 2009	ST-5	2	ND	Probe removed	ND	Probe removed
March 2009	ST-5	4	ND	Probe removed	ND	Probe removed
March 2009	ST-5	7	ND	Probe removed	ND	Probe removed
March 2009	ST-5	10	ND	Probe removed	ND	Probe removed
March 2009	ST-7	SS	6,100	NA	40	NA
March 2009	ST-7	2	69,000	55,000	640	540
March 2009	ST-7	4	130,000	200,000	1,200	2,200
March 2009	ST-7	7	136,000	150,000	1,500	1,600
March 2009	ST-7	10	126,000	79,000	1,400	1,000
March 2009	ST-8	SS	557	NA	ND	NA
March 2009	ST-8	2	12,000	3,000	110	28
March 2009	ST-8	4	28,000	9,300	200	54
March 2009	ST-8	7	33,000	21,000	280	110
March 2009	ST-8	10	34,000	20,000	160	160
March 2009	ST-9	2	ND	14	ND	ND
March 2009	ST-9	4	ND	ND	ND	ND
March 2009	ST-9	7	ND	25	11	7
March 2009	ST-9	10	75	30	20	ND
April 2009	ST-1	SS	370	NA	ND	NA
April 2009	ST-1	2	24000	NO SAMPLE	350	NO SAMPLE
April 2009	ST-1	4	53000	72000	670	1100
April 2009	ST-1	7	74000	83000	1000	1300
April 2009	ST-1	10	76000	51000	1100	2600
April 2009	ST-2	SS	ND	NA	ND	NA
April 2009	ST-2	2	NO SAMPLE	76	NO SAMPLE	17
April 2009	ST-2	4	1900	1800	53	19
April 2009	ST-2	7	3500	2000	78	27
April 2009	ST-2	10	3200	1000	93	24
April 2009	ST-3	2	32	ND	ND	ND
April 2009	ST-3	4	84	ND	15	ND
April 2009	ST-3	7	290	140	32	15
April 2009	ST-3	10	87	80	46	20
April 2009	ST-4	2	ND	ND	ND	ND
April 2009	ST-4	4	ND	ND	10	ND
April 2009	ST-4	7	ND	ND	ND	ND
April 2009	ST-4	10	ND	11	11	ND
April 2009	ST-5	2	ND	Probe removed	ND	Probe removed
April 2009	ST-5	4	ND	Probe removed	ND	Probe removed
April 2009	ST-5	7	ND	Probe removed	ND	Probe removed
April 2009	ST-5	10	ND	Probe removed	ND	Probe removed

Appendix E
Soil Vapor Sample Results Summary
($\mu\text{g}/\text{m}^3$)

Sampling Round	Location	Depth	Macro TCE	Micro TCE	Macro PCE	Micro PCE
April 2009	ST-7	SS	8300	NA	140	NA
April 2009	ST-7	2	110000	65000	1700	1100
April 2009	ST-7	4	212000	190000	3500	4000
April 2009	ST-7	7	210000	160000	3900	3100
April 2009	ST-7	10	210000	22000	3900	880
April 2009	ST-8	SS	850	NA	13	NA
April 2009	ST-8	2	17000	5000	290	49
April 2009	ST-8	4	39000	16000	510	120
April 2009	ST-8	7	38000	18000	500	220
April 2009	ST-8	10	41000	12000	570	170
April 2009	ST-9	2	ND	ND	ND	ND
April 2009	ST-9	4	13	ND	13	ND
April 2009	ST-9	7	10	ND	16	ND
April 2009	ST-9	10	110	14	27	ND
May 2009	ST-1	SS	500	NA	23	NA
May 2009	ST-1	2	NO SAMPLE	NO SAMPLE	NO SAMPLE	NO SAMPLE
May 2009	ST-1	4	41000	52000	860	1500
May 2009	ST-1	7	63000	NO SAMPLE	1700	NO SAMPLE
May 2009	ST-1	10	66000	47000	1800	1600
May 2009	ST-2	SS	62	NA	ND	NA
May 2009	ST-2	2	NO SAMPLE	860	NO SAMPLE	56
May 2009	ST-2	4	2500	2800	130	110
May 2009	ST-2	7	4000	2800	170	97
May 2009	ST-2	10	3400	1300	210	81
May 2009	ST-3	2	48	13	10	12
May 2009	ST-3	4	200	ND	47	ND
May 2009	ST-3	7	700	300	88	36
May 2009	ST-3	10	280	99	110	22
May 2009	ST-4	2	ND	ND	ND	13
May 2009	ST-4	4	ND	ND	15	13
May 2009	ST-4	7	ND	ND	19	ND
May 2009	ST-4	10	ND	11	24	13
May 2009	ST-5	2	ND	Probe removed	ND	Probe removed
May 2009	ST-5	4	ND	Probe removed	ND	Probe removed
May 2009	ST-5	7	ND	Probe removed	ND	Probe removed
May 2009	ST-5	10	ND	Probe removed	ND	Probe removed
May 2009	ST-7	SS	4000	NA	130	NA
May 2009	ST-7	2	120000	66000	4000	2200
May 2009	ST-7	4	230000	190000	7400	6600
May 2009	ST-7	7	220000	160000	8000	5600
May 2009	ST-7	10	220000	46000	7700	2000
May 2009	ST-8	SS	740	NA	24	NA
May 2009	ST-8	2	4700	5000	160	140
May 2009	ST-8	4	32000	7500	830	110
May 2009	ST-8	7	34000	15000	850	390
May 2009	ST-8	10	31000	7800	820	250
May 2009	ST-9	2	23	ND	34	ND
May 2009	ST-9	4	24	ND	25	11
May 2009	ST-9	7	21	10	42	12
May 2009	ST-9	10	280	ND	71	ND
June 2009	ST-1	SS	370	NA	ND	NA
June 2009	ST-1	2	NO SAMPLE	NO SAMPLE	NO SAMPLE	NO SAMPLE
June 2009	ST-1	4	NO SAMPLE	30,000	NO SAMPLE	1,000
June 2009	ST-1	7	67,000	27,000	2,300	900
June 2009	ST-1	10	78,000	25,000	2,500	700
June 2009	ST-2	SS	20	NA	ND	NA
June 2009	ST-2	2	NO SAMPLE	810	NO SAMPLE	86
June 2009	ST-2	4	1,800	2,700	110	140
June 2009	ST-2	7	3,100	1,800	160	87
June 2009	ST-2	10	2,400	1,100	150	70
June 2009	ST-3	2	130	48	18	15
June 2009	ST-3	4	300	NO SAMPLE	42	NO SAMPLE
June 2009	ST-3	7	520	480	58	45
June 2009	ST-3	10	350	290	83	39
June 2009	ST-4	2	ND	ND	ND	ND
June 2009	ST-4	4	ND	ND	14	ND
June 2009	ST-4	7	ND	ND	18	ND
June 2009	ST-4	10	ND	ND	18	ND

Appendix E
Soil Vapor Sample Results Summary
($\mu\text{g}/\text{m}^3$)

Sampling Round	Location	Depth	Macro TCE	Micro TCE	Macro PCE	Micro PCE
June 2009	ST-5	2	ND	Probe removed	ND	Probe removed
June 2009	ST-5	4	ND	Probe removed	ND	Probe removed
June 2009	ST-5	7	ND	Probe removed	ND	Probe removed
June 2009	ST-5	10	ND	Probe removed	ND	Probe removed
June 2009	ST-7	SS	3,400	NA	97	NA
June 2009	ST-7	2	100,000	28,000	4,900	1,200
June 2009	ST-7	4	180,000	82,000	8,400	3,600
June 2009	ST-7	7	190,000	49,000	8,900	1,900
June 2009	ST-7	10	170000	6,800	6,600	340
June 2009	ST-8	SS	460	NA	16	NA
June 2009	ST-8	2	16,000	4,800	690	140
June 2009	ST-8	4	34,000	8,500	1,200	140
June 2009	ST-8	7	33,000	7,300	1,100	190
June 2009	ST-8	10	35,000	2,800	1,100	83
June 2009	ST-9	2	23	ND	21	21
June 2009	ST-9	4	35	26	31	27
June 2009	ST-9	7	24	19	33	25
June 2009	ST-9	10	260	30	44	19
July 2009	ST-1	SS	400	NA	17	NA
July 2009	ST-1	2	NO SAMPLE	NO SAMPLE	NO SAMPLE	NO SAMPLE
July 2009	ST-1	4	NO SAMPLE	40,000	NO SAMPLE	1,500
July 2009	ST-1	7	NO SAMPLE	34,000	NO SAMPLE	1,200
July 2009	ST-1	10	95,000	26,000	3,104	920
July 2009	ST-2	SS	83	NA	ND	NA
July 2009	ST-2	2	NO SAMPLE	2,000	NO SAMPLE	170
July 2009	ST-2	4	NO SAMPLE	5,300	NO SAMPLE	440
July 2009	ST-2	7	5,800	3,700	460	200
July 2009	ST-2	10	4,000	2,600	230	160
July 2009	ST-3	2	100	59	28	11
July 2009	ST-3	4	24	ND	ND	ND
July 2009	ST-3	7	1,100	960	150	106
July 2009	ST-3	10	600	560	150	120
July 2009	ST-4	2	ND	Probe removed	ND	Probe removed
July 2009	ST-4	4	ND	Probe removed	ND	Probe removed
July 2009	ST-4	7	ND	Probe removed	24	Probe removed
July 2009	ST-4	10	ND	Probe removed	30	Probe removed
July 2009	ST-5	2	ND	Probe removed	ND	Probe removed
July 2009	ST-5	4	NO SAMPLE	Probe removed	NO SAMPLE	Probe removed
July 2009	ST-5	7	ND	Probe removed	ND	Probe removed
July 2009	ST-5	10	ND	Probe removed	ND	Probe removed
July 2009	ST-7	SS	114	NA	ND	NA
July 2009	ST-7	2	NO SAMPLE	31,000	NO SAMPLE	1,600
July 2009	ST-7	4	230,000	103,000	8,600	4,600
July 2009	ST-7	7	270,000	66,000	10,000	2,700
July 2009	ST-7	10	300,000	20,000	11,000	970
July 2009	ST-8	SS	690	NA	25	NA
July 2009	ST-8	2	18,000	15,000	750	600
July 2009	ST-8	4	48,000	5,000	1,600	130
July 2009	ST-8	7	50,000	8,500	1,600	300
July 2009	ST-8	10	46,000	7,000	1,400	280
July 2009	ST-9	2	ND	ND	29	ND
July 2009	ST-9	4	47	29	52	30
July 2009	ST-9	7	44	25	73	28
July 2009	ST-9	10	206	75*	82	29*
August 2009	ST-1	SS	300	NA	15	NA
August 2009	ST-1	2	NO SAMPLE	NO SAMPLE	NO SAMPLE	NO SAMPLE
August 2009	ST-1	4	NO SAMPLE	34,000	NO SAMPLE	1,400
August 2009	ST-1	7	NO SAMPLE	27,000	NO SAMPLE	1,000
August 2009	ST-1	10	NO SAMPLE	24,000	NO SAMPLE	880
August 2009	ST-2	SS	43	NA	ND	NA
August 2009	ST-2	2	NO SAMPLE	1,500	NO SAMPLE	120
August 2009	ST-2	4	NO SAMPLE	4,000	NO SAMPLE	160
August 2009	ST-2	7	4,500	4,100	250	160
August 2009	ST-2	10	3,900	1,400	250	92
August 2009	ST-3	2	150	72	33	22
August 2009	ST-3	4	12	NO SAMPLE	ND	NO SAMPLE
August 2009	ST-3	7	1,030	1,040	140	104
August 2009	ST-3	10	530	540	140	90

Appendix E
Soil Vapor Sample Results Summary
($\mu\text{g}/\text{m}^3$)

Sampling Round	Location	Depth	Macro TCE	Micro TCE	Macro PCE	Micro PCE
August 2009	ST-4	2	NO SAMPLE	Probe removed	NO SAMPLE	Probe removed
August 2009	ST-4	4	NO SAMPLE	Probe removed	NO SAMPLE	Probe removed
August 2009	ST-4	7	11	Probe removed	35	Probe removed
August 2009	ST-4	10	14	Probe removed	41	Probe removed
August 2009	ST-5	2	ND	Probe removed	ND	Probe removed
August 2009	ST-5	4	NO SAMPLE	Probe removed	NO SAMPLE	Probe removed
August 2009	ST-5	7	ND	Probe removed	ND	Probe removed
August 2009	ST-5	10	ND	Probe removed	ND	Probe removed
August 2009	ST-7	SS	NO SAMPLE	NA	NO SAMPLE	NA
August 2009	ST-7	2	NO SAMPLE	30,000	NO SAMPLE	1,500
August 2009	ST-7	4	180,000	77,000	8,000	3,800
August 2009	ST-7	7	230,000	54,000	11,000	2,400
August 2009	ST-7	10	220,000	23,000	10,000	1,200
August 2009	ST-8	SS	440	NA	20	NA
August 2009	ST-8	2	11,000	11,000	500	560
August 2009	ST-8	4	35,000	4,000	1,400	130
August 2009	ST-8	7	42,000	7,400	1,500	300
August 2009	ST-8	10	39,000	4,500	1,300	180
August 2009	ST-9	2	24	ND	31	19
August 2009	ST-9	4	63	21	61	34
August 2009	ST-9	7	31	44	70	50
August 2009	ST-9	10	290	76	73	36
September 2009	ST-1	SS	1,200	NA	21	NA
September 2009	ST-1	2	NO SAMPLE	NO SAMPLE	NO SAMPLE	NO SAMPLE
September 2009	ST-1	4	NO SAMPLE	82,000	NO SAMPLE	1,700
September 2009	ST-1	7	NO SAMPLE	89,000	NO SAMPLE	1,900
September 2009	ST-1	10	NO SAMPLE	76,000	NO SAMPLE	1,500
September 2009	ST-2	SS	36	NA	ND	NA
September 2009	ST-2	2	NO SAMPLE	6,100	NO SAMPLE	300
September 2009	ST-2	4	NO SAMPLE	13,000	NO SAMPLE	430
September 2009	ST-2	7	NO SAMPLE	8,300	NO SAMPLE	690
September 2009	ST-2	10	21,000	4,300	820	190
September 2009	ST-3	2	430	750	40	26
September 2009	ST-3	4	NO SAMPLE	NO SAMPLE	NO SAMPLE	NO SAMPLE
September 2009	ST-3	7	NO SAMPLE	3,000	NO SAMPLE	170
September 2009	ST-3	10	2,000	3,000	240	300
September 2009	ST-4	2	ND	Probe removed	ND	Probe removed
September 2009	ST-4	4	ND	Probe removed	ND	Probe removed
September 2009	ST-4	7	15	Probe removed	42	Probe removed
September 2009	ST-4	10	24	Probe removed	54	Probe removed
September 2009	ST-5	2	ND	Probe removed	ND	Probe removed
September 2009	ST-5	4	ND	Probe removed	ND	Probe removed
September 2009	ST-5	7	ND	Probe removed	ND	Probe removed
September 2009	ST-5	10	ND	Probe removed	ND	Probe removed
September 2009	ST-7	SS	NO SAMPLE	NA	NO SAMPLE	NA
September 2009	ST-7	2	NO SAMPLE	100,000	NO SAMPLE	2,900
September 2009	ST-7	4	NO SAMPLE	240,000	NO SAMPLE	6,800
September 2009	ST-7	7	710,000	180,000	20,000	4,700
September 2009	ST-7	10	680,000	120,000	18,000	3,200
September 2009	ST-8	SS	NO SAMPLE	NA	NO SAMPLE	NA
September 2009	ST-8	2	36,000	16,000	870	400
September 2009	ST-8	4	110,000	12,000	2,500	200
September 2009	ST-8	7	110,000	32,000	2,600	720
September 2009	ST-8	10	110,000	25,000	2,300	540
September 2009	ST-9	2	33	ND	34	15
September 2009	ST-9	4	120	29	91	35
September 2009	ST-9	7	150	24	110	19
September 2009	ST-9	10	790	150	130	44
October 2009	ST-1	SS	2,100	NA	37	NA
October 2009	ST-1	2	NO SAMPLE	NO SAMPLE	NO SAMPLE	NO SAMPLE
October 2009	ST-1	4	NO SAMPLE	40,000	NO SAMPLE	940
October 2009	ST-1	7	NO SAMPLE	42,000	NO SAMPLE	1,000
October 2009	ST-1	10	NO SAMPLE	41,000	NO SAMPLE	940
October 2009	ST-2	SS	1,100	NA	24	NA
October 2009	ST-2	2	NO SAMPLE	1,700	NO SAMPLE	80
October 2009	ST-2	4	NO SAMPLE	4,200	NO SAMPLE	160
October 2009	ST-2	7	NO SAMPLE	4,200	NO SAMPLE	160
October 2009	ST-2	10	5,800	2,200	320	100

Appendix E
Soil Vapor Sample Results Summary
($\mu\text{g}/\text{m}^3$)

Sampling Round	Location	Depth	Macro TCE	Micro TCE	Macro PCE	Micro PCE
October 2009	ST-3	2	120	150	12	21
October 2009	ST-3	4	NO SAMPLE	NO SAMPLE	NO SAMPLE	NO SAMPLE
October 2009	ST-3	7	NO SAMPLE	14,00	NO SAMPLE	84
October 2009	ST-3	10	1,100	790	170	90
October 2009	ST-4	2	NO SAMPLE	NO PROBE	NO SAMPLE	NO PROBE
October 2009	ST-4	4	ND	NO PROBE	ND	NO PROBE
October 2009	ST-4	7	NO SAMPLE	NO PROBE	NO SAMPLE	NO PROBE
October 2009	ST-4	10	24	NO PROBE	41	NO PROBE
October 2009	ST-5	2	ND	Probe removed	ND	Probe removed
October 2009	ST-5	4	NO SAMPLE	Probe removed	NO SAMPLE	Probe removed
October 2009	ST-5	7	NO SAMPLE	Probe removed	NO SAMPLE	Probe removed
October 2009	ST-5	10	ND	Probe removed	ND	Probe removed
October 2009	ST-7	SS	NO SAMPLE	NA	NO SAMPLE	NA
October 2009	ST-7	2	NO SAMPLE	40,000	NO SAMPLE	1,100
October 2009	ST-7	4	NO SAMPLE	95,000	NO SAMPLE	2,600
October 2009	ST-7	7	300,000	82,000	11,000	2,200
October 2009	ST-7	10	330,000	50,000	12,000	1,600
October 2009	ST-8	SS	NO SAMPLE	NA	NO SAMPLE	NA
October 2009	ST-8	2	19,000	7,900	530	220
October 2009	ST-8	4	41,000	14,000	1,200	250
October 2009	ST-8	7	48,000	15,000	1,500	350
October 2009	ST-8	10	51,000	12,000	1,400	290
October 2009	ST-9	2	52	ND	34	22
October 2009	ST-9	4	93	NO SAMPLE	49	NO SAMPLE
October 2009	ST-9	7	160	51	54	39
October 2009	ST-9	10	360	100	68	32

Definitions:

- $\mu\text{g}/\text{m}^3$ - micrograms per cubic meter
- NA - not applicable (no sub-slab micro-purge probes)
- ND - not detected
- PCE - tetrachloroethene
- SS - sub-slab
- TCE - trichloroethene

Appendix F
Soil Vapor Profiles

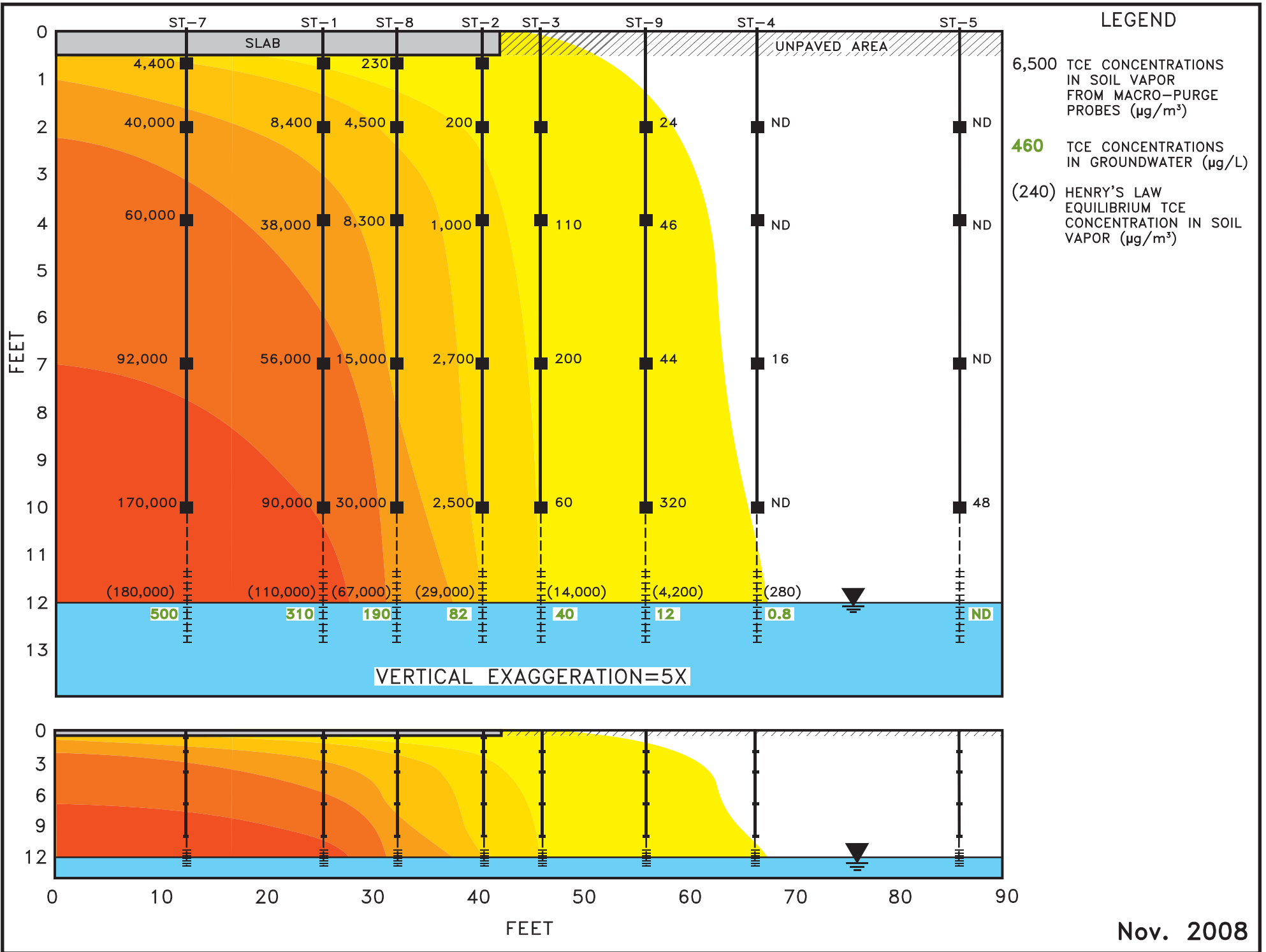

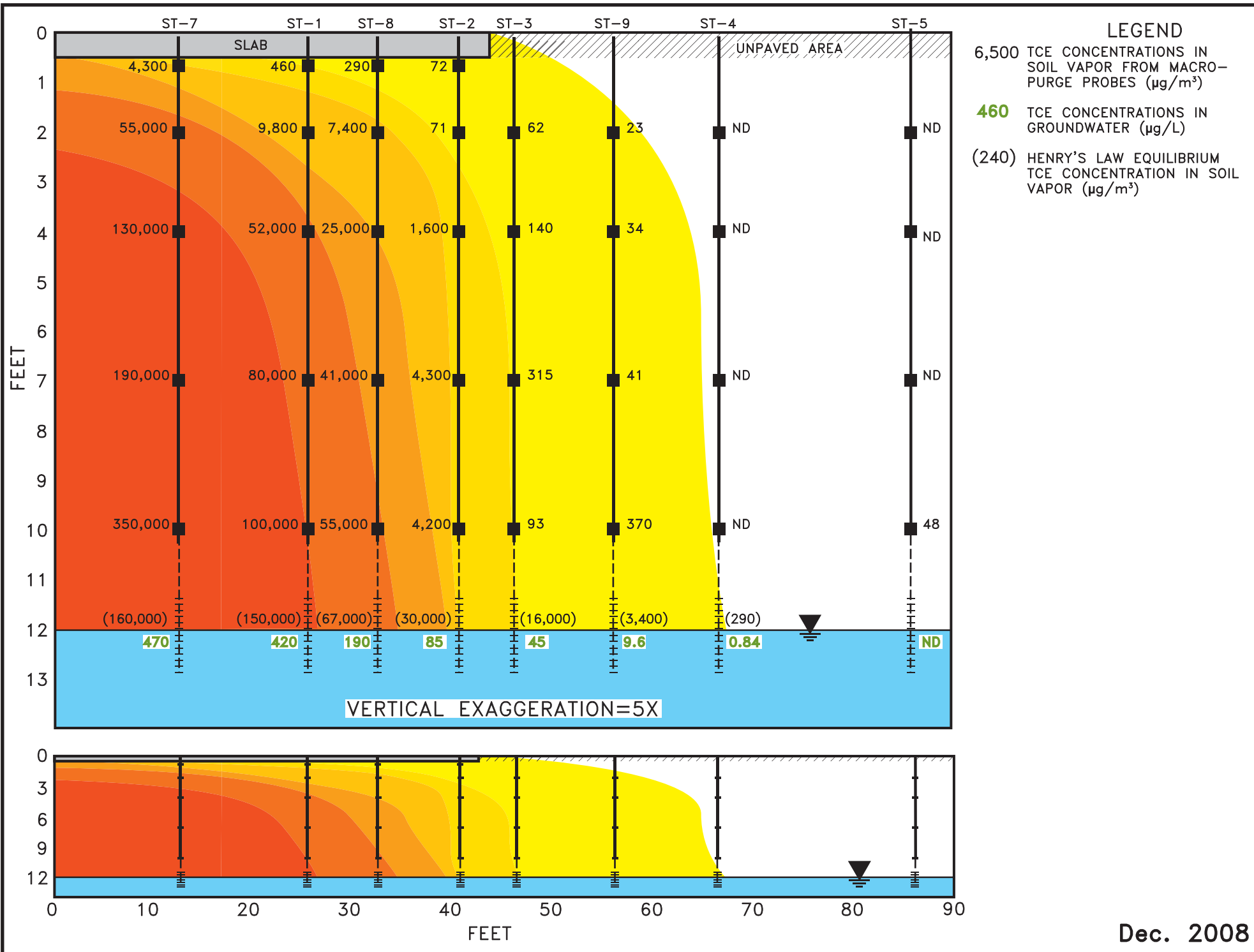

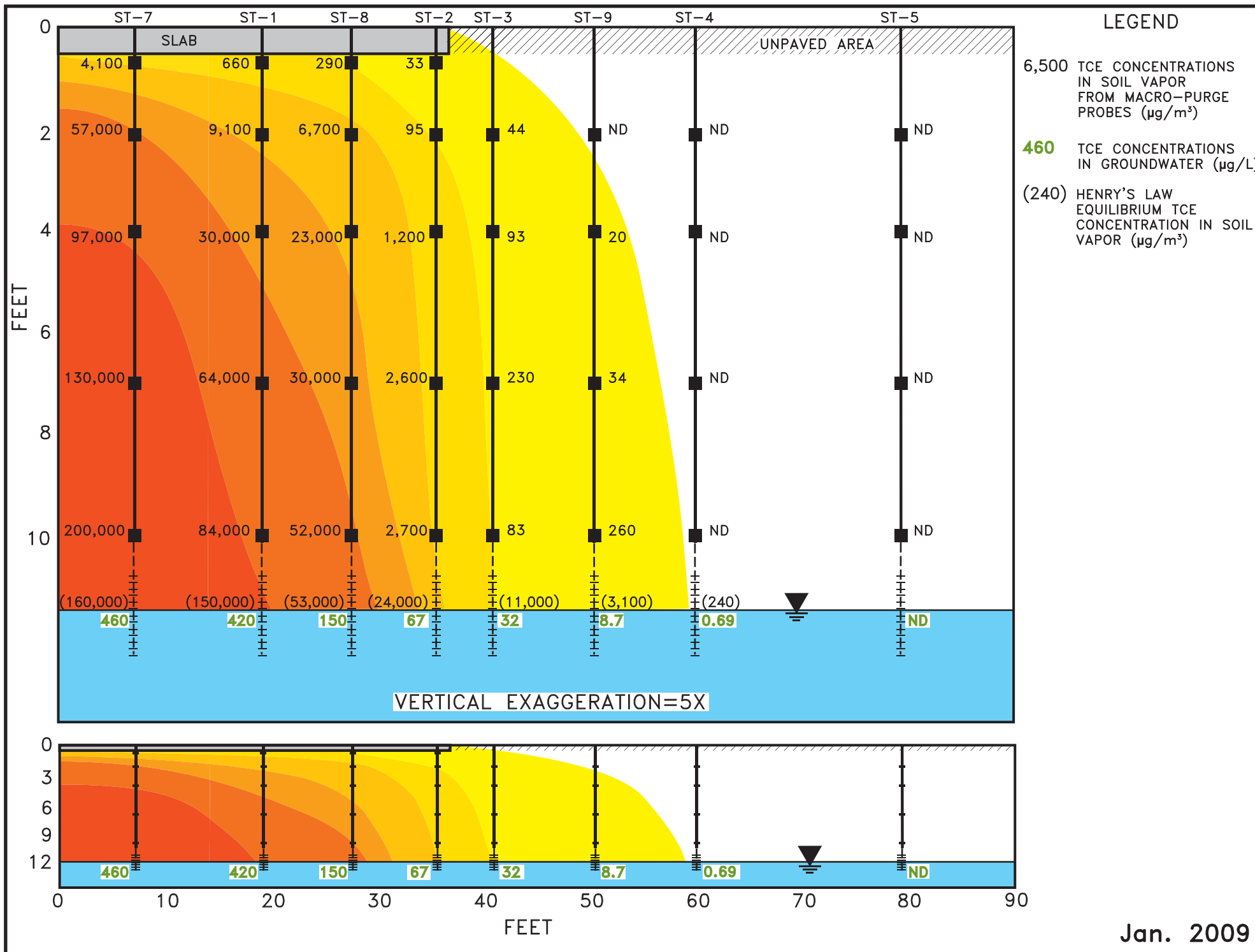

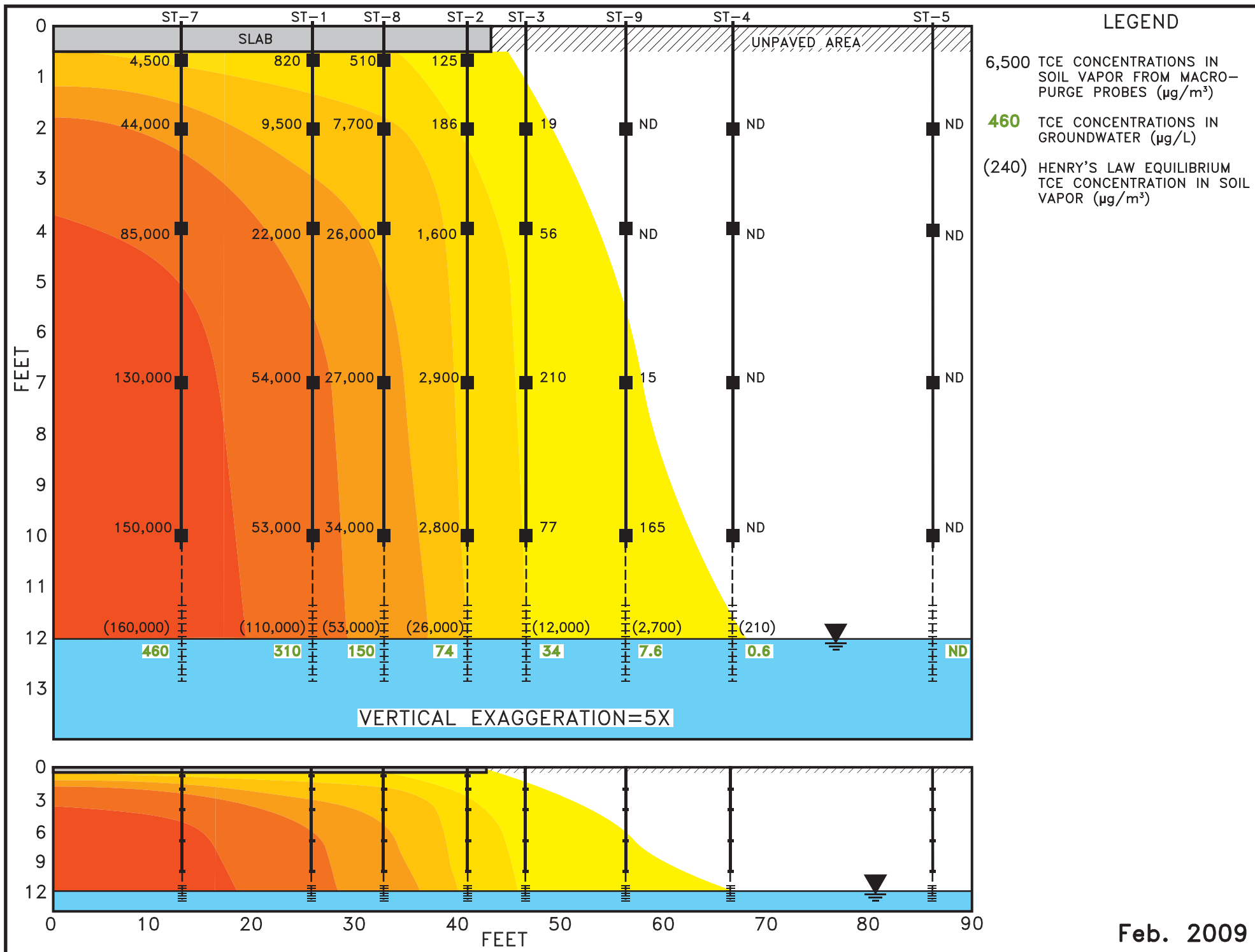

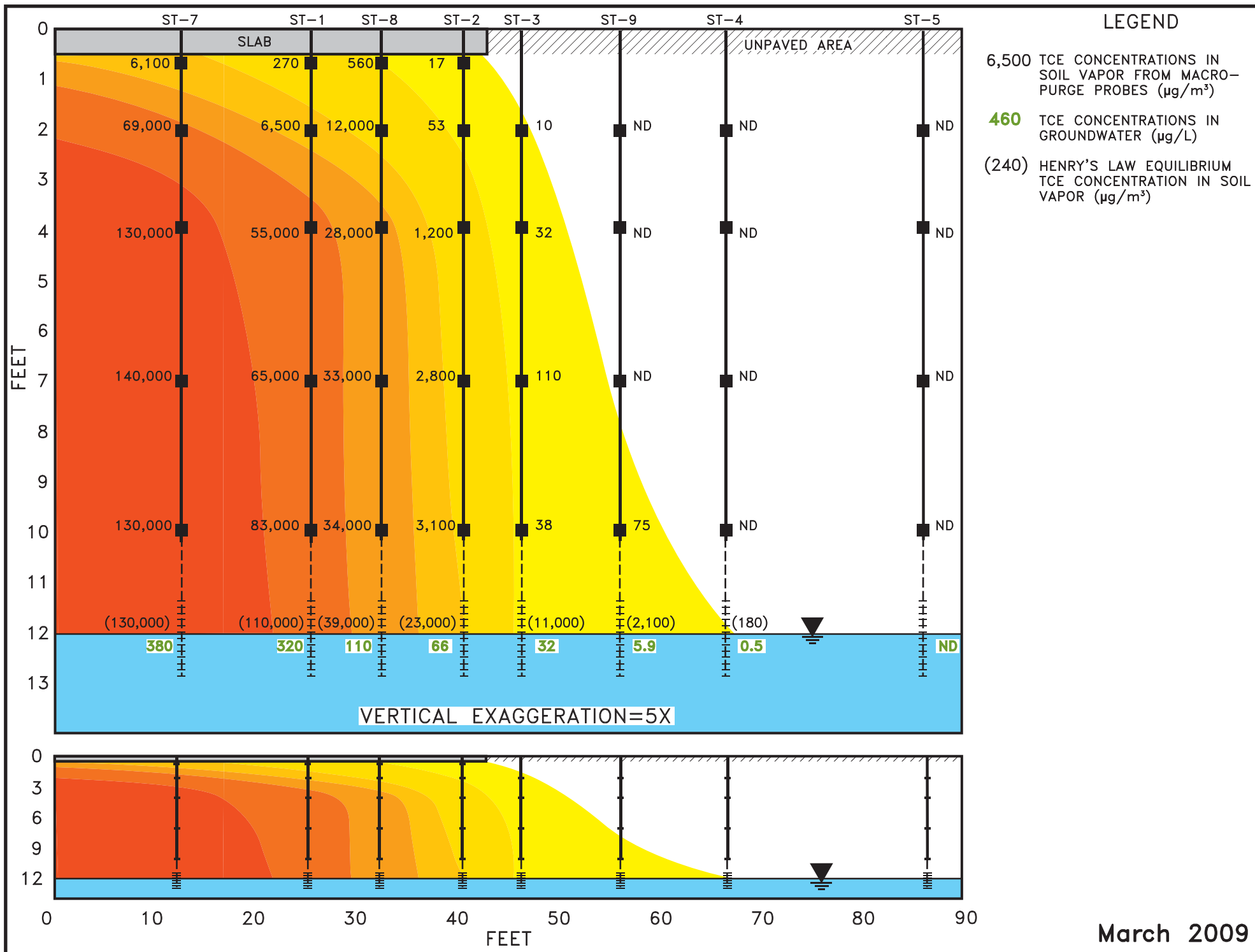

March 2009

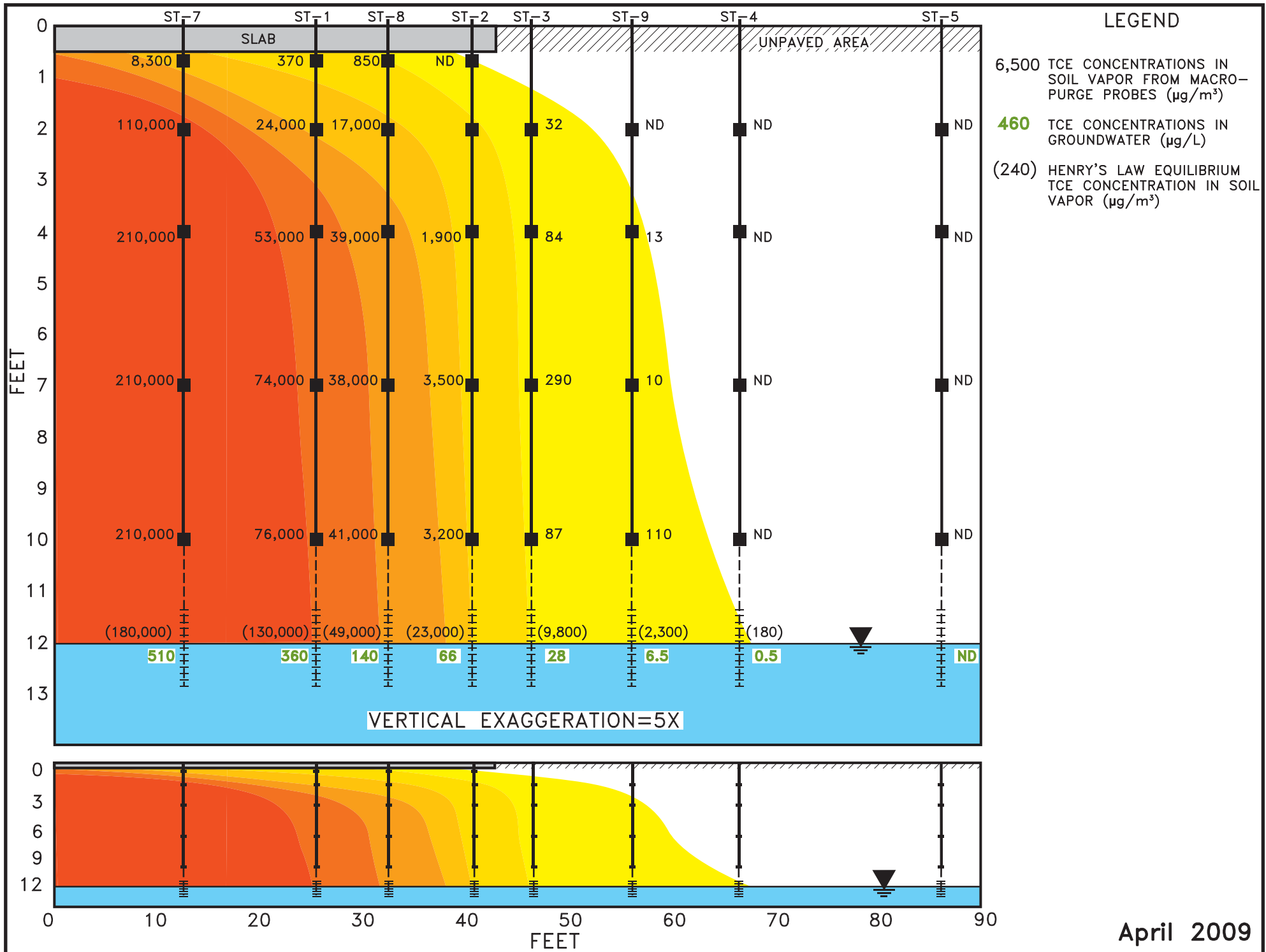

April 2009

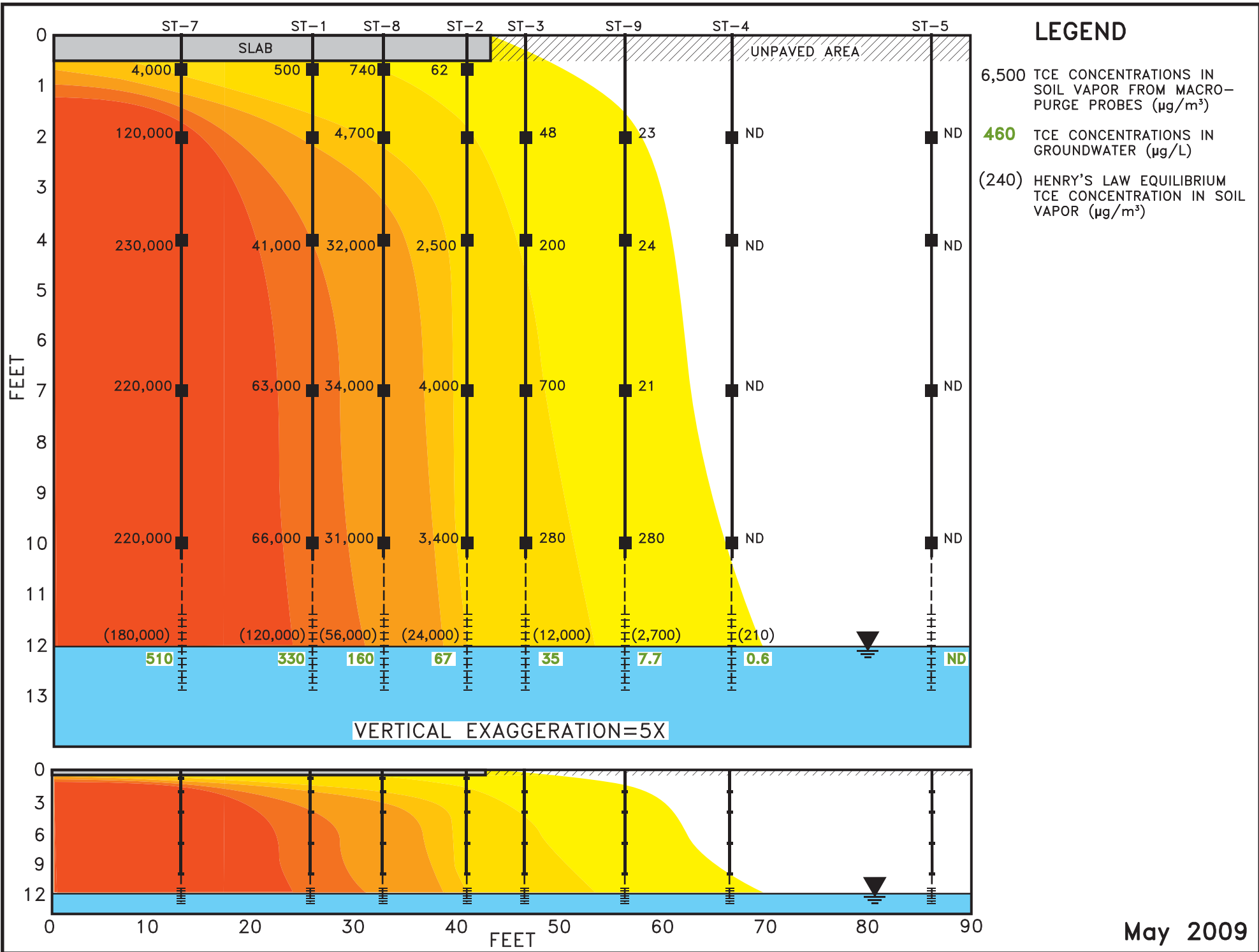

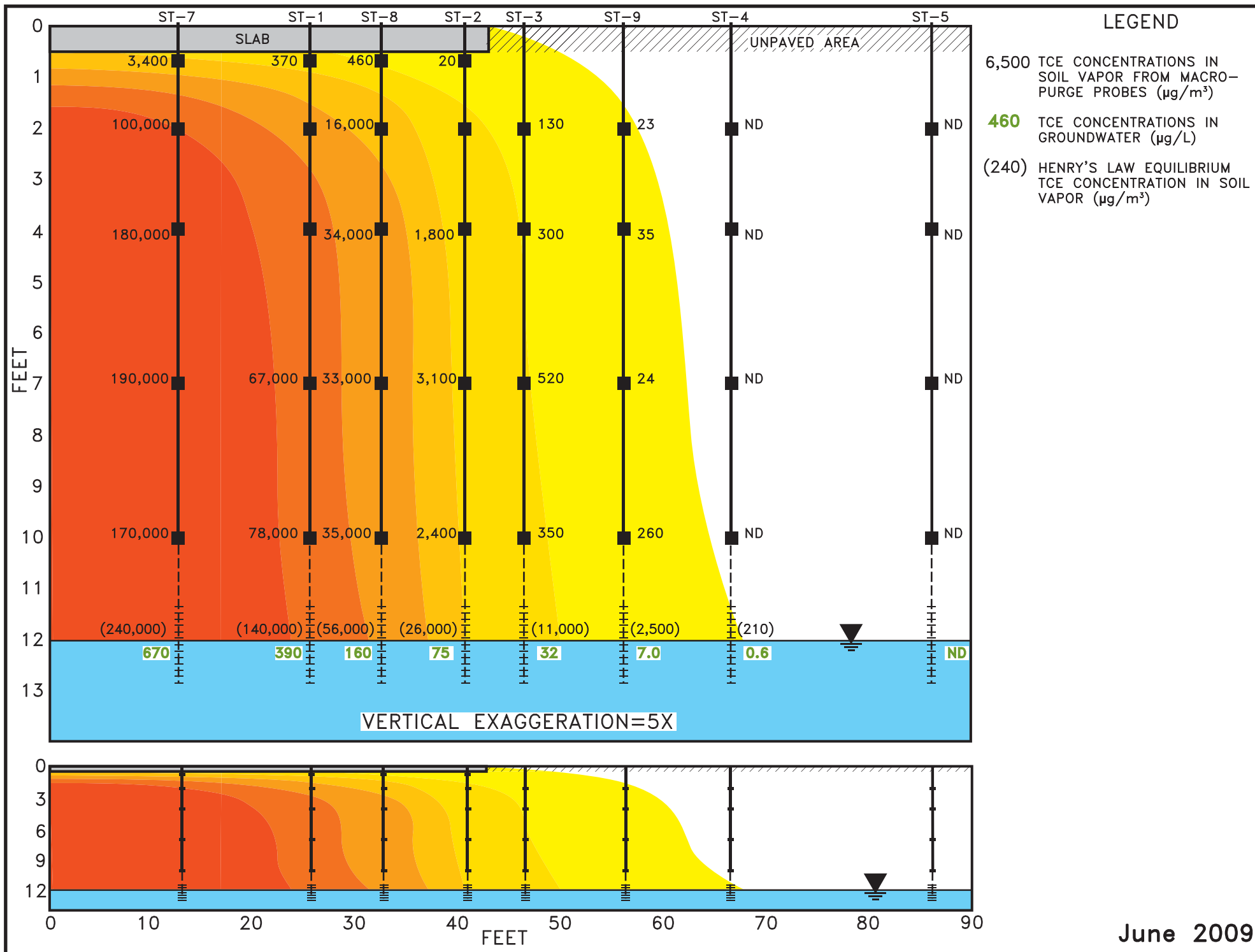

June 2009

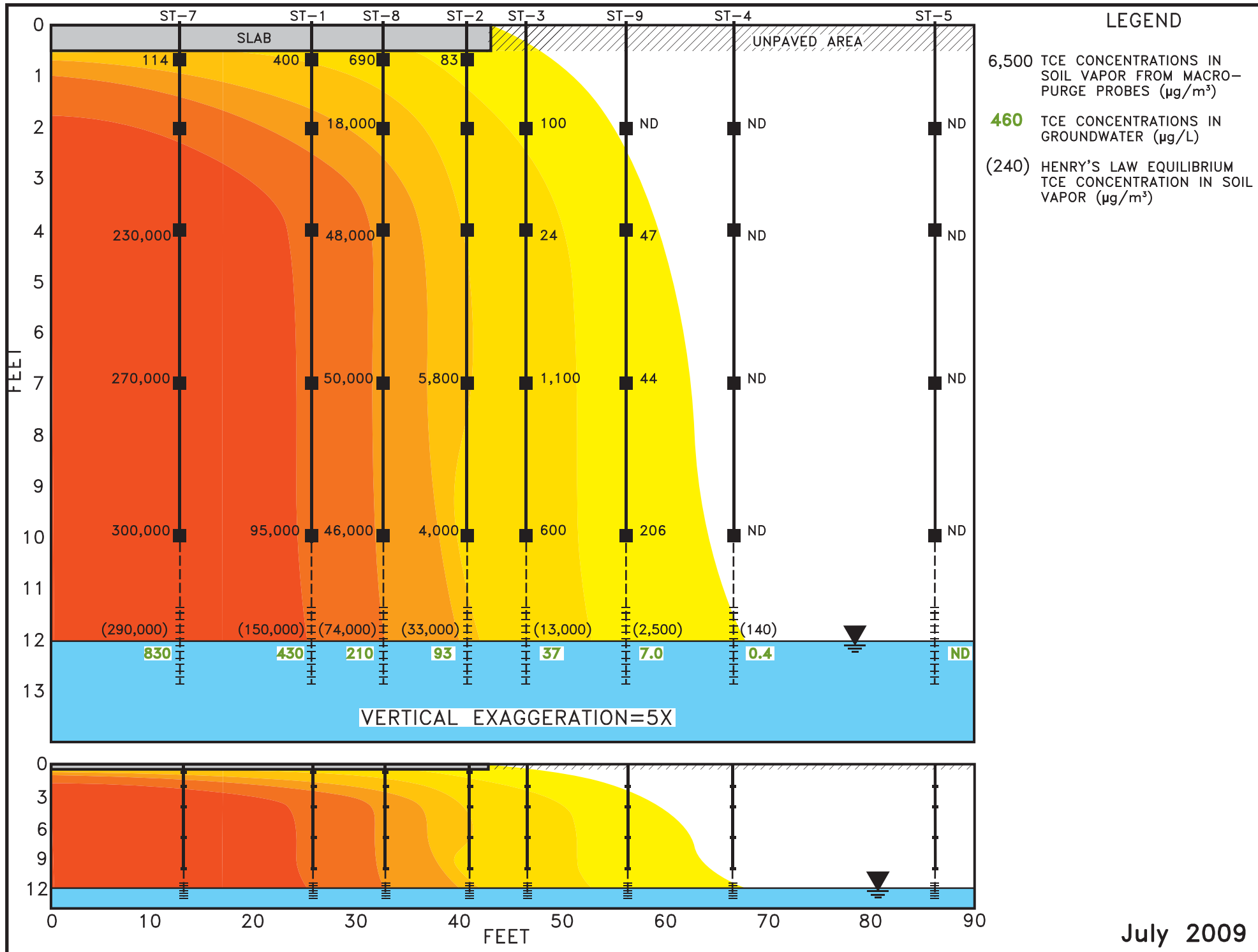

July 2009

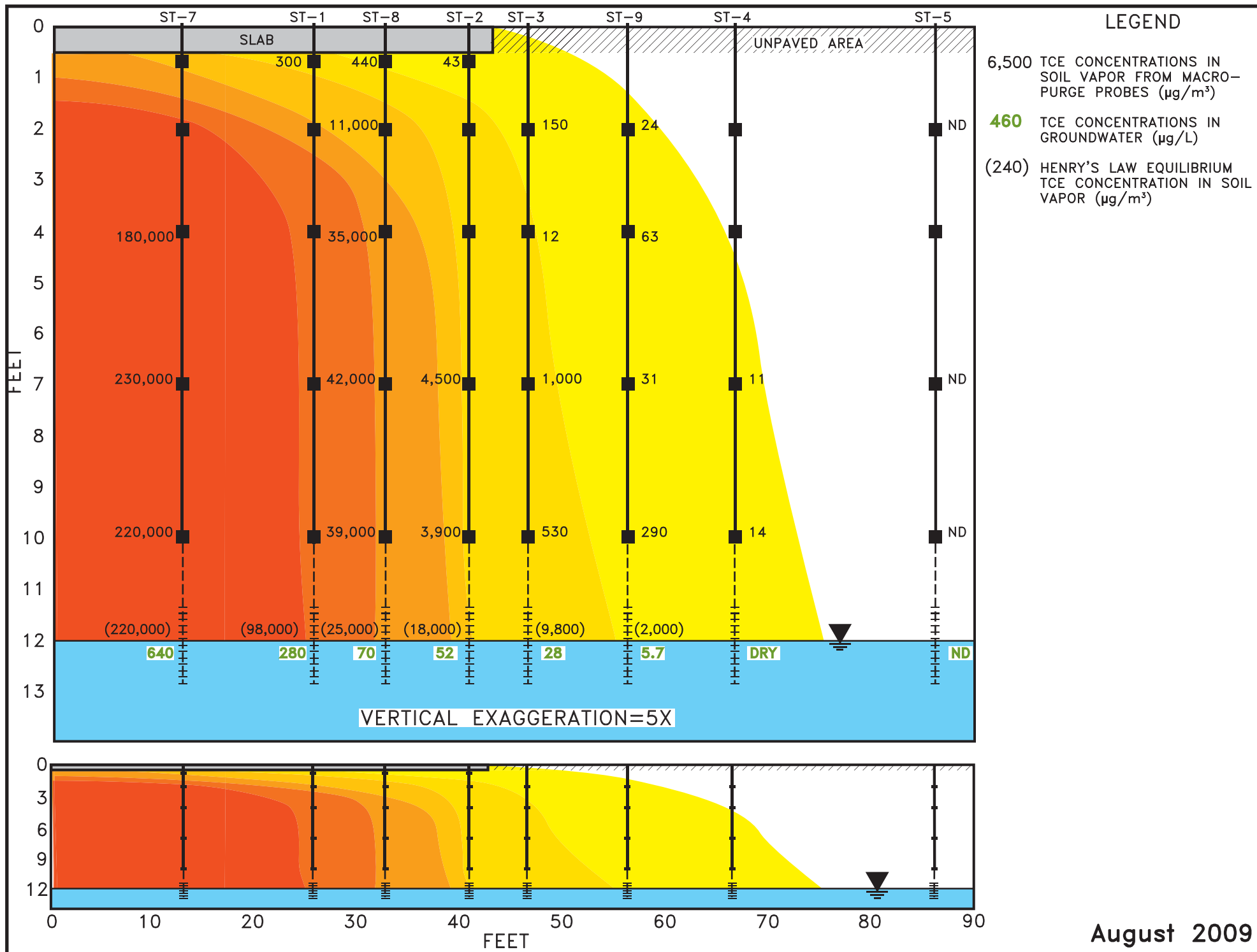

Appendix G
Statistical Analyses

Appendix G
EPA STREAMS TO-85
Statistical Analyses of Micro-Purge versus Macro-Purge Data

Percent of Macro-purge measurements measured at each station that exceed the Micro-purge measurements by more than a factor of two are listed below.

Location	Ratio	Percentage
ST-1	6/24	25
ST-2	13/35	37
ST-3	12/30	40
ST-7	23/42	55
ST-8	41/48	85
ST-9	17/27	63

The expectation is that the micro-purge versus macro-purge data will exhibit a 1:1 correlation, and they should be best described by a linear regression. However, it was found that the power-law equations provided the best fit to the measurement data: $Y = a \times X^b$, where Y = Micro-purge measurement of TCE ($\mu\text{g}/\text{m}^3$) and X = Macro-purge measurement of TCE ($\mu\text{g}/\text{m}^3$). Note that on a Log-Log plot, the power-law equation reduces to a linear expression, where $\text{Ln } Y = a + b \text{Ln } X$. The values of the fitted coefficients and the resultant R-square values are listed on each figure shown.

Data grouped by depth using the power-law model $Y = a \times X^b$

The upper and lower lines represent the 95% confidence interval about the fitted power-law curve.

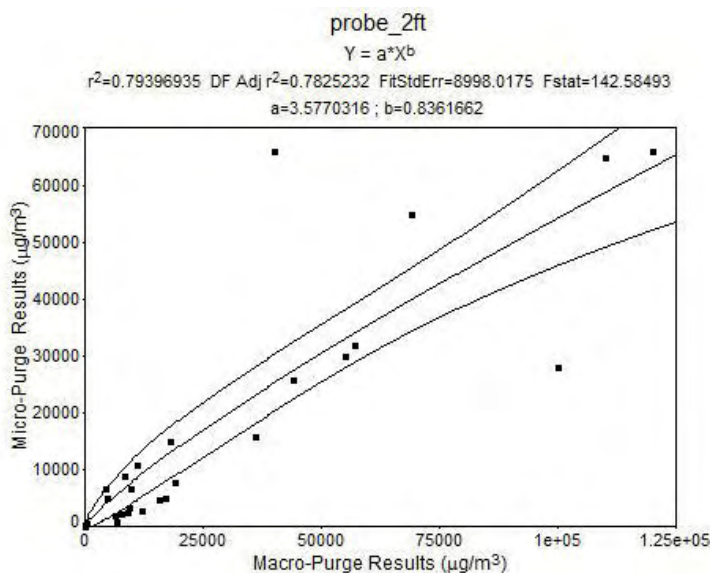

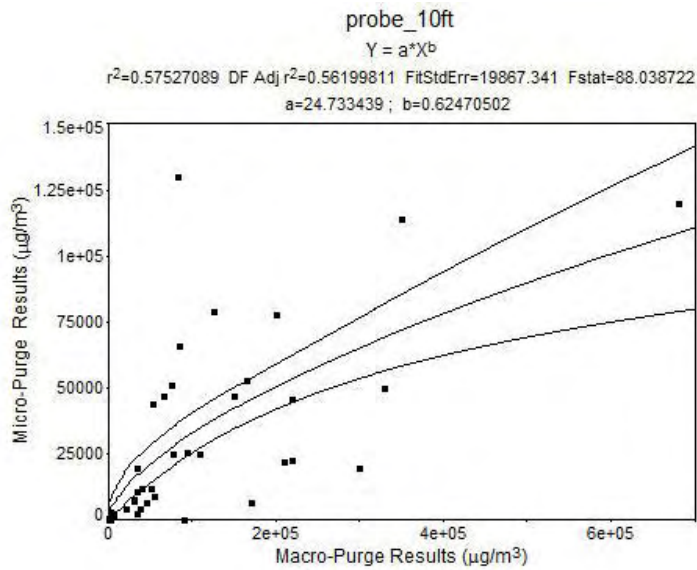
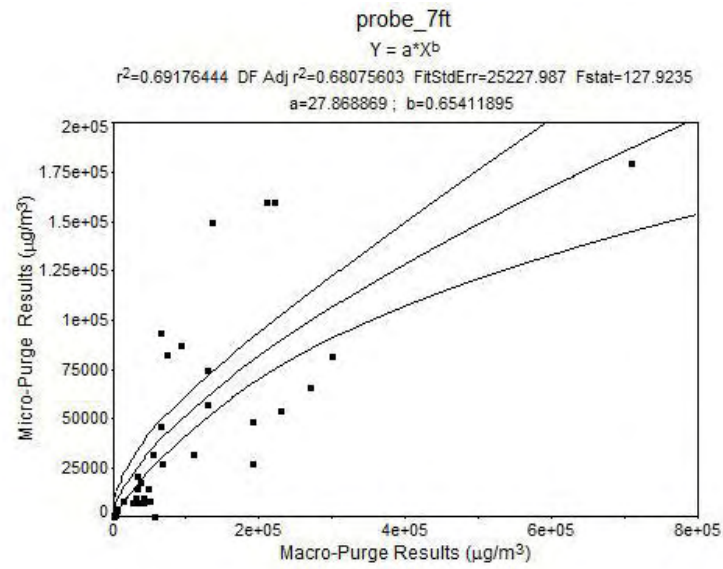
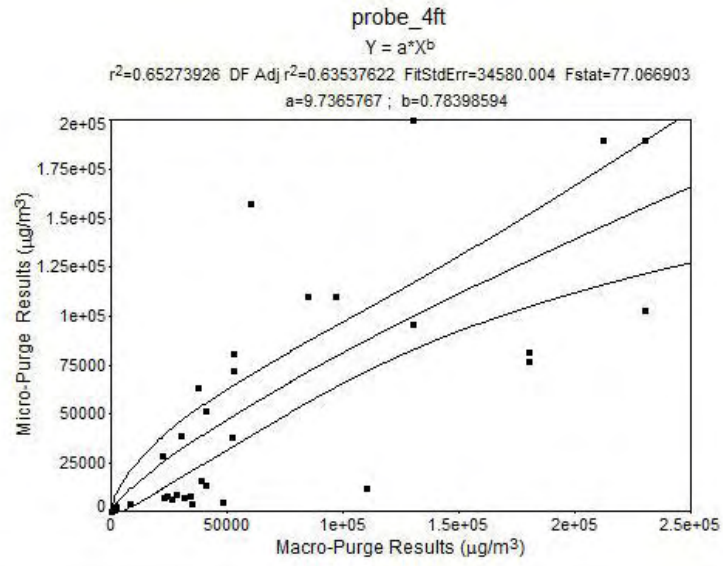

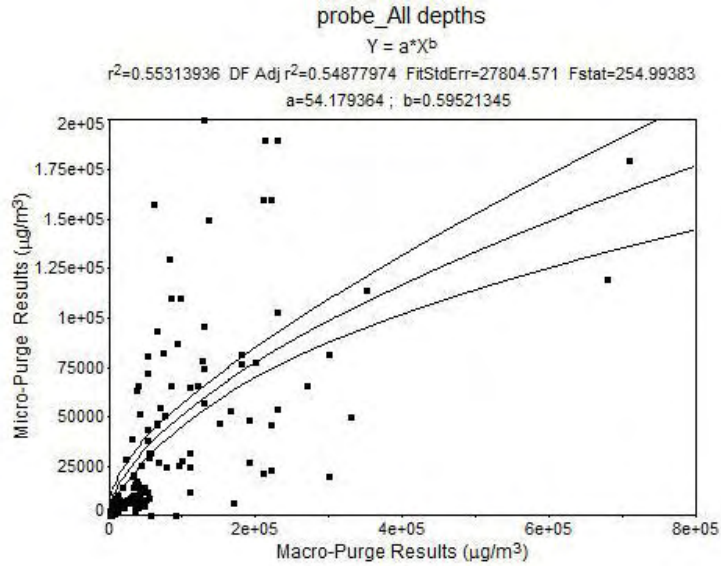

Data grouped by month using the power-law model $Y = a \times X^b$

Note that September, October, and November are fitted with a linear regression model $Y = a + bX$ since the power-law model failed to converge. The upper and lower lines represent the 95% confidence interval about the fitted power-law curve.

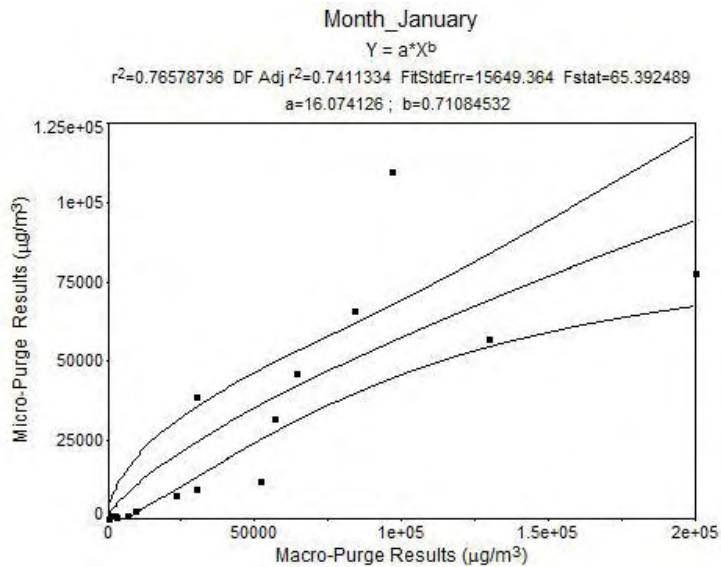

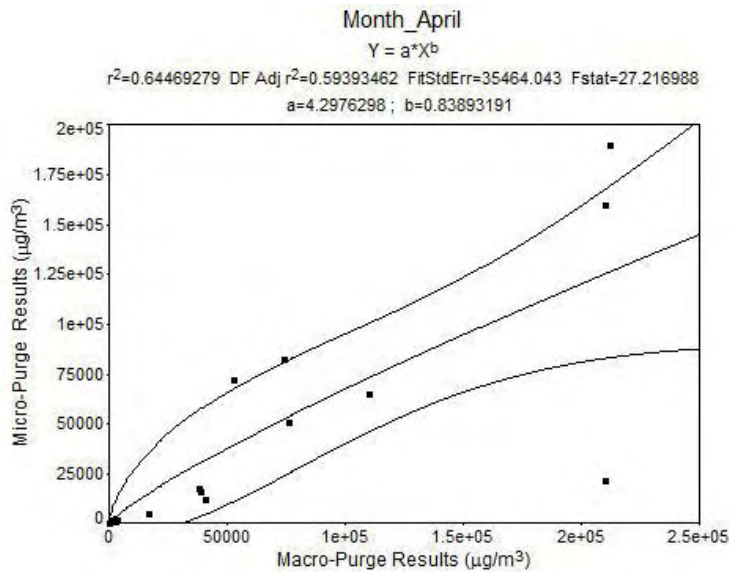
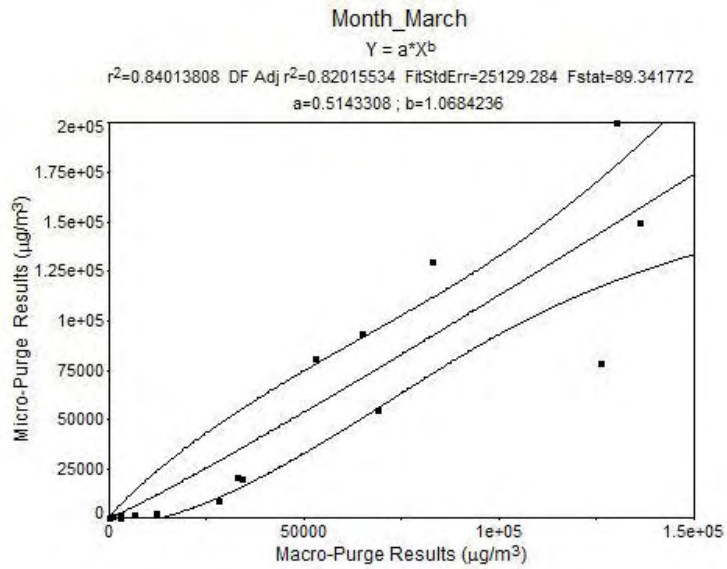
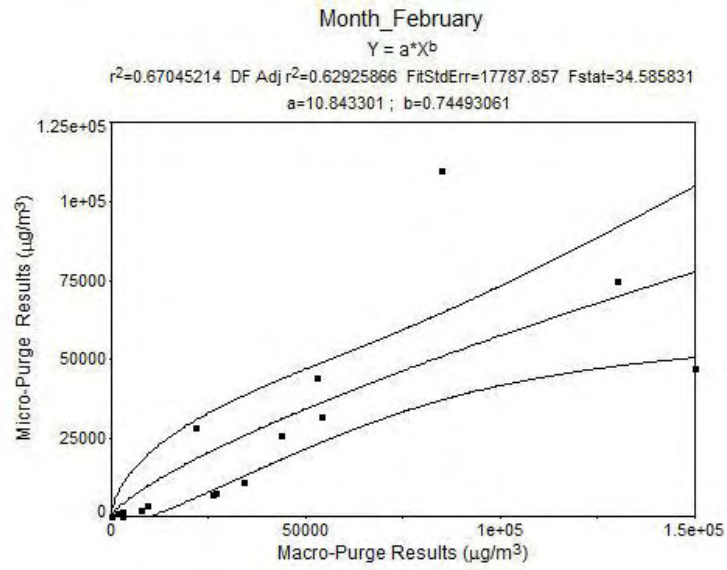

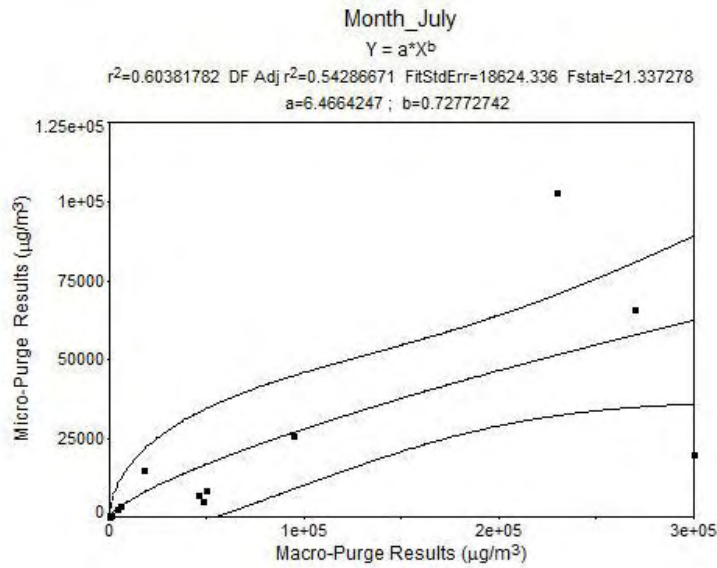
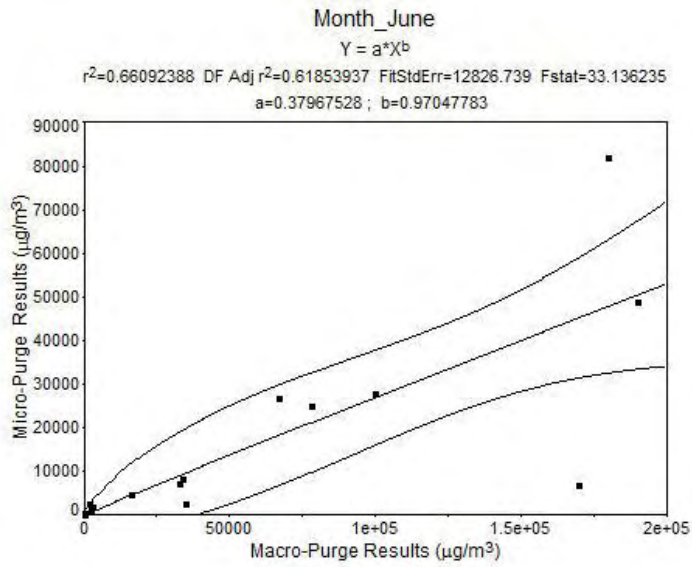
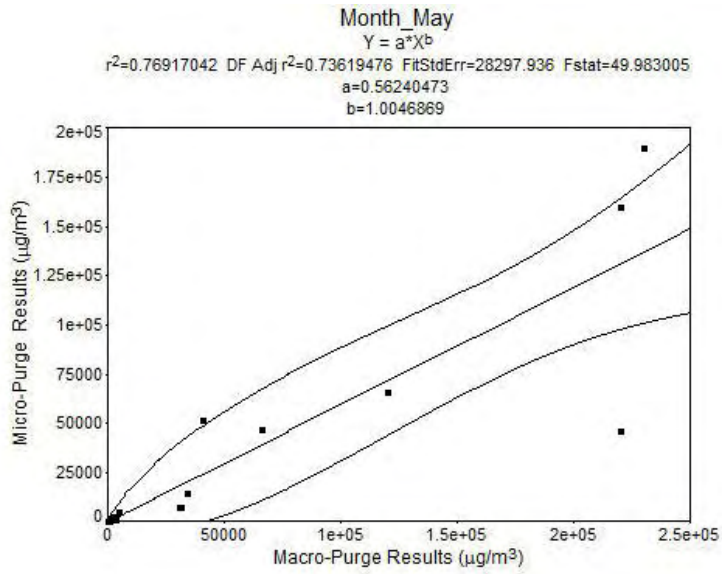

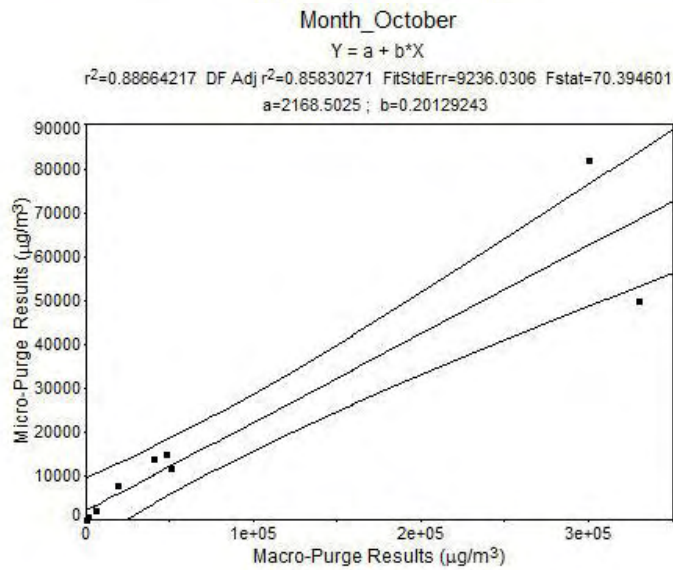
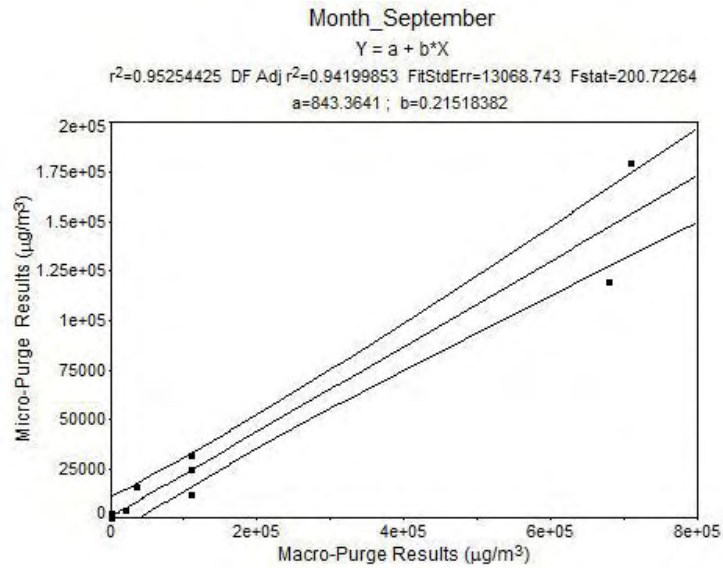
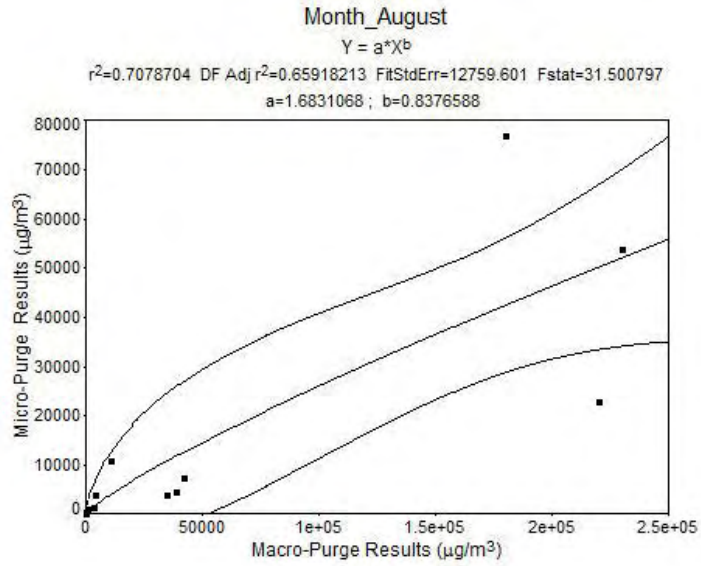

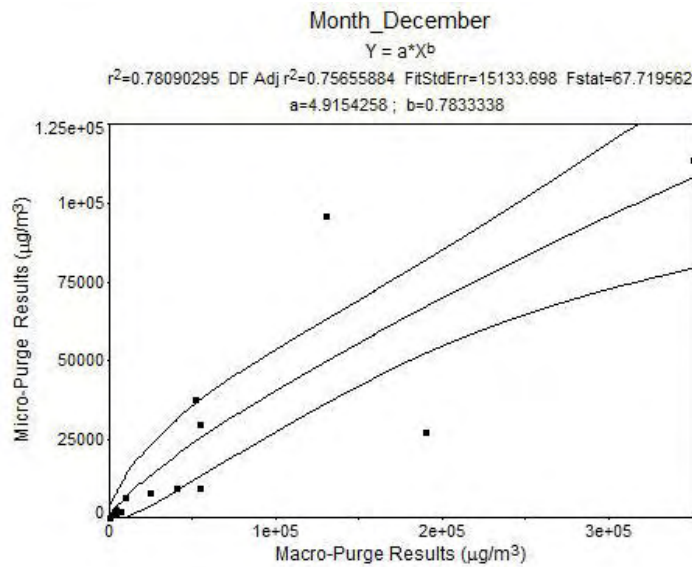
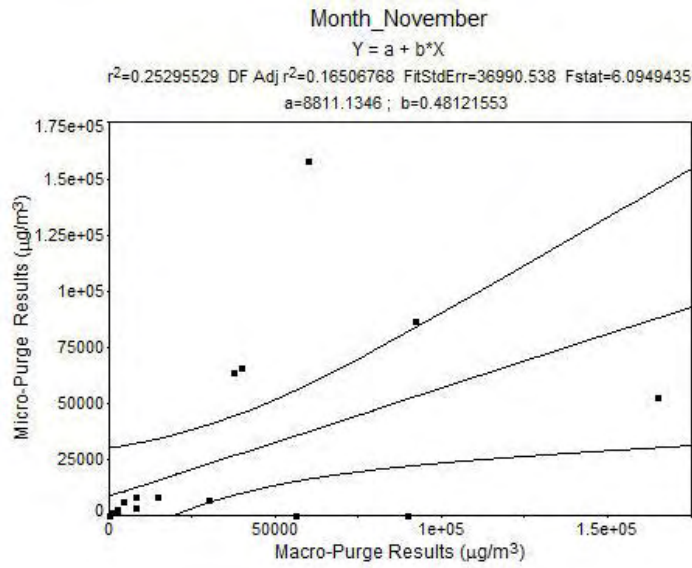

Data grouped by location using the power-law model $Y = a \times X^b$

Note that location ST-7 was not fitted since the power-law model failed to converge. The upper and lower lines represent the 95% confidence interval about the fitted power-law curve.

Station_ST1

$$Y = a \cdot X^b$$

$r^2=0.24886838$ DF Adj $r^2=0.18355259$ FitStdErr=29275.762 Fstat=7.9517904
a=125.76912 ; b=0.53975234

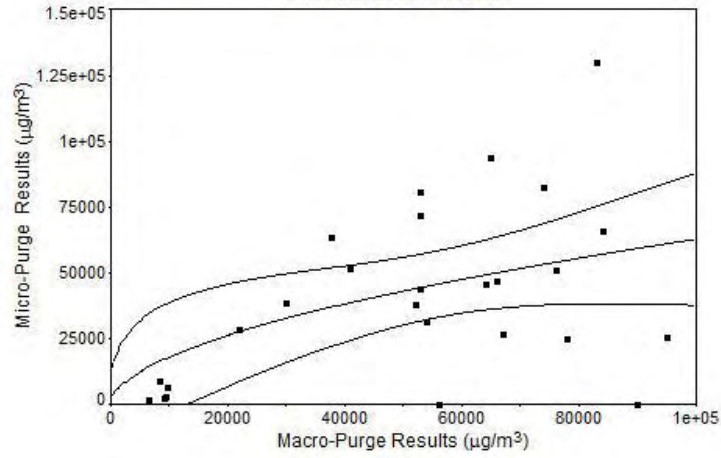

Station_ST2

$$Y = a \cdot X^b$$

$r^2=0.50831015$ DF Adj $r^2=0.47757953$ FitStdErr=805.89308 Fstat=34.115479
a=42.704545 ; b=0.46924583

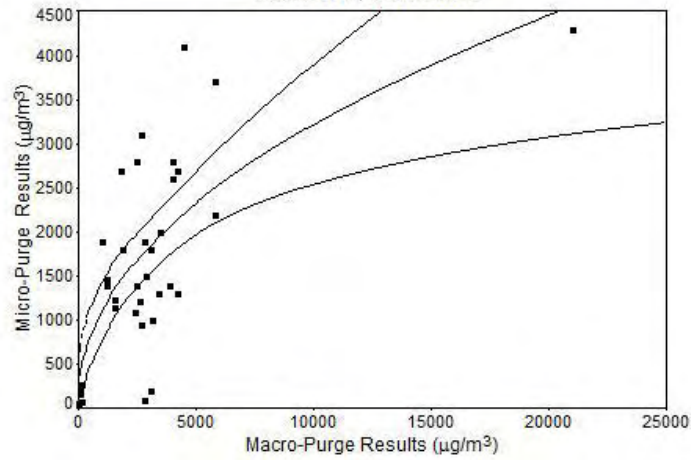

Station_ST3

$$Y = a \cdot X^b$$

$r^2=0.90544485$ DF Adj $r^2=0.89844076$ FitStdErr=177.69414 Fstat=268.12347
a=0.038481908 ; b=1.4735831

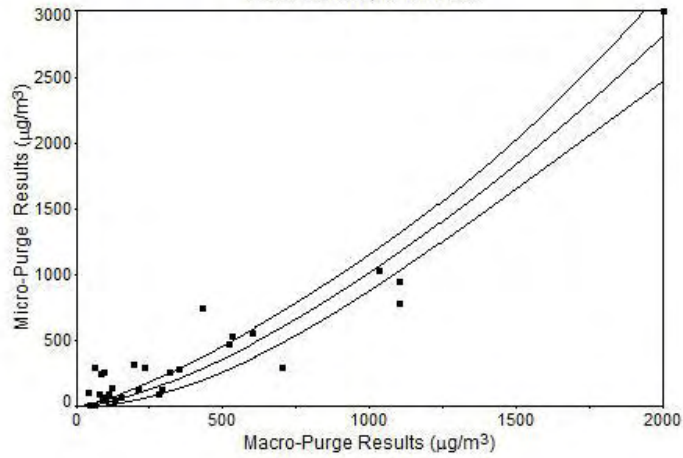

Station_ST7

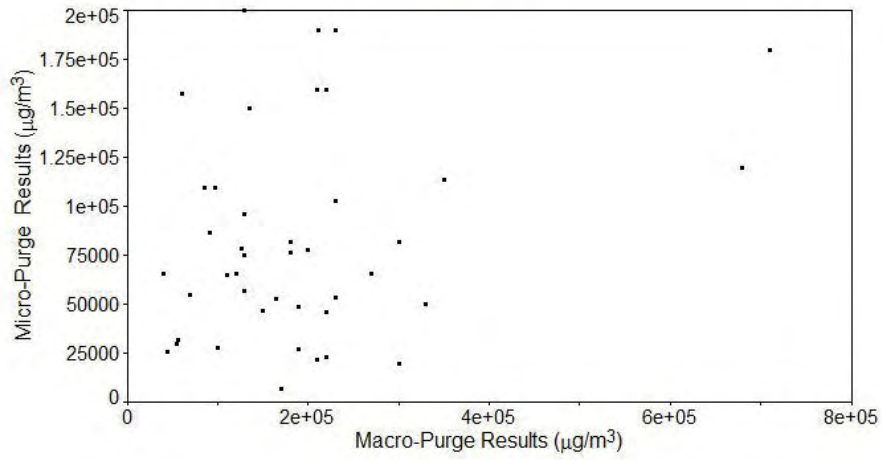

Station_ST8

$$Y = a \cdot X^b$$

$r^2=0.40752942$ DF Adj $r^2=0.38119739$ FitStdErr=4761.0663 Fstat=31.640986
a=16.750243 ; b=0.61433242

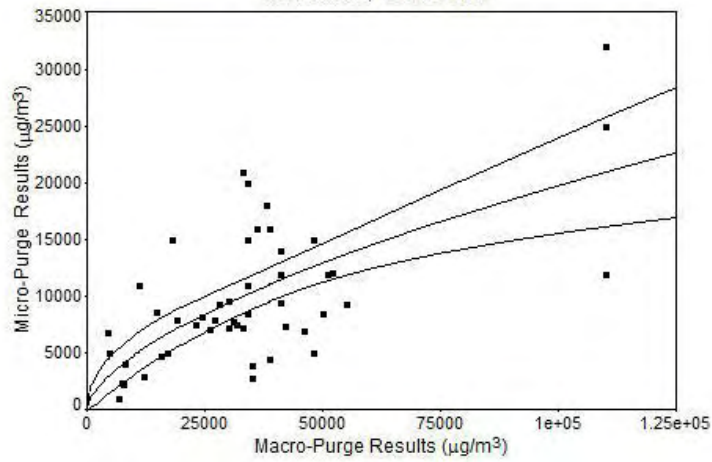

Station_ST9

$$Y = a \cdot X^b$$

$r^2=0.61449406$ DF Adj $r^2=0.58236856$ FitStdErr=19.694454 Fstat=39.849844
a=1.4391547 ; b=0.66913301

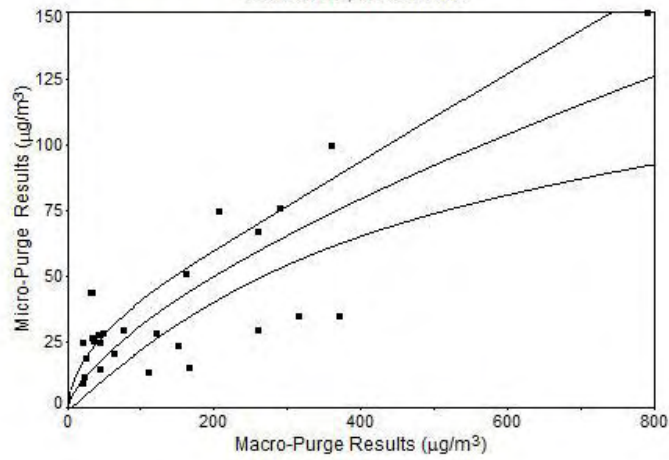



United States
Environmental Protection
Agency

Office of Research
and Development (8101R)
Washington, DC 20460

Official Business
Penalty for Private Use
\$300

EPA/600/R-10/118
October 2010
www.epa.gov

Please make all necessary changes on the below label,
detach or copy, and return to the address in the upper
left-hand corner.

If you do not wish to receive these reports CHECK HERE ;
detach, or copy this cover, and return to the address in the
upper left-hand corner.

PRESORTED STANDARD
POSTAGE & FEES PAID
EPA PERMIT No. G-35



Recycled/Recyclable
Printed with vegetable-based ink on
paper that contains a minimum of
50% post-consumer fiber content
processed chlorine free