

# Strategy and Design Considerations for Prioritization of Mine Waste Source Area Remediation within the Headwaters of the Tar Creek Watershed



Marc Schlebusch, P.E.  
CDM Smith  
Bryant Burnett, CAPT, U.S. PHS  
U.S. EPA Region 7  
Chad Ferguson, P.E. R.G.  
HydroGeologic  
Chris Robb, P.E.  
HydroGeologic

**CDM  
Smith**

# PRESENTATION AGENDA

- Introduction
- Project Goals
- Summarize existing conditions
- Describe remediation strategy
- Provide preliminary project phasing plan
- Conclusions
- Questions



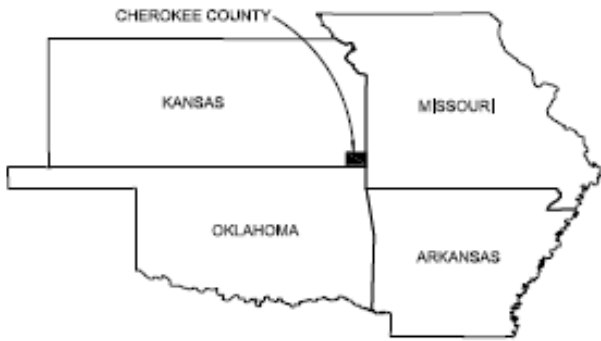

# INTRODUCTION

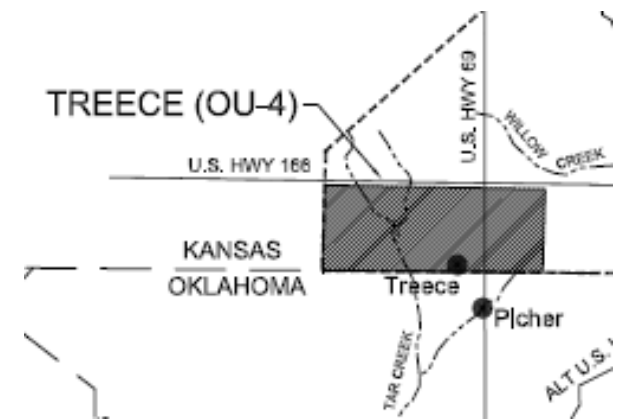

- Cherokee County Superfund Site is located in the southeastern portion of Kansas and is part of the Tri-State Mining District
- Operable Unit (OU) 4 – Treece Subsite is a U.S. Environmental Protection Agency (EPA) Superfund site
- OU-4 is located in and around Treece, Kansas and encompasses approximately 11 square miles or about 7,040 acres
- OU-4 includes Tar Creek and adjacent mine waste areas between State Line Road and Highway 166
- Surface water runoff impacts to Tar Creek from adjacent mine waste areas

# PROJECT GOALS



# PROJECT GOALS

- Eliminate ecological and human health risk pathways resulting from exposure to mine waste
  - Consolidate and cover mine waste
- Reduce cadmium, lead and zinc loading on Tar Creek
  - Mine waste removal and consolidation to eliminate water and sediment contamination from existing surficial mine waste
- Stabilize and restore Tar Creek

# SUMMARY OF EXISTING CONDITIONS

# MINE WASTE AREAS

- Approximately 5,300,000 cubic yards of mining wastes were identified in OU-4
- Approximately 1,900,000 cubic yards of mining wastes remediated to date in OU-4
- Tar Creek and adjacent mine waste areas remain to be remediated



# ENCROACHMENT OF WASTE PILES

- Waste piles at the downstream portion of the main channel infringe on the stream
- Sediment contamination from surficial mine waste
- Resuspension of sediments and metals is a mechanism of mine waste transport
- High stream velocities caused by waste piles on both sides of stream bank
- Potential for future stream degradation



Example of Mine Waste Encroachment



# EXISTING STREAM CROSSINGS

- Many of the existing stream crossings at county roads in the project area are in poor condition
  - Downstream of project area is a low-water crossing (State Line Road)
  - Culverts for main channel of Tar Creek are reinforced concrete pipes and the bridge is cast-in-place concrete
  - Culverts for Northwest Tributary are cast-in-place concrete bridges and have an open bottom



State Line Road Low-Water Crossing

# EXAMPLE OF EXISTING STREAM CROSSINGS



Tar Creek - SW Star Road Culverts  
Southwest of Muncie Pit



Northwest Tributary - SW Star Road Culvert  
Southeast of TC-2



# STREAM DEGRADATION ON NORTHWEST TRIBUTARY

- Examples of stream degradation include:
  - Headcutting, where the stream lowers grade
  - Bank erosion, caused by high velocities downstream of stream crossing as well as headcutting
  - Impaired water quality and wildlife habitat



Example of Bank Erosion



Example of Headcutting

# EXISTING POOLS OF WATER

- Existing pools of water
  - Abandoned structures from old mining-related haul roads and railroad crossings impound water on Tar Creek
  - Previous USACE project at Muncie Pit
  - Animal activity, such as beaver dams also impound water



Example of Existing Structure Impounding Water



Example of Existing Structure Impounding Water



# REMEDIATION STRATEGY

# GENERAL REMEDIATION STRATEGY

- Excavate mine waste, contaminated soil, and contaminated sediment and transport to and dispose at mine waste consolidation areas
- Fill subsidence features
- Abandon vent pipes and open mine shafts
- Cover mine waste consolidation areas with 12 inches of select fill and 6 inches topsoil
- Backfill excavated areas as needed for positive surface drainage

# GENERAL REMEDIATION STRATEGY (cont.)

- Reduce the quantity of impacted watershed runoff to improve Tar Creek water quality
  - Consolidate and cover the mining wastes then revegetate the areas
  - Realign Tar Creek to provide separation from the mine waste consolidation areas
- Construct grade control structures to maintain stream elevations and alignments
- Seed disturbed areas
- Restore wetlands





# STREAM RESTORATION STRATEGIES

- Excavate mine waste and contaminated sediment and soil
  - Excavate visible mine waste adjacent to and within Tar Creek
  - Excavate 12-inches of contaminated sediment from Tar Creek
  - Backfill Tar Creek excavation to within 6 inches of original grade as needed

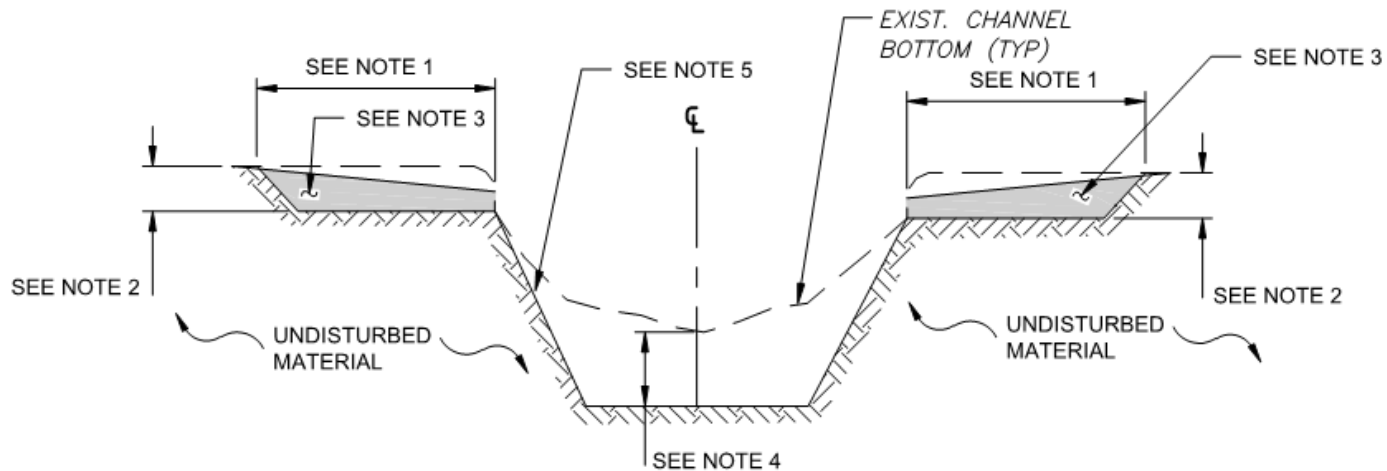

TYPICAL CREEK CHANNEL EXCAVATION/RESTORATION



# STREAM RESTORATION STRATEGIES (cont.)

- Restore creek hydraulics to a pre-remediation condition and address existing stream degradation
  - Construct Newbury riffles to hold stream in place
  - Install riprap aprons at downstream crossings to resist high velocities
  - Grade and vegetate banks to stabilize slope



Example of Newbury Riffle

# STREAM RESTORATION STRATEGIES (cont.)

- Replace artificial obstructions within creek to enhance ponded areas
  - Remove abandoned structures from old mining-related haul roads and railroad crossings that impound water
- Protect creek alignment upstream of existing road crossings
  - Construct in-stream structures upstream of road crossings to protect stream alignment in the event of future road improvements by county/state road departments



# WETLAND RESTORATION

- Goal of exceeding a minimum 1:1 ratio of wetlands for pre- and post-construction conditions
- Use wetland seed mix for restoration in majority of areas along creek
- Use wetland plugs in selected areas
- Provide additional maintenance of restored wetland areas to assist establishment



# SHORT- AND LONG-TERM MONITORING OF REMEDY

- Conduct aquatic macro invertebrate study
- Conduct background and baseline sediment and water sampling
  - Sample pre- and post-construction for each phase
  - Sample upstream and downstream of remediated areas
- Long-term monitoring will provide indication of success of the remediation



# PRELIMINARY PROJECT PHASING PLAN





# PHASE 1

- Design for Phase 1 is currently underway
- Remediate Northwest Tributary of Tar Creek north of Star Road
- Excavate mine waste, contaminated soil, and contaminated sediment
- Consolidate material on the east and west sides of SW 20<sup>th</sup> Street, and construct cover
- Realign tributary to avoid existing structures
- Restore and revegetate existing pastures and wetlands

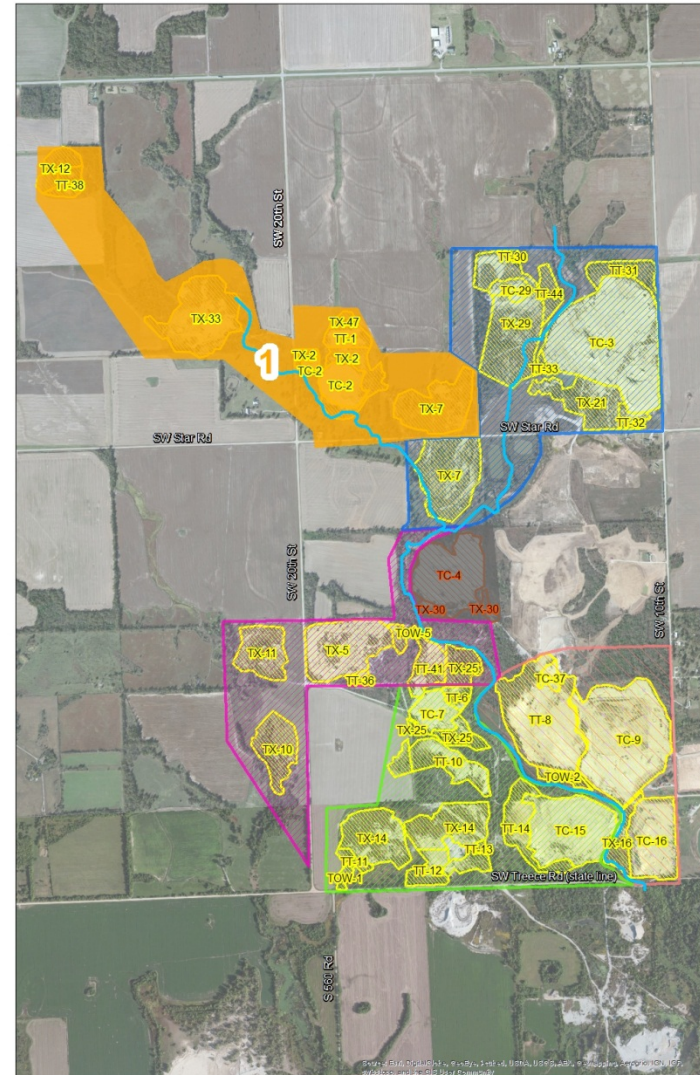



# PHASE 1 (cont.)

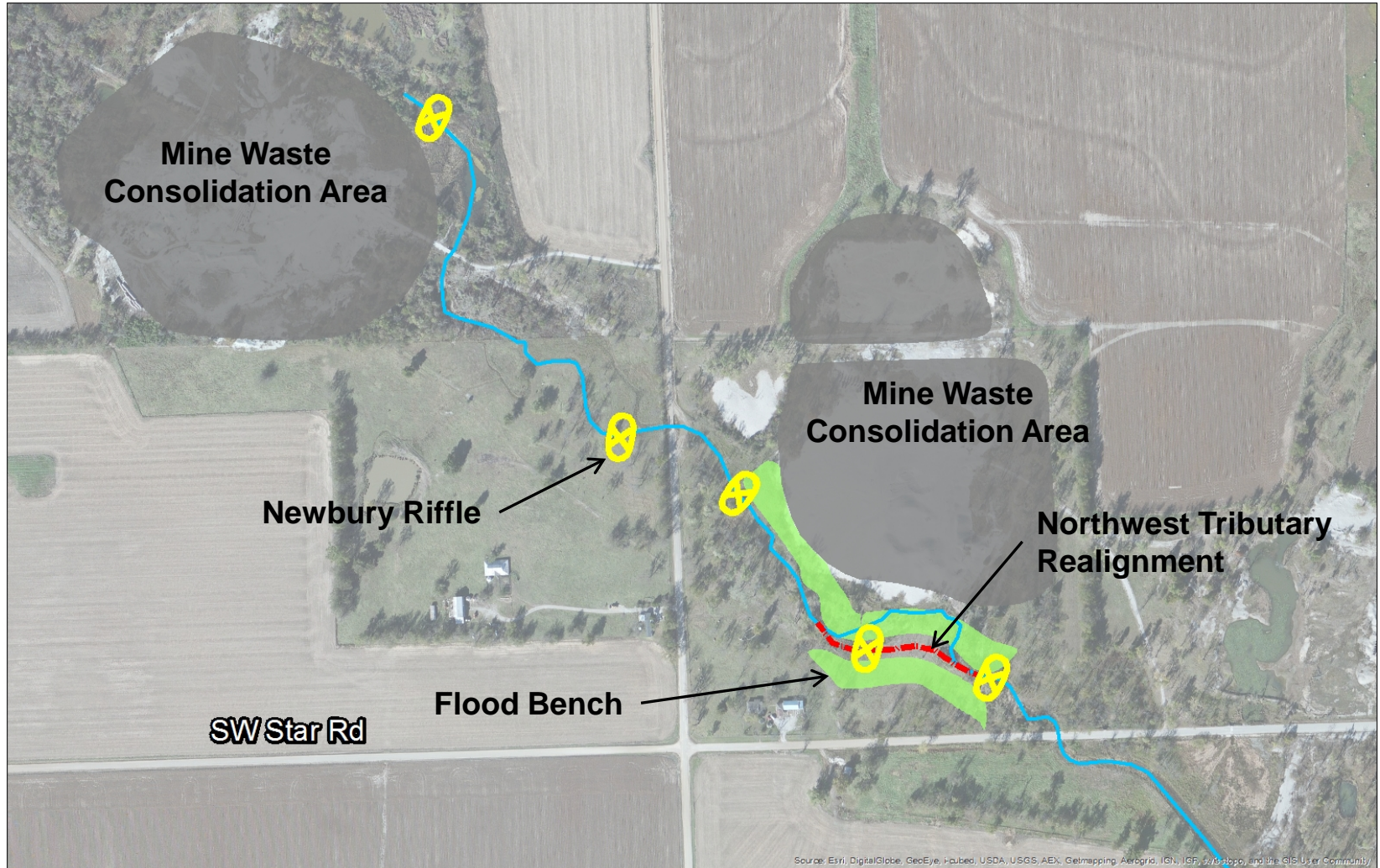

# PROPOSED PHASE 2

- Remediate Tar Creek north of Star Road, northwest tributary south of Star Road (TX-7 South), and adjacent mine waste areas
- Excavate mine waste, contaminated soil, and contaminated sediment
- Consolidate material on existing TC-3 mine waste area
- Place cover on mine waste consolidation area
- Realign Tar Creek to the west in existing mine waste area to provide separation from mine waste consolidation area

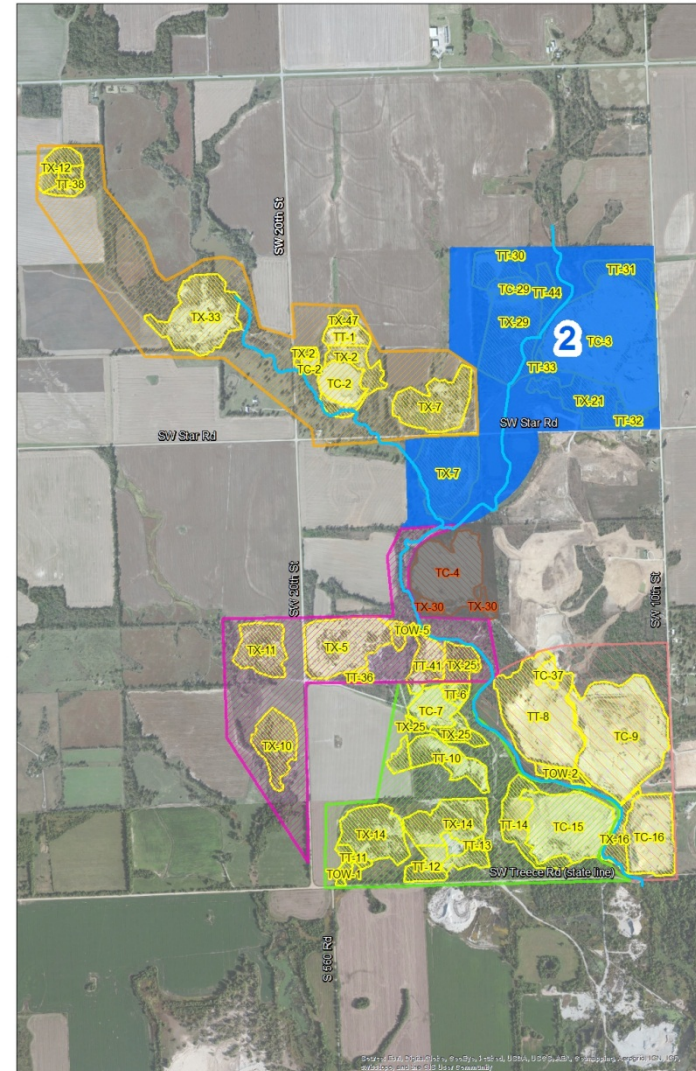



# PROPOSED PHASE 2 (cont.)

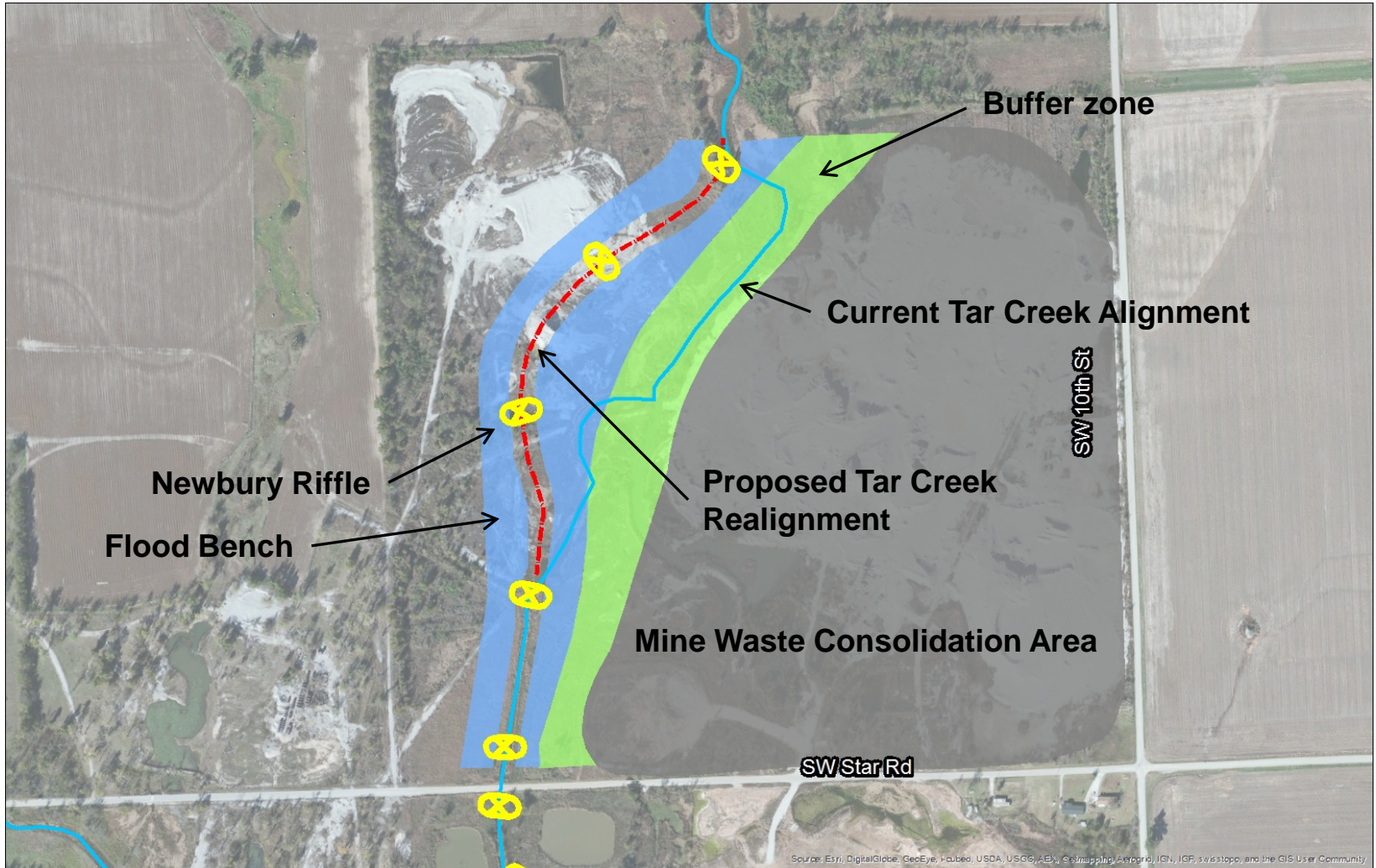



# PROPOSED PHASE 2 (cont.)





# PROPOSED PHASE 3

- Remedial action design and implementation at TC-4 will be conducted by a potentially responsible party (PRP) which will be incorporated into the overall design for Tar Creek
- Remediate Tar Creek south along the PRP area to the future western tributary outlet
- Excavate mine waste, contaminated soil, and contaminated sediment and place at southwest mine waste consolidation area in Phase 4.

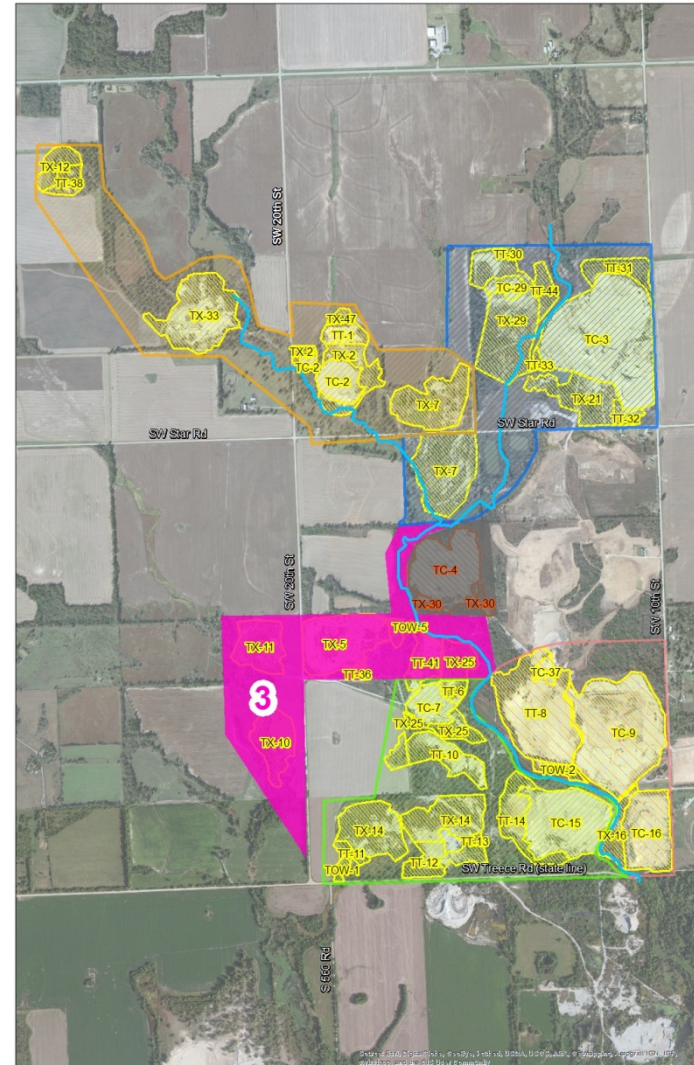



# PROPOSED PHASE 3 (cont.)

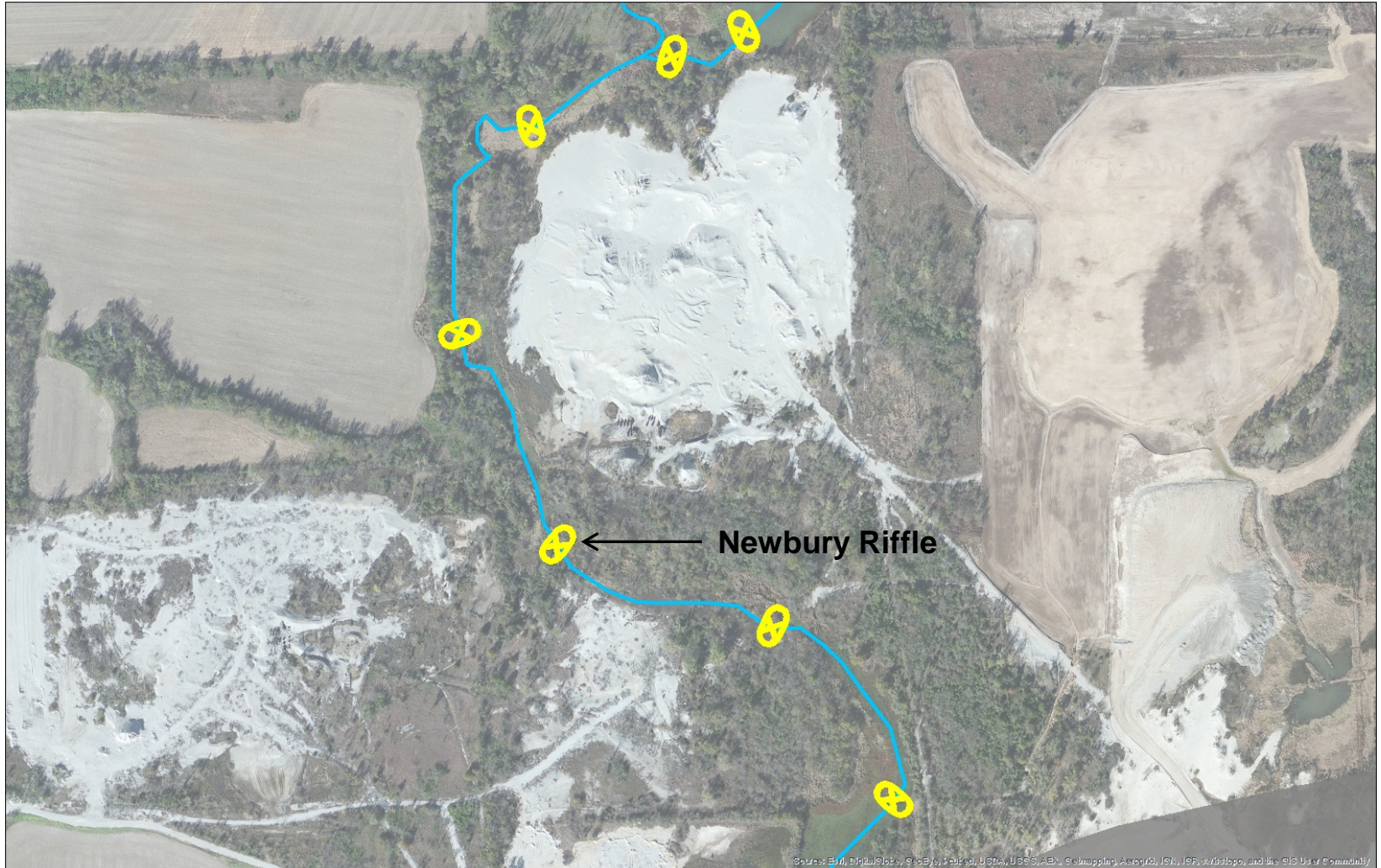



# PROPOSED PHASE 4

- Pull back mine waste and contaminated soil from areas TC-15/TT-14 for later realignment of Tar Creek
- Excavate mine waste, contaminated soil, and contaminated sediment and place in southwest mine waste consolidation area
- Place cover on southwest mine waste consolidation area

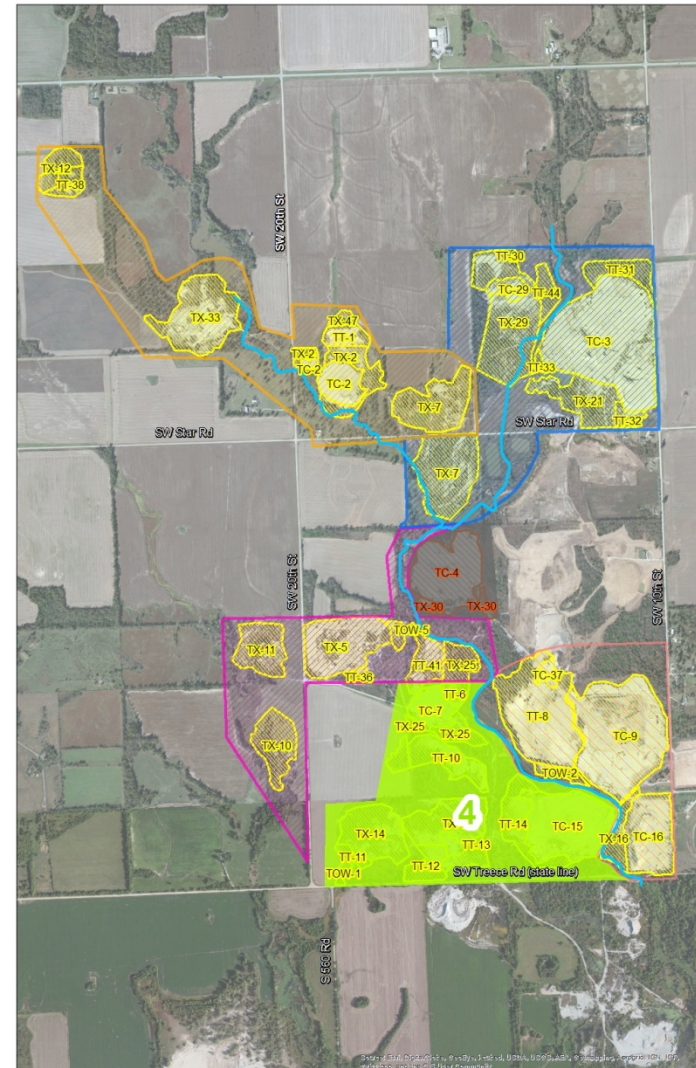

# PROPOSED PHASE 4 (cont.)

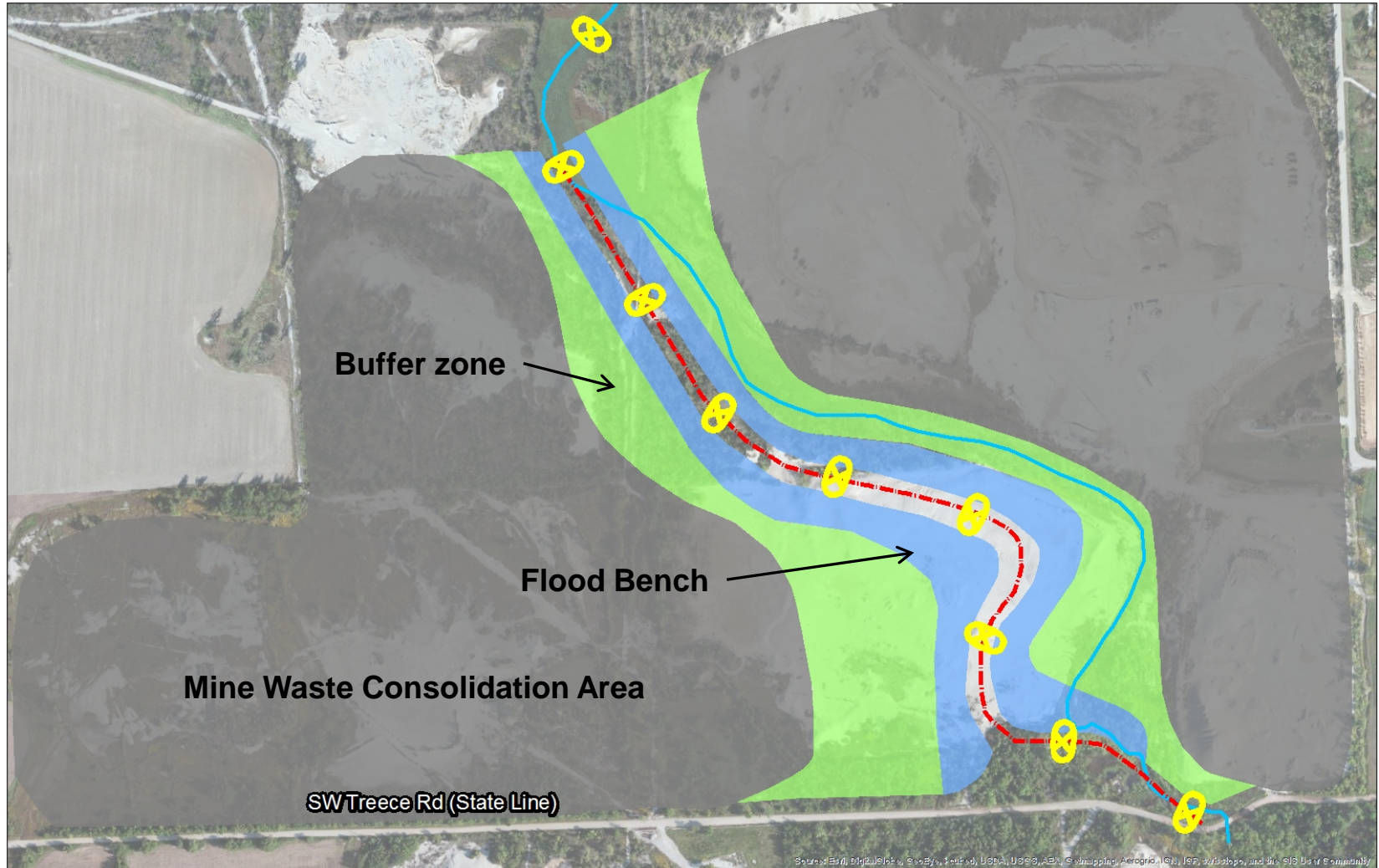



# PROPOSED PHASE 5

- Remediate Tar Creek from the former railroad spur to State Line Road in areas not subject to realignment
- Realign Tar Creek to provide separation from TC-9/TT-8/TOW-2 mine waste consolidation area and address previous concerns regarding leaching from subsurface contaminants
- Excavate mine waste, contaminated soil, and contaminated sediment and place at mine waste consolidation area
- Redirect drainage north of mine waste consolidation area to west Tar Creek

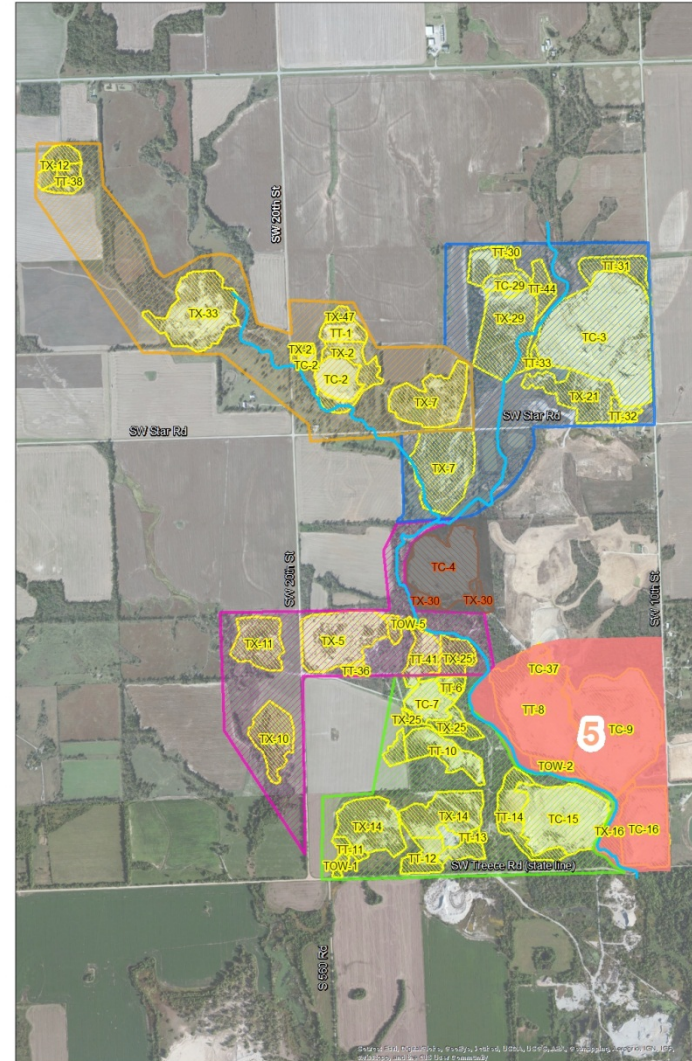

# PROPOSED PHASE 5 (cont.)

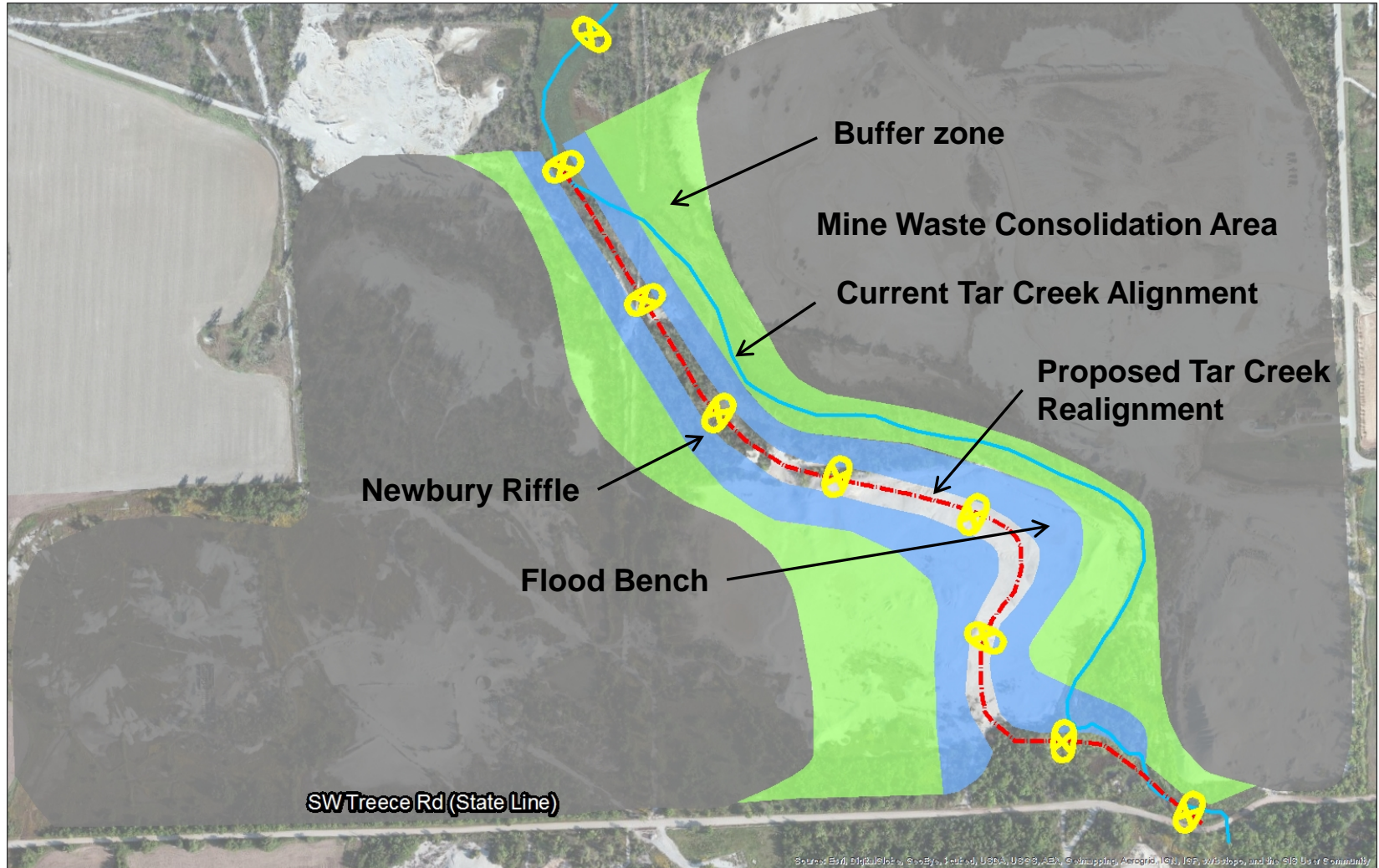



# CONCLUSIONS

# CONCLUSIONS

- Remove and consolidate remaining mine waste, contaminated soil, and contaminated sediment adjacent to and within Tar Creek and OU-4
- Remediate Tar Creek from upstream to downstream in five phases as funding becomes available
- Restore and stabilize Tar Creek and adjacent areas including wetlands
- Conduct pre- and post-construction water quality and macro-invertebrate sampling in Tar Creek



QUESTIONS?