

# FINAL REPORT

Use of On-Site GC/MS Analysis to Distinguish Between Vapor  
Intrusion and Indoor Sources of VOCs

ESTCP Project ER-201119

November 2013

Lila Beckley  
Thomas McHugh  
**GSI Environmental Inc.**

Kyle Gorder  
Erik Dettenmaier  
**Hill Air Force Base**

Ignacio Rivera-Duarte  
**SSC Pacific**

*Distribution Statement A*

*This document has been cleared for public release*



## TABLE OF CONTENTS

1.0	INTRODUCTION .....	1
1.1	BACKGROUND .....	1
1.2	OBJECTIVE OF THE DEMONSTRATION.....	3
1.3	REGULATORY DRIVERS .....	3
2.0	TECHNOLOGY .....	5
2.1	TECHNOLOGY DESCRIPTION .....	5
2.1.1	Analytical Instrument.....	5
2.1.2	Precision and Accuracy Requirements .....	6
2.1.3	Prior Application.....	6
2.2	TECHNOLOGY DEVELOPMENT.....	7
2.3	ADVANTAGES AND LIMITATIONS OF THE TECHNOLOGY.....	7
2.3.1	Alternate Instruments for On-Site GC/MS Analysis .....	7
2.3.2	Advantages and Limitations of the On-Site Analysis Method .....	8
2.3.3	HAPSITE Instrument Reliability.....	9
3.0	PERFORMANCE OBJECTIVES .....	11
3.1	OBJECTIVE 1: COLLECTION OF DATA REPRESENTATIVE OF SITE CONDITIONS USING ON-SITE GC/MS.....	13
3.1.1	Data Requirements.....	13
3.1.2	Success Criteria and Results .....	13
3.2	OBJECTIVE 2: COLLECTION OF DATA REPRESENTATIVE OF SITE CONDITIONS USING OFF-SITE LABORATORY ANALYSIS.....	13
3.2.1	Data Requirements.....	13
3.2.2	Success Criteria.....	13
3.3	OBJECTIVE 3: VALIDATION OF DRAFT PROTOCOL FOR USE OF ON- SITE ANALYSIS TO EVALUATE VAPOR INTRUSION.....	13
3.3.1	Data Requirements.....	14
3.3.2	Success Criteria.....	14
3.4	OBJECTIVE 4: IMPLEMENTABILITY AND COST EFFECTIVENESS OF THE PROTOCOL FOR ON-SITE ANALYSIS.....	14
3.4.1	Data Requirements.....	14
3.4.2	Success Criteria.....	14
4.0	SITE DESCRIPTION .....	16
4.1	SITE LOCATION AND HISTORY.....	16
4.2	SITE GEOLOGY, HYDROGEOLOGY, AND CONTAMINANT DISTRIBUTION.....	20
5.0	TEST DESIGN .....	22
5.1	CONCEPTUAL EXPERIMENTAL DESIGN.....	22
5.1.1	Conventional Program - Collection of Indoor Air and Sub-Slab Soil Gas Samples .....	22
5.1.2	Collection of Samples for Stable Isotope Analysis.....	23
5.1.3	Protocol for Use of On-Site Analysis for Vapor Intrusion .....	23
5.2	BASELINE CHARACTERIZATION.....	25
5.3	LABORATORY STUDY RESULTS .....	25
5.4	DESIGN AND LAYOUT OF TECHNOLOGY COMPONENTS .....	25

5.4.1	Installation of Sampling Points for Conventional Samples .....	25
5.4.2	Sampling Points for CSIA Samples .....	26
5.4.3	Sampling Points for On-Site Analysis Protocol .....	26
5.5	FIELD TESTING.....	26
5.5.1	Field Testing for Conventional Vapor Intrusion Program.....	26
5.5.2	Field Testing for CSIA Samples .....	26
5.5.3	Field Testing for On-Site Analysis Protocol.....	27
5.6	SAMPLING AND ANALYSIS METHODS .....	28
5.6.1	Conventional Vapor Intrusion Program.....	29
5.6.2	CSIA Samples .....	30
5.6.3	Samples to Support the On-Site Analysis Protocol .....	30
5.6.4	Sample Summary and Quality Assurance Procedures.....	30
5.7	SAMPLING RESULTS.....	31
5.7.1	Vapor Intrusion Classification using Conventional Lines of Evidence Approach.....	35
5.7.2	VI Classification using the CSIA Protocol .....	37
5.7.3	VI Classification using the On-Site Analysis Protocol.....	38
5.8	SUPPLEMENTAL DATA .....	42
5.8.1	Identification of Indoor Sources .....	42
5.8.2	Use of Building Pressure Manipulation.....	44
5.8.3	Identification of Vapor Intrusion Entry Points .....	46
6.0	PERFORMANCE ASSESSMENT .....	48
6.1	OBJECTIVE 1: COLLECTION OF DATA REPRESENTATIVE OF SITE CONDITIONS USING ON-SITE GC/MS.....	48
6.1.1	Data Quality Review.....	48
6.1.2	Evaluation of Performance Objective 1 .....	53
6.2	OBJECTIVE 2: COLLECTION OF DATA REPRESENTATIVE OF SITE CONDITIONS USING OFF-SITE ANALYSIS .....	53
6.2.1	Data Quality Review.....	53
6.2.2	Evaluation of Performance Objective 2.....	56
6.2.3	Evaluation of UFP-QAPP Forms.....	57
6.3	OBJECTIVE 3: VALIDATION OF DRAFT PROTOCOL FOR USE OF ON-SITE ANALYSIS TO EVALUATE VAPOR INTRUSION.....	58
6.3.1	Site-by-Site Analysis of Results: Building VI Classifications .....	58
6.3.2	Other Findings .....	62
6.3.3	Evaluation of Performance Objective 3.....	63
6.4	OBJECTIVE 4: IMPLEMENTABILITY AND COST EFFECTIVENESS OF THE PROTOCOL FOR ON-SITE ANALYSIS.....	64
6.4.1	Demonstration Findings.....	64
6.4.2	Evaluation of Performance Objective 4.....	65
6.4.3	Modifications to the On-Site Analysis Protocol .....	66
7.0	COST ASSESSMENT.....	68
7.1	COST MODEL FOR THE DEMONSTRATION .....	68
7.1.1	Cost Element: Project Planning and Preparation.....	69
7.1.2	Cost Element: On-Site Analysis Field Program .....	69
7.1.3	Cost Element: Data Evaluation and Reporting .....	70

7.2	COST DRIVERS .....	71
7.3	COST ANALYSIS.....	71
8.0	IMPLEMENTATION ISSUES .....	74
9.0	REFERENCES .....	76

**TABLES**

Table 1:	Performance Objectives.....	12
Table 2:	Demonstration Buildings.....	19
Table 3:	Demonstration Site Geology/Hydrogeology and Key Contaminants.....	20
Table 4:	Summary of Conventional Vapor Intrusion Sampling Program .....	23
Table 5:	Summary of CSIA for Vapor Intrusion Sampling Program .....	23
Table 6:	Typical On-Site Analysis Program for Field Demonstration .....	27
Table 7:	Laboratory Analytical Methods for Demonstration .....	29
Table 8:	Summary of Demonstration Program.....	32
Table 9:	Key Analytical Parameters .....	33
Table 10:	Numeric Standards Used for VI Classifications.....	34
Table 11:	VI Classification using Lines of Evidence Approach: Conventional and On-Site Protocol.....	35
Table 12:	Conventional Program Results .....	36
Table 13:	CSIA Protocol Results.....	38
Table 14:	On-Site Analysis Protocol Results.....	41
Table 15:	HAPSITE Instruments used for each Demonstration.....	48
Table 16:	Calibration Curve Summary Statistics.....	49
Table 17:	Summary of On-Site Data Quality Evaluation .....	53
Table 18:	Summary of Laboratory Data Evaluation Results .....	56
Table 19:	VI Classification based on Investigation Method.....	59
Table 20:	Cost Model for the Field Demonstration .....	68
Table 21:	Typical Consultant Labor Requirements for Project Planning.....	69
Table 22:	Representative Unit Costs for On-Site Analysis Demonstration.....	70
Table 23:	Typical Labor Requirements for Data Evaluation and Reporting .....	70
Table 24:	Costs for Routine Implementation of On-Site Analysis Protocol at Four Buildings ...	72
Table 25:	Estimated Cost of Typical Vapor Intrusion Investigation at Four Buildings .....	73

**FIGURES**

Figure 1:	Building-Specific Field Testing Schedule.....	22
Figure 2:	Demonstration Process for On-Site Analysis to Evaluate Vapor Intrusion .....	24
Figure 3:	Example Pressure Transducer Installation .....	28
Figure 4:	Interpretation of CSIA Results .....	37
Figure 5:	Indoor trans-1,2-DCE Source Identification .....	43
Figure 6:	Indoor PCE Source Identification using On-Site Protocol.....	44
Figure 7:	Non-removable Indoor TCE Source with Associated HAPSITE Survey Response.....	45
Figure 8:	Pressure Manipulation Results Confirming Vapor Intrusion .....	45
Figure 9:	Identification of Utility Trench as a Vapor Source .....	46
Figure 10:	Example of a Vapor Entry Point .....	47

## **APPENDICES**

Appendix A: Points of Contact

Appendix B: Lines of Evidence Evaluations

Appendix C: Results from Individual Demonstration Sites

Appendix D: Data Quality Review and Laboratory Reports

Appendix E: Recommended Protocol

## ACRONYMS

1,1,1-TCA	1,1,1-trichloroethane
1,2-DCA	1,2-dichloroethane
AFB	Air Force Base
bgs	Below ground surface
CCV	Continuing calibration verification
BTEX	Benzene, toluene, ethylbenzene, xylenes
cis-1,2-DCE	cis-1,2-dichloroethylene
COC	Chemical of concern
COTS	Commercially-available off the shelf
CSIA	Compound-specific stable isotope analysis
cVOC	Chlorinated volatile organic compound
DoD	Department of Defense
DQO	Data quality objective
ESTCP	Environmental Security Technology Certification Program
FUDS	Formerly Used Defense Site
ETV	Environmental Technology Verification
ft	Foot, feet
GC	Gas chromatography
GW	Groundwater
HCs	Hydrocarbons
HVAC	Heating, ventilation, and air conditioning
IDW	Investigation derived waste
LCL	Lower calibration limit
MS	Mass spectrometry
MTBE	Methyl-tert-butyl ether
N/A	Not applicable
PAH	Polyaromatic hydrocarbon
NELAC	National Environmental Laboratory Accreditation Conference
PCE	Tetrachloroethylene
pCi	Picocurie
ppbV	Parts per billion by volume
QA	Quality assurance
QAPP	Quality assurance project plan
QC	Quality control
SIM	Selective ion monitoring
SOP	Standard operating procedure
sq ft	Square feet
RPD	Relative percent difference
RF	Response factor
RSD	Relative standard deviation
RV	Recreational vehicle
TAGA	Trace Atmospheric Gas Analyzer
TCE	Trichloroethylene

trans-1,2-DCE	trans-1,2-dichloroethylene
UFP-QAPP	Uniform Federal Policy for Quality Assurance Project Plans
USEPA	United States Environmental Protection Agency
UST	Underground storage tank
VI	Vapor intrusion
VC	Vinyl chloride
VOA	Volatile organic analysis
VOC	Volatile organic compound

## ACKNOWLEDGMENTS

This project would not have been possible without the support and contribution of numerous individuals and organizations. The authors thank Samuel Brock and Mahalingam Ravichandran of AFCEC for support and oversight; Bill Myers, Jim Gillie, Tom Lynott, Mike Haley, Amanda Michels, Cheryl Neades, Andy Anders, Miguel Plaza, Brian Mosley, Sandra Piettro, Jim Kelly plus numerous other site personnel for providing access to the demonstration sites and facilitating implementation of the project at these sites; the ESTCP technical review staff for helpful technical comments and suggestions; and Andrea Leeson and the ESTCP program staff at Hydrogeologic for invaluable project support.

## **EXECUTIVE SUMMARY**

### **OBJECTIVES OF THE DEMONSTRATION**

Distinguishing between vapor intrusion (VI) and indoor sources of volatile organic compounds (VOCs) is a significant challenge in site assessments, greatly increasing the cost and complexity of investigations. Rapid on-site analysis of indoor air samples using a portable GC/MS allows the users to understand the distribution of VOCs in real-time, supporting identification of the source while in still the field. The overall objective of the demonstration was to develop and validate a step-wise investigation procedure using commercially-available off the shelf (COTS) on-site GC/MS analysis with real-time decision making as a tool to distinguish between vapor intrusion and indoor sources of VOCs.

### **TECHNOLOGY DESCRIPTION**

Use of on-site GC/MS analysis to distinguish between vapor intrusion and indoor sources of VOCs requires a field-portable analytical instrument with sufficient sensitivity to measure VOC concentrations in indoor air within the concentration range of regulatory concern (i.e., as low as 1  $\mu\text{g}/\text{m}^3$ ). A high degree of precision is also required because the protocol relies on measuring concentration gradients inside a building to identify sources of VOCs. For the demonstration, we utilized a HAPSITE portable GC/MS instrument. Although specific procedures in the investigation protocol were developed using the HAPSITE, any on-site instrument with sufficient sensitivity and precision may be used in the protocol.

### **DEMONSTRATION RESULTS**

The field investigation program included application of the on-site GC/MS analysis protocol at four Department of Defense (DoD) sites. To evaluate the validity of this investigation approach, we also conducted conventional vapor intrusion and compound-specific stable isotope analysis (CSIA; ESTCP Project ER-201025) investigations concurrently at the study sites. Results from the three investigation methods were compared to evaluate the relative effectiveness of the different investigation approaches.

This report presents the results from a total of seven demonstration buildings. At all seven of the demonstration buildings, the on-site analysis protocol performed as well as or better than the conventional investigation approach. At six of the seven buildings, the results from the on-site analysis protocol were consistent with the overall evaluation of the vapor intrusion condition based on the results from all three of the investigation methods combined. The field conditions encountered at the demonstration sites did not fully test some aspects of the on-site analysis protocol such as identification of vapor entry points. Therefore, in order to further illustrate the utility of the on-site analysis protocol for distinguishing between vapor intrusion and indoor sources of VOCs, we have included results from several supplemental studies which show how the method can be used for indoor source identification and vapor entry point identification. Additional examples are also provided for the building pressure manipulation (McHugh et al., 2012; USEPA, 2011b) option of the protocol.

### **IMPLEMENTATION ISSUES**

This project has resulted in the development and validation of an on-site GC/MS analysis protocol to distinguish vapor intrusion from indoor sources of VOCs. The protocol can be used



as a standalone investigation method or can be used within a larger investigation program. Advantages of the protocol include:

- Real-time results: The key advantage of the on-site analysis method is the ability to measure indoor air VOC concentrations and determine the primary sources (i.e., indoor vs. subsurface) in real time during the course of the field investigation. Because of the short analytical method run times, many samples can be collected while on site, resulting in a large volume of data available for interpretation while still in the field. This allows the investigators to more readily react to building-specific situations and make decisions (e.g., rule out vapor intrusion, determine potential vapor entry points, find primary VOC sources, etc.).
- Definitive data: Although the method focuses on on-site analysis, a small number of air samples are collected for off-site laboratory analysis to confirm key findings. These confirmation sample results are supported by standard laboratory quality assurance/quality control (QA/QC) and can be used for regulatory decision-making.
- No sub-slab sample points: The protocol eliminates the need to drill through the building foundation.
- Reduced sampling requirements: Because indoor sources of VOCs can be identified and removed during the investigation, the on-site analysis method will more frequently yield clearer results compared to the conventional investigation approach. When used in conjunction with building pressure manipulation, the need for further sampling to characterize temporal variability may also be reduced or eliminated.

Potential limitations to the use of the on-site GC/MS analysis protocol include:

- Equipment availability and reliability: The HAPSITE Smart Plus or alternate instrument for on-site analysis is less common than the equipment used for the conventional investigation approach. As a result, equipment availability, procurement, and scheduling may be more complex. Reliability, sensitivity, and other QA requirements should be considered when selecting the on-site GC/MS instrument for use in the protocol.
- Staff suitably trained in interpretation of vapor data: The field team should include one more senior staff member with the knowledge, skills, ability and authority to make field-decisions based on the on-site measurements. The team should also include at least one experienced GC/MS operator.
- Target compounds: Specific target compounds should be sufficiently volatile to be detected at concentrations similar to the applicable indoor air screening concentration. Less volatile compounds such as naphthalene may not be good candidates for on-site analysis because it is difficult to calibrate the on-site instrument for analysis of low concentrations of less volatile compounds. Additionally, accurate identification may be problematic with certain VOCs. This issue may be addressed by fine-tuning the analytical method or interpreting chromatograms and ion mass ratio data in the field.
- Building construction: For building pressure control to be effective, the building cannot be too large (>20,000 sq. ft.) or too leaky (e.g., presence of built-in ventilation slats).

## 1.0 INTRODUCTION

The purpose of this project is to validate an investigation procedure using commercially-available off the shelf (COTS) on-site gas chromatography/mass spectrometry (GC/MS) analysis with real-time decision making as a tool to distinguish between vapor intrusion (VI) and indoor sources of volatile organic compounds (VOCs). The specific goals of the project are as follows:

- Task 1: Validate the use of the HAPSITE portable GC/MS for measurement of low concentrations of VOCs (as low as  $1 \mu\text{g}/\text{m}^3$ ) in indoor air.
- Task 2: Develop a standardized investigation protocol for on-site analysis of indoor air samples for the purpose of identifying the source(s) of the VOCs including: i) Building operating procedures to minimize air mixing prior to sample collection; ii) Systematic sample collection and analysis to determine the distribution of VOCs within the building and to identify likely indoor sources of VOCs and/or vapor intrusion entry points; iii) Procedures to test specific sources and entry points of VOCs; and iv) Confirmation sampling following source isolation and/or removal.
- Task 3: Demonstrate on-site analysis protocol and performance for vapor intrusion investigations through application at four U.S. Department of Defense (DoD) buildings with known vapor intrusion or potential vapor intrusion concerns.

Task 1 was accomplished through a study which compared samples analyzed by the HAPSITE against analysis by a fixed-base analytical laboratory (GSI, 2012a). This study confirmed that the accuracy, precision, and sensitivity of the HAPSITE are sufficient to measure VOC concentrations in air at levels of regulatory concern (i.e., chlorinated VOC concentration above  $0.5$  to  $1 \mu\text{g}/\text{m}^3$ ; petroleum VOC concentration above  $1$  to  $5 \mu\text{g}/\text{m}^3$ ).

The Task 2 deliverable, a standardized protocol for use of on-site GC/MS analysis for vapor intrusion investigations, was completed in 2012 (GSI, 2012b).

This report summarizes the results of Task 3 and recommends refinements of the protocol based on field demonstrations at four Department of Defense (DoD) sites. The draft investigation protocol was refined based on the results of the demonstration; the revised protocol is provided in Appendix E of this report.

### 1.1 BACKGROUND

Since 2000, regulators and the regulated community have become increasingly concerned about the potential for exposure to VOCs through vapor intrusion to indoor air at sites with contaminated soil or groundwater. Relatively few vapor intrusion case studies are available in the published literature (e.g., Folkes et al., 2009; Eklund and Simon, 2007; DiGiulio et al., 2006; Sanders and Hers, 2006). However, detailed investigations at a limited number of corrective action sites have documented elevated levels of chlorinated VOCs in houses located above contaminated groundwater (Tillman and Weaver, 2005; DiGiulio et al., 2006). In response to

these concerns, the United States Environmental Protection Agency (USEPA) and many state regulatory agencies have issued guidance specifying screening and field investigation procedures for the identification of vapor intrusion impacts at corrective action sites. Although the specific recommended investigation procedures vary significantly between guidance documents, the majority of these documents utilize a step-wise evaluation process that includes preliminary screening followed by field investigation, if needed. This step-wise process generally addresses:

Presence of Volatile Chemicals: Vapor intrusion is a potential concern at sites with soil or groundwater impacted by volatile chemicals. Corrective action sites without volatile chemicals (typically defined by vapor pressure and/or Henry's Law constant) require no further evaluation for vapor intrusion. Example volatility criteria are as follows:

- USEPA (2002): Volatile chemicals are defined based on Henry's Law Constant of greater than  $1 \times 10^{-5}$  atm-m<sup>3</sup>/mol.
- NJDEP (2006): Volatile chemicals are defined based on Henry's Law Constant of greater than  $1 \times 10^{-5}$  atm-m<sup>3</sup>/mol and a vapor pressure of greater than 1 mm Hg.

Pathway Screening Criteria: For sites with volatile chemicals in soil or groundwater, most regulatory guidance provides conservative screening criteria for preliminary evaluation of the vapor intrusion pathway. Screening criteria are typically provided for groundwater and soil gas and less commonly for soil. These criteria are typically used to evaluate the likelihood of whether VOCs are migrating away from a source area at concentrations that could cause a vapor intrusion impact. Although exceedances of these criteria do not indicate that a vapor intrusion impact has occurred or will occur, additional investigation of vapor intrusion is required if the maximum VOC concentration is greater than the screening value within a defined distance (typically 100 feet [ft]) of a vapor intrusion receptor (i.e., a current or future building). For some common chemicals of concern (COCs), the USEPA screening criteria for groundwater are equal to drinking water standards. In addition, some soil gas screening criteria are less than or equal to analytical detection limits. As a result, few corrective action sites are screened out of further evaluation using these criteria.

Building-Specific Evaluation: For sites with volatile chemicals present at concentrations above the screening criteria, most guidance documents require a field investigation to determine the presence or absence of vapor intrusion impacts to near-by buildings (commonly defined as within 100 ft of VOC impacts). When conducting a site-specific field investigation, the USEPA guidance recommends collection of below-foundation (i.e., sub-slab) gas samples followed by simultaneous below-foundation and indoor air samples, if needed. The USEPA guidance raises a number of data quality issues to be addressed as part of the field investigation including: indoor sources of VOCs (background), spatial variability, temporal variability, and sample collection and analytical variability.

Although vapor intrusion guidance documents typically utilize a step-wise investigation approach, most guidance documents use very low screening criteria for the preliminary evaluations. As a result, indoor air testing is often required.

Guidance documents often recommend determining indoor sources of VOCs as part of the investigation to help decipher the indoor air sample results. However, as a practical matter, pinpointing indoor sources of VOCs is difficult using conventional means such as visual inspections or occupant interviews. The benefit of the on-site analysis procedure is a more robust means to identify indoor sources of VOCs up front, early in the building evaluation process.

## **1.2 OBJECTIVE OF THE DEMONSTRATION**

Distinguishing between vapor intrusion and indoor sources of VOCs is a significant challenge in site assessments, greatly increasing the cost and complexity of investigations. Rapid on-site analysis of indoor air samples using a GC/MS allows the users to understand the distribution of VOCs in real-time, supporting a real-time identification of the source. For this project, we have developed a step-wise protocol for the use of on-site GC/MS analysis to distinguish between vapor intrusion and indoor sources of VOCs. The overall objective of the demonstration is to validate the accuracy and utility of the on-site analysis protocol for the evaluation of vapor intrusion. For this purpose, the protocol was applied at four demonstration sites (with one to two buildings at each site) and the results were compared with other available data to determine whether the protocol yielded an accurate assessment of vapor intrusion.

## **1.3 REGULATORY DRIVERS**

For many corrective action sites, the current regulatory framework requires a building-specific investigation of vapor intrusion if the concentrations of specific VOCs such as tetrachloroethylene (PCE), trichloroethylene (TCE) or benzene in groundwater are above federal drinking water standards and buildings are present within 100 ft of subsurface contamination (e.g., USEPA, 2002). In addition, most state and federal guidance documents utilize very low screening criteria for the preliminary evaluation, and some states (e.g., New York) do not allow screening based on subsurface VOC concentrations. Instead, indoor air testing is required at all field investigation sites (NYDOH, 2006).

Although testing of indoor air is the most direct method to determine whether screening criteria are exceeded, interpretation of results is often complicated. Indoor sources of VOCs are ubiquitous, resulting in detectable concentrations in indoor air that are often above regulatory screening levels. For example, background concentrations of TCE range from 0.3 to 1.6  $\mu\text{g}/\text{m}^3$  in houses unaffected by vapor intrusion (50<sup>th</sup> to 95<sup>th</sup> percentile values; Dawson and McAlary, 2009), concentrations that are the same level when compared to a residential  $10^{-6}$  risk limit of 0.43  $\mu\text{g}/\text{m}^3$  (USEPA, 2013). Background concentrations of TCE, benzene, and several other VOCs also commonly exceed regulatory screening levels (USEPA, 2011a).

Complexity or lack of specific regulatory guidance on conducting and interpreting data from indoor air investigations, combined with difficulty in distinguishing between sources of VOCs in indoor air (i.e., subsurface contaminant source vs. indoor source), often leads to ambiguous investigation results prompting additional investigations. The main benefit of on-site analysis is to provide identification of VOC sources while the investigation is in progress. Investigators can

then use this information to make decisions such as removal of indoor sources prior to collection of samples for regulatory decision-making.

## 2.0 TECHNOLOGY

The purpose of this project is to demonstrate the on-site GC/MS analysis of air samples as an effective investigation method to distinguish between vapor intrusion and indoor sources of VOCs. The use of on-site analysis for vapor intrusion investigations has been tested previously, most notably at Hill Air Force Base (AFB) (e.g., Gorder and Dettenmaier, 2011). However, there are currently no widely-accepted and validated protocols for such investigations. The purpose of this technology demonstration project is to develop and validate such protocols and make the use of on-site analysis methods more standardized and accessible to potential technical and regulatory users.

### 2.1 TECHNOLOGY DESCRIPTION

Use of on-site analysis to distinguish between vapor intrusion and indoor sources of VOCs requires a field-portable analytical instrument with sufficient sensitivity to measure VOC concentration in indoor air within the concentration range of regulatory concern (i.e., low  $\mu\text{g}/\text{m}^3$ ).

#### 2.1.1 Analytical Instrument

GC/MS is the gold standard for quantitative analysis of samples containing VOCs or other organic compounds. GC provides separation of a wide range of chemicals that may be present in a single sample. Following separation, the compounds are sent through an MS which uses a high-energy beam to break the compound into several ionized fragments. These fragments are separated according to their mass to charge ratio and the abundance of each fragment is measured. Each compound produces a unique fragmentation pattern that supports definitive identification of each compound in the sample. In addition, the sensitivity of the MS detector allows for quantitative measurements down to very low concentrations. As a result of its accuracy and sensitivity, over the last 20 years, GC/MS has become the predominant method for the analysis of VOCs and other organics in soil, water, and air samples.

The HAPSITE GC/MS is a field-portable instrument designed for on-site analysis of air and water samples by personnel without extensive training in analytical chemistry. The HAPSITE weighs approximately 35 pounds (without the battery) and is intended for transport from site to site in a suitcase-sized shipping container. The user interface is relatively simple so that proper use of the instrument requires only a few days of training. However, as discussed in Section 6.4, proper application of the on-site analysis protocol may require additional training. When operated in the quantitative GC/MS mode, the HAPSITE can accurately measure VOCs present in air samples at concentrations of less than  $1 \mu\text{g}/\text{m}^3$ . The HAPSITE can also be used in continuous-read survey mode to provide semi-quantitative identification of VOCs present in the 100s of  $\mu\text{g}/\text{m}^3$  concentration range.

The HAPSITE instrument has been commercially available since the 1990s. In 1997, the accuracy and sensitivity of the HAPSITE for the analysis of VOCs in water samples was verified through the USEPA Environmental Technology Verification (ETV) program (<http://www.epa.gov/etv>). This verification project demonstrated sensitivity for analysis of VOCs in water as low as  $5 \mu\text{g}/\text{L}$ , with accuracy and precision similar to fixed laboratory

analysis. Technological improvements have resulted in sensitivity for VOCs in air samples of approximately  $1 \mu\text{g}/\text{m}^3$  for the HAPSITE ER which was released in 2009.

Currently, the primary commercial application of the HAPSITE is in industrial hygiene and public safety. The HAPSITE is widely used by private industry to monitor worker exposure to industrial chemicals and by the military to monitor for chemical warfare agents. However, environmental applications of the HAPSITE, including vapor intrusion, are increasing. In late 2008, Hill AFB purchased a HAPSITE for on-site analysis of indoor air samples in residences with potential vapor intrusion concerns. The instrument immediately proved to be invaluable for the identification of previously undiscovered indoor sources of VOCs that had been confounding vapor intrusion investigations relying on conventional fixed-laboratory analysis (Gorder and Dettenmaier, 2011).

### **2.1.2 Precision and Accuracy Requirements**

Precision is the agreement in analytical results for repeated analysis of the same sample. Application of the HAPSITE for building-specific investigations relies on the ability to identify differences in target VOC concentrations between different locations within the building. The ability to identify spatial differences in VOC concentration is a strong function of instrument precision. With high precision, a small difference in measured VOC concentrations between two sample locations can be reliably interpreted as a true difference, as opposed to variability in sample measurements. This true difference, in turn, is used to determine the location of the VOC source. With low precision, a small difference in VOC concentration between sample locations may be an artifact of variability in instrument response making it more difficult to determine the location of the source.

Accuracy is the agreement between the instrument analytical response and a known concentration. Instrument accuracy is relatively unimportant for on-site GC/MS analysis for building-specific investigations. The investigation procedure is targeted primarily on identification of the source(s) of the VOCs being detected in indoor air, a process that requires high precision but not high accuracy because the on-site evaluations rely primarily on comparisons of relative, rather than absolute, magnitudes (i.e., is the concentration in the basement higher than on the main floor?). When the primary source of the target VOC is determined to be vapor intrusion, then the attainment of accurate results becomes more important because of the need to determine whether the vapor intrusion results exceed the indoor air screening level. However, as long as the margin of error is known, then the instrument results can be reliably interpreted even if the accuracy is less than that typically obtained from a fixed laboratory instrument. For example, if the accuracy is known to be  $\pm 100\%$  (i.e., 3-fold accuracy), then a measured VOC concentration that is more than 3 times above or below the indoor air screening concentration can be reliably interpreted as truly above or below the screening level. For concentrations within 3-fold of the screening level, a confirmation sample can be collected for off-site analysis.

### **2.1.3 Prior Application**

The use of on-site analysis to distinguish between vapor intrusion and indoor sources of VOCs has significantly streamlined building-specific vapor intrusion investigations at Hill AFB (Gorder and Dettenmaier, 2011), where indoor air testing has been conducted at over 2000

residences overlying or located in close proximity to affected groundwater associated with the facility. Prior to acquisition of the HAPSITE, detections of VOCs in indoor air at concentrations above the facility action level required extensive follow-up investigation and sometimes resulted in unnecessary installation of mitigation systems. Currently, a similar detection is followed by a 2-4 hour follow-up investigation using the HAPSITE. In over 90% of the houses investigated using the HAPSITE, an indoor source or sources emitting the specific VOC of concern has been located and removal has resulted in concentrations of the VOC falling below the action level. In many cases, the indoor sources have been products not previously recognized to be sources of the VOC. Examples include plastic decorations emitting 1,2-dichloroethane (1,2-DCA) (Doucette et al., 2009), taxidermy foam emitting trans-1,2-dichloroethylene (trans-1,2-DCE), and pepper spray canisters emitting TCE.

## **2.2 TECHNOLOGY DEVELOPMENT**

As noted above, the HAPSITE has been used for vapor intrusion investigations, primarily at Hill AFB and surrounding residences (Gorder and Dettenmaier, 2011). Although the HAPSITE proved valuable for the evaluation of vapor intrusion at Hill AFB, a standardized protocol has not been fully validated in order to better transfer the technology to DoD and private users, and to gain acceptance by the regulatory community. Additionally, the focus of prior work involved studies of residential buildings.

The purpose of this demonstration was to develop a specific protocol for the use of on-site GC/MS analysis to distinguish between vapor intrusion and indoor sources of VOCs, for use in a wide range of building types. The development of a validated protocol will support the application of this investigation procedure at other vapor intrusion sites across the county as well as regulatory acceptance of the results.

## **2.3 ADVANTAGES AND LIMITATIONS OF THE TECHNOLOGY**

This demonstration project used the HAPSITE portable GC/MS instrument manufactured by Inficon (<http://www.inficon.com>) to complete the on-site analysis for VOCs. We used the following instrument models during the course of the project: SMART (oldest version), SMART PLUS (intermediate version), and ER (current model manufactured by Inficon).

Alternate tools for on-site analysis are described in Section 2.3.1. Advantages and limitations of the technology itself (application of on-site GC/MS analysis to distinguish between vapor intrusion and indoor sources of VOCs) are discussed in Section 2.3.2. Our experience with reliability of the three HAPSITE models is discussed in Section 2.3.3.

### **2.3.1 Alternate Instruments for On-Site GC/MS Analysis**

The HAPSITE GC/MS is the only field-portable instrument (i.e., instrument specifically intended to be transported from site to site) with sufficient sensitivity to measure VOC concentrations in air as low as  $1 \mu\text{g}/\text{m}^3$ . However, on-site analysis of air samples by GC/MS could also be conducted using a mobile laboratory. A mobile laboratory usually consists of standard laboratory GC/MS instruments installed in a van or recreational vehicle (RV). Mobile laboratory analyses of air samples are offered by a number of commercial laboratories. In



addition, the USEPA can provide similar services with the Trace Atmospheric Gas Analyzer (TAGA) unit, although the equipment in this unit is more sophisticated and sensitive than standard commercial laboratory equipment. A mobile laboratory is somewhat less portable than the HAPSITE (i.e., cannot be shipped by air), and requires a more highly trained operator. On the other hand, some mobile laboratories are National Environmental Laboratory Accreditation Conference (NELAC) certified, increasing the regulatory acceptance of the results. NELAC or similar certification of results is typically required when the analytical results are used for health risk assessment or comparison to regulatory standards.

Because the HAPSITE is more portable and requires less operator training, this demonstration project utilized a HAPSITE for on-site GC/MS analysis. For this investigation procedure, the on-site results by the HAPSITE GC/MS are used to determine the source(s) of VOCs in indoor air. As discussed in Section 5.5.3, the investigation protocol includes the collection of a small number of samples for off-site laboratory analysis. These samples are used for definitive decision-making (i.e., to determine whether COC concentrations in indoor air exceed applicable screening values). The use of results from off-site laboratories for definitive decision-making reduces the need for NELAC certification of on-site results or similar extensive documentation of on-site data quality.

### **2.3.2 Advantages and Limitations of the On-Site Analysis Method**

This on-site analysis method is in contrast to conventional vapor intrusion investigation methods (e.g., those described in ITRC, 2007 and USEPA, 2002) which focus on off-site analysis for determining VOC concentrations with a limited number of subsurface and indoor air samples. Using this conventional approach, analytical results are typically not available for several weeks after the investigation has been completed. Because of the high potential for confounding results due to prevalence of indoor VOC sources, the results from the off-site lab, when received, are often difficult to interpret.

Advantages of the on-site analysis method include:

- *Real-time results:* The key advantage of the on-site analysis method is the ability to measure indoor air VOC concentrations and determine the primary sources (i.e., indoor vs. subsurface) in real time during the course of the field investigation. Because of the short analytical method run times, many samples can be collected while on site, resulting in a large volume of data available for interpretation while still in the field. This allows the investigators to more readily react to building-specific situations and make decisions (e.g., rule out vapor intrusion, determine potential vapor entry points, find primary VOC sources, etc.). Although the method focuses on on-site analysis, a small number of air samples are collected for off-site laboratory analysis to confirm key findings.
- *No sub-slab sample points:* The on-site analysis method does not require the installation of sub-slab sample points, eliminating the need to drill through the building foundation.
- *Reduced sampling requirements:* Because indoor sources of VOCs can be identified and removed during the investigation program, the on-site analysis method will more frequently yield definitive results compared to the conventional investigation approach,

reducing the need for follow-up sampling events. When the optional building depressurization method is used, the need for characterization of temporal variability may also be reduced or eliminated.

Potential limitations of the method include:

- *Equipment availability:* The HAPSITE GC/MS (SMART PLUS) or alternate instrument for on-site analysis is less common than the equipment used for the conventional investigation approach. As a result, equipment availability, procurement, and scheduling may be more complex.
- *Staff suitably trained in interpretation of vapor data:* The field team should include one more senior staff member with the knowledge, skills, ability and authority to make decisions in the field based on the on-site measurements. The team should also include at least one experienced HAPSITE operator.
- *Target compounds:* Specific target compounds should be sufficiently volatile to be detected at concentrations similar to the applicable indoor air screening concentration. Less volatile compounds such as naphthalene may not be good candidates for on-site analysis because it is difficult to calibrate the on-site instrument for analysis of low concentrations of less volatile compounds. Additionally, accurate identification may be problematic with certain VOCs (e.g., vinyl chloride, cis-1,2-dichloroethylene). This issue may be addressed by fine-tuning the analytical method or interpreting chromatograms and ion mass ratio data in the field.
- *Temporal variability:* Changes in building pressure relative to the subsurface can cause temporal variations in vapor intrusion. As a result, a one-day investigation program with uncontrolled building pressure conditions may not identify vapor intrusion that could occur under other building pressure conditions. The on-site analysis method itself does not account for potentially episodic vapor intrusion. The protocol (GSI, 2012b), however, includes an optional building pressure control step which minimizes concerns about temporal variability. Building depressurization, for example, will enhance the potential for vapor intrusion. Induced negative pressure will tend to draw subsurface vapors, if present, up into the building. As a result, an absence of vapor intrusion under both baseline and induced negative pressure conditions serves to reduce the concern regarding temporally-variable vapor intrusion.

### **2.3.3 HAPSITE Instrument Reliability**

Three models of the HAPSITE GC/MS have been manufactured by Inficon: the HAPSITE SMART (introduced in 2005); the SMART PLUS (introduced in 2008), and HAPSITE ER (introduced in 2008; current model produced by Inficon). All three instruments are capable of running customized methods suitable for the on-site analysis protocol. However, as discussed below, the functionality of the instruments is somewhat different. In addition, based on our experience during the implementation of this demonstration and other applications of the HAPSITE GC/MS instrument, there appear to be important differences in instrument reliability between the three models.

- *HAPSITE SMART*: We used a HAPSITE SMART once during the demonstration. The user interface on the SMART was not as intuitive as on the later models, making it difficult to check instrument settings and review results. Also, in contrast to the later HAPSITE models, this instrument does not have a wireless option, making it more difficult to utilize a laptop to review results. The SMART also appeared to have more day-to-day variability than the other instruments (average relative percent difference (RPD) between continuing calibration verification (CCV) standard concentration and HAPSITE sample result approximately 44% with SMART vs. 24% with SMART PLUS and ER; see Table D.1.5). Based on our limited experience with the SMART, we were unable to evaluate instrument reliability. However, we recommend against the use of the SMART for implementation of the on-site protocol due to the more limited user interface and reduced functionality.
- *HAPSITE SMART PLUS*: We used a SMART PLUS at one of the four demonstration sites. In addition, project team members have extensive experience with the SMART PLUS at other sites. Overall, the functionality of the SMART PLUS is similar to the ER. Based on our experience during the demonstration program and during other applications, the SMART PLUS is a very reliable instrument. The SMART PLUS performed as expected during all of the demonstration field programs. With proper routine maintenance, the SMART PLUS will rarely fail during a field program. Although the SMART PLUS is not currently manufactured by Inficon, instruments are available for rental from KD Analytical (<http://www.kdanalytical.com/>) and used instruments may be available for purchase from third parties. In addition, the DoD owns a large number of SMART PLUS instruments that may be available for use on some DoD facilities.
- *HAPSITE ER*: The HAPSITE ER is the only model currently manufactured by Inficon. We attempted to use the ER at all four demonstration sites, although the instrument failed at two of the four sites (see Section 6.1). In addition, project team members have extensive experience with the ER at other sites. Based on our experience during the demonstration and at other sites, the ER is much less reliable than the SMART PLUS. Both the instrument owned by GSI Environmental and the instrument owned by Hill AFB have been plagued by hardware and software problems that required shipment to Inficon for repair. Over a period of three years, the HAPSITE ER owned by GSI had to be sent to Inficon for repairs a total of 11 times. The ER instrument commonly failed during field programs forcing us to switch to a back-up instrument. The ER does feature some hardware and software improvements that modestly improve the functionality relative to the SMART PLUS. However, the sensitivity of the SMART PLUS and ER are similar. Based on the poor reliability of the ER, we do not recommend use of the HAPSITE ER for implementation of the on-site analysis protocol.

**Overall Finding:** We recommend use the HAPSITE SMART PLUS, but not the SMART or the ER for implementation of the on-site analysis protocol for evaluation of vapor intrusion.

### **3.0 PERFORMANCE OBJECTIVES**

The overall objective of the demonstration was to validate the draft protocol for the application of on-site GC/MS analysis to distinguish between vapor intrusion and indoor sources of VOCs. The demonstration was done in the field at “full-scale”, that is, in typical buildings subject to vapor intrusion investigations. This objective was met by:

- 1) Applying the draft protocol in one to two buildings with vapor intrusion concerns at each of four demonstration sites;
- 2) Utilizing the results obtained from the protocol to determine the vapor intrusion conditions in the buildings;
- 3) Conducting additional sampling in each building consisting of i) samples typically collected for a conventional vapor intrusion investigation and ii) application of the draft protocol for use of compound-specific stable isotope analysis (CSIA) for the investigation of vapor intrusion (from ER-201025; GSI, 2012e); and
- 4) Comparing the interpretation of the additional sampling to the interpretation from the on-site analysis results in order to determine the reliability and comparability of the different investigation approaches.

Specific quantitative and qualitative performance objectives are summarized in Table 1.

**Table 1: Performance Objectives**

Performance Objective	Data Requirements	Success Criteria and Results
<b>Quantitative Performance Objectives</b>		
1) Collection of data representative of site conditions using the on-site GC/MS.	<p>Results from on-site analysis of vapor-phase samples.</p> <p>Associated QA results (e.g., calibration curve, instrument blanks, calibration checks, duplicate analyses) to demonstrate acceptable instrument performance.</p>	<p>For &gt;75% of on-site analyses:</p> <ul style="list-style-type: none"> <li>• Precision: RPD &lt; 30% for duplicate samples</li> <li>• Accuracy: RPD &lt; 75% between CCV standard and on-site result; RPD &lt; 75% for paired samples analyzed on-site and off-site</li> <li>• Sensitivity: &lt; 1 µg/m<sup>3</sup> for chlorinated VOCs and &lt; 5 µg/m<sup>3</sup> for petroleum hydrocarbons</li> </ul> <p><b>Result: Data met precision, accuracy, and sensitivity goals.</b></p>
2) For confirmation samples analyzed by off-site laboratories, collection of data representative of site conditions.	<p>Results from off-site analysis of vapor-phase samples.</p> <p>Associated QA results (e.g., laboratory QA results, duplicate analyses) to demonstrate acceptable laboratory performance.</p>	<p>For &gt;90% of off-site analyses:</p> <ul style="list-style-type: none"> <li>• Precision: RPD &lt; 30% for field duplicate samples; RPD &lt; 25% for laboratory duplicate results</li> <li>• Accuracy: standard laboratory accuracy</li> <li>• Sensitivity: &lt; 1 µg/m<sup>3</sup> for all VOCs</li> </ul> <p><b>Result: Data met precision, accuracy, and sensitivity goals.</b></p>
<b>Qualitative Performance Objectives</b>		
3) Validation of the draft protocol for the use of on-site analysis to evaluate vapor intrusion.	<p>Determination of vapor intrusion conditions using i) results from application of the protocol, ii) conventional sampling approach, and iii) stable isotope analysis (per ER-201025).</p>	<p>Success will be achieved if:</p> <ol style="list-style-type: none"> <li>1) All three investigation methods yield definitive, consistent determinations regarding the presence or absence of vapor intrusion, or</li> <li>2) If one or more of the methods yield ambiguous results, attainment of a clearer determination using the on-site analysis method, as compared to the alternate methods.</li> </ol> <p><b>Result: At all seven of the demonstration buildings, the on-site analysis protocol performed as well as or better than the conventional investigation approach. At six of the seven buildings, the results from the on-site analysis protocol were consistent with the overall evaluation of the vapor intrusion condition based on the results from all three of the investigation methods combined.</b></p>
4) Implementability of the draft protocol for the use of on-site analysis to evaluate vapor intrusion.	<p>Field experience implementing the protocol and interpreting the results.</p>	<p>Determination that the protocol is implementable and cost effective.</p> <p><b>Result: Overall, the protocol is usable (by adequately trained personnel) and cost effective.</b></p>

### **3.1 OBJECTIVE 1: COLLECTION OF DATA REPRESENTATIVE OF SITE CONDITIONS USING ON-SITE GC/MS**

The collection of data that is representative of actual site conditions was achieved by adhering to the sampling and analysis procedures specified in the Demonstration Plan. These procedures are summarized in Section 5 of this report.

#### **3.1.1 Data Requirements**

Data collected to evaluate this performance objective included HAPSITE calibration records, results from daily QA samples such as blanks and CCV samples, and results from field duplicates.

#### **3.1.2 Success Criteria and Results**

QA samples were evaluated to determine the data precision, accuracy, completeness, representativeness, and comparability. Overall, the project data met the requirements of the Demonstration Plan and associated QAPP. Details of the data quality evaluation are presented in Section 6.1 of this report.

### **3.2 OBJECTIVE 2: COLLECTION OF DATA REPRESENTATIVE OF SITE CONDITIONS USING OFF-SITE LABORATORY ANALYSIS**

The collection of site data that is representative of actual site conditions was achieved by adhering to the sampling and analysis procedures specified in Section 5 of this report.

#### **3.2.1 Data Requirements**

To meet this performance objective, field personnel followed sampling and analysis procedures described in the Demonstration Plan and associated QAPP. Records were maintained and QA samples were collected. These samples included field duplicates and standard laboratory QA/QC.

#### **3.2.2 Success Criteria**

The procedures and QA samples were evaluated to determine the data precision, accuracy, and completeness. Overall, the project data met the requirements of the QAPP. Details of the data quality evaluation are presented in Section 6.2 of this report.

### **3.3 OBJECTIVE 3: VALIDATION OF DRAFT PROTOCOL FOR USE OF ON-SITE ANALYSIS TO EVALUATE VAPOR INTRUSION**

The goal of the field demonstration was to produce a validated procedure for the use of on-site analysis to evaluate vapor intrusion.

### **3.3.1 Data Requirements**

A draft protocol was developed prior to the field demonstration (GSI, 2012b). This draft was used as the basis of the demonstrations. Validation involved comparison of the results from application of the protocol with results obtained using other investigation approaches (see Section 5). The two approaches for comparison were: i) conventional building-specific vapor intrusion sampling (i.e., collection of sub-slab and indoor air samples); and ii) stable isotope analysis per ER-201025.

Each of the three data sets was analyzed independently to determine the presence or absence of vapor intrusion in the target building. Data evaluation methods are described in Section 5.7 and 6.3.

### **3.3.2 Success Criteria**

The demonstration plan included a data interpretation matrix for each investigation approach. The matrices were designed to yield a range of conclusions for each test building, from “no evidence of vapor intrusion” to “results not definitive” to “clear evidence of vapor intrusion,” depending upon the strength of lines of evidence for the particular approach.

The performance objective was considered met if: i) all three investigation methods yielded the same definitive determination regarding the presence or absence of vapor intrusion; or ii) definitive results were obtained from the on-site analysis method with ambiguous results from one or both of the alternative methods.

As discussed further in Section 6.3, the on-site analysis protocol performed as well as or better than the conventional protocol at all seven demonstration buildings. At six of the seven buildings (86%), the results from the on-site analysis protocol were consistent with the overall evaluation of the vapor intrusion condition based on the results from all three of the investigation methods combined.

## **3.4 OBJECTIVE 4: IMPLEMENTABILITY AND COST EFFECTIVENESS OF THE PROTOCOL FOR ON-SITE ANALYSIS**

The protocol should be implementable by environmental professionals with training and experience in interpretation of vapor data and/or operation of the on-site analysis equipment. The protocol should also be cost effective compared to alternative investigation methods.

### **3.4.1 Data Requirements**

We evaluated field experience obtained during the demonstration program. Qualitative success criteria included complexity of the protocol implementation and other logistical issues and costs associated with implementation.

### **3.4.2 Success Criteria**

Under most conditions, the protocol appears to be implementable and cost effective. These conditions and limitations are discussed further in Section 6.4. Based on the results of the field

demonstrations, we made minor modifications to the protocol. These changes are discussed in Section 6.4.3. A revised protocol which incorporates these changes is included in Appendix E.



## 4.0 SITE DESCRIPTION

The field demonstration was completed at a total of seven buildings at four sites: i) Joint Base Lewis-McChord near Tacoma, Washington; ii) Selfridge Air National Guard Base, near Detroit, Michigan; iii) Tyndall Air Force Base, near Panama City, Florida; and iv) the former Raritan Arsenal in Edison, New Jersey. At Joint Base Lewis-McChord and Tyndall AFB, on-site screening of additional buildings was conducted in order to select the two buildings at each site for implementation of the full demonstration program. The on-site GC/MS analysis demonstration was combined with the demonstration of another innovative vapor intrusion investigation method (compound-specific stable isotope analysis; ESTCP ER-201025). Both projects involve protocols to distinguish between indoor sources of VOCs and vapor intrusion. Site selection prioritized the following:

- *Building Characteristics*: Availability of one to three buildings at each site. Specific buildings for investigation were to be residential or industrial, large or small, and occupied or suitable for occupancy.
- *Subsurface Sample Points*: Presence of at least three existing subsurface sample points (either monitoring wells or soil gas sample points) with detectable concentrations of VOCs located within 1000 ft of a target building (either upgradient of the building or within 100 ft downgradient). These sample points were used to characterize the isotope fingerprint of the subsurface VOC source (ESTCP Project ER-201025).
- *Vapor Intrusion Concern*: Presence of building(s) with either i) known vapor intrusion issues; or ii) high vapor intrusion concern based on the presence of VOCs in close proximity to the building.
- *Building Access*: Availability of access to all parts of the building(s) during normal working hours for up to three days.

### 4.1 SITE LOCATION AND HISTORY

Each of the demonstration sites has a dissolved chlorinated solvent or petroleum hydrocarbon plume, or both, in shallow groundwater that has migrated away from the source (release) area. Prior to the demonstration, each site had been investigated in sufficient detail to provide an understanding of site geology and contaminant distribution in the subsurface and to allow selection of candidate buildings for the demonstration. Final selection of buildings for the demonstration was based on the existing data supplemented, in some cases, by field screening.

The demonstration sites included:

- *Joint Base Lewis-McChord (Lewis-McChord)*: This site is a military facility located south of Tacoma, Washington, that is an amalgam of US Army Fort Lewis and McChord Air Force Base. A chlorinated solvent plume is present in the uppermost aquifer beneath buildings in the Logistics Center. Because of the potentially large number of candidate buildings at the site, GSI prioritized the buildings by selecting buildings with footprints

located within 200 feet of a shallow zone monitoring well having TCE concentrations greater than 10 µg/L in the most recent monitoring event. This prioritization yielded eight buildings (Buildings 9522, 9671, 9666, 9679, 9674, 9669, 9564, and 9673). At the beginning of the field demonstration, indoor air in these buildings was screened using the HAPSITE. The key analyte used for screening was TCE, the primary COC in groundwater.

The highest TCE concentration (TCE 0.3 ppbV [1.6 µg/m<sup>3</sup>]) was found in Building 9669, which was selected as the first demonstration building. The other buildings had lower TCE concentrations, ranging from below detection limits to 0.03 ppbV (0.2 µg/m<sup>3</sup>). The second building for the demonstration, Building 9674, was selected based on building characteristics such as proximity to the groundwater plume, limited occupancy minimizing disruption to workers, and building construction.

- Selfridge Air National Guard Base (Selfridge): This site is an active military installation located north of Detroit, Michigan. Building 1533, located on the southwest corner of the base, was selected for the demonstration. This building is currently used as a maintenance facility for the U.S. Border Patrol.

Releases from two underground storage tanks (USTs) located northeast of Building 1533 were discovered in 1992. One of the tanks reportedly contained leaded gasoline and the other, diesel fuel. The tanks were removed in 1992, and remediation and groundwater monitoring have been conducted since that time. The shallow petroleum hydrocarbon plume is present beneath much of the Building 1533 footprint. The key target compound in groundwater is benzene.

- Tyndall Air Force Base (Tyndall): This site is an active military installation located near Panama City, Florida. Chlorinated solvent plumes are present in shallow groundwater beneath several on-site buildings. To prioritize buildings for investigation, GSI reviewed building locations relative to recent groundwater monitoring results, focusing on TCE, one of the key COCs in groundwater. Based on this evaluation, we prioritized six buildings: Building 156, 246, 219, 522, 258, and 560. GSI screened the indoor air in the six buildings, analyzing the samples with a HAPSITE SMART instrument. TCE concentrations were typically less than 0.1 ppbV (0.54 µg/m<sup>3</sup>). Because the concentrations were relatively low and uniform, Buildings 156 and 219 were selected for the demonstration based on proximity to impacted groundwater and ease of access.
- Former Raritan Arsenal Site (Raritan): This Formerly Used Defense Site (FUDS) is located in Middlesex County, New Jersey. The site was operated by the US Army and was used for handling ammunition and ordnance from 1917- 1963. Since site closure in 1963, various environmental investigation, remediation, and monitoring projects have been conducted. Over the last 10 years, more than 45 buildings have been evaluated for the vapor intrusion pathway, and six are subject to ongoing monitoring. Several buildings have had mitigation systems installed (Weston, 2012). Two buildings, Campus Plaza 4 (CP4) and Building 209, were selected for the demonstration because i) they are located near shallow impacted groundwater plumes; ii) they do not have active mitigation

systems; and iii) historical indoor air and sub-slab sample results are available for comparison from 2004 - present (Campus Plaza 4) and 2006 - present (Building 209).

Both buildings are large and have been partitioned into separate suites to accommodate the current tenants. Campus Plaza 4 is occupied by three tenants and the property owner's firm. To screen the building, at least one indoor air sample was collected in each of the four spaces. Building 209 has been divided into six different sections used for office and/or lab space. One indoor air sample was collected in each section for screening. Based on TCE concentrations in the screening results, the office/warehouse space on the west end of Campus Plaza 4 was selected for detailed evaluation. TCE indoor air concentrations in the west end were approximately 1 ppbV ( $5.4 \mu\text{g}/\text{m}^3$ ), but ranged from below detection limits to 0.2 ppbV ( $1 \mu\text{g}/\text{m}^3$ ) in the other office spaces. At Building 209, TCE, the key COC in groundwater, was not detected in any indoor air screening sample. However, PCE was detected in indoor air. Based on these results, a central bay was selected for detailed evaluation. The indoor air PCE screening concentration in that bay was 0.07 ppbV ( $0.48 \mu\text{g}/\text{m}^3$ ), but ranged from 0.03 to 0.05 ppbV ( $0.2$  to  $0.34 \mu\text{g}/\text{m}^3$ ) in the other bays.

A total of seven commercial buildings were included in the field demonstration. The demonstration included conventional VI sampling in each building as well as application of the on-site GC/MS analysis and compound-specific stable isotope analysis (CSIA) protocols as summarized in Table 2. Because of the low VOC concentrations at some buildings, limited sampling for the CSIA demonstration was done at Lewis-McChord Building 9674, Tyndall Building 156, Tyndall Building 219, and Raritan Building 209.

**Table 2: Demonstration Buildings**

Building / Use	Size (sq ft)	Construction	Key VOC for VI Evaluation	On-Site GC/MS Analysis Demonstration Completed (ER-201119)	CSIA Demonstration Completed (ER-201025)
<b>Joint Base Lewis-McChord, Washington</b>					
9669/ Warehouse <sup>1</sup>	20,000	Slab on grade	TCE	Yes	Yes
9674/ Hazardous Waste Storage	4,000	Slab on grade	TCE	Yes	Partial
<b>Selfridge Air National Guard Base, Michigan</b>					
1533/ Vehicle Maintenance	2,000	Slab on grade	Benzene	Yes	Yes
<b>Tyndall Air Force Base, Florida</b>					
156/ Airplane Hanger Workshop <sup>2</sup>	4,000	Slab on grade	TCE	Yes	Partial
219 / Office <sup>3</sup>	7,000	Slab on grade	TCE	Yes	Partial
<b>Former Raritan Arsenal, New Jersey</b>					
Campus Plaza 4 <sup>4</sup> Office and Warehouse	30,000	Slab on grade	TCE	Yes	Yes
Building 209 Bay C <sup>5</sup> / Laboratory	14,000	Slab on grade	TCE	Yes	Partial

## Notes:

1. Building 9669 is approximately 40,000 sq ft and is divided into 2 halves. The demonstration was conducted the southeastern half of the building.
2. Building 156 is approximately 34,000 sq ft and is divided into multiple sections. The demonstration was conducted in the northern section of the building housing wood shops and paint booth rooms.
3. Building 219 is approximately 23,000 sq ft. The demonstration was conducted in the central portion of the building where access was granted.
4. Campus Plaza 4 building area is approximately 73,500 sq ft. The demonstration was conducted in the western portion of the building.
5. Building 209 building areas is approximately 105,200 sq ft. The demonstration was conducted in one of the central bays of the building.

## 4.2 SITE GEOLOGY, HYDROGEOLOGY, AND CONTAMINANT DISTRIBUTION

The demonstration sites and buildings have varying degrees of concern with respect to vapor intrusion based on previously conducted environmental assessments. The geology, hydrogeology, and contaminant distribution at each site are summarized in Table 3.

**Table 3: Demonstration Site Geology/Hydrogeology and Key Contaminants**

Site	Geology/Hydrogeology	Contaminant Distribution
<p>Joint Base Lewis-McChord Logistics Center</p>	<p>Shallow stratigraphy consists of alternating glacial and non-glacial sediments (Envirosphere, 1988).</p> <p>Depth to water approximately 20-30 ft bgs.</p> <p>Hydraulic gradient to the northwest.</p>	<p>Chlorinated VOCs (cVOCs) are present in shallow groundwater as a result of historic releases from former disposal areas located upgradient of the buildings.</p> <p>cVOCs included in site groundwater monitoring program: TCE, cis-1,2-DCE, PCE, 1,1,1-TCA, VC.</p> <p>Near the demonstration buildings, TCE concentrations in groundwater in the shallow aquifer range from 60 – 110 µg/L, based on monitoring conducted in Spring 2012.</p>
<p>Selfridge Air National Guard Base</p>	<p>Shallow stratigraphy consists of glacial lake sediments (e.g., clays and silts) overlying a sedimentary bedrock. In the vicinity of Building 1533, shallow soils are predominantly sand and gravel fill. Underlying the fill is a clay layer approximately 30-40 feet thick (AMEC, 2009).</p> <p>Depth to water approximately 2 – 6 ft bgs.</p> <p>Hydraulic gradient to the south-southwest.</p>	<p>Impacted soils were excavated from the former UST basin and nearby areas in 1992 and 2003. Remaining soil and groundwater impacts are present along the western edge of the former UST basin/excavation area, under the eastern portion of Building 1533, and south of Building 1533.</p> <p>Key COCs from the site investigation are benzene, toluene, ethylbenzene and xylenes (BTEX) and polyaromatic hydrocarbons (PAH) compounds. Benzene was considered the primary COC for the vapor intrusion evaluation.</p>

Site	Geology/Hydrogeology	Contaminant Distribution
Tyndall Air Force Base	<p>Shallow stratigraphy consists primarily of unconsolidated sands approximately 50 ft thick. This interval is underlain by calcareous sandy clay to clayey sand (Jackson Bluff Formation).</p> <p>Depth to the water table aquifer ranges from 2 – 7 ft bgs.</p> <p>In the vicinity of the study building, the hydraulic gradient is generally towards the north/northeast.</p>	<p>cVOCs are present in shallow (water table) and deeper zones at the site. The areal extent of cVOCs in the shallow zone is smaller than in the deeper zones.</p> <p>Recent groundwater monitoring results near the demonstration buildings indicate that TCE and cis-1,2-DCE are the primary constituents. Concentrations near Building 156 range from 31 – 299 µg/L (TCE) and 21 – 101 (cis-1,2-DCE) [URS, 2008]. Near Building 219, TCE concentrations are less than 10 µg/L; cis-1,2-DCE concentrations have been measured at more than 2,000 µg/L (3E Consultants, 2011).</p>
Former Raritan Arsenal Site	<p>The shallow stratigraphy consists of interbedded sands and clays. Gravels may also be present.</p> <p>There are two separate plumes with separate source areas in the vicinity of Campus Plaza 4 and Building 209. The hydraulic gradient in both areas is generally towards the southeast (Weston, 2013).</p> <p>The Campus Plaza 4 building is located above the Area of Concern 2 plume. The depth to water in the vicinity of Campus Plaza 4 is approximately 10 ft bgs.</p> <p>Building 209 is located approximately 150 feet west of the Area of Concern 8 A/B plume. Depth to water in the vicinity of Building 209 is approximately 30 ft bgs.</p>	<p>2012 groundwater monitoring results near the demonstration buildings indicate that TCE is the primary COC. At Campus Plaza 4, TCE concentrations are approximately 8 µg/L. Near Building 209, TCE concentrations range from below detection (in a monitoring well next to the building) to approximately 2 µg/L upgradient of the building.</p>

## 5.0 TEST DESIGN

### 5.1 CONCEPTUAL EXPERIMENTAL DESIGN

The purpose of the field demonstration was to validate two different, innovative vapor intrusion investigation methods: i) compound-specific stable isotope analysis (ER-201025); and ii) on-site GC/MS analysis (ER-201119). In general terms, the validation process consisted of implementing a conventional vapor intrusion investigation program along with the two innovative methods at each demonstration building (Figure 1). The results from each of the three sampling programs were then evaluated to determine the comparability of the three methods as well as the effectiveness of the methods in differentiating vapor intrusion from indoor sources of VOCs.

**Figure 1: Building-Specific Field Testing Schedule**

	Day 1	Day 2	Day 3
1. Conventional VI Investigation Method			
a. Questionnaire and indoor source removal (if any)	Red		
b. Install sub-slab sampling points	Red		
c. Collect sub-slab vapor samples (grab)	Red	Orange	
d. Collect indoor and ambient (outdoor) air samples (8-hour)	Red	Orange	
2. CSIA (ESTCP Project ER-201025)			
a. On-site screening to determine sampling parameters <sup>3</sup>	Red		
b. Collect indoor air sample	Red	Orange	
c. Collect subsurface source sample	Red	Orange	
3. On-Site Analysis Method			
a. Baseline measurements and sampling		Red	
b. Building pressure control and follow-up sampling			Orange

Notes: 1) Pre-sampling equipment checks and calibration are not shown. These activities occurred prior to any building investigations (prior to “Day 1”); 2) Orange = contingent; 3) For CSIA, VOC concentrations must be estimated to determine sample locations and sampling time.

#### 5.1.1 Conventional Program - Collection of Indoor Air and Sub-Slab Soil Gas Samples

Currently, building-specific vapor intrusion investigations are most commonly conducted by collecting a limited number of indoor air and sub-slab soil gas samples for off-site analysis. The results are interpreted using a multiple lines-of-evidence approach.

The conventional program was completed first. A visual building survey, interview with building representative, and record review were conducted to identify indoor VOC sources for removal prior to sampling, consistent with conventional approaches. No indoor sources were identified and removed from any of the demonstration buildings using this approach. The conventional sampling program implemented in each building is summarized in Table 4.

**Table 4: Summary of Conventional Vapor Intrusion Sampling Program**

Component	Matrix	Typical Number of Samples <sup>1</sup>	Analyte	Location
Conventional Vapor Intrusion Sampling Program (each test building)	Indoor air	2	VOCs	Indoors, with number of locations depending on building size
	Sub-slab vapor	3	VOCs	Sub-slab, 3 locations
	Ambient air	1	VOCs	Outdoors, upwind of building

Note: 1) Table does not include QA samples.

### 5.1.2 Collection of Samples for Stable Isotope Analysis

ESTCP Project ER-201025 involves the use of CSIA for the evaluation of vapor intrusion. Because the on-site analysis protocol could include identification and removal of indoor VOC sources as well as manipulation of building pressure conditions, the CSIA and conventional programs were completed first to avoid inadvertently influencing the results of these programs.

The CSIA sampling program is summarized in Table 5. Additional detail concerning the CSIA sampling program is provided in the ER-201025 Demonstration Plan (GSI, 2012d).

**Table 5: Summary of CSIA for Vapor Intrusion Sampling Program**

Component	Matrix	Number of Samples <sup>1</sup>	Analyte	Location
CSIA for Vapor Intrusion Sampling Program (each test building)	Indoor air	1 - 3	Isotope ratios for target VOC	Inside target building
	Sub slab vapor	1	Isotope ratios for target VOC	Below target building foundation
	Subsurface source	1 - 3	Isotope ratios for target VOC	Nearby monitoring well(s)

Note: 1) Table indicates approximate number of samples collected. Detailed information concerning the logic for determining the sample locations and the specific number of samples is provided in the Demonstration Plan for ER-201025 (GSI, 2012d).

### 5.1.3 Protocol for Use of On-Site Analysis for Vapor Intrusion

Following collection of the conventional samples and CSIA samples, the on-site analysis protocol (GSI, 2012b) was implemented in each building. The protocol uses a step-wise sampling and analysis process to identify vapor entry points and indoor sources of VOCs (see Figure 2). The specific number of samples collected varied from building to building because the scope of each step in the investigation process is defined by the prior results.



**Figure 2: Demonstration Process for On-Site Analysis to Evaluate Vapor Intrusion**

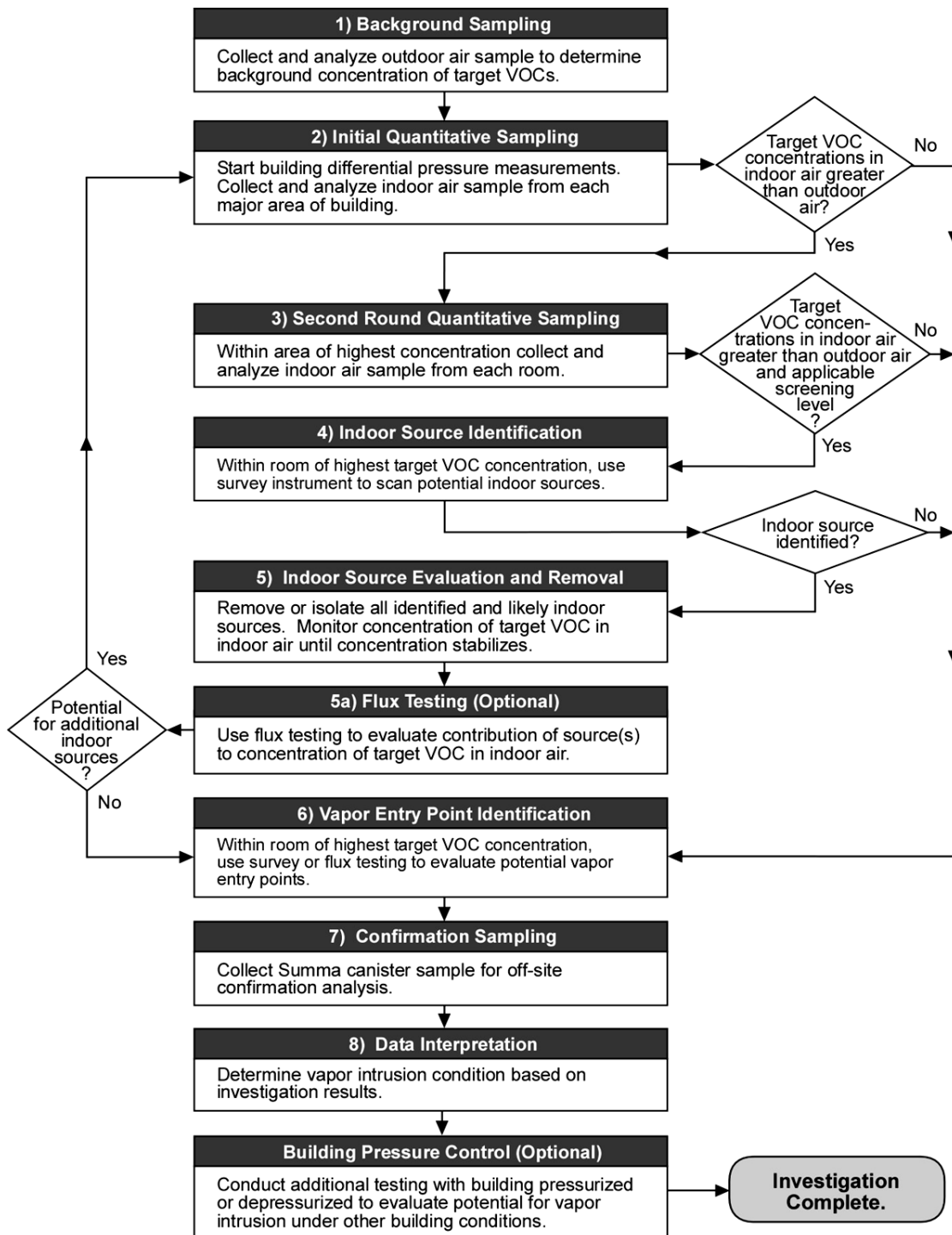

Notes: 1) The last step of the process (investigation complete) refers to the field investigation program. Additional investigation of the building may or may not be required, depending on final evaluation of the results, including results from confirmation samples analyzed by the off-site laboratory. 2) This flow chart was used as the basis of the demonstration. A revised flow chart which incorporates findings from the demonstration is provided in Appendix E.

## 5.2 BASELINE CHARACTERIZATION

As discussed in Section 4, site and building selection was based on pre-existing data. No additional baseline characterization was conducted prior to the demonstration at each building.

## 5.3 LABORATORY STUDY RESULTS

A laboratory study was conducted to validate the use of the HAPSITE portable GC/MS instrument for measurement of low concentrations of VOCs (i.e., as low as  $1 \mu\text{g}/\text{m}^3$ ) in indoor air. The laboratory study included a side-by-side comparison of results from HAPSITE-analyzed air samples to samples analyzed by a fixed-base laboratory.

A HAPSITE ER instrument was used for the lab study. Fixed-base laboratory analysis was conducted at H&P Mobile Geochemistry Inc. in Carlsbad, California. Based on this study, on-site GC/MS analysis was determined to have sufficient accuracy, precision, and sensitivity to effectively distinguish between vapor intrusion and indoor sources of VOCs (GSI, 2012a).

## 5.4 DESIGN AND LAYOUT OF TECHNOLOGY COMPONENTS

At each building selected for the demonstration, the field program consisted of i) collection of samples associated with a conventional VI investigation; ii) collection of samples for demonstration of CSIA for VI evaluation; and iii) implementation of the on-site analysis protocol. Sections 5.4.1-5.4.3 describe sampling point installation procedures for each of the investigation methods.

### 5.4.1 Installation of Sampling Points for Conventional Samples

Sub-slab Sample Points: For the first three demonstration sites (Lewis-McChord, Selfridge, and Tyndall), three sub-slab sample points were installed in each test building to characterize the distribution of VOCs below the building foundation. Specific sample locations were distributed across the building and were adjusted to minimize the disturbance of building activities. Sample points for the collection of sub-slab soil gas samples were installed by drilling a  $\frac{3}{4}$  to 1 inch hole through the building slab and into the underlying soil or fill material to a depth of 3 to 4 inches below the base of the foundation. A length of  $\frac{1}{8}$  inch (outside diameter) nylon tubing was placed in the hole and covered with approximately 3-4 inches of 20/40 sand. The remainder of the hole was sealed with a combination of hydrated bentonite clay and modeling clay. The end of the tubing was plugged with modeling clay when samples were not being collected. After sample collection was completed, the sample points were removed and the holes were sealed with cement or concrete patch.

At the last demonstration site (Raritan), permanent sub-slab sampling points had previously been installed for on-going VI monitoring. Rather than install new sub-slab sampling points, GSI used the existing points in the test buildings at this site.

Indoor Sample Points: For each test building, one to three indoor air sample points were collected to characterize the distribution of VOCs inside the building. Specific sample points

were selected based on an evaluation of building operating characteristics, building size, and layout. Sample locations were also chosen to minimize disruption of building activities.

Outdoor Sample Point: For each demonstration site, at least one ambient (outdoor) air sample point was selected at each site to characterize the concentration of VOCs outside the building. Specific sample points were selected to balance the following factors: i) upwind; ii) avoid disruption to building occupants; and iii) location next to the HVAC system air intake if access to this point was available.

#### **5.4.2 Sampling Points for CSIA Samples**

Matrices sampled for the CSIA program included groundwater, sub-slab soil gas, and indoor air. Groundwater samples were collected from existing, near-by monitoring wells. Sub-slab and indoor air samples were typically collected from the same locations as the conventional samples. Additional information on sampling point selection for the CSIA program is provided in the final report for ER-201025.

#### **5.4.3 Sampling Points for On-Site Analysis Protocol**

Implementation of the on-site analysis protocol does not require the collection of any samples from the subsurface and, therefore, did not require the installation of any sample points. Indoor air sample locations were selected in accordance with the protocol (see Figure 2).

### **5.5 FIELD TESTING**

One round of testing was conducted at each demonstration building following installation of the sampling points, as applicable.

#### **5.5.1 Field Testing for Conventional Vapor Intrusion Program**

Conventional vapor intrusion investigation programs do not typically utilize field testing. An attempt to identify and remove indoor sources of VOCs is commonly conducted using a questionnaire and interview with the building owner or operator.

For each of the test buildings, the investigation team met with building representative(s) to complete an occupied building questionnaire and to conduct a visual inspection for potential indoor sources. For the Raritan buildings, previously-completed questionnaires were available for review.

No indoor VOC sources were removed from the test buildings based on these procedures.

#### **5.5.2 Field Testing for CSIA Samples**

Collection of vapor-phase samples for CSIA required an estimation of the concentration of the target VOC at the sample location (GSI, 2012e). Indoor air and sub-slab sampling locations were screened with a HAPSITE instrument. The screening results were used to estimate target VOC concentrations which were then used to estimate sampling parameters.

### 5.5.3 Field Testing for On-Site Analysis Protocol

On-Site Analysis using the HAPSITE GC/MS: Prior to initiation of the on-site analysis program at each site, the GC/MS instrument was calibrated (GSI, 2012b, Appendix B). QA samples were also analyzed on a daily basis: i) in the morning, prior to any building sampling; ii) at mid-day; and iii) at the end of the day, after completion of building samples. The QA samples included blanks and CCV samples.

At each building, the on-site testing was conducted in a step-wise manner. These steps included i) background (outdoor air) sampling; ii) initial quantitative sampling; iii) second round quantitative sampling; iv) indoor source identification; v) indoor source evaluation and removal; vi) vapor point entry identification; vii) confirmation sampling; and viii) data interpretation. Based on the results of each step, some of these elements were conducted more than once (see Figure 2).

The number of analyses typically conducted for each step in the investigation is summarized in Table 6. QA samples were also collected and analyzed during implementation of the on-site testing program to ensure proper functioning of the GC/MS.

**Table 6: Typical On-Site Analysis Program for Field Demonstration**

Investigation Step	Typical Number of Analyses Per Building	Analysis Type
1) Background Sampling	1	On-site GC/MS
2) Initial Sampling	3 – 6	On-site GC/MS
3) Second Round Sampling	3 – 6	On-site GC/MS
4) Indoor Source Identification <sup>1</sup>	4 – 8 <sup>1</sup>	On-site MS (i.e., survey mode)
5/5a) Indoor Source Testing <sup>2</sup>	1 - 2 <sup>2</sup>	On-site GC/MS
6) Vapor Entry Point Identification/ Testing <sup>2</sup>	4 - 8 <sup>1</sup>	On-site MS and on-site GC/MS
7) Confirmation Sampling (for comparison to regulatory screening levels)	1 - 3	Off-site GC/MS
On-site QA Samples: Duplicate on- site analyses	≥ 1 per 20 on-site analyses	On-site GC/MS

Note: 1) For Source Identification, each “sample” represents one potential source item or potential vapor entry point screened using the HAPSITE continuous-reading survey mode. 2) For Source Testing, each “sample” represents one potential source product or potential vapor intrusion entry point tested using a source product emission chamber or entry point isolation protocol.

The on-site analysis protocol includes an optional procedure for induced building pressure control (pressurization or depressurization, see GSI, 2012b). For sites without vapor intrusion under building conditions present at the time of the investigation, the optional building depressurization program can provide additional information concerning the potential for vapor intrusion under other building operating conditions. In addition, for buildings with indoor sources that cannot be removed, manipulation of building pressure can provide additional information concerning the relative contribution of indoor sources vs. vapor intrusion. The optional building pressurization procedure was implemented in at least one building at each demonstration site.

Measurement of Pressure Gradients: Pressure gradients across the building envelope were used to evaluate the predominant direction of airflow. This information was used to help evaluate the results from the on-site analysis. For example, if the pressure gradient across the building envelope indicated positive building pressure (i.e., building pressurized relative to outdoors), then it is more likely that any elevated concentrations of the target VOCs in indoor air were originating from an indoor source.

Pressure gradients were measured using an Omniguard 4 differential pressure transducer equipped with a data logger. The instrument has two pressure ports: a reference port open to the indoor atmosphere and a second port open to the area to be measured (sub-slab space or outside the building as shown in Figure 3). Readings are obtained by measuring the pressure difference between the two ports. Measurements were collected at each demonstration building, with the instrument set to record at 5 minute intervals.

**Figure 3: Example Pressure Transducer Installation**



## **5.6 SAMPLING AND ANALYSIS METHODS**

As described above, three different vapor intrusion investigation methods were employed during the demonstration. Each method included specific sampling procedures and analysis of samples at an off-site laboratory. Laboratory analytical methods are summarized in Table 7.

**Table 7: Laboratory Analytical Methods for Demonstration**

Matrix	Analyte	Method	Container	Preservative	Holding Time
<b>Conventional Vapor Intrusion Program</b>					
Vapor	VOCs	USEPA TO-15 <sup>1</sup>	6-L Summa Canister	None	30 days
<b>CSIA Program</b>					
Vapor	VOCs and corresponding isotopes	Klisch et al., 2012 <sup>2</sup>	Sorbent tube	Ice	4 weeks <sup>2</sup>
Ground -water	VOCs and corresponding isotopes	Klisch et al., 2012 <sup>2</sup>	VOA vials	Ice	2 weeks
<b>On-Site GC/MS Program</b>					
Vapor	Radon	McHugh et al., 2008 <sup>3</sup>	1-L Tedlar bag	None	14 days <sup>4</sup>
	VOCs	USEPA TO-15 <sup>1</sup>	6-L Summa Canister	None	30 days

Notes:

1) Samples analyzed by ALS/Columbia Analytical Services in Simi Valley, CA.

2) Samples analyzed by the University of Oklahoma, Norman, OK. Holding time for vapor samples was originally 2 weeks but has been extended based on additional studies. See ER-201025 final report.

3) Samples analyzed by the University of Southern California, Los Angeles, CA.

4) No holding time specified, but lab tests demonstrate accurate results after 14 days storage in Tedlar bag (McHugh et al., 2008).

### 5.6.1 Conventional Vapor Intrusion Program

The conventional sampling program consisted of indoor and ambient air and sub-slab soil gas sample collection for VOC analysis.

Collection and Analysis of Indoor and Ambient Air Samples: At each test building, indoor and outdoor air samples were collected in individually certified, 6L Summa canisters. Flow controllers were used to collect 8-hour composite samples for analysis of VOCs by USEPA Method TO-15 or TO-15 SIM.

Collection and Analysis of Sub-Slab Gas Samples: Prior to sample collection, the sample points were purged and a helium tracer test was conducted to verify that the point was not leaking. The test was conducted by threading the sample point tubing through a shroud. The shroud was then filled with at least 10% helium, as measured with an MGD-2002 portable helium detector. After the shroud filled with the desired amount of helium, the helium meter was attached to the probe tubing. The point passed the leak test if the concentration in the tubing was less than 10% of the concentration in the shroud. In addition to the helium tracer test, a shut-in test was conducted to verify that the sampling train did not leak. Any leaks at the probe point or in the sampling train were repaired by rehydrating the bentonite or tightening connections in the sampling train, respectively. After confirming that the points were leak free, the sample was collected. Samples were collected in individually certified, 6L Summa canisters. The samples were collected as

grab samples (i.e., without flow controllers) for analysis of VOCs by USEPA Method TO-15 or TO-15 SIM.

### **5.6.2 CSIA Samples**

The procedures used for the collection of CSIA samples are provided in the ER-201025 sampling protocol (GSI, 2012e). In general, three types of locations were selected for sampling: i) groundwater (to evaluate the subsurface source); ii) sub-slab (to evaluate the soil gas beneath the building); and iii) indoor air. Groundwater samples were collected in 60 mL VOA vials using standard groundwater sample collection methods. Sub-slab and indoor air samples were collected using active sorbent tube methods. Specific sample locations were chosen based on initial vapor/air screening results from on-site GC/MS analysis. Sub-slab samples were collected from sub-slab probe points installed for the conventional vapor intrusion program.

### **5.6.3 Samples to Support the On-Site Analysis Protocol**

Collection and Analysis of Indoor Air Samples: The majority of samples collected for this protocol are analyzed on-site. However, at the end of each phase of the protocol (i.e., baseline building characterization, characterization of depressurized building conditions, etc.), a sample is collected for off-site laboratory analysis. These samples are used to i) confirm the accuracy of the on-site analysis results; and ii) to provide fully validated documentation of VOC concentrations in indoor air at the conclusion of the on-site testing program. An individually certified, 6-L Summa canister was used to collect a grab sample for analysis of VOCs by USEPA Method TO-15 or TO-15 SIM. Separate ambient (outdoor) air samples were not collected for this portion of the demonstration because an ambient air sample was already collected for the conventional program (Section 5.6.1).

Collection and Analysis of Indoor and Outdoor Air Samples for Radon: At each test building where the optional building pressure control procedure was implemented, at least two indoor air samples and one ambient air sample were collected in Tedlar bags for off-site radon analysis. The indoor air samples for radon analysis were paired with the samples collected in Summa canisters for VOC analysis.

### **5.6.4 Sample Summary and Quality Assurance Procedures**

In addition to samples collected for the demonstration (summarized in Table 8 below), samples were collected for QA purposes. QA samples collected for off-site laboratory analysis consisted of field duplicates and trip blanks. Field duplicates were collected at a rate of at least 1:20 Summa canisters, 1:20 Tedlar bags, and 1:10 sorbent tubes. One sorbent tube trip blank was also analyzed for each demonstration site.

In addition to QA samples, other measures were taken to assure data quality. These measures included:

- Adherence to the Demonstration Plan and associated QAPPs (GSI, 2012c)
- Calibrating the HAPSITE prior to each demonstration, and analyzing field QA samples
- Use of Decontamination Procedures, where applicable. All sampling equipment was either i) single-use, disposable material; or ii) flushed/purged before samples were

collected. Equipment used to collect samples from locations with potentially high VOC concentrations (e.g., sub-slab sample points) was not used subsequently for the collection of low concentration samples (e.g., indoor air). Sample containers used for collection of sub-slab, indoor and ambient vapor samples (Summa canisters) were individually certified clean by the lab that provides them to prevent any contamination from previous samples. Samples collected for radon analysis were collected using single-use Tedlar sample bags.

- **Sample Documentation.** Field documentation was facilitated by pre-printed tables, labels, and log forms that simplified and allowed for more precise notation of sample collection and conditions while in the field. All samples for laboratory analysis were submitted under chain-of-custody control. All laboratory reports included a narrative that discussed any quality control excursions. Photographs were also taken to document project activities.
- **Instrument Downloads.** To avoid transcription errors, pressure readings collected with the differential pressure transducer were logged by the instrument and then later downloaded as an electronic data file. Data recorded on the HAPSITE instrument were downloaded as electronic files and imported into a database to facilitate analysis.

## **5.7 SAMPLING RESULTS**

Tables 8 and 9 summarize the demonstration program and key analytes considered for each demonstration building. Building vapor intrusion classifications based on the investigation approach and associated lines of evidence are summarized in Appendix B. Comprehensive sampling results for each demonstration site are included in Appendix C. Appendix D includes tables summarizing the data quality review, QA forms, and laboratory reports.



**Table 8: Summary of Demonstration Program**

Site / Building	Conv. VI Program			CSIA			On-Site Analysis		
	Sub-slab Sample Locations	Indoor Air Sample Locations	Outdoor Air Sample Locations	Source (GW) Sample Locations	Sub-slab Sample Locations	Indoor Air Sample Locations	On-Site GC/MS Indoor Air Samples	On-Site Surveys	Pressure Conditions Tested
<b>Joint Base Lewis-McChord, Washington</b>									
Building 9669	3	2	1	3	1	1	35	3	BL, NP, PP
Building 9674	3	1	1	0	0	0	7	0	BL, NP
<b>Selfridge Air National Guard Base, Michigan</b>									
Building 1533	3	1	1	1	2	1	28	6	BL, NP, PP
<b>Tyndall Air Force Base, Florida</b>									
Building 156	3	3	0	1	1	0	14	0	BL, NP
Building 219	3	2	1	1	1	1	9	0	BL
<b>Former Raritan Arsenal Site, New Jersey</b>									
Campus Plaza 4	2	2	1	2	1	2	56	0	BL, NP
Building 209	2	2	1	2	1	0	10	0	BL

Note: BL = baseline (normal) operating conditions; NP = induced negative pressure; PP = induced positive pressure

**Table 9: Key Analytical Parameters**

Site / Building	Conv. VI and On-Site Analysis Program		CSIA		
	TO-15 (Key Analyte <sup>1</sup> )	On-Site Analysis (Key Analyte <sup>1</sup> )	Compound	Isotope 1	Isotope 2
<b>Joint Base Lewis-McChord, Washington</b>					
Building 9669 <sup>2</sup>	cVOCs (TCE)	cVOCs (TCE <sup>2</sup> )	TCE	$\delta^{13}\text{C}$	$\delta^{37}\text{Cl}$
Building 9674	cVOCs (TCE)	cVOCs (TCE)	-	-	-
<b>Selfridge Air National Guard Base, Michigan</b>					
Building 1533	Petroleum HCs (Benzene)	PHC (Benzene)	Benzene	$\delta^{13}\text{C}$	-
<b>Tyndall Air Force Base, Florida</b>					
Building 156	cVOCs (TCE)	cVOCs (TCE)	TCE	$\delta^{13}\text{C}$	$\delta^{37}\text{Cl}$
Building 219	cVOCs (TCE)	cVOCs (TCE)	TCE	$\delta^{13}\text{C}$	$\delta^{37}\text{Cl}$
<b>Former Raritan Arsenal Site, New Jersey</b>					
Campus Plaza 4	cVOCs (TCE)	cVOCs (TCE)	TCE	$\delta^{13}\text{C}$	$\delta^{37}\text{Cl}$
Building 209	cVOCs (TCE)	cVOCs (TCE)	TCE	$\delta^{13}\text{C}$	$\delta^{37}\text{Cl}$

Notes: 1) Key Analyte = key analyte for vapor intrusion evaluation; 2) At Building 9669, TCE was the key COC for vapor intrusion evaluation. As discussed in Section 5.8.1, on-site analysis was also used to locate a trans-1,2-DCE source.

The overall objective of the demonstration was to evaluate the effectiveness of the on-site analysis protocol relative to two alternative investigation approaches: conventional sampling and the CSIA protocol. In order to compare the effectiveness of each approach, the results for each of the three investigation approaches were initially evaluated independently.

For each test building and each of the three investigation methods, the vapor intrusion classification was based on the framework set out in the Demonstration Plan. These evaluation frameworks and the results from each investigation approach are summarized in Sections 5.7.1 (Conventional), 5.7.2 (CSIA Protocol), and 5.7.3 (On-Site Protocol).

Each of the three investigation methods is intended to determine the source of any target VOC detected in indoor air (i.e., vapor intrusion vs. indoor/ambient source). Note that for regulatory projects, a response action is required only if the concentration of the target VOC in indoor air exceeds the applicable regulatory standard.

For the assessment of regulatory implications, we applied USEPA screening values to all the demonstration sites. These values may not be the legal standards for regulatory responses at the individual sites. They were used for this demonstration in order to provide consistency between the sites. For the demonstration buildings, the key COC for the vapor intrusion evaluation was either TCE or benzene. Therefore, the values in Table 10 were used for comparisons with site data.

**Table 10: Numeric Standards Used for VI Classifications**

Analyte	Risk-Based Screening Level ( $\mu\text{g}/\text{m}^3$ )	
TCE	3.0	USEPA Regional Screening Level Tables, May 2013; commercial/industrial setting; $10^{-6}$ target risk
Benzene	1.6	USEPA Regional Screening Level Tables, May 2013; commercial/industrial setting; $10^{-6}$ target risk

Note: Screening levels used in conventional and on-site analysis protocol building evaluations.

As discussed in Section 5.7.1 and 5.7.3, evaluation of the conventional and on-site analysis protocol results both utilized a multiple lines-of-evidence approach. For each of these two methods, the concordance among the lines of evidence was used to determine the overall vapor intrusion classification as detailed in Table 11. When VOC concentrations are very low, it is more likely that the source identification will not be definitive. However, if VOC concentrations are below the regulatory standard, then no response action is required regardless of the source (although further monitoring may be required in some cases to evaluate temporal variability).

**Table 11: VI Classification using Lines of Evidence Approach: Conventional and On-Site Protocol**

<b>Results of Lines of Evidence Evaluation</b>	<b>Vapor Intrusion Classification</b>
All lines of evidence indicate absence of vapor intrusion.	No evidence of current vapor intrusion.
Mixed results, but weight of evidence indicates absence of vapor intrusion.	Supporting evidence of no current vapor intrusion.
Mixed lines of evidence.	Inconclusive.
Weight of evidence suggests vapor intrusion with some uncertainty.	Supporting evidence of current vapor intrusion.
Lines of evidence predominately indicate vapor intrusion. Strongest lines indicate vapor intrusion.	Clear evidence of current vapor intrusion.

Note: This table applies to the conventional and on-site analysis approaches.

### 5.7.1 Vapor Intrusion Classification using Conventional Lines of Evidence Approach

The results from the conventional sampling program were evaluated using a lines-of-evidence approach which included the following questions:

1. Comparison of key VOC concentrations in indoor air to ambient (outdoor) air: Do indoor concentrations of the key VOC exceed outdoor concentrations? To be conservative, a “Yes” response was considered consistent with vapor intrusion.

In six of seven buildings, indoor air concentrations of the key VOC exceeded ambient (outdoor) air concentrations. This line of evidence, however, is not definitive with respect to vapor intrusion because of potential contributions from indoor sources.

2. Sub-slab to indoor air attenuation factors: Are concentrations of the key VOC below the building significantly (e.g., >10x) higher than in indoor air?

At each building, the sub-slab concentrations varied widely. In six of seven buildings, at least one sub-slab result was more than 10x higher than the indoor air result.

3. Sub-slab to indoor air ratios: Are other VOCs found beneath the slab, and are sub-slab to indoor air concentration ratios similar?

At four of seven demonstration buildings, other VOCs (beyond the key target VOC) were found at relatively high concentrations beneath the slab, and were also detected in indoor air. This general pattern was taken to suggest VI.

4. Composition of VOCs (e.g., concentration ratios) present in indoor air compared to composition of VOCs present in groundwater: Are ratios in indoor air consistent with a subsurface source?

This line of evidence is applicable when multiple VOCs are associated with the groundwater. Multiple VOCs were detected in groundwater near all the demonstration buildings. However, this line of evidence was generally inconclusive.

Other lines of evidence are used in various guidance documents. For example, the vertical distribution of VOCs within a building (e.g., main floor concentrations vs. basements/crawl space) is often evaluated. However, the demonstration buildings were all one story, slab-on-grade, commercial buildings. Therefore, this line of evidence is not considered further in the data evaluation.

Based on the lines of evidence evaluation (Questions 1 – 4), each building was classified with respect to vapor intrusion as shown in Table 11 above.

Building-specific results and interpretation of the conventional lines of evidence approach are presented in Table 12. It is important to note that the regulatory implication is based on the generic screening level used to standardize data interpretations *for this report*. Actual needs or requirements may be different, and will depend on each site’s particular circumstances.

**Table 12: Conventional Program Results**

<b>Building</b>	<b>Finding Based on Conventional Approach</b>	<b>Additional Information (Appendix B)</b>
Lewis-McChord Building 9669	<p><b>FINDING:</b> Supporting evidence of current vapor intrusion</p> <p><b>IMPLICATION:</b> <i>Indoor air concentration (1.5 µg/m<sup>3</sup>) is BELOW USEPA screening level (3 µg/m<sup>3</sup>); however, monitoring may be appropriate to characterize temporal variability.</i></p>	Figure B.1.1
Lewis-McChord Building 9674	<p><b>FINDING:</b> Supporting evidence of current vapor intrusion</p> <p><b>IMPLICATION:</b> <i>No concern due to very low TCE concentration. Indoor air TCE concentration is approximately 2% of the USEPA screening level (3 µg/m<sup>3</sup>).</i></p>	Figure B.2.1
Selfridge Building 1533	<p><b>FINDING:</b> Inconclusive, cannot distinguish between VI and indoor sources.</p> <p><b>IMPLICATION:</b> <i>(1) Indoor benzene concentration greater than USEPA screening level (1.6 µg/m<sup>3</sup>); (2) Further study needed to determine source.</i></p>	Figure B.3.1
Tyndall Building 156	<p><b>FINDING:</b> Supporting evidence of no current vapor intrusion</p> <p><b>IMPLICATION:</b> <i>No vapor intrusion concern. The key target VOC (TCE) not detected, with detection limits approximately 1% of USEPA screening level.</i></p>	Figure B.4.1
Tyndall Building 219	<p><b>FINDING:</b> Inconclusive. Source of TCE in indoor air not clear, however, TCE concentration is very low.</p> <p><b>IMPLICATION:</b> <i>No concern due to low TCE conc. The key target VOC (TCE) found at approximately 3% of the USEPA screening level (3 µg/m<sup>3</sup>).</i></p>	Figure B.5.1

Building	Finding Based on Conventional Approach	Additional Information (Appendix B)
Raritan Building CP4	<p><b>FINDING:</b> Supporting evidence of current vapor intrusion</p> <p><b>IMPLICATION:</b> Indoor air TCE concentration is within 50% of USEPA screening level (<math>3 \mu\text{g}/\text{m}^3</math>). Monitoring may be needed to characterize temporal variability.</p>	Figure B.6.1
Raritan Building 209	<p><b>FINDING:</b> Supporting evidence of current vapor intrusion</p> <p><b>IMPLICATION:</b> No vapor intrusion concern. Indoor air TCE concentration approximately 2% of the USEPA screening level (<math>3 \mu\text{g}/\text{m}^3</math>).</p>	Figure B.7.1

Note: Findings and implications above are based on the conventional program only. See Section 6.3 for an evaluation of the full dataset (e.g., results from conventional, CSIA, and on-site analysis approaches).

### 5.7.2 VI Classification using the CSIA Protocol

For each building, the compound-specific isotope ratios measured in indoor air samples were compared to i) subsurface (groundwater) samples; and ii) the range of isotopic signatures for indoor sources. These comparisons were done to evaluate the presence or absence of vapor intrusion (Figure 4), and the level of confidence in the interpretation. Although isotope ratios were also measured in sub-slab soil gas samples, these results were found not to be useful for source determination (see ER-201025 Final Report).

The CSIA results fall into six categories, as illustrated in Figure 4:

**Figure 4: Interpretation of CSIA Results**

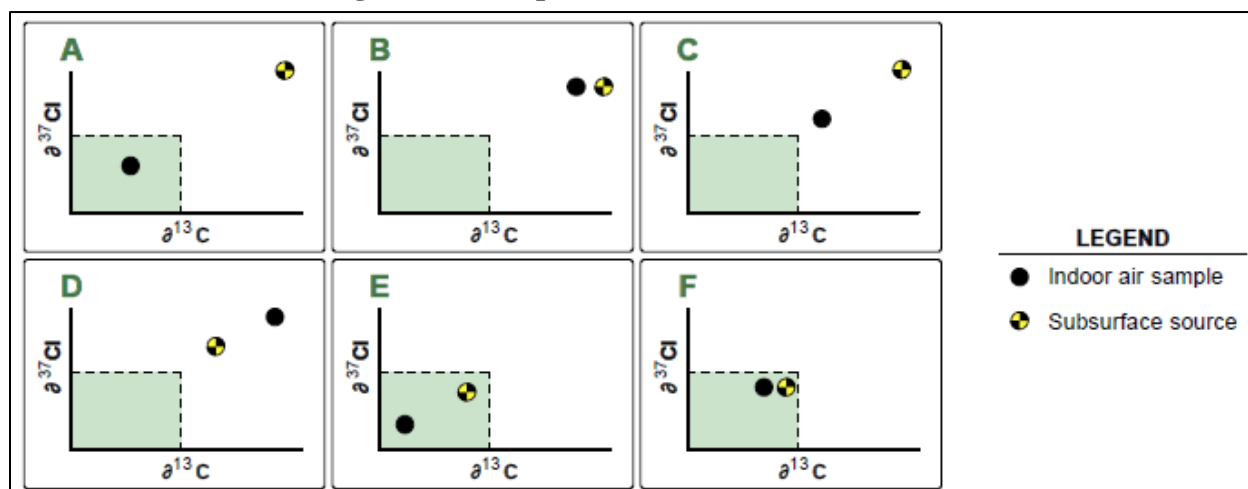

Data interpretation is based on pattern matching, as follows:

- (A) Strong evidence that an indoor source is the primary source of VOCs in indoor air.
- (B) Strong evidence that the subsurface source is the primary source of VOCs in indoor air.
- (C) Evidence of mixed subsurface and indoor air sources.
- (D) Evidence that the subsurface source is the primary source of VOCs in indoor air, additional enrichment in the heavy isotopes is likely occurring between the subsurface measurement point and the target building.
- (E) Supporting evidence that an indoor source is the primary source of VOCs in indoor air.
- (F) Supporting evidence that the subsurface source is the primary source of VOCs in indoor air. However, results are also potentially consistent with an indoor source, so the results should be interpreted within the context of other lines of evidence.

The CSIA protocol results and interpretation for each building are presented in Appendix B. Individual demonstration building results are summarized in Table 13.

**Table 13: CSIA Protocol Results**

<b>Building</b>	<b>Finding Based on CSIA Protocol</b>	<b>Additional Information (Appendix B)</b>
Lewis-McChord Building 9669	Supporting evidence of current vapor intrusion	Figure B.1.2
Lewis-McChord Building 9674	Not tested because of low TCE concentration in indoor air	Figure B.2.2
Selfridge Building 1533	Supporting evidence of NO current vapor intrusion	Figure B.3.2
Tyndall Building 156	Not tested because of low TCE concentration in indoor air	Figure B.4.2
Tyndall Building 219	Not tested because of low TCE concentration in indoor air	Figure B.5.2
Raritan Building CP4	Strong evidence of an indoor source, not vapor intrusion	Figure B.6.2
Raritan Building 209	Not tested because of low TCE concentration in indoor air	Figure B.7.2

Note: Findings above are based on the CSIA protocol only. See Section 6.3 for an evaluation of the full dataset (e.g., results from conventional, CSIA, and on-site analysis approaches).

### 5.7.3 VI Classification using the On-Site Analysis Protocol

In general terms, the on-site analysis protocol involves characterizing the VOC concentrations in a building under normal operating conditions (i.e., “baseline” conditions). Building pressure is measured and may be manipulated to get a better understanding of the source of VOCs in indoor air.

### 5.7.3.1 Baseline Building Characterization

During the baseline building characterization process, a large number of indoor air samples can be collected to map the concentration gradient in the building both laterally and vertically (if the building has more than one floor). Areas with relatively high VOC concentrations in indoor air are examined in more detail, as these areas will likely contain indoor VOC source(s) or subsurface vapor entry points. The overall goal is to determine the source of the target VOC in indoor air. If a significant indoor VOC source is found, it is removed from the building, if possible, before completion of the baseline characterization. In this manner, the overall level of VOCs in the building is reduced to the extent possible, minimizing confusion in analytical results that is often caused by the presence of indoor sources.

Different actions may be taken to understand the VOC source. For example, if a suspected indoor VOC source is found and removed from the building, and the VOC concentration in indoor air then decreases significantly, one would interpret that the suspected source was the primary contributor of VOCs to indoor air. A wide variety of actions can be taken depending upon site-specific circumstances. However, the underlying theme is that the protocol relies on iterative testing and data interpretation to find the source of VOCs and determine the susceptibility of the building to vapor intrusion. All data collected up to this point are field measurements and analysis.

At the end of the baseline characterization (and after concentrations have stabilized after indoor source removal), the investigators make a preliminary interpretation of the source of VOCs using the following guidelines:

1. Comparison of target VOC concentrations in indoor air to ambient (outdoor) air: Do indoor concentrations of the key VOC exceed outdoor concentrations? A “Yes” response is conservatively considered to be consistent with vapor intrusion. This line of evidence is not definitive with respect to vapor intrusion, however, because of potential contributions from indoor sources.
2. No indoor sources: Were known indoor sources of target VOCs removed prior to the end of the baseline period such that no (known) indoor sources remain in the building? If “Yes”, then the source of target VOCs may be consistent with vapor intrusion. If “No”, known indoor sources remain, and these indoor sources may be the primary source(s) of VOCs in indoor air. This question does not apply if the on-site results for the target VOC are below detection limits.
3. Baseline building pressure: Is baseline building pressure negative (i.e., building depressurized relative to outdoors [ambient])? A “No” provides evidence of an indoor source because a positive building pressure does not support the flow of soil gas into the building. A “Yes” response is conservatively considered to be consistent with vapor intrusion. However, this line of evidence alone is not definitive with respect to vapor intrusion because a negative building pressure does not eliminate the possibility of an indoor source.
4. Vapor entry point: Were vapor entry points found? If “Yes”, then vapor intrusion could contribute to target VOCs in indoor air.

The range of building classifications based on these lines of evidence is summarized in Table 11 above.



### **5.7.3.2 Pressure Control Evaluation**

The protocol includes an optional step in which building pressure is manipulated (see Figure 2). Changes in building pressure relative to the subsurface can cause temporal variations in vapor intrusion. As a result, a one-day investigation program with uncontrolled building conditions may not identify vapor intrusion that could occur under other building pressure conditions. To better understand building conditions, the differential pressure between indoors and outdoors is measured during the baseline evaluation. Building pressure control may then be used as a tool to control the advective flow of soil gas into the building. If advection (rather than diffusion) is the primary mode of vapor intrusion for a building, then building pressure control can provide an improved understanding of the potential for vapor intrusion (McHugh et al., 2012; USEPA, 2011b). Building pressure control can also be used to support the findings from the baseline evaluation.

Lines of evidence for the optional pressure control evaluation focus on change in target VOC concentrations relative to baseline, and relative to the building pressure condition.

1. Building pressurization: Are target VOC concentrations suppressed by building pressurization? A “Yes” response is consistent with VI.
2. Building depressurization: Are target VOC concentrations enhanced by depressurization? A “Yes” response is consistent with VI.

The range of building classifications based on these lines of evidence is summarized in Table 11 above.

### **5.7.3.3 Data Interpretation using both On- and Off-site Results**

The building evaluations in Sections 5.7.3.1 and 5.7.3.2 above may be done with the results from on-site analysis. Similarly, the overall finding regarding the susceptibility of the building to vapor intrusion considers the on-site results from both the baseline characterization and pressure control evaluations.

The on-site analysis protocol includes collection of a grab indoor air sample for off-site laboratory analysis at the end of each pressure period (i.e., baseline, pressurization, and depressurization). Because these samples are supported by laboratory QA/QC consistent with analytical method (TO-15) requirements, they are suitable to be used for “definitive” decision-making and comparisons screening levels. These lab-based results are used to evaluate the regulatory implication of the findings at each building. These samples also serve to confirm the on-site results.

For each demonstration building, the VI classification (Table 14) was determined using the lines of evidence described in Sections 5.7.3.1 and 5.7.3.2. It is important to note that the regulatory implication is based on the generic screening level used to standardize data interpretations *for this report*. Actual needs or requirements may be different, and will depend on each site’s particular circumstances.

**Table 14: On-Site Analysis Protocol Results**

<b>Building</b>	<b>Results Based on On-Site Analysis Protocol</b>	<b>Additional Information (Appendix B)</b>
Lewis-McChord Building 9669	<p><u>OVERALL FINDING:</u> Evidence of current vapor intrusion</p> <p><i>IMPLICATION:</i> Indoor air concentration (<math>2 \mu\text{g}/\text{m}^3</math>) is below USEPA screening level (<math>3 \mu\text{g}/\text{m}^3</math>). Pressure control evaluation increases confidence in result, and decreases concern with temporal variability.</p>	Figure B.1.3
Lewis-McChord Building 9674	<p><u>OVERALL FINDING:</u> No evidence of current/potential vapor intrusion</p> <p><i>IMPLICATION:</i> No concern due to very low TCE concentration. TCE concentrations (confirmation samples) at or below detection limit (i.e., 1% of USEPA screening level)</p>	Figure B.2.3
Selfridge Building 1533	<p><u>OVERALL FINDING:</u> No evidence of current/potential vapor intrusion</p> <p><i>IMPLICATION:</i> Primary sources of benzene are indoors. Indoor air benzene concentration greater than USEPA screening level due to indoor sources. No additional evaluation warranted under current building use.</p>	Figure B.3.3
Tyndall Building 156	<p><u>OVERALL FINDING:</u> No evidence of current/potential vapor intrusion</p> <p><i>IMPLICATION:</i> No vapor intrusion concern. Baseline and depressurized confirmation sample TCE result below detection limit (1% of USEPA screening level).</p>	Figure B.4.3
Tyndall Building 219	<p><u>OVERALL FINDING:</u> Inconclusive. Source of TCE in indoor air not clear, however, TCE concentration is very low.</p> <p><i>IMPLICATION:</i> No concern due to low TCE concentration. The key target VOC (TCE) less than 10% of the USEPA screening level (<math>3 \mu\text{g}/\text{m}^3</math>). TCE concentration was very low despite negative</p>	Figure B.5.3

Building	Results Based on On-Site Analysis Protocol	Additional Information (Appendix B)
	<i>baseline building pressure (favorable for vapor intrusion), reducing concern regarding temporal variability.</i>	
Raritan Building CP4	<p><b>OVERALL FINDING:</b> Office Area: Supporting evidence of vapor intrusion. Warehouse: Suggestive of vapor intrusion.</p> <p><i><b>IMPLICATION:</b> Indoor air concentration (0.43 µg/m<sup>3</sup> in warehouse) is below USEPA screening level (3 µg/m<sup>3</sup>). Controlled depressurization did not enhance vapor intrusion reducing concern regarding temporal variability.</i></p>	Figure B.6.3
Raritan Building 209	<p><b>OVERALL FINDING:</b> No evidence of current vapor intrusion. Normal building pressure condition suggests vapor intrusion not likely.</p> <p><i><b>IMPLICATION:</b> No vapor intrusion concern. TCE concentration well below USEPA screening level (3 µg/m<sup>3</sup>). TCE concentration was very low despite strong negative baseline building pressure (created by operation of lab fume hoods), reducing concern regarding temporal variability.</i></p>	Figure B.7.3

Note: Findings and implications above are based on the on-site analysis protocol only. See Section 6.3 for an evaluation of the full dataset (e.g., results from conventional, CSIA, and on-site analysis approaches).

## 5.8 SUPPLEMENTAL DATA

The field conditions encountered at the demonstration sites did not test some aspects of the on-site analysis protocol such as identification and removal of indoor sources. In order to further illustrate the utility of the on-site analysis protocol for distinguishing between vapor intrusion and indoor sources of VOCs, we have included results from several supplemental studies. In each case, the investigation was conducted by a member of the demonstration team. However, because these studies were not covered by the demonstration program, the conventional sampling and isotope sampling were not conducted.

### 5.8.1 Identification of Indoor Sources

Results from two supplemental studies illustrate the ability of the on-site analysis protocol to identify indoor sources of VOCs.

- Lewis-McChord Building 9669: Although no indoor sources of the primary target COC (TCE) were identified in this demonstration building, application of the on-site analysis

protocol resulted in the identification of an indoor source of trans-1,2-DCE. This chemical is an analyte included in the HAPSITE chlorinated VOC method but is not strongly associated with the subsurface source at Lewis-McChord. The distribution of trans-1,2-DCE in indoor air was distinct from the distribution of TCE in indoor air (see Figure 5). Following the trans-1,2-DCE concentration gradient, the field team located a box of lubricant sprays on a warehouse shelf. The product labels confirmed that trans-1,2-DCE was an ingredient.

**Figure 5: Indoor trans-1,2-DCE Source Identification**

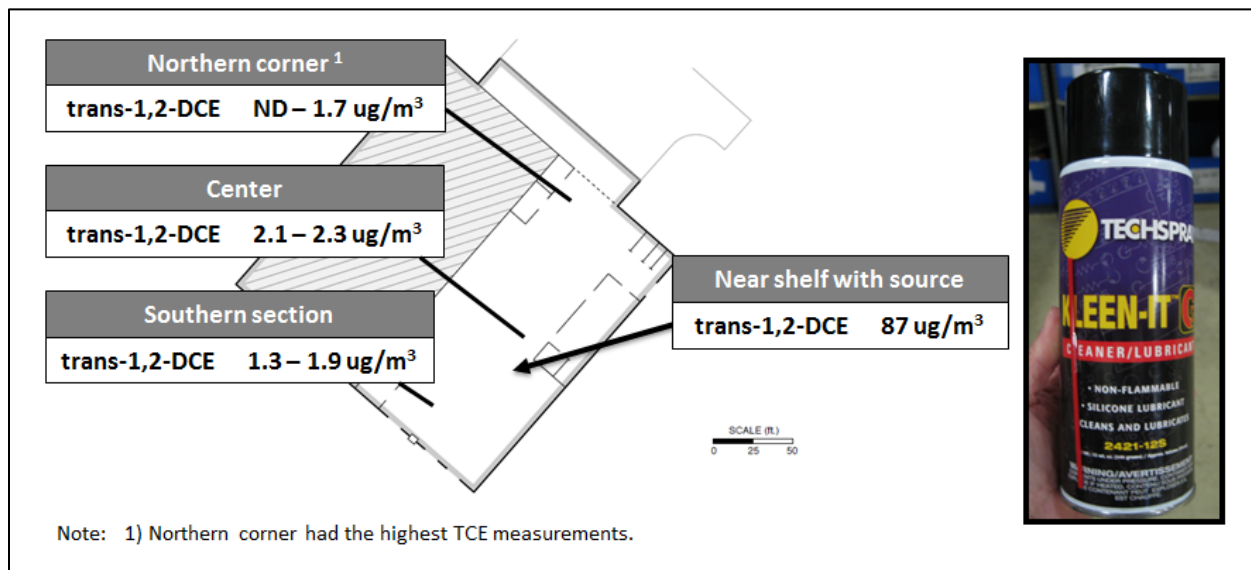

- Hill AFB Building 514, Utah:** In this building, the on-site analysis protocol resulted in the identification of a hazardous waste storage drum in a laboratory as a source of PCE in indoor air (Figure 6, Panels 1 and 3). This drum was not identified as a potential source by the building manager or by review of waste characterization results. Although PCE was not detected, the detection limits were elevated because of other chemicals present in the waste (i.e., PCE < 500 ppm). Using the HAPSITE survey, the drum was identified as a strong vapor source (Figure 6, Panel 2). PCE concentrations in Building 514 before and after removal of the waste drum are shown in Figure 6 (Panel 4).

**Figure 6: Indoor PCE Source Identification using On-Site Protocol**

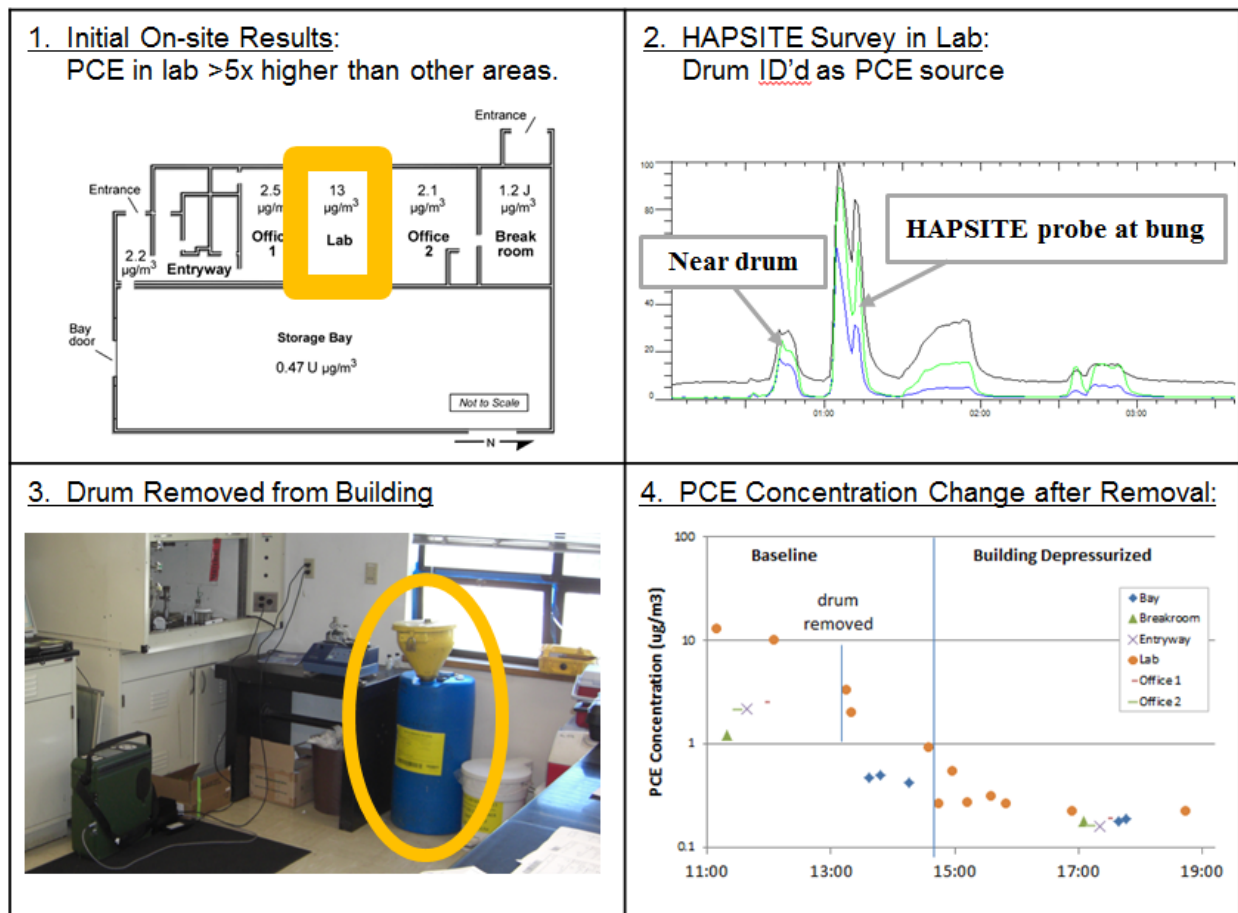

### 5.8.2 Use of Building Pressure Manipulation

The use of building pressure control to better understand the presence or absence of vapor intrusion is illustrated by the results from two supplemental sites.

- Hill AFB, Building 514, Utah:** Figure 6 (Panel 4) illustrates the results of building pressure manipulation after removal of the indoor PCE source identified using the HAPSITE survey. After the drum was removed, indoor air concentrations in the lab decreased by more than an order of magnitude, to levels less than  $1 \mu\text{g}/\text{m}^3$ . When the building was depressurized, TCE concentrations continued to decrease, to levels near the instrument detection limit. The lack of PCE enhancement during the depressurization period indicates that there was no measurable influx of PCE from the subsurface (i.e., no vapor intrusion). The indoor source, therefore, was confirmed as the primary source of PCE to indoor air.
- Hill AFB Building 755, Utah:** Building 755 at Hill AFB houses tanks and equipment associated with non-aqueous phase liquid (NAPL) recovery at Hill AFB Operable Unit 2. The equipment is a potential indoor source of TCE that could not be removed from the

building during the sampling program. HAPSITE surveys confirmed that pipe flanges and valves contributed to TCE in indoor air (Figure 7). The effect of building pressure control on indoor TCE concentrations is shown on Figure 8. The on-site analysis protocol and pressure control evaluation indicated that, although significant indoor TCE sources were present, the building was impacted by vapor intrusion.

**Figure 7: Non-removable Indoor TCE Source with Associated HAPSITE Survey Response**

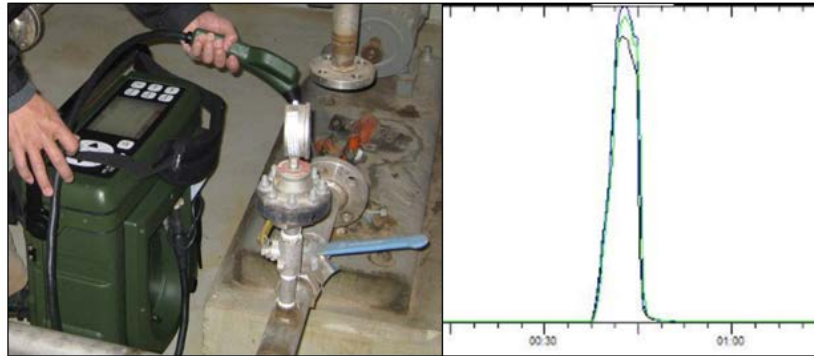

Note: TCE identifying masses - 95 (black), 130 (blue), 132 (green).

**Figure 8: Pressure Manipulation Results Confirming Vapor Intrusion**

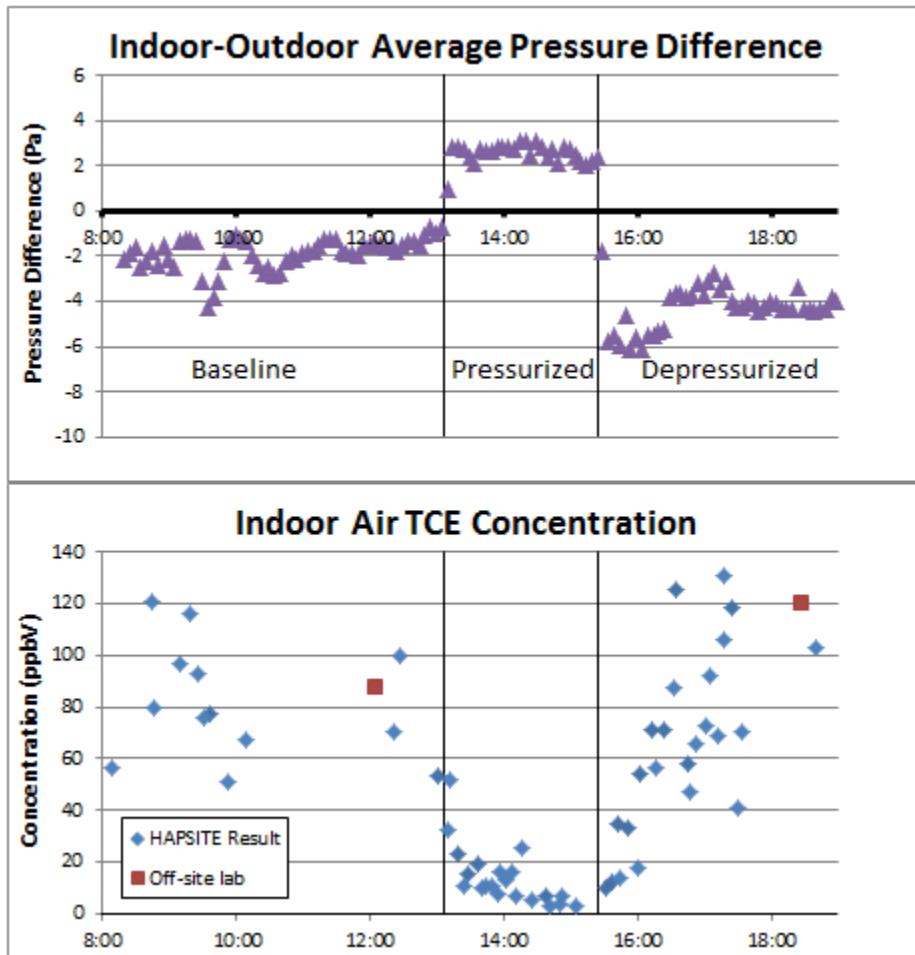

### 5.8.3 Identification of Vapor Intrusion Entry Points

Results from two supplemental sites illustrate the ability of the on-site analysis protocol to identify vapor intrusion entry points.

- Industrial Building, California: The highest concentrations of TCE in indoor air were measured in the middle of the building (TCE  $3.5 \mu\text{g}/\text{m}^3$  and  $4.7 \mu\text{g}/\text{m}^3$ ). Two samples collected from utility trenches below the building floor contained highest overall concentrations of TCE (TCE in floor vent  $27.4 \mu\text{g}/\text{m}^3$ ; TCE in sewer manhole  $26.3 \mu\text{g}/\text{m}^3$ ). The HAPSITE survey mode confirmed TCE at these two utility trench access points, indicating that the utility trench was the vapor intrusion entry point (Figure 9).

**Figure 9: Identification of Utility Trench as a Vapor Source**

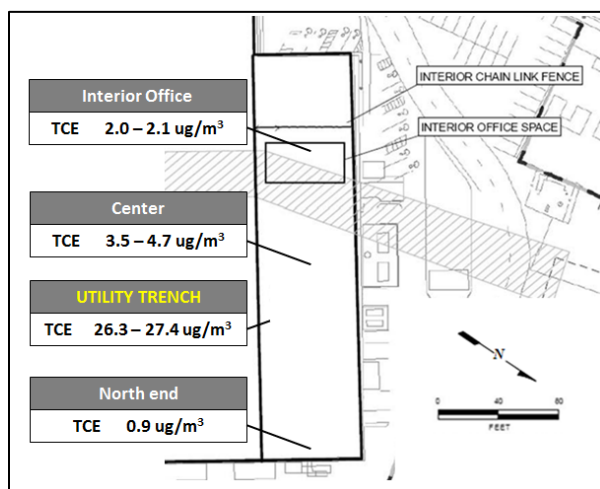

Note: Yellow text highlights vapor entry point.

- Former Dry Cleaner, California: During the initial building characterization, PCE in indoor air was found at levels ranging from below detection up to  $22 \mu\text{g}/\text{m}^3$ . Floor flux and expansion joint samples were collected by covering sections of the floor with plastic sheeting, inserting the HAPSITE probe, and analyzing the air under the sheeting. Two rooms had relatively high PCE concentrations in indoor air. Samples from expansion joints in these rooms had elevated results, including one expansion joint sample containing PCE at  $20,000 \mu\text{g}/\text{m}^3$ . Building pressure was not manipulated during this study. However, differential pressure measurements indicated that the building was depressurized during the investigation. These results suggest that vapor intrusion was the primary source of VOCs in indoor air, with the majority of vapor entry occurring in two rooms in the building.

Vapor entry points were also identified in one demonstration building and one supplemental building:

- Raritan CP4 Warehouse: Indoor air had relatively uniform TCE concentrations throughout the warehouse. Two expansion joints were sampled in this area. One had

concentrations of about 20x the indoor concentrations, while the other had concentrations <3x indoor concentrations (Figure 10). Although one location was clearly elevated relative to the other, neither appeared to be a significant entry point because indoor air TCE concentrations were uniform within the vicinity of the cracks and were lower than TCE concentrations found in other parts of the building.

**Figure 10: Example of a Vapor Entry Point**



Note: Yellow text highlights the location with highest slab concentration found in the building.

- Hill AFB Building 755, Utah: In this building, pressure control demonstrated that vapor intrusion was the primary source of TCE in indoor air. To identify entry points, sections of the floor were isolated and sampled. A crack in the center of the slab was sampled along with an adjacent, uncracked section of the slab. The TCE concentrations at the cracked section of the floor were up to 15x higher than indoor air. At the uncracked section of the slab, the TCE concentration was similar to that in indoor air, suggesting that vapor migration was associated with cracks in the slab rather than diffusing through the bulk concrete foundation.



## 6.0 PERFORMANCE ASSESSMENT

This section summarizes the data analysis completed to assess the performance objectives described in Section 3 and determine if the success criteria were met.

### 6.1 OBJECTIVE 1: COLLECTION OF DATA REPRESENTATIVE OF SITE CONDITIONS USING ON-SITE GC/MS

Due to the poor reliability of the HAPSITE ER, a back-up instrument (usually a SMART PLUS) was brought to each demonstration. If the primary instrument failed during the demonstration, the back-up instrument was calibrated and used to complete the field program. The HAPSITE instruments used for each demonstration are summarized in Table 15.

**Table 15: HAPSITE Instruments used for each Demonstration**

Demonstration Site	HAPSITE Instruments Used
Lewis-McChord	HAPSITE ER
Selfridge	HAPSITE ER <sup>1</sup>
Tyndall	HAPSITE SMART <sup>2</sup>
Raritan	HAPSITE SMART PLUS

Notes: 1) HAPSITE ER failed initial calibration but stabilized after first day. Met performance requirements after re-calibration. 2) HAPSITE ER failed during initial calibration and was shipped to manufacturer for repairs. A HAPSITE SMART was used for the demonstration.

#### 6.1.1 Data Quality Review

Analytical results from on-site GC/MS analysis were evaluated against the data quality objectives specified in the QAPPs (GSI, 2012c). Key areas considered in the data usability assessment included i) HAPSITE calibration; ii) sampling procedures; iii) precision; iv) accuracy; v) completeness; and vi) instrument sensitivity.

##### 6.1.1.1 HAPSITE Calibration

The field team arrived at each demonstration site city the day before fieldwork was scheduled to commence. Tasks during this “start-up” day included calibrating the HAPSITE instrument. The team confirmed that the calibration curve met the requirements of the QAPP prior to collecting building investigation samples. Calibration curve statistics are detailed in Table D.1.1 of Appendix D and summarized in Table 16 for the TCE and benzene, analytes typically of concern at VI investigation sites.

**Table 16: Calibration Curve Summary Statistics**

	<b>Correlation Coefficient (R<sup>2</sup> goal ≥ 98%)</b>	<b>Relative Standard Deviation (RSD goal of &lt;20%)</b>	<b>Relative Standard Deviation of Response Factor (RSD of RF goal of &lt;30%)</b>
TCE <sup>1</sup>	100%	2.98 - 6.62%	9.61 – 23.95%
Benzene <sup>2</sup>	100%	0.62 – 1.12%	4.34 – 4.45%

Note: 1) Summary statistics cover one calibration each of the ER, SMART, and SMART PLUS. 2) Summary statistics cover 2 calibrations of the HAPSITE ER.

At two of the four demonstration sites (i.e., Lewis-McChord and Raritan), the instrument calibration was completed successfully prior to any on-site work. Exceptions occurred at the Selfridge and Tyndall sites:

- At the beginning of the Selfridge demonstration, the HAPSITE ER instrument appeared to be unstable, giving very different results for the same sample. For example, one 10 ppbV standard was analyzed two times. In the first run, the benzene result was 26 ppbV. The result from the second analysis of the same standard was 15 ppbV. Additionally, the QA requirements for calibration were not met. Test samples were collected and analyzed in the building on 18 September 2012, during which the HAPSITE ER results appeared to stabilize. The instrument was recalibrated on the morning of 19 September 2012, prior to returning to the building, and all performance metrics were met. Samples for the formal on-site analysis protocol demonstration were collected using the calibration that met the project QA requirements.
- At the beginning of the Tyndall demonstration, the HAPSITE ER failed. GSI had a HAPSITE SMART instrument available as a backup. Because of time constraints, GSI analyzed samples collected for indoor air screening purposes prior to calibrating the instrument. This was deemed acceptable because the SMART's response appeared to be linear when analyzing a small set of standards with known concentrations. The SMART was calibrated at the end of the day after it was determined that the ER could not be repaired and used for the demonstration. Samples for the formal on-site analysis protocol demonstration were collected using the calibration that met the project QA requirements.

**Finding:** A calibrated HAPSITE was used for each formal demonstration of the protocol. Calibration metrics met the requirements of the QAPP.

### 6.1.1.2 Sampling Procedures

Samples collected for the formal demonstration were collected in accordance with Standard Operating Procedures (SOPs) routinely utilized by GSI or methods validated during previous field programs, as detailed in the project QAPPs. During the field programs covered by this report, the following deviations from planned tasks occurred:

- Although not specified in the Demonstration Plan, GSI screened buildings at three of the four demonstration sites to identify key buildings in which to complete the demonstration. At Lewis-McChord, we screened eight buildings and then conducted the demonstration at two. At Tyndall, we screened six buildings and then conducted the demonstration at two. At Raritan, we obtained access to two large buildings that were each divided into separate suites. We screened a total of six spaces within each building, and used the screening results to focus on specific areas within each building.
- At Tyndall Building 219, we did not have access to the entire building because of security restrictions. However, we were able to sample multiple locations across the building footprint.
- At Tyndall Building 156, baseline confirmation samples (i.e., samples collected for off-site laboratory analysis) were not collected until the next day.
- The pressure control option of the protocol was used at five of the seven demonstration buildings. In the demonstration plan, the anticipated minimum duration of each pressure cycle was two hours. Because of time limits set by building occupants (i.e., to accommodate normal working hours, to avoid disruption of work, etc.), the duration of each pressure cycle at Lewis-McChord Building 9669 was approximately one hour. For each building, however, the time needed for the concentrations to stabilize was less than anticipated. The test was not negatively impacted by the reduced duration of the pressure cycles at Lewis-McChord.

**Finding:** *Established sampling procedures were used in the demonstration, which was completed in a total of seven test buildings. Minor deviations occurred based on site-specific needs, but these changes did not negatively impact the data collected.*

### 6.1.1.3 Precision Assessment

The precision assessment evaluates the agreement in analytical results between normal and duplicate samples (i.e., field duplicates). Precision was evaluated by calculating the relative percent difference (RPD) between the paired samples, provided that the compound was detected in both. The precision objective was less than 30% RPD between the paired results for at least 75% of on-site analyses. Precision was calculated as follows:

$$\text{RPD} = \frac{\text{Measured conc. in normal sample} - \text{Measured conc. in duplicate}}{0.5 \times (\text{Measured conc. in normal sample} + \text{Measured conc. in duplicate})} \times 100$$

A total of 14 sample pairs were analyzed using the SIM method for cVOCs (see Table D.1.2). For the key target VOC (TCE), all but one of the RPD values met the 30% target. Four sample pairs were analyzed using the SIM method for petroleum hydrocarbons (see Table D.1.3). Three of the four sample pairs met the RPD goal.

**Finding:** *The precision goal was met for the key target VOCs.*

#### **6.1.1.4 Accuracy Assessment**

The accuracy assessment evaluates the agreement between an observed value and an accepted reference value. Field accuracy was maintained through implementation of instrument calibration, startup, and tuning protocols. Instrument calibration prior to on-site fieldwork is discussed in Section 6.1.1.1 above.

During the course of each field investigation, the instrument was automatically tuned at least once per day. Accuracy was checked by analyzing method blank and CCV samples before and after on-site building investigations and also at mid-day. Additional QA samples were analyzed as needed to confirm that the instrument was operating properly (e.g., blanks analyzed to “clean out” the instrument after high-concentration samples, to minimize carryover). Accuracy was also evaluated through the analysis of “split” samples (i.e., samples collected in Summa canisters which were paired with the HAPSITE samples).

#### Blank Samples

The results from blank samples are provided in Table D.1.4 for the key VOCs (e.g., benzene and TCE). For the cVOC method, analytes generally met the objective of concentrations less than the lower calibration limit (LCL). For the majority of the blanks, high purity nitrogen was placed into a Tedlar bag and the bag attached to the HAPSITE probe for analysis. In several instances, TCE was reported at levels greater than the LCL. In these instances, a sample of room air or outdoor air was analyzed directly with the HAPSITE probe (i.e., without using a Tedlar bag) immediately after the suspect blank sample. In all cases, the “ambient blank” met the data quality objective. This suggested that the analyte was associated with the Tedlar bag, and that the instrument was operating adequately.

#### CCV Samples

The results of the CCV samples are provided in Tables D.1.5 (cVOC method) and D.1.6 (BTEX/MTBE method). The results in these tables are given in units of ppbV. The tables include the RPD (%) calculated as the absolute value of the difference between the standard concentration and the sample result, divided by the average, and multiplied by 100.

Results for TCE are shown in Table D.1.5. For TCE measured with the HAPSITE ER and SMART PLUS, the average RPD was 24%. For TCE measured with the HAPSITE SMART, the average RPD was 44%. Results for benzene are shown in Table D.1.6. The average RPD was 44%.

#### Split Samples

We also evaluated accuracy by comparing the on-site and off-site results (see Table D.1.7). The dataset contained a total of 14 paired HAPSITE – laboratory samples. The samples for laboratory analysis were collected over approximately 2-3 minutes, with the Summa canister positioned near the HAPSITE probe. The intent was to collect the paired samples at the same time and location to the extent possible so that the Summa canister samples could serve as confirmation of the HAPSITE results.

The RPD was calculated when both the HAPSITE and laboratory detected the compound; a total of 10 RPD values were calculated. Eight of the 10 values were less than 75%, which was the quality objective for the project.

The largest errors (RPD > 100%) occurred in two sample pairs:

- Selfridge Building 1533 negative pressure confirmation sample. The HAPSITE ER sample was collected approximately 20 minutes before the Summa canister sample. This sample pair was collected in an auto maintenance building. Less than a minute after starting the HAPSITE sample, a worker started a vehicle inside the closed building. Because of the exhaust fumes, we did not immediately collect the Summa canister sample. After the exhaust odors diminished, we set up the HAPSITE ER to collect a final building sample. The ER failed (i.e., rebooted itself). There was not enough time to finish the reboot cycle before the building closed for the day. Therefore, we collected the Summa canister sample without a HAPSITE sample.
- Raritan Building CP4 wall gap sample. The HAPSITE SMART PLUS result for TCE was much larger than the Summa canister result (11  $\mu\text{g}/\text{m}^3$  vs. 2.4  $\mu\text{g}/\text{m}^3$ ). This difference was likely due to the small space being sampled and the relative volumes. The HAPSITE sample was approximately 100 mL while the Summa canister was 6-L. After collecting the Summa canister sample, we re-sampled the same wall gap with the HAPSITE. The TCE concentration reported by the HAPSITE was 4  $\mu\text{g}/\text{m}^3$  (approximately 1/3 of the original reported concentration), suggesting that there was a limited pocket of air with higher concentrations.

***Finding:** Overall, the accuracy goal was met. Experienced and attentive HAPSITE operators are recommended to identify equipment issues and take corrective action timely. The use of Tedlar bags may introduce error.*

#### **6.1.1.5 Completeness Assessment**

Completeness is the ratio of the number of valid sample results to the total number of samples planned. The completeness objective for field samples was at least 90%.

We collected samples needed to complete the on-site analysis protocol in each building. The largest barriers to sample collection related to instrument issues, where, for example, the HAPSITE would give an error and the sample would not be analyzed. Typically, these issues were resolved in the field such that the overall goals of the building investigation were met. An instance in which a desired sample was not collected was the Selfridge site negative pressure confirmation sample described in Section 6.1.1.4 above.

***Finding:** Overall, the completeness goal was met. Experienced and attentive HAPSITE operators are recommended to identify equipment issues and take corrective action timely. Instrument reliability should be factored into the time requested for access as well as planning for backup instruments.*

### 6.1.1.6 Sensitivity Assessment

The sensitivity objective for this project was  $<1 \mu\text{g}/\text{m}^3$  for cVOCs and  $<5 \mu\text{g}/\text{m}^3$  for petroleum hydrocarbons. For cVOCs, this objective was evaluated by comparing HAPSITE and laboratory results (Table D.1.7). The HAPSITE gave a result that was generally consistent with the laboratory (i.e., TCE detected by both the HAPSITE and the lab or not detected by either the HAPSITE or the lab). For these samples, laboratory detection limits were in the range of  $0.03 \mu\text{g}/\text{m}^3$  for TCE. Benzene detections on the HAPSITE were generally consistent with benzene reported by the lab. Benzene concentrations were relatively high in the building, so a detailed evaluation of sensitivity could not be done. In separate investigations not included in the demonstration, GSI has obtained results for benzene with instrument sensitivities on the order of  $1 \mu\text{g}/\text{m}^3$ .

**Finding:** Overall sensitivity objectives ( $<1 \mu\text{g}/\text{m}^3$ ) were met for TCE. Detailed evaluations of sensitivity for petroleum hydrocarbons could not be done because of relatively high concentrations in the demonstration building. In previous studies, benzene has been measured to levels on the order of  $1 \mu\text{g}/\text{m}^3$ .

### 6.1.2 Evaluation of Performance Objective 1

The data quality exceptions noted above do not limit the usability of the results obtained because corrective action was taken in the field when problems were noted. Overall, the on-site analytical results met the success criteria set out in the project performance objectives (see Table 17). The additional evaluations discussed above support that the data are usable for protocol evaluation.

**Table 17: Summary of On-Site Data Quality Evaluation**

Success Criteria	Results
Precision: RPD $< 30\%$ for duplicate samples (for $>75\%$ of on-site analyses)	Goal met
Accuracy: RPD $< 75\%$ for standard concentration vs. HAPSITE result (for $> 75\%$ of on-site analyses)	Goal met
Accuracy: RPD $< 75\%$ for paired samples analyzed on-site and off-site (for $>75\%$ of on-site analyses)	Goal met
Sensitivity: $<1 \mu\text{g}/\text{m}^3$ for cVOCs and $<5 \mu\text{g}/\text{m}^3$ for petroleum hydrocarbons (for $75\%$ of the on-site analyses)	Goal met for cVOCs (e.g., TCE) and petroleum hydrocarbons (e.g., benzene)

## 6.2 OBJECTIVE 2: COLLECTION OF DATA REPRESENTATIVE OF SITE CONDITIONS USING OFF-SITE ANALYSIS

### 6.2.1 Data Quality Review

Analytical results from off-site laboratory analysis were evaluated against the data quality objectives specified in the QAPPs (GSI, 2012c). Key areas considered in the data usability

assessment included i) sampling procedures; ii) custody procedures; iii) precision assessment; iv) accuracy assessment; and v) completeness.

#### **6.2.1.1 Sampling Procedures**

Groundwater and vapor samples submitted for laboratory analysis were collected in accordance with SOPs routinely utilized by GSI or methods validated during previous field programs, as detailed in the project QAPPs.

During the field programs covered by this report, the following deviations from planned procedures occurred:

- At Tyndall, a field duplicate was not collected for radon analysis.
- At the Raritan buildings, permanent sub-slab vapor probes had been installed during previous investigations, and have been monitored on a routine basis for the last several years. Rather than installing new, temporary points, GSI collected sub-slab samples from the existing points. We planned to collect samples from three probe points in each building. We were only able to collect two in each building because i) at the CP4 building, one of the points was obstructed and we were only able to collect sufficient soil gas volume for on-site screening; and ii) at Building 209, we were unable to seal one of the probes enough to pass the helium leak test.
- Groundwater sample collection procedures at the following sites were modified based on site-specific needs. At the Lewis-McChord site, groundwater samples were collected by personnel from Versar, the site contractor. At the Selfridge site, GSI collected the groundwater samples using low-flow/no-purge methods because of limited options to manage investigation-derived waste (IDW). At the Raritan site, groundwater samples were collected with bailers because of pump malfunctions.
- Groundwater samples were collected for the CSIA protocol to characterize the isotope signature of the subsurface source. At the Selfridge site, the monitoring well had not been sampled for several years. Therefore, the groundwater sample was split, with one portion submitted for VOC analysis and the other submitted for the isotope analysis.

#### **6.2.1.2 Custody and Sample Handling Procedures**

All samples for off-site analysis were shipped under chain of custody control. The types of samples included:

- Vapor samples collected in Summa canisters for TO-15 analysis. These samples did not have special preservation or shipping requirements. All the samples for TO-15 analysis were submitted to ALS/Columbia Analytical Services in Simi Valley, California. All samples were received by the laboratory in good condition, and were analyzed within holding time requirements.

- Vapor samples collected in Tedlar bags for radon analysis. These samples did not have special preservation requirements. These samples were all shipped for overnight delivery to the University of Southern California Earth Sciences contract laboratory. All samples were received by the laboratory in good condition, and were analyzed within holding time requirements (i.e., all samples analyzed within 4 days of collection).
- Groundwater samples collected in VOA vials for VOC analysis. A groundwater sample was collected at the Selfridge site for analysis by USEPA Method 8260. This sample was shipped, on ice, to Alpha Analytical Laboratory in Mansfield, MA. The sample was received by the laboratory in good condition, and was analyzed within the required holding time.
- Samples collected for stable isotope analysis. Groundwater samples were collected in VOA vials provided by TestAmerica laboratory in Houston, Texas. Vapor samples were collected in sorbent tubes provided by the University of Oklahoma Geology Department contract laboratory. All samples for stable isotope analysis were shipped on ice to the University of Oklahoma. Samples were received by the laboratory in good condition except for groundwater samples from Raritan. Several vials containing samples from Raritan were broken during shipment. However, there was sufficient sample volume in the intact vials to complete the desired analysis.

The majority of the samples for isotope analysis were analyzed outside of the two week holding time that was validated during the laboratory study for ESTCP Project ER-201025 (Kuder et al., 2012). Additional analyses were completed to assess the data quality, and an extended holding time was validated as described in the ER-201025 final report.

### **6.2.1.3 Precision Assessment**

The precision assessment evaluates the agreement in analytical results between duplicate samples (i.e., field duplicates and lab duplicates). Precision was evaluated by calculating the relative percent difference (RPD) between paired samples, provided that the compound was detected in both.

#### Field Precision Assessment

For VOC analysis, the precision objective was less than 30% RPD between the paired results. For radon analysis, the objective was less than 30% RPD or <0.5 pCi/L difference, whichever was larger.

A total of 4 field duplicates were collected for TO-15 or TO-15 SIM analysis over the course of the demonstrations. RPD calculations were done if the analyte was detected in both the normal and field duplicate samples (Table D.2.1). 93% (13 of 14 values) met the RPD goal.

A total of 3 field duplicates were collected for radon analysis (Table D.2.1). All samples met the precision goal of <0.5 pCi/L.



## Laboratory Precision Assessment

Laboratory precision of air/vapor samples is demonstrated by RPD values calculated for the laboratory duplicates (e.g., duplicate analysis of field samples). For each demonstration site, all RPD values met the lab's criteria of  $\leq 25\%$  (see ALS lab reports in Appendix D.3).

### **6.2.1.4 Accuracy Assessment**

The laboratory accuracy assessment evaluates the agreement between an observed value and an accepted reference value. For the TO-15 and TO-15 SIM analyses, assessments of accuracy focus on laboratory QA/QC results from method blanks, surrogate spike recovery, and laboratory control samples. No analytes were detected in method blanks analyzed for each batch of demonstration site samples. Surrogate spike recovery and laboratory control sample (spike) recovery were within the lab's acceptance limits for each set of demonstration site samples (see ALS lab reports in Appendix D.3). Laboratory surrogate spike recovery acceptance limits were 70-130%; laboratory control sample recovery acceptance limits vary by analyte, and are typically in the range of 60-140%.

### **6.2.1.5 Completeness**

Completeness is the ratio of the number of valid sample results to the total number of samples planned. The completeness objective for field samples was at least 90%. With the exception of one field duplicate radon sample at Tyndall, all planned samples were collected, meeting the overall project goal. Individual demonstration site results are provided in Appendix C.

## **6.2.2 Evaluation of Performance Objective 2**

The data quality exceptions noted in the review above are typical of environmental field programs. None of these exceptions limit the usability of the results obtained. The results of the data quality review are summarized in Table 18.

**Table 18: Summary of Laboratory Data Evaluation Results**

Data Quality Objective	Results of Data Quality Evaluation			
	Groundwater by 8260	Air/Vapor TO-15 / TO-15 SIM	Groundwater/Vapor for Isotope Analysis	Air/Radon
Sampling Procedures	Acceptable	Acceptable	Acceptable	Acceptable
Custody Procedures	Acceptable	Acceptable	Acceptable	Acceptable
Holding Time	Acceptable	Acceptable	Acceptable*	Acceptable
Temperature on Arrival	Acceptable	NA	Acceptable	NA
Field Duplicate Samples	NA	Acceptable	Acceptable	Acceptable*
Surrogates, LCS/LCSD, MS/MSD Samples	Acceptable	Acceptable	NA	NA
Blank Analysis	Acceptable	Acceptable	Acceptable	NA
Completeness Assessment	NA	Acceptable	Acceptable	Acceptable
<b>Overall Data Usability</b>	<b>Acceptable</b>	<b>Acceptable</b>	<b>Acceptable</b>	<b>Acceptable</b>

Acceptable = This Data Quality Objective (DQO) was evaluated and found to have met the requirements outlined in the QAPP. Acceptable\* = This DQO was found to have deficiencies or exceptions as discussed in the text however, the data was determined to be usable. NA = DQO is not applicable to the indicated method.

### 6.2.3 Evaluation of UFP-QAPP Forms

As part of the demonstration, we were asked to evaluate the utility of several Uniform Federal Policy for Quality Assurance Project Plan (UFP-QAPP) forms for documentation of data quality related to the field demonstration. The UFP-QAPP forms were developed to provide procedures and guidance for consistently implementing the national consensus standard ANSI/ASQ E-4 (Quality Systems for Environmental Data and Technology Programs), for the collection and use of environmental data at Federal facilities. More information regarding these forms can be obtained from <http://www.epa.gov/fedfac/documents/qualityassurance.htm>.

In conjunction with a project reviewer, we identified a subset of forms applicable to the demonstration:

- Forms Applicable for All Sites
  - QAPP Worksheet #10: Conceptual Site Model
  - QAPP Worksheet #12: Measurement Performance Criteria
  - QAPP Worksheet #19&30: Sample Containers, Preservation, and Hold Times
  - QAPP Worksheet #20: Field QC Summary
  - QAPP Worksheet #21: Field SOPs
  - QAPP Worksheet #22: Field Equipment Calibration, Maintenance, Testing, and Inspection
  - QAPP Worksheet #34: Data Verification and Validation Inputs
  - QAPP Worksheet #35: Data Verification Procedures
  - QAPP Worksheet #37: Data Usability Assessment
  
- Forms for Individual Sites
  - QAPP Worksheet #18: Sampling Locations and Methods
  - QAPP Worksheet #26&27: Sample Handling, Custody, and Disposal

The completed forms are provided in Appendix D.2. These forms provide value for site investigation and remediation projects by presenting a standard set of necessary QA documentation in a standardized format. However, the standardized nature may act as a limitation where the project sampling and QA requirements are more varied. For example, the dynamic nature of the on-site analysis protocol is such that, while a user may estimate the number and location of samples to be collected, the final decision is not made until field conditions are assessed. The dynamic nature of the sample collection process is difficult to capture on the standardized forms. Additionally, for the demonstration, we adjusted some of the data collection goals based on results from the prior demonstration sites. These changes were needed to meet the overall project goals but were difficult to capture using the standardized forms. The forms would likely have been more useful if the decision to use them had been made prior to development of the demonstration plan.

### **6.3 OBJECTIVE 3: VALIDATION OF DRAFT PROTOCOL FOR USE OF ON-SITE ANALYSIS TO EVALUATE VAPOR INTRUSION**

The effectiveness of the on-site analysis protocol was evaluated by applying the protocol at seven buildings (across four demonstration sites) and comparing the results to those obtained using two alternative evaluation methods: i) conventional sampling and ii) the CSIA protocol. The vapor intrusion classification of each demonstration building was evaluated separately, in accordance with criteria established for each of the three investigation approaches (see Sections 5.7.1 – 5.7.3). Evaluation of the full dataset is provided below.

#### **6.3.1 Site-by-Site Analysis of Results: Building VI Classifications**

The hypothesis for this field demonstration was that the on-site analysis method will more commonly yield definitive results compared to the conventional sampling program. In order to test this hypothesis, the results from the on-site and conventional investigation methods were compared for each building. When the classification was the same, the methods were determined to have performed equally. When one method resulted in a more definitive classification than another (e.g., supporting evidence vs. results not definitive), that method was determined to have performed better. If the methods yielded contradictory classifications (e.g., supporting evidence of no vapor intrusion vs. supporting evidence of vapor intrusion), then the results from the isotope analysis and any other available information was used to determine which method performed better. The results for each of the seven buildings are summarized in Table 19 and discussed further below.

**Table 19: VI Classification based on Investigation Method**

<b>Building</b>	<b>Conventional Approach</b>	<b>CSIA Protocol</b>	<b>On-Site Analysis Protocol</b>	<b>Overall Result</b>
Lewis-McChord 9669	Supporting evidence of current VI (conc. below reg. level)	Supporting evidence of current VI	Evidence of current VI (conc. below reg. level)	<b>Results generally consistent between three methods. Results from on-site protocol were most definitive. On-site analysis/pressure control increase confidence in result and decrease concern with temporal variability.</b>
Lewis-McChord 9674	Supporting evidence of current VI (conc. below reg. level)	Not applicable (1)	No evidence of current/potential VI (conc. below reg. level)	<b>Low confidence in the conventional approach because of low concentrations. Results from on-site protocol were more definitive and increased confidence that there is no potential VI concern.</b>
Selfridge 1533	Inconclusive	Supporting Evidence of No Current VI	No evidence of current/potential VI	<b>Results generally consistent between CSIA and on-site methods. Results from on-site protocol were most definitive, indicating primary source was indoors.</b>
Tyndall 156	Supporting evidence of no current VI	Not applicable (1)	No evidence of current/potential VI	<b>Results generally consistent between two applicable methods. Results from on-site protocol were more definitive.</b>
Tyndall 219	Inconclusive (conc. below reg. level)	Not applicable (1)	Inconclusive (conc. below reg. level)	<b>On-site protocol performed the same as the conventional program.</b>
Raritan CP4	Supporting evidence of current VI (conc. below reg. level)	Strong Evidence of Indoor Source	Supporting evidence of current VI (below reg. level)	<b>CSIA protocol performed best. On-site protocol and conventional approach both provided incorrect results.</b>
Raritan 209	Supporting evidence of current VI (conc. below reg. level)	Not applicable (1)	No evidence of current VI (conc. below reg. level)	<b>Low confidence in the conventional approach because of low concentrations. Results from on-site protocol were more definitive. Low concern regarding temporal variability because building is strongly depressurized.</b>

Notes:

1) CSIA protocol not applicable because of low/no TCE in indoor air.

2) Classifications under each investigation approach indicate the evidence for vapor intrusion, followed by the implication (e.g., comparison to risk-based level) in parenthesis, if there is evidence of vapor intrusion.

Lewis-McChord 9669: The TCE concentration in indoor air ( $1.2$  to  $1.5 \mu\text{g}/\text{m}^3$ ) was up to 50% of the USEPA screening value ( $3.0 \mu\text{g}/\text{m}^3$ ) making the source (i.e., vapor intrusion vs. indoor or ambient) an important consideration. The conventional results were generally indicative of current vapor intrusion (Figure B.1.1). However, TCE was the only subsurface COC consistently detected in indoor air limiting the ability to evaluate the constituent ratio line of evidence. Building 9669 is a supply distribution warehouse that contains a large variety (over 100) of VOC-containing products. As a result, using the conventional results alone, it would be difficult to conclude with a high degree of confidence that no indoor sources of TCE were present. The on-site analysis protocol (both the baseline sampling and the pressure control) yielded results inconsistent with an indoor source of TCE (Figure B.1.3). These results provided a higher degree of confidence that the TCE detected in indoor air originated in the subsurface. The results of the on-site analysis protocol i) increased confidence in the result that vapor intrusion was occurring, but at levels below screening levels; and ii) decreased concern with temporal variability because of the variety of building conditions tested.

Lewis-McChord 9674: The TCE concentration in indoor air ( $0.072 \mu\text{g}/\text{m}^3$ ) was well below the USEPA screening value ( $3.0 \mu\text{g}/\text{m}^3$ ). As a result, definitively identifying the source (i.e., vapor intrusion vs. indoor or ambient) would be relatively unimportant for determining how to proceed. The conventional results yielded supporting evidence of current vapor intrusion (Figure B.2.1). However, there is not high confidence in this interpretation because concentration ratios were not clearly consistent with a groundwater source. Additionally, Building 9674 is a hazardous waste storage building. Using the conventional results alone, it would be difficult to conclude that the low ( $0.072 \mu\text{g}/\text{m}^3$ , approximately 2x the detection limit) TCE concentration was due to any particular source (e.g., subsurface, indoor, or residual from indoor source which had been removed prior to sampling). The difference between the “supporting evidence” finding for the conventional program and the “no evidence” finding for the on-site analysis program is primarily attributable to lower detection limits for the off-site analysis. The results from the on-site analysis protocol (both the baseline sampling and pressure control) increase the confidence that there is no vapor intrusion concern because the building was tested under multiple building pressure conditions, but resulted in the same “no evidence” finding for each pressure condition (Figure B.2.3). Additionally, no vapor entry points were found and no TCE concentration gradients were observed in the building under baseline and depressurized conditions.

Selfridge 1533: The conventional results were generally indicative of no vapor intrusion because the maximum benzene concentration in the sub-slab was less than 10x the concentration in indoor air and there were obvious non-removable sources in the building (i.e., automobiles being repaired). However, the benzene concentration in indoor air ( $14 \mu\text{g}/\text{m}^3$ ) was almost 10x greater than the risk-based screening value and the maximum benzene concentration in the sub-slab ( $58 \mu\text{g}/\text{m}^3$ ) was greater than the concentration in indoor air (Figure B.3.1). As a result, a regulator may have required additional evaluation of whether vapor intrusion was contributing to the benzene detected in indoor air. The results from the on-site protocol provided greater confidence that indoor sources were the predominate sources of benzene in indoor air because i) the on-site analysis documented the temporally variable impact of the indoor sources on benzene concentration in indoor air and ii) the building pressure control results were consistent with an

indoor source of benzene (Figure B.3.3). Because of the overall magnitude dominated by indoor sources, no additional evaluation would be warranted under current building use.

Tyndall 156: The conventional results provided strong evidence of no current vapor intrusion because TCE was not detected in indoor air (with a detection limit well below the USEPA screening value of  $3.0 \mu\text{g}/\text{m}^3$ ) (Figure B.4.1). The results from the on-site analysis protocol also provided strong evidence of no current vapor intrusion because TCE was not detected in indoor air (Figure B.4.3). The on-site analysis protocol also indicated that temporally-variable vapor intrusion is not a concern because no TCE was detected in indoor air under depressurized conditions.

Tyndall 219: The TCE concentration in indoor air ( $0.086\text{-}0.087 \mu\text{g}/\text{m}^3$ ) was well below the USEPA screening value ( $3.0 \mu\text{g}/\text{m}^3$ ). As a result, definitively identifying the source (i.e., vapor intrusion vs. indoor or ambient) would be relatively unimportant for determining how to proceed. The conventional results were inconclusive with regard to vapor intrusion. Although sub-slab TCE results were higher than indoor air, and indoor air TCE was higher than outdoors, concentration ratios were not consistent with vapor intrusion (Figure B.5.1). The on-site analysis results were also inconclusive in that a specific VOC source (i.e., subsurface vs. indoor source) was not found in the accessible portions of the building. Although this was true, it was also true that no hot spots were found, indicating a lack of strong source(s) within the building. Building depressurization was not conducted due to access constraints. However, differential pressure measurements collected during the on-site program show that the building was generally depressurized (i.e., condition conducive to vapor intrusion) (Figure B.5.3). This condition, combined with the lack of strong source and TCE concentrations well below screening levels, suggests that there are no vapor intrusion concerns in the building.

Raritan CP4: The TCE concentration in indoor air ( $1.3$  to  $2.1 \mu\text{g}/\text{m}^3$ ) was up to 67% of the USEPA screening value ( $3.0 \mu\text{g}/\text{m}^3$ ), making the source (i.e., vapor intrusion vs. indoor or ambient) an important consideration. The conventional results provided supporting evidence of vapor intrusion because the maximum TCE concentration in the sub-slab was more than 10x the TCE concentration in indoor air (Figure B.6.1). The on-site analysis protocol results also provided supporting evidence of vapor intrusion because i) TCE was detected in indoor air; ii) no indoor sources of TCE were found; iii) two floor cracks were identified as vapor entry points; and iv) the TCE concentrations measured in the wall gap of one room was higher than the highest TCE concentration measured in indoor air (Figure B.6.3). Elevated COC concentrations in wall gaps are consistent with vapor intrusion because wall gaps can be connected to vapor entry points and have lower air exchange rates than building interior spaces.

The on-site analysis protocol results, however, were not considered definitive for two reasons. First, the two floor crack entry points appeared to be minor because there were no measurable differences in indoor air TCE concentrations above the entry points vs. elsewhere in the warehouse area. Indoor air TCE concentrations were higher in other parts of the building, but no strong entry points were identified. Second, the wall gap appeared to represent a limited reservoir of TCE. TCE concentrations within the wall gap decreased after collection of a 6-L Summa sample. In addition, several other wall gaps tested did not show elevated concentrations of TCE. Based on the CSIA results, both the conventional results and the on-site analysis

protocol results appear to have provided an incorrect indication of vapor intrusion as the source of the TCE in indoor air.

The CSIA results for Raritan CP4 provided strong evidence of an indoor source because the TCE in groundwater was enriched in both  $^{13}\text{C}$  and  $^{37}\text{Cl}$  consistent with kinetic isotope effect of biodegradation while the TCE in indoor air had lower levels of  $^{13}\text{C}$  and  $^{37}\text{Cl}$  consistent untransformed TCE. Although no indoor source of TCE was identified during the site visit, the building manager reported that the building's cleaning service had used a TCE-based spot remover in the past. Although she had requested that they not use chlorinated solvents in the building, she indicated that it was possible that they were still using them during some cleaning events.

Although the combined results from the investigations of Raritan CP4 do not support a definitive source identification, the most likely explanation is the recent use of a TCE-containing spot remover. Based on the on-site analysis results, the highest TCE concentrations were found within a cluster of conference rooms that were the only carpeted spaces within the building. TCE concentrations within this cluster of rooms decreased from approximately  $6\ \mu\text{g}/\text{m}^3$  on the first day of the demonstration to approximately  $2\ \mu\text{g}/\text{m}^3$  on the fourth day. The elevated concentration of TCE in the wall gap would be consistent with recent use of TCE in the building because elevated TCE concentrations would persist longer in the wall gap than in the more ventilated room space.

Raritan 209: The conventional results provided supporting evidence of current vapor intrusion, with one 8-hour indoor air sample having a TCE concentration of  $0.064\ \mu\text{g}/\text{m}^3$  and the other  $<0.05\ \mu\text{g}/\text{m}^3$ . Because the maximum TCE concentration in indoor air ( $0.064\ \mu\text{g}/\text{m}^3$ ) was much less than the risk-based screening value ( $3.0\ \mu\text{g}/\text{m}^3$ ), there is no vapor intrusion concern (Figure B.7.1). The results from the on-site analysis protocol provided no evidence of current vapor intrusion. No hot spots with elevated TCE levels were found, and no vapor entry points were found. That, combined with indoor air results below instrument detection limits, indicates a lack of vapor intrusion (Section 5.7.3.1 for decision logic). Building 209 is strongly depressurized under normal operating conditions due to the continuous operation of numerous laboratory fume hoods. As a result, conditions were favorable for vapor intrusion during sample collection. The absence of TCE above risk-based levels in indoor air for both the conventional program and the on-site analysis protocol support a finding of no current or future vapor intrusion concern (Figure B.7.3).

### 6.3.2 Other Findings

- The Protocol is Applicable to Large Open Buildings: Prior to the field demonstrations, the on-site analysis protocol had been applied primarily to residences and smaller commercial buildings with discrete rooms. In these buildings, the concentration differences between rooms were important for identification of indoor sources and vapor entry points. For this demonstration, the protocol was applied in several buildings consisting of large, open spaces (e.g., Building 9669, 9674, 1533, CP4 warehouse). Even within open spaces, on-site analysis was able to identify spatial differences in concentrations leading to the identification of indoor sources (e.g., trans-1,2-DCE in Lewis-McChord Building 9669; Section 5.8.1) or vapor entry points (see Section 5.8.3).

Based on these results, it appears that the protocol is broadly applicable for all buildings subject to vapor intrusion investigation.

- Pressure Control is Effective in Large Buildings: Building pressure could be manipulated sufficiently to impact target VOC concentrations in buildings up to 20,000 sq. ft.
- Pressure Control Results Can Be Obtained in as Little as Two Hours: When pressure manipulation is done, concentrations of target VOCs tend to respond quickly. Using on-site analysis, the impact of pressure control is usually clear within one hour allowing for pressurization and depressurization to be completed in approximately two hours. When concentration changes are small or higher than usual variability is observed, longer times may be required to obtain clear results.
- The Protocol is Minimally Disruptive to Building Occupants: The protocol does not require installation of sub-slab sampling points. Minor inconveniences were possible, particularly when implementing the pressure control evaluation; however, equipment could generally be staged to avoid disruption of building activities. The pressure control portion of the investigation can be somewhat more disruptive because it requires that opening of doors be minimized while building pressure is being controlled. In addition, the use of a window or door fan to control building pressure may cause noticeable changes in indoor air temperature when the outdoor temperature is well above or below the baseline indoor air temperature. For this reason, pressure control of occupied buildings may not be appropriate when the outdoor temperature is above 90°F or below 40°F.
- The Survey Method has Limited Utility for Identification of Vapor Entry Points: For most demonstration buildings, the HAPSITE survey mode was not sufficiently sensitive to locate specific vapor entry points. However, use of the quantitative mode allowed identification of specific vapor entry points or specific areas within the building where vapor entry was occurring. While survey mode has successfully identified vapor entry points in some buildings (see Section 5.8.3), quantitative mode combined with building pressure control appears to be a more reliable method to identify vapor intrusion.

### **6.3.3 Evaluation of Performance Objective 3**

Overall, for six of the seven demonstration buildings, the on-site analysis protocol performed as well as or better than the conventional approach:

- At 4 of 7 of the demonstration buildings, the on-site analysis protocol performed as well as or better than the conventional approach (Lewis-McChord 9669, Selfridge 1533, Tyndall 156, Tyndall 219 [see Table 19]) by yielding clearer VI classifications (No evidence vs. Supporting evidence, etc.).
- At 2 of 7 of the demonstration buildings, the vapor intrusion interpretation from the on-site and conventional approaches were different. At these buildings, Lewis-McChord 9674 and Raritan 209, the conventional approach yielded supporting evidence for vapor intrusion while the on-site approach indicated there was no evidence of vapor intrusion.



When reviewing the indoor air results from the conventional approach, however, we note that the reported concentrations were low (Lewis-McChord 9674 TCE concentration 0.072 ug/m<sup>3</sup> [detection limit 0.038 ug/m<sup>3</sup>]; Raritan 209 TCE concentration <0.05 ug/m<sup>3</sup> and 0.064 ug/m<sup>3</sup> [detection limit 0.043 ug/m<sup>3</sup>]), resulting in less confidence in the conventional results. The on-site approach allows for higher sample density and includes the ability to retest under “worse” building pressure conditions. There is greater confidence in the on-site approach because testing was done under normal and depressurized conditions in multiple locations throughout the buildings, TCE was not detected in indoor air, and field QA met project requirements.

For one of the seven buildings (i.e., Raritan CP4), both the conventional and on-site results provided an incorrect indication of vapor intrusion as the primary source of TCE detected in the indoor air. At this one building, the CSIA approach provided the clearest result.

Supplemental results from four other buildings demonstrated the utility of the on-site analysis protocol for understanding vapor intrusion conditions by i) identifying indoor sources of VOCs; ii) identifying specific vapor intrusion entry points; and iii) confirming the presence or absence of vapor intrusion through building pressure control. Taken as a whole, the demonstration results validate the on-site analysis protocol as a reliable method to determine the presence or absence of vapor intrusion in a building.

## **6.4 OBJECTIVE 4: IMPLEMENTABILITY AND COST EFFECTIVENESS OF THE PROTOCOL FOR ON-SITE ANALYSIS**

### **6.4.1 Demonstration Findings**

This objective was evaluated by reviewing the experience gained during the demonstration. Overall, the protocol was more effective than the other investigation methods used, yielding clearer results and interpretations of the vapor intrusion concern in each building.

Factors which influenced the implementability of the protocol during the demonstration included:

- Choice of Instrument: The most reliable instrument was the SMART PLUS. The HAPSITE ER worked well when the instrument was functioning properly, but was not reliable.
- Key target VOC: The customized HAPSITE methods described in the Demonstration Plan typically met all performance standards for TCE and PCE (cVOC method) and benzene (petroleum VOC method). However, the methods were less suited for compounds such as vinyl chloride (cVOC method) and toluene (petroleum VOC method). For these analytes, RSD and/or RSD of RF calibration goals were not met at Tyndall and Selfridge, respectively. For investigations where these are the primary target analytes, we would recommend development of an alternative customized method better optimized for these analytes.

- Personnel: Successful implementation of the protocol requires personnel with experience in i) operation of the HAPSITE (or alternative on-site instrument); and ii) implementation of the protocol. Key skills for HAPSITE operation are familiarity with normal instrument performance and ability to recognize non-standard performance, ability to analyze and understand detailed results to identify false positive detections and missed quantifications reported by the software operated in default mode. Key skills for implementation of the protocol are the ability to evaluate information from different sources (e.g., on-site analysis instrument, pressure transducer, interviews and building inspection) in order to proceed correctly through the protocol logic.

#### **6.4.2 Evaluation of Performance Objective 4**

The on-site analysis protocol is implementable (by personnel with adequate experience) and cost effective (see Section 7).

We recommend a field team of at least two staff to assist with HAPSITE operation, including daily QA tasks. In addition, one of the team members should be well versed in the logic of the protocol. Because fundamental elements such as the number of samples and sample locations are dynamic and build upon cumulative results of the investigation in-progress, the senior team member should have the knowledge and authority to make field decisions on how the investigation should progress.

The protocol will be most cost effective when applied to multiple buildings during a single mobilization. Also, on-site analysis is best suited to differentiate between indoor and subsurface sources of VOCs. Based on our experience to date, final decision-making with regard to quantitative, “definitive” comparisons to regulatory, risk-based screening levels should be done using laboratory-analyzed confirmation samples because of practical limitations on generating lab-quality data in the field. The following example scenario describes how the protocol may be most effectively applied:

- Initial Screening: Many buildings identified for indoor air testing are not found to have vapor intrusion. For many buildings, initial testing shows no COCs in indoor air that exceed applicable risk limits. Provided that any concerns regarding possible temporal variability are addressed, these buildings can be eliminated from further evaluation for vapor intrusion. Initial screening can be conducted using Summa canisters, passive sorbent samplers, or an on-site instrument.
- On-Site Analysis Protocol: The on-site analysis protocol can be applied in the subset of buildings with COC concentrations exceeding the screening level. These buildings with higher concentrations are likely to have either indoor or subsurface sources which can be distinguished using the protocol. Follow up actions can be determined based on the strength of the findings (e.g., VOCs strongly attributed to indoor source, etc.) and final COC concentration relative to the applicable screening level.
- Training: The on-site analysis protocol (Appendix E) is intended to provide sufficient detail to be implemented by an environmental professional with a few years of general experience, experience with vapor intrusion field investigations, and a sound

understanding of vapor intrusion processes. Proper operation of the HAPSITE will typically require at least one day of training. Additional field experience with the HAPSITE will be helpful for the user to obtain a practical understanding of typical instrument performance and response. This additional experience may be necessary for a user to accurately identify operational issues while in the field; for example, cases where ions from non-target compounds result in the default software settings yielding false-positive target compound detections. In addition, application of the on-site analysis protocol is the type of relatively complex task where proficiency generally increases with experience.

### 6.4.3 Modifications to the On-Site Analysis Protocol

Based on the field experience from the demonstration, the following modifications have been made to the on-site analysis protocol that was presented in the Demonstration Plan. The revised protocol is provided as Appendix E of this report.

- **Calibration and QA Needs:** If the on-site GC/MS instrument's response is known and it is sufficiently sensitive and precise, then calibration prior to use is not necessary. Daily blank and CCV samples are helpful to monitor the instrument's stability. In most cases, ambient air may be used for blanks. The user should be aware that the use of nitrogen (and Tedlar bags) may be problematic.
- **QA Samples:** Field duplicates at a set collection rate are not recommended. Field duplicates are encouraged to confirm anomalous results. Field duplicates may also be done during the baseline period, if necessary, but are not recommended while building pressure is being manipulated.
- **Sampling during the Pressure Control Evaluation:** During the demonstration, target VOC concentrations responded quickly to pressure manipulation. Samples should be analyzed more quickly at the beginning of the pressure period, to characterize the change and determine when concentrations have stabilized.
- **Use of Flux Devices:** Flux jars or other isolation devices may be helpful if quantitative or semi-quantitative emission calculations are desired. However, sampling bulk indoor air may be sufficient to determine whether the indoor source is significant or not (i.e., if there's an overall concentration change after removal [see Figure 6 in Section 5.8.1]). The protocol has been revised to discuss the general benefits of isolating potential sources. The description of flux jars has been retained as an option.
- **Confirmation Samples:** The draft protocol included collection of grab samples for off-site laboratory TO-15 analysis. The protocol has been revised to note that grab, 8-hour, or 24-hour samples may be collected for off-site laboratory analysis, depending on the intended use of the data. Grab samples are most consistent with the HAPSITE sample collection process, and would serve as better "split" samples if the investigator intends to evaluate HAPSITE accuracy. Many regulatory guidance documents, however, require time integrated samples for comparison to screening levels.

- Radon: Radon can be used as a soil gas tracer to verify the effectiveness of building pressure manipulation. At the demonstration sites, the baseline radon concentration varied widely. In areas where radon concentrations were high enough to be reliably measured, the radon results were consistent with the expected change (i.e., increased concentrations during building depressurization; decreased concentrations during pressurization). However, in some areas (e.g., Tyndall), overall radon concentrations were low and results were at or below the quantitation limits. The revised protocol includes radon sampling as an option, rather than a required step.

## 7.0 COST ASSESSMENT

The costs of implementing the field demonstration programs were tracked and used to estimate the expected cost of implementing the validated on-site analysis protocol. It is important to note that the field demonstrations included additional tasks and associated costs in order to validate the protocol (e.g., collecting samples for three investigation methods, rather than one). These costs would not be incurred during standard application of the procedure. Therefore, Section 7.1 describes the cost model associated with the demonstration, while Sections 7.2 and 7.3 focus on cost considerations for routine application of the procedure.

### 7.1 COST MODEL FOR THE DEMONSTRATION

The demonstration included three different site characterization methods, each implemented at four DoD sites. Key cost elements included i) project planning and preparation; ii) field implementation; and iii) data evaluation and reporting (Table 20). Travel and shipping costs are not included in these estimates, as they will vary by location.

**Table 20: Cost Model for the Field Demonstration**

Cost Element	Data to be Tracked	Examples
1. Project planning and preparation	Labor hours	Senior Project Scientist/Engineer, Project Scientist / Engineer
	Supplies (On-Site Analysis Protocol)	Calibration gas, Tedlar bags
2. Field program	Labor hours	Senior Project Scientist/Engineer, Project Scientist / Engineer
	Conventional Program	
	Equipment Rental, Supplies	Hammer drill rental, helium meter rental
	Sample Analysis	Off-site laboratory analysis of air/vapor samples
	CSIA Protocol	
	Equipment Rental, Supplies	Pumps, consumables
	Sample Analysis	Off-site laboratory analysis of water or sorbent tube samples
	On-Site Analysis Protocol	
	Equipment Rental, Supplies	HAPSITE rental, operating costs, consumables
	Sample Analysis	Off-site laboratory analysis of confirmation samples
3. Data evaluation and reporting	Labor hours	Senior Project Scientist/Engineer, Project Scientist / Engineer

Note: Cost model does not include travel or shipping costs.

### 7.1.1 Cost Element: Project Planning and Preparation

Project planning included reviewing existing site data, prioritizing buildings for investigation, identifying target VOCs, and obtaining site access. These factors will typically be independent of investigation method.

The primary cost in this element comes from labor requirements (see Table 21). For the demonstration, the time required for planning varied widely, and depended primarily upon site-specific circumstances such as i) the number of meetings and effort needed to gain access; and ii) volume of historic data reviewed to determine the specific buildings for investigation. Field preparation (e.g., calibrating and testing the HAPSITE) was completed the day before on-site work began. Additional time was needed if the instrument required re-calibration during the course of the investigation, or the analytical methods needed to be modified and tested to address site-specific target VOCs.

**Table 21: Typical Consultant Labor Requirements for Project Planning**

Cost Element	Sub Category	Representative Amount
Project Planning and Preparation	Project Planning (pre-field event)	
	Labor hours: Senior Project Scientist/Engineer	10-15 hours per site
	Labor hours: Project Scientist/Engineer	25-35 hours per site
	Preparation (on location, prior to building investigation)	
	Labor hours: Senior Project Scientist/Engineer	2-4 hours per site
	Labor hours: Project Scientist/Engineer	4-8 hours per site

Note: Labor hours are specific to the on-site protocol, and do not include time required for general tasks (shipping, travel, etc.).

Costs for supplies included special standard gas mixes needed to calibrate and analyze for particular site-specific target VOCs. Specialty gas mixes typically cost in the range of \$1,000 - \$1,500, and may require 3-4 weeks lead time for ordering.

### 7.1.2 Cost Element: On-Site Analysis Field Program

Costs for the on-site analysis portion of the field demonstration are summarized in Table 22.

**Table 22: Representative Unit Costs for On-Site Analysis Demonstration**

Cost Element	Sub Category	Representative Unit Cost	Representative Unit
On-Site Analysis Field Program	Labor hours: Senior Project Scientist/Engineer	4-8	Hours per building
	Labor hours: Project Scientist/Engineer	4-8	Hours per building
	HAPSITE Rental	\$500	Dollars per day
	Other Equipment Rental (floor fan, differential pressure recorder)	\$75	Dollars per day
	Supplies (Tedlar bags, HAPSITE consumables)	\$50	Dollars per day
	Sample Analysis: Air/gas sample TO-15 analysis at off-site lab	\$240 (\$150 analysis + \$90 lab equipment rental)	Per air/gas sample
	Sample Analysis: Air/gas sample radon analysis at off-site lab	\$110 (\$100 analysis + \$10 PVF bag)	Per air/gas sample

### 7.1.3 Cost Element: Data Evaluation and Reporting

Following completion of the on-site analysis field program, the results were reviewed and organized into a report. Key elements included data review and validation, documentation of the results, and documentation of the overall findings.

The primary cost for this element is for labor. Typical time required for data compilation, review and reporting is summarized in Table 23, and varied based on the number of buildings and samples collected and any additional quality checking that was needed (e.g., if the dataset required additional processing or review to evaluate false positives).

**Table 23: Typical Labor Requirements for Data Evaluation and Reporting**

Cost Element	Sub Category	Representative Amount
Data Evaluation and Reporting	Labor hours: Senior Project Scientist/Engineer	10-15 hours per site
	Labor hours: Project Scientist/Engineer	25-40 hours per site

Note: Estimates include download of HAPSITE results, data management, and evaluation of the HAPSITE results.

## 7.2 COST DRIVERS

The cost for implementation of the on-site analysis protocol is not expected to vary significantly based on specific site characteristics. Although aspects of the protocol are dynamic (e.g., specific number of samples collected for on-site analysis), associated costs are not because HAPSITE and other equipment usage charges are typically assessed on a daily or weekly basis. Important project-specific cost considerations for routine implementation of the protocol are i) mobilization costs; and ii) number of buildings to be evaluated per mobilization.

## 7.3 COST ANALYSIS

Routine implementation of the on-site analysis protocol will cost less than implementation during the field demonstration because of the additional tasks needed to validate the protocol.

The on-site analysis protocol may be used as a standalone investigation method or as a component of a larger vapor intrusion investigation. As an example of the latter case, the protocol can be used at buildings in which target VOCs have been found in indoor air at concentrations above screening levels and there is a need to locate the source of VOCs (i.e., vapor intrusion vs. indoor source). Locating the actual source is helpful to avoid unnecessary re-sampling or mitigation system installation that may be triggered by ambiguous results produced from a traditional investigation.

Costs for the on-site analysis protocol (Table 24) are marginally higher than costs of a conventional investigation (Table 25). However, the higher costs are offset by the nature of the results. In other words, the on-site analysis protocol typically yields clearer results than a conventional investigation. Clearer results potentially lead to less need for resampling.



**Table 24: Costs for Routine Implementation of On-Site Analysis Protocol at Four Buildings**

<b>Cost Element</b>	<b>Category</b>				<b>Unit Cost</b>	<b>Unit</b>	<b>Cost</b>	<b>TOTALS</b>
1. Project planning and preparation	Labor	Senior Project Scientist/Engineer	16	hours	\$150	\$/hr	\$2,400	\$6,000
	Labor	Project Scientist / Engineer	36	hours	\$100	\$/hr	\$3,600	
2. On-site analysis field program	Labor	Senior Project Scientist/Engineer	24	hours	\$150	\$/hr	\$3,600	\$10,605
	Labor	Project Scientist / Engineer	24	hours	\$100	\$/hr	\$2,400	
	Equipment Rental	HAPSITE, Floor fan, differential pressure recorder	3	days	\$575	\$/day	\$1,725	
	Off-site Sample Analysis	VOCs (3 samples × 4 buildings)	12	samples	\$240	\$/spl	\$2,880	
	Off-site Sample Analysis	Radon (3 samples × 4 buildings)	0	samples	\$110	\$/spl	0	
3. Data evaluation and reporting	Labor	Senior Project Scientist/Engineer	15	hours	\$150	\$/hr	\$2,250	\$5,750
	Labor	Project Scientist / Engineer	35	hours	\$100	\$/hr	\$3,500	
<b>Project Total:</b>								<b>\$22,355</b>
<b>Cost Per Building:</b>								<b>\$5,589</b>

Note: 1) Estimates assume application of the procedure at four buildings during a single field program, assuming 2 buildings per day. Project planning and preparation includes pre-mobilization and on-location tasks (equipment prep/QA). 2) Cost estimates do not include travel to the site or shipping.

**Table 25: Estimated Cost of Typical Vapor Intrusion Investigation at Four Buildings**

Cost Element	Category				Unit Cost	Unit	Cost	TOTALS
1. Project planning and preparation	Labor	Senior Project Scientist/Engineer	8	hours	\$150	\$/hr	\$1,200	\$3,200
	Labor	Project Scientist / Engineer	20	hours	\$100	\$/hr	\$2,000	
2. Conventional field program	Labor	Senior Project Scientist/Engineer	16	hours	\$150	\$/hr	\$2,400	\$13,640
	Labor	Project Scientist / Engineer	24	hours	\$100	\$/hr	\$2,400	
	Labor	Technician (sub-slab installation, etc.)	24	hours	\$75	\$/hr	\$1,800	
	Equipment Rental, Supplies	Sub-slab point installation, leak tracer gas (e.g., helium), helium meter	4	buildings	\$500	\$/bldg	\$2,000	
	Off-site Sample Analysis	VOCs (3 sub-slab, 2 indoor air per building × 4 buildings + 1 outdoor)	21	samples	\$240	\$/spl	\$5,040	
3. Data evaluation and reporting	Labor	Senior Project Scientist/Engineer	10	hours	\$150	\$/hr	\$1,500	\$3,900
	Labor	Project Scientist / Engineer	24	hours	\$100	\$/hr	\$2,400	
<b>Project Total:</b>								<b>\$20,740</b>
<b>Cost Per Building:</b>								<b>\$5,185</b>

Note: Cost estimates do not include travel to the site or shipping. Labor hours assume building inspection/manual product removal, sub-slab sample point installations, sub-slab/indoor/ambient sample setup, collection, and pickup.

## 8.0 IMPLEMENTATION ISSUES

This project has resulted in development and validation of an on-site GC/MS analysis protocol to distinguish vapor intrusion from indoor sources of VOCs, one of the major issues with current investigation techniques. The protocol is a useful tool to help users evaluate building-specific vapor intrusion risks and rapidly identify cases of real vapor intrusion or cases where vapor intrusion is not a concern.

Advantages of the protocol include:

- Real-time results: The key advantage of the on-site analysis method is the ability to measure indoor air VOC concentrations and determine the primary sources (i.e., indoor vs. subsurface) in real time during the course of the field investigation. Because of the short analytical method run times, many samples can be collected while on site, resulting in a large volume of data available for interpretation while still in the field. This allows the investigators to more readily react to building-specific situations and make decisions (e.g., rule out vapor intrusion, determine potential vapor entry points, find primary VOC sources, etc.).
- Definitive data: Although the method focuses on on-site analysis, a small number of indoor air samples are collected for off-site laboratory analysis to confirm key findings. These confirmation sample results are supported by standard laboratory QA/QC.
- No sub-slab sample points: The protocol eliminates the need to drill through the building foundation.
- Reduced sampling requirements: Because indoor sources of VOCs can be identified and removed during the investigation, the on-site analysis method will more frequently yield clearer results compared to the conventional investigation approach. When used in conjunction with building pressure manipulation, the need for further sampling to characterize temporal variability may also be reduced or eliminated.

Potential limitations to the use of the on-site GC/MS analysis protocol include:

- Equipment availability and reliability: The HAPSITE GC/MS (SMART PLUS) or alternate instrument for on-site analysis is less common than the equipment used for the conventional investigation approach. As a result, equipment availability, procurement, and scheduling may be more complex. Additionally, during the instrument selection process, users should verify that the instrument can meet project QA requirements (e.g., sensitive enough to detect target VOCs at levels of regulatory concern).
- Staff suitably trained in interpretation of vapor data: The field team should include one more senior staff member with the knowledge, skills, ability and authority to make field-decisions based on the on-site measurements. The team should also include at least one experienced HAPSITE operator.

- Target compounds: Specific target compounds should be sufficiently volatile to be detected at concentrations similar to the applicable indoor air screening concentration. Less volatile compounds such as naphthalene may not be good candidates for on-site analysis because it is difficult to calibrate the on-site instrument for analysis of low concentrations of less volatile compounds. Additionally, accurate identification may be problematic with certain VOCs (e.g., vinyl chloride, cis-1,2-dichloroethylene). This issue may be addressed by fine-tuning the analytical method or interpreting chromatograms and ion mass ratio data in the field.
- Temporal variability: Changes in building pressure relative to the subsurface can cause temporal variations in vapor intrusion. As a result, a one-day investigation program with uncontrolled building conditions may not identify vapor intrusion that could occur under other building pressure conditions. The on-site analysis method itself does not account for potentially episodic vapor intrusion. The protocol (GSI, 2012b), however, includes an optional building pressure control step which minimizes concerns about temporal variability. Building depressurization, for example, will enhance the potential for vapor intrusion. Induced negative pressure will tend to draw subsurface vapors, if present, up into the building. As a result, an absence of vapor intrusion under both baseline and induced negative pressure conditions serves to reduce the concern regarding temporally-variable vapor intrusion.
- Building construction: For building pressure control to be effective, the building cannot be too large (>20,000 sq. ft.) or too leaky (e.g., constructed with built-in ventilation slats).

## 9.0 REFERENCES

- 3E Consultants, 2011. Supplemental Site Assessment Report, Tyndall Air Force Base Site 264/280.
- Dawson, H. E., and T. McAlary, 2009. A compilation of statistics for VOCs from post-1990 indoor air concentration studies in North American residences unaffected by subsurface vapor intrusion. *Ground Water Monitoring and Remediation* 29(1): 60-69.
- DiGiulio, D., C. Paul, R. Cody, R. Willey, S. Clifford, P. Kahn, R. Mosley, A. Lee, and K. Christensen, 2006. *Assessment of Vapor Intrusion in Homes Near the Raymark Superfund Site Using Basement and Sub-Slab Air Samples*. March 2006. U.S. EPA Office of Research and Development. Publication Number EPA/600/R-05/147.
- Doucette, W. J., A. J. Hall, and K. A. Gorder, 2009. Emissions of 1,2-dichloroethane from holiday decorations as a source of indoor air contamination. *Ground Water Monitoring & Remediation* 30 (1): 67-73.
- Eklund B.M., and M.A. Simon, 2007. Concentration of tetrachloroethylene in indoor air at a former dry cleaner facility as a function of subsurface contamination: a case study. *Journal Air Waste Management Association* 57(6):753-60.
- Envirosphere, 1988. Fort Lewis Logistics Center Remedial Investigation/Feasibility Study.
- Folkes, D., W. Wertz, J. Kurtz, and T. Kuehster, 2009. Observed Spatial and Temporal Distributions of cVOCs at Colorado and New York Vapor Intrusion Sites. *Ground Water Monitoring and Remediation* 29(1): 70-80.
- Gorder, K.A., and E.M. Dettenmaier, 2011. Portable GC/MS Methods to Evaluate Sources of cVOC Contamination in Indoor Air. *Ground Water Monitoring and Remediation* 31(4): 113-119.
- GSI Environmental, 2012a. Results of Laboratory Validation Study, ESTCP Project ER-201119, Use of On-Site GC/MS Analysis to Distinguish between Vapor Intrusion and Indoor Sources of VOCs (McHugh, Molofsky, Gorder, Dettenmaier, Rivera-Duarte, Version 3, August 2012).
- GSI Environmental, 2012b, Protocol for Site Investigations, ESTCP Project ER-201119, Use of On-Site GC/MS Analysis to Distinguish between Vapor Intrusion and Indoor Sources of VOCs (McHugh, Beckley, Gorder, Dettenmaier, Rivera-Duarte, Version 2, May 2012).
- GSI Environmental, 2012c, Demonstration Plan, ESTCP Project ER-201119, Use of On-Site GC/MS Analysis to Distinguish between Vapor Intrusion and Indoor Sources of VOCs (McHugh, Beckley, Gorder, Dettenmaier, Rivera-Duarte, Version 2, May 2012).

GSI Environmental, 2012d, Demonstration Plan, ESTCP Project ER-201025, Use of Compound-Specific Isotope Analysis to Distinguish between Vapor Intrusion and Indoor Sources of VOCs (McHugh, Kuder, Philp, Version 2, June 2012).

GSI Environmental, 2012e, ESTCP Project ER-201025 Task 2 Report: Characterization of Sources and Investigation Protocol, Use of Compound-Specific Stable Isotope Analysis to Distinguish between Vapor Intrusion and Indoor Sources of VOCs (McHugh, Kuder, Philp, Version 2, May 2012).

Interstate Technology & Regulatory Council (ITRC), 2007. Vapor Intrusion: A Practical Guideline. Interstate Technology & Regulatory Council, Washington, DC.

Klisch, M., T. Kuder, R.P. Philp, T.E. McHugh, 2012. Validation of Adsorbents for Sample Preconcentration in Compound-Specific Isotope Analysis of Common Vapor Intrusion Pollutants, *Journal of Chromatography* 1270:20-27.

Kuder, T., M. Klisch, R.P. Philp, and T. McHugh, 2012, Laboratory Study Report, Use of Compound-Specific Stable Isotope Analysis to Distinguish between Vapor Intrusion and Indoor Sources of VOCs, ER-201025, Version 2, January 2012.

McHugh T.E., D.E. Hammond, T. Nickels, and B. Hartman, 2008. Use of Radon Measurements for Evaluation of VOC Vapor Intrusion. *Environmental Forensics* 9(1): 107-114.

McHugh T.E., L. Beckley, D. Bailey, K. Gorder, E. Dettenmaier, I. Rivera-Duarte, S. Brock and I. MacGregor, 2012. Evaluation of Vapor Intrusion Using Controlled Building Pressure. *Environmental Science and Technology* 46 (9): 4792–4799.

New Jersey Department of Environmental Protection (NJDEP), 2006. *Vapor Intrusion Guidance*. Available at <http://www.nj.gov/dep/srp/guidance/vaporintrusion/vig.htm>

New York Department of Health (NYDOH), 2006. *Guidance for Evaluating Soil Vapor Intrusion in the State of New York*. Available at [http://www.health.state.ny.us/environmental/investigations/soil\\_gas/svi\\_guidance/](http://www.health.state.ny.us/environmental/investigations/soil_gas/svi_guidance/).

Sanders, P.F., and I. Hers, 2006. Vapor Intrusion in Homes over Gasoline-Contaminated Ground Water in Stafford, New Jersey, *Ground Water Monitoring and Remediation* 26(1): 63-72.

Tillman, F. D. and J. W. Weaver, 2005. *Review of Recent Research on Vapor Intrusion*, U.S. EPA Office of Research and Development. Publication Number EPA/600/R-05/106.

URS, 2008. Semi-Annual Groundwater Monitoring Report, Tyndall Air Force Base SS026.

USEPA, 2002. *Draft Guidance for Evaluating the Vapor Intrusion to Indoor Air Pathway from Groundwater and Soils (Subsurface Vapor Intrusion Guidance)*. Available at <http://www.epa.gov/epaoswer/hazwaste/ca/eis/vapor.htm>.

USEPA, 2010. Review of the Draft 2002 Subsurface Vapor Intrusion Guidance, Office of Solid Waste and Emergency Response. Available at <http://www.epa.gov/oswer/vaporintrusion/>.

USEPA, 2011a, Background Indoor Air Concentrations of Volatile Organic Compounds in North American Residences (1990-2009). U.S. Environmental Protection Agency Office of Solid Waste and Emergency Response, EPA 530-R-10-001.

USEPA, 2011b, Environmental Technology Verification Report Verification of Building Pressure Control as Conducted by GSI Environmental, Inc. for the Assessment of Vapor Intrusion, <http://www.epa.gov/nrmrl/std/etv/vt-ams.html#sctvi>.

USEPA, 2013, Regional Screening Table, Available at [http://www.epa.gov/reg3hwmd/risk/human/rb-concentration\\_table/index.htm](http://www.epa.gov/reg3hwmd/risk/human/rb-concentration_table/index.htm). May 2013 update, accessed 24 June 2013.

Weston Solutions, 2012, Indoor Air Quality Report #8, Former Raritan Arsenal, Edison, New Jersey. Preliminary Draft.

Weston Solutions, 2013, Groundwater AOC 2 and 8A/B Progress Report for the Former Raritan Arsenal, Edison, New Jersey. Preliminary Draft.

# **Appendix A: Points of Contact**

---

## **Use of On-Site GC/MS Analysis to Distinguish between Vapor Intrusion and Indoor Sources of VOCs**



## Appendix A: Points of Contact

POINT OF CONTACT Name	ORGANIZATION Name Address	Phone Fax E-mail	Role in Project
Tom McHugh	GSI Environmental Inc. 2211 Norfolk Street Ste 1000 Houston, TX 77098	temchugh@gsi-net.com	Principal Investigator (PI)
Lila Beckley	GSI Environmental Inc. 9600 Great Hills Trail Ste 350E Austin, TX 78759	Ph: 512-346-4474 Fax: 512-346-4476 lbeckley@gsi-net.com	Project Team Member
Kyle Gorder	75CEG/CEVR 7274 Wardleigh Rd Hill AFB Utah 84056-5137	Ph: 801-775-2559 kyle.gorder@hill.af.mil	Project Team Member
Erik Dettenmaier	75CEG/CEVR 7274 Wardleigh Rd Hill AFB Utah 84056-5137	Ph: 801-777-3804 Erik.Dettenmaier@hill.af.mil	Project Team Member
Ignacio Rivera-Duarte	SPAWAR Systems Center Pacific Code 71752, Environmental Analysis and Compliance 53475 Strothe Rd. San Diego, CA 92152-6343	Ph: (619) 553-2373 ignacio.rivera@navy.mil	Project Team Member
Dr. Sam Brock	AFCEC 3300 Sidney Brooks Brooks City-Base TX, 78235	Ph: 210-536-4329 Fax: 210-536-4330 Samuel.Brock@brooks.af.mil	Contracting Officer's Rep.
William Myers	Environmental Restoration Bldg 2012 Liggett AVE RM 313 Box 339500, MS-17 JBLM, WA 98433-9500	Ph: 253-477-3742 william.w.myers@us.army.mil	Site Project Manager (Demonstration Site #1)
Cheryl Neades	Environmental Division, IMMI-PWE U.S. Army Garrison Detroit Arsenal, Michigan	Ph: 586-282-8345 cheryl.l.neades.civ@mail.mil	Site Project Manager (Demonstration Site #2)
Miguel Plaza	Environmental Restoration Flight 325 CES/PMO 119 Alabama Avenue Tyndall AFB, FL 32403	Ph: 850-283-2398 miguel.plaza@tyndall.af.mil	Site Project Manager (Demonstration Site #3)
Sandra Pietro	Environmental Branch U.S. Army Corps of Engineers NY District, Jacob K. Javits Federal Building, 26 Federal Plaza, Room 1811 New York, NY 10278-0098	Ph: 917-790-8487 Sandra.L.Pietro@usace.army.mil	Site Project Manager (Demonstration Site #4)

# **Appendix B: Lines of Evidence Evaluations**

---

## **Use of On-Site GC/MS Analysis to Distinguish between Vapor Intrusion and Indoor Sources of VOCs**

## FIGURE B.1.1: RESULTS FROM CONVENTIONAL VAPOR INTRUSION PROGRAM

ESTCP Project ER-201119, Use of On-Site GC/MS Analysis to Distinguish between VI and Indoor Sources of VOCs

### Site Data: Lewis-McChord Building 9669, Washington

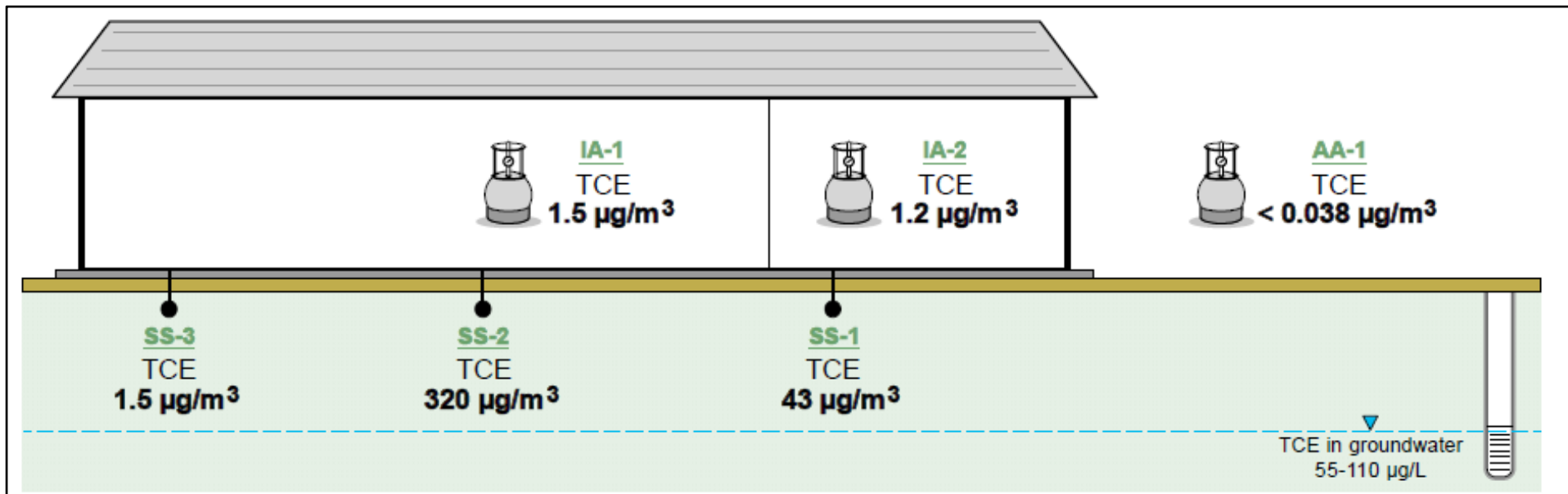

### Data Interpretation

Line of Evidence	Consistent with VI?	Comment
• Indoor air concentration > outdoor air?	<b>Yes</b>	Also consistent with potential indoor source
• Sub-slab >10x indoor air concentration?	<b>Yes</b>	At 2 of 3 sub-slab points
• Sub-slab to indoor air concentration ratios consistent with VI?	<b>Yes</b>	TCE, PCE, 111TCA are highest conc VOCs in sub-slab; also detected in indoor air, with similar conc ratios.
• Concentration ratios consistent with groundwater (GW) source?	<b>Inconclusive</b>	In GW, c12DCE is approx 2% of TCE conc; c12DCE not detected in sub-slab or indoor air, but may not have been detectable because of low conc in GW source; PCE, 111TCA not detected in GW.

**FINDING:** Supporting evidence of current vapor intrusion

**IMPLICATION:** Indoor air conc (1.5 ug/m3) is BELOW USEPA screening level (3 ug/m3); however, monitoring may be appropriate to characterize temporal variability.

### FIGURE B.1.2: RESULTS FROM CSIA PROTOCOL

ESTCP Project ER-201119, Use of On-Site GC/MS Analysis to Distinguish between VI and Indoor Sources of VOCs

#### Site Data: Lewis-McChord Building 9669, Washington

#### Indoor Air vs. Groundwater Isotope Signatures

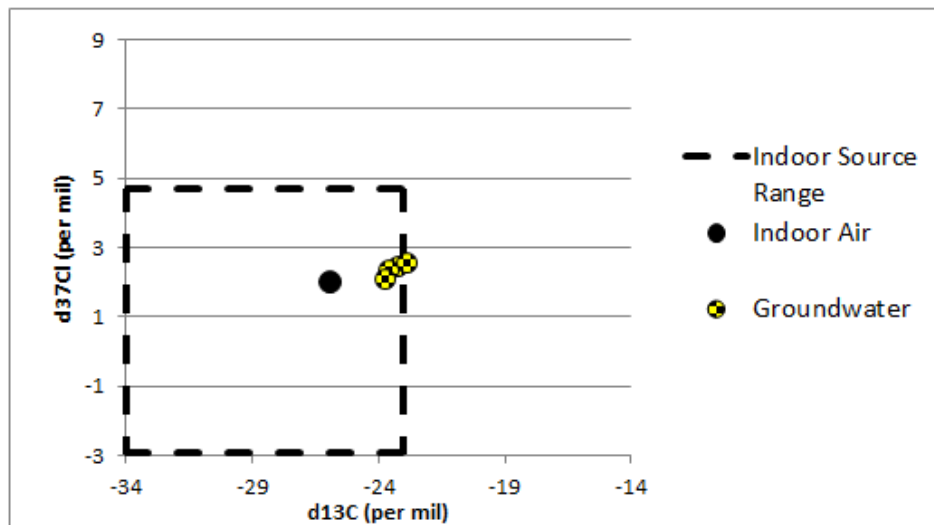

#### Data Interpretation

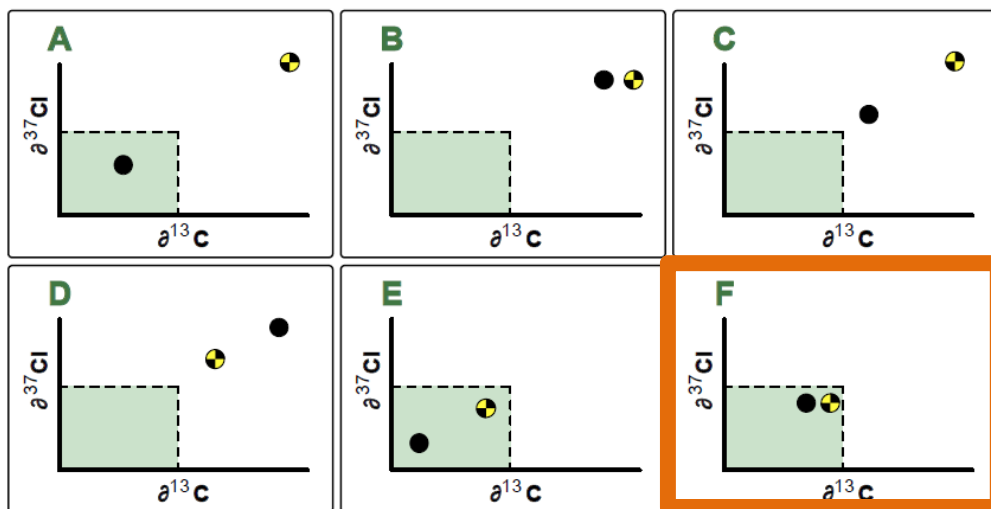

- LEGEND**
- Indoor air sample
  - Subsurface source

**FINDING:** Supporting evidence of current vapor intrusion

Notes: 1) See Section 5.7.2 for decision logic. 2) See Table C.1.2 for CSIA sample results.

## FIGURE B.1.3: RESULTS FROM ON-SITE ANALYSIS PROTOCOL

ESTCP Project ER-201119, Use of On-Site GC/MS Analysis to Distinguish between VI and Indoor Sources of VOCs

### Site Data: Lewis-McChord Building 9669, Washington

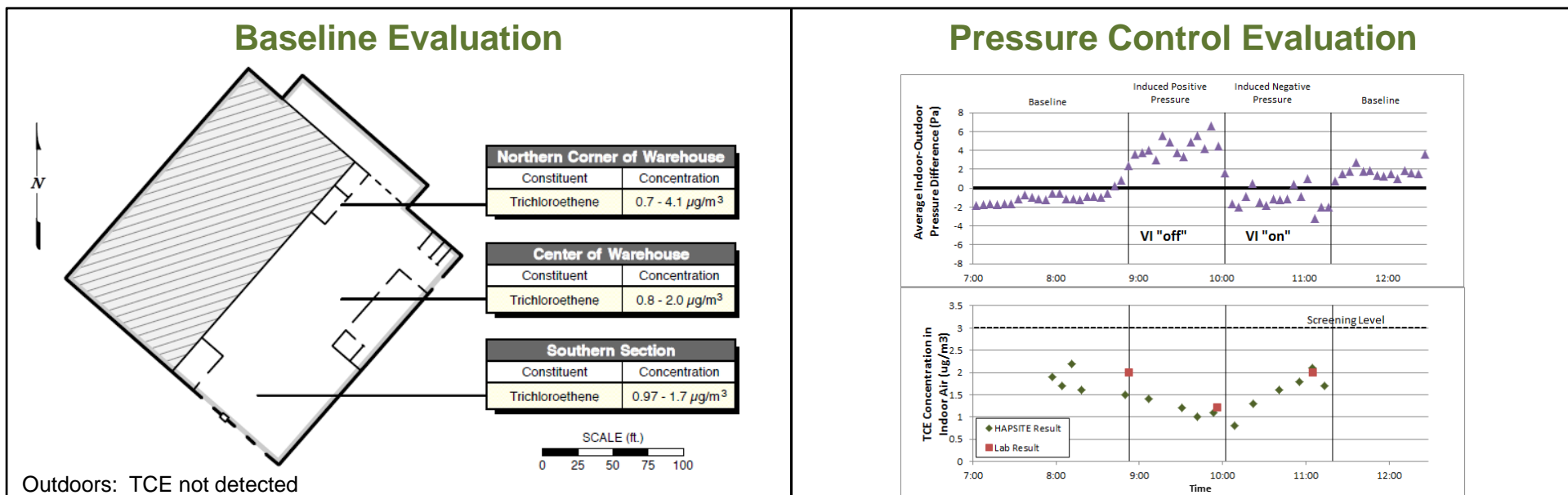

### Data Interpretation

Line of Evidence (Baseline)	Consistent with VI?
• Indoor air concentration > outdoor air?	<b>Yes</b>
• No indoor sources?	<b>Yes</b>
• Baseline building pressure negative?	<b>Yes</b>
• Vapor entry point found?	<b>No</b>
<b>Baseline Finding: Supporting evidence of current VI</b>	

Line of Evidence (Pressure Control)	Consistent with VI?
• Target VOC conc suppressed by building pressurization?	<b>Yes</b>
• Target VOC conc enhanced by depressurization?	<b>Yes</b>
<b>Pressure Control Finding: Evidence of VI</b>	

**OVERALL FINDING:** Evidence of current vapor intrusion

**IMPLICATION:** Indoor air conc (2  $\mu\text{g}/\text{m}^3$ ) is BELOW USEPA screening level (3  $\mu\text{g}/\text{m}^3$ ). Pressure control evaluation increases confidence in result, and decreases concern with temporal variability.

Notes: 1) See Section 5.7.3 for decision logic. 2) See Table C.1.3 and C.1.4 for on-site analysis protocol results.

## FIGURE B.2.1: RESULTS FROM CONVENTIONAL VAPOR INTRUSION PROGRAM

ESTCP Project ER-201119, Use of On-Site GC/MS Analysis to Distinguish between VI and Indoor Sources of VOCs

### Site Data: Lewis-McChord Building 9674, Washington

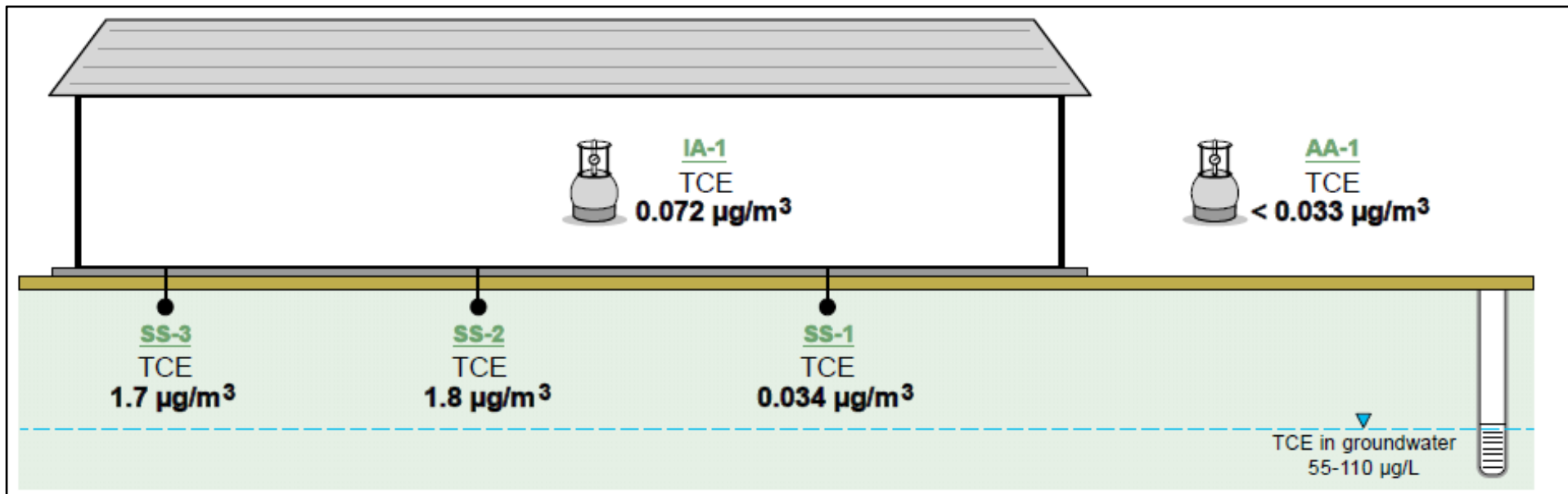

### Data Interpretation

Line of Evidence	Consistent with VI?	Comment
• Indoor air concentration > outdoor air?	<b>Yes</b>	Also consistent with potential indoor source
• Sub-slab >10x indoor air concentration?	<b>Yes</b>	At 2 of 3 sub-slab points
• Sub-slab to indoor air concentration ratios consistent with VI?	<b>Yes</b>	TCE, PCE are highest VOCs in sub-slab and are also detected in indoor air
• Concentration ratios consistent with groundwater (GW) source?	<b>Inconclusive</b>	In GW, c12DCE is approx 2% of TCE conc; c12DCE not detected in sub-slab or indoor air, but may not have been detectable because of low conc in GW source; PCE not detected in GW.

**FINDING:** Supporting evidence of current vapor intrusion

**IMPLICATION:** No concern due to very low TCE conc. Indoor air TCE concentration is approximately 2% of the USEPA screening level (3 ug/m3).

## FIGURE B.2.2: RESULTS FROM CSIA PROTOCOL

ESTCP Project ER-201119, Use of On-Site GC/MS Analysis to Distinguish between VI and Indoor Sources of VOCs

**Site Data:** Lewis-McChord Building 9674, Washington

### Indoor Air vs. Groundwater Isotope Signatures

Not Tested because of  
Low TCE Concentration in Indoor Air

### Data Interpretation

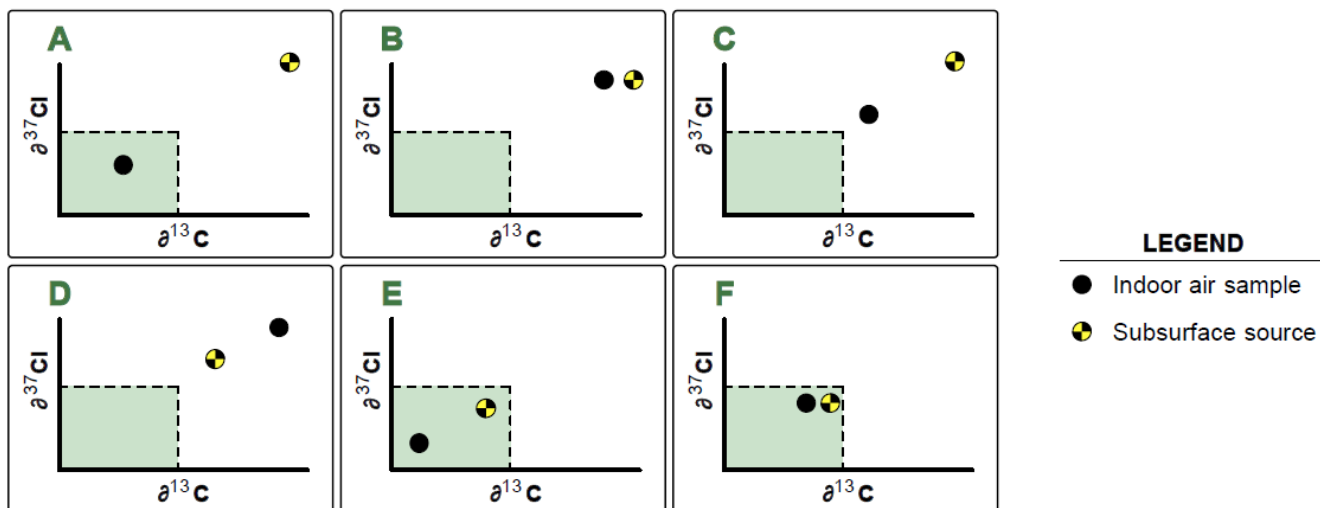

**FINDING:** N/A

### FIGURE B.2.3: RESULTS FROM ON-SITE ANALYSIS PROTOCOL

ESTCP Project ER-201119, Use of On-Site GC/MS Analysis to Distinguish between VI and Indoor Sources of VOCs

#### Site Data: Lewis-McChord Building 9674, Washington

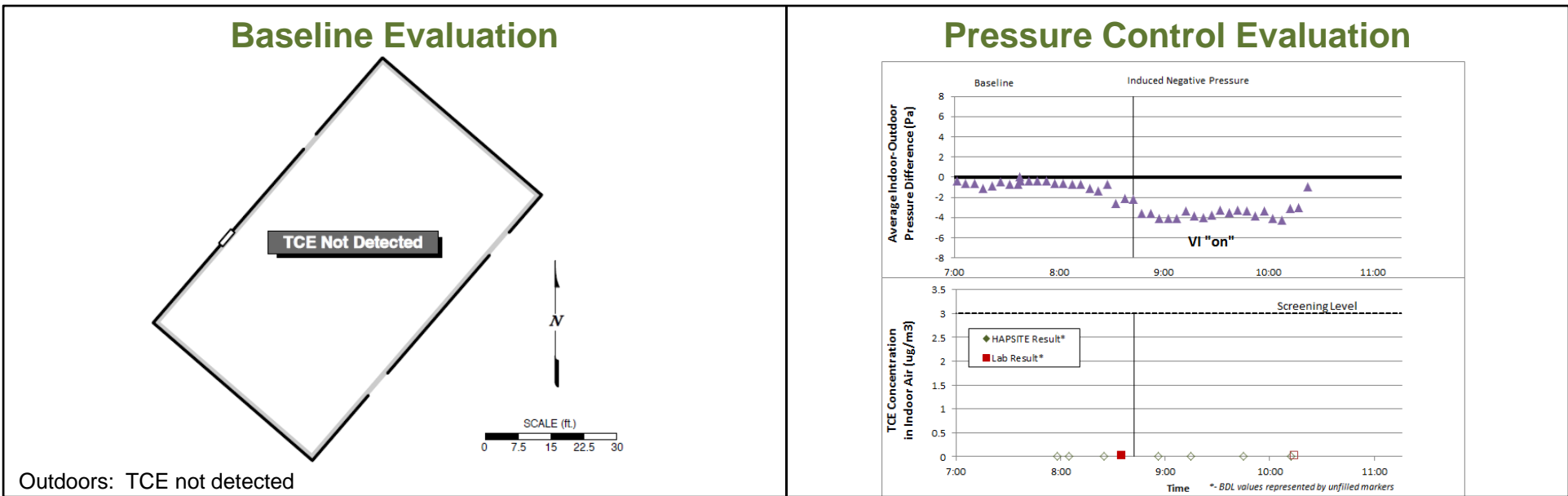

#### Data Interpretation

Line of Evidence (Baseline)	Consistent with VI?
• Indoor air concentration > outdoor air?	<b>No</b>
• No indoor sources?	<b>n/a</b>
• Baseline building pressure negative?	<b>Yes</b>
• Vapor entry point found?	<b>No</b>
<b>Baseline Finding: No evidence of current VI</b>	

Line of Evidence (Pressure Control)	Consistent with VI?
• Target VOC conc suppressed by building pressurization?	<b>Not tested</b>
• Target VOC conc enhanced by depressurization?	<b>No</b>
<b>Pressure Control Finding: No evidence of potential VI</b>	

**OVERALL FINDING:** No evidence of current/potential vapor intrusion

**IMPLICATION:** No concern due to very low TCE conc. TCE concentrations (confirmation samples) at or below detection limit (i.e., 1% of USEPA screening level)

Notes: 1) See Section 5.7.3 for decision logic. 2) See Table C.1.3 and C.1.4 for on-site analysis protocol results.



### FIGURE B.3.1: RESULTS FROM CONVENTIONAL VAPOR INTRUSION PROGRAM

ESTCP Project ER-201119, Use of On-Site GC/MS Analysis to Distinguish between VI and Indoor Sources of VOCs

#### Site Data: Selfridge Building 1533, Michigan

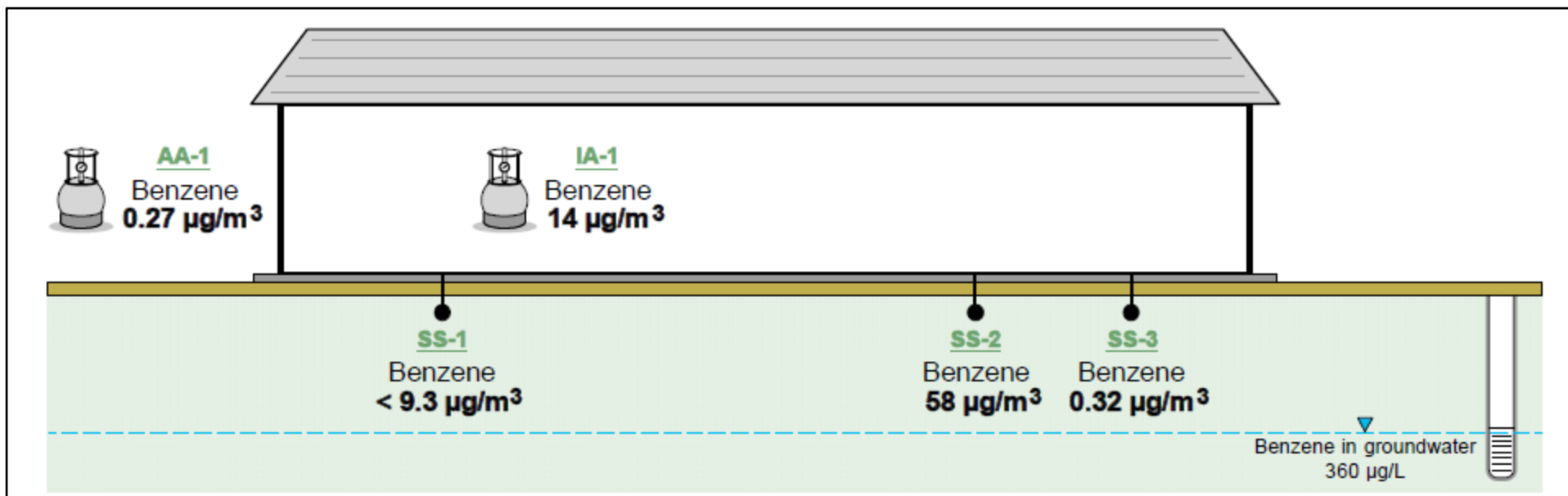

#### Data Interpretation

Line of Evidence	Consistent with VI?	Comment
• Indoor air concentration > outdoor air?	<b>Yes</b>	Also consistent with identified indoor source (e.g., automobiles being services inside building)
• Sub-slab >10x indoor air concentration?	<b>No</b>	
• Sub-slab to indoor air concentration ratios consistent with VI?	<b>Inconclusive</b>	Elevated detection limits in indoor air prevent meaningful comparisons
• Concentration ratios consistent with groundwater (GW) source?	<b>Inconclusive</b>	In GW, benzene is approx 25% of the ethylbenzene concentration. In sub-slab, ratios vary between sample points. In indoor air, ethylbenzene not detected (<57 ug/m3).

**FINDING:** Inconclusive, can't distinguish between VI and indoor sources.

**IMPLICATION:** Indoor benzene concentration greater than USEPA screening level (1.6 ug/m3).  
Further study needed to determine source.

### FIGURE B.3.2: RESULTS FROM CSIA PROTOCOL

ESTCP Project ER-201119, Use of On-Site GC/MS Analysis to Distinguish between VI and Indoor Sources of VOCs

#### Site Data: Selfridge Building 1533, Michigan

#### Indoor Air vs. Groundwater Isotope Signatures

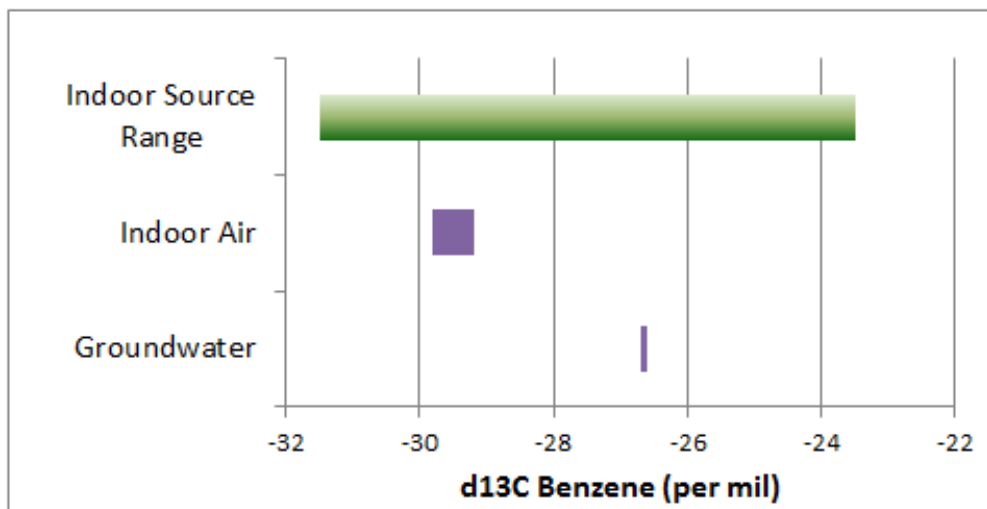

#### Data Interpretation

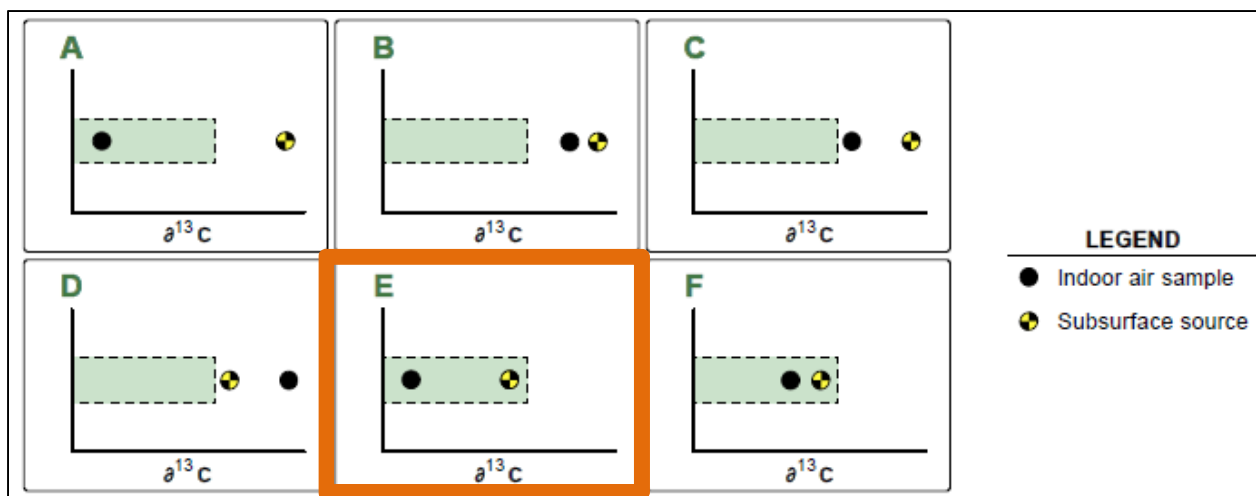

**FINDING:** Supporting evidence of no current vapor intrusion

Notes: 1) See Section 5.7.2 for decision logic. 2) See Table C.2.2 for CSIA sample results.

### FIGURE B.3.3: RESULTS FROM ON-SITE ANALYSIS PROTOCOL

ESTCP Project ER-201119, Use of On-Site GC/MS Analysis to Distinguish between VI and Indoor Sources of VOCs

#### Site Data: Selfridge Building 1533, Michigan

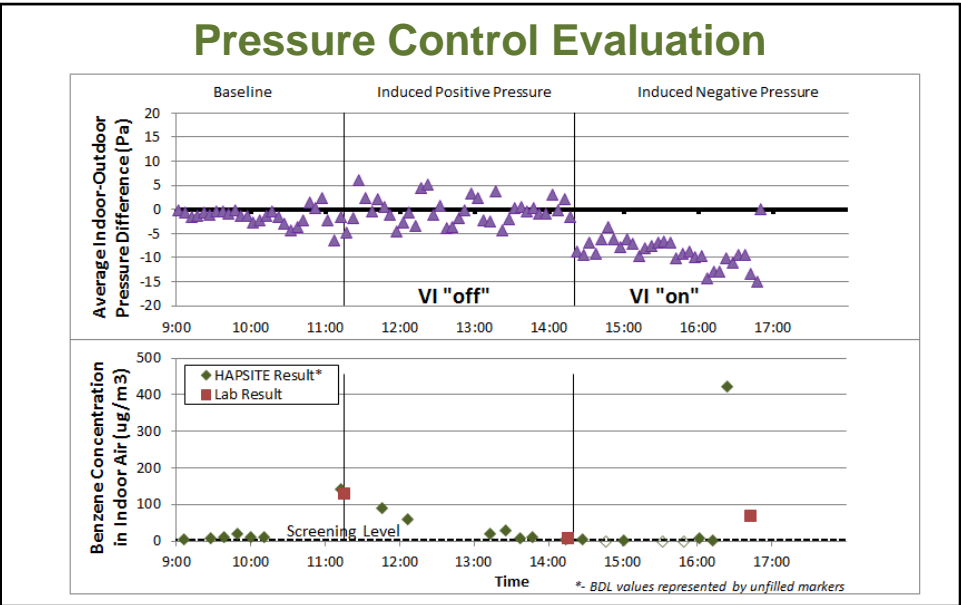
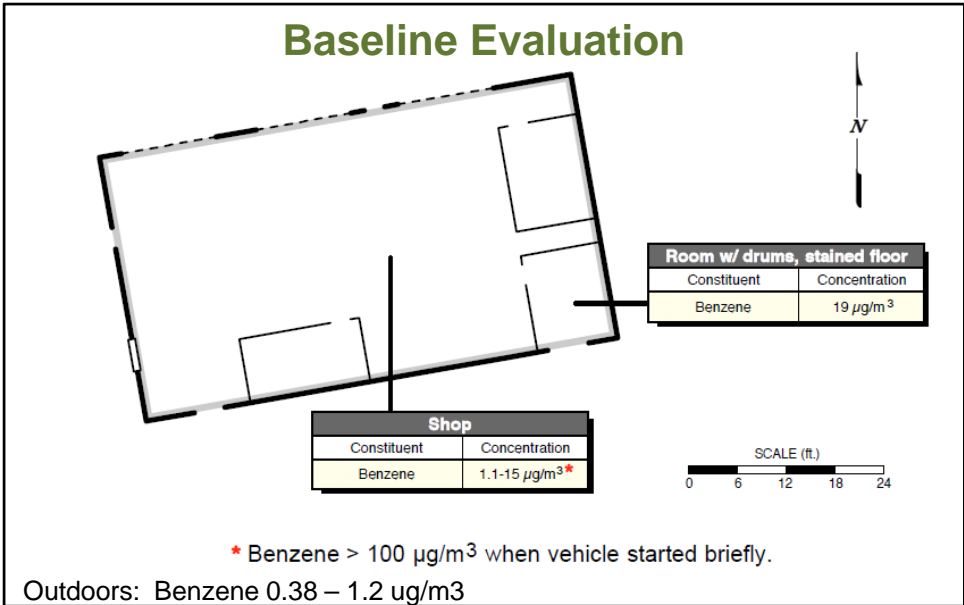

#### Data Interpretation

Line of Evidence (Baseline)	Consistent with VI?
• Indoor air concentration > outdoor air?	Yes
• No indoor sources?	No (Sources found and could not be removed from building)
• Baseline building pressure negative?	Yes
• Vapor entry point found?	No
Baseline Finding: <b>Supporting evidence of no current VI</b>	

Line of Evidence (Pressure Control)	Consistent with VI?
• Target VOC conc suppressed by building pressurization?	No
• Target VOC conc enhanced by depressurization?	No
Pressure Control Finding: <b>No evidence of potential VI</b>	

**OVERALL FINDING:** No evidence of current/potential vapor intrusion

**IMPLICATION:** Primary sources of benzene are indoors. Indoor air benzene concentration greater than USEPA screening level due to indoor sources. No additional evaluation warranted under current building use.

Notes: 1) See Section 5.7.3 for decision logic. 2) See Table C.2.3 and C.2.4 for on-site analysis protocol results.

## FIGURE B.4.1: RESULTS FROM CONVENTIONAL VAPOR INTRUSION PROGRAM

ESTCP Project ER-201119, Use of On-Site GC/MS Analysis to Distinguish between VI and Indoor Sources of VOCs

### Site Data: Tyndall Building 156, Florida

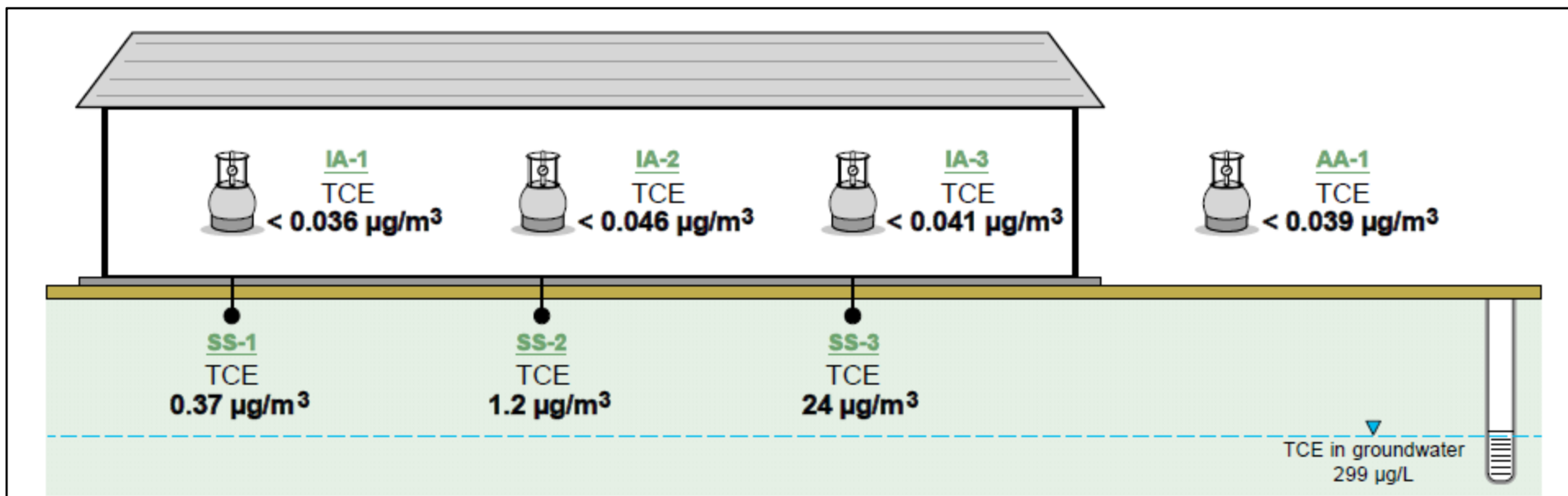

### Data Interpretation

Line of Evidence	Consistent with VI?	Comment
• Indoor air concentration > outdoor air?	No	
• Sub-slab >10x indoor air concentration?	Yes	
• Sub-slab to indoor air concentration ratios consistent with VI?	Inconclusive	TCE detected in sub-slab, but not in indoor air. PCE detected in sub-slab and indoor air. SS-3 location has highest concentrations (and is closest to GW source).
• Concentration ratios consistent with groundwater (GW) source?	No	In GW, c12DCE conc is approx 10% of TCE conc, but PCE is not detected. In indoor air, cis12DCE and TCE not detected, but PCE was detected.

**FINDING:** Supporting evidence of no current vapor intrusion

**IMPLICATION:** No vapor intrusion concern. The key target VOC (TCE) not detected, with detection limits approx 1% of USEPA screening level.

### FIGURE B.4.2: RESULTS FROM CSIA PROTOCOL

ESTCP Project ER-201119, Use of On-Site GC/MS Analysis to Distinguish between VI and Indoor Sources of VOCs

**Site Data:** Tyndall Building 156, Florida

#### Indoor Air vs. Groundwater Isotope Signatures

Not Tested because of  
Low TCE Concentration in Indoor Air

#### Data Interpretation

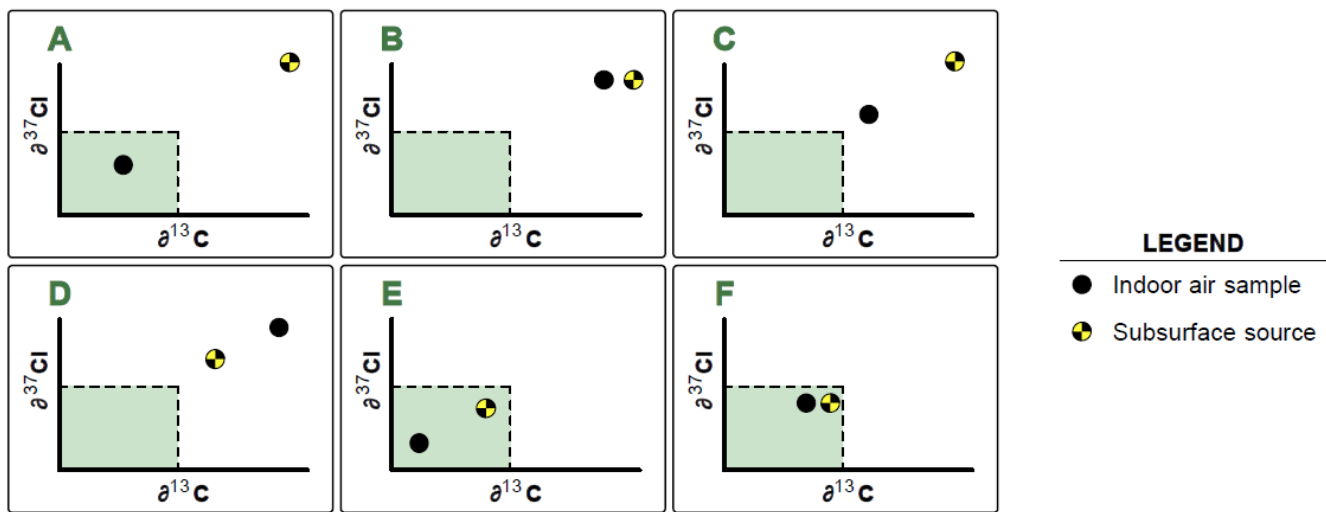

**FINDING:** N/A

Notes: 1) See Section 5.7.2 for decision logic.

### FIGURE B.4.3: RESULTS FROM ON-SITE ANALYSIS PROTOCOL

ESTCP Project ER-201119, Use of On-Site GC/MS Analysis to Distinguish between VI and Indoor Sources of VOCs

#### Site Data: Tyndall Building 156, Florida

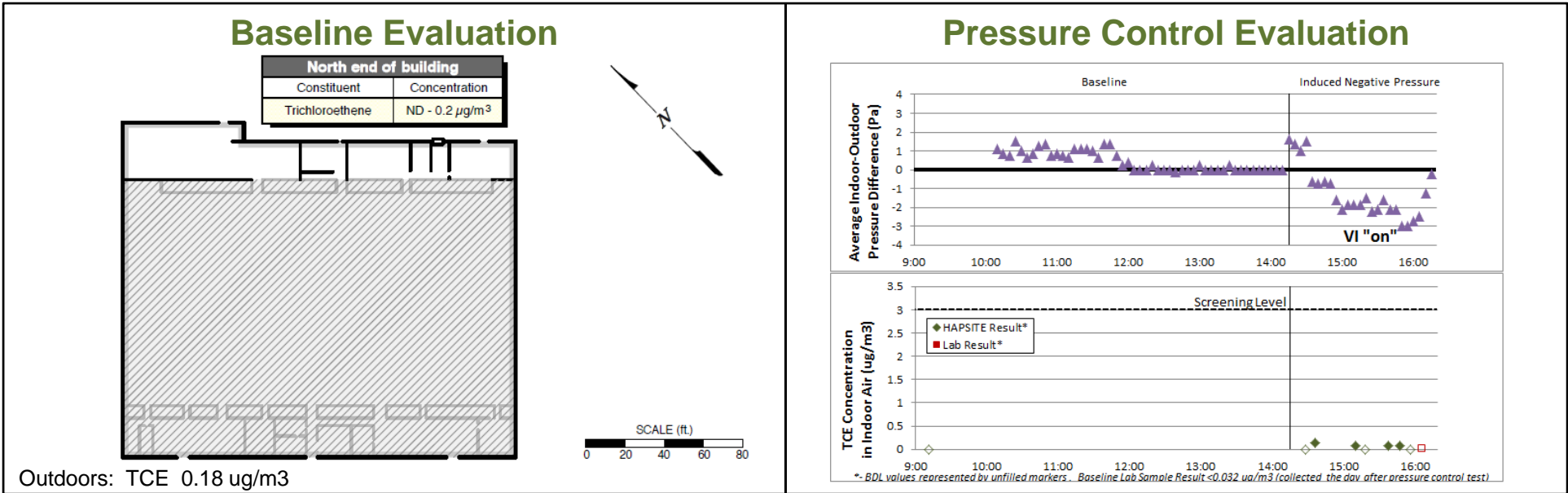

#### Data Interpretation

Line of Evidence (Baseline)	Consistent with VI?
• Indoor air concentration > outdoor air?	No
• No indoor sources?	n/a
• Baseline building pressure negative?	No
• Vapor entry point found?	No
<b>Baseline Finding: No evidence of current VI</b>	

Line of Evidence (Pressure Control)	Consistent with VI?
• Target VOC conc suppressed by building pressurization?	No
• Target VOC conc enhanced by depressurization?	No
<b>Pressure Control Finding: No evidence of potential VI</b>	

**OVERALL FINDING:** No evidence of current/potential vapor intrusion  
**IMPLICATION:** No vapor intrusion concern. Baseline and depressurized confirmation sample TCE result below detection limit (1% of USEPA screening level).

Notes: 1) See Section 5.7.3 for decision logic. 2) See Table C.3.3 and C.3.4 for on-site analysis protocol results.

## FIGURE B.5.1: RESULTS FROM CONVENTIONAL VAPOR INTRUSION PROGRAM

ESTCP Project ER-201119, Use of On-Site GC/MS Analysis to Distinguish between VI and Indoor Sources of VOCs

### Site Data: Tyndall Building 219, Florida

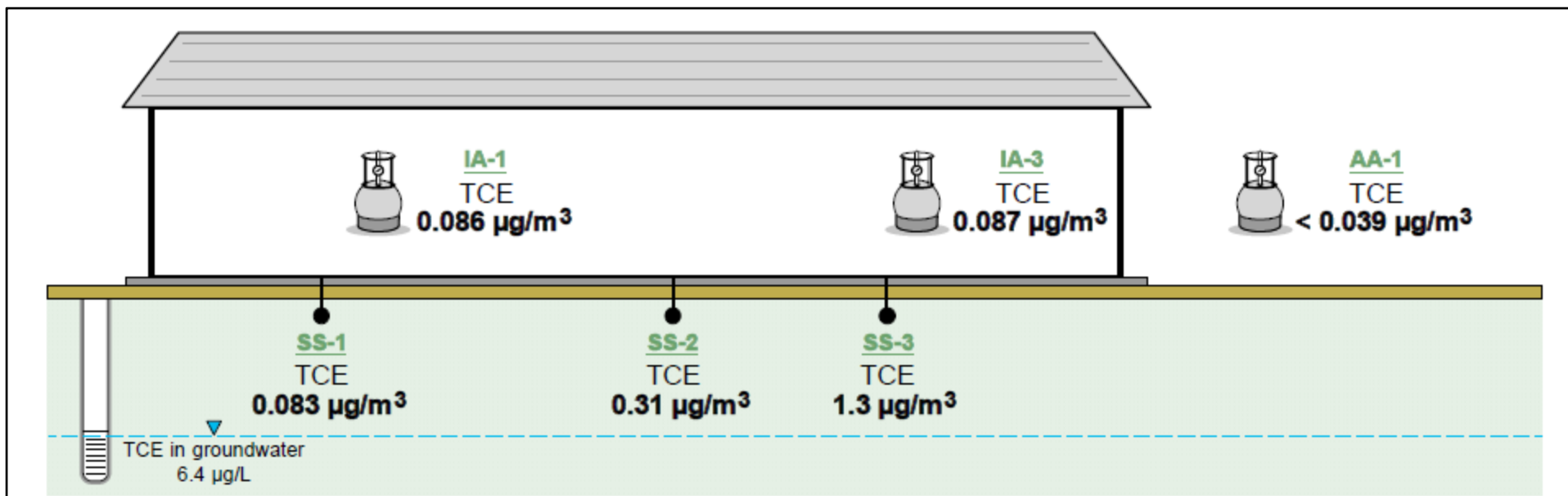

### Data Interpretation

Line of Evidence	Consistent with VI?	Comment
• Indoor air concentration > outdoor air?	<b>Yes</b>	Also consistent with potential indoor source.
• Sub-slab >10x indoor air concentration?	<b>Inconclusive</b>	Greater than 10x at 1 of 3, but average sub-slab concentration is less than 10x indoor air concentration.
• Sub-slab to indoor air concentration ratios consistent with VI?	<b>Inconclusive</b>	TCE, PCE detected in sub-slab; TCE and PCE detected in indoor air. Ratios and distribution are not consistent.
• Concentration ratios consistent with groundwater (GW) source?	<b>No</b>	In GW, c12DCE is much greater than TCE (c12DCE 2,200 ug/L vs. TCE 6.4 ug/L). c12DCE not detected in sub-slab or indoor air.

**FINDING:** Inconclusive. Source of TCE in indoor air not clear, however, TCE conc is very low.

**IMPLICATION:** No concern due to low TCE conc. The key target VOC (TCE) found at approx 3% of the USEPA screening level (3 ug/m3).

## FIGURE B.5.2: RESULTS FROM CSIA PROTOCOL

ESTCP Project ER-201119, Use of On-Site GC/MS Analysis to Distinguish between VI and Indoor Sources of VOCs

**Site Data:** Tyndall Building 219, Florida

### Indoor Air vs. Groundwater Isotope Signatures

Not Tested because of  
Low TCE Concentration in Indoor Air

### Data Interpretation

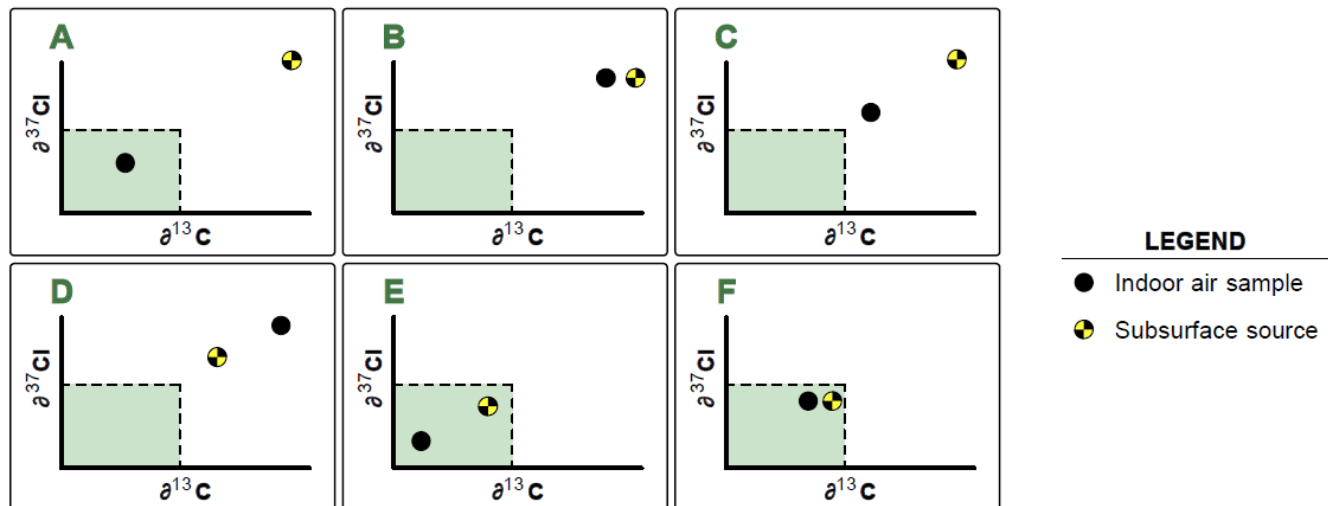

**FINDING:** N/A



### FIGURE B.5.3: RESULTS FROM ON-SITE ANALYSIS PROTOCOL

ESTCP Project ER-201119, Use of On-Site GC/MS Analysis to Distinguish between VI and Indoor Sources of VOCs

#### Site Data: Tyndall Building 219, Florida

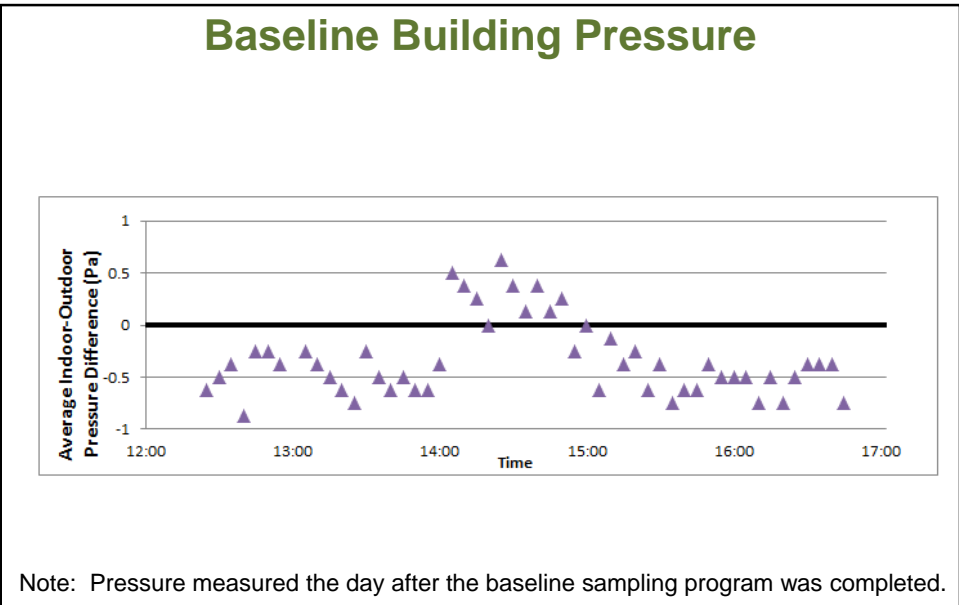
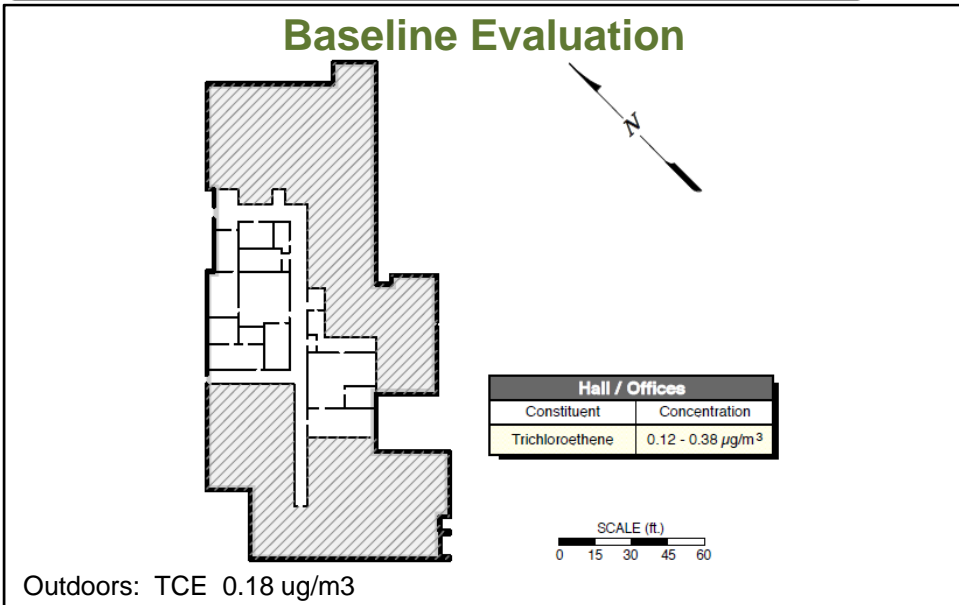

#### Data Interpretation

Line of Evidence (Baseline)	Consistent with VI?
• Indoor air concentration > outdoor air?	<b>Yes</b>
• No indoor sources?	<b>Yes</b>
• Baseline building pressure negative?	<b>Yes</b>
• Vapor entry point found?	<b>No</b>
<b>Baseline Finding: Inconclusive (No access to some parts of building)</b>	

Line of Evidence (Pressure Control)	Consistent with VI?
• Target VOC conc suppressed by building pressurization?	<b>Not tested</b>
• Target VOC conc enhanced by depressurization?	<b>Not tested</b>
<b>Pressure Control Finding: N/A</b>	

**OVERALL FINDING:** Inconclusive. Source of TCE in indoor air not clear, however, TCE conc is very low.

**IMPLICATION:** No concern due to low TCE conc. The key target VOC (TCE) less than 10% of the USEPA screening level (3 ug/m3). TCE concentration was very low despite negative baseline building pressure (favorable for vapor intrusion), reducing concern regarding temporal variability.

Notes: 1) See Section 5.7.3 for decision logic. 2) See Table C.3.3 and C.3.4 for on-site analysis protocol results.

## FIGURE B.6.1: RESULTS FROM CONVENTIONAL VAPOR INTRUSION PROGRAM

ESTCP Project ER-201119, Use of On-Site GC/MS Analysis to Distinguish between VI and Indoor Sources of VOCs

### Site Data: Raritan Building CP4, New Jersey

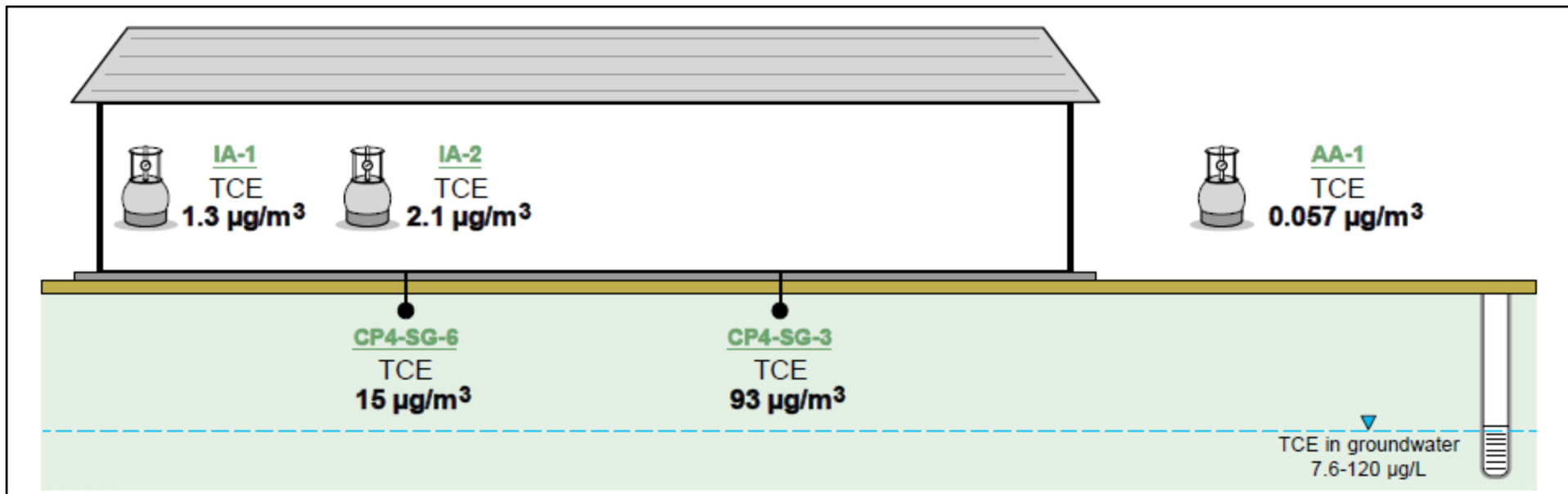

### Data Interpretation

Line of Evidence	Consistent with VI?	Comment
• Indoor air concentration > outdoor air?	<b>Yes</b>	Also consistent with potential indoor source.
• Sub-slab >10x indoor air concentration?	<b>Yes</b>	
• Sub-slab to indoor air concentration ratios consistent with VI?	<b>Yes</b>	TCE, PCE found at highest concentrations in sub-slab; also detected in indoor air. Ratios similar.
• Concentration ratios consistent with groundwater (GW) source?	<b>Inconclusive</b>	In GW, c12DCE is 20-75% of the TCE conc. In sub-slab, c12DCE is <1% of the TCE conc. c12DCE not detected in indoor air.

**FINDING:** Supporting evidence of current vapor intrusion

**IMPLICATION:** Indoor air TCE concentration is within 50% of USEPA screening level ( $3 \mu\text{g}/\text{m}^3$ ).  
Monitoring may be needed to characterize temporal variability.

### FIGURE B.6.2: RESULTS FROM CSIA PROTOCOL

ESTCP Project ER-201119, Use of On-Site GC/MS Analysis to Distinguish between VI and Indoor Sources of VOCs

#### Site Data: Raritan Building CP4, New Jersey

#### Indoor Air vs. Groundwater Isotope Signatures

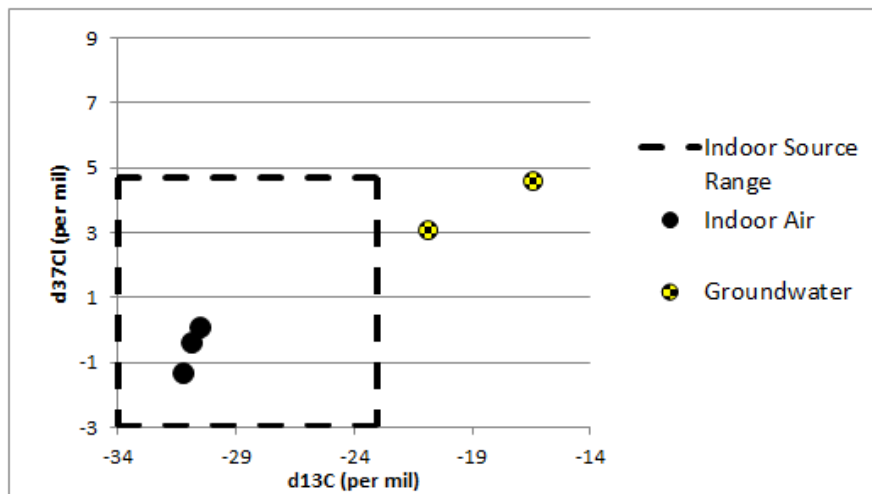

#### Data Interpretation

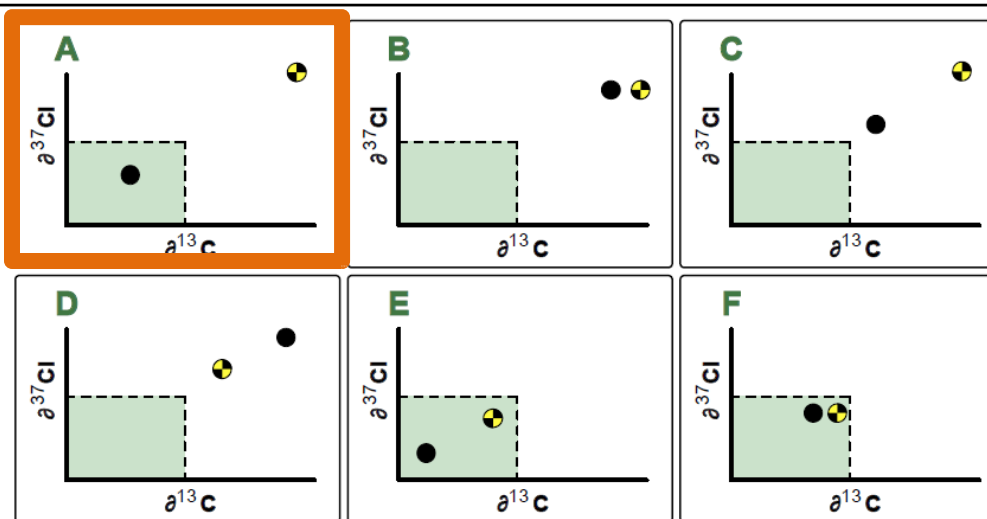

- LEGEND**
- Indoor air sample
  - Subsurface source

**FINDING:** Strong evidence of indoor source, not vapor intrusion

Notes: 1) See Section 5.7.2 for decision logic. 2) See Table C.4.2 for CSIA sample results.

**FIGURE B.6.3: RESULTS FROM ON-SITE ANALYSIS PROTOCOL**

ESTCP Project ER-201119, Use of On-Site GC/MS Analysis to Distinguish between VI and Indoor Sources of VOCs

**Site Data: Raritan Building CP4, New Jersey**

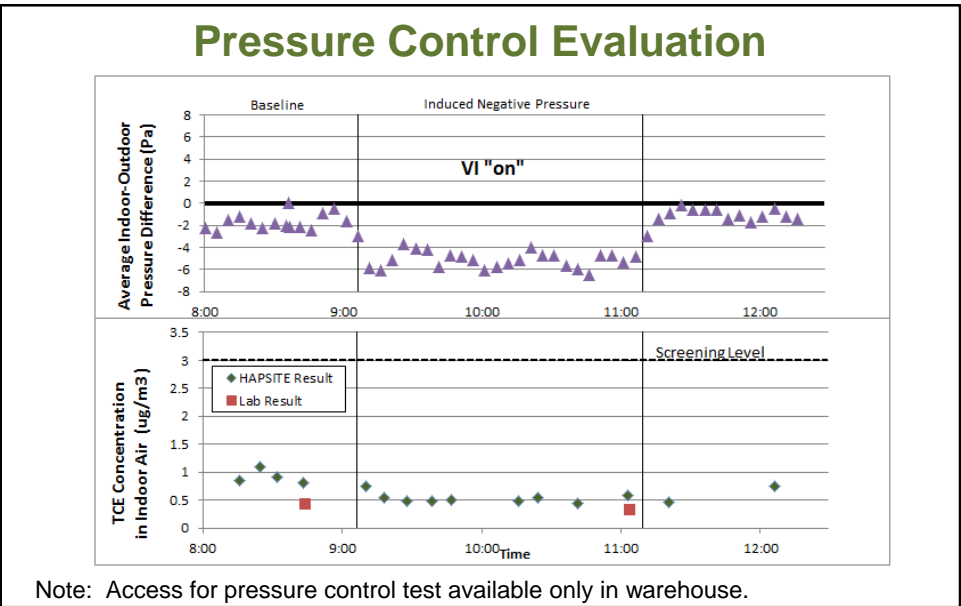
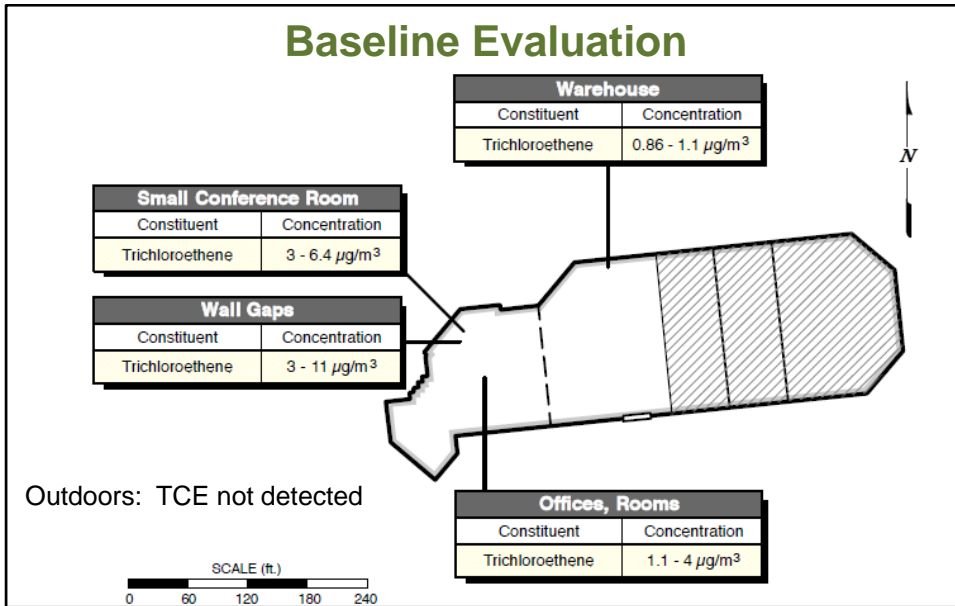

**Data Interpretation**

Line of Evidence (Baseline)	Consistent with VI?
• Indoor air concentration > outdoor air?	<b>Yes</b>
• No indoor sources?	<b>Yes</b>
• Baseline building pressure negative?	<b>Yes</b>
• Vapor entry point found?	<b>Inconclusive (conf room wall gap conc. 2-3x higher than indoor air; one warehouse expansion joint 5x higher than indoor air)</b>
<b>Baseline Finding: Supporting evidence of current VI</b>	

Line of Evidence (Pressure Control)	Consistent with VI?
• Target VOC conc suppressed by building pressurization?	<b>Not tested</b>
• Target VOC conc enhanced by depressurization?	<b>No</b>
<b>Pressure Control Finding: Pressure variation does not enhance VI (warehouse)</b>	

**OVERALL FINDING:** Office Area: Supporting evidence of VI. Warehouse: Suggestive of VI.

**IMPLICATION:** Indoor air conc (0.43 µg/m<sup>3</sup> in warehouse) is BELOW USEPA screening level (3 µg/m<sup>3</sup>). Controlled depressurization did not enhance vapor intrusion reducing concern regarding temporal variability.

Notes: 1) See Section 5.7.3 for decision logic. 2) See Table C.4.3 and C.4.4 for on-site analysis protocol results.

## FIGURE B.7.1: RESULTS FROM CONVENTIONAL VAPOR INTRUSION PROGRAM

ESTCP Project ER-201119, Use of On-Site GC/MS Analysis to Distinguish between VI and Indoor Sources of VOCs

### Site Data: Raritan Building 209, New Jersey

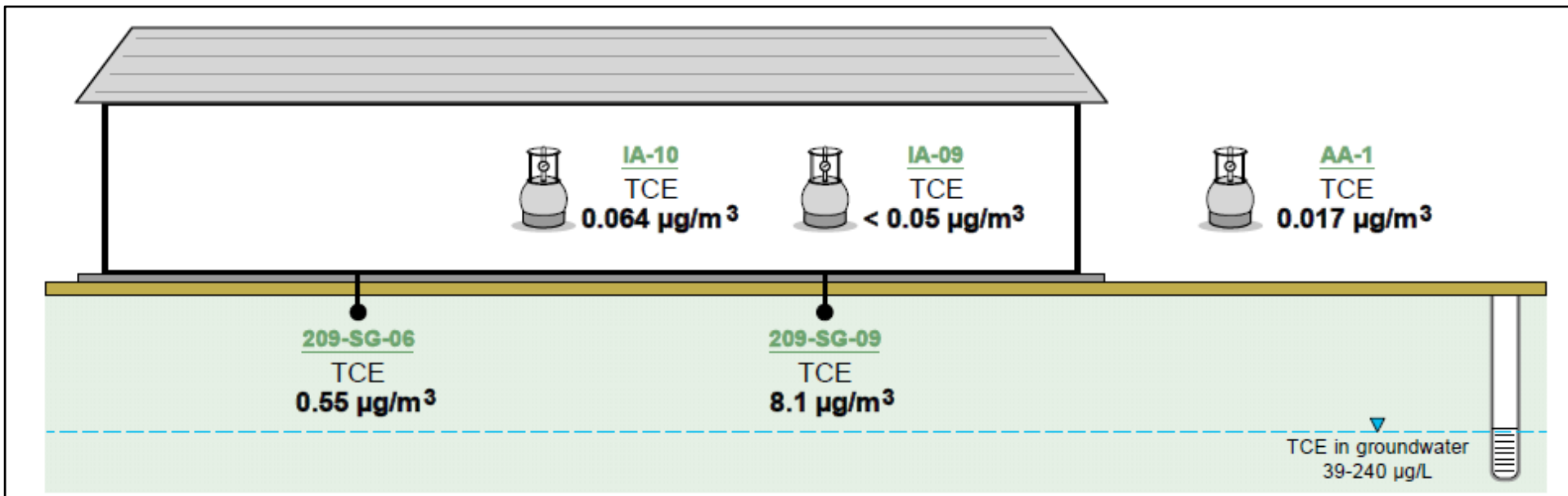

### Data Interpretation

Line of Evidence	Consistent with VI?	Comment
• Indoor air concentration > outdoor air?	<b>Yes</b>	Also consistent with potential indoor source.
• Sub-slab >10x indoor air concentration?	<b>Yes</b>	
• Sub-slab to indoor air concentration ratios consistent with VI?	<b>Yes</b>	TCE, PCE found at highest concentrations in sub-slab; also detected in indoor air.
• Concentration ratios consistent with groundwater (GW) source?	<b>Inconclusive</b>	In GW, c12DCE is less than 2% of TCE concentration. c12DCE not detected in sub-slab or indoor air, but may not have been detectable because of low concentration in GW source.

**FINDING:** Supporting evidence of current vapor intrusion

**IMPLICATION:** No vapor intrusion concern. Indoor air TCE concentration approx 2% of the USEPA screening level (3 ug/m3).

Notes: 1) Building schematic is not to scale. 2) See Section 5.7.1 for decision logic. 3) See Table C.4.1 for all conventional program results.

### FIGURE B.7.2: RESULTS FROM CSIA PROTOCOL

ESTCP Project ER-201119, Use of On-Site GC/MS Analysis to Distinguish between VI and Indoor Sources of VOCs

**Site Data:** Raritan Building 209, New Jersey

#### Indoor Air vs. Groundwater Isotope Signatures

Not Tested because of  
Low TCE Concentration in Indoor Air

#### Data Interpretation

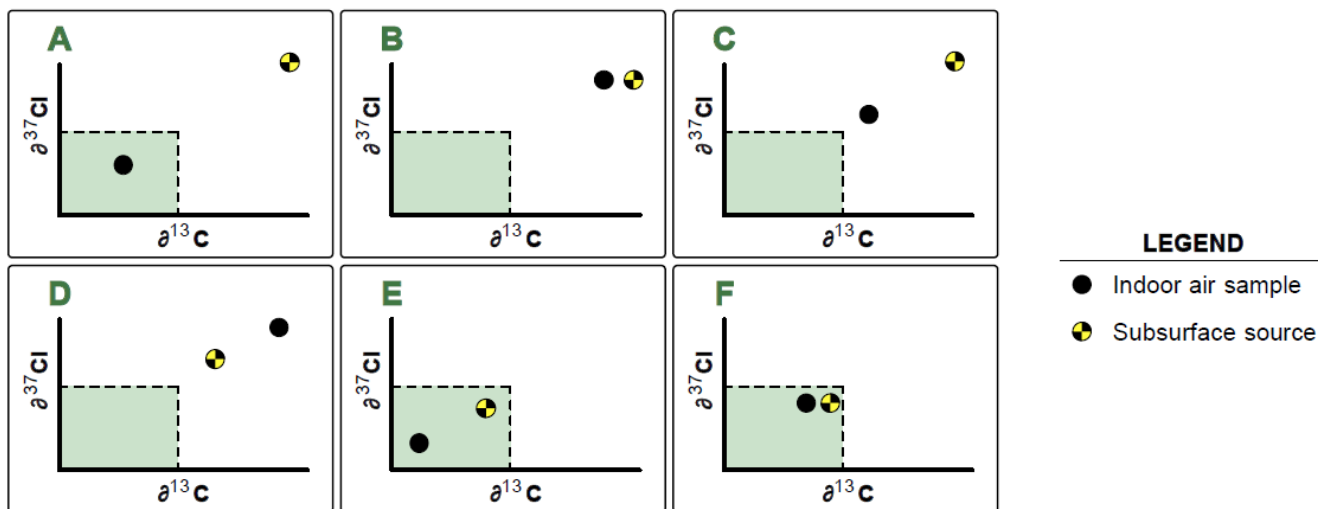

**FINDING:** N/A

### FIGURE B.7.3: RESULTS FROM ON-SITE ANALYSIS PROTOCOL

ESTCP Project ER-201119, Use of On-Site GC/MS Analysis to Distinguish between VI and Indoor Sources of VOCs

#### Site Data: Raritan Building 209, New Jersey

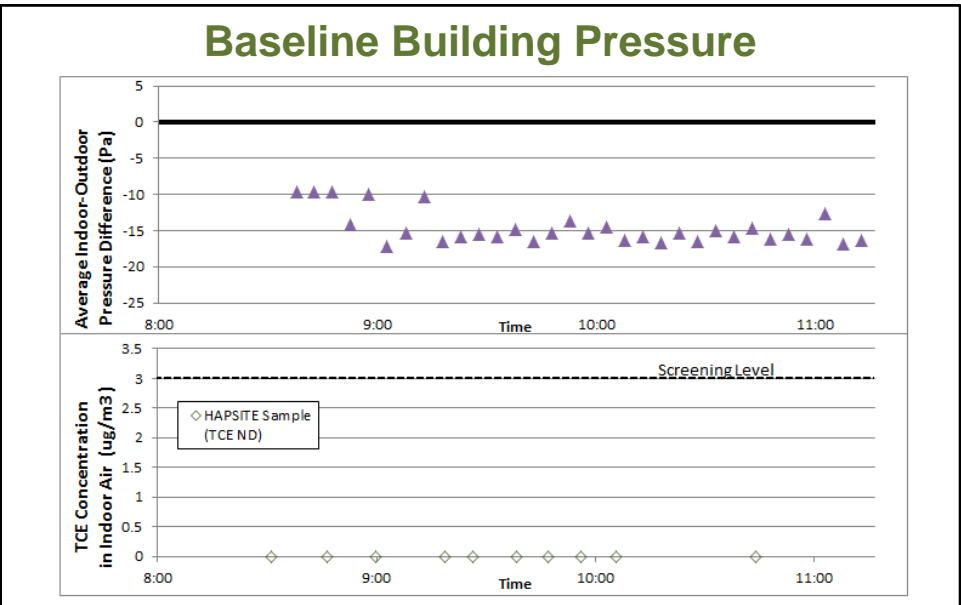
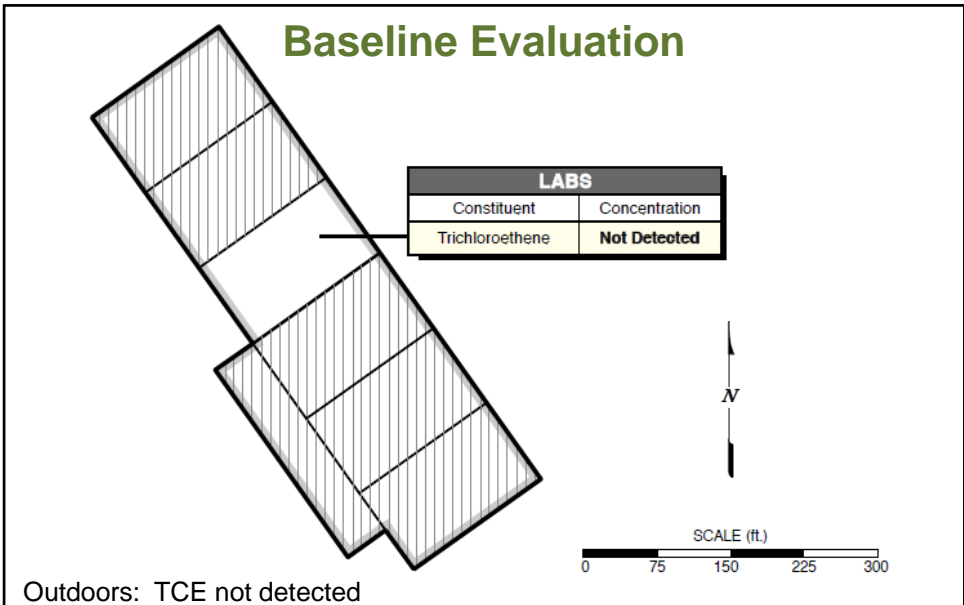

#### Data Interpretation

Line of Evidence (Baseline)	Consistent with VI?
• Indoor air concentration > outdoor air?	<b>No</b>
• No indoor sources?	<b>n/a</b>
• Baseline building pressure negative?	<b>Yes</b>
• Vapor entry point found?	<b>No</b>
<b>Baseline Finding: No evidence of current VI</b>	

Line of Evidence (Pressure Control)	Consistent with VI?
• Target VOC conc suppressed by building pressurization?	<b>Not tested</b>
• Target VOC conc enhanced by depressurization?	<b>Not tested</b>
<b>Pressure Control Finding: N/A</b>	

**OVERALL FINDING:** No evidence of current VI.

**IMPLICATION:** No vapor intrusion concern. TCE conc well below USEPA screening level (3 ug/m3). TCE conc was very low despite strong negative baseline building pressure (created by operation of lab fume hoods), reducing concern regarding temporal variability.

Notes: 1) See Section 5.7.3 for decision logic. 2) See Table C.4.3 and C.4.4 for on-site analysis protocol results. 3) Building is depressurized under normal conditions from operation of fume hoods.

# **Appendix C: Results from Individual Demonstration Sites**

---

## **Use of On-Site GC/MS Analysis to Distinguish between Vapor Intrusion and Indoor Sources of VOCs**

- Appendix C.1: Joint Base Lewis-McChord, Washington
- Appendix C.2: Selfridge Air National Guard Base, Michigan
- Appendix C.3: Tyndall Air Force Base, Florida
- Appendix C.4: Former Raritan Arsenal Site, New Jersey



# Appendix C.1: Joint Base Lewis-McChord, Washington

## **TABLES**

---

Table C.1.1	Results from Conventional Vapor Intrusion Program
Table C.1.2	Results from Isotope Program
Table C.1.3	Results from On-Site Analysis Program Confirmation Samples
Table C.1.4	Results from On-Site GC/MS Analysis

## **FIGURES**

---

Figure C.1.1	Site Map
Figure C.1.2	Building 9669 Floorplan
Figure C.1.3	Building 9674 Floorplan

**TABLE C.1.1: RESULTS FROM CONVENTIONAL VAPOR INTRUSION PROGRAM**  
**ESTCP Project ER-201119**  
**Joint Base Lewis-McChord, Washington**

Location ID: Field Sample ID: Sample Location ID: Description:	GROUNDWATER		
	LC-18 (Note 4)	LC-48 (Note 4)	MT-1 (Note 4)
Matrix:	GW	GW	GW
Sample Type:	N	N	N
Sample Collection Date:	6/21/2012	6/21/2012	5/30/2012
Analytical Method (units):	8260 (ug/L)	8260 (ug/L)	8260 (ug/L)
<b>Key Analyte for VI Evaluation</b>			
Trichloroethene (TCE)	<b>55</b>	<b>110 H</b>	<b>96</b>
<b>Other Reported Compounds</b>			
Dichloroethane, 1,2-	-	-	-
Dichloroethene, 1,1- (1,1-DCE)	-	-	-
Dichloroethene, cis-1,2-	<b>0.73</b>	<b>2.1</b>	<b>1.4</b>
Dichloroethene, trans-1,2-	-	-	-
Tetrachloroethene (PCE)	<0.5	<0.5	<0.5
Trichloroethane, 1,1,1- (TCA)	<0.5	<0.5	<0.5
Vinyl chloride (VC)	<0.5	<0.5	<0.5

Notes:

- Vapor samples analyzed by ALS/Columbia Analytical Services, Simi Valley, CA.
- Sub-slab soil gas collected as grab samples (without flow controller). Indoor and outdoor air samples collected with 8-hour flow controller.
- Bold font = detected result; Less-than symbol ("<") = analyte not found at indicated limit; Dash ("-") indicates compound not analyzed.
- Results from May/June 2012 groundwater monitoring event, provided by base personnel. VOC analysis of groundwater samples was not conducted as part of the ESTCP VI Study.

**TABLE C.1.1: RESULTS FROM CONVENTIONAL VAPOR INTRUSION PROGRAM**  
**ESTCP Project ER-201119**  
**Joint Base Lewis-McChord, Washington**

Location ID:	BUILDING 9669					
Field Sample ID:	1-SS-1-CON	1-SS-2-CON	1-SS-3-CON	1-IA-1-CON	1-IA-2-CON	1-AA-1-CON
Sample Location ID:	1-SS-1	1-SS-2	1-SS-3	1-IA-1	1-IA-2	1-AA-1
Description:	Sub-slab, front, near battery recycling area	Sub-slab, middle, near 1-IA-1	Sub-slab, back of building	Indoor air, center of warehouse	Indoor air, shelf in product storage area	Outdoors
Matrix:	SS	SS	SS	IA	IA	AA
Sample Type:	N	N	N	N	N	N
Sample Collection Date:	7/24/2012 10:46	7/24/2012 11:06	7/24/2012 11:27	7/24/2012 15:57	7/24/2012 15:58	7/24/2012 16:00
Analytical Method (units):	TO-15 SIM (ug/m3)	TO-15 SIM (ug/m3)	TO-15 SIM (ug/m3)	TO-15 SIM (ug/m3)	TO-15 SIM (ug/m3)	TO-15 SIM (ug/m3)
<b>Key Analyte for VI Evaluation</b>						
Trichloroethene (TCE)	43	320	1.5	1.5	1.2	<0.038
<b>Other Reported Compounds</b>						
Dichloroethane, 1,2-	<b>0.65</b>	<0.55	<b>3.2</b>	<b>0.053</b>	<b>0.05</b>	<0.038
Dichloroethene, 1,1- (1,1-DCE)	<0.13	<0.55	<0.91	<0.037	<0.036	<0.038
Dichloroethene, cis-1,2-	<0.13	<0.55	<0.91	<0.037	<0.036	<0.038
Dichloroethene, trans-1,2-	<0.13	<b>0.57</b>	<0.91	<b>2.3</b>	<b>1.6</b>	<0.038
Tetrachloroethene (PCE)	<b>17</b>	<b>22</b>	<b>21</b>	<b>0.18</b>	<b>0.15</b>	<b>0.052</b>
Trichloroethane, 1,1,1- (TCA)	<b>3.4</b>	<b>6.2</b>	<b>9</b>	<b>0.042</b>	<b>0.039</b>	<0.038
Vinyl chloride (VC)	<0.13	<0.55	<0.91	<0.037	<0.036	<0.038

Notes:

- Vapor samples analyzed by ALS/Columbia Analytical Services, Simi Valley, CA.
- Sub-slab soil gas collected as grab samples (without flow controller). Indoor and outdoor air samples collected with 8-hour flow controller.
- Bold font = detected result; Less-than symbol ("<") = analyte not found at indicated limit; Dash ("-") indicates compound not analyzed.

**TABLE C.1.1: RESULTS FROM CONVENTIONAL VAPOR INTRUSION PROGRAM**  
**ESTCP Project ER-201119**  
**Joint Base Lewis-McChord, Washington**

Location ID:	BUILDING 9674				
Field Sample ID:	2-SS-1-CON	2-SS-2-CON	2-SS-3-CON-Resample	2-IA-1-CON	2-AA-1-CON
Sample Location ID:	2-SS-1	2-SS-2	2-SS-3	2-IA-1	2-AA-1
Description:	Sub-slab, north side of building	Sub-slab, near center	Sub-slab, south side of building	Indoor air, center of warehouse	Outdoors
Matrix:	SS	SS	SS	IA	AA
Sample Type:	N	N	N	N	N
Sample Collection Date:	7/24/2012 14:49	7/24/2012 15:05	7/26/2012 8:08	7/24/2012 15:21	7/24/2012 15:25
Analytical Method (units):	TO-15 SIM (ug/m3)	TO-15 SIM (ug/m3)	TO-15 SIM (ug/m3)	TO-15 SIM (ug/m3)	TO-15 SIM (ug/m3)
<b>Key Analyte for VI Evaluation</b>					
Trichloroethene (TCE)	<b>0.034</b>	<b>1.8</b>	<b>1.7</b>	<b>0.072</b>	<0.033
<b>Other Reported Compounds</b>					
Dichloroethane, 1,2-	<b>0.24</b>	<b>0.3</b>	<b>0.096</b>	<0.038	<b>0.038</b>
Dichloroethene, 1,1- (1,1-DCE)	<b>0.035</b>	<0.063	<0.033	<0.038	<0.033
Dichloroethene, cis-1,2-	<0.033	<0.063	<0.033	<0.038	<0.033
Dichloroethene, trans-1,2-	<0.033	<0.063	<0.033	<0.038	<0.033
Tetrachloroethene (PCE)	<b>18</b>	<b>48</b>	<b>35 D</b>	<b>0.24</b>	<b>0.053</b>
Trichloroethane, 1,1,1- (TCA)	<b>1.7</b>	<b>0.73</b>	<b>1.5</b>	<0.038	<0.033
Vinyl chloride (VC)	<0.033	<0.063	<0.033	<0.038	<0.033

Notes:

- Vapor samples analyzed by ALS/Columbia Analytical Services, Simi Valley, CA.
- Sub-slab soil gas collected as grab samples (without flow controller). Indoor and outdoor air samples collected with 8-hour flow controller.
- Bold font = detected result; Less-than symbol ("<") = analyte not found at indicated limit; Dash ("-") indicates compound not analyzed; "D" indicates result is from a dilution.

**TABLE C.1.2: RESULTS FROM ISOTOPE PROGRAM**  
**ESTCP Project ER-201119 and ER-201025**  
**Joint Base Lewis-McChord, Washington**

Location ID:	GROUNDWATER				BUILDING 9669		
	LC-18	DUP-1	LC-48	MT-1	1-SS-2-CSI	3-SS-2-CSI	1-IA-1-CSI
Field Sample ID:	LC-18	DUP-1	LC-48	MT-1	1-SS-2-CSI	3-SS-2-CSI	1-IA-1-CSI
Sample Location ID:	LC-18	LC-18	LC-48	MT-1	1-SS-2	1-SS-2	1-IA-1
Description:	near Building 9669	near Building 9669	near Building 9674	upgradient of 9669/9674	middle, near 1-IA-1	middle, near 1-IA-1	center of warehouse
Matrix:	GW	GW	GW	GW	SS	SS	IA
Sample Type:	N	FD	N	N	N	FD	N
Sample Collection Date/Time:	7/24/2012 10:50:00 AM	7/24/2012 10:50:00 AM	7/24/2012 11:35:00 AM	7/24/2012 10:15:00 AM	7/25/2012 9:34:00 AM	7/25/2012 9:57:00 AM	7/24/2012 9:41:00 AM
Analytical Method (units):	TCE C/Cl (per mil)	TCE C/Cl (per mil)	TCE C/Cl (per mil)	TCE C/Cl (per mil)	TCE C/Cl (per mil)	TCE C/Cl (per mil)	TCE C/Cl (per mil)
<b>Analyte</b>							
d13C TCE	<b>-23.3 H</b>	<b>-23.6 H</b>	<b>-23.8 H</b>	<b>-22.9 H</b>	<b>-18.5 H</b>	<b>-18.8 H</b>	<b>-25.9 HJ</b>
d37Cl TCE	<b>2.5 H</b>	<b>2.4 H</b>	<b>2.1 H</b>	<b>2.6 H</b>	<b>5.8 H</b>	<b>5.5 H</b>	<b>2.0 H</b>

Notes:

1. Isotope analysis was completed by the University of Oklahoma.
2. Groundwater samples collected by Versar.
3. Bold font = detected result; Less-than symbol ("<") = analyte not found at indicated limit; Dash ("-") indicates compound not analyzed; H = samples analyzed outside of validated holding time period of 2 weeks; J = estimated result.
4. Indoor air TCE concentrations were too low in Building 9674 to allow collection of sufficient mass for isotope analysis.

**TABLE C.1.3: RESULTS FROM ON-SITE ANALYSIS PROGRAM CONFIRMATION SAMPLES**  
**ESTCP Project ER-201119 and ER-201025**  
**Joint Base Lewis-McChord, Washington**

Location ID:	BUILDING 9669			
Field Sample ID:	1-IA-3-BL	1-IA-3-PP	1-IA-3-NP	1-AA-1
Sample Location ID:	1-IA-3	1-IA-3	1-IA-3	1-AA-1
Description:	near battery/ recycling area	near battery/ recycling area	near battery/ recycling area	outdoors
Matrix:	IA	IA	IA	AA
Pressure Condition	BL	PP	NP	BL
Sample Type:	N	N	N	N
Sample Collection Date/Time:	7/25/2012 8:53	7/25/2012 9:57	7/25/2012 11:06	7/25/2012 9:25
Analytical Method (units):	TO-15 SIM (ug/m3)	TO-15 SIM (ug/m3)	TO-15 SIM (ug/m3)	TO-15 SIM (ug/m3)
<b>Key Analyte for VI Evaluation</b>				
Trichloroethene (TCE)	<b>2</b>	<b>1.2</b>	<b>2</b>	-
<b>Other Reported VOCs</b>				
Dichloroethane, 1,2-	<b>0.051</b>	<b>0.05</b>	<b>0.047</b>	-
Dichloroethene, 1,1- (1,1-DCE)	<0.031	<0.031	<0.031	-
Dichloroethene, cis-1,2-	<0.031	<0.031	<0.031	-
Dichloroethene, trans-1,2-	<b>2.2</b>	<b>1.5</b>	<b>1</b>	-
Tetrachloroethene (PCE)	<b>0.22</b>	<b>0.17</b>	<b>0.16</b>	-
Trichloroethane, 1,1,1- (TCA)	<b>0.041</b>	<b>0.038</b>	<b>0.035</b>	-
Vinyl chloride (VC)	<0.031	<0.031	<0.031	-
<b>Radon (pCi/L)</b>				
Radon	<b>0.36</b>	<b>0.3</b>	<b>0.2</b>	<b>0.01</b>

Notes:

- VOC analysis of vapor samples by ALS/Columbia Analytical Services, Simi Valley, California. Radon analysis by University of Southern California.
- Samples collected as grab (i.e., without flow controller). Samples for VOC analysis were collected in 6-L Summa canisters. Samples for Radon analysis were collected in 1-L Tedlar bags.
- Pressure Condition: BL = baseline (uncontrolled); NP = negative pressure (building depressurized); PP = positive pressure (building pressurized)
- Bold font = detected result; Less-than symbol ("<") = analyte not found at indicated limit; Dash ("-") indicates compound not analyzed.

**TABLE C.1.3: RESULTS FROM ON-SITE ANALYSIS PROGRAM CONFIRMATION SAMPLES**  
**ESTCP Project ER-201119 and ER-201025**  
**Joint Base Lewis-McChord, Washington**

Location ID:	BUILDING 9674			
Field Sample ID:	2-IA-1-BL	DUP-1	2-IA-1-NP	2-AA-1
Sample Location ID:	2-IA-1	2-IA-1	2-IA-1	2-AA-1
Description:	center of warehouse	center of warehouse	center of warehouse	outdoors
Matrix:	IA	IA	IA	AA
Pressure Condition:	BL	BL	NP	BL
Sample Type:	N	FD	N	N
Sample Collection Date/Time:	7/26/2012 8:36	7/26/2012 8:36	7/26/2012 10:15	7/26/2012 8:45
Analytical Method (units):	TO-15 SIM (ug/m3)	TO-15 SIM (ug/m3)	TO-15 SIM (ug/m3)	TO-15 SIM (ug/m3)
<b>Key Analyte for VI Evaluation</b>				
Trichloroethene (TCE)	<b>0.032</b>	<0.031	<0.03	-
<b>Other Reported VOCs</b>				
Dichloroethane, 1,2-	<b>0.036</b>	<b>0.035</b>	<b>0.035</b>	-
Dichloroethene, 1,1- (1,1-DCE)	<0.03	<0.031	<0.03	-
Dichloroethene, cis-1,2-	<0.03	<0.031	<0.03	-
Dichloroethene, trans-1,2-	<0.03	<0.031	<0.03	-
Tetrachloroethene (PCE)	<0.03	<0.031	<0.03	-
Trichloroethane, 1,1,1- (TCA)	<0.03	<0.031	<0.03	-
Vinyl chloride (VC)	<0.03	<0.031	<0.03	-
<b>Radon (pCi/L)</b>				
Radon	<b>0.09</b>	<b>0.1</b>	<b>0.12</b>	<b>0.09</b>

Notes:

- VOC analysis of vapor samples by ALS/Columbia Analytical Services, Simi Valley, California. Radon analysis by University of Southern California.
- Samples collected as grab (i.e., without flow controller). Samples for VOC analysis were collected in 6-L Summa canisters. Samples for Radon analysis were collected in 1-L Tedlar bags.
- Pressure Condition: BL = baseline (uncontrolled); NP = negative pressure (building depressurized); PP = positive pressure (building pressurized)
- Bold font = detected result; Less-than symbol ("<") = analyte not found at indicated limit; Dash ("-") indicates compound not analyzed.

**TABLE C.1.4: RESULTS FROM ON-SITE GC/MS ANALYSIS**  
**ESTCP Project ER-201119 and ER-201025**  
**Joint Base Lewis-McChord, Washington**

Sample Date/Time	Description	Matrix	DCE12T	TCE
			ug/m3	ug/m3
<b>SCREENING SAMPLES</b>				
7/23/2012 10:56	Workroom air, door open	AI	U	U
7/23/2012 11:06	09522 IA (Tedlar)	AI	U	U
7/23/2012 11:13	09671 IA (Tedlar)	AI	U	0.12 J
7/23/2012 11:21	09666 IA (Tedlar)	AI	U	U
7/23/2012 11:28	Workroom air, door open	AI	U	U
7/23/2012 11:35	09679 IA (Tedlar)	AI	U	U
7/23/2012 11:43	09674 IA (Tedlar)	AI	U	U
7/23/2012 11:50	09669 IA (Tedlar)	AI	1.4 J	1.7 J
7/23/2012 12:44	09522 IA (re-run Tedlar)	AI	U	U
7/23/2012 12:52	Workroom air, door open	AI	U	U
7/23/2012 14:27	09564 IA (Tedlar)	AI	U	0.097 J
7/23/2012 14:35	09673 IA (Tedlar)	AI	U	U
7/23/2012 16:15	9669-SS-1 (Tedlar)	SS	U	45
7/23/2012 16:23	9669-SS-2 (Tedlar)	SS	U	210 JE
7/23/2012 16:30	Workroom air, door open	AI	U	0.4 J
7/23/2012 16:38	9669-SS-3	SS	U	4
7/23/2012 16:49	9669-SS-2 (repeat Tedlar)	SS	U	210 JE
7/24/2012 10:15	9674 SS-1 (Tedlar)	SS	U	0.22 J
7/24/2012 10:28	9674 SS-2 (Tedlar)	SS	U	1.8 J
7/24/2012 10:35	9674 SS-3 (Tedlar)	SS	U	U
7/24/2012 10:43	rerun 9674 SS-3 Tedlar	SS	U	1.6 J
<b>BUILDING 9669</b>				
7/24/2012 10:07	1-IA-1 location; next to 8-hr Summa	AI	2.4	2 J
7/24/2012 10:51	1-IA-1 repeat	AI	2.2	U
7/24/2012 11:33	Outdoors on loading dock	AA	U	U
7/24/2012 13:45	Near battery center	AI	0.48 J	2 J
7/24/2012 13:53	Center back	AI	1.7 J	0.97 J
7/24/2012 14:00	Center (1-IA-1)	AI	21	0.91 J
7/24/2012 14:09	Center of offices (room with cubicles)	AI	1.5 J	0.81 J
7/24/2012 14:16	Office front corner (design demonstration room)	AI	0.91 J	0.91 J
7/24/2012 14:24	Repeat front corner near battery center/recycling area	AI	0.48 J	4.1



**TABLE C.1.4: RESULTS FROM ON-SITE GC/MS ANALYSIS**  
**ESTCP Project ER-201119 and ER-201025**  
**Joint Base Lewis-McChord, Washington**

Sample Date/Time	Description	Matrix	DCE12T	TCE
			ug/m3	ug/m3
<b>BUILDING 9669</b>				
7/24/2012 14:32	Inside cage	AI	0.63 J	0.75 J
7/24/2012 14:39	Between counter and front door/main entrance	AI	0.79 J	0.91 J
7/24/2012 14:47	Near 1-IA-2	AI	0.59 J	0.7 J
7/24/2012 14:54	Repeat front corner near battery center	AI	U	2.8
7/25/2012 7:57	BL 1-IA-1 center of building	AI	2.1	1.9 J
7/25/2012 8:04	BL Center back	AI	1.9 J	1.7 J
7/25/2012 8:11	BL Front corner	AI	1.7 J	2.2 J
7/25/2012 8:18	BL Front, near counter	AI	2 J	1.6 J
7/25/2012 8:50	BL Repeat front corner (1-IA-3)	AI	1.6 J	1.5 J
7/25/2012 9:07	PP Repeat front corner (1-IA-3)	AI	1.5 J	1.4 J
7/25/2012 9:23	Outdoors at 1-AA-1.	AA	U	U
7/25/2012 9:31	PP Repeat front corner (1-IA-3)	AI	1.3 J	1.2 J
7/25/2012 9:42	PP Repeat front corner (1-IA-3)	AI	1.1 J	1 J
7/25/2012 9:54	PP Repeat front corner (1-IA-3)	AI	1.1 J	1.1 J
7/25/2012 10:08	NP Repeat front corner (1-IA-3)	AI	0.95 J	0.81 J
7/25/2012 10:22	NP Repeat front corner (1-IA-3)	AI	1.2 J	1.3 J
7/25/2012 10:41	NP Repeat front corner (1-IA-3)	AI	0.95 J	1.6 J
7/25/2012 10:55	NP Repeat front corner (1-IA-3)	AI	0.91 J	1.8 J
7/25/2012 11:05	NP Repeat front corner (1-IA-3)	AI	0.71 J	2.1 J
7/25/2012 11:13	NP Repeat front corner (1-IA-3)	AI	0.91 J	1.7 J
7/25/2012 11:27	Flux crack near SS-2. Sampled after 5 minutes.	AF	1.2 J	1 J
7/25/2012 11:35	Flux same crack near SS-2. Sampled after 15 minutes total. Fan off.	AF	1.3 J	U
7/25/2012 13:25	Flux second crack, in floor of cage. Sampled after approx 1 hr 20 min	AF	0.79 J	2.8
7/25/2012 13:36	BL Indoor air in cage	AI	1.2 J	1.8 J
7/25/2012 13:43	BL 1-IA-3	AI	1.2 J	2.9
7/25/2012 13:50	BL Center back	AI	1.3 J	1.2 J
7/25/2012 14:01	BL Center, near 1-IA-1	AI	2.3	1.1 J
7/25/2012 14:09	BL Near shelf with trans12DCE source	AI	87	0.97 J
7/25/2012 14:21	BL Center of other half of building (haz mat storage)	AI	U	0.23 J
7/25/2012 14:33	Floor flux through carpet 1. Bowl set approx 1 hr 10 min prior to sampling.	AF	1 J	5.4

**TABLE C.1.4: RESULTS FROM ON-SITE GC/MS ANALYSIS**  
**ESTCP Project ER-201119 and ER-201025**  
**Joint Base Lewis-McChord, Washington**

Sample Date/Time	Description	Matrix	DCE12T	TCE
			ug/m3	ug/m3
<b>BUILDING 9669</b>				
7/25/2012 14:41	Floor flux through carpet 2	AF	0.59 J	1.3 J
7/25/2012 14:53	Floor flux through carpet 3, closer to wall	AF	0.56 J	4.5
7/25/2012 15:01	Floor flux through carpet 4, closer to cage	AF	U	3.8
7/25/2012 15:08	Repeat floor flux through carpet 1. Bowl set <5 min prior to sampling	AF	0.63 J	2.6 J
7/25/2012 15:15	Floor flux through carpet 5, further from wall	AF	0.67 J	3.1
7/25/2012 15:22	Floor flux through carpet 6	AF	0.59 J	3.6
7/25/2012 15:29	Indoor air approx 2 ft above carpet 6	AI	U	5.9
7/25/2012 15:39	Indoor air approx 2 ft above floor, near closed bay door	AI	0.63 J	4
<b>BUILDING 9674</b>				
7/26/2012 7:47	Outdoors near 2-AA-1	AA	U	U
7/26/2012 7:58	BL 2-IA-1 center of building	AI	U	U
7/26/2012 8:05	BL in front of hazmat containers	AI	U	U
7/26/2012 8:25	BL in front of back / bondcote shelves (repeat location)	AI	U	U
7/26/2012 8:56	NP 2-IA-1	AI	U	U
7/26/2012 9:15	NP 2-IA-1	AI	U	U
7/26/2012 9:45	NP 2-IA-1	AI	U	U
7/26/2012 10:13	NP 2-IA-1	AI	U	U

Notes:

1. Samples analyzed using an Inficon HAPSITE ER portable GC/MS instrument. Calibration curve 7/22/2012.
2. Samples are grouped by building, and sorted chronologically.
3. J = estimated (result less than lower calibration limit); JE = estimated (result higher than upper calibration limit); U = not detected.
4. Matrix: AI = Indoor air; AF = Flux chamber; AA = Ambient (outdoor) air; SS = Sub-slab

**APPENDIX C FIGURES**  
**ESTCP Projects ER-201119 and ER-201025**  
**Joint Base Lewis-McChord, Washington**

**Figure C.1.1: Site Map**

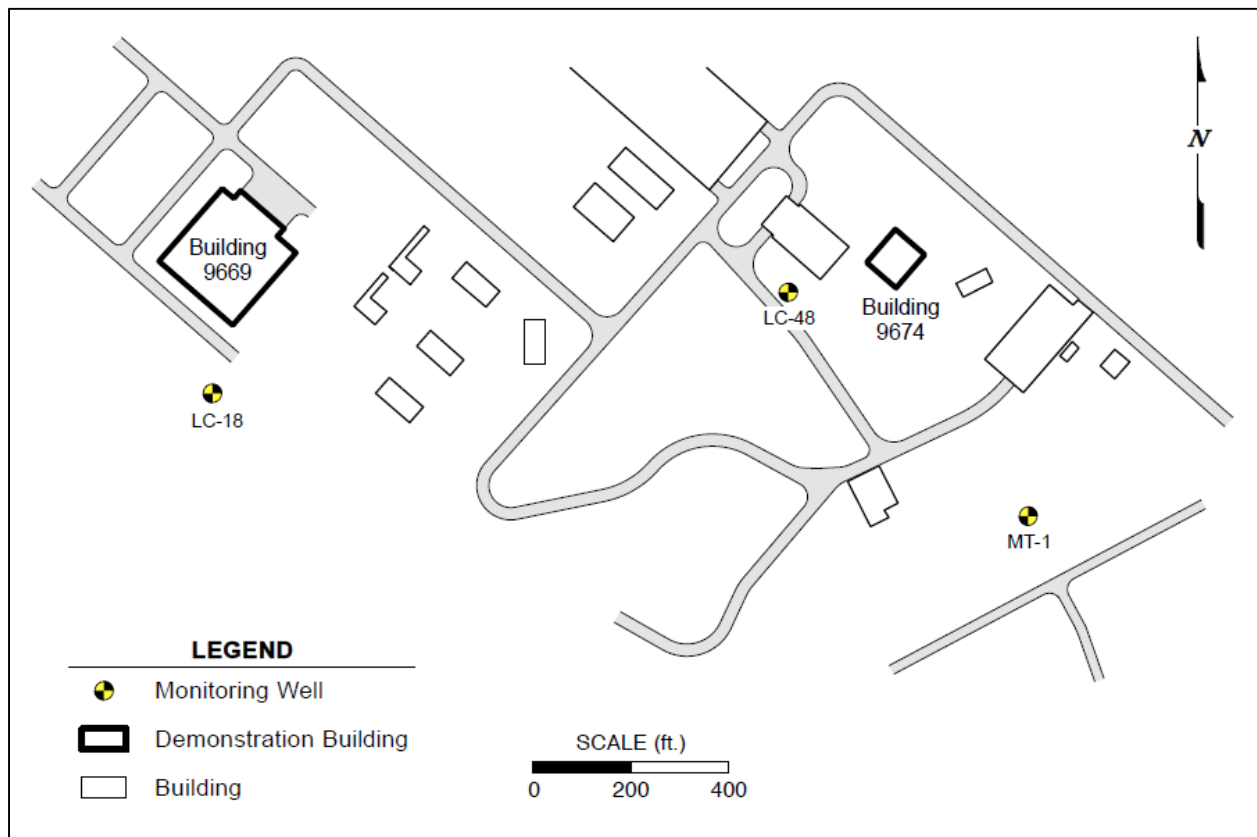

Note: Only monitoring wells sampled for the demonstration are shown. Groundwater gradient is to the northwest. TCE concentration in shallow groundwater in map area is in the 50 – 100 ug/L range.

**APPENDIX C FIGURES**  
**ESTCP Projects ER-201119 and ER-201025**  
**Joint Base Lewis-McChord, Washington**

**Figure C.1.2: Building 9669 Floorplan**

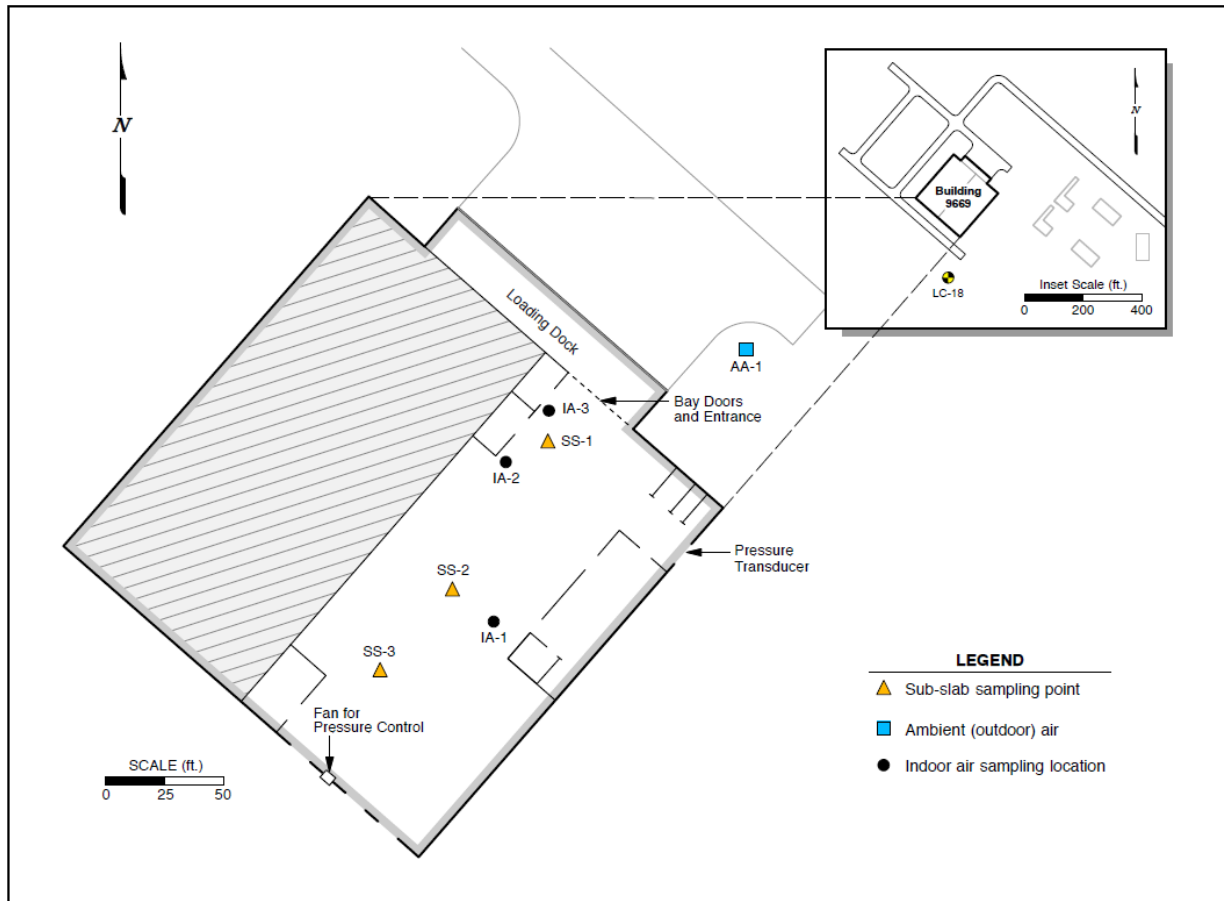

Note: Figure illustrates sample locations for off-site laboratory analysis. HAPSITE sample locations are not shown.

**APPENDIX C FIGURES**  
**ESTCP Projects ER-201119 and ER-201025**  
**Joint Base Lewis-McChord, Washington**

**Figure C.1.3: Building 9674 Floorplan**

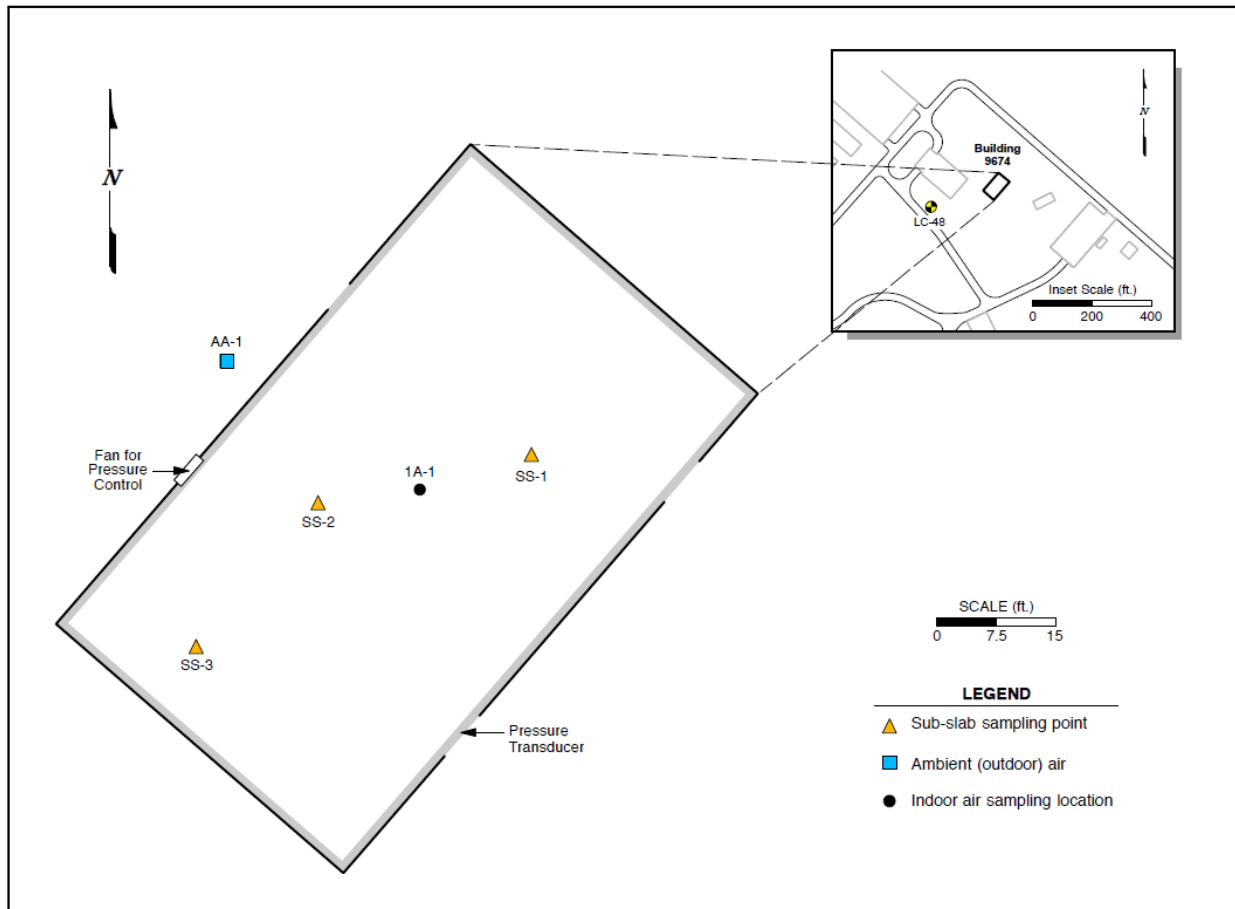

Note: Figure illustrates sample locations for off-site laboratory analysis. HAPSITE sample locations are not shown.

## **Appendix C.2: Selfridge Air National Guard Base, Michigan**

### **TABLES**

---

Table C.2.1	Results from Conventional Vapor Intrusion Program
Table C.2.2	Results from Isotope Program
Table C.2.3	Results from On-Site Analysis Program Confirmation Samples
Table C.2.4	Results from On-Site GC/MS Analysis

### **FIGURES**

---

Figure C.2.1	Site Map
Figure C.2.2	Building 1533 Floorplan

**TABLE C.2.1: RESULTS FROM CONVENTIONAL VAPOR INTRUSION PROGRAM**  
 ESTCP Project ER-201119 and ER-201025  
 Selfridge Air National Guard Base, Michigan

Location ID: Field Sample ID: Sample Location ID: Description: Matrix: Sample Type: Sample Collection Date/Time: Analytical Method (units):	BUILDING 1533					
	MW-16	SS-1C	SS-2C	SS-3C	INDOOR-C1	OUTDOOR-C1
	MW-16	SS-1	SS-2	SS-3	IA-1	AA-1
	East of building, between building and fmr UST cavity	Sub-slab, west bay of building	Sub-slab, inside storeroom on east side of building	Sub-slab, northeast corner outside office door	Indoor Air, southwest side of building	Outdoors, west of building
	GW	SS	SS	SS	IA	AA
	N	N	N	N	N	N
	9/18/2012 15:20	9/18/2012 13:23	9/18/2012 13:43	9/18/2012 14:00	9/18/2012 16:30	9/18/2012 16:30
8260C (ug/L)	TO-15 (ug/m3)	TO-15 (ug/m3)	TO-15 (ug/m3)	TO-15 (ug/m3)	TO-15 (ug/m3)	
<b>Key Analyte for VI Evaluation</b>						
Benzene	360	<9.3	58	0.32	14	0.27
<b>Other Reported Compounds</b>						
Acetone	<200	510	3300	250	54000	14
Acetonitrile	-	<46	<32	<0.69	<57	<0.73
Acrolein	-	<190	<130	<2.8	<230	<2.9
Acrylonitrile	<200	<46	<32	<0.69	<57	<0.73
Benzyl Chloride	-	<46	<32	<0.69	<57	<0.73
Bromobenzene	<100	-	-	-	-	-
Bromochloromethane	<100	-	-	-	-	-
Bromodichloromethane	<20	<9.3	<6.4	<0.14	<11	<0.15
Bromoform	<80	<46	<32	<0.69	<57	<0.73
Bromomethane	<40	<9.3	<6.4	<0.14	<11	<0.15
Butadiene, 1,3-	-	<19	<13	<0.28	<23	<0.29
Butanone, 2- (MEK)	<200	<460	<320	<6.9	<570	<7.3
Butyl Acetate, n-	-	<46	<32	<0.69	<57	<0.73
Butylbenzene, n-	32	-	-	-	-	-
Butylbenzene, sec-	<20	-	-	-	-	-
Butylbenzene, tert-	<100	-	-	-	-	-
Carbon disulfide	<200	<460	<320	<6.9	<570	<7.3
Carbon tetrachloride	<20	<9.3	<6.4	<0.14	<11	0.48
Chloro-1-propene, 3- (Allyl Chloride)	-	<9.3	<6.4	<0.14	<11	<0.15
Chlorobenzene	<20	<9.3	<6.4	<0.14	<11	<0.15
Chloroethane	<40	<9.3	<6.4	<0.14	<11	<0.15
Chloroform	<30	<9.3	<6.4	0.2	<11	<0.15
Chloromethane	<100	<19	<13	<0.28	<23	0.37
Chlorotoluene, o-	<100	-	-	-	-	-
Chlorotoluene, p-	<100	-	-	-	-	-
Cyclohexane	-	<93	480	<1.4	<110	<1.5
Dibromo-3-chloropropane, 1,2- (DBCP)	<100	<46	<32	<0.69	<57	<0.73

**TABLE C.2.1: RESULTS FROM CONVENTIONAL VAPOR INTRUSION PROGRAM**  
 ESTCP Project ER-201119 and ER-201025  
 Selfridge Air National Guard Base, Michigan

Location ID: Field Sample ID: Sample Location ID: Description: Matrix: Sample Type: Sample Collection Date/Time: Analytical Method (units):	BUILDING 1533					
	MW-16	SS-1C	SS-2C	SS-3C	INDOOR-C1	OUTDOOR-C1
	MW-16	SS-1	SS-2	SS-3	IA-1	AA-1
	East of building, between building and fmr UST cavity	Sub-slab, west bay of building	Sub-slab, inside storeroom on east side of building	Sub-slab, northeast corner outside office door	Indoor Air, southwest side of building	Outdoors, west of building
	GW	SS	SS	SS	IA	AA
	N	N	N	N	N	N
	9/18/2012 15:20	9/18/2012 13:23	9/18/2012 13:43	9/18/2012 14:00	9/18/2012 16:30	9/18/2012 16:30
8260C (ug/L)	TO-15 (ug/m3)	TO-15 (ug/m3)	TO-15 (ug/m3)	TO-15 (ug/m3)	TO-15 (ug/m3)	
Dibromochloromethane	<20	<9.3	<6.4	<0.14	<11	<0.15
Dibromoethane, 1,2-	<80	<9.3	<6.4	<0.14	<11	<0.15
Dibromomethane	<200	-	-	-	-	-
Dichloro-1,1,2,2-tetrafluoroethane, 1,2- (CF <sub>2</sub> )	-	<46	<32	<0.69	<57	<0.73
Dichloro-2-butene, trans-1,4-	<100	-	-	-	-	-
Dichlorobenzene, 1,2-	<100	<9.3	<6.4	<0.14	<11	<0.15
Dichlorobenzene, 1,3-	<100	<9.3	<6.4	<0.14	<11	<0.15
Dichlorobenzene, 1,4-	<100	<9.3	<6.4	<b>0.14</b>	<11	<0.15
Dichlorobutane, 1,4-	<200	-	-	-	-	-
Dichlorodifluoromethane (CFC 12)	<200	<46	<32	<b>2.2</b>	<57	<b>2.2</b>
Dichloroethane, 1,1- (1,1-DCA)	<30	<9.3	<6.4	<0.14	<11	<0.15
Dichloroethane, 1,2-	<20	<9.3	<6.4	<0.14	<11	<0.15
Dichloroethene, 1,1- (1,1-DCE)	<20	<9.3	<6.4	<0.14	<11	<0.15
Dichloroethene, cis-1,2-	<20	<9.3	<6.4	<0.14	<11	<0.15
Dichloroethene, trans-1,2-	<30	<9.3	<6.4	<0.14	<11	<0.15
Dichloropropane, 1,2-	<70	<9.3	<6.4	<0.14	<11	<0.15
Dichloropropane, 1,3-	<100	-	-	-	-	-
Dichloropropane, 2,2-	<100	-	-	-	-	-
Dichloropropene, 1,1-	<100	-	-	-	-	-
Dichloropropene, cis-1,3-	<20	<46	<32	<0.69	<57	<0.73
Dichloropropene, trans-1,3-	<20	<46	<32	<0.69	<57	<0.73
Dioxane, 1,4-	-	<46	<32	<0.69	<57	<0.73
Ethanol	-	<460	<320	<6.9	<570	<7.3
Ethyl Acetate	-	<93	<64	<1.4	<110	<b>3.1</b>
Ethyl ether	<100	-	-	-	-	-
Ethyl methacrylate	<200	-	-	-	-	-
Ethylbenzene	<b>1400</b>	<46	<b>430</b>	<b>0.92</b>	<57	<0.73
Ethyltoluene, 4-	-	<46	<b>260</b>	<b>1.2</b>	<57	<0.73
Heptane, n-	-	<46	<b>960</b>	<b>11</b>	<b>5700</b>	<b>0.91</b>
Hexachlorobutadiene	<20	<46	<32	<0.69	<57	<0.73



**TABLE C.2.1: RESULTS FROM CONVENTIONAL VAPOR INTRUSION PROGRAM**  
 ESTCP Project ER-201119 and ER-201025  
 Selfridge Air National Guard Base, Michigan

Location ID: Field Sample ID: Sample Location ID: Description: Matrix: Sample Type: Sample Collection Date/Time: Analytical Method (units):	BUILDING 1533					
	MW-16	SS-1C	SS-2C	SS-3C	INDOOR-C1	OUTDOOR-C1
	MW-16	SS-1	SS-2	SS-3	IA-1	AA-1
	East of building, between building and fmr UST cavity	Sub-slab, west bay of building	Sub-slab, inside storeroom on east side of building	Sub-slab, northeast corner outside office door	Indoor Air, southwest side of building	Outdoors, west of building
	GW	SS	SS	SS	IA	AA
	N	N	N	N	N	N
	9/18/2012 15:20	9/18/2012 13:23	9/18/2012 13:43	9/18/2012 14:00	9/18/2012 16:30	9/18/2012 16:30
8260C (ug/L)	TO-15 (ug/m3)	TO-15 (ug/m3)	TO-15 (ug/m3)	TO-15 (ug/m3)	TO-15 (ug/m3)	
Hexane, n-	-	<46	1200	1.2	240	<0.73
Hexanone, 2-	<200	<46	<32	<0.69	<57	<0.73
Isopropylbenzene (Cumene)	68	<46	34	<0.69	<57	<0.73
Isopropyltoluene, p-	<20	-	-	-	-	-
Limonene, d-	-	<46	<32	<0.69	<57	<0.73
Methyl Methacrylate	-	<93	<64	<1.4	<110	<1.5
Methyl tert-Butyl Ether	<40	<9.3	<6.4	0.45	<11	<0.15
Methyl-2-pentanone, 4-	<200	<46	<32	<0.69	<57	<0.73
Methylene Chloride	<120	<46	<32	<0.69	<57	<0.73
Naphthalene	680	<46	<32	11	<57	<0.73
Nonane, n-	-	<46	51	<0.69	<57	<0.73
Octane, n-	-	<46	210	0.91	<57	<0.73
Pinene, alpha-	-	<46	<32	2.8	<57	<0.73
Propanol, 2- (Isopropyl Alcohol)	-	<460	<320	<6.9	<570	14
Propene	-	<46	<32	2.2	<57	4.8
Propylbenzene, n-	210	<46	130	<0.69	<57	<0.73
Styrene	<40	<46	<32	<0.69	<57	<0.73
Tetrachloroethane, 1,1,1,2-	<20	-	-	-	-	-
Tetrachloroethane, 1,1,2,2-	<20	<9.3	<6.4	<0.14	<11	<0.15
Tetrachloroethene	<20	8000	5000	610 D	<11	0.52
Tetrahydrofuran (THF)	<200	<46	<32	<0.69	<57	<0.73
Toluene	41	<46	52	1.5	<57	1.2
Trichlorobenzene, 1,2,3-	<100	-	-	-	-	-
Trichlorobenzene, 1,2,4-	<100	<46	<32	<0.69	<57	<0.73
Trichloroethane, 1,1,1-	<20	<9.3	<6.4	<0.14	<11	<0.15
Trichloroethane, 1,1,2-	<30	<9.3	<6.4	<0.14	<11	<0.15
Trichloroethene	<20	9.4	26	0.63	48	0.3
Trichlorofluoromethane (CFC 11)	<100	<9.3	<6.4	0.88	<11	1.2
Trichloropropane, 1,2,3-	<200	-	-	-	-	-
Trichlorotrifluoroethane, 1,1,2-	-	<9.3	<6.4	0.45	<11	0.48

**TABLE C.2.1: RESULTS FROM CONVENTIONAL VAPOR INTRUSION PROGRAM**  
 ESTCP Project ER-201119 and ER-201025  
 Selfridge Air National Guard Base, Michigan

Location ID:	BUILDING 1533					
Field Sample ID:	MW-16	SS-1C	SS-2C	SS-3C	INDOOR-C1	OUTDOOR-C1
Sample Location ID:	MW-16	SS-1	SS-2	SS-3	IA-1	AA-1
Description:	East of building, between building and fmr UST cavity	Sub-slab, west bay of building	Sub-slab, inside storeroom on east side of building	Sub-slab, northeast corner outside office door	Indoor Air, southwest side of building	Outdoors, west of building
Matrix:	GW	SS	SS	SS	IA	AA
Sample Type:	N	N	N	N	N	N
Sample Collection Date/Time:	9/18/2012 15:20	9/18/2012 13:23	9/18/2012 13:43	9/18/2012 14:00	9/18/2012 16:30	9/18/2012 16:30
Analytical Method (units):	8260C (ug/L)	TO-15 (ug/m3)	TO-15 (ug/m3)	TO-15 (ug/m3)	TO-15 (ug/m3)	TO-15 (ug/m3)
Trimethylbenzene, 1,2,4-	<b>1800</b>	<46	<b>860</b>	<b>25</b>	<57	<0.73
Trimethylbenzene, 1,3,5-	<b>570</b>	<46	<b>220</b>	<b>7.4</b>	<57	<0.73
Vinyl acetate	<200	<460	<320	<6.9	<570	<7.3
Vinyl chloride	<40	<9.3	<6.4	<0.14	<11	<0.15
Xylene, o-	<40	<46	<32	<b>2.2</b>	<57	<0.73
Xylenes, m,p-	<b>4800</b>	<46	<b>770</b>	<b>3</b>	<57	<0.73

Notes:

1. Groundwater sample analyzed by Alpha Analytical, Mansfield, MA. Vapor samples analyzed by ALS/Columbia Analytical Services, Simi Valley, California.
2. Sub-slab soil gas collected as grab samples (without flow controller). Indoor and outdoor air sample collected with 8-hour flow controller.
3. Bold font = detected result; Less-than symbol ("<") = analyte not found at indicated limit; Dash ("-") indicates compound not analyzed.

**TABLE C.2.2: RESULTS FROM ISOTOPE PROGRAM**  
**ESTCP Project ER-201119 and ER-201025**  
**Selfridge Air National Guard Base, Michigan**

Location ID:	BUILDING 1533						
Field Sample ID:	MW-16	SS-1	SS-2 1 HOUR	SS-2 HIGH	SS-2 LOW	INDOOR-1	INDOOR-1 OVERNIGHT
Sample Location ID:	MW-16	SS-1	SS-2	SS-2	SS-2	IA-1	IA-1
Description:	East of building	at IA-2; near IA-1	Inside storeroom	Inside storeroom	Inside storeroom	Southwest side of building	Southwest side of building
Matrix:	GW	SS	SS	SS	SS	IA	IA
Sample Type:	N	N	N	N	N	N	N
Sample Collection Date/Time:	9/18/2012 15:20	9/19/2012 16:40	9/19/2012 10:49	9/18/2012 16:44	9/18/2012 16:56	9/18/2012 16:22	9/20/2012 8:17
Units:	per mil	per mil	per mil	per mil	per mil	per mil	per mil
Analyte							
d13C BEN	<b>-26.6 H</b>	<b>-29.9 H</b>	<b>-29.4 H</b>	<b>-31.1 H</b>	<b>-28.9 JH</b>	<b>-29.1 H</b>	<b>-30.0 H</b>
d13C TCE	-	<b>-18.8 H</b>	<b>-26.0 H</b>	<b>-25.5 H</b>	-	<b>-32.5 H</b>	<b>-30.7 JH</b>
d13C PCE	-	<b>-26.7 H</b>	<b>-25.3 H</b>	<b>-25.5 H</b>	<b>-25.7 H</b>	<b>-27.8 JH</b>	<b>-27.8 JH</b>

Notes:

1. Isotope analysis was completed by the University of Oklahoma.
2. Bold font = detected result; Dash ("-") indicates compound not analyzed;  
 H = samples analyzed outside of validated holding time period of 2 weeks; J = estimated result.

**TABLE C.2.3: RESULTS FROM ON-SITE ANALYSIS PROGRAM CONFIRMATION SAMPLES**  
**ESTCP Project ER-201119 and ER-201025**  
**Selfridge Air National Guard Base, Michigan**

Location ID:	BUILDING 1533			
Field Sample ID:	INDOOR-1-BL	INDOOR-1-PP (RE)	INDOOR-1-NP	AMBIENT-1-BL
Sample Location ID:	IA-2	IA-2	IA-2	AA-1
Description:	Indoor air from center of western bay; sample collected 5 min after SUV in bay was started briefly	Center of western bay	Center of western bay; sample collected after truck in bay started briefly	Outdoors, west of building
Matrix:	IA	IA	IA	AA
Pressure Condition:	BL	PP	NP	BL
Sample Type:	N	N	N	N
Sample Collection Date/Time:	9/19/2012 11:15	9/19/2012 14:16	9/19/2012 16:43	9/19/2012 11:10
Analytical Method (units):	TO-15 (ug/m3)	TO-15 (ug/m3)	TO-15 (ug/m3)	TO-15 (ug/m3)
<b>Key Analyte for VI Evaluation</b>				
Benzene	130	5.3 RE	69	-
<b>Other Reported VOCs</b>				
Acetone	1100	18000 RE E	9400 D	-
Acetonitrile	2.4	<2.5 RE	<6.5	-
Acrolein	<5	<9.9 RE	<26	-
Acrylonitrile	<1.2	<2.5 RE	<6.5	-
Benzyl Chloride	<1.2	<2.5 RE	<6.5	-
Bromodichloromethane	<0.25	<0.5 RE	<1.3	-
Bromoform	<1.2	<2.5 RE	<6.5	-
Bromomethane	<0.25	<0.5 RE	<1.3	-
Butadiene, 1,3-	33	<0.99 RE	14	-
Butanone, 2- (MEK)	<12	<25 RE	<65	-
Butyl Acetate, n-	2.1	<2.5 RE	<6.5	-
Carbon disulfide	<12	<25 RE	<65	-
Carbon tetrachloride	0.55	<0.5 RE	<1.3	-
Chloro-1-propene, 3- (Allyl Chloride)	<0.25	<0.5 RE	<1.3	-
Chlorobenzene	<0.25	<0.5 RE	<1.3	-
Chloroethane	<0.25	<0.5 RE	<1.3	-
Chloroform	0.27	<0.5 RE	<1.3	-
Chloromethane	0.86	<0.99 RE	<2.6	-
Cyclohexane	12	27 RE	33	-
Dibromo-3-chloropropane, 1,2- (DBCP)	<1.2	<2.5 RE	<6.5	-
Dibromochloromethane	<0.25	<0.5 RE	<1.3	-
Dibromoethane, 1,2-	<0.25	<0.5 RE	<1.3	-
Dichloro-1,1,2,2-tetrafluoroethane, 1,2- (CFC 112)	<1.2	<2.5 RE	<6.5	-
Dichlorobenzene, 1,2-	<0.25	<0.5 RE	<1.3	-
Dichlorobenzene, 1,3-	<0.25	<0.5 RE	<1.3	-
Dichlorobenzene, 1,4-	<0.25	<0.5 RE	<1.3	-
Dichlorodifluoromethane (CFC 12)	2.3	<2.5 RE	<6.5	-
Dichloroethane, 1,1- (1,1-DCA)	<0.25	<0.5 RE	<1.3	-
Dichloroethane, 1,2-	<0.25	<0.5 RE	<1.3	-
Dichloroethene, 1,1- (1,1-DCE)	<0.25	<0.5 RE	<1.3	-
Dichloroethene, cis-1,2-	<0.25	<0.5 RE	<1.3	-
Dichloroethene, trans-1,2-	<0.25	<0.5 RE	<1.3	-
Dichloropropane, 1,2-	<0.25	<0.5 RE	<1.3	-
Dichloropropene, cis-1,3-	<1.2	<2.5 RE	<6.5	-
Dichloropropene, trans-1,3-	<1.2	<2.5 RE	<6.5	-
Dioxane, 1,4-	<1.2	<2.5 RE	<6.5	-
Ethanol	77	25 RE	80	-
Ethyl Acetate	<2.5	<5 RE	27	-
Ethylbenzene	84	6 RE	50	-
Ethyltoluene, 4-	36	3.3 RE	29	-
Heptane, n-	130	1800 RE E	1100	-

**TABLE C.2.3: RESULTS FROM ON-SITE ANALYSIS PROGRAM CONFIRMATION SAMPLES**  
**ESTCP Project ER-201119 and ER-201025**  
**Selfridge Air National Guard Base, Michigan**

Location ID: Field Sample ID: Sample Location ID: Description: Matrix: Pressure Condition: Sample Type: Sample Collection Date/Time: Analytical Method (units):	BUILDING 1533			
	INDOOR-1-BL	INDOOR-1-PP (RE)	INDOOR-1-NP	AMBIENT-1-BL
	IA-2	IA-2	IA-2	AA-1
	Indoor air from center of western bay; sample collected 5 min after SUV in bay was started briefly	Center of western bay	Center of western bay; sample collected after truck in bay started briefly	Outdoors, west of building
	IA	IA	IA	AA
	BL	PP	NP	BL
	N	N	N	N
	9/19/2012 11:15	9/19/2012 14:16	9/19/2012 16:43	9/19/2012 11:10
	TO-15 (ug/m3)	TO-15 (ug/m3)	TO-15 (ug/m3)	TO-15 (ug/m3)
Hexachlorobutadiene	<1.2	<2.5 RE	<6.5	-
Hexane, n-	<b>68</b>	<b>10 RE</b>	<b>120</b>	-
Hexanone, 2-	<1.2	<2.5 RE	<6.5	-
Isopropylbenzene (Cumene)	<b>4.3</b>	<2.5 RE	<6.5	-
Limonene, d-	<b>23</b>	<b>19 RE</b>	<b>100</b>	-
Methyl Methacrylate	<2.5	<5 RE	<13	-
Methyl tert-Butyl Ether	<0.25	<0.5 RE	<1.3	-
Methyl-2-pentanone, 4-	<b>20</b>	<b>6 RE</b>	<b>9.5</b>	-
Methylene Chloride	<b>23</b>	<b>9.7 RE</b>	<6.5	-
Naphthalene	<b>19</b>	<b>2.7 RE</b>	<b>47</b>	-
Nonane, n-	<b>46</b>	<b>3.7 RE</b>	<b>14</b>	-
Octane, n-	<b>25</b>	<2.5 RE	<b>15</b>	-
Pinene, alpha-	<1.2	<2.5 RE	<6.5	-
Propanol, 2- (Isopropyl Alcohol)	<b>21</b>	<25 RE	<65	-
Propene	<b>86</b>	<b>3.4 RE</b>	<b>39</b>	-
Propylbenzene, n-	<b>16</b>	<2.5 RE	<b>12</b>	-
Styrene	<b>31</b>	<2.5 RE	<b>21</b>	-
Tetrachloroethane, 1,1,2,2-	<0.25	<0.5 RE	<1.3	-
Tetrachloroethene	<b>1.8</b>	<b>0.57 RE</b>	<b>1.8</b>	-
Tetrahydrofuran (THF)	<1.2	<2.5 RE	<6.5	-
Toluene	<b>410 D</b>	<b>18 RE</b>	<b>170</b>	-
Trichlorobenzene, 1,2,4-	<1.2	<2.5 RE	<6.5	-
Trichloroethane, 1,1,1-	<0.25	<0.5 RE	<1.3	-
Trichloroethane, 1,1,2-	<0.25	<0.5 RE	<1.3	-
Trichloroethene	<b>140</b>	<b>54 RE</b>	<b>15</b>	-
Trichlorofluoromethane (CFC 11)	<b>1.2</b>	<b>1.2 RE</b>	<b>1.8</b>	-
Trichlorotrifluoroethane, 1,1,2-	<b>0.49</b>	<0.5 RE	<1.3	-
Trimethylbenzene, 1,2,4-	<b>120</b>	<b>13 RE</b>	<b>110</b>	-
Trimethylbenzene, 1,3,5-	<b>38</b>	<b>3.8 RE</b>	<b>34</b>	-
Vinyl acetate	<12	<25 RE	<65	-
Vinyl chloride	<0.25	<0.5 RE	<1.3	-
Xylene, o-	<b>100</b>	<b>8.2 RE</b>	<b>70</b>	-
Xylenes, m,p-	<b>290</b>	<b>21 RE</b>	<b>180</b>	-
<b>Radon (pCi/L)</b>				
Radon	<b>0.42</b>	<b>0.19</b>	<b>0.28</b>	<b>0.08</b>

Notes:

- VOC analysis of vapor samples by ALS/Columbia Analytical Services, Simi Valley, California. Radon analysis by University of Southern Calif
- Samples collected as grab (i.e., without flow controller). Samples for VOC analysis were collected in 6-L Summa canisters. Samples for Rad in 1-L Tedlar bags.
- Pressure Condition: BL = baseline (normal operating conditions); NP = negative pressure (building depressurized); PP = positive pressure (l
- Bold font = detected result; Less-than symbol ("<") = analyte not found at indicated limit; Dash ("-") indicates compound not analyzed.
- INDOOR-1-PP Summa canister sample was re-analyzed to report lower concentrations. This was done by re-running the sample with a large

**TABLE C.2.4: RESULTS FROM ON-SITE GC/MS ANALYSIS**  
**ESTCP Project ER-201119 and ER-201025**  
**Selfridge Air National Guard Base, Michigan**

Sample Date/Time	Description	Matrix	Benzene
			ug/m3
<b>BUILDING 1533</b>			
9/18/2012 8:39	Center of garage	AI	1.1 J
9/18/2012 8:52	Outside, near Summa	AA	0.23 J
9/18/2012 9:07	Center of west wall	AI	4.5
9/18/2012 9:17	Repeat	AI	8.9
9/18/2012 9:32	Repeat	AI	15
9/18/2012 9:56	Repeat	AI	12
9/18/2012 10:10	Outdoors near AA-1	AA	0.25 J
9/18/2012 11:52	Corner near office	AI	U
9/18/2012 13:47	Screening SS-1	SS	6.4
9/18/2012 13:59	Screening SS-2	SS	38
9/18/2012 14:10	Screening SS-3	SS	2.7
9/18/2012 14:49	Repeat SS-3 bag	SS	2.1
9/19/2012 8:55	AA-1 west of building	AA	1.2 J
9/19/2012 9:05	IA-1 southwest corner	AI	6.1
9/19/2012 9:16	Tedlar SS-2	SS	15
9/19/2012 9:27	Repeat IA-1	AI	7
9/19/2012 9:38	At refrigerator opposite corner	AI	9.6
9/19/2012 9:49	Room with SS-2	AI	19
9/19/2012 9:59	Bathroom door cracked	AI	9.6
9/19/2012 10:10	Shop near used oil/workbench	AI	9.9
9/19/2012 11:12	Center of shop after vehicle started briefly	AI	141 JE
9/19/2012 11:35	Tedlar SS-1	SS	4.8
9/19/2012 11:45	IA-2/Shop (near lift)	AI	89
9/19/2012 11:56	Tedlar SS-3	SS	3.5
9/19/2012 12:06	IA-2/Shop (near lift)	AI	58
9/19/2012 13:12	Repeat IA-2	AI	19
9/19/2012 13:25	Inside store room with SS-2	AI	30
9/19/2012 13:36	In front of fan	AI	8
9/19/2012 13:47	Near fridge. Repeat 014	AI	9.6
9/19/2012 14:00	Outside AA-1	AA	0.38 J

**TABLE C.2.4: RESULTS FROM ON-SITE GC/MS ANALYSIS**  
**ESTCP Project ER-201119 and ER-201025**  
**Selfridge Air National Guard Base, Michigan**

Sample Date/Time	Description	Matrix	Benzene
			ug/m3
<b>BUILDING 1533</b>			
9/19/2012 14:13	IA-2	AI	5.1
9/19/2012 14:27	IA2	AI	4.8
9/19/2012 14:46	IA2	AI	U
9/19/2012 15:00	IA2	AI	2
9/19/2012 15:31	IA2	AI	U
9/19/2012 15:48	Across room at fridge	AI	U
9/19/2012 16:01	Above SS-2 room indoor air	AI	8.6
9/19/2012 16:12	IA2	AI	2.6
9/19/2012 16:24	IA2	AI	422 JE

Notes:

1. Samples analyzed using an Inficon HAPSITE ER portable GC/MS instrument. Calibration curve 9/19/2012.
2. Samples are sorted chronologically.
3. J = estimated (result less than lower calibration limit); JE = estimated (result higher than upper calibration limit); U = not detected.
4. Matrix: AI = Indoor air; AA = Ambient (outdoor) air; SS = Sub-slab

**APPENDIX C FIGURES**  
**ESTCP Projects ER-201119 and ER-201025**  
**Selfridge Air National Guard Base, Michigan**

**Figure C.2.1: Site Map**

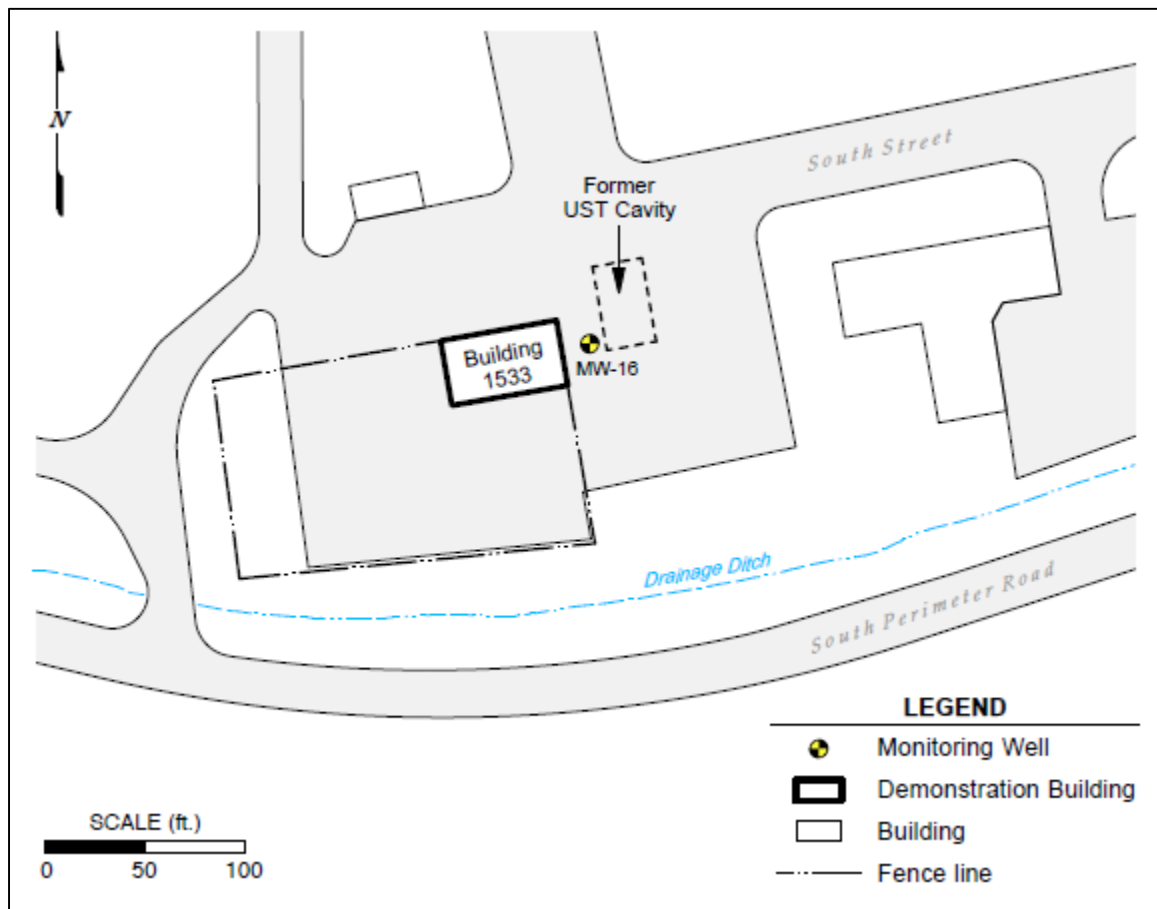

Note: Only monitoring wells sampled for the demonstration are shown.



**APPENDIX C FIGURES**  
**ESTCP Projects ER-201119 and ER-201025**  
**Selfridge Air National Guard Base, Michigan**

**Figure C.2.2: Building 1533 Floorplan**

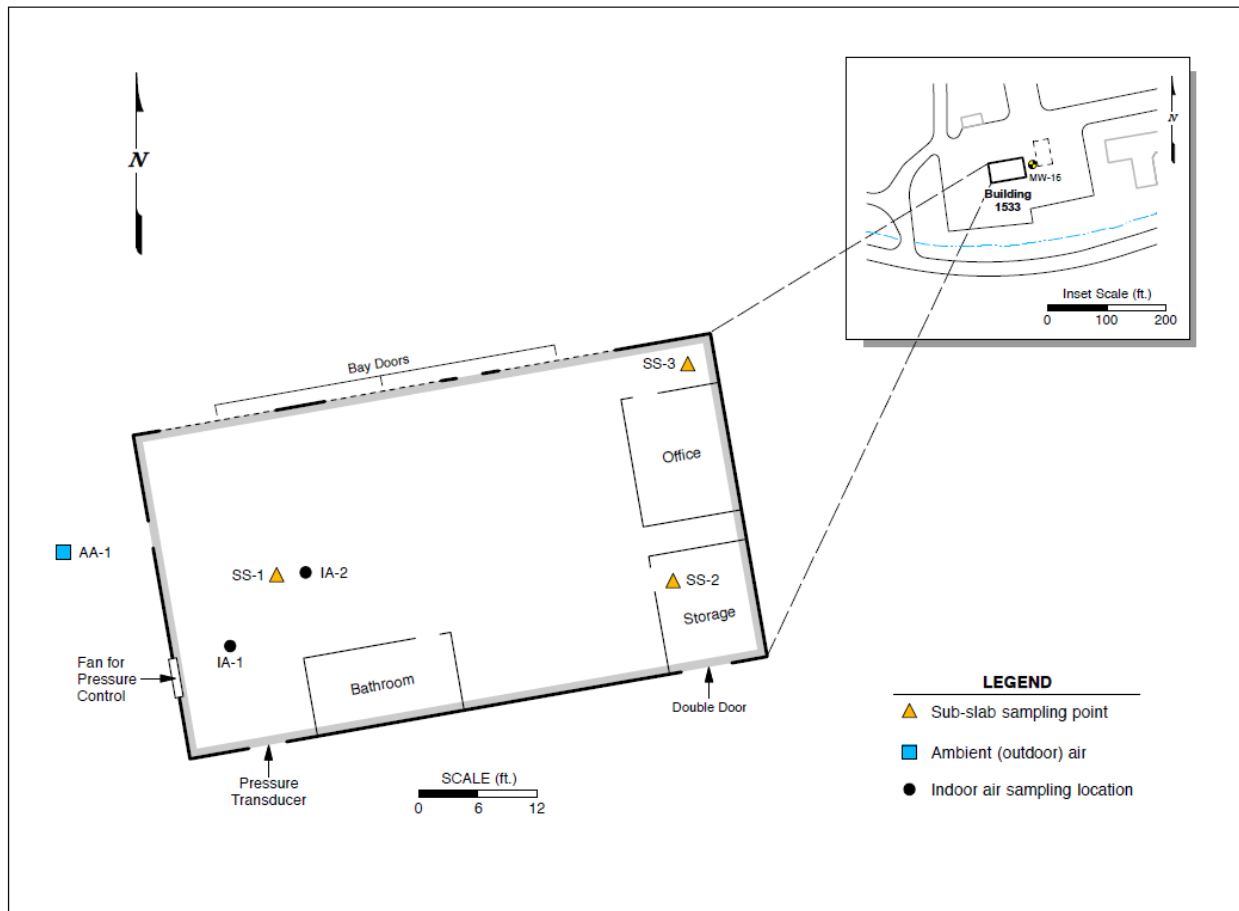

Note: Figure illustrates sample locations for off-site laboratory analysis. HAPSITE sample locations are not shown.

## Appendix C.3: Tyndall Air Force Base, Florida

### **TABLES**

---

Table C.3.1	Results from Conventional Vapor Intrusion Program
Table C.3.2	Results from Isotope Program
Table C.3.3	Results from On-Site Analysis Program Confirmation Samples
Table C.3.4	Results from On-Site GC/MS Analysis

### **FIGURES**

---

Figure C.3.1	Site Map
Figure C.3.2	Building 156 Floorplan
Figure C.3.3	Building 219 Floorplan

**TABLE C.3.1: RESULTS FROM CONVENTIONAL VAPOR INTRUSION PROGRAM**  
 ESTCP Project ER-201119 and ER-201025  
 Tyndall Air Force Base, Florida

	GROUNDWATER	
	MW-5 <sup>1</sup>	MW-20s <sup>1</sup>
Location ID:	SA-150-MW-5	264/280-MW-20s
Field Sample ID:		
Sample Location ID:	North of Building 156	South of Building 219
Description:		
Matrix:	GW	GW
Sample Type:	N	N
Sample Collection Date/Time:	2008	2010
Analytical Method (units):	8260 (ug/L)	8260 (ug/L)
<b>Key Analyte for VI Evaluation</b>		
Trichloroethene	299	6.4
<b>Other Reported Compounds</b>		
Dichloroethene, 1,1- (1,1-DCE)	-	-
Dichloroethene, cis-1,2-	21.4	2200
Dichloroethene, trans-1,2-	-	-
Tetrachloroethene	-	-
Vinyl chloride	-	-

Notes:

1. Groundwater samples were collected as part of normal site investigation/monitoring (i.e., not part of ESTCP VI Study).
2. Bold font = detected result

**TABLE C.3.1: RESULTS FROM CONVENTIONAL VAPOR INTRUSION PROGRAM**  
 ESTCP Project ER-201119 and ER-201025  
 Tyndall Air Force Base, Florida

Location ID:	BUILDING 156 (HANGER)					
Field Sample ID:	156-SS-1	156-SS-2	156-SS-3	156-IA-1	156-IA-2	156-IA-3
Sample Location ID:	1-SS-1	1-SS-2	1-SS-3	1-IA-1	1-IA-2	1-IA-3
Description:	Paired with IA-1	Paired with IA-2	Paired with IA-3	Shop at N side of building	Wood shop in north-central part of building	Paint booth room at NW corner of building
Matrix:	SS	SS	SS	IA	IA	IA
Sample Type:	N	N	N	N	N	N
Sample Collection Date/Time:	2/21/2013	2/21/2013	2/21/2013	2/20/2013	2/20/2013	2/20/2013
Analytical Method (units):	TO-15 SIM (ug/m3)	TO-15 SIM (ug/m3)	TO-15 SIM (ug/m3)	TO-15 SIM (ug/m3)	TO-15 SIM (ug/m3)	TO-15 SIM (ug/m3)
<b>Key Analyte for VI Evaluation</b>						
Trichloroethene	<b>0.37</b>	<b>1.2</b>	<b>24</b>	<0.036	<0.046	<0.041
<b>Other Reported Compounds</b>						
Dichloroethene, 1,1- (1,1-DCE)	<0.032	<0.032	<0.034	<0.036	<0.046	<0.041
Dichloroethene, cis-1,2-	<0.032	<0.032	<b>0.085</b>	<0.036	<0.046	<0.041
Dichloroethene, trans-1,2-	<0.032	<0.032	<b>0.051</b>	<0.036	<0.046	<0.041
Tetrachloroethene	<b>0.26</b>	<b>0.16</b>	<b>0.45</b>	<b>0.054</b>	<b>0.063</b>	<b>0.6</b>
Vinyl chloride	<0.032	<0.032	<0.034	<0.036	<0.046	<0.041

Notes:

- Vapor samples analyzed by ALS/Columbia Analytical Services, Simi Valley, California using USEPA Method TO-15 SIM.
- Sub-slab soil gas collected as grab samples (without flow controller). Indoor and outdoor air sample collected with 8-hour flow controller.
- All samples collected in 6-L Summa canisters.
- Bold font = detected result; Less-than symbol ("<") = analyte not found at indicated limit.
- Ambient air sample 219-AA-1 used for Building 156 and 219.

**TABLE C.3.1: RESULTS FROM CONVENTIONAL VAPOR INTRUSION PROGRAM**  
 ESTCP Project ER-201119 and ER-201025  
 Tyndall Air Force Base, Florida

Location ID:	BUILDING 219 (OFFICE)					
Field Sample ID:	219-SS-1	219-SS-2	219-SS-3	219-IA-1	219-IA-3	219-AA-1
Sample Location ID:	2-SS-1	2-SS-2	2-SS-3	2-IA-1	2-IA-3	2-AA-1
Sample Location Description:	Paired with IA-1	Center of building	Paired with IA-3	Southern half of building in central hallway	Northern half of building in janitor closet	Outside southwest entrance
Matrix:	SS	SS	SS	IA	IA	AA
Sample Type:	N	N	N	N	N	N
Sample Collection Date/Time:	2/21/2013	2/21/2013	2/21/2013	2/20/2013	2/20/2013	2/20/2013
Analytical Method (units):	TO-15 SIM (ug/m3)	TO-15 SIM (ug/m3)	TO-15 SIM (ug/m3)	TO-15 SIM (ug/m3)	TO-15 SIM (ug/m3)	TO-15 SIM (ug/m3)
<b>Key Analyte for VI Evaluation</b>						
Trichloroethene	<b>0.083</b>	<b>0.31</b>	<b>1.3</b>	<b>0.086</b>	<b>0.087</b>	<0.039
<b>Other Reported Compounds</b>						
Dichloroethene, 1,1- (1,1-DCE)	<0.032	<0.13	<0.063	<0.039	<0.041	<0.039
Dichloroethene, cis-1,2-	<0.032	<0.13	<0.063	<0.039	<0.041	<0.039
Dichloroethene, trans-1,2-	<b>0.14</b>	<b>0.41</b>	<0.063	<0.039	<0.041	<0.039
Tetrachloroethene	<b>4.5</b>	<b>7.5</b>	<b>0.97</b>	<b>0.048</b>	<0.041	<0.039
Vinyl chloride	<0.032	<0.13	<0.063	<0.039	<0.041	<0.039

Notes:

1. Vapor samples analyzed by ALS/Columbia Analytical Services, Simi Valley, California using USEPA Method TO-15 SIM.
2. Sub-slab soil gas collected as grab samples (without flow controller). Indoor and outdoor air sample collected with 8-hour flow controller.
3. All samples collected in 6-L Summa canisters.
4. Bold font = detected result; Less-than symbol ("<") = analyte not found at indicated limit.
5. Ambient air sample 219-AA-1 used for Building 156 and 219.

**TABLE C.3.2: RESULTS FROM ISOTOPE PROGRAM**  
**ESTCP Project ER-201119 and ER-201025**  
**Tyndall Air Force Base, Florida**

Location ID:	BUILDING 156 (HANGER)		BUILDING 219 (OFFICE)			
	Field Sample ID:	156-SS-3	MW-20s	219-SS-3	219-IA-3 P1	219-IA-3-P2
Sample Location ID:	MW-5	1-SS-3	MW-20s	2-SS-3	2-IA-3	2-IA-3
Description:	North of Building 156	Paired with IA-3	South of building	Paired with IA-3 (sample collected approx 9 hours after planted source was removed)	Northern half of building in janitor closet (planted source)	Northern half of building in janitor closet (planted source)
Matrix:	GW	SS	GW	SS	IA	IA
Sample Type:	N	N	N	N	N	FD
Sample Collection Date/Time:	2/22/2013 12:10	2/21/2013 13:49	2/22/2013 12:30	2/22/2013 8:26	2/21/2013 8:00	2/21/2013 8:00
Analytical Method (units):	TCE C/CI (per mil)	TCE C/CI (per mil)	TCE C/CI (per mil)	TCE C/CI (per mil)	TCE C/CI (per mil)	TCE C/CI (per mil)
<b>Analyte</b>						
d13C TCE	<b>13.8 H</b>	<b>-9.6 H</b>	<b>-18.4 H</b>	<b>-1.9 H</b>	<b>-29 H</b>	<b>-28.8 H</b>
d37Cl TCE	<b>10.1</b>	<b>6.3 H</b>	<b>4.7</b>	<b>6.3 H</b>	<b>-3.5 H</b>	<b>-3.2 H</b>

Notes:

1. Isotope analysis was completed by the University of Oklahoma.
2. Bold font = detected result  
 H = samples analyzed outside of validated holding time period of 2 weeks
3. Indoor air TCE concentrations were too low in Building 156 and 219 to allow collection of sufficient mass for isotope analysis. An indoor VOC source was planted in Building 219 for evaluation in ESTCP Project ER-201025.

**TABLE C.3.3: RESULTS FROM ON-SITE ANALYSIS PROGRAM CONFIRMATION SAMPLES**  
 ESTCP Project ER-201119 and ER-201025  
 Tyndall Air Force Base, Florida

Location ID:	BUILDING 156 (HANGER)			
Sample Location ID:	156-IA-4	156-IA-4	156-IA-5	156-AA-1
Description:	Small room adjacent to wood shop	Small room adjacent to wood shop	Small room adjacent to wood shop	Outdoors, north of Building 156
Matrix:	IA	IA	IA	AA
Field Sample ID:	156-IA-4-BL	156-IA-4-NP	156-IA-5-NP	156-AA-1
Pressure Condition:	BL	NP	NP	BL
Sample Type:	N	N	FD	N
Sample Collection Date/Time:	2/22/13 8:04	2/21/13 16:05	2/21/13 16:05	2/21/13 16:05
Analytical Method (units):	TO-15 SIM (ug/m3)	TO-15 SIM (ug/m3)	TO-15 SIM (ug/m3)	TO-15 SIM (ug/m3)
<b>Key Analyte for VI Evaluation</b>				
Trichloroethene	<0.032	<0.031	<0.033	-
<b>Other Reported Compounds</b>				
Dichloroethene, 1,1- (1,1-DCE)	<0.032	<0.031	<0.033	-
Dichloroethene, cis-1,2-	<0.032	<0.031	<0.033	-
Dichloroethene, trans-1,2-	<0.032	<0.031	<0.033	-
Tetrachloroethene	<b>0.077</b>	<b>0.061</b>	<b>0.062</b>	-
Vinyl chloride	<0.032	<0.031	<0.033	-
<b>Radon (pCi/L)</b>				
Radon	<b>0.07</b>	U	-	<b>0.03</b>

Notes:

- VOC analysis by ALS/Columbia Analytical Services, Simi Valley, California using USEPA Method TO-15 SIM.
- Samples for VOC analysis were collected in 6-L Summa canisters without flow controllers.
- Radon analysis by the University of Southern California.
- Samples for radon analysis were collected in 1-L Tedlar bags.
- Bold font = detected result; Less-than symbol ("<") = analyte not found at indicated limit.
- BL = Baseline (uncontrolled) conditions; NP = Negative Pressure induced in building.

**TABLE C.3.4: RESULTS FROM ON-SITE GC/MS ANALYSIS**  
**ESTCP Project ER-201119 and ER-201025**  
**Tyndall Air Force Base, Florida**

Sample Date/Time	Description	Matrix	TCE
			ug/m3
<b>SCREENING SAMPLES</b>			
2/19/2013 11:03	Building 246 Tedlar bag screening sample (indoor air)	AI	0.21 J
2/19/2013 11:11	Building 258 Tedlar bag screening sample (indoor air)	AI	0.32 J
2/19/2013 11:20	Building 522 Tedlar bag screening sample (indoor air)	AI	0.19 J
2/19/2013 11:30	Building 560 Tedlar bag screening sample (indoor air)	AI	U
<b>BUILDING 156 (HANGER)</b>			
2/19/2013 10:37	Building 156 north end, Tedlar bag screening sample (indoor air)	AI	0.19 J
2/19/2013 10:46	Building 156 south end, Tedlar bag screening sample (indoor air)	AI	U
2/20/2013 13:47	Building 156 NW work shop	AI	0.2 J
2/20/2013 13:57	Building 156 floor grate, N of NW workshop	AI	0.11 J
2/20/2013 14:06	Building 156 wood shop	AI	0.15 J
2/20/2013 14:15	Building 156 painting room	AI	0.11 J
2/21/2013 9:11	Building 156 small room adjacent to wood shop	AI	U
2/21/2013 10:32	Building 156 156-SS-3	SS	23
2/21/2013 10:40	Building 156 156-SS-2	SS	8.1
2/21/2013 10:48	Building 156 156-SS-1	SS	1.6 J
2/21/2013 14:27	Building 156 small room adjacent to wood shop	AI	U
2/21/2013 14:35	Building 156 small room adjacent to wood shop	AI	0.14 J
2/21/2013 15:09	Building 156 painting room	AI	0.081 J
2/21/2013 15:17	Building 156 small room adjacent to wood shop	AI	U
2/21/2013 15:37	Building 156 small room adjacent to wood shop	AI	0.086 J
2/21/2013 15:47	Building 156 painting room	AI	0.086 J
2/21/2013 15:56	Building 156 small room adjacent to wood shop	AI	U
<b>BUILDING 219</b>			
2/19/2013 10:54	Building 219 Tedlar bag screening sample (indoor air)	AI	0.18 J
2/20/2013 9:21	Building 219 hallway, south end	AI	0.26 J
2/20/2013 9:31	Building 219 hallway, center	AI	0.14 J
2/20/2013 9:40	Building 219 hallway, north end	AI	0.12 J
2/20/2013 10:02	Building 219 south end of hallway, under the door to secure area	AI	0.38 J
2/21/2013 7:55	Building 219 Outside front door of building	AA	0.18 J
2/21/2013 8:07	Building 219 Intersection of front door hallway and main hallway	AI	0.34 J
2/21/2013 8:15	Building 219 Hallway, in front of janitor's closet	AI	1 J



**TABLE C.3.4: RESULTS FROM ON-SITE GC/MS ANALYSIS**  
**ESTCP Project ER-201119 and ER-201025**  
**Tyndall Air Force Base, Florida**

Sample Date/Time	Description	Matrix	TCE
			ug/m3
2/21/2013 8:23	Building 219 with tube, beneath door of janitor's closet	AI	54
2/21/2013 8:33	Building 219 main hallway, around corner of janitor's closer	AI	0.81 J
2/21/2013 14:45	Building 219 South end of building, 219-SS-1	SS	0.27 J
2/21/2013 14:53	Building 219 Building Center, 219-SS-2	SS	0.54 J
2/21/2013 15:01	Building 219 Janitor's closet at north end, 219-SS-3	SS	4.9

Notes:

1. Samples analyzed using a HAPSITE SMART portable GC/MS instrument. Calibration curve 2/19/2013.
2. Samples are grouped by building, and sorted chronologically.
3. J = estimated (result less than lower calibration limit); U = not detected.
4. Matrix: AI = Indoor air; AA = Ambient (outdoor) air; SS = Sub-slab

**APPENDIX C FIGURES**  
**ESTCP Projects ER-201119 and ER-201025**  
**Tyndall Air Force Base, Florida**

**Figure C.3.1: Site Map**

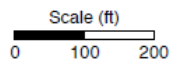
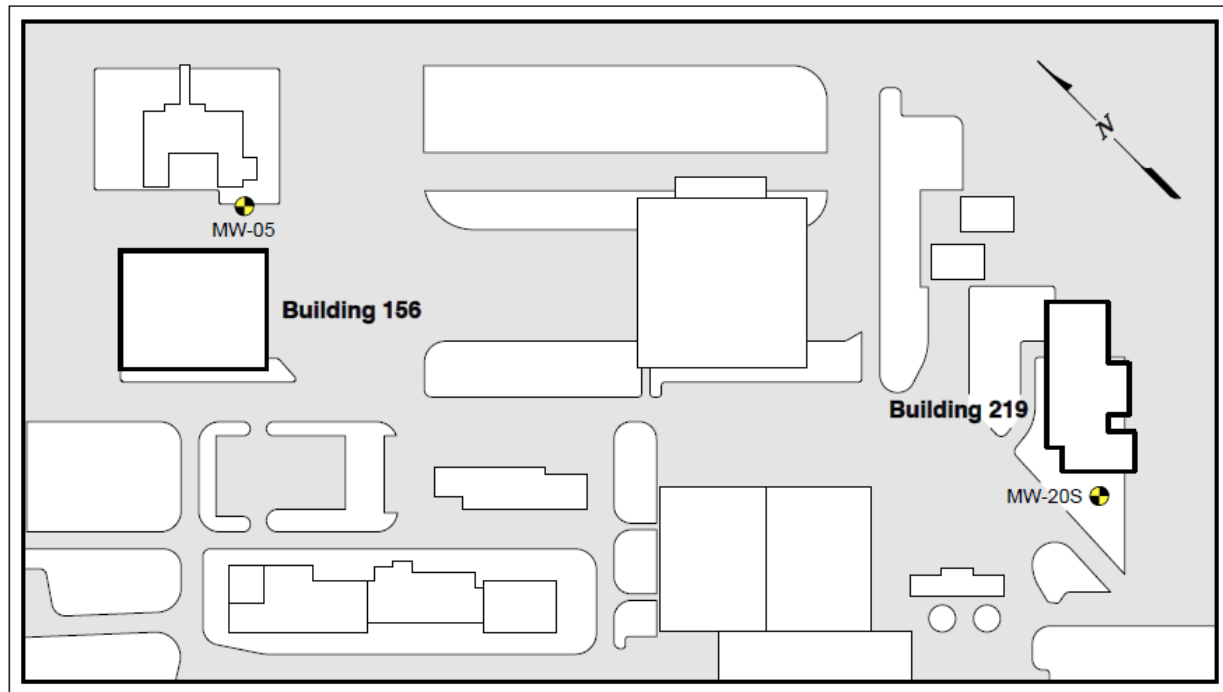

Note: Only monitoring wells sampled for the demonstration are shown.

**APPENDIX C FIGURES**  
**ESTCP Projects ER-201119 and ER-201025**  
**Tyndall Air Force Base, Florida**

**Figure C.3.2: Building 156 Floorplan**

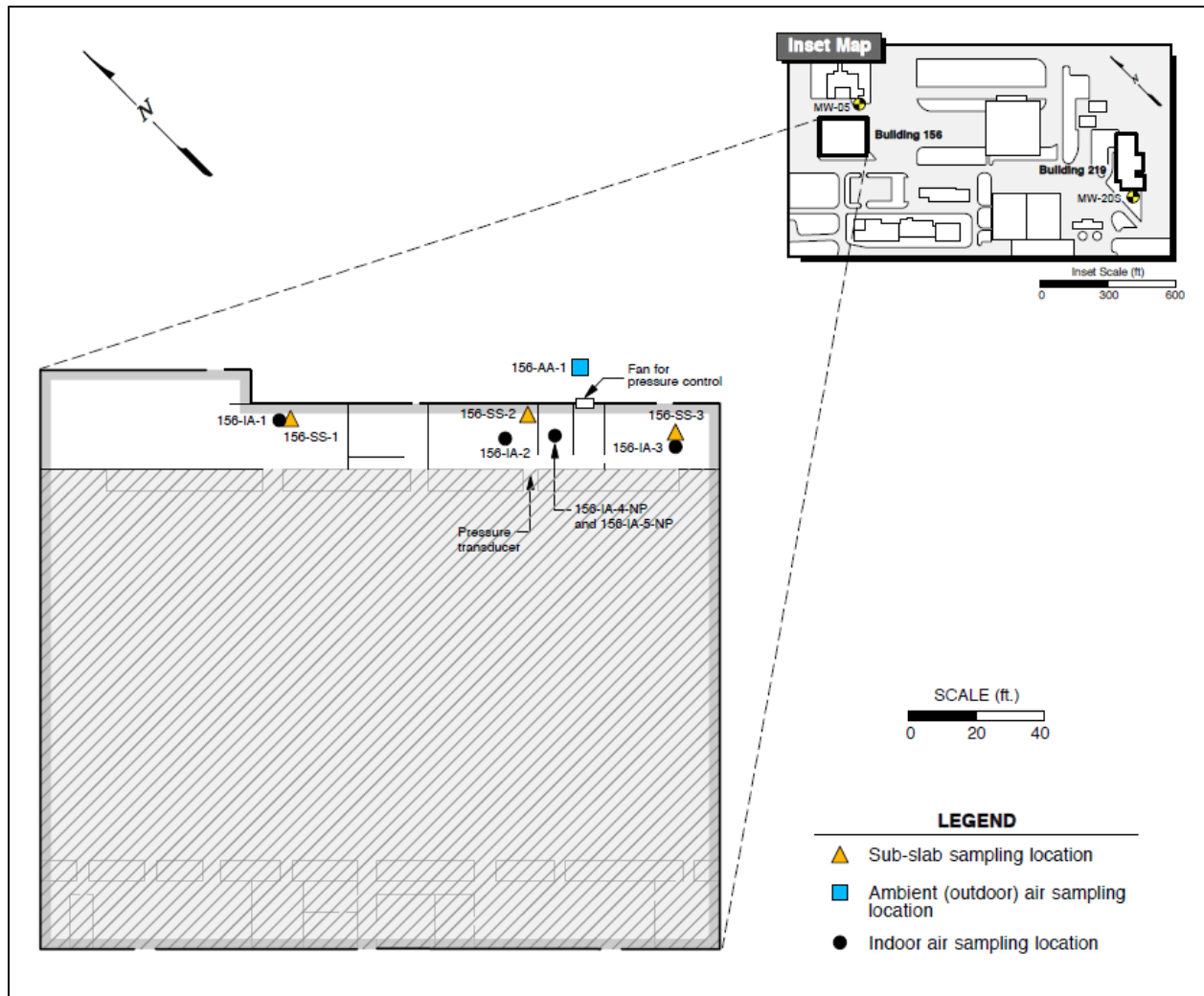

Note: Figure illustrates sample locations for off-site laboratory analysis. HAPSITE sample locations are not shown.

**APPENDIX C FIGURES**  
**ESTCP Projects ER-201119 and ER-201025**  
**Tyndall Air Force Base, Florida**

**Figure C.3.3: Building 219 Floorplan**

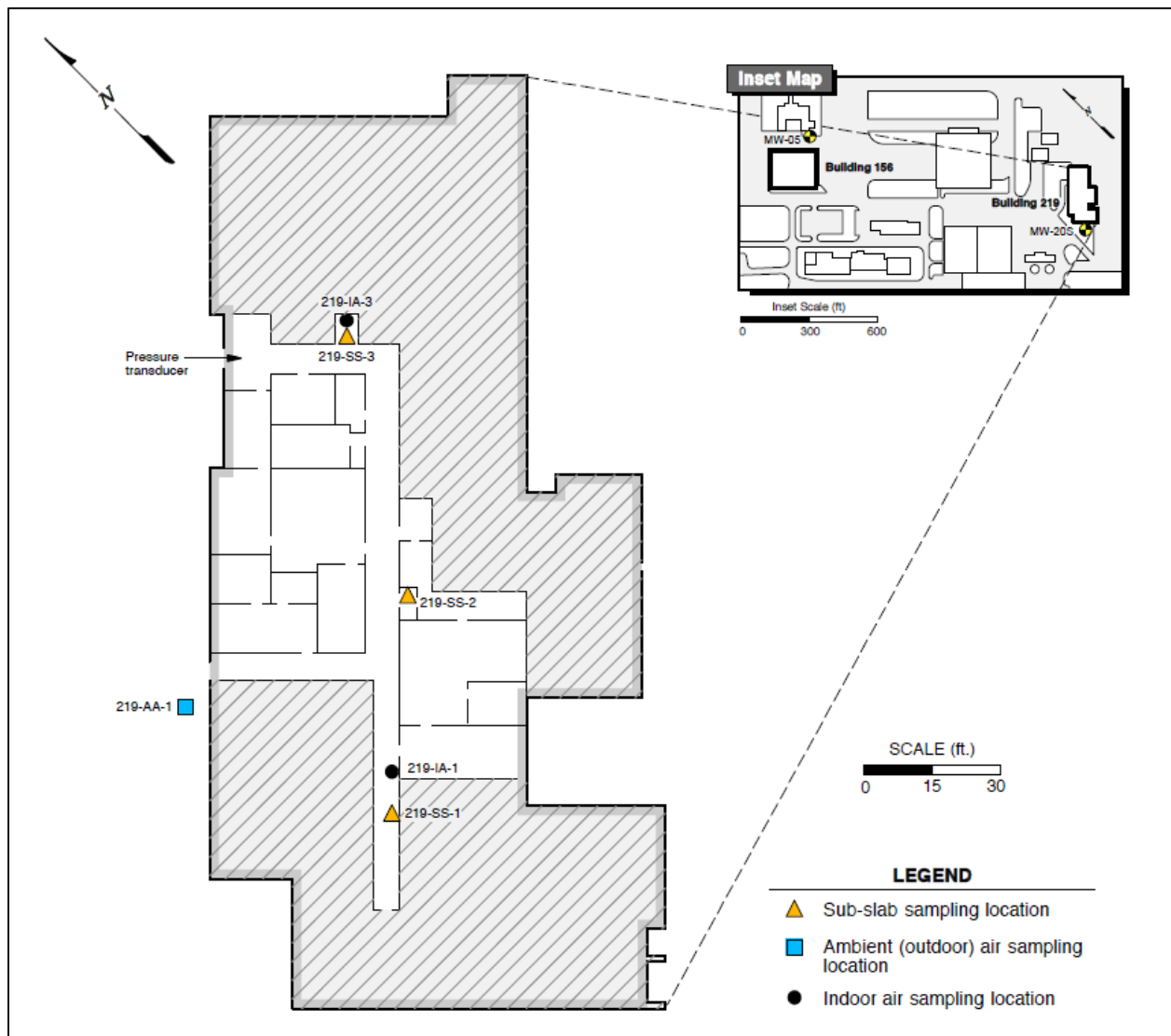

Note: Figure illustrates sample locations for off-site laboratory analysis. HAPSITE sample locations are not shown.

## **Appendix C.4: Former Raritan Arsenal Site, New Jersey**

### **TABLES**

---

Table C.4.1	Results from Conventional Vapor Intrusion Program
Table C.4.2	Results from Isotope Program
Table C.4.3	Results from On-Site Analysis Program Confirmation Samples
Table C.4.4	Results from On-Site GC/MS Analysis

### **FIGURES**

---

Figure C.4.1	Site Map
Figure C.4.2	Building CP4 Floorplan
Figure C.4.3	Building 209 Floorplan

**TABLE C.4.1 RESULTS FROM CONVENTIONAL VAPOR INTRUSION PROGRAM**  
 ESTCP Project ER-201119 and ER-201025  
 Former Raritan Arsenal Site, New Jersey

Location ID:	GROUNDWATER			
Field Sample ID:	MW-CP-IV-1 <sup>3</sup>	MW-139 <sup>3</sup>	MW-136 <sup>3</sup>	MW-156 <sup>3</sup>
Sample Location ID:	MW-CP-IV-1	MW-139	MW-136	MW-156
Description:	Well located north of CP4 building	Well located west of CP4 building	Well located north of Building 209	Well located northeast of Building 209
Matrix:	GW	GW	GW	GW
Sample Type:	N	N	N	N
Sample Collection Date:	5/23/2012	5/23/2012	5/22/2012	5/22/2012
Analytical Method (units):	TO-15 SIM (ug/m3)	TO-15 SIM (ug/m3)	TO-15 SIM (ug/m3)	TO-15 SIM (ug/m3)
<b>Key Analyte for VI Evaluation</b>				
Trichloroethene	7.6	120	39	240
<b>Other Reported Compounds</b>				
Dichloroethene, 1,1- (1,1-DCE)	<0.09	1	<0.09	0.28 J
Dichloroethene, cis-1,2-	1.5	91	<0.18	3.6
Dichloroethene, trans-1,2-	<0.13	0.79 J	<0.13	0.41 J
Tetrachloroethene	0.71 J	5.7	<0.1	<0.1
Vinyl chloride	<0.14	24	<0.14	<0.14

Notes:

1. Bold font = detected result; "<" = not detected above detection limit
2. J = The result is an estimated concentration that is less than the MRL but greater than or equal to the MDL.
3. Results from May 2012 groundwater monitoring event were provided by site personnel. VOC analysis of groundwater samples was not conducted as part of the ESTCP VI study.

**TABLE C.4.1 RESULTS FROM CONVENTIONAL VAPOR INTRUSION PROGRAM**  
 ESTCP Project ER-201119 and ER-201025  
 Former Raritan Arsenal Site, New Jersey

Location ID:	BUILDING 209				
Field Sample ID:	209-SG-09	209-SG-06	209-IA-09	209-IA-10	209-AA-1
Sample Location ID:	2-SS-1	2-SS-2	2-IA-1	2-IA-2	2-AA-1
Description:	Permanent point in Room L306 Organic Prep/TCLP Extraction Lab	Permanent point in Bay D	Paired with permanent subslab point 209-SG-09	Opposite end of Bay C	North of entrance
Matrix:	SS	SS	IA	IA	AA
Sample Type:	N	N	N	N	N
Sample Collection Date/Time:	3/27/2013 10:00	3/27/2013 10:50	3/27/2013 16:09	3/27/2013 16:08	3/27/2013 16:10
Analytical Method (units):	TO-15 SIM (ug/m3)	TO-15 SIM (ug/m3)	TO-15 SIM (ug/m3)	TO-15 SIM (ug/m3)	TO-15 SIM (ug/m3)
<b>Key Analyte for VI Evaluation</b>					
Trichloroethene	8.1	0.55	<0.05	0.064	0.017 J
<b>Other Reported Compounds</b>					
Dichloroethene, 1,1- (1,1-DCE)	0.05 J	0.028 J	0.063 J	<0.0053	<0.0051
Dichloroethene, cis-1,2-	<0.07	<0.014	<0.084	<0.017	<0.016
Dichloroethene, trans-1,2-	<0.079	<0.016	<0.094	<0.019	<0.018
Tetrachloroethene	6.4	13	0.073 J	0.058	0.042
Vinyl chloride	<0.018	<0.0036	<0.021	<0.0043	<0.0041

Notes:

1. "<" = not detected above method detection limit
2. J = The result is an estimated concentration that is less than the MRL but greater than or equal to the MDL.
3. D = The reported result is from a dilution.

**TABLE C.4.1 RESULTS FROM CONVENTIONAL VAPOR INTRUSION PROGRAM**  
**ESTCP Project ER-201119 and ER-201025**  
**Former Raritan Arsenal Site, New Jersey**

Location ID:	BUILDING CP4				
Field Sample ID:	CP4-SG-6	CP4-SG-3	CP4-IA-1	CP4-IA-2	CP4-AA-1
Sample Location ID:	1-SS-1	1-SS-3	1-IA-1	1-IA-2	1-AA-1
Description:	Permanent point in Warehouse 1 on west side closest to offices	Permanent point in 280 Raritan	At end of the hall in the engineering section, on top of cabinet	In financial services area, on cubicle cabinet	Outside back door
Matrix:	SS	SS	IA	IA	AA
Sample Type:	N	N	N	N	N
Sample Collection Date/Time:	3/26/2013 15:00	3/26/2013 9:00	3/26/2013 16:44	3/26/2013 16:45	3/26/2013 16:42
Analytical Method (units):	TO-15 SIM (ug/m3)	TO-15 SIM (ug/m3)	TO-15 SIM (ug/m3)	TO-15 SIM (ug/m3)	TO-15 SIM (ug/m3)
<b>Key Analyte for VI Evaluation</b>					
Trichloroethene	15	93 D	1.3	2.1	0.057
<b>Other Reported Compounds</b>					
Dichloroethene, 1,1- (1,1-DCE)	<0.0042	<0.0042	<0.0055	<0.0044	<0.005
Dichloroethene, cis-1,2-	0.014 J	1.1	<0.017	<0.014	<0.016
Dichloroethene, trans-1,2-	0.023 J	0.3	<0.019	0.018 J	<0.018
Tetrachloroethene	7.3	12	0.3	0.27	0.096
Vinyl chloride	<0.0034	<0.0034	<0.0044	<0.0036	<0.004

Notes:

1. "<" = not detected above method detection limit
2. J = The result is an estimated concentration that is less than the MRL but greater than or equal to the MDL.
3. D = The reported result is from a dilution.



**TABLE C.4.2: RESULTS FROM ISOTOPE PROGRAM**  
**ESTCP Project ER-201119 and ER-201025**  
**Former Raritan Arsenal Site, New Jersey**

Location ID:		CAMPUS PLAZA 4				
Description:	MW-139	MW-CP-IV-1	Permanent point; Warehouse 1 on west side closest to offices.	In 1st conference room wall behind ethernet outlet	In kitchen between conference rooms	In kitchen between conference rooms
Matrix:	GW	GW	SS	IA	IA	IA
Field Sample ID:	MW-139	MW-CP-IV-1	CP4-SG-6	CP4-IA-3	CP4-IA-4B	CP4-IA-4
Sample Type:	N	N	N	N	N	FD
Sample Collection Date/Time:	3/28/2013	3/28/2013	3/28/2013 12:12	3/27/2013 9:05	3/28/2013 9:45	3/27/2012 9:05
Analytical Method (units):	TCE C/CI (per mil)	TCE C/CI (per mil)	TCE C/CI (per mil)	TCE C/CI (per mil)	TCE C/CI (per mil)	TCE C/CI (per mil)
<b>Analyte</b>						
d13C TCE	-16.5	-20.9	-5.4	-31.2	-30.5	-30.9
d37Cl TCE	4.6	3.1	3.4	-1.3	0.1	-0.4

Location ID:		BUILDING 209	
Description:	MW-136	MW-156	Permanent point; in Room L306 Organic Prep/TCLP Extraction Lab
Matrix:	GW	GW	SS
Field Sample ID:	MW-136	MW-156	209-SG-09
Sample Type:	N	N	N
Sample Collection Date/Time:	3/28/2013	3/28/2013	3/27/2013 15:30
Analytical Method (units):	TCE C/CI (per mil)	TCE C/CI (per mil)	TCE C/CI (per mil)
<b>Analyte</b>			
d13C TCE	-22.2	-25.3	-10.6
d37Cl TCE	1.5	1.9	3.3

Notes:

1. Isotope analysis was completed by the University of Oklahoma.
2. Bold font = detected result

**TABLE C.4.3: RESULTS FROM ON-SITE ANALYSIS PROGRAM CONFIRMATION SAMPLES**  
 ESTCP Project ER-201119 and ER-201025  
 Former Raritan Arsenal Site, New Jersey

Location ID:	BUILDING CP4				
	CP4-IA-3	CP4-IA-5-BL	CP4-IA-5-NP	CP4-IA-5-NP	CP1-AA-2
Field Sample ID:	1-IA-3	1-IA-5	1-IA-5	1-IA-5	1-AA-2
Sample Location ID:	1-IA-3	1-IA-5	1-IA-5	1-IA-5	1-AA-2
Description:	In 1st conference room wall behind ethernet outlet	Warehouse 1	Warehouse 1	Warehouse 1	Behind warehouse
Matrix:	IA	IA	IA	IA	AA
Pressure Condition:	BL	BL	NP	NP	BL
Sample Type:	N	N	N	FD	N
Sample Collection Date/Time:	3/26/2013 16:30	3/28/2013 8:45	3/28/2013 11:05	3/28/2013 11:05	3/28/2013 8:50
Analytical Method (units):	TO-15 SIM (ug/m3)	TO-15 SIM (ug/m3)	TO-15 SIM (ug/m3)	TO-15 SIM (ug/m3)	TO-15 SIM (ug/m3)
<b>Key Analyte for VI Evaluation</b>					
Trichloroethene	2.4	0.43	0.32	0.33	-
<b>Other Reported Compounds</b>					
Dichloroethene, 1,1- (1,1-DCE)	<0.0039	<0.0037	<0.019	<0.019	-
Dichloroethene, cis-1,2-	<0.012	<0.012	<0.061	<0.059	-
Dichloroethene, trans-1,2-	<0.014	<b>0.041</b>	<0.069	<b>0.25</b>	-
Tetrachloroethene	<b>0.16</b>	<b>0.066</b>	<b>0.097 J</b>	<b>0.17</b>	-
Vinyl chloride	<0.0032	<0.003	<0.016	<0.015	-
<b>Radon (pCi/L)</b>					
Radon	-	<b>0.23</b>	<b>0.11</b>	<b>0.15</b>	<b>0.03</b>

Notes:

- VOC analysis of vapor samples by ALS/Columbia Analytical Services, Simi Valley, California. Radon analysis by University of Southern California.
- Samples collected as grab (i.e., without flow controller). Samples for VOC analysis were collected in 6-L Summa canisters. Samples for Radon analysis were collected in 1-L Tedlar bags.
- Pressure Condition: BL = baseline (uncontrolled); NP = negative pressure (building depressurized).
- Bold font = detected result; Less-than symbol ("<") = analyte not found at indicated limit; J-flag ("J") indicates the result is an estimated concentration that is less than the method reporting limit but greater than or equal to the method detection limit. Dash ("-") indicates compound not analyzed.

**TABLE C.4.4: RESULTS FROM ON-SITE GC/MS ANALYSIS**  
**ESTCP Project ER-201119 and ER-201025**  
**Former Raritan Arsenal Site, New Jersey**

Sample Date/Time	Description	Matrix	PCE	TCE
			ug/m3	ug/m3
<b>SCREENING SAMPLES</b>				
3/25/2013 8:59	274 Raritan (bag)	AI	0.26 J	U
3/25/2013 9:08	280 Raritan (bag)	AI	0.24 J	0.81 J
3/25/2013 9:32	278/284 Raritan (bag). Odors in building (equipment cleaned recently?)	AI	0.26 J	U
3/25/2013 9:51	Re-run 280 Raritan bag	AI	0.34 J	1.1 J
3/25/2013 9:59	Re-run 280 Raritan bag (duplicate)	AI	0.29 J	1.1 J
3/25/2013 10:27	Bldg 209 Bay A (bag)	AI	0.25 J	U
3/25/2013 10:35	Bldg 209 Bay B (bag)	AI	0.24 J	U
3/25/2013 10:43	Bldg 209 Bay C (bag)	AI	0.48 J	U
3/25/2013 11:35	Bldg 209 Bay D (bag) - retry	AI	0.37 J	U
3/25/2013 11:43	Bldg 209 Bay E (bag)	AI	0.37 J	U
3/25/2013 11:51	Bldg 209 Bay F (bag)	AI	0.25 J	U
<b>BUILDING CP4</b>				
3/25/2013 8:21	300 Raritan CPIV conference room	AI	0.34 J	6.4
3/25/2013 8:52	Repeat 300 Raritan CPIV conference room. Sampled with probe	AI	0.2 J	4.7
3/25/2013 9:16	300 Raritan Warehouse (bag), sample collected near spray cans	AI	0.24 J	0.52 J
3/25/2013 9:24	300 Raritan Warehouse 2 (bag)	AI	0.25 J	0.86 J
3/25/2013 10:11	repeat 300 Raritan CPIV conference room. Sampled with probe	AI	0.24 J	6.4
3/25/2013 11:01	CPIV conference room air, repeat	AI	0.26 J	5.9
3/25/2013 11:27	Repeat conference room (after restart, autotune, conc cleanout)	AI	0.23 J	6.4
3/26/2013 8:30	conference room air, sampled with probe	AI	0.22 J	3.3
3/26/2013 9:12	280 Raritan (bag)	AI	0.18 J	0.97 J
3/26/2013 9:20	280 Raritan Subslab (CP4-SG-3)	SS	8.1	91
3/26/2013 9:49	conference room	AI	0.24 J	3
3/26/2013 9:58	300-1 (bag)	AI	0.39 J	3
3/26/2013 10:06	300-2 (bag)	AI	0.29 J	2.3 J
3/26/2013 10:14	300-3 (bag)	AI	0.35 J	2 J
3/26/2013 10:48	conference room (after reboot)	AI	0.24 J	3.4
3/26/2013 10:56	retry 300-4 (bag)	AI	0.26 J	2.4 J
3/26/2013 11:06	300-5 (bag)	AI	0.38 J	2.8
3/26/2013 11:14	300-6 (bag)	AI	0.24 J	1.1 J
3/26/2013 11:25	300-7 (bag)	AI	0.31 J	3.9
3/26/2013 11:33	300-8 (bag)	AI	0.28 J	3.7
3/26/2013 11:42	conference room air, sampled with probe	AI	0.23 J	3.2
3/26/2013 11:59	Outdoor air at AA-1 (bag)	AA	U	U
3/26/2013 12:13	conference room kitchen (bag)	AI	0.28 J	3.3
3/26/2013 12:26	janitorial closet (bag)	AI	0.32 J	3.3
3/26/2013 12:34	mail room 1 (bag)	AI	0.3 J	4
3/26/2013 12:42	mail room 2 (bag)	AI	0.29 J	3
3/26/2013 13:07	Conference room, sampled with probe	AI	0.25 J	3.1
3/26/2013 14:03	Conference room, before reboot	AI	0.27 J	3.7
3/26/2013 14:21	Repeat conference room after reboot	AI	0.26 J	3.5
3/26/2013 14:29	Men's room off central hallway (bag)	AI	0.29 J	2.7
3/26/2013 14:38	Women's room off central hallway (bag). Strong perfume/air freshener odors.	AI	0.29 J	2.6 J
3/26/2013 14:58	Hallway outside conference room	AI	0.27 J	3.3
3/26/2013 15:10	300-7 location sampled with probe (M/W restroom near conference rooms)	AI	0.26 J	3.3
3/26/2013 15:18	300-9 pass-through hall between conference room 1 and mailroom. Sampled with probe.	AI	0.26 J	3.1
3/26/2013 15:26	Upstairs composite (bag)	AI	0.28 J	2.8
3/26/2013 15:39	Vent in ceiling of conference room (bag)	AI	0.35 J	3.5
3/26/2013 15:47	Warehouse 1 (bag)	AI	0.29 J	1.7 J
3/26/2013 15:56	In wall, behind ethernet/outlet cover. Sampled with probe.	AI	0.25 J	11
3/26/2013 16:09	Plumbing wall gap under bathroom sink by 300-7	AI	0.27 J	3
3/26/2013 16:17	Wall outlet near 300-1	AI	0.28 J	3.1
3/26/2013 16:25	Wall outlet outside Conference Room 1	AI	0.26 J	3
3/26/2013 16:33	resample ethernet/wall outlet (same as run 38 location). Collected after Summa/grab sample CP4-IA-3.	AI	0.27 J	4

**TABLE C.4.4: RESULTS FROM ON-SITE GC/MS ANALYSIS**  
**ESTCP Project ER-201119 and ER-201025**  
**Former Raritan Arsenal Site, New Jersey**

Sample Date/Time	Description	Matrix	PCE	TCE
			ug/m3	ug/m3
3/26/2013 17:23	CP4-SG-2 screening (bag)	SS	2.3 J	24
3/26/2013 17:57	CP4-SG-6 (bag)	SS	7.5	20
3/28/2013 8:16	BL; warehouse near Omniguard	AI	U	0.86 J
3/28/2013 8:25	Center of Warehouse 2	AI	U	1.1 J
3/28/2013 8:32	Warehouse 1 north end, near building materials storage	AI	U	0.91 J
3/28/2013 8:44	End of BL; Warehouse 1, paired with CP4-IA-5-BL summa and radon	AI	U	0.81 J
3/28/2013 9:11	NP; Repeat Run 4 location, fan on 10 minutes	AI	U	0.75 J
3/28/2013 9:18	NP; Inside hallway leading to offices; fan on 15 minutes	AI	U	0.54 J
3/28/2013 9:28	NP; Run 4 location; sample collected after bay door opened and closed for delivery	AI	U	0.49 J
3/28/2013 9:39	NP; Warehouse 1 center (same location as Run 7)	AI	U	0.48 J
3/28/2013 9:47	NP; inside door/hall (same as Run 9 location)	AI	U	0.5 J
3/28/2013 10:16	NP; Warehouse 1 at Run 4 location. Fan on 70 min.	AI	U	0.49 J
3/28/2013 10:24	NP; resample Warehouse 2 run 5 location	AI	U	0.54 J
3/28/2013 10:34	NP; sub-slab, sampled with 3/8" tubing inserted in gap at expansion joint	SS	0.81 J	7
3/28/2013 10:42	NP; indoor air above crack sampled in run 16	AI	U	0.45 J
3/28/2013 10:52	NP; slab expansion joint sampled through tubing	SS	0.22 J	1.4 J
3/28/2013 11:03	NP; last NP sample, paired with summa/teclor and dups CP4-IA-5-NP and DUP-1	AI	U	0.59 J
3/28/2013 11:13	Conference room kitchen (bag). Sample collected into Tedlar bag approx 10:00	AI	0.88 J	2.2 J
3/28/2013 11:21	BL. Repeat run 4 location	AI	U	0.46 J
3/28/2013 11:59	BL; resample crack (run 16 location)	SS	1.2 J	9.1
3/28/2013 12:07	BL; resample indoor air above crack	AI	U	0.75 J
3/28/2013 12:16	Outdoors behind warehouse	AA	U	0.45 J
<b>BUILDING 209</b>				
3/27/2013 8:31	Hall outside EPA/ESAT Balance and Drying Oven Lab	AI	U	U
3/27/2013 8:46	In hall by copy machine (across from Summa canister 209-IA-10)	AI	U	U
3/27/2013 8:59	Store room on south end	AI	U	U
3/27/2013 9:09	Outside, between Building 209 and 207	AA	U	U
3/27/2013 9:19	By 209-IA-09	AI	U	U
3/27/2013 9:26	In lab washroom	AI	U	U
3/27/2013 9:38	Bay C construction area. Sampled with probe using tubing inserted under door.	AI	U	U
3/27/2013 9:47	Resample run 011 location (by 209-IA-09)	AI	U	U
3/27/2013 9:56	Near entrance of organic prep/TCLP extraction lab (room with IA/SG-09 point)	AI	U	U
3/27/2013 10:05	Warehouse IA above subslab probe 209-SG-06	AI	0.24 J	U
3/27/2013 10:16	209-SG-09 (bag)	SS	4.6	7.5
3/27/2013 10:44	Retry run 018 location.	AI	U	U
3/27/2013 10:53	209-SG-06 (middle point)	SS	15	1.3 J
3/27/2013 11:23	209-SG-04 southeastern most point (bag)	SS	4.8	U

Notes:

1. Samples analyzed using an Inficon HAPSITE ER portable GC/MS instrument. Calibration curve 3/24/2013.
2. Samples are grouped by building, and sorted chronologically.
3. J = estimated (result less than lower calibration limit); JE = estimated (result higher than upper calibration limit); U = not detected.
4. Matrix: AI = Indoor air; AA = Ambient (outdoor) air; SS = Sub-slab

**APPENDIX C FIGURES**  
**ESTCP Projects ER-201119 and 201025**  
**Former Raritan Arsenal Site, New Jersey**

**Figure C.4.1: Site Map**

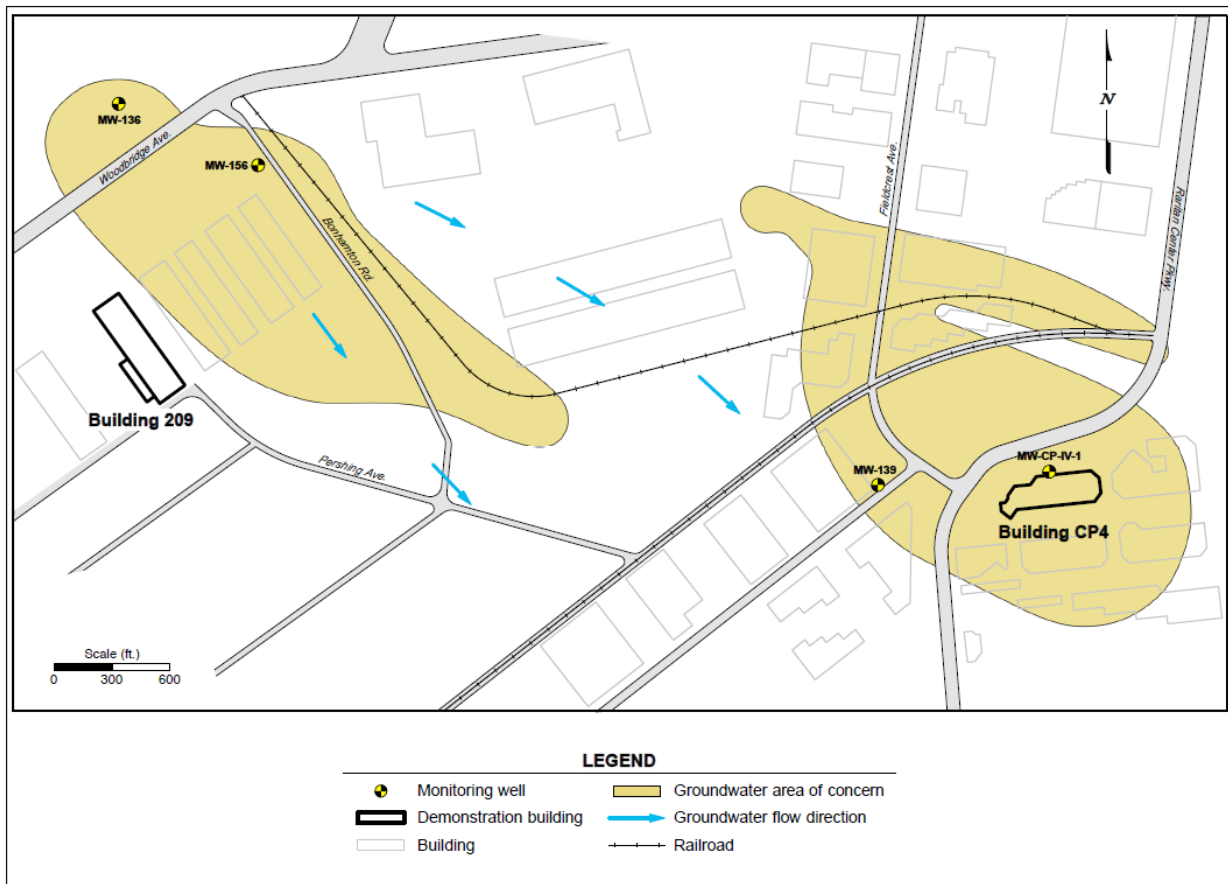

Note: Only monitoring wells sampled for the demonstration are shown.

**APPENDIX C FIGURES**  
**ESTCP Projects ER-201119 and 201025**  
**Former Raritan Arsenal Site, New Jersey**

**Figure C.4.2: Building CP4 Floorplan**

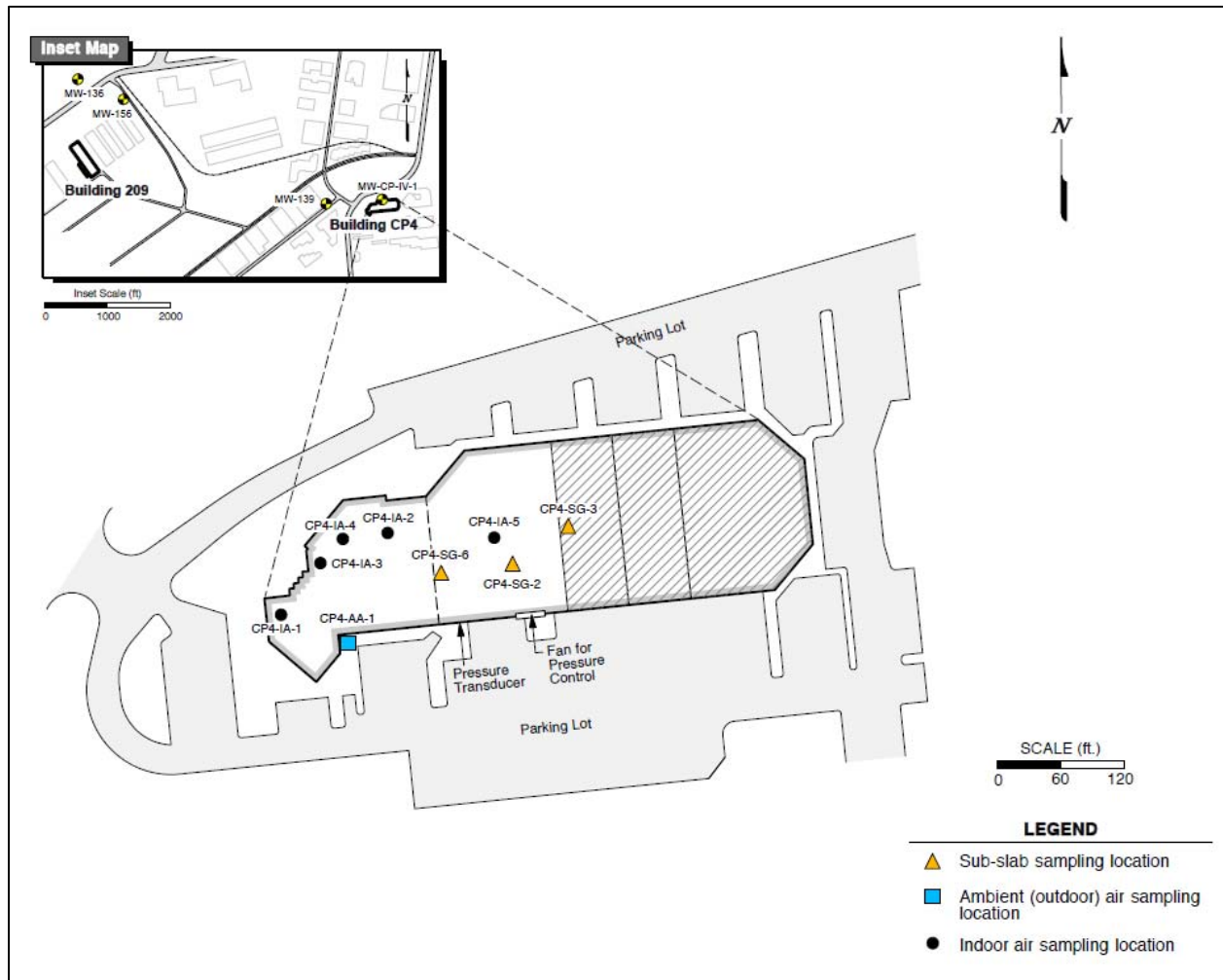

Note: Figure illustrates sample locations for off-site laboratory analysis. HAPSITE sample locations are not shown.

**APPENDIX C FIGURES**  
**ESTCP Projects ER-201119 and 201025**  
**Former Raritan Arsenal Site, New Jersey**

**Figure C.4.3: Building 209 Floorplan**

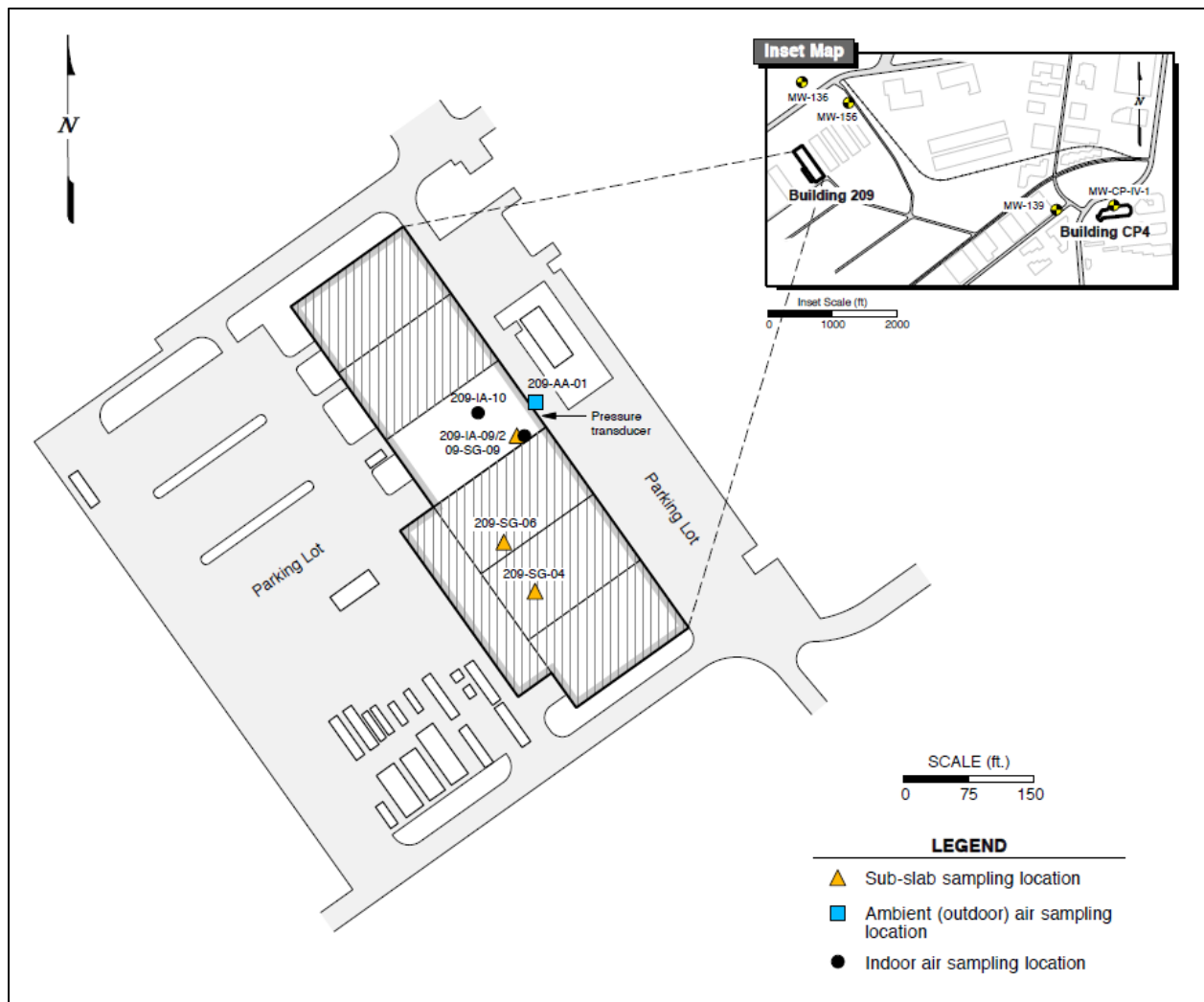

Note: Figure illustrates sample locations for off-site laboratory analysis. HAPSITE sample locations are not shown.

# **Appendix D: Data Quality Review and Laboratory Reports**

---

## **Use of On-Site GC/MS Analysis to Distinguish between Vapor Intrusion and Indoor Sources of VOCs**

Appendix D.1	Data Quality Review
Appendix D.2	UFP-QAPP Forms
Appendix D.3	Laboratory Reports



## Appendix D.1: Data Quality Review

### **TABLES**

---

Table D.1.1	HAPSITE Calibration Curve Metrics
Table D.1.2	HAPSITE Precision Assessment – cVOC Method
Table D.1.3	HAPSITE Precision Assessment – BTEX/MTBE Method
Table D.1.4	Method Blanks
Table D.1.5	HAPSITE Accuracy Assessment – cVOC Method
Table D.1.6	HAPSITE Accuracy Assessment – BTEX Method
Table D.1.7	Comparison between HAPSITE and Laboratory Results

**TABLE D.1.1: HAPSITE CALIBRATION CURVE METRICS**  
**ESTCP Project ER-201119**

		Compound	No. of Points in Calibration Curve	R <sup>2</sup>	RSD	RSD of RF
<b>JOINT BASE LEWIS-MCCHORD, WASHINGTON</b>						
<b>Instrument:</b>	HAPSITE ER	Vinyl Chloride	4	1	7.09%	20.09%
<b>Method:</b>	SIM_100PPB_Hill_VI_List_20120722	1,1-DCE	6	0.998	12.48%	16.76%
<b>Calibration Date:</b>	7/22/2012	trans	6	1	4.46%	8.33%
		1,1-DCA	6	0.999	9.22%	13.28%
		cis	6	1	2.56%	7.27%
		1,2-DCA	6	1	2.30%	8.14%
		CtCL	6	1	3.04%	8.53%
		TCE	6	1	6.62%	23.95%
		PCE	5	0.999	12.62%	27.22%
<b>SELFRIDGE AIR NATIONAL GUARD BASE, MICHIGAN</b>						
<b>Instrument:</b>	HAPSITE ER	MTBE	6	1	0.77%	6.27%
<b>Method:</b>	BETX_20120919_100PPB	Benzene	6	1	1.12%	4.56%
<b>Calibration Date:</b>	9/19/2012	Toluene	6	1	8.12%	36.76%
		Ethylbenzene	6	1	5.89%	10.64%
		m,p-xylene	6	0.996	15.35%	19.85%
		o-xylene	6	0.999	9.70%	15.96%
<b>SELFRIDGE AIR NATIONAL GUARD BASE, MICHIGAN</b>						
<b>Instrument:</b>	HAPSITE ER	IS-69	6	N/A	N/A	1.46%
<b>Method:</b>	IS_BETX_20120919_100PPB	IS-93	6	N/A	N/A	2.26%
<b>Calibration Date:</b>	9/19/2012	MTBE	6	1	1.65%	6.47%
		Benzene	6	1	0.62%	4.34%
		Toluene	6	1	8.93%	39.10%
		Ethylbenzene	6	1	6.56%	12.91%
		m,p-xylene	6	0.996	15.95%	22.10%
		o-xylene	6	0.999	10.42%	18.27%
<b>TYNDALL AIR FORCE BASE, FLORIDA</b>						
<b>Instrument:</b>	HAPSITE Smart	Vinyl Chloride	6	0.994	22.92%	58.75%
<b>Method:</b>	SIM_100PPB_Hill_VI_List	1,1-DCE	6	1	3.54%	4.66%
<b>Calibration Date:</b>	2/19/2013	trans	6	1	4.92%	4.01%
		1,1-DCA	6	1	5.64%	5.26%
		cis	6	0.99	7.40%	9.34%
		1,2-DCA	6	1	5.51%	6.17%
		CtCL	6	0.999	6.56%	9.28%
		TCE	4	1	5.16%	9.61%
		PCE	6	1	5.12%	14.04%
<b>FORMER RARITAN ARSENAL SITE, NEW JERSEY</b>						
<b>Instrument:</b>	HAPSITE Smart Plus	Vinyl Chloride	5	1	3.96%	18.54%
<b>Method:</b>	SIM_100PPB_Hill_VI_List	1,1-DCE	6	1	1.19%	6.70%
<b>Calibration Date:</b>	3/24/2013	trans	6	1	0.60%	3.70%
		1,1-DCA	6	1	0.81%	5.65%
		cis	6	1	0.55%	1.20%
		1,2-DCA	6	0.998	8.28%	20.29%
		CtCL	6	1	2.28%	16.56%
		TCE	6	1	2.98%	16.09%
		PCE	6	1	2.91%	10.64%

Notes:

1. 1,1-DCE = 1,1-dichloroethene; trans = trans-1,2-dichloroethene; 1,1-DCA = 1,1-dichloroethane; cis = cis-1,2-dichloroethene; 1,2-DCA = 1,2-dichloroethane; CtCL = tetrachloromethane; TCE = trichloroethylene; PCE = tetrachloroethylene; MTBE = methyl tert-butyl ether; IS-69 = internal standard of mass 69; IS-93 = internal standard of mass 93.

2. R<sup>2</sup> = correlation coefficient; RSD = relative standard deviation of calibration curve; RSD of RF = relative standard deviation of the response factor.

3. N/A - Non applicable.

**TABLE D.1.2: HAPSITE PRECISION ASSESSMENT - CVOC METHOD**  
**ESTCP Project ER-201119**

Normal Sample		Duplicate Sample		Trichloroethylene		
				N	FD	RPD
				ug/m3	ug/m3	%
<b>Lewis-McChord: 9 cVOC Method Analyzed with HAPSITE ER</b>						
3 ppbV CVOC bag	7/23/2012 7:24	3 ppbV CVOC (repeat)	7/23/2012 7:31	15	15	0%
09522 IA (Tedlar)	7/23/2012 11:06	09522 IA (re-run Tedlar)	7/23/2012 12:44	U	U	nc
9669-SS-2 (Tedlar)	7/23/2012 16:23	9669-SS-2 (repeat Tedlar)	7/23/2012 16:49	210 JE	210 JE	0%
9674 SS-3 (Tedlar)	7/24/2012 10:35	rerun 9674 SS-3 Tedlar	7/24/2012 10:43	U	1.6 J	nc
Nitrogen (5-L bag) - Mesa	7/24/2012 13:21	re-run N2 bag	7/24/2012 13:28	3.8	3.8	0%
cVOC standard in Tedlar bag	7/25/2012 6:23	Re-analyze sample to check concentrations	7/25/2012 6:34	2 J	2.1 J	-5%
NP Repeat front corner (1-IA-3)	7/25/2012 10:55	NP Repeat front corner (1-IA-3)	7/25/2012 11:05	1.8 J	2.1 J	-15%
NP Repeat front corner (1-IA-3)	7/25/2012 11:05	NP Repeat front corner (1-IA-3)	7/25/2012 11:13	2.1 J	1.7 J	21%
<b>Tyndall: 9 cVOC Method Analyzed with HAPSITE SMART</b>						
hotel room air	2/19/2013 9:53	hotel room air	2/19/2013 10:07	0.49 J	0.3 J	<b>48%</b>
N2 bag	2/21/2013 5:13	N2 bag	2/21/2013 5:42	7	6.4	9%
<b>Raritan: 9 cVOC Method Analyzed with HAPSITE SMART PLUS</b>						
Re-run 280 Raritan bag	3/25/2013 9:51	Re-run 280 Raritan bag (duplicate)	3/25/2013 9:59	1.1 J	1.1 J	0%
Conference room, sampled with probe	3/26/2013 13:07	Retry conference room after reboot.	3/26/2013 14:21	3.1	3.5	-12%
1 ppb CVOC	3/27/2013 6:14	Repeat 1 ppb bag	3/27/2013 6:23	6.4	5.9	8%
1 ppb bag #2, made this morning (1st use of new bag)	3/27/2013 6:48	Repeat new bag #2	3/27/2013 7:00	5.3	5.4	-2%

Note:

1. Bold-italics indicates RPD greater than 30%.

**TABLE D.1.3: HAPSITE PRECISION ASSESSMENT - BTEX/MTBE METHOD**  
**ESTCP Project ER-201119**

Normal Sample		Duplicate Sample		Benzene		
				N	FD	RPD
				ug/m3	ug/m3	%
<b>Selfridge: BTEX and MTBE Method Analyzed with HAPSITE ER</b>						
10 ppb standard in pre-purged 1-L Tedlar #5	9/17/2012 18:57	re-run 10 ppb bag #5	9/17/2012 19:39	5.8	3.2	<b>58%</b>
3 ppb bag #3	9/18/2012 6:06	re-run 3 ppb bag #3	9/18/2012 6:29	12	12	0%
Screening SS-3	9/18/2012 14:10	Repeat SS-3 bag	9/18/2012 14:49	2.7	2.1	25%
5 ppb bag #4, after recalibration	9/19/2012 7:44	5 ppb bag #4 after HAPSITE restarted itself	9/19/2012 8:34	15	15	0%

Note:

1. Bold-italics indicates RPD greater than 30%.

**TABLE D.1.4: METHOD BLANKS**  
**ESTCP Project ER-201119**

Description	Sample Timestamp	Benzene	Trichloroethylene
		ug/m3	ug/m3
<b>LEWIS-MCCHORD: HAPSITE ER / 9 cVOC SIM Method</b>			
Nitrogen (bag) - Mesa gas	7/22/2012 20:10	-	1 J
Indoor air - hotel room	7/22/2012 20:21	-	U
Nitrogen (bag) - Mesa	7/22/2012 20:28	-	0.97 J
Nitrogen (bag) - Inficon bottle	7/22/2012 20:57	-	1.9 J
Indoor air - hotel room (cleanout sample)	7/22/2012 22:33	-	U
Nitrogen (bag) - Mesa	7/23/2012 7:41	-	3.4
Indoor air - hotel room	7/23/2012 7:54	-	U
Nitrogen (bag) - Mesa	7/23/2012 8:01	-	3.3
Nitrogen (bag) - Mesa	7/23/2012 8:18	-	0.45 J
Nitrogen (bag) - Mesa	7/23/2012 12:28	-	1.1 J
Nitrogen (bag) - Mesa	7/23/2012 16:58	-	U
Nitrogen (5-L bag) - Mesa / Same bag from 7/23	7/24/2012 6:16	-	2 J
Indoor air - hotel room	7/24/2012 6:34	-	U
Nitrogen (5-L bag) - Mesa/ new N2 added to bag in the morning	7/24/2012 13:21	-	3.8
re-run N2 bag	7/24/2012 13:28	-	3.8
Outdoors at end of loading dock outside 9669. Used outdoor air d/t issues with Tedlar bag	7/24/2012 13:37	-	U
Nitrogen (bag) - Mesa	7/24/2012 15:06	-	3.6
Outdoors at end of loading dock outside 9669	7/24/2012 15:47	-	U
Nitrogen (5-L bag) - Mesa / new N2 added to 5-L bag from yesterday	7/25/2012 6:14	-	2 J
Nitrogen (1-L bag) - Mesa / new N2 added to bag this morning	7/25/2012 11:43	-	0.49 J
Nitrogen (1-L bag) - Mesa	7/25/2012 17:19	-	0.51 J

**TABLE D.1.4: METHOD BLANKS**  
**ESTCP Project ER-201119**

Description	Sample Timestamp	Benzene	Trichloroethylene
		ug/m3	ug/m3
Nitrogen (1-L bag) - Mesa / Used bag from yesterday. Flushed bag and added new N2	7/26/2012 6:44	-	U
Indoor air - hotel room	7/26/2012 6:53	-	U
Nitrogen (Mesa) in 1-L bag.	7/26/2012 9:33	-	7.5
Outdoor air blank (outside 9674). Did not use Tedlar bag d/t potential TCE issues.	7/26/2012 10:35	-	U
<b>SELFRIDGE: HAPSITE ER / BTEX and MTBE SIM Method</b>			
Hotel Room Air	9/17/2012 17:25	0.99 J	-
Mesa Nitrogen from new, unpurged 5-L Tedlar bag #1	9/17/2012 17:36	0.24 J	-
Mesa Nitrogen from 5-L Tedlar bag #1	9/17/2012 17:50	0.23 J	-
Outdoor air from pre-purged 1-L Tedlar bag	9/17/2012 18:01	0.73 J	-
Hotel Room Air	9/17/2012 19:51	0.42 J	-
Mesa Nitrogen from 5-L Tedlar bag #1	9/18/2012 5:53	0.093 J	-
Hotel Room Air	9/18/2012 6:17	0.51 J	-
Hotel Room Air	9/18/2012 7:03	0.51 J	-
N2 Blank	9/19/2012 6:14	0.42 J	-
N2 bag from this morning	9/19/2012 18:15	0.48 J	-
<b>TYNDALL: HAPSITE SMART / 9 cVOC + Toluene SIM Method</b>			
hotel room air	2/18/2013 17:44	-	0.1 J
hotel room air	2/19/2013 8:00	-	0.64 J
hotel room air	2/19/2013 9:53	-	0.49 J
hotel room air	2/19/2013 10:07	-	0.3 J
hotel room air	2/19/2013 14:20	-	0.4 J
hotel room air	2/19/2013 17:15	-	0.64 J

**TABLE D.1.4: METHOD BLANKS**  
**ESTCP Project ER-201119**

Description	Sample Timestamp	Benzene	Trichloroethylene
		ug/m3	ug/m3
hotel room air	2/20/2013 5:40	-	0.7 J
N2 bag	2/20/2013 5:53	-	0.26 J
N2 bag	2/20/2013 10:55	-	0.2 J
N2 bag	2/20/2013 15:02	-	0.25 J
N2 bag (bag from yesterday)	2/21/2013 5:13	-	7
N2 bag	2/21/2013 5:42	-	6.4
hotel room air	2/21/2013 5:53	-	0.28 J
building TAFB-1; N2 in new Tedlar bag	2/21/2013 14:11	-	0.16 J
N2 bag from this afternoon	2/21/2013 17:32	-	U
<b>RARITAN: HAPSITE SMART PLUS / 9 cVOC + Toluene SIM Method</b>			
Hotel room air	3/24/2013 15:54	-	U
N2 bag	3/24/2013 16:28	-	U
Hotel room air	3/24/2013 17:06	-	U
Hotel room air	3/24/2013 17:18	-	U
Hotel room air.	3/24/2013 17:36	-	U
N2 bag	3/25/2013 8:35	-	0.45 J
N2 bag from this morning	3/25/2013 13:18	-	0.64 J
N2 bag	3/26/2013 8:39	-	0.47 J
N2 bag (made this morning)	3/26/2013 12:50	-	0.64 J
Hotel room indoor air, to test	3/26/2013 17:49	-	U
N2 bag	3/26/2013 18:06	-	0.59 J
N2 bag made this morning	3/27/2013 6:06	-	0.81 J

**TABLE D.1.4: METHOD BLANKS**  
**ESTCP Project ER-201119**

Description	Sample Timestamp	Benzene	Trichloroethylene
		ug/m3	ug/m3
Hotel room air	3/27/2013 7:12	-	U
N2 blank	3/27/2013 11:33	-	1 J
N2 bag made yesterday	3/28/2013 5:53	-	0.97 J
N2 bag made yesterday	3/28/2013 11:29	-	1.1 J

Notes:

1. Dash ("-") indicates no analysis (compound not included in method).
2. J = estimated concentration less than lower calibration limit.



**TABLE D.1.5: HAPSITE ACCURACY ASSESSMENT - CVOC METHOD**  
**ESTCP Project ER-201119**

Sample Description	Conc. ppbV	Trichloroethylene		
		Result	RPD	
		ppbV	%	
<b>Lewis-McChord: 9 cVOC Method Analyzed with HAPSITE ER</b>				
cal check; 1 ppbv bag	7/23/2012 1:18	1	1.5	40%
cal check; 5 ppbv bag	7/23/2012 1:27	5	6.8	31%
1 ppbV CVOC bag	7/23/2012 7:11	1	1.3	26%
3 ppbV CVOC bag	7/23/2012 7:24	3	2.8	7%
3 ppbV CVOC (repeat)	7/23/2012 7:31	3	2.8	7%
1 ppbV CVOC	7/23/2012 12:36	1	1.2	18%
1 ppbV CVOC bag	7/23/2012 17:05	1	1.3	26%
1 ppbV CVOC bag	7/24/2012 6:24	1	1.4	33%
1 ppbV CVOC bag	7/24/2012 13:14	1	1.5	40%
1 ppbv bag	7/24/2012 15:13	1	1.3	26%
1 ppbV bag, with new mix. N2 for mix was taken straight from Mesa Cylinder	7/25/2012 6:57	1	1.3	26%
1 ppbV bag	7/25/2012 11:54	1	1.3	26%
1 ppbV bag	7/25/2012 17:12	1	1.4	33%
1 ppbV bag	7/26/2012 6:36	1	1.2	18%
1 ppbV bag	7/26/2012 10:26	1	1.1	10%
<b>Tyndall: 9 cVOC Method Analyzed with HAPSITE SMART</b>				
0.5 ppb bag made 2/18/2013	2/19/2013 8:13	0.5	0.73	37%
1 ppb bag made 2/18/2013	2/19/2013 8:23	1	1.3	26%
3 ppb bag made 2/18/2013	2/19/2013 8:32	3	4	29%
5 ppb bag made 2/18/2013	2/19/2013 8:44	5	7.1	35%
10 ppb bag made 2/18/2013	2/19/2013 9:40	10	11	10%
1 ppb bag cal check	2/19/2013 16:46	1	1.9	62%

**TABLE D.1.5: HAPSITE ACCURACY ASSESSMENT - CVOC METHOD**  
**ESTCP Project ER-201119**

Sample Description	Conc. ppbV	Trichloroethylene		
		Result ppbV	RPD %	
		1 ppb bag	2/20/2013 6:08	1
1 ppb bag	2/20/2013 11:03	1	2	67%
1 ppb bag	2/20/2013 15:10	1	1.8	57%
1 ppb bag	2/21/2013 6:01	1	1.8	57%
building TAFB-1; 1 ppb bag made this morning	2/21/2013 14:19	1	1.2	18%
1 ppb bag	2/21/2013 17:40	1	0.7	35%
<b>Raritan: 9 cVOC Method Analyzed with HAPSITE SMART PLUS</b>				
1 ppb bag (same as used for calibration)	3/24/2013 18:33	1	1.1	10%
1.0 ppb bag - cvoc mix made at approx 06:15 this morning	3/25/2013 8:43	1	1.1	10%
1 ppb bag from this morning	3/25/2013 13:31	1	1.5	40%
1 ppb bag	3/26/2013 8:46	1	1.1	10%
1 ppb bag	3/26/2013 12:58	1	1.5	40%
1 ppb CVOC bag from this morning	3/26/2013 18:14	1	1.4	33%
1 ppb CVOC	3/27/2013 6:14	1	1.2	18%
Repeat 1 ppb bag	3/27/2013 6:23	1	1.1	10%
1 ppb bag #2, made this morning (1st use of new bag)	3/27/2013 6:48	1	0.98	2%
Repeat new bag #2	3/27/2013 7:00	1	1	0%
1 ppb CVOC bag made this morning	3/27/2013 11:41	1	1.6	46%
1 ppb bag (#1) made yesterday	3/28/2013 6:01	1	1.4	33%
1 ppb bag #2 made this morning	3/28/2013 6:27	1	1.4	33%
1 ppb bag made today (bag #2)	3/28/2013 11:37	1	1.6	46%
1 ppb bag made yesterday (bag #1)	3/28/2013 11:44	1	1.4	33%

Note: RPD = abs(standard - sample result)/average of standard and sample result x 100

**TABLE D.1.6: HAPSITE ACCURACY ASSESSMENT - BTEX METHOD**  
**ESTCP Project ER-201119**

Sample Description	Conc. ppbV	Benzene		
		N	RPD	
		ppbV	%	
<b>SANG: BTEX/MTBE Method Analyzed with HAPSITE ER</b>				
re-run 10 ppb bag #5	9/17/2012 19:39	10	1	164%
5 ppb bag #4, run with new cal	9/17/2012 22:21	5	0.69	151%
3 ppb bag #3, run with new cal	9/17/2012 22:34	3	0.41 J	152%
3 ppb bag #3	9/18/2012 6:06	3	3.7	21%
re-run 3 ppb bag #3	9/18/2012 6:29	3	3.6	18%
10 ppb bag #5	9/18/2012 6:49	10	10	0%
3 ppb bag #3b (made this morning).	9/18/2012 16:21	3	2.5	18%
3 ppb bag #3b	9/18/2012 18:41	3	4.2	33%
10 ppb bag #5b (made this morning).	9/18/2012 18:58	10	13	26%
5 ppb bag #4	9/19/2012 7:44	5	4.8	4%
5 ppb bag #4 after HAPSITE restarted	9/19/2012 8:34	5	4.7	6%
Bag 1ppb to check readings	9/19/2012 11:24	1	1.1	10%
1 ppb bag (#2b) from this morning	9/19/2012 18:29	1	0.94	6%
3 ppb bag (#3) from this morning	9/19/2012 18:40	3	2.7	11%

**TABLE D.1.7: COMPARISON BETWEEN HAPSITE AND LABORATORY RESULTS**  
**ESTCP Project ER-201119**

ON-SITE RESULT				LAB RESULT				Dir.
Sample Date/Time	Sample Description	Analyte	Result (ug/m3)	Field Sample ID	Sample Date/Time	Pressure Condition	Lab Result (ug/m3)	RPD
<b>HAPSITE ER / Lewis-McChord Building 9669</b>								
7/25/2012 8:50	BL Repeat front corner (1-IA-3)	TCE	1.5 J	1-IA-3-BL	7/25/2012 8:53	BL	2	29%
7/25/2012 9:54	PP Repeat front corner (1-IA-3)	TCE	1.1 J	1-IA-3-PP	7/25/2012 9:57	PP	1.2	9%
7/25/2012 11:13	NP Repeat front corner (1-IA-3)	TCE	1.7 J	1-IA-3-NP	7/25/2012 11:06	NP	2	16%
<b>HAPSITE ER / Lewis-McChord Building 9674</b>								
7/26/2012 7:58	BL 2-IA-1 center of building	TCE	U	2-IA-1-BL	7/26/2012 8:36	BL	0.032	nc
7/26/2012 10:13	NP 2-IA-1	TCE	U	2-IA-1-NP	7/26/2012 10:15	NP	<0.03	nc
<b>HAPSITE ER / Selfridge Building 1533</b>								
9/19/2012 11:12	Center of shop (after vehicle en)	BZ	141 JE	INDOOR-1-BL	9/19/2012 11:15	BL	130	-8%
9/19/2012 14:13	IA-2	BZ	5.1	INDOOR-1-PP	9/19/2012 14:16	PP	5.3 RE	4%
9/19/2012 16:24	IA-2	BZ	422 JE	INDOOR-1-NP	9/19/2012 16:43	NP	69	-144%
<b>SMART / Tyndall Building 156</b>								
2/21/2013 14:27	Building 156 small room adjacer	TCE	U	156-IA-4-BL	2/22/2013 8:04	BL	<0.032	nc
2/21/2013 15:56	Building 156 small room adjacer	TCE	U	156-IA-4-NP	2/21/2013 15:57	NP	<0.031	nc
<b>SMART PLUS / Raritan Building CP4</b>								
3/26/2013 15:56	In wall, behind ethernet/outlet c	TCE	11	CP4-IA-3	3/26/2013 16:30	BL	2.4	-128%
3/26/2013 16:33	resample ethernet/wall outlet (s	TCE	4	CP4-IA-3	3/26/2013 16:30	BL	2.4	-50%
3/28/2013 8:44	End of BL; Warehouse 1, paired	TCE	0.81 J	CP4-IA-5-BL	3/28/2013 8:45	BL	0.43	-61%
3/28/2013 11:03	NP; last NP sample, paired with	TCE	0.59 J	CP4-IA-5-NP	3/28/2013 11:05	NP	0.32	-59%

## **Appendix D.2: UFP-QAPP Forms**

### **CONTENTS**

---

Appendix D.2.1	Forms Applicable to All Sites
Appendix D.2.2	Forms for Individual Sites

## **Appendix D.2.1: Forms Applicable to All Sites**

**QAPP Worksheet #10: Conceptual Site Model**  
**(UFP-QAPP Manual Section 2.5.2)**  
**(EPA 2106-G-05 Section 2.2.5)**

This demonstration will be combined with the demonstration of CSIA to distinguish between indoor sources of VOCs and vapor intrusion (ESTCP Project ER-201025). Validating the two different investigation methods at the same sites leverages the results of each individual innovative method.

The field demonstration program will be completed at four sites. Site selection is based on the following characteristics:

- *Building Characteristics*: At each site, the demonstration will be conducted in one to three buildings depending on building size and other factors. The buildings may be residential or industrial, large or small, but should be occupied or suitable for occupancy.
- *Vapor Intrusion Concern*: The candidate buildings should either i) have known vapor intrusion issues or ii) have been identified as having high vapor intrusion concern based on the presence of VOCs in close proximity to the building.
- *Subsurface Sample Points*: At least three existing subsurface sample points (either monitoring wells or soil gas sample points) with detectable concentrations of VOCs should be located within 1000 ft of a target building (either upgradient of the building or within 100 ft downgradient). These sample points will be used to characterize the isotope fingerprint of the subsurface VOC source (ESTCP Project ER-201025).
- *Building Access*: Access must be available to all parts of the building during normal working hours for up to three days. The investigation program will not disrupt normal building activities and will have at most a minimal impact on the building occupants.

The demonstration sites have varying degrees of concern with vapor intrusion based on previously conducted environmental assessments. Site geology/hydrogeology and contaminant distribution is summarized below:

Site	Geology/Hydrogeology	Contaminant Distribution
Joint Base Lewis-McChord Logistics Center	<p>Shallow stratigraphy consists of alternating glacial and non-glacial sediments (Envirosphere, 1988).</p> <p>Depth to water approximately 20-30 feet bgs.</p> <p>Hydraulic gradient to the northwest.</p>	<p>cVOCs are present in shallow groundwater as a result of historic releases from former disposal areas located upgradient of the buildings</p> <p>cVOCs included in site groundwater monitoring program: TCE, c12DCE, PCE, 111TCA, VC</p> <p>Near the demonstration buildings, TCE concentrations in groundwater in the shallow aquifer range from 60 – 110 ug/L, based on monitoring conducted in Spring 2012.</p>
Selfridge Air National Guard Base	<p>Shallow stratigraphy consists of glacial lake sediments (e.g., clays and silts) overlying a sedimentary bedrock. In the vicinity of Building 1533, shallow soils are predominantly sand and gravel fill. Underlying the fill is a clay approximately 30-40 feet thick (AMEC, 2009).</p> <p>Depth to water approximately 2 – 6 feet bgs.</p> <p>Hydraulic gradient to the south-southwest.</p>	<p>Impacted soils were excavated from the former UST basin and nearby areas in 1992 and 2003. Remaining soil and groundwater impacts are present along the western edge of the former UST basin/excavation area, under the eastern portion of Building 1533, and south of Building 1533.</p> <p>Key COCs from the site investigation are BTEX and PAH compounds. Benzene was considered the primary COC for the vapor intrusion evaluation.</p>
Tyndall Air Force Base	<p>Shallow stratigraphy consists primarily of unconsolidated sands approximately 50 feet thick. This interval is underlain by a calcareous sandy clay to clayey sand (Jackson Bluff</p>	<p>cVOCs are present shallow (water table) and deeper zones at the site. The areal extent of cVOCs in the shallow zone is smaller than in the deeper zones.</p>



	<p>Formation).</p> <p>Depth to the water table aquifer ranges from 2 – 7 feet bgs.</p> <p>In the vicinity of the study building, the hydraulic gradient is generally towards the north/northeast.</p>	<p>Recent groundwater monitoring results near the demonstration buildings indicate that TCE and cis-1,2-DCE are the primary constituents. Concentrations near Building 156 range from 31 – 299 ug/L (TCE) and 21 – 101 (cis-1,2-DCE) [URS, 2008]. Near Building 219, TCE concentrations are less than 10 ug/L; cis-1,2-DCE concentrations have been measured at more than 2,000 ug/L (3E Consultants, 2011).</p>
Former Raritan Arsenal Site	<p>The shallow stratigraphy consists of interbedded sands and clays. Gravels may also be present.</p> <p>There are two separate plumes with separate source areas in the vicinity of Campus Plaza 4 and Building 209. The hydraulic gradient in both areas is generally towards the southeast.</p> <p>The Campus Plaza 4 building is located above the AOC2 plume. The depth to water in the vicinity of Campus Plaza 4 is approximately 10 feet bgs.</p> <p>Building 209 is located approximately 150 feet west of the AOC8A/B plume. Depth to water in the vicinity of Building 209 is approximately 30 feet bgs.</p>	<p>2012 groundwater monitoring results near the demonstration buildings indicate that TCE is the primary COC. At Campus Plaza 4, TCE concentrations are approximately 8 ug/L. Near Building 209, TCE concentrations range from below detection (in a monitoring well next to the building) to approximately 2 ug/L upgradient of the building.</p>

**QAPP Worksheet #12: Measurement Performance Criteria**  
**(UFP-QAPP Manual Section 2.6.2)**  
**(EPA 2106-G-05 Section 2.2.6)**

Matrix: Air / Vapor  
Analytical Group or Method: VOA/TO-15 (laboratory analysis)  
Concentration Level: Low

<b>Data Quality Indicator (DQI)</b>	<b>QC sample or measurement performance activity</b>	<b>Measurement Performance Criteria</b>
Overall Precision	Field Duplicates	RPD $\leq$ 30% when VOCs are detected in both samples $\geq$ sample-specific LOQ
Analytical Precision (laboratory)	Laboratory Control Sample Duplicates	RPD $\leq$ 25%
Analytical Accuracy/Bias (laboratory)	Laboratory Control Samples	Analyte-specific (per lab SOP)
Analytical Accuracy/Bias (matrix interference)	Matrix Spike Duplicates	Analyte-specific (per lab SOP)
Sensitivity	LOQ verification sample (spiked at LOQ)	Recovery within $\pm$ 25% of LOQ
Completeness	See Worksheet #34	See Worksheet #34

Matrix: Air / Vapor  
Analytical Group or Method: VOA/TO-15 (field analysis)  
Concentration Level: Low

<b>Data Quality Indicator (DQI)</b>	<b>QC sample or measurement performance activity</b>	<b>Measurement Performance Criteria</b>
Overall Precision	Field Duplicates	RPD $\leq$ 30% when VOCs are detected in both samples $\geq$ sample-specific LOQ
Overall accuracy/bias (contamination)	Equipment Blanks	No target analyte concentrations $\geq$ LCL
Sensitivity	LOQ verification sample (spiked at LOQ)	<1ug/m3 for cVOCs and <5ug/m3 for VOCs
Completeness	See Worksheet #34	See Worksheet #34

**QAPP Worksheet #19&30: Sample Containers, Preservation, and Hold Times  
(UFP-QAPP Manual Section 3.1.2.2)  
(EPA 2106-G-05 Section 2.3.2)**

Laboratory (Name, sample receipt address, POC, e-mail, and phone numbers):

ALS/Columbia Analytical Services (attn.: Sue Anderson, sanderson@caslab.com)  
 2655 Park Center Drive, Ste. A  
 Simi Valley, California 93065  
 805.526.7161  
 805.526.7270 (fax)

List any required accreditations/certifications:

n/a

Back-up Laboratory:

Alpha Analytical, Mansfield, MA

Sample Delivery Method:

FedEx or UPS (ground shipping acceptable)

Analyte/ Analyte Group	Matrix	Method/ SOP	Container(s) (number, size & type per sample)	Preservation	Preparation Holding Time	Analytical Holding Time	Data Package Turnaround
Volatile Organic Compounds	Air/Vapor	TO-15	6-L Summa, individually certified	none	n/a	30 days	10 days

**QAPP Worksheet #20: Field QC Summary**  
**(UFP-QAPP Section 3.1.1 and 3.1.2)**  
**(EPA 2106-G-05 Section 2.3.5)**

<b>Matrix</b>	<b>Analyte/Analytical Group</b>	<b>Field Samples</b>	<b>Field Duplicates</b>	<b>Matrix Spikes</b>	<b>Matrix Spike Duplicates</b>	<b>Field Blanks</b>	<b>Equipment Blanks</b>	<b>Trip Blanks</b>	<b>CCV</b>	<b>Total # analyses<sup>1</sup></b>
Air/Vapor	VOCs (low conc.)	20	1	0	0	3	N/A	N/A	3	27

## Note:

1. Number of samples per representative building per day

**QAPP Worksheet #21: Field SOPs  
(UFP-QAPP Manual Section 3.1.2)  
(EPA 2106-G-05 Section 2.3.2)**

<b>SOP # or reference</b>	<b>Title, Revision, Date, and URL (if available)</b>	<b>Originating Organization</b>	<b>SOP option or Equipment Type (if SOP provides different options)</b>	<b>Modified for Project? Y/N</b>	<b>Comments</b>
Protocol v2, Appendix B	HAPSITE calibration	GSI Environmental	n/a	N	
Demonstration Plan v2, Appendix D, Section 8.1	HAPSITE daily checks (blanks, continuing calibration verification, field duplicates)	GSI Environmental	n/a	N	
Demonstration Plan v2, Figure 5.1.2 and Appendix D, Section 4.1.1	Protocol for vapor sampling with HAPSITE	GSI Environmental	n/a	N	
Demonstration Plan v2, Appendix D, Section 4.2	Differential Pressure Measurements	GSI Environmental	n/a	N	

Demonstration Plan v2, Section 5.3.1	Sub-slab sample point installation	GSI Environmental	n/a	Y	Sub-slab sampling points will be installed in holes up to 3/4" in diameter
Demonstration Plan v2, Section 5.3.1 and Appendix E, Section 4.1	Collecting samples for off-site lab analysis, including tubing purge	GSI Environmental	n/a	Y	For air sampling into Tedlar bags for radon analysis, collect up to 500 mL in a 1-Liter bag
Demonstration Plan v2, Appendix E, Section 8.1.2	Collecting field duplicates for off-site lab analysis	GSI Environmental	n/a	N	

**QAPP Worksheet #22: Field Equipment Calibration, Maintenance, Testing, and Inspection**  
**(UFP-QAPP Manual Section 3.1.2.4)**  
**(EPA 2106-G-05 Section 2.3.6)**

<b>Field Equipment</b>	<b>Activity</b>	<b>SOP Reference</b>	<b>Title or position of responsible person</b>	<b>Frequency</b>	<b>Acceptance Criteria</b>	<b>Corrective Action</b>
HAPSITE	Calibration	Protocol, Appendix B	Equipment Operator	Prior to demonstration	See SOP	See SOP
HAPSITE	Inspection and Maintenance	Inficon Manual	Equipment Operator	As indicated by instrument warning messages	See manual	See manual
HAPSITE	Testing	Demonstration Plan, App D (QAPP)	Equipment Operator	See QAPP	See QAPP	See QAPP
Omniguard 4 Differential Pressure Recorder	Inspection and Maintenance	User Guide	Equipment Operator	Prior to deployment	See User Guide	See User Guide



**QAPP Worksheet #34: Data Verification and Validation Inputs**  
**(UFP-QAPP Manual Section 5.2.1 and Table 9)**  
**(EPA 2106-G-05 Section 2.5.1)**

<b>Item</b>	<b>Description</b>	<b>Verification (completeness)</b>	<b>Validation (conformance to specifications)</b>
<b>Planning Documents/Records</b>			
<b>1</b>	Approved QAPP	<b>X</b>	
<b>2</b>	Contract	<b>X</b>	
<b>4</b>	Field SOPs	<b>X</b>	
<b>Field Records</b>			
<b>5</b>	Field logbooks	<b>X</b>	<b>X</b>
<b>6</b>	Equipment calibration records	<b>X</b>	<b>X</b>
<b>7</b>	Chain-of-Custody Forms	<b>X</b>	<b>X</b>
<b>8</b>	Sampling diagrams/surveys	<b>X</b>	<b>X</b>
<b>9</b>	Field corrective action reports	<b>X</b>	<b>X</b>
<b>Analytical Data Package</b>			
<b>10</b>	Cover sheet (laboratory identifying information)	<b>X</b>	<b>X</b>
<b>11</b>	Case narrative	<b>X</b>	<b>X</b>
<b>12</b>	Sample receipt records	<b>X</b>	<b>X</b>
<b>13</b>	Sample chronology (i.e. dates and times of receipt, preparation, & analysis)	<b>X</b>	<b>X</b>
<b>14</b>	LOD/LOQ establishment and verification	<b>X</b>	<b>X</b>
<b>15</b>	Instrument calibration records	<b>X</b>	<b>X</b>
<b>16</b>	Definition of laboratory qualifiers	<b>X</b>	<b>X</b>
<b>17</b>	Results reporting forms	<b>X</b>	<b>X</b>
<b>18</b>	QC sample results	<b>X</b>	<b>X</b>
<b>19</b>	Corrective action reports	<b>X</b>	<b>X</b>
<b>20</b>	Electronic data deliverable	<b>X</b>	<b>X</b>

**QAPP Worksheet #35: Data Verification Procedures**  
**(UFP-QAPP Manual Section 5.2.2)**  
**(EPA 2106-G-05 Section 2.5.1)**

<b>Records Reviewed</b>	<b>Requirement Documents</b>	<b>Process Description</b>	<b>Responsible Person, Organization</b>
Field forms	QAPP	Verify that records are present and complete for each day of field activities. Verify that all planned samples including field QC samples were collected and that sample collection locations are documented. Verify that changes/exceptions are documented and were reported in accordance with requirements. Verify that any required field monitoring was performed and results are documented.	Daily - Project Manager  At conclusion of field activities - Project QA Manager
Chain-of-custody forms	QAPP	Verify the completeness of chain-of-custody records. Examine entries for consistency with the field logbook. Check that appropriate methods and sample preservation have been recorded. Verify that the required volume of sample has been collected and that sufficient sample volume is available for QC samples (e.g., MS/MSD). Verify that all required signatures and dates are present. Check for transcription errors.	Daily - Field Crew Chief  At conclusion of field activities - Project QA Manager

Laboratory Deliverable	QAPP	Verify that the laboratory deliverable contains all records specified in the QAPP. Check sample receipt records to ensure sample condition upon receipt was noted, and any missing/broken sample containers were noted and reported according to plan. Compare the data package with the CoCs to verify that results were provided for all collected samples. Review the narrative to ensure all QC exceptions are described. Check for evidence that any required notifications were provided to project personnel as specified in the QAPP. Verify that necessary signatures and dates are present.	Before release – Laboratory QAM  Upon receipt - Project QA Manager
Audit Reports, Corrective Action Reports	QAPP	Verify that all planned audits were conducted. Examine audit reports. For any deficiencies noted, verify that corrective action was implemented according to plan.	Project QA Manager

**QAPP Worksheet #37: Data Usability Assessment  
(UFP-QAPP Manual Section 5.2.3 including Table 12)  
(EPA 2106-G-05 Section 2.5.2, 2.5.3, and 2.5.4)**

Identify personnel (organization and position/title) responsible for participating in the data usability assessment:

- Project Manager
- Project QA Manager
- Field Task Leader
- Principal Investigator

Describe how the usability assessment will be documented: Appropriate project personnel will follow data verification procedures (e.g., QAPP worksheet #35). Data quality exceptions will be documented in the project files and final report.

Summarize the data usability assessment process including statistics, equations, and computer algorithms that will be used to analyze the data:

<b>Step 1</b>	<p><b>Review the project’s objectives and sampling design</b></p> <p><i>Review the key outputs to make sure they are still applicable. Review the sampling design for consistency with stated objectives.</i></p>
<b>Step 2</b>	<p><b>Review the data verification and data validation outputs</b></p> <p><i>Review available QA reports, including the data verification and data validation reports. Perform basic calculations and summarize the data (using graphs, maps, tables, etc.). Look for patterns, trends, and anomalies (i.e., unexpected results). Review deviations from planned activities (e.g., number and locations of samples, holding time exceedances, damaged samples, non-compliant PT sample results, and SOP deviations) and determine their impacts on the data usability. Evaluate implications of unacceptable QC sample results.</i></p>
<b>Step 3</b>	<p><b>Verify the assumptions of the selected statistical method, if applicable</b></p> <p><i>Verify whether underlying assumptions for selected statistical methods (if documented in the QAPP) are valid. Common assumptions include the distributional form of the data, independence of the data, dispersion characteristics, homogeneity, etc. Depending on the robustness of the statistical method, minor deviations from assumptions usually are not critical to statistical analysis and data interpretation. If serious deviations from assumptions are discovered, then another statistical method may need to be selected.</i></p>

<b>Step 4</b>	<b>Implement the statistical method, if applicable</b>  <i>Implement the specified statistical procedures for analyzing the data and review underlying assumptions. For decision projects that involve hypothesis testing (e.g., “concentrations of lead in groundwater are below the action level”) consider the consequences for selecting the incorrect alternative; for estimation projects (e.g., establishing a boundary for surface soil contamination), consider the tolerance for uncertainty in measurements.</i>
<b>Step 5</b>	<b>Document data usability and draw conclusions</b>  <i>Determine if the data can be used as intended, considering implications of deviations and corrective actions. Discuss data quality indicators. Assess the performance of the sampling design and identify limitations on data use. Update the conceptual site model and document conclusions. Prepare the data usability summary report which can be in the form of text and/or a table.</i>

## **Appendix D.2.2: Forms for Individual Sites**

**QAPP Worksheet #18: Sampling Locations and Methods**  
**(UFP-QAPP Manual Section 3.1.1 and 3.1.2)**  
**(EPA 2106-G-05 Section 2.3.1 and 2.3.2)**

Location ID/ Sample ID	Matrix <sup>1</sup>	Depth (ft BGS)	Type <sup>2</sup>	Analyte/ Analytical Group	Sampling SOP	Comments
JBLM-1 / 1-AA-1-CON	AA	-	N	VOC	CON; Summa, 6-L	8-hr FC; summa set on ground
JBLM-1 / 1-IA-1-CON	IA	-	N	VOC	CON; Summa, 6-L	8-hr FC; summa on desk
JBLM-1 / 1-IA-2-CON	IA	-	N	VOC	CON; Summa, 6-L	8-hr FC; summa on shelf
JBLM-1 / 1-SS-1-CON	SS	0.5	N	VOC	CON; Summa, 6-L	grab
JBLM-1 / 1-SS-2-CON	SS	0.5	N	VOC	CON; Summa, 6-L	grab
JBLM-1 / 1-SS-3-CON	SS	0.5	N	VOC	CON; Summa, 6-L	grab
JBLM-1 / 1-IA-1-CSI	IA	-	N	Isotope	CSI; Sorbent tubes	sampling 7/23 15:27 - 7/24 09:41
JBLM-1 / 1-SS-2-CSI	SS	0.5	N	Isotope	CSI; Sorbent tubes	sampling 7/25 09:17 - 7/25 09:34
JBLM-1 / 3-SS-2-CSI	SS	0.5	FD	Isotope	CSI; Sorbent tubes	duplicate at 1-SS-2; sampling 7/25 09:40 - 7/25 09:57
JBLM-1 / DUP-1	GW	32 - 40	FD	Isotope	CSI; VOA vials	duplicate at LC-18
JBLM-1 / LC-18	GW	32 - 40	N	Isotope	CSI; VOA vials	
JBLM-1 / MT-1	GW	<30	N	Isotope	CSI; VOA vials	

<sup>1</sup>Key: GW = groundwater, AA = Ambient (outdoor) air, IA = Indoor Air, SS = Sub-slab

<sup>2</sup>Key: N = normal; FD = field duplicate

<sup>3</sup>Key: CON = conventional program; OSA = on-site GC/MS analysis program; CSI = compound-specific stable isotope program

JBLM-1 / 1-AA-1	AA	-	N	Radon	OSA; Tedlar, 1-L	grab; 500 mL
JBLM-1 / 1-IA-3-BL	IA	-	N	Radon	OSA; Tedlar, 1-L	grab; 500 mL; timestamp from lab report 7/25/2012 8:51:00 AM (updated to sync with paired summa)
JBLM-1 / 1-IA-3-BL	IA	-	N	VOC	OSA; Summa, 6-L	grab; summa on desk
JBLM-1 / 1-IA-3-NP	IA	-	N	Radon	OSA; Tedlar, 1-L	grab; 500 mL
JBLM-1 / 1-IA-3-NP	IA	-	N	VOC	OSA; Summa, 6-L	grab; summa on desk
JBLM-1 / 1-IA-3-PP	IA	-	N	Radon	OSA; Tedlar, 1-L	grab; 500 mL; timestamp from lab report 7/25/2012 9:55:00 AM (updated to pair with summa)
JBLM-1 / 1-IA-3-PP	IA	-	N	VOC	OSA; Summa, 6-L	grab; summa on desk
JBLM-2 / 2-AA-1-CON	AA	-	N	VOC	CON; Summa, 6-L	8-hr FC; summa set on ground
JBLM-2 / 2-IA-1-CON	IA	-	N	VOC	CON; Summa, 6-L	8-hr FC; summa set on ground
JBLM-2 / 2-SS-1-CON	SS	0.5	N	VOC	CON; Summa, 6-L	grab
JBLM-2 / 2-SS-2-CON	SS	0.5	N	VOC	CON; Summa, 6-L	grab
JBLM-2 / 2-SS-3-CON- Resample	SS	0.5	N	VOC	CON; Summa, 6-L	grab; original sample had too much vac after sampling
JBLM-2 / LC-48	GW	27.3 - 32.3	N	Isotope	CSI; VOA vials	
JBLM-2 / 2-AA-1	AA	-	N	Radon	OSA; Tedlar, 1-L	grab; 500 mL
JBLM-2 / 2-IA-1-BL	IA	-	N	VOC	OSA; Summa, 6-L	grab; summa on floor under shelf
JBLM-2 / 2-IA-1-BL	IA	-	N		OSA; Tedlar, 1-L	grab; 500 mL
JBLM-2 / 2-IA-1-NP	IA	-	N	VOC	OSA; Summa, 6-L	grab; summa on floor under shelf



JBLM-2 / 2-IA-1-NP	IA	-	N	Radon	OSA; Tedlar, 1-L	grab; 500 mL
JBLM-2 / DUP-1	IA	-	FD	Radon	OSA; Tedlar, 1-L	grab; 500 mL; duplicate at 2-IA-1-BL

**QAPP Worksheet #26 & 27: Sample Handling, Custody, and Disposal**  
**(UFP-QAPP Manual Section 3.3)**  
**(EPA 2106-G-05 Section 2.3.3)**

Sampling Organization: GSI

Laboratory: ALS/Columbia Analytical Services (Summas) and USC (Tedlars for Radon Analysis)

Method of sample delivery (shipper/carrier): FedEx

Number of days from reporting until sample disposal 30

<b>Activity</b>	<b>Organization and title or position of person responsible for the activity</b>	<b>SOP reference</b>
Sample labeling	GSI/ Field Lead Versar/ Field Lead (groundwater sample only)	QAPP
Chain-of-custody form completion	GSI / Field Lead	QAPP
Packaging	GSI / Field Lead	QAPP
Shipping coordination	GSI / Field Lead	QAPP
Sample receipt, inspection, & log-in	ALS/Columbia (Summas) USC (Radon)	Lab SOP Lab SOP
Sample custody and storage	ALS/Columbia (Summas) USC (Radon)	Lab SOP Lab SOP

<b>Activity</b>	<b>Organization and title or position of person responsible for the activity</b>	<b>SOP reference</b>
Sample disposal	ALS/Columbia (Summas) USC (Radon)	Lab SOP Lab SOP

**QAPP Worksheet #18: Sampling Locations and Methods**  
**(UFP-QAPP Manual Section 3.1.1 and 3.1.2)**  
**(EPA 2106-G-05 Section 2.3.1 and 2.3.2)**

Location ID/ Sample ID	Matrix <sup>1</sup>	Depth (ft BGS)	Type <sup>2</sup>	Analyte/ Analytical Group	Sampling SOP	Comments
SANG-1 / INDOOR-C1	IA	-	N	VOC	CON; Summa, 6-L	8-hr FC; summa set on floor
SANG-1 / MW-16	GW	3 - 8	N	VOC	CON; VOA vials	No purge; 2 vials to Alpha for 8260
SANG-1 / OUTDOOR-C1	AA	-	N	VOC	CON; Summa, 6-L	8-hr FC; summa set on ground; was AMBIENT-C1 on the label.
SANG-1 / SS-1C	SS	0.5	N	VOC	CON; Summa, 6-L	grab
SANG-1 / SS-2C	SS	0.5	N	VOC	CON; Summa, 6-L	grab
SANG-1 / SS-3C	SS	0.5	N	VOC	CON; Summa, 6-L	grab
SANG-1 / INDOOR-1	IA	-	N	Isotope	CSI; Sorbent tubes	sampling 9/18 9:51 - 9/18 16:22
SANG-1 / INDOOR-1 OVERNIGHT	IA	-	N	Isotope	CSI; Sorbent tubes	sampling 9/19 16:40 - 9/20 8:17
SANG-1 / MW-16	GW	3 - 8	N	Isotope	CSI; VOA vials	No purge; 6 vials to OU
SANG-1 / SS-1	SS	0.5	N	Isotope	CSI; Sorbent tubes	sampling 9/19 11:45 - 9/19 16:40
SANG-1 / SS-2 1 HOUR	SS	0.5	N	Isotope	CSI; Sorbent tubes	sampling 9/19 9:46 - 9/19 10:49

<sup>1</sup>Key: GW = groundwater, AA = Ambient (outdoor) air, IA = Indoor Air, SS = Sub-slab

<sup>2</sup>Key: N = normal; FD = field duplicate

<sup>3</sup>Key: CON = conventional program; OSA = on-site GC/MS analysis program; CSI = compound-specific stable isotope program

SANG-1 / SS-2 HIGH	SS	0.5	N	Isotope	CSI; Sorbent tubes	sampling 9/18 14:49 - 9/18 16:44
SANG-1 / SS-2 LOW	SS	0.5	N	Isotope	CSI; Sorbent tubes	sampling 9/18 16:46 - 9/18 16:56
SANG-1 / TRIP BLANK	TB	-	TB	Isotope	CSI; Sorbent tubes	
SANG-1 / AMBIENT-1-BL	AA	-	N	Radon	OSA; Tedlar, 1-L	grab; 500 mL
SANG-1 / DUP-1	IA	-	FD	VOC	OSA; Summa, 6-L	Collected with Indoor-1- PP
SANG-1 / DUP-1	IA	-	FD	Radon	OSA; Tedlar, 1-L	grab; 500 mL
SANG-1 / INDOOR-1-BL	IA	-	N	Radon	OSA; Tedlar, 1-L	grab; 500 mL
SANG-1 / INDOOR-1-BL	IA	-	N	VOC	OSA; Summa, 6-L	grab; summa on floor
SANG-1 / INDOOR-1-NP	IA	-	N	VOC	OSA; Summa, 6-L	grab; summa on floor
SANG-1 / INDOOR-1-NP	IA	-	N	Radon	OSA; Tedlar, 1-L	grab; 500 mL
SANG-1 / INDOOR-1-PP	IA	-	N	VOC	OSA; Summa, 6-L	grab; summa on floor

**QAPP Worksheet #26 & 27: Sample Handling, Custody, and Disposal  
(UFP-QAPP Manual Section 3.3)  
(EPA 2106-G-05 Section 2.3.3)**

Sampling Organization:       GSI      

Laboratory:       ALS/Columbia Analytical Services (Summas) and USC (Tedlars for Radon Analysis)      

Method of sample delivery (shipper/carrier):       FedEx      

Number of days from reporting until sample disposal       30      

<b>Activity</b>	<b>Organization and title or position of person responsible for the activity</b>	<b>SOP reference</b>
Sample labeling	GSI/ Field Lead	QAPP
Chain-of-custody form completion	GSI / Field Lead	QAPP
Packaging	GSI / Field Lead	QAPP
Shipping coordination	GSI / Field Lead	QAPP
Sample receipt, inspection, & log-in	ALS/Columbia (Summas)	Lab SOP
	USC (Radon)	Lab SOP
Sample custody and storage	ALS/Columbia (Summas)	Lab SOP
	USC (Radon)	Lab SOP
Sample disposal	ALS/Columbia (Summas)	Lab Sop

<b>Activity</b>	<b>Organization and title or position of person responsible for the activity</b>	<b>SOP reference</b>
	USC (Radon)	Lab SOP

**QAPP Worksheet #18: Sampling Locations and Methods**  
**(UFP-QAPP Manual Section 3.1.1 and 3.1.2)**  
**(EPA 2106-G-05 Section 2.3.1 and 2.3.2)**

Location ID/ Sample ID	Matrix <sup>1</sup>	Depth (ft BGS)	Type <sup>2</sup>	Analyte/ Analytical Group	Sampling SOP	Comments
TAFB-1 / 1-IA-1-CON	IA	-	N	VOC	CON; Summa, 6-L	8-hr FC; summa set on ground
TAFB-1 / 1-IA-2-CON	IA	-	N	VOC	CON; Summa, 6-L	8-hr FC; summa set on ground
TAFB-1 / 1-IA-3-CON	IA	-	N	VOC	CON; Summa, 6-L	8-hr FC; summa set on ground
TAFB-1 / 1-SS-1-CON	SS	0.5	N	VOC	CON; Summa, 6-L	grab
TAFB-1 / 1-SS-2-CON	SS	0.5	N	VOC	CON; Summa, 6-L	grab
TAFB-1 / 1-SS-3-CON	SS	0.5	N	VOC	CON; Summa, 6-L	grab
TAFB-1 / 1-SS-3-CSI	SS	0.5	N	Isotope	CSI; Sorbent tubes	sampling 2/21 12:18 - 2/21 13:49
TAFB-1 / MW-5	GW	5 - 15	N	Isotope	CSI; VOA vials	
TAFB-1 / 1-AA-1-BL	AA	-	N	Radon	OSA; Tedlar, 1-L	grab; 500 mL
TAFB-1 / 1-IA-4-BL	IA	-	N	Radon	OSA; Tedlar, 1-L	grab; 500 mL
TAFB-1 / 1-IA-4-BL	IA	-	N	VOC	OSA; Summa, 6-L	grab; summa on ground
TAFB-1 / 1-IA-4-NP	IA	-	N	Radon	OSA; Tedlar, 1-L	grab; 500 mL
TAFB-1 / 1-IA-4-NP	IA	-	N	VOC	OSA; Summa, 6-L	grab; summa on ground
TAFB-1 / 1-IA-5-NP	IA	-	FD	Radon	OSA; Tedlar, 1-L	grab; 500 mL

<sup>1</sup>Key: GW = groundwater, AA = Ambient (outdoor) air, IA = Indoor Air, SS = Sub-slab

<sup>2</sup>Key: N = normal; FD = field duplicate

<sup>3</sup>Key: CON = conventional program; OSA = on-site GC/MS analysis program; CSI = compound-specific stable isotope program



TAFB-1 / 1-IA-5-NP	IA	-	FD	VOC	OSA; Summa, 6-L	grab; summa on ground
TAFB-2 / 2-AA-1-CON	AA	-	N	VOC	CON; Summa, 6-L	8-hr FC; summa set on ground
TAFB-2 / 2-IA-1-CON	IA	-	N	VOC	CON; Summa, 6-L	8-hr FC; summa set on ground
TAFB-2 / 2-IA-3-CON	IA	-	N	VOC	CON; Summa, 6-L	8-hr FC; summa set on ground
TAFB-2 / 2-SS-1-CON	SS	0.5	N	VOC	CON; Summa, 6-L	grab
TAFB-2 / 2-SS-2-CON	SS	0.5	N	VOC	CON; Summa, 6-L	grab
TAFB-2 / 2-SS-3-CON	SS	0.5	N	VOC	CON; Summa, 6-L	grab
TAFB-2 / MW-20s	GW	5 - 15	N	Isotope	CSI; VOA vials	
TAFB-2 / 2-IA-3-P1-CSI	IA	-	N	Isotope	CSI; Sorbent tubes	sampling near planted source 2/20 16:50 - 2/21 08:00
TAFB-2 / 2-IA-3-P2-CSI	IA	-	FD	Isotope	CSI; Sorbent tubes	sampling near planted source 2/20 16:50 - 2/21 08:00
TAFB-2 / 2-SS-3-CSI	SS	0.5	N	Isotope	CSI; Sorbent tubes	sampling 2/21 16:55 - 2/22 08:26

**QAPP Worksheet #26 & 27: Sample Handling, Custody, and Disposal  
(UFP-QAPP Manual Section 3.3)  
(EPA 2106-G-05 Section 2.3.3)**

Sampling Organization:       GSI      

Laboratory:       ALS/Columbia Analytical Services (Summas) and USC (Tedlars for Radon Analysis)      

Method of sample delivery (shipper/carrier):       FedEx      

Number of days from reporting until sample disposal       30      

<b>Activity</b>	<b>Organization and title or position of person responsible for the activity</b>	<b>SOP reference</b>
Sample labeling	GSI/ Field Lead Versar/ Field Lead (groundwater sample only)	QAPP
Chain-of-custody form completion	GSI / Field Lead	QAPP
Packaging	GSI / Field Lead	QAPP
Shipping coordination	GSI / Field Lead	QAPP
Sample receipt, inspection, & log-in	ALS/Columbia (Summas) USC (Radon)	Lab SOP Lab SOP
Sample custody and storage	ALS/Columbia (Summas)	Lab SOP

Activity	Organization and title or position of person responsible for the activity	SOP reference
	USC (Radon)	Lab SOP
Sample disposal	ALS/Columbia (Summas)	Lab SOP
	USC (Radon)	Lab SOP

**QAPP Worksheet #18: Sampling Locations and Methods**  
**(UFP-QAPP Manual Section 3.1.1 and 3.1.2)**  
**(EPA 2106-G-05 Section 2.3.1 and 2.3.2)**

Location ID/ Sample ID	Matrix <sup>1</sup>	Depth (ft BGS)	Type <sup>2</sup>	Analyte/ Analytical Group	Sampling SOP	Comments
FRAS-1 / 1-AA-1-CON	AA	-	N	VOC	CON; Summa, 6-L	8-hr FC; summa set on ground
FRAS-1 / 1-IA-1-CON	IA	-	N	VOC	CON; Summa, 6-L	8-hr FC; summa on cubicle cabinet
FRAS-1 / 1-IA-2-CON	IA	-	N	VOC	CON; Summa, 6-L	8-hr FC; summa on top of cabinet
FRAS-1 / 1-SS-1-CON	SS	0.5	N	VOC	CON; Summa, 6-L	grab
FRAS-1 / 1-SS-3-CON	SS	0.5	N	VOC	CON; Summa, 6-L	grab
FRAS-1 / 1-IA-3-CSI	IA	-	N	Isotope	CSI; Sorbent tubes	sampling 3/26 16:47 - 3/27 09:05
FRAS-1 / 1-IA-4-CSI	IA	-	N	Isotope	CSI; Sorbent tubes	sampling 3/26 16:50 - 3/27 09:05
FRAS-1 / 1-IA-4-CSI	IA	-	FD	Isotope	CSI; Sorbent tubes	sampling 3/27 15:49 - 3/28 09:45
FRAS-1 / 1-SG-6-CSI	SS	0.5	N	Isotope	CSI; Sorbent tubes	sampling 3/28 10:20 - 3/28 12:12
FRAS-1 / MW-139	GW	approx. 13	N	Isotope	CSI; VOA vials	
FRAS-1 / MW-CP-IV-1	GW	approx. 12.5	N	Isotope	CSI; VOA vials	

<sup>1</sup>Key: GW = groundwater, AA = Ambient (outdoor) air, IA = Indoor Air, SS = Sub-slab, SG = Soil-gas

<sup>2</sup>Key: N = normal; FD = field duplicate

<sup>3</sup>Key: CON = conventional program; OSA = on-site GC/MS analysis program; CSI = compound-specific stable isotope program

FRAS-1 / 1-AA-2	AA	-	N	Radon	OSA; Tedlar, 1-L	grab; 500 mL
FRAS-1 / 1-IA-3	IA	-	N	VOC	OSA; Summa, 6-L	grab; summa on ground
FRAS-1 / 1-IA-5	IA	-	N	Radon	OSA; Tedlar, 1-L	grab; 500 mL
FRAS-1 / 1-IA-5	IA	-	N	VOC	OSA; Summa, 6-L	grab; summa on desk
FRAS-1 / 1-IA-5	IA	-	FD	Radon	OSA; Tedlar, 1-L	grab; 500 mL
FRAS-1 / 1-IA-5	IA	-	FD	VOC	OSA; Summa, 6-L	grab; summa on desk
FRAS-1 / 1-IA-5-NP	IA	-	N	Radon	OSA; Tedlar, 1-L	grab; 500 mL
FRAS-1 / 1-IA-5-NP	IA	-	N	VOC	OSA; Summa, 6-L	grab; summa on desk
FRAS-2 / 2-AA-1-CON	AA	-	N	VOC	CON; Summa, 6-L	8-hr FC; summa set on ground
FRAS-2 / 2-IA-1-CON	IA	-	N	VOC	CON; Summa, 6-L	8-hr FC; summa set on ground
FRAS-2 / 2-IA-2-CON	IA	-	N	VOC	CON; Summa, 6-L	8-hr FC; summa set on ground
FRAS-2 / 2-SS-1-CON	SS	0.5	N	VOC	CON; Summa, 6-L	grab
FRAS-2 / 2-SS-2-CON	SS	0.5	N	VOC	CON; Summa, 6-L	grab
FRAS-2 / MW-136	GW	approx. 37	N	Isotope	CSI; VOA vials	
FRAS-2 / MW-156	GW	approx. 37.5	N	Isotope	CSI; VOA vials	
FRAS-2 / 2-SS-9	SS	-	N	Radon	OSA; Tedlar, 1-L	grab; 500 mL

**QAPP Worksheet #26 & 27: Sample Handling, Custody, and Disposal  
(UFP-QAPP Manual Section 3.3)  
(EPA 2106-G-05 Section 2.3.3)**

Sampling Organization:       GSI      

Laboratory:       ALS/Columbia Analytical Services (Summas) and USC (Tedlars for Radon Analysis)      

Method of sample delivery (shipper/carrier):       FedEx      

Number of days from reporting until sample disposal       30      

<b>Activity</b>	<b>Organization and title or position of person responsible for the activity</b>	<b>SOP reference</b>
Sample labeling	GSI/ Field Lead Versar/ Field Lead (groundwater sample only)	QAPP
Chain-of-custody form completion	GSI / Field Lead	QAPP
Packaging	GSI / Field Lead	QAPP
Shipping coordination	GSI / Field Lead	QAPP
Sample receipt, inspection, & log-in	ALS/Columbia (Summas) USC (Radon)	Lab SOP Lab SOP
Sample custody and storage	ALS/Columbia (Summas) USC (Radon)	Lab SOP Lab SOP

<b>Activity</b>	<b>Organization and title or position of person responsible for the activity</b>	<b>SOP reference</b>
Sample disposal	ALS/Columbia (Summas) USC (Radon)	Lab SOP Lab SOP

## **Appendix D.3: Laboratory Analytical Reports**



# Laboratory Analytical Reports

---

**Use of Compound-Specific Stable Isotope Analysis to Distinguish  
between Vapor Intrusion and Indoor Sources of VOCs  
ER-201025**

**Use of On-Site GC/MS Analysis to Distinguish between Vapor  
Intrusion and Indoor Sources of VOCs  
ER-201119**

# **Joint Base Lewis-McChord, Washington**

## LABORATORY REPORT

August 10, 2012

Tom McHugh  
GSI Environmental Inc.  
2211 Norfolk, Suite 1000  
Houston, TX 77098

**RE: ESTCP / JBLM Long Center / G-3585 / 3669**

Dear Tom:

Enclosed are the results of the samples submitted to our laboratory on July 27, 2012. For your reference, these analyses have been assigned our service request number P1203080.

All analyses were performed according to our laboratory's NELAP and DoD-ELAP-approved quality assurance program. The test results meet requirements of the current NELAP and DoD-ELAP standards, where applicable, and except as noted in the laboratory case narrative provided. For a specific list of NELAP and DoD-ELAP-accredited analytes, refer to the certifications section at [www.caslab.com](http://www.caslab.com). Results are intended to be considered in their entirety and apply only to the samples analyzed and reported herein.

Columbia Analytical Services, Inc. dba ALS Environmental (ALS) is certified by the California Department of Health Services, NELAP Laboratory Certificate No. 02115CA; Arizona Department of Health Services, Certificate No. AZ0694; Florida Department of Health, NELAP Certification E871020; New Jersey Department of Environmental Protection, NELAP Laboratory Certification ID #CA009; New York State Department of Health, NELAP NY Lab ID No: 11221; Oregon Environmental Laboratory Accreditation Program, NELAP ID: CA200007; The American Industrial Hygiene Association, Laboratory #101661; United States Department of Defense Environmental Laboratory Accreditation Program (DoD-ELAP), Certificate No. L11-203; Pennsylvania Registration No. 68-03307; TX Commission of Environmental Quality, NELAP ID T104704413-12-3; Minnesota Department of Health, NELAP Certificate No. 362188; Washington State Department of Ecology, ELAP Lab ID: C946, State of Utah Department of Health, NELAP Certificate No. CA01527Z012-Z; Los Angeles Department of Building and Safety, Approval No: TA00001. Each of the certifications listed above have an explicit Scope of Accreditation that applies to specific matrices/methods/analytes; therefore, please contact me for information corresponding to a particular certification.

If you have any questions, please call me at (805) 526-7161.

Respectfully submitted,

**ALS | Environmental**



Digitally Signed By Sue Anderson at 3:06 pm, Aug 10, 2012

Sue Anderson  
Project Manager

Client: GSI Environmental Inc. Service Request No: P1203080  
Project: ESTCP / JBLM Long Center / G-3585 / 3669

---

## CASE NARRATIVE

The samples were received intact under chain of custody on July 27, 2012 and were stored in accordance with the analytical method requirements. Please refer to the sample acceptance check form for additional information. The results reported herein are applicable only to the condition of the samples at the time of sample receipt.

### Volatile Organic Compound Analysis

The samples were analyzed in SIM mode for selected volatile organic compounds in accordance with EPA Method TO-15 from the Compendium of Methods for the Determination of Toxic Organic Compounds in Ambient Air, Second Edition (EPA/625/R-96/010b), January, 1999. The analytical system was comprised of a gas chromatograph / mass spectrometer (GC/MS) interfaced to a whole-air preconcentrator.

---

*The results of analyses are given in the attached laboratory report. All results are intended to be considered in their entirety, and Columbia Analytical Services, Inc. dba ALS Environmental (ALS) is not responsible for utilization of less than the complete report.*

*Use of Columbia Analytical Services, Inc. dba ALS Environmental (ALS)'s Name. Client shall not use ALS's name or trademark in any marketing or reporting materials, press releases or in any other manner ("Materials") whatsoever and shall not attribute to AALS any test result, tolerance or specification derived from ALS's data ("Attribution") without ALS's prior written consent, which may be withheld by ALS for any reason in its sole discretion. To request ALS's consent, Client shall provide copies of the proposed Materials or Attribution and describe in writing Client's proposed use of such Materials or Attribution. If ALS has not provided written approval of the Materials or Attribution within ten (10) days of receipt from Client, Client's request to use ALS's name or trademark in any Materials or Attribution shall be deemed denied. ALS may, in its discretion, reasonably charge Client for its time in reviewing Materials or Attribution requests. Client acknowledges and agrees that the unauthorized use of ALS's name or trademark may cause ALS to incur irreparable harm for which the recovery of money damages will be inadequate. Accordingly, Client acknowledges and agrees that a violation shall justify preliminary injunctive relief. For questions contact the laboratory.*

DETAIL SUMMARY REPORT

Client: GSI Environmental Inc.  
 Project ID: ESTCP / JBLM Long Center / G-3585 / 3669

Service Request: P1203080

Date Received: 7/27/2012  
 Time Received: 09:45

TO-15 - VOC SIM

Client Sample ID	Lab Code	Matrix	Date Collected	Time Collected	Container ID	Pi1 (psig)	Pf1 (psig)	
1-AA-1-CON	P1203080-001	Air	7/24/2012	16:00	AC00717	-2.63	3.55	X
1-IA-1-CON	P1203080-002	Air	7/24/2012	15:57	AC01368	-2.17	3.63	X
1-IA-2-CON	P1203080-003	Air	7/24/2012	15:58	AC00081	-1.86	3.54	X
1-SS-1-CON	P1203080-004	Air	7/24/2012	10:46	AC01782	-3.38	3.58	X
1-SS-2-CON	P1203080-005	Air	7/24/2012	11:06	AC00480	-0.97	3.56	X
1-SS-3-CON	P1203080-006	Air	7/24/2012	11:27	AC01637	-5.17	2.56	X
2-AA-1-CON	P1203080-007	Air	7/24/2012	15:25	AC01154	-0.75	3.52	X
2-IA-1-CON	P1203080-008	Air	7/24/2012	15:21	AC01900	-2.57	3.69	X
2-SS-1-CON	P1203080-009	Air	7/24/2012	14:49	AS00103	-0.93	3.56	X
2-SS-2-CON	P1203080-010	Air	7/24/2012	15:05	AC01190	-0.21	3.55	X
1-IA-3-BL	P1203080-011	Air	7/25/2012	08:53	AC00714	0.33	3.72	X
1-IA-3-PP	P1203080-012	Air	7/25/2012	09:57	AC00229	0.31	3.55	X
2-SS-3-CON-Resample	P1203080-013	Air	7/26/2012	08:08	AC01034	-0.90	3.50	X
2-IA-1-BL	P1203080-014	Air	7/26/2012	08:36	AC00748	0.33	3.56	X
2-IA-1-NP	P1203080-015	Air	7/26/2012	10:15	AC01165	0.41	3.56	X
DUP-1	P1203080-016	Air	7/26/2012	00:00	AC00822	0.38	3.75	X
1-IA-3-NP	P1203080-017	Air	7/25/2012	11:06	AC01327	0.37	3.65	X

2655 Park Center Drive, Suite A  
 Simi Valley, California 93065  
 Phone (805) 526-7161  
 Fax (805) 526-7270

**Requested Turnaround Time in Business Days (Surcharges) please circle**  
 1 Day (100%) 2 Day (75%) 3 Day (50%) 4 Day (35%) 5 Day (25%) 10 Day-Standard

CAS Project No. R223052

Company Name & Address (Reporting Information)  
CSI Services  
0241 Norwalk Ste 1000  
Houston TX 77098

Project Name  
ESTEP / STBM LogCater

Project Number  
G-3585/3669

P.O. # / Billing Information

Project Manager  
T. M. Kelly

Phone  
713-572-6300

Fax

Email Address for Result Reporting  
trm@kellyeng.com / tmkelly@csimotion.com

Sampler (Print & Sign)  
UMB / TEM / TTT

Client Sample ID	Laboratory ID Number	Date Collected	Time Collected	Canister ID (Bar code #, AC, SC, etc.)	Flow Controller ID (Bar code #, FC #)	Canister Start Pressure "Hg	Canister End Pressure "Hg/psig	Sample Volume	Analysis Method	Comments
1-AA-1-CON	1-272	7/24/12	0824-1600	AC00717	FCAD00473	-30	-5.5	6-L		
1-IA-1-CON	2-223	7/24/12	0830-1557	AC01368	FCAD00556	-29.5	-5			
1-EA-2-CON	3-194	7/24/12	0835-1558	AC00081	FCAD00561	-30	-4			
1-SS-1-CON	4-344	7/24/12	1040-1046	AC01782	None	-29.5	-7.5			Subst lab, grab
1-SS-2-CON	5-102	7/24/12	1103-1106	AC00480	None	-30	-2			"
1-SS-3-CON	6-573	7/24/12	1119-1127	AC01637	None	-30	-11			"
2-AA-1-CON	7-114	7/24/12	0802-1525	AC01154	FCAD00496	-30	-2			
2-IA-1-CON	8-262	7/24/12	0758-1521	AC01900	FCAD01966	-30	-5.5			
2-SS-1-CON	9-098	7/24/12	1448-1449	AS00103	None	-30	-1.5			Subst lab, grab
2-SS-2-CON	10-020	7/24/12	1502-1505	AC01190	None	-30	0			"
2-SS-3-CON	11-033	7/24/12	1515-1518	AC01871	None	-30	-20			Do NOT ANALYZE
1-IA-3-BL	11-103D	7/25/12	0851-0853	AC00714	None	-30	0			grab (subst lab)
1-IA-3-PP	12-102S	7/25/12	0855-0857	AC00229	None	-30	0			"
2-SS-3-CON-Example	13-098	7/25/12	0808	AC01034	None	-30	-2			Subst lab, grab

**Report Tier Levels - please select**

Tier I - Results (Default if not specified) \_\_\_\_\_

Tier II (Results + QC Summaries) \_\_\_\_\_

Tier III (Results + QC & Calibration Summaries) \_\_\_\_\_

Tier IV (Data Validation Package) 10% Surcharge \_\_\_\_\_

EDD required (Yes/No) \_\_\_\_\_

Type: grab

Relinquished by: (Signature) \_\_\_\_\_ Date: 7/26/12 Time: 1150

Received by: (Signature) \_\_\_\_\_ Date: 7/26/12 Time: 0845

Project Requirements (MPLs, QAPP) \_\_\_\_\_

Cooler / Blank Temperature \_\_\_\_\_ °C



**Sample Acceptance Check Form**

Client: GSI Environmental Inc. Work order: P1203080

Project: ESTCP / JBLM Long Center / G-3585 / 3669

Sample(s) received on: 7/27/12 Date opened: 7/27/12 by: MZAMORA

**Note:** This form is used for all samples received by CAS. The use of this form for custody seals is strictly meant to indicate presence/absence and not as an indication of compliance or nonconformity. Thermal preservation and pH will only be evaluated either at the request of the client and/or as required by the method/SOP.

- |  | <u>Yes</u>                          | <u>No</u>                           | <u>N/A</u>                          |
|--|-------------------------------------|-------------------------------------|-------------------------------------|
| 1 Were <b>sample containers</b> properly marked with client sample ID?   | <input checked="" type="checkbox"/> | <input type="checkbox"/>            | <input type="checkbox"/>            |
| 2 Container(s) <b>supplied by CAS</b> ?  | <input checked="" type="checkbox"/> | <input type="checkbox"/>            | <input type="checkbox"/>            |
| 3 Did <b>sample containers</b> arrive in good condition?   | <input checked="" type="checkbox"/> | <input type="checkbox"/>            | <input type="checkbox"/>            |
| 4 Were <b>chain-of-custody</b> papers used and filled out?   | <input checked="" type="checkbox"/> | <input type="checkbox"/>            | <input type="checkbox"/>            |
| 5 Did <b>sample container labels</b> and/or tags agree with custody papers?                                      | <input checked="" type="checkbox"/> | <input type="checkbox"/>            | <input type="checkbox"/>            |
| 6 Was <b>sample volume</b> received adequate for analysis?   | <input checked="" type="checkbox"/> | <input type="checkbox"/>            | <input type="checkbox"/>            |
| 7 Are samples within specified holding times?  | <input checked="" type="checkbox"/> | <input type="checkbox"/>            | <input type="checkbox"/>            |
| 8 Was proper <b>temperature</b> (thermal preservation) of cooler at receipt adhered to?                          | <input type="checkbox"/>            | <input type="checkbox"/>            | <input checked="" type="checkbox"/> |
| 9 Was a <b>trip blank</b> received?  | <input type="checkbox"/>            | <input checked="" type="checkbox"/> | <input type="checkbox"/>            |
| 10 Were <b>custody seals</b> on outside of cooler/Box?   | <input type="checkbox"/>            | <input checked="" type="checkbox"/> | <input type="checkbox"/>            |
| Location of seal(s)? _____ Sealing Lid?  | <input type="checkbox"/>            | <input type="checkbox"/>            | <input checked="" type="checkbox"/> |
| Were signature and date included?  | <input type="checkbox"/>            | <input type="checkbox"/>            | <input checked="" type="checkbox"/> |
| Were seals intact?   | <input type="checkbox"/>            | <input type="checkbox"/>            | <input checked="" type="checkbox"/> |
| Were custody seals on outside of sample container?   | <input type="checkbox"/>            | <input checked="" type="checkbox"/> | <input type="checkbox"/>            |
| Location of seal(s)? _____ Sealing Lid?  | <input type="checkbox"/>            | <input type="checkbox"/>            | <input checked="" type="checkbox"/> |
| Were signature and date included?  | <input type="checkbox"/>            | <input type="checkbox"/>            | <input checked="" type="checkbox"/> |
| Were seals intact?   | <input type="checkbox"/>            | <input type="checkbox"/>            | <input checked="" type="checkbox"/> |
| 11 Do containers have appropriate <b>preservation</b> , according to method/SOP or Client specified information? | <input type="checkbox"/>            | <input type="checkbox"/>            | <input checked="" type="checkbox"/> |
| Is there a client indication that the submitted samples are <b>pH</b> preserved?                                 | <input type="checkbox"/>            | <input type="checkbox"/>            | <input checked="" type="checkbox"/> |
| Were <b>VOA vials</b> checked for presence/absence of air bubbles?   | <input type="checkbox"/>            | <input type="checkbox"/>            | <input checked="" type="checkbox"/> |
| Does the client/method/SOP require that the analyst check the sample pH and <u>if necessary</u> alter it?        | <input type="checkbox"/>            | <input type="checkbox"/>            | <input checked="" type="checkbox"/> |
| 12 <b>Tubes:</b> Are the tubes capped and intact?  | <input type="checkbox"/>            | <input type="checkbox"/>            | <input checked="" type="checkbox"/> |
| Do they contain moisture?  | <input type="checkbox"/>            | <input type="checkbox"/>            | <input checked="" type="checkbox"/> |
| 13 <b>Badges:</b> Are the badges properly capped and intact?   | <input type="checkbox"/>            | <input type="checkbox"/>            | <input checked="" type="checkbox"/> |
| Are dual bed badges separated and individually capped and intact?  | <input type="checkbox"/>            | <input type="checkbox"/>            | <input checked="" type="checkbox"/> |

Lab Sample ID	Container Description	Required pH *	Received pH	Adjusted pH	VOA Headspace (Presence/Absence)	Receipt / Preservation Comments
P1203080-001.01	6.0 L Ambient Can					
P1203080-002.01	6.0 L Ambient Can					
P1203080-003.01	6.0 L Ambient Can					
P1203080-004.01	6.0 L Ambient Can					
P1203080-005.01	6.0 L Ambient Can					
P1203080-006.01	6.0 L Ambient Can					
P1203080-007.01	6.0 L Ambient Can					
P1203080-008.01	6.0 L Ambient Can					

Explain any discrepancies: (include lab sample ID numbers): \_\_\_\_\_





RESULTS OF ANALYSIS

Page 1 of 1

**Client:** GSI Environmental Inc.

**Client Sample ID:** 1-AA-1-CON

**Client Project ID:** ESTCP / JBLM Long Center / G-3585 / 3669

CAS Project ID: P1203080

CAS Sample ID: P1203080-001

Test Code: EPA TO-15 SIM

Date Collected: 7/24/12

Instrument ID: Tekmar AUTOCAN/Agilent 5973N/HP6890A/MS7

Date Received: 7/27/12

Analyst: Wida Ang

Date Analyzed: 8/1/12

Sampling Media: 6.0 L Summa Canister

Volume(s) Analyzed: 1.00 Liter(s)

Test Notes:

Container ID: AC00717

Initial Pressure (psig): -2.63 Final Pressure (psig): 3.55

Canister Dilution Factor: 1.51

CAS #	Compound	Result µg/m <sup>3</sup>	MRL µg/m <sup>3</sup>	Result ppbV	MRL ppbV	Data Qualifier
75-01-4	Vinyl Chloride	ND	0.038	ND	0.015	
75-35-4	1,1-Dichloroethene	ND	0.038	ND	0.0095	
156-60-5	trans-1,2-Dichloroethene	ND	0.038	ND	0.0095	
156-59-2	cis-1,2-Dichloroethene	ND	0.038	ND	0.0095	
107-06-2	1,2-Dichloroethane	ND	0.038	ND	0.0093	
71-55-6	1,1,1-Trichloroethane	ND	0.038	ND	0.0069	
79-01-6	Trichloroethene	ND	0.038	ND	0.0070	
127-18-4	Tetrachloroethene	<b>0.052</b>	0.038	<b>0.0077</b>	0.0056	

ND = Compound was analyzed for, but not detected above the laboratory reporting limit.

MRL = Method Reporting Limit - The minimum quantity of a target analyte that can be confidently determined by the referenced method.

RESULTS OF ANALYSIS

Page 1 of 1

**Client:** GSI Environmental Inc.

**Client Sample ID:** 1-IA-1-CON

**Client Project ID:** ESTCP / JBLM Long Center / G-3585 / 3669

CAS Project ID: P1203080

CAS Sample ID: P1203080-002

Test Code: EPA TO-15 SIM

Instrument ID: Tekmar AUTOCAN/Agilent 5973N/HP6890A/MS7

Analyst: Wida Ang

Sampling Media: 6.0 L Summa Canister

Test Notes:

Container ID: AC01368

Date Collected: 7/24/12

Date Received: 7/27/12

Date Analyzed: 8/1/12

Volume(s) Analyzed: 1.00 Liter(s)

Initial Pressure (psig): -2.17 Final Pressure (psig): 3.63

Canister Dilution Factor: 1.46

CAS #	Compound	Result µg/m <sup>3</sup>	MRL µg/m <sup>3</sup>	Result ppbV	MRL ppbV	Data Qualifier
75-01-4	Vinyl Chloride	ND	0.037	ND	0.014	
75-35-4	1,1-Dichloroethene	ND	0.037	ND	0.0092	
156-60-5	trans-1,2-Dichloroethene	<b>2.3</b>	0.037	<b>0.59</b>	0.0092	
156-59-2	cis-1,2-Dichloroethene	ND	0.037	ND	0.0092	
107-06-2	1,2-Dichloroethane	<b>0.053</b>	0.037	<b>0.013</b>	0.0090	
71-55-6	1,1,1-Trichloroethane	<b>0.042</b>	0.037	<b>0.0077</b>	0.0067	
79-01-6	Trichloroethene	<b>1.5</b>	0.037	<b>0.28</b>	0.0068	
127-18-4	Tetrachloroethene	<b>0.18</b>	0.037	<b>0.026</b>	0.0054	

ND = Compound was analyzed for, but not detected above the laboratory reporting limit.

MRL = Method Reporting Limit - The minimum quantity of a target analyte that can be confidently determined by the referenced method.

RESULTS OF ANALYSIS

Page 1 of 1

**Client:** GSI Environmental Inc.

**Client Sample ID:** 1-IA-2-CON

**Client Project ID:** ESTCP / JBLM Long Center / G-3585 / 3669

CAS Project ID: P1203080

CAS Sample ID: P1203080-003

Test Code: EPA TO-15 SIM

Date Collected: 7/24/12

Instrument ID: Tekmar AUTOCAN/Agilent 5973N/HP6890A/MS7

Date Received: 7/27/12

Analyst: Wida Ang

Date Analyzed: 8/1/12

Sampling Media: 6.0 L Summa Canister

Volume(s) Analyzed: 1.00 Liter(s)

Test Notes:

Container ID: AC00081

Initial Pressure (psig): -1.86 Final Pressure (psig): 3.54

Canister Dilution Factor: 1.42

CAS #	Compound	Result µg/m <sup>3</sup>	MRL µg/m <sup>3</sup>	Result ppbV	MRL ppbV	Data Qualifier
75-01-4	Vinyl Chloride	ND	0.036	ND	0.014	
75-35-4	1,1-Dichloroethene	ND	0.036	ND	0.0090	
156-60-5	trans-1,2-Dichloroethene	<b>1.6</b>	0.036	<b>0.39</b>	0.0090	
156-59-2	cis-1,2-Dichloroethene	ND	0.036	ND	0.0090	
107-06-2	1,2-Dichloroethane	<b>0.050</b>	0.036	<b>0.012</b>	0.0088	
71-55-6	1,1,1-Trichloroethane	<b>0.039</b>	0.036	<b>0.0072</b>	0.0065	
79-01-6	Trichloroethene	<b>1.2</b>	0.036	<b>0.23</b>	0.0066	
127-18-4	Tetrachloroethene	<b>0.15</b>	0.036	<b>0.021</b>	0.0052	

ND = Compound was analyzed for, but not detected above the laboratory reporting limit.

MRL = Method Reporting Limit - The minimum quantity of a target analyte that can be confidently determined by the referenced method.

RESULTS OF ANALYSIS

Page 1 of 1

**Client:** GSI Environmental Inc.

**Client Sample ID:** 1-SS-1-CON

**Client Project ID:** ESTCP / JBLM Long Center / G-3585 / 3669

CAS Project ID: P1203080

CAS Sample ID: P1203080-004

Test Code: EPA TO-15 SIM

Date Collected: 7/24/12

Instrument ID: Tekmar AUTOCAN/Agilent 5973N/HP6890A/MS7

Date Received: 7/27/12

Analyst: Wida Ang

Date Analyzed: 8/1/12

Sampling Media: 6.0 L Summa Canister

Volume(s) Analyzed: 0.30 Liter(s)

Test Notes:

Container ID: AC01782

Initial Pressure (psig): -3.38 Final Pressure (psig): 3.58

Canister Dilution Factor: 1.61

CAS #	Compound	Result µg/m <sup>3</sup>	MRL µg/m <sup>3</sup>	Result ppbV	MRL ppbV	Data Qualifier
75-01-4	Vinyl Chloride	ND	0.13	ND	0.053	
75-35-4	1,1-Dichloroethene	ND	0.13	ND	0.034	
156-60-5	trans-1,2-Dichloroethene	ND	0.13	ND	0.034	
156-59-2	cis-1,2-Dichloroethene	ND	0.13	ND	0.034	
107-06-2	1,2-Dichloroethane	<b>0.65</b>	0.13	<b>0.16</b>	0.033	
71-55-6	1,1,1-Trichloroethane	<b>3.4</b>	0.13	<b>0.61</b>	0.025	
79-01-6	Trichloroethene	<b>43</b>	0.13	<b>8.1</b>	0.025	
127-18-4	Tetrachloroethene	<b>17</b>	0.13	<b>2.5</b>	0.020	

ND = Compound was analyzed for, but not detected above the laboratory reporting limit.

MRL = Method Reporting Limit - The minimum quantity of a target analyte that can be confidently determined by the referenced method.

RESULTS OF ANALYSIS

Page 1 of 1

**Client:** GSI Environmental Inc.

**Client Sample ID:** 1-SS-2-CON

**Client Project ID:** ESTCP / JBLM Long Center / G-3585 / 3669

CAS Project ID: P1203080

CAS Sample ID: P1203080-005

Test Code: EPA TO-15 SIM

Date Collected: 7/24/12

Instrument ID: Tekmar AUTOCAN/Agilent 5973N/HP6890A/MS7

Date Received: 7/27/12

Analyst: Wida Ang

Date Analyzed: 8/1/12

Sampling Media: 6.0 L Summa Canister

Volume(s) Analyzed: 0.060 Liter(s)

Test Notes:

Container ID: AC00480

Initial Pressure (psig): -0.97 Final Pressure (psig): 3.56

Canister Dilution Factor: 1.33

CAS #	Compound	Result µg/m <sup>3</sup>	MRL µg/m <sup>3</sup>	Result ppbV	MRL ppbV	Data Qualifier
75-01-4	Vinyl Chloride	ND	0.55	ND	0.22	
75-35-4	1,1-Dichloroethene	ND	0.55	ND	0.14	
156-60-5	trans-1,2-Dichloroethene	<b>0.57</b>	0.55	<b>0.14</b>	0.14	
156-59-2	cis-1,2-Dichloroethene	ND	0.55	ND	0.14	
107-06-2	1,2-Dichloroethane	ND	0.55	ND	0.14	
71-55-6	1,1,1-Trichloroethane	<b>6.2</b>	0.55	<b>1.1</b>	0.10	
79-01-6	Trichloroethene	<b>320</b>	0.55	<b>60</b>	0.10	
127-18-4	Tetrachloroethene	<b>22</b>	0.55	<b>3.3</b>	0.082	

ND = Compound was analyzed for, but not detected above the laboratory reporting limit.

MRL = Method Reporting Limit - The minimum quantity of a target analyte that can be confidently determined by the referenced method.

RESULTS OF ANALYSIS

Page 1 of 1

**Client:** GSI Environmental Inc.

**Client Sample ID:** 1-SS-3-CON

**Client Project ID:** ESTCP / JBLM Long Center / G-3585 / 3669

CAS Project ID: P1203080

CAS Sample ID: P1203080-006

Test Code: EPA TO-15 SIM

Instrument ID: Tekmar AUTOCAN/Agilent 5973N/HP6890A/MS7

Analyst: Wida Ang

Sampling Media: 6.0 L Summa Canister

Test Notes:

Container ID: AC01637

Date Collected: 7/24/12

Date Received: 7/27/12

Date Analyzed: 8/1/12

Volume(s) Analyzed: 0.050 Liter(s)

Initial Pressure (psig): -5.17      Final Pressure (psig): 2.56

Canister Dilution Factor: 1.81

CAS #	Compound	Result	MRL	Result	MRL	Data Qualifier
		µg/m <sup>3</sup>	µg/m <sup>3</sup>	ppbV	ppbV	
75-01-4	Vinyl Chloride	ND	0.91	ND	0.35	
75-35-4	1,1-Dichloroethene	ND	0.91	ND	0.23	
156-60-5	trans-1,2-Dichloroethene	ND	0.91	ND	0.23	
156-59-2	cis-1,2-Dichloroethene	ND	0.91	ND	0.23	
107-06-2	1,2-Dichloroethane	<b>3.2</b>	0.91	<b>0.78</b>	0.22	
71-55-6	1,1,1-Trichloroethane	<b>9.0</b>	0.91	<b>1.7</b>	0.17	
79-01-6	Trichloroethene	<b>1.5</b>	0.91	<b>0.28</b>	0.17	
127-18-4	Tetrachloroethene	<b>21</b>	0.91	<b>3.1</b>	0.13	

ND = Compound was analyzed for, but not detected above the laboratory reporting limit.

MRL = Method Reporting Limit - The minimum quantity of a target analyte that can be confidently determined by the referenced method.

RESULTS OF ANALYSIS

Page 1 of 1

**Client:** GSI Environmental Inc.

**Client Sample ID:** 2-AA-1-CON

**Client Project ID:** ESTCP / JBLM Long Center / G-3585 / 3669

CAS Project ID: P1203080

CAS Sample ID: P1203080-007

Test Code: EPA TO-15 SIM

Date Collected: 7/24/12

Instrument ID: Tekmar AUTOCAN/Agilent 5973N/HP6890A/MS7

Date Received: 7/27/12

Analyst: Wida Ang

Date Analyzed: 8/1/12

Sampling Media: 6.0 L Summa Canister

Volume(s) Analyzed: 1.00 Liter(s)

Test Notes:

Container ID: AC01154

Initial Pressure (psig): -0.75      Final Pressure (psig): 3.52

Canister Dilution Factor: 1.31

CAS #	Compound	Result µg/m <sup>3</sup>	MRL µg/m <sup>3</sup>	Result ppbV	MRL ppbV	Data Qualifier
75-01-4	Vinyl Chloride	ND	0.033	ND	0.013	
75-35-4	1,1-Dichloroethene	ND	0.033	ND	0.0083	
156-60-5	trans-1,2-Dichloroethene	ND	0.033	ND	0.0083	
156-59-2	cis-1,2-Dichloroethene	ND	0.033	ND	0.0083	
107-06-2	1,2-Dichloroethane	<b>0.038</b>	0.033	<b>0.0093</b>	0.0081	
71-55-6	1,1,1-Trichloroethane	ND	0.033	ND	0.0060	
79-01-6	Trichloroethene	ND	0.033	ND	0.0061	
127-18-4	Tetrachloroethene	<b>0.053</b>	0.033	<b>0.0079</b>	0.0048	

ND = Compound was analyzed for, but not detected above the laboratory reporting limit.

MRL = Method Reporting Limit - The minimum quantity of a target analyte that can be confidently determined by the referenced method.



RESULTS OF ANALYSIS

Page 1 of 1

**Client:** GSI Environmental Inc.

**Client Sample ID:** 2-IA-1-CON

**Client Project ID:** ESTCP / JBLM Long Center / G-3585 / 3669

CAS Project ID: P1203080

CAS Sample ID: P1203080-008

Test Code: EPA TO-15 SIM

Date Collected: 7/24/12

Instrument ID: Tekmar AUTOCAN/Agilent 5973N/HP6890A/MS7

Date Received: 7/27/12

Analyst: Wida Ang

Date Analyzed: 8/1/12

Sampling Media: 6.0 L Summa Canister

Volume(s) Analyzed: 1.00 Liter(s)

Test Notes:

Container ID: AC01900

Initial Pressure (psig): -2.57 Final Pressure (psig): 3.69

Canister Dilution Factor: 1.52

CAS #	Compound	Result µg/m <sup>3</sup>	MRL µg/m <sup>3</sup>	Result ppbV	MRL ppbV	Data Qualifier
75-01-4	Vinyl Chloride	ND	0.038	ND	0.015	
75-35-4	1,1-Dichloroethene	ND	0.038	ND	0.0096	
156-60-5	trans-1,2-Dichloroethene	ND	0.038	ND	0.0096	
156-59-2	cis-1,2-Dichloroethene	ND	0.038	ND	0.0096	
107-06-2	1,2-Dichloroethane	ND	0.038	ND	0.0094	
71-55-6	1,1,1-Trichloroethane	ND	0.038	ND	0.0070	
79-01-6	Trichloroethene	<b>0.072</b>	0.038	<b>0.013</b>	0.0071	
127-18-4	Tetrachloroethene	<b>0.24</b>	0.038	<b>0.035</b>	0.0056	

ND = Compound was analyzed for, but not detected above the laboratory reporting limit.

MRL = Method Reporting Limit - The minimum quantity of a target analyte that can be confidently determined by the referenced method.

RESULTS OF ANALYSIS

Page 1 of 1

**Client:** GSI Environmental Inc.

**Client Sample ID:** 2-SS-1-CON

**Client Project ID:** ESTCP / JBLM Long Center / G-3585 / 3669

CAS Project ID: P1203080

CAS Sample ID: P1203080-009

Test Code: EPA TO-15 SIM

Date Collected: 7/24/12

Instrument ID: Tekmar AUTOCAN/Agilent 5973N/HP6890A/MS7

Date Received: 7/27/12

Analyst: Wida Ang

Date Analyzed: 8/2/12

Sampling Media: 6.0 L Summa Canister

Volume(s) Analyzed: 1.00 Liter(s)

Test Notes:

Container ID: AS00103

Initial Pressure (psig): -0.93      Final Pressure (psig): 3.56

Canister Dilution Factor: 1.33

CAS #	Compound	Result	MRL	Result	MRL	Data Qualifier
		µg/m <sup>3</sup>	µg/m <sup>3</sup>	ppbV	ppbV	
75-01-4	Vinyl Chloride	ND	0.033	ND	0.013	
75-35-4	1,1-Dichloroethene	<b>0.035</b>	0.033	<b>0.0087</b>	0.0084	
156-60-5	trans-1,2-Dichloroethene	ND	0.033	ND	0.0084	
156-59-2	cis-1,2-Dichloroethene	ND	0.033	ND	0.0084	
107-06-2	1,2-Dichloroethane	<b>0.24</b>	0.033	<b>0.059</b>	0.0082	
71-55-6	1,1,1-Trichloroethane	<b>1.7</b>	0.033	<b>0.31</b>	0.0061	
79-01-6	Trichloroethene	<b>0.034</b>	0.033	<b>0.0063</b>	0.0062	
127-18-4	Tetrachloroethene	<b>18</b>	0.033	<b>2.6</b>	0.0049	

ND = Compound was analyzed for, but not detected above the laboratory reporting limit.

MRL = Method Reporting Limit - The minimum quantity of a target analyte that can be confidently determined by the referenced method.

RESULTS OF ANALYSIS

Page 1 of 1

**Client:** GSI Environmental Inc.

**Client Sample ID:** 2-SS-2-CON

**Client Project ID:** ESTCP / JBLM Long Center / G-3585 / 3669

CAS Project ID: P1203080

CAS Sample ID: P1203080-010

Test Code: EPA TO-15 SIM

Date Collected: 7/24/12

Instrument ID: Tekmar AUTOCAN/Agilent 5973N/HP6890A/MS7

Date Received: 7/27/12

Analyst: Wida Ang

Date Analyzed: 8/2/12

Sampling Media: 6.0 L Summa Canister

Volume(s) Analyzed: 0.50 Liter(s)

Test Notes:

Container ID: AC01190

Initial Pressure (psig): -0.21 Final Pressure (psig): 3.55

Canister Dilution Factor: 1.26

CAS #	Compound	Result µg/m <sup>3</sup>	MRL µg/m <sup>3</sup>	Result ppbV	MRL ppbV	Data Qualifier
75-01-4	Vinyl Chloride	ND	0.063	ND	0.025	
75-35-4	1,1-Dichloroethene	ND	0.063	ND	0.016	
156-60-5	trans-1,2-Dichloroethene	ND	0.063	ND	0.016	
156-59-2	cis-1,2-Dichloroethene	ND	0.063	ND	0.016	
107-06-2	1,2-Dichloroethane	<b>0.30</b>	0.063	<b>0.075</b>	0.016	
71-55-6	1,1,1-Trichloroethane	<b>0.73</b>	0.063	<b>0.13</b>	0.012	
79-01-6	Trichloroethene	<b>1.8</b>	0.063	<b>0.33</b>	0.012	
127-18-4	Tetrachloroethene	<b>48</b>	0.063	<b>7.1</b>	0.0093	

ND = Compound was analyzed for, but not detected above the laboratory reporting limit.

MRL = Method Reporting Limit - The minimum quantity of a target analyte that can be confidently determined by the referenced method.

RESULTS OF ANALYSIS

Page 1 of 1

**Client:** GSI Environmental Inc.

**Client Sample ID:** 1-IA-3-BL

**Client Project ID:** ESTCP / JBLM Long Center / G-3585 / 3669

CAS Project ID: P1203080

CAS Sample ID: P1203080-011

Test Code: EPA TO-15 SIM

Date Collected: 7/25/12

Instrument ID: Tekmar AUTOCAN/Agilent 5973N/HP6890A/MS7

Date Received: 7/27/12

Analyst: #N/A

Date Analyzed: 8/1/12

Sampling Media: 6.0 L Summa Canister

Volume(s) Analyzed: 1.00 Liter(s)

Test Notes:

Container ID: AC00714

Initial Pressure (psig): 0.33      Final Pressure (psig): 3.72

Canister Dilution Factor: 1.23

CAS #	Compound	Result	MRL	Result	MRL	Data Qualifier
		µg/m <sup>3</sup>	µg/m <sup>3</sup>	ppbV	ppbV	
75-01-4	Vinyl Chloride	ND	0.031	ND	0.012	
75-35-4	1,1-Dichloroethene	ND	0.031	ND	0.0078	
156-60-5	trans-1,2-Dichloroethene	<b>2.2</b>	0.031	<b>0.56</b>	0.0078	
156-59-2	cis-1,2-Dichloroethene	ND	0.031	ND	0.0078	
107-06-2	1,2-Dichloroethane	<b>0.051</b>	0.031	<b>0.013</b>	0.0076	
71-55-6	1,1,1-Trichloroethane	<b>0.041</b>	0.031	<b>0.0075</b>	0.0056	
79-01-6	Trichloroethene	<b>2.0</b>	0.031	<b>0.37</b>	0.0057	
127-18-4	Tetrachloroethene	<b>0.22</b>	0.031	<b>0.032</b>	0.0045	

ND = Compound was analyzed for, but not detected above the laboratory reporting limit.

MRL = Method Reporting Limit - The minimum quantity of a target analyte that can be confidently determined by the referenced method.

RESULTS OF ANALYSIS

Page 1 of 1

**Client:** GSI Environmental Inc.

**Client Sample ID:** 1-IA-3-PP

**Client Project ID:** ESTCP / JBLM Long Center / G-3585 / 3669

CAS Project ID: P1203080

CAS Sample ID: P1203080-012

Test Code: EPA TO-15 SIM

Date Collected: 7/25/12

Instrument ID: Tekmar AUTOCAN/Agilent 5973N/HP6890A/MS7

Date Received: 7/27/12

Analyst: Wida Ang

Date Analyzed: 8/1/12

Sampling Media: 6.0 L Summa Canister

Volume(s) Analyzed: 1.00 Liter(s)

Test Notes:

Container ID: AC00229

Initial Pressure (psig): 0.31 Final Pressure (psig): 3.55

Canister Dilution Factor: 1.22

CAS #	Compound	Result µg/m <sup>3</sup>	MRL µg/m <sup>3</sup>	Result ppbV	MRL ppbV	Data Qualifier
75-01-4	Vinyl Chloride	ND	0.031	ND	0.012	
75-35-4	1,1-Dichloroethene	ND	0.031	ND	0.0077	
156-60-5	trans-1,2-Dichloroethene	<b>1.5</b>	0.031	<b>0.39</b>	0.0077	
156-59-2	cis-1,2-Dichloroethene	ND	0.031	ND	0.0077	
107-06-2	1,2-Dichloroethane	<b>0.050</b>	0.031	<b>0.012</b>	0.0075	
71-55-6	1,1,1-Trichloroethane	<b>0.038</b>	0.031	<b>0.0069</b>	0.0056	
79-01-6	Trichloroethene	<b>1.2</b>	0.031	<b>0.22</b>	0.0057	
127-18-4	Tetrachloroethene	<b>0.17</b>	0.031	<b>0.025</b>	0.0045	

ND = Compound was analyzed for, but not detected above the laboratory reporting limit.

MRL = Method Reporting Limit - The minimum quantity of a target analyte that can be confidently determined by the referenced method.

RESULTS OF ANALYSIS

Page 1 of 1

**Client:** GSI Environmental Inc.

**Client Sample ID:** 2-SS-3-CON-Resample

**Client Project ID:** ESTCP / JBLM Long Center / G-3585 / 3669

CAS Project ID: P1203080

CAS Sample ID: P1203080-013

Test Code: EPA TO-15 SIM

Date Collected: 7/26/12

Instrument ID: Tekmar AUTOCAN/Agilent 5973N/HP6890A/MS7

Date Received: 7/27/12

Analyst: Wida Ang

Date Analyzed: 8/1 - 8/2/12

Sampling Media: 6.0 L Summa Canister

Volume(s) Analyzed: 1.00 Liter(s)

Test Notes:

0.10 Liter(s)

Container ID: AC01034

Initial Pressure (psig): -0.90      Final Pressure (psig): 3.50

Canister Dilution Factor: 1.32

CAS #	Compound	Result	MRL	Result	MRL	Data Qualifier
		µg/m <sup>3</sup>	µg/m <sup>3</sup>	ppbV	ppbV	
75-01-4	Vinyl Chloride	ND	0.033	ND	0.013	
75-35-4	1,1-Dichloroethene	ND	0.033	ND	0.0083	
156-60-5	trans-1,2-Dichloroethene	ND	0.033	ND	0.0083	
156-59-2	cis-1,2-Dichloroethene	ND	0.033	ND	0.0083	
107-06-2	1,2-Dichloroethane	<b>0.096</b>	0.033	<b>0.024</b>	0.0082	
71-55-6	1,1,1-Trichloroethane	<b>1.5</b>	0.033	<b>0.27</b>	0.0061	
79-01-6	Trichloroethene	<b>1.7</b>	0.033	<b>0.32</b>	0.0061	
127-18-4	Tetrachloroethene	<b>35</b>	0.33	<b>5.1</b>	0.049	<b>D</b>

ND = Compound was analyzed for, but not detected above the laboratory reporting limit.

MRL = Method Reporting Limit - The minimum quantity of a target analyte that can be confidently determined by the referenced method.

D = The reported result is from a dilution.

RESULTS OF ANALYSIS

Page 1 of 1

**Client:** GSI Environmental Inc.

**Client Sample ID:** 2-IA-1-BL

**Client Project ID:** ESTCP / JBLM Long Center / G-3585 / 3669

CAS Project ID: P1203080

CAS Sample ID: P1203080-014

Test Code: EPA TO-15 SIM

Date Collected: 7/26/12

Instrument ID: Tekmar AUTOCAN/Agilent 5973N/HP6890A/MS7

Date Received: 7/27/12

Analyst: Wida Ang

Date Analyzed: 8/1/12

Sampling Media: 6.0 L Summa Canister

Volume(s) Analyzed: 1.00 Liter(s)

Test Notes:

Container ID: AC00748

Initial Pressure (psig): 0.33      Final Pressure (psig): 3.56

Canister Dilution Factor: 1.21

CAS #	Compound	Result	MRL	Result	MRL	Data Qualifier
		µg/m <sup>3</sup>	µg/m <sup>3</sup>	ppbV	ppbV	
75-01-4	Vinyl Chloride	ND	0.030	ND	0.012	
75-35-4	1,1-Dichloroethene	ND	0.030	ND	0.0076	
156-60-5	trans-1,2-Dichloroethene	ND	0.030	ND	0.0076	
156-59-2	cis-1,2-Dichloroethene	ND	0.030	ND	0.0076	
107-06-2	1,2-Dichloroethane	<b>0.036</b>	0.030	<b>0.0089</b>	0.0075	
71-55-6	1,1,1-Trichloroethane	ND	0.030	ND	0.0055	
79-01-6	Trichloroethene	<b>0.032</b>	0.030	<b>0.0060</b>	0.0056	
127-18-4	Tetrachloroethene	ND	0.030	ND	0.0045	

ND = Compound was analyzed for, but not detected above the laboratory reporting limit.

MRL = Method Reporting Limit - The minimum quantity of a target analyte that can be confidently determined by the referenced method.

RESULTS OF ANALYSIS

Page 1 of 1

**Client:** GSI Environmental Inc.

**Client Sample ID:** 2-IA-1-NP

**Client Project ID:** ESTCP / JBLM Long Center / G-3585 / 3669

CAS Project ID: P1203080

CAS Sample ID: P1203080-015

Test Code: EPA TO-15 SIM

Date Collected: 7/26/12

Instrument ID: Tekmar AUTOCAN/Agilent 5973N/HP6890A/MS7

Date Received: 7/27/12

Analyst: Wida Ang

Date Analyzed: 8/1/12

Sampling Media: 6.0 L Summa Canister

Volume(s) Analyzed: 1.00 Liter(s)

Test Notes:

Container ID: AC01165

Initial Pressure (psig): 0.41      Final Pressure (psig): 3.56

Canister Dilution Factor: 1.21

CAS #	Compound	Result	MRL	Result	MRL	Data Qualifier
		µg/m <sup>3</sup>	µg/m <sup>3</sup>	ppbV	ppbV	
75-01-4	Vinyl Chloride	ND	0.030	ND	0.012	
75-35-4	1,1-Dichloroethene	ND	0.030	ND	0.0076	
156-60-5	trans-1,2-Dichloroethene	ND	0.030	ND	0.0076	
156-59-2	cis-1,2-Dichloroethene	ND	0.030	ND	0.0076	
107-06-2	1,2-Dichloroethane	<b>0.035</b>	0.030	<b>0.0088</b>	0.0075	
71-55-6	1,1,1-Trichloroethane	ND	0.030	ND	0.0055	
79-01-6	Trichloroethene	ND	0.030	ND	0.0056	
127-18-4	Tetrachloroethene	ND	0.030	ND	0.0045	

ND = Compound was analyzed for, but not detected above the laboratory reporting limit.

MRL = Method Reporting Limit - The minimum quantity of a target analyte that can be confidently determined by the referenced method.



RESULTS OF ANALYSIS

Page 1 of 1

**Client:** GSI Environmental Inc.

**Client Sample ID:** DUP-1

**Client Project ID:** ESTCP / JBLM Long Center / G-3585 / 3669

CAS Project ID: P1203080

CAS Sample ID: P1203080-016

Test Code: EPA TO-15 SIM

Date Collected: 7/26/12

Instrument ID: Tekmar AUTOCAN/Agilent 5973N/HP6890A/MS7

Date Received: 7/27/12

Analyst: Wida Ang

Date Analyzed: 8/1/12

Sampling Media: 6.0 L Summa Canister

Volume(s) Analyzed: 1.00 Liter(s)

Test Notes:

Container ID: AC00822

Initial Pressure (psig): 0.38      Final Pressure (psig): 3.75

Canister Dilution Factor: 1.22

CAS #	Compound	Result	MRL	Result	MRL	Data Qualifier
		µg/m <sup>3</sup>	µg/m <sup>3</sup>	ppbV	ppbV	
75-01-4	Vinyl Chloride	ND	0.031	ND	0.012	
75-35-4	1,1-Dichloroethene	ND	0.031	ND	0.0077	
156-60-5	trans-1,2-Dichloroethene	ND	0.031	ND	0.0077	
156-59-2	cis-1,2-Dichloroethene	ND	0.031	ND	0.0077	
107-06-2	1,2-Dichloroethane	<b>0.035</b>	0.031	<b>0.0086</b>	0.0075	
71-55-6	1,1,1-Trichloroethane	ND	0.031	ND	0.0056	
79-01-6	Trichloroethene	ND	0.031	ND	0.0057	
127-18-4	Tetrachloroethene	ND	0.031	ND	0.0045	

ND = Compound was analyzed for, but not detected above the laboratory reporting limit.

MRL = Method Reporting Limit - The minimum quantity of a target analyte that can be confidently determined by the referenced method.

RESULTS OF ANALYSIS

Page 1 of 1

**Client:** GSI Environmental Inc.

**Client Sample ID:** 1-IA-3-NP

**Client Project ID:** ESTCP / JBLM Long Center / G-3585 / 3669

CAS Project ID: P1203080

CAS Sample ID: P1203080-017

Test Code: EPA TO-15 SIM

Instrument ID: Tekmar AUTOCAN/Agilent 5973N/HP6890A/MS7

Analyst: Wida Ang

Sampling Media: 6.0 L Summa Canister

Test Notes:

Container ID: AC01327

Date Collected: 7/25/12

Date Received: 7/27/12

Date Analyzed: 8/1/12

Volume(s) Analyzed: 1.00 Liter(s)

Initial Pressure (psig): 0.37 Final Pressure (psig): 3.65

Canister Dilution Factor: 1.22

CAS #	Compound	Result µg/m <sup>3</sup>	MRL µg/m <sup>3</sup>	Result ppbV	MRL ppbV	Data Qualifier
75-01-4	Vinyl Chloride	ND	0.031	ND	0.012	
75-35-4	1,1-Dichloroethene	ND	0.031	ND	0.0077	
156-60-5	trans-1,2-Dichloroethene	<b>1.0</b>	0.031	<b>0.25</b>	0.0077	
156-59-2	cis-1,2-Dichloroethene	ND	0.031	ND	0.0077	
107-06-2	1,2-Dichloroethane	<b>0.047</b>	0.031	<b>0.012</b>	0.0075	
71-55-6	1,1,1-Trichloroethane	<b>0.035</b>	0.031	<b>0.0065</b>	0.0056	
79-01-6	Trichloroethene	<b>2.0</b>	0.031	<b>0.38</b>	0.0057	
127-18-4	Tetrachloroethene	<b>0.16</b>	0.031	<b>0.023</b>	0.0045	

ND = Compound was analyzed for, but not detected above the laboratory reporting limit.

MRL = Method Reporting Limit - The minimum quantity of a target analyte that can be confidently determined by the referenced method.

RESULTS OF ANALYSIS

Page 1 of 1

**Client:** GSI Environmental Inc.  
**Client Sample ID:** Method Blank  
**Client Project ID:** ESTCP / JBLM Long Center / G-3585 / 3669

CAS Project ID: P1203080  
CAS Sample ID: P120801-MB

Test Code: EPA TO-15 SIM  
Instrument ID: Tekmar AUTOCAN/Agilent 5973N/HP6890A/MS7  
Analyst: Wida Ang  
Sampling Media: 6.0 L Summa Canister  
Test Notes:

Date Collected: NA  
Date Received: NA  
Date Analyzed: 8/1/12  
Volume(s) Analyzed: 1.00 Liter(s)

Canister Dilution Factor: 1.00

CAS #	Compound	Result µg/m <sup>3</sup>	MRL µg/m <sup>3</sup>	Result ppbV	MRL ppbV	Data Qualifier
75-01-4	Vinyl Chloride	ND	0.025	ND	0.0098	
75-35-4	1,1-Dichloroethene	ND	0.025	ND	0.0063	
156-60-5	trans-1,2-Dichloroethene	ND	0.025	ND	0.0063	
156-59-2	cis-1,2-Dichloroethene	ND	0.025	ND	0.0063	
107-06-2	1,2-Dichloroethane	ND	0.025	ND	0.0062	
71-55-6	1,1,1-Trichloroethane	ND	0.025	ND	0.0046	
79-01-6	Trichloroethene	ND	0.025	ND	0.0047	
127-18-4	Tetrachloroethene	ND	0.025	ND	0.0037	

ND = Compound was analyzed for, but not detected above the laboratory reporting limit.

MRL = Method Reporting Limit - The minimum quantity of a target analyte that can be confidently determined by the referenced method.

RESULTS OF ANALYSIS

Page 1 of 1

**Client:** GSI Environmental Inc.  
**Client Sample ID:** Method Blank  
**Client Project ID:** ESTCP / JBLM Long Center / G-3585 / 3669

CAS Project ID: P1203080  
 CAS Sample ID: P120802-MB

Test Code: EPA TO-15 SIM  
 Instrument ID: Tekmar AUTOCAN/Agilent 5973N/HP6890A/MS7  
 Analyst: Wida Ang  
 Sampling Media: 6.0 L Summa Canister  
 Test Notes:

Date Collected: NA  
 Date Received: NA  
 Date Analyzed: 8/2/12  
 Volume(s) Analyzed: 1.00 Liter(s)

Canister Dilution Factor: 1.00

CAS #	Compound	Result µg/m <sup>3</sup>	MRL µg/m <sup>3</sup>	Result ppbV	MRL ppbV	Data Qualifier
75-01-4	Vinyl Chloride	ND	0.025	ND	0.0098	
75-35-4	1,1-Dichloroethene	ND	0.025	ND	0.0063	
156-60-5	trans-1,2-Dichloroethene	ND	0.025	ND	0.0063	
156-59-2	cis-1,2-Dichloroethene	ND	0.025	ND	0.0063	
107-06-2	1,2-Dichloroethane	ND	0.025	ND	0.0062	
71-55-6	1,1,1-Trichloroethane	ND	0.025	ND	0.0046	
79-01-6	Trichloroethene	ND	0.025	ND	0.0047	
127-18-4	Tetrachloroethene	ND	0.025	ND	0.0037	

ND = Compound was analyzed for, but not detected above the laboratory reporting limit.

MRL = Method Reporting Limit - The minimum quantity of a target analyte that can be confidently determined by the referenced method.

## SURROGATE SPIKE RECOVERY RESULTS

Page 1 of 1

**Client:** GSI Environmental Inc.  
**Client Project ID:** ESTCP / JBLM Long Center / G-3585 / 3669

CAS Project ID: P1203080

**Test Code:** EPA TO-15 SIM  
**Instrument ID:** Tekmar AUTOCAN/Agilent 5973N/HP6890A/MS7  
**Analyst:** Wida Ang  
**Sampling Media:** 6.0 L Summa Canister(s)  
**Test Notes:**

**Date(s) Collected:** 7/24 - 7/26/12  
**Date(s) Received:** 7/27/12  
**Date(s) Analyzed:** 8/1 - 8/2/12

Client Sample ID	CAS Sample ID	1,2-Dichloroethane-d4	Toluene-d8	Bromofluorobenzene	Acceptance Limits	Data Qualifier
		% Recovered	% Recovered	% Recovered		
Method Blank	P120801-MB	101	103	97	70-130	
Method Blank	P120802-MB	101	101	97	70-130	
Lab Control Sample	P120801-LCS	99	99	102	70-130	
Lab Control Sample	P120802-LCS	100	99	102	70-130	
1-AA-1-CON	P1203080-001	100	102	100	70-130	
1-IA-1-CON	P1203080-002	100	101	94	70-130	
1-IA-2-CON	P1203080-003	100	103	95	70-130	
1-SS-1-CON	P1203080-004	102	106	91	70-130	
1-SS-2-CON	P1203080-005	102	105	101	70-130	
1-SS-3-CON	P1203080-006	100	105	97	70-130	
2-AA-1-CON	P1203080-007	101	104	100	70-130	
2-IA-1-CON	P1203080-008	99	100	96	70-130	
2-IA-1-CON	P1203080-008DUP	100	99	99	70-130	
2-SS-1-CON	P1203080-009	99	104	90	70-130	
2-SS-2-CON	P1203080-010	101	103	97	70-130	
2-SS-2-CON	P1203080-010DUP	101	102	96	70-130	
1-IA-3-BL	P1203080-011	102	100	91	70-130	
1-IA-3-PP	P1203080-012	99	101	94	70-130	
2-SS-3-CON-Resample	P1203080-013	101	103	95	70-130	
2-IA-1-BL	P1203080-014	101	102	98	70-130	
2-IA-1-NP	P1203080-015	100	101	100	70-130	
DUP-1	P1203080-016	99	101	100	70-130	
1-IA-3-NP	P1203080-017	99	102	92	70-130	

Surrogate percent recovery is verified and accepted based on the on-column result.

Reported results are shown in concentration units and as a result of the calculation, may vary slightly from the on-column percent recovery.

LABORATORY CONTROL SAMPLE SUMMARY

Page 1 of 1

**Client:** GSI Environmental Inc.  
**Client Sample ID:** Lab Control Sample  
**Client Project ID:** ESTCP / JBLM Long Center / G-3585 / 3669  
**Test Code:** EPA TO-15 SIM  
**Instrument ID:** Tekmar AUTOCAN/Agilent 5973N/HP6890A/MS7  
**Analyst:** Wida Ang  
**Sampling Media:** 6.0 L Summa Canister  
**Test Notes:**

**CAS Project ID:** P1203080  
**CAS Sample ID:** P120801-LCS  
**Date Collected:** NA  
**Date Received:** NA  
**Date Analyzed:** 8/01/12  
**Volume(s) Analyzed:** 0.125 Liter(s)

CAS #	Compound	Spike Amount µg/m <sup>3</sup>	Result µg/m <sup>3</sup>	% Recovery	CAS	Data Qualifier
					Acceptance Limits	
75-01-4	Vinyl Chloride	4.00	3.18	80	56-127	
75-35-4	1,1-Dichloroethene	4.36	3.52	81	59-131	
156-60-5	trans-1,2-Dichloroethene	4.04	3.30	82	60-128	
156-59-2	cis-1,2-Dichloroethene	4.28	3.57	83	62-130	
107-06-2	1,2-Dichloroethane	4.16	3.41	82	51-140	
71-55-6	1,1,1-Trichloroethane	4.08	3.39	83	57-132	
79-01-6	Trichloroethene	3.96	3.33	84	51-127	
127-18-4	Tetrachloroethene	3.80	3.06	81	58-134	

Laboratory Control Sample percent recovery is verified and accepted based on the on-column result.  
 Reported results are shown in concentration units and as a result of the calculation, may vary slightly.

LABORATORY CONTROL SAMPLE SUMMARY

Page 1 of 1

**Client:** GSI Environmental Inc.  
**Client Sample ID:** Lab Control Sample  
**Client Project ID:** ESTCP / JBLM Long Center / G-3585 / 3669  
**Test Code:** EPA TO-15 SIM  
**Instrument ID:** Tekmar AUTOCAN/Agilent 5973N/HP6890A/MS7  
**Analyst:** Wida Ang  
**Sampling Media:** 6.0 L Summa Canister  
**Test Notes:**

**CAS Project ID:** P1203080  
**CAS Sample ID:** P120802-LCS  
**Date Collected:** NA  
**Date Received:** NA  
**Date Analyzed:** 8/02/12  
**Volume(s) Analyzed:** 0.125 Liter(s)

CAS #	Compound	Spike Amount µg/m <sup>3</sup>	Result µg/m <sup>3</sup>	% Recovery	CAS	Data Qualifier
					Acceptance Limits	
75-01-4	Vinyl Chloride	4.00	3.26	82	56-127	
75-35-4	1,1-Dichloroethene	4.36	3.56	82	59-131	
156-60-5	trans-1,2-Dichloroethene	4.04	3.35	83	60-128	
156-59-2	cis-1,2-Dichloroethene	4.28	3.59	84	62-130	
107-06-2	1,2-Dichloroethane	4.16	3.44	83	51-140	
71-55-6	1,1,1-Trichloroethane	4.08	3.36	82	57-132	
79-01-6	Trichloroethene	3.96	3.28	83	51-127	
127-18-4	Tetrachloroethene	3.80	3.05	80	58-134	

Laboratory Control Sample percent recovery is verified and accepted based on the on-column result. Reported results are shown in concentration units and as a result of the calculation, may vary slightly.

LABORATORY DUPLICATE SUMMARY RESULTS

Page 1 of 1

**Client:** GSI Environmental Inc.

**Client Sample ID:** 2-IA-1-CON

**Client Project ID:** ESTCP / JBLM Long Center / G-3585 / 3669

CAS Project ID: P1203080

CAS Sample ID: P1203080-008DUP

Test Code: EPA TO-15 SIM

Date Collected: 7/24/12

Instrument ID: Tekmar AUTOCAN/Agilent 5973N/HP6890A/MS7

Date Received: 7/27/12

Analyst: Wida Ang

Date Analyzed: 8/1/12

Sampling Media: 6.0 L Summa Canister

Volume(s) Analyzed: 1.00 Liter(s)

Test Notes:

Container ID: AC01900

Initial Pressure (psig): -2.57

Final Pressure (psig): 3.69

Canister Dilution Factor: 1.52

CAS #	Compound	Sample Result		Duplicate		Average µg/m <sup>3</sup>	% RPD	RPD Limit	Data Qualifier
		µg/m <sup>3</sup>	ppbV	µg/m <sup>3</sup>	ppbV				
75-01-4	Vinyl Chloride	ND	ND	ND	ND	-	-	25	
75-35-4	1,1-Dichloroethene	ND	ND	ND	ND	-	-	25	
156-60-5	trans-1,2-Dichloroethene	ND	ND	ND	ND	-	-	25	
156-59-2	cis-1,2-Dichloroethene	ND	ND	ND	ND	-	-	25	
107-06-2	1,2-Dichloroethane	ND	ND	0.0391	0.00965	-	-	25	
71-55-6	1,1,1-Trichloroethane	ND	ND	ND	ND	-	-	25	
79-01-6	Trichloroethene	0.0715	0.0133	0.0714	0.0133	0.07145	<b>0.1</b>	25	
127-18-4	Tetrachloroethene	0.240	0.0355	0.264	0.0390	0.252	<b>10</b>	25	

ND = Compound was analyzed for, but not detected above the laboratory reporting limit.



LABORATORY DUPLICATE SUMMARY RESULTS

Page 1 of 1

**Client:** GSI Environmental Inc.

**Client Sample ID:** 2-SS-2-CON

**Client Project ID:** ESTCP / JBLM Long Center / G-3585 / 3669

CAS Project ID: P1203080

CAS Sample ID: P1203080-010DUP

Test Code: EPA TO-15 SIM

Date Collected: 7/24/12

Instrument ID: Tekmar AUTOCAN/Agilent 5973N/HP6890A/MS7

Date Received: 7/27/12

Analyst: Wida Ang

Date Analyzed: 8/2/12

Sampling Media: 6.0 L Summa Canister

Volume(s) Analyzed: 0.50 Liter(s)

Test Notes:

Container ID: AC01190

Initial Pressure (psig): -0.21

Final Pressure (psig): 3.55

Canister Dilution Factor: 1.26

CAS #	Compound	Sample Result		Duplicate Sample Result		Average µg/m <sup>3</sup>	% RPD	RPD Limit	Data Qualifier
		µg/m <sup>3</sup>	ppbV	µg/m <sup>3</sup>	ppbV				
75-01-4	Vinyl Chloride	ND	ND	ND	ND	-	-	25	
75-35-4	1,1-Dichloroethene	ND	ND	ND	ND	-	-	25	
156-60-5	trans-1,2-Dichloroethene	ND	ND	ND	ND	-	-	25	
156-59-2	cis-1,2-Dichloroethene	ND	ND	ND	ND	-	-	25	
107-06-2	1,2-Dichloroethane	0.305	0.0753	0.300	0.0743	0.3025	<b>2</b>	25	
71-55-6	1,1,1-Trichloroethane	0.729	0.134	0.693	0.127	0.711	<b>5</b>	25	
79-01-6	Trichloroethene	1.79	0.333	1.76	0.327	1.775	<b>2</b>	25	
127-18-4	Tetrachloroethene	48.1	7.10	46.0	6.79	47.05	<b>4</b>	25	

ND = Compound was analyzed for, but not detected above the laboratory reporting limit.

RESULTS OF ANALYSIS

Page 1 of 1

**Client:** GSI Environmental Inc.  
**Client Project ID:** ESTCP / JBLM Long Center / G-3585 / 3669 CAS Project ID: P1203080

**Method Blank Summary**

Test Code: EPA TO-15 SIM  
Instrument ID: Tekmar AUTOCAN/Agilent 5973N/HP6890A/MS7 Lab File ID: 08011203.D  
Analyst: Wida Ang Date Analyzed: 8/01/12  
Sampling Media: 6.0 L Summa Canister(s) Time Analyzed: 08:17  
Test Notes:

Client Sample ID	CAS Sample ID	Lab File ID	Time Analyzed
Lab Control Sample	P120801-LCS	08011204.D	08:45
1-SS-1-CON	P1203080-004	08011208.D	11:47
1-SS-2-CON	P1203080-005	08011209.D	12:16
1-SS-3-CON	P1203080-006	08011210.D	12:43
1-AA-1-CON	P1203080-001	08011211.D	13:35
1-IA-1-CON	P1203080-002	08011212.D	14:07
1-IA-2-CON	P1203080-003	08011213.D	14:38
2-AA-1-CON	P1203080-007	08011214.D	15:29
2-IA-1-CON	P1203080-008	08011215.D	16:01
2-IA-1-CON (Lab Duplicate)	P1203080-008DUP	08011216.D	16:33
1-IA-3-BL	P1203080-011	08011218.D	17:32
1-IA-3-PP	P1203080-012	08011219.D	18:04
2-SS-3-CON-Resample	P1203080-013	08011220.D	18:36
2-IA-1-BL	P1203080-014	08011221.D	19:08
2-IA-1-NP	P1203080-015	08011222.D	19:40
DUP-1	P1203080-016	08011223.D	20:11
1-IA-3-NP	P1203080-017	08011224.D	20:44

RESULTS OF ANALYSIS

Page 1 of 1

**Client:** GSI Environmental Inc.  
**Client Project ID:** ESTCP / JBLM Long Center / G-3585 / 3669 CAS Project ID: P1203080

**Method Blank Summary**

Test Code: EPA TO-15 SIM  
 Instrument ID: Tekmar AUTOCAN/Agilent 5973N/HP6890A/MS7 Lab File ID: 08021204.D  
 Analyst: Wida Ang Date Analyzed: 8/02/12  
 Sampling Media: 6.0 L Summa Canister(s) Time Analyzed: 07:58  
 Test Notes:

Client Sample ID	CAS Sample ID	Lab File ID	Time Analyzed
Lab Control Sample	P120802-LCS	08021205.D	08:26
2-SS-3-CON-Resample (Dilution)	P1203080-013	08021207.D	11:46
2-SS-1-CON	P1203080-009	08021208.D	12:18
2-SS-2-CON	P1203080-010	08021209.D	12:45
2-SS-2-CON (Lab Duplicate)	P1203080-010DUP	08021212.D	15:43

RESULTS OF ANALYSIS

Page 1 of 1

**Client:** GSI Environmental Inc.  
**Client Project ID:** ESTCP / JBLM Long Center / G-3585 / 3669 **CAS Project ID:** P1203080

**Internal Standard Area and RT Summary**

**Test Code:** EPA TO-15 SIM **Lab File ID:** 08011202.D  
**Instrument ID:** Tekmar AUTOCAN/Agilent 5973N/HP6890A/MS7 **Date Analyzed:** 8/1/12  
**Analyst:** Wida Ang **Time Analyzed:** 07:28  
**Sampling Media:** 6.0 L Summa Canister(s)  
**Test Notes:**

	IS1 (BCM)		IS2 (DFB)		IS3 (CBZ)	
	AREA #	RT #	AREA #	RT #	AREA #	RT #
<b>24 Hour Standard</b>	29278	9.33	127514	10.66	28816	13.41
<b>Upper Limit</b>	40989	9.66	178520	10.99	40342	13.74
<b>Lower Limit</b>	17567	9.00	76508	10.33	17290	13.08

Client Sample ID		IS1 (BCM)	IS2 (DFB)	IS3 (CBZ)
		AREA #	RT #	AREA #
01	Method Blank	30845	9.34	123583
02	Lab Control Sample	29936	9.33	130325
03	1-SS-1-CON	31782	9.33	143134
04	1-SS-2-CON	29743	9.32	129710
05	1-SS-3-CON	28554	9.33	126421
06	1-AA-1-CON	32709	9.33	147941
07	1-IA-1-CON	32046	9.33	142804
08	1-IA-2-CON	32257	9.33	144534
09	2-AA-1-CON	33601	9.33	151329
10	2-IA-1-CON	31687	9.33	144397
11	2-IA-1-CON (Lab Duplicate)	31234	9.33	144338
12	1-IA-3-BL	31724	9.33	143826
13	1-IA-3-PP	33066	9.33	149053
14	2-SS-3-CON-Resample	32821	9.33	147700
15	2-IA-1-BL	32378	9.33	146693
16	2-IA-1-NP	31576	9.33	142003
17	DUP-1	32252	9.33	143939
18	1-IA-3-NP	32639	9.33	147075
19				
20				

IS1 (BCM) = Bromochloromethane  
 IS2 (DFB) = 1,4-Difluorobenzene  
 IS3 (CBZ) = Chlorobenzene-d5

AREA UPPER LIMIT = 140% of internal standard area  
 AREA LOWER LIMIT = 60% of internal standard area  
 RT UPPER LIMIT = 0.33 minutes of internal standard RT  
 RT LOWER LIMIT = 0.33 minutes of internal standard RT

# Column used to flag values outside QC limits with an I.  
 I = Internal standard not within the specified limits. See case narrative.

RESULTS OF ANALYSIS

Page 1 of 1

**Client:** GSI Environmental Inc.  
**Client Project ID:** ESTCP / JBLM Long Center / G-3585 / 3669 **CAS Project ID:** P1203080

**Internal Standard Area and RT Summary**

**Test Code:** EPA TO-15 SIM **Lab File ID:** 08021203.D  
**Instrument ID:** Tekmar AUTOCAN/Agilent 5973N/HP6890A/MS7 **Date Analyzed:** 8/2/12  
**Analyst:** Wida Ang **Time Analyzed:** 07:27  
**Sampling Media:** 6.0 L Summa Canister(s)  
**Test Notes:**

	IS1 (BCM)		IS2 (DFB)		IS3 (CBZ)						
	AREA	#	RT	#	AREA	#	RT	#			
<b>24 Hour Standard</b>	31051		9.33		138795		10.66		31508		13.41
<b>Upper Limit</b>	43471		9.66		194313		10.99		44111		13.74
<b>Lower Limit</b>	18631		9.00		83277		10.33		18905		13.08

Client Sample ID		IS1 (BCM)	IS2 (DFB)	IS3 (CBZ)			
		AREA	RT	AREA	RT	AREA	RT
01	Method Blank	30396	9.34	127198	10.66	29705	13.42
02	Lab Control Sample	31152	9.32	138167	10.66	31140	13.41
03	2-SS-3-CON-Resample (Dilution)	29546	9.33	125838	10.66	29193	13.41
04	2-SS-1-CON	30276	9.33	130727	10.66	34933	13.41
05	2-SS-2-CON	30419	9.32	137865	10.66	33676	13.41
06	2-SS-2-CON (Lab Duplicate)	33994	9.33	154635	10.66	37520	13.41
07							
08							
09							
10							
11							
12							
13							
14							
15							
16							
17							
18							
19							
20							

IS1 (BCM) = Bromochloromethane  
 IS2 (DFB) = 1,4-Difluorobenzene  
 IS3 (CBZ) = Chlorobenzene-d5  
 AREA UPPER LIMIT = 140% of internal standard area  
 AREA LOWER LIMIT = 60% of internal standard area  
 RT UPPER LIMIT = 0.33 minutes of internal standard RT  
 RT LOWER LIMIT = 0.33 minutes of internal standard RT  
 # Column used to flag values outside QC limits with an I.  
 I = Internal standard not within the specified limits. See case narrative.

Response Factor Report MS07

Method : J:\Ms07\METHODS\X7071612.M (RTE Integrator)  
 Title : EPA TO-15 per SOP VOA-TO15 (CASS TO-15/GC-MS)  
 Last Update : Tue Jul 17 11:58:51 2012  
 Response via : Initial Calibration

Calibration Files

10 =07161214.D 25 =07161205.D 75 =07161206.D 100 =07161207.D 500 =07161208.D  
 1000 =07161209.D 2500 =07161210.D 9999 =07161211.D 20K =07161212.D

Compound	10	25	75	100	500	1000	2500	9999	20K	Avg	%RSD
1) I Bromochloromethan	4.007	3.453	3.050	4.022	3.319	2.937	2.913	3.349	3.121	3.352	12.48
2) T Dichlorodifluorom		1.082	0.874	1.136	0.917	0.804	0.707	0.957	0.904	0.923	15.07
3) T Chloromethane	3.280	2.535	2.261	3.021	2.481	2.232	2.217	2.589	2.491	2.567	14.17
4) T Vinyl Chloride		1.740	1.298	1.745	1.352	1.206	1.148	1.394	1.361	1.406	15.90
5) T Bromomethane	1.650	1.297	1.159	1.535	1.248	1.088	1.102	1.273	1.247	1.289	14.69
6) T Chloroethane				1.628	1.211	1.069	1.070	1.312	1.252	1.257	16.43
7) T Acetone	3.170	2.700	2.447	3.223	2.677	2.381	2.373	2.761	2.643	2.708	11.49
8) T Trichlorofluorome	1.528	1.273	1.088	1.465	1.232	1.115	1.123	1.361	1.323	1.279	12.22
9) T 1,1-Dichloroethen			1.551	1.897	1.513	1.329	1.328	1.544	1.453	1.517	12.69
10) T Methylene Chlorid	1.376	1.196	1.021	1.366	1.114	0.992	0.967	1.119	1.058	1.134	13.36
11) T Trichlorotrifluor	1.755	1.383	1.257	1.608	1.368	1.231	1.254	1.510	1.445	1.423	12.42
12) T trans-1,2-Dichlor	3.476	2.901	2.651	3.515	2.964	2.630	2.669	3.231	3.051	3.010	11.30
13) T 1,1-Dichloroethan	4.194	3.455	3.188	4.094	3.673	3.456	3.750	4.886	4.756	3.939	15.00
14) T Methyl tert-Butyl	1.692	1.366	1.289	1.609	1.397	1.288	1.297	1.562	1.497	1.444	10.50
15) T cis-1,2-Dichloroe			2.997	3.582	2.559	2.276	2.272	2.611	2.494	2.684	17.33
16) T Chloroform	1.905	1.870	1.861	1.883	1.849	1.830	1.843	1.826	1.825	1.855	1.49
17) S 1,2-Dichloroethan	2.749	2.177	2.021	2.642	2.209	1.981	2.001	2.322	2.216	2.258	12.15
18) T 1,2-Dichloroethan	2.523	2.185	1.967	2.566	2.199	1.969	1.964	2.342	2.240	2.217	10.35
19) T 1,1,1-Trichloroet			7.038	7.962	6.010	5.480	5.405	6.269	5.985	6.307	14.42
20) T Benzene	1.965	1.693	1.489	1.937	1.633	1.460	1.469	1.782	1.703	1.681	11.32
21) T Carbon Tetrachlor											
22) I 1,4-Difluorobenze	0.477	0.414	0.368	0.486	0.385	0.340	0.332	0.389	0.370	0.396	13.85
23) T 1,2-Dichloropropa	0.546	0.494	0.433	0.578	0.461	0.405	0.415	0.464	0.451	0.472	12.30
24) T Bromodichlorometh	0.397	0.343	0.306	0.402	0.322	0.285	0.284	0.323	0.309	0.330	13.16
25) T Trichloroethene		0.292	0.245	0.281	0.234	0.216	0.225	0.281	0.270	0.255	11.36
26) T 1,4-Dioxane	0.615	0.500	0.448	0.587	0.507	0.468	0.488	0.593	0.582	0.532	11.68
27) T cis-1,3-Dichlorop	0.537	0.424	0.390	0.492	0.427	0.397	0.416	0.531	0.522	0.460	13.10
28) T trans-1,3-Dichlor											

36 of 41

(#) = Out of Range ### Number of calibration levels exceeded format ###  
 X7071612.M Wed Aug 01 10:29:55 2012

Response Factor Report MS07

Method : J:\Ms07\METHODS\X7071612.M (RTE Integrator)  
 Title : EPA TO-15 per SOP VOA-TO15 (CASS TO-15/GC-MS)  
 Last Update : Tue Jul 17 11:58:51 2012  
 Response via : Initial Calibration

Calibration Files

10 =07161214.D 25 =07161205.D 75 =07161206.D 100 =07161207.D 500 =07161208.D  
 1000 =07161209.D 2500 =07161210.D 9999 =07161211.D 20K =07161212.D

Compound	10	25	75	100	500	1000	2500	9999	20K	Avg	%RSD
29) T 1,1,2-Trichloroet	0.364	0.324	0.287	0.370	0.291	0.257	0.253	0.292	0.280	0.302	13.99
30) S Toluene-d8 (SS2)	1.107	1.143	1.135	1.110	1.066	1.066	1.059	1.048	1.083	1.091	3.15
31) T Toluene	1.599	1.319	1.639	1.310	1.193	1.205	1.417	1.374	1.382	1.382	11.95
32) T 1,2-Dibromoethane	0.469	0.368	0.328	0.423	0.343	0.310	0.312	0.369	0.354	0.364	14.44
33) T Tetrachloroethene	0.416	0.371	0.319	0.428	0.333	0.298	0.288	0.333	0.319	0.345	14.37
-----ISTD-----											
34) I Chlorobenzene-d5	4.884	3.758	3.350	4.301	3.628	3.263	3.307	3.799	3.438	3.748	14.30
35) T Chlorobenzene	6.628	5.420	4.898	6.092	5.533	5.291	5.738	7.170	6.511	5.920	12.41
36) T Ethylbenzene	4.752	3.863	3.599	4.498	4.493	4.487	4.757	5.880	5.290	4.624	14.78
37) T m,p-Xylene	5.022	4.241	4.017	4.970	5.077	4.836	5.094	6.137	5.540	4.993	12.60
38) T o-Xylene	2.897	2.661	2.409	3.057	2.697	2.441	2.457	2.949	2.690	2.695	8.71
39) T 1,1,2,2-Tetrachlo	1.682	1.762	1.818	1.826	1.923	1.948	1.863	1.838	1.760	1.825	4.54
40) S Bromofluorobenzene	3.633	2.580	2.518	3.055	2.837	2.615	2.665	3.203	2.861	2.885	12.50
41) T 1,3-Dichlorobenze	3.859	2.481	2.438	2.997	2.777	2.573	2.655	3.220	2.882	2.876	15.54
42) T 1,4-Dichlorobenze	3.609	2.480	2.387	2.900	2.721	2.511	2.560	3.101	2.753	2.780	13.78
43) T 1,2-Dichlorobenze	1.529	1.500	1.544	1.543	1.543	1.504	1.612	1.978	1.822	1.629	10.78
44) T 1,2,4-Trichlorobe	4.584	4.587	4.521	4.929	5.107	5.841	8.165	7.620	5.669	5.669	25.47
45) T Naphthalene	1.264	1.101	1.006	1.132	0.995	0.907	0.940	1.113	1.041	1.055	10.42
46) T Hexachlorobutadie											

(#) = Out of Range ### Number of calibration levels exceeded format ###  
 X7071612.M Wed Aug 01 10:29:56 2012

Evaluate Continuing Calibration Report

Data Path : J:\Ms07\DATA\2012\_08\01\  
 Data File : 08011202.D  
 Acq On : 1 Aug 2012 7:28  
 Operator : WA  
 Sample : 500pg TO-15 SIM CCV STD (125mL)  
 Misc : S25-07131201/S25-07131206  
 ALS Vial : 16 Sample Multiplier: 1

Quant Time: Aug 01 10:29:36 2012  
 Quant Method : J:\Ms07\METHODS\X7071612.M  
 Quant Title : EPA TO-15 per SOP VOA-TO15 (CASS TO-15/GC-MS)  
 QLast Update : Tue Jul 17 11:58:51 2012  
 Response via : Initial Calibration

Min. RRF : 0.000 Min. Rel. Area : 50% Max. R.T. Dev 0.33min  
 Max. RRF Dev : 30% Max. Rel. Area : 200%

	Compound	AvgRF	CCRF	%Dev	Area%	Dev (min)
1 I	Bromochloromethane (IS1)	1.000	1.000	0.0	118	0.00
2 T	Dichlorodifluoromethane (CF)	3.352	2.886	13.9	103	0.01
3 T	Chloromethane	0.923	0.807	12.6	104	0.01
4 T	Vinyl Chloride	2.567	2.186	14.8	104	0.00
5 T	Bromomethane	1.406	1.223	13.0	107	0.00
6 T	Chloroethane	1.289	1.115	13.5	106	0.00
7 T	Acetone	1.257	1.178	6.3	115	0.00
8 T	Trichlorofluoromethane	2.708	2.355	13.0	104	0.00
9 T	1,1-Dichloroethene	1.279	1.119	12.5	107	0.00
10 T	Methylene Chloride	1.517	1.322	12.9	103	0.00
11 T	Trichlorotrifluoroethane	1.134	0.977	13.8	104	0.00
12 T	trans-1,2-Dichloroethene	1.423	1.234	13.3	107	0.00
13 T	1,1-Dichloroethane	3.010	2.563	14.9	102	0.00
14 T	Methyl tert-Butyl Ether	3.939	3.489	11.4	112	0.00
15 T	cis-1,2-Dichloroethene	1.444	1.264	12.5	107	0.00
16 T	Chloroform	2.684	2.315	13.7	107	0.00
17 S	1,2-Dichloroethane-d4 (SS1)	1.855	1.835	1.1	117	0.00
18 T	1,2-Dichloroethane	2.258	1.951	13.6	104	0.00
19 T	1,1,1-Trichloroethane	2.217	1.932	12.9	104	0.00
20 T	Benzene	6.307	5.309	15.8	105	0.00
21 T	Carbon Tetrachloride	1.681	1.441	14.3	104	0.00
22 I	1,4-Difluorobenzene (IS2)	1.000	1.000	0.0	122	0.00
23 T	1,2-Dichloropropane	0.396	0.331	16.4	105	0.00
24 T	Bromodichloromethane	0.472	0.389	17.6	103	0.00
25 T	Trichloroethene	0.330	0.281	14.8	107	0.00
26 T	1,4-Dioxane	0.255	0.226	11.4	118	0.00
27 T	cis-1,3-Dichloropropene	0.532	0.455	14.5	110	0.00
28 T	trans-1,3-Dichloropropene	0.460	0.383	16.7	110	0.00
29 T	1,1,2-Trichloroethane	0.302	0.246	18.5	103	0.00
30 S	Toluene-d8 (SS2)	1.091	1.089	0.2	125	0.00
31 T	Toluene	1.382	1.178	14.8	110	0.00
32 T	1,2-Dibromoethane	0.364	0.297	18.4	106	0.00
33 T	Tetrachloroethene	0.345	0.293	15.1	108	0.00
34 I	Chlorobenzene-d5 (IS3)	1.000	1.000	0.0	122	0.00
35 T	Chlorobenzene	3.748	3.251	13.3	109	0.00
36 T	Ethylbenzene	5.920	5.324	10.1	117	0.00
37 T	m,p-Xylene	4.624	4.194	9.3	114	0.00



Evaluate Continuing Calibration Report

Data Path : J:\Ms07\DATA\2012\_08\01\  
 Data File : 08011202.D  
 Acq On : 1 Aug 2012 7:28  
 Operator : WA  
 Sample : 500pg TO-15 SIM CCV STD (125mL)  
 Misc : S25-07131201/S25-07131206  
 ALS Vial : 16 Sample Multiplier: 1

Quant Time: Aug 01 10:29:36 2012  
 Quant Method : J:\Ms07\METHODS\X7071612.M  
 Quant Title : EPA TO-15 per SOP VOA-TO15 (CASS TO-15/GC-MS)  
 QLast Update : Tue Jul 17 11:58:51 2012  
 Response via : Initial Calibration

Min. RRF : 0.000 Min. Rel. Area : 50% Max. R.T. Dev 0.33min  
 Max. RRF Dev : 30% Max. Rel. Area : 200%

	Compound	AvgRF	CCRF	%Dev	Area%	Dev(min)
38 T	o-Xylene	4.993	4.569	8.5	110	0.00
39 T	1,1,2,2-Tetrachloroethane	2.695	2.289	15.1	104	0.00
40 S	Bromofluorobenzene (SS3)	1.825	1.904	-4.3	121	0.00
41 T	1,3-Dichlorobenzene	2.885	2.502	13.3	108	0.00
42 T	1,4-Dichlorobenzene	2.876	2.462	14.4	108	0.00
43 T	1,2-Dichlorobenzene	2.780	2.405	13.5	108	0.00
44 T	1,2,4-Trichlorobenzene	1.629	1.455	10.7	115	0.00
45 T	Naphthalene	5.669	5.612	1.0	139	0.00
46 T	Hexachlorobutadiene	1.055	0.897	15.0	110	0.00

(#) = Out of Range

SPCC's out = 0 CCC's out = 0

Evaluate Continuing Calibration Report

Data Path : J:\Ms07\DATA\2012\_08\02\  
 Data File : 08021203.D  
 Acq On : 2 Aug 2012 7:27  
 Operator : WA  
 Sample : 500pg TO-15 SIM CCV STD (125mL)  
 Misc : S25-07131201/S25-07131206  
 ALS Vial : 16 Sample Multiplier: 1

Quant Time: Aug 02 11:07:37 2012  
 Quant Method : J:\Ms07\METHODS\X7071612.M  
 Quant Title : EPA TO-15 per SOP VOA-TO15 (CASS TO-15/GC-MS)  
 QLast Update : Tue Jul 17 11:58:51 2012  
 Response via : Initial Calibration

Min. RRF : 0.000 Min. Rel. Area : 50% Max. R.T. Dev 0.33min  
 Max. RRF Dev : 30% Max. Rel. Area : 200%

	Compound	AvgRF	CCRF	%Dev	Area%	Dev (min)
1 I	Bromochloromethane (IS1)	1.000	1.000	0.0	125	0.00
2 T	Dichlorodifluoromethane (CF)	3.352	2.915	13.0	110	0.00
3 T	Chloromethane	0.923	0.803	13.0	110	0.00
4 T	Vinyl Chloride	2.567	2.191	14.6	111	0.00
5 T	Bromomethane	1.406	1.219	13.3	113	0.00
6 T	Chloroethane	1.289	1.113	13.7	112	0.00
7 T	Acetone	1.257	1.196	4.9	124	0.00
8 T	Trichlorofluoromethane	2.708	2.360	12.9	111	0.00
9 T	1,1-Dichloroethene	1.279	1.135	11.3	116	0.00
10 T	Methylene Chloride	1.517	1.319	13.1	109	0.00
11 T	Trichlorotrifluoroethane	1.134	0.978	13.8	110	0.00
12 T	trans-1,2-Dichloroethene	1.423	1.235	13.2	113	0.00
13 T	1,1-Dichloroethane	3.010	2.583	14.2	109	0.00
14 T	Methyl tert-Butyl Ether	3.939	3.618	8.1	124	0.00
15 T	cis-1,2-Dichloroethene	1.444	1.265	12.4	114	0.00
16 T	Chloroform	2.684	2.310	13.9	113	0.00
17 S	1,2-Dichloroethane-d4 (SS1)	1.855	1.847	0.4	125	0.00
18 T	1,2-Dichloroethane	2.258	1.937	14.2	110	0.00
19 T	1,1,1-Trichloroethane	2.217	1.928	13.0	110	0.00
20 T	Benzene	6.307	5.280	16.3	110	0.00
21 T	Carbon Tetrachloride	1.681	1.442	14.2	111	0.00
22 I	1,4-Difluorobenzene (IS2)	1.000	1.000	0.0	133	0.00
23 T	1,2-Dichloropropane	0.396	0.321	18.9	111	0.00
24 T	Bromodichloromethane	0.472	0.375	20.6	108	0.00
25 T	Trichloroethene	0.330	0.274	17.0	113	0.00
26 T	1,4-Dioxane	0.255	0.223	12.5	127	0.00
27 T	cis-1,3-Dichloropropene	0.532	0.446	16.2	117	0.00
28 T	trans-1,3-Dichloropropene	0.460	0.382	17.0	119	0.00
29 T	1,1,2-Trichloroethane	0.302	0.241	20.2	110	0.00
30 S	Toluene-d8 (SS2)	1.091	1.099	-0.7	137	0.00
31 T	Toluene	1.382	1.171	15.3	119	0.00
32 T	1,2-Dibromoethane	0.364	0.293	19.5	114	0.00
33 T	Tetrachloroethene	0.345	0.288	16.5	115	0.00
34 I	Chlorobenzene-d5 (IS3)	1.000	1.000	0.0	133	0.00
35 T	Chlorobenzene	3.748	3.185	15.0	117	0.00
36 T	Ethylbenzene	5.920	5.286	10.7	127	0.00
37 T	m,p-Xylene	4.624	4.179	9.6	124	0.00

Evaluate Continuing Calibration Report

Data Path : J:\Ms07\DATA\2012\_08\02\  
 Data File : 08021203.D  
 Acq On : 2 Aug 2012 7:27  
 Operator : WA  
 Sample : 500pg TO-15 SIM CCV STD (125mL)  
 Misc : S25-07131201/S25-07131206  
 ALS Vial : 16 Sample Multiplier: 1

Quant Time: Aug 02 11:07:37 2012  
 Quant Method : J:\Ms07\METHODS\X7071612.M  
 Quant Title : EPA TO-15 per SOP VOA-TO15 (CASS TO-15/GC-MS)  
 QLast Update : Tue Jul 17 11:58:51 2012  
 Response via : Initial Calibration

Min. RRF : 0.000 Min. Rel. Area : 50% Max. R.T. Dev 0.33min  
 Max. RRF Dev : 30% Max. Rel. Area : 200%

	Compound	AvgRF	CCRF	%Dev	Area%	Dev(min)
38 T	o-Xylene	4.993	4.534	9.2	119	0.00
39 T	1,1,2,2-Tetrachloroethane	2.695	2.213	17.9	109	0.00
40 S	Bromofluorobenzene (SS3)	1.825	1.881	-3.1	130	0.00
41 T	1,3-Dichlorobenzene	2.885	2.432	15.7	114	0.00
42 T	1,4-Dichlorobenzene	2.876	2.419	15.9	116	0.00
43 T	1,2-Dichlorobenzene	2.780	2.345	15.6	115	0.00
44 T	1,2,4-Trichlorobenzene	1.629	1.433	12.0	124	0.00
45 T	Naphthalene	5.669	5.671	-0.0	153	0.00
46 T	Hexachlorobutadiene	1.055	0.878	16.8	118	0.00

(#) = Out of Range

SPCC's out = 0 CCC's out = 0

Radon Analysis (EPA Method GS: Grab Sample/Scintillation Cell counting)																			
<b>For GSI Environmental</b>																			
Samples Collected by: T. McHugh/L. Beckley										Client Project Number: G-3669, 3585									
Site: Tacoma, WA										Sample Dates: 07/25/2012, 7/26/12									
Analysts: Doug Hammond										Sample containers: Tedlar bags w/ nylon fittings									
Phone: 310-490-7896										Assumed Site Pressure: 1.00 atm									
email: dhammond@usc.edu										based on an elevation of 250 ft									
										Time Zone adjustment: add to decay time									
										0 hours									
										Collect (PDT)									
										Run (PDT)									
<b>Summary</b>																			
		Collection			Analysis					Lab Duplicates									
		Date	time	Date	time	Vol run	Conc.	±1 sig	mean	±1ssd	Notes								
		(PDT)	(PDT)	(PDT)	(PDT)	(cc)	pCi/L	pCi/L	pCi/L	pCi/L									
Received 07/26/12, from ESTCP (Project G-3669)																			
1		1-IA-3-BL	7/25/12	8:51	7/26/12	17:05	60	0.36	0.11										
2		1-IA-3-NP	7/25/12	11:06	7/26/12	17:02	120	0.20	0.06										
3		1-IA-3-PP	7/25/12	9:55	7/26/12	16:59	120	0.30	0.07										
4		1-AA-1	7/25/12	9:25	7/26/12	16:56	120	0.01	0.05										
Received 7/27/12, from JBLM (Project 3585)																			
5		2-IA-1-NP	7/26/12	10:15	7/27/12	18:22	120	0.12	0.02			more precise							
		lab dupe	7/26/12	10:15	7/30/12	10:37	120	0.23	0.11			less precise							
6		Dup-1	7/26/12	10:15	7/27/12	18:30	60	0.10	0.04										
7		2-IA-1-BL	7/26/12	8:36	7/27/12	18:18	120	0.09	0.03										
8		2-AA-1	7/26/12	8:45	7/27/12	18:26	120	0.09	0.03										
Uncertainty given in pCi/liter is based on counting statistics for low activity samples. For high activity samples uncertainty is ±5%.																			
The Lower Limit of Detection for Rn (95% confidence level as recommended by EPA 402-R-95-012, Oct. 97) is 0.14 pCi/liter.																			
Results are reported based on standardization with NIST-traceable radon sources.																			
These results are for application of naturally-occurring radon as a tracer of soil vapor intrusion, but are not intended for evaluation of radon hazards.																			
Note Details:																			
Results corrected to in situ pressure as noted above																			
<b>Raw Data, Calculation factors, and Analytical Details</b>																			
<b>Sample ID</b>		Collection		Analysis		Count in	He	Air/He	Vol run	Press	obs	sig	Decay T	Decay	Concentration	count	Notes		
		Date	Time	Date	Time	cell/ch	eff	eff	(cc)	factor	dpm	dpm	(hours)	factor	dpm/liter	pCi/liter	pCi/liter	±1 sig	
		(PDT)	(PDT)	(PDT)	(PDT)														
Received 07/26/12, from ESTCP (Project G-3669)																			
1		1-IA-3-BL	7/25/12	8:51	7/26/12	17:05	76/22	0.902	0.98	60	1.00	0.033	0.010	32.2	1.276	0.79	0.36	0.11	
2		1-IA-3-NP	7/25/12	11:06	7/26/12	17:02	84/11	0.785	0.95	120	1.00	0.032	0.010	29.9	1.254	0.45	0.20	0.06	
3		1-IA-3-PP	7/25/12	9:55	7/26/12	16:59	83/33	0.806	0.95	120	1.00	0.049	0.011	31.1	1.265	0.67	0.30	0.07	
4		1-AA-1	7/25/12	9:25	7/26/12	16:56	82/32	0.743	0.95	120	1.00	0.002	0.007	31.5	1.269	0.03	0.01	0.05	
Received 7/27/12, from JBLM (Project 3585)																			
5		2-IA-1-NP	7/26/12	10:15	7/27/12	18:22	81/31	0.818	0.95	120	1.00	0.019	0.004	32.1	1.275	0.26	0.12	0.02	
		lab dupe	7/26/12	10:15	7/30/12	10:37	82/32	0.743	0.95	120	1.00	0.021	0.010	96.4	2.071	0.51	0.23	0.11	
6		Dup-1	7/26/12	10:15	7/27/12	18:30	76/22	0.902	0.98	60	1.00	0.009	0.004	32.3	1.276	0.22	0.10	0.04	
7		2-IA-1-BL	7/26/12	8:36	7/27/12	18:18	82/32	0.743	0.95	120	1.00	0.013	0.004	33.7	1.290	0.20	0.09	0.03	
8		2-AA-1	7/26/12	8:45	7/27/12	18:26	83/33	0.806	0.95	120	1.00	0.014	0.004	33.7	1.290	0.20	0.09	0.03	
Decay corrections based on Rn decay constant of 0.1813 per day																			
Conversion from dpm based on 0.4504 pCi/dpm																			
Blanks are negligible.																			
<b>Definitions:</b>																			
Cell/ch:		Counting cell and channel used																	
He eff:		Cell and counter efficiency using helium matrix																	
Air/He:		Correction for matrix counting gas density																	
Sample vol:		Volume analyzed (cc)																	
Press factor:		Correction to in situ pressure based on collection altitude																	
obs dpm:		observed radon activity (disintegrations per minute) when analyzed																	
		sig dpm																	
		uncertainty (± 1 sig) in dpm based on counting statistics																	
		Decay T: time elapsed from sampling to analysis																	
		Decay factor: Correction factor for decay from collection to analysis																	
		dpm/liter: Radon concentration in disintegrations per minute per liter of sample																	
		pCi/liter: Radon concentration in picoCuries per liter																	
		count stats: uncertainty in observed radon based on counting statistics																	





**Summary: Averages**

	$\delta^{13}\text{C TCE (VPDB)}$	$\delta^{37}\text{Cl TCE (SMOC)}$
LC-18	-23.3	2.5
LC-48	-23.8	2.1
MT-1	-22.9	2.6
DUP-1	-23.6	2.4
1-IA-1-CSI	-25.9	2.0
1-SS-2-CSI	-18.5	5.8
3-SS-2-CSI	-18.8	5.5

**Replicates and standards****Water samples**

Run #	Sample ID	volume (ul)	$\delta^{13}\text{C TCE (VPDB)}$
6415	LC-18	4500	-23.3
6416	LC-48	2300	-23.9
6420	LC-48	2363	-23.7
6417	MT-1	2600	-22.7
6419	MT-1	5629	-23.2
6418	DUP-1	5000	-23.6

Run #	Standard ID	$\delta^{13}\text{C TCE (VPDB)}$
6414	Aqueous TCE	-30.65
6422	Aqueous TCE	-30.95
	stdev	0.2

Run #	Sample ID	volume (ul)	$\delta^{37}\text{Cl TCE (SMOC)}$
2910	LC-18	1270	2.5
2909	LC-48	547	2.0
2911	LC-48	500	2.1
2908	MT-1	1530	2.7
2912	MT-1	1525	2.6
2907	DUP-1	1250	2.4

Run #	Sample ID	$\delta^{37}\text{Cl TCE (SMOC)}$
2897	Aqueous TCE	3.5
2898	Aqueous TCE	3.6
2900	Aqueous TCE	3.3
2905	Aqueous TCE	3.5
2913	Aqueous TCE	2.6
	stdev	0.4

### Vapor samples

Run #	Sample ID	Tube #	$\delta^{13}\text{C}$ TCE (VPDB)	
8959	1-IA-1-CSI	C16_K08436	-25.9	see Note 1
8957	1-SS-2-CSI	C16_K08430	-18.2	
8960	1-SS-2-CSI	C16_J06979	-18.8	
8958	3-SS-2-CSI	C16_J03697	-18.8	

Run #	Standard ID	Tube #	$\delta^{13}\text{C}$ TCE (VPDB)
8956	Vapor TCE	C16_K08457	-31.0
8961	Vapor TCE	C16_K08440	-30.6
8955	Vapor TCE	C16_J03150	-30.9
		stdev	0.2

Run #	Sample ID	Tube #	$\delta^{37}\text{Cl}$ TCE (SMOC)
2926	1-IA-1-CSI	C16_K08451	2.0
2923	1-SS-2-CSI	C16_K08411	5.8
2924	3-SS-2-CSI	C16_J03143	5.5
2928	3-SS-2-CSI	C16_J06645	5.6

Run #	Standard ID	Tube #	$\delta^{37}\text{Cl}$ TCE (SMOC)
2922	STD	C16_J06695	3.1
2925	STD	C16_J04853	3.3
2927	STD	C16_J03770	3.8
2929	STD	C16_J03146	3.2
2930	STD	C16_J07356	3.1
		stdev	0.3

Note 1: limited coelution, the reported value is biased by 1-2 permil (i.e., the reported number is more negative than a true number)



Received by GSI, 3 May 2013

Results of additional analyses of JBLM samples:

**OU#613 TCE, C CSIA**

Dup = split of the sample recollected on Cx1016

all tube numbers refer to the original samples collected in the field

analytical uncertainty defined by the standards: Aug-12  $\pm$  0.4 (2 stdevs at n=4); Oct-12  $\pm$  0.6 (2 stdevs at n=7); April-13  $\pm$  0.4 (2 stdevs at n=10)

run #	date analyzed	sample ID	original airtube #	del TCE VPDB	remarks
8959	8/27/2012	1-IA-1-CSI	C16_K08436	-25.9	limited coelution, the reported number may be biased by 1-2 permil peak coelutes
9071	10/22/2012	1-IA-1-CSI	C16_J07242		
9480	4/17/2013	1-IA-1-CSI	C16_J03141	-26.0	split of run #9480
9483	4/17/2013	Dup 1-IA-1-CSI	C16_J03141	-26.4	
8957	8/27/2012	1-SS-2-CSI	C16_K08430	-18.2	split of run #9069
8960	8/27/2012	1-SS-2-CSI	C16_J06979	-18.8	
9069	10/22/2012	1-SS-2-CSI	C16_J07342	no peak	
9482	4/17/2013	Dup 1-SS-2-CSI	C16_J07342	no peak	
8958	8/27/2012	3-SS-2-CSI	C16_J03697	-18.8	split of run #9068
9068	10/22/2012	3-SS-2-CSI	C16_J03553	-19.5	
9481	4/17/2013	Dup 3-SS-2-CSI	C16_J03553	-18.8	

# **Selfridge Air National Guard Base, Michigan**

## LABORATORY REPORT

October 11, 2012

Tom McHugh  
GSI Environmental Inc.  
2211 Norfolk, Suite 1000  
Houston, TX 77098

**RE: ESTCP CSIA / OSA Demonstration / 3585/3669**

Dear Tom:

Your CAS report number P1203938 has been amended for the samples submitted to our laboratory on September 25, 2012. Sample Indoor-1-PP (P1203938-007) was re-run and a larger volume injected and the data has been added to the original report. The additional data pages have been indicated by the "Added Page" footer located at the bottom right of the page.

All analyses were performed according to our laboratory's NELAP and DoD-ELAP-approved quality assurance program. The test results meet requirements of the current NELAP and DoD-ELAP standards, where applicable, and except as noted in the laboratory case narrative provided. For a specific list of NELAP and DoD-ELAP-accredited analytes, refer to the certifications section at [www.caslab.com](http://www.caslab.com). Results are intended to be considered in their entirety and apply only to the samples analyzed and reported herein.

Columbia Analytical Services, Inc. dba ALS Environmental (ALS) is certified by the California Department of Health Services, NELAP Laboratory Certificate No. 02115CA; Arizona Department of Health Services, Certificate No. AZ0694; Florida Department of Health, NELAP Certification E871020; New Jersey Department of Environmental Protection, NELAP Laboratory Certification ID #CA009; New York State Department of Health, NELAP NY Lab ID No: 11221; Oregon Environmental Laboratory Accreditation Program, NELAP ID: CA200007; The American Industrial Hygiene Association, Laboratory #101661; United States Department of Defense Environmental Laboratory Accreditation Program (DoD-ELAP), Certificate No. L11-203; Pennsylvania Registration No. 68-03307; TX Commission of Environmental Quality, NELAP ID T104704413-12-3; Minnesota Department of Health, NELAP Certificate No. 362188; Washington State Department of Ecology, ELAP Lab ID: C946, State of Utah Department of Health, NELAP Certificate No. CA01527Z012-Z; Los Angeles Department of Building and Safety, Approval No: TA00001. Each of the certifications listed above have an explicit Scope of Accreditation that applies to specific matrices/methods/analytes; therefore, please contact me for information corresponding to a particular certification.

If you have any questions, please call me at (805) 526-7161.

Respectfully submitted,

**ALS | Environmental**



Digitally Signed By Sue Anderson at 1:26 pm, Oct 11, 2012

Sue Anderson  
Project Manager

Client: GSI Environmental Inc. Service Request No: P1203938  
Project: ESTCP CSIA / OSA Demonstration / 3585/3669

---

## CASE NARRATIVE

The samples were received intact under chain of custody on September 25, 2012 and were stored in accordance with the analytical method requirements. Please refer to the sample acceptance check form for additional information. The results reported herein are applicable only to the condition of the samples at the time of sample receipt.

### Volatile Organic Compound Analysis

The samples were analyzed for volatile organic compounds in accordance with EPA Method TO-15 from the Compendium of Methods for the Determination of Toxic Organic Compounds in Ambient Air, Second Edition (EPA/625/R-96/010b), January, 1999. The analytical system was comprised of a gas chromatograph / mass spectrometer (GC/MS) interfaced to a whole-air preconcentrator.

---

*The results of analyses are given in the attached laboratory report. All results are intended to be considered in their entirety, and Columbia Analytical Services, Inc. dba ALS Environmental (ALS) is not responsible for utilization of less than the complete report.*

*Use of Columbia Analytical Services, Inc. dba ALS Environmental (ALS)'s Name. Client shall not use ALS's name or trademark in any marketing or reporting materials, press releases or in any other manner ("Materials") whatsoever and shall not attribute to AALS any test result, tolerance or specification derived from ALS's data ("Attribution") without ALS's prior written consent, which may be withheld by ALS for any reason in its sole discretion. To request ALS's consent, Client shall provide copies of the proposed Materials or Attribution and describe in writing Client's proposed use of such Materials or Attribution. If ALS has not provided written approval of the Materials or Attribution within ten (10) days of receipt from Client, Client's request to use ALS's name or trademark in any Materials or Attribution shall be deemed denied. ALS may, in its discretion, reasonably charge Client for its time in reviewing Materials or Attribution requests. Client acknowledges and agrees that the unauthorized use of ALS's name or trademark may cause ALS to incur irreparable harm for which the recovery of money damages will be inadequate. Accordingly, Client acknowledges and agrees that a violation shall justify preliminary injunctive relief. For questions contact the laboratory.*

DETAIL SUMMARY REPORT

Client: GSI Environmental Inc.  
 Project ID: ESTCP CSIA / OSA Demonstration / 3585/3669

Service Request: P1203938

Date Received: 9/25/2012  
 Time Received: 09:35

TO-15 - VOC Cans

Client Sample ID	Lab Code	Matrix	Date Collected	Time Collected	Container ID	Pi1 (psig)	Pf1 (psig)	
Indoor-C1	P1203938-001	Air	9/18/2012	16:30	AS00243	-3.20	3.58	X
Outdoor-C1	P1203938-002	Air	9/18/2012	16:30	AC01931	-2.16	3.60	X
SS-1C	P1203938-003	Air	9/18/2012	13:20	AC00942	-0.73	3.53	X
SS-2C	P1203938-004	Air	9/18/2012	13:40	AC00977	-0.30	3.54	X
SS-3C	P1203938-005	Air	9/18/2012	13:55	AC01198	-1.53	3.50	X
Indoor-1-BL	P1203938-006	Air	9/19/2012	11:12	AS00228	0.02	3.61	X
Indoor-1-PP	P1203938-007	Air	9/19/2012	14:13	AC00376	-0.05	3.51	X
Indoor-1-NP	P1203938-008	Air	9/19/2012	16:40	AC01877	-0.02	4.36	X
Dup 1	P1203938-009	Air	9/19/2012	00:00	AC00745	-0.03	3.59	X

2655 Park Center Drive, Suite A  
 Sirm Valley, California 93065  
 Phone (805) 526-7161  
 Fax (805) 526-7270

**Requested Turnaround Time in Business Days (Surcharges) please circle**  
 1 Day (100%) 2 Day (75%) 3 Day (50%) 4 Day (35%) 5 Day (25%) 10 Day-Standard

CAS Project No. P1203938

**Company Name & Address (Reporting Information)**

GSI Environmental  
 2211 Norfolk Blvd 1020  
 Houston TX ~~77078~~ 77098

Project Manager  
 Tom McHugh/Lita Beckley

Phone 713 522 6300 Fax \_\_\_\_\_

**Email Address for Result Reporting**

temc@gsi-net.com, lbeckley@gsi-net.com

**Sampler (Print & Sign)**

TEM/LMB

**Project Name**

ESTP CS1A/GSA Demonstration

**Project Number**

3585/3669

**P.O. # / Billing Information**

**CAS Contact:**

Sue Anderson

**Analysis Method**

**Comments**  
 e.g. Actual Preservative or specific instructions

TO-15 Scan

Client Sample ID	Laboratory ID Number	Date Collected	Time Collected	Sampler ID (Bar code # - AC, SC, etc.)	Flow Controller ID (Bar code # - FC #)	Canister Start Pressure "Hg	Canister End Pressure "Hg/psig	Sample Volume	Analysis Method	Comments
<u>Indoor-C1</u>	<u>1-319</u>	<u>9/18/2012</u>	<u>0835-1630</u>	<u>AS00243</u>	<u>FCA00515</u>	<u>-29</u>	<u>-6.2</u>	<u>6L</u>	<u>✓</u>	<u>field cans</u>
<u>Ductlow-C1</u>	<u>2-216</u>	<u>9/18/2012</u>	<u>0835-1630</u>	<u>AE01931</u>	<u>FCA00392</u>	<u>-29</u>	<u>-4.5</u>	<u>6L</u>	<u>✓</u>	<u>after TO-15 for possible add'l analysis</u>
<u>SS-1C</u>	<u>3-071</u>	<u>9/18/2012</u>	<u>1320</u>	<u>AC00942</u>	<u>-</u>	<u>-28.8</u>	<u>-0.4</u>	<u>6L</u>	<u>✓</u>	<u>analysis</u>
<u>SS-2C</u>	<u>4-026</u>	<u>9/18/2012</u>	<u>1340</u>	<u>AC00977</u>	<u>-</u>	<u>-29.1</u>	<u>0</u>	<u>6L</u>	<u>✓</u>	<u>analysis</u>
<u>SS-3C</u>	<u>5-150</u>	<u>9/18/2012</u>	<u>1355</u>	<u>AC01198</u>	<u>-</u>	<u>-29.2</u>	<u>-2.5</u>	<u>6L</u>	<u>✓</u>	<u>analysis</u>
<u>Indoor-1-BL</u>	<u>6-1002</u>	<u>9/19/2012</u>	<u>1112</u>	<u>AS00228</u>	<u>-</u>	<u>-29.2</u>	<u>0</u>	<u>6L</u>	<u>✓</u>	<u>analysis</u>
<u>Indoor-1-PP</u>	<u>7-006</u>	<u>9/19/2012</u>	<u>1413</u>	<u>AE50376</u>	<u>-</u>	<u>-29.2</u>	<u>0</u>	<u>6L</u>	<u>✓</u>	<u>analysis</u>
<u>Indoor-1-NP</u>	<u>8-006</u>	<u>9/19/2012</u>	<u>1640</u>	<u>AE01877</u>	<u>-</u>	<u>-29</u>	<u>0</u>	<u>6L</u>	<u>✓</u>	<u>analysis</u>
<u>Dup 1</u>	<u>9-011</u>	<u>9/19/2012</u>	<u>1453</u>	<u>AC00745</u>	<u>-</u>	<u>-29</u>	<u>0</u>	<u>6L</u>	<u>✓</u>	<u>analysis</u>

**Report Tier Levels - please select**

Tier I - Results (Default if not specified) \_\_\_\_\_

Tier II (Results + QC Summaries) \_\_\_\_\_

Tier III (Results + QC & Calibration Summaries) ✓

EDD required Yes No \_\_\_\_\_  
 Type: log/m3

Project Requirements (MRLs, QAPP)

Relinquished by: (Signature) <u>[Signature]</u>	Date: <u>9/19/12</u>	Time: <u>1800</u>	Received by: (Signature) <u>[Signature]</u>	Date: <u>9/19/12</u>	Time: <u>0935</u>	Cooler / Blank Temperature _____ °C
Relinquished by: (Signature)	Date: _____	Time: _____	Received by: (Signature)	Date: _____	Time: _____	Cooler / Blank Temperature _____ °C

**Sample Acceptance Check Form**

Client: GSI Environmental Inc. Work order: P1203938

Project: ESTCP CSIA / OSA Demonstration / 3585/3669

Sample(s) received on: 9/25/12 Date opened: 9/25/12 by: MZAMORA

**Note:** This form is used for all samples received by CAS. The use of this form for custody seals is strictly meant to indicate presence/absence and not as an indication of compliance or nonconformity. Thermal preservation and pH will only be evaluated either at the request of the client and/or as required by the method/SOP.

- |  | <u>Yes</u>                          | <u>No</u>                           | <u>N/A</u>                          |
|--|-------------------------------------|-------------------------------------|-------------------------------------|
| 1 Were <b>sample containers</b> properly marked with client sample ID?   | <input checked="" type="checkbox"/> | <input type="checkbox"/>            | <input type="checkbox"/>            |
| 2 Container(s) <b>supplied by CAS</b> ?  | <input checked="" type="checkbox"/> | <input type="checkbox"/>            | <input type="checkbox"/>            |
| 3 Did <b>sample containers</b> arrive in good condition?   | <input checked="" type="checkbox"/> | <input type="checkbox"/>            | <input type="checkbox"/>            |
| 4 Were <b>chain-of-custody</b> papers used and filled out?   | <input checked="" type="checkbox"/> | <input type="checkbox"/>            | <input type="checkbox"/>            |
| 5 Did <b>sample container labels</b> and/or tags agree with custody papers?                                      | <input type="checkbox"/>            | <input checked="" type="checkbox"/> | <input type="checkbox"/>            |
| 6 Was <b>sample volume</b> received adequate for analysis?   | <input checked="" type="checkbox"/> | <input type="checkbox"/>            | <input type="checkbox"/>            |
| 7 Are samples within specified holding times?  | <input checked="" type="checkbox"/> | <input type="checkbox"/>            | <input type="checkbox"/>            |
| 8 Was proper <b>temperature</b> (thermal preservation) of cooler at receipt adhered to?                          | <input type="checkbox"/>            | <input type="checkbox"/>            | <input checked="" type="checkbox"/> |
| 9 Was a <b>trip blank</b> received?  | <input type="checkbox"/>            | <input checked="" type="checkbox"/> | <input type="checkbox"/>            |
| 10 Were <b>custody seals</b> on outside of cooler/Box?   | <input type="checkbox"/>            | <input checked="" type="checkbox"/> | <input type="checkbox"/>            |
| Location of seal(s)? _____ Sealing Lid?  | <input type="checkbox"/>            | <input type="checkbox"/>            | <input checked="" type="checkbox"/> |
| Were signature and date included?  | <input type="checkbox"/>            | <input type="checkbox"/>            | <input checked="" type="checkbox"/> |
| Were seals intact?   | <input type="checkbox"/>            | <input type="checkbox"/>            | <input checked="" type="checkbox"/> |
| Were custody seals on outside of sample container?   | <input type="checkbox"/>            | <input checked="" type="checkbox"/> | <input type="checkbox"/>            |
| Location of seal(s)? _____ Sealing Lid?  | <input type="checkbox"/>            | <input type="checkbox"/>            | <input checked="" type="checkbox"/> |
| Were signature and date included?  | <input type="checkbox"/>            | <input type="checkbox"/>            | <input checked="" type="checkbox"/> |
| Were seals intact?   | <input type="checkbox"/>            | <input type="checkbox"/>            | <input checked="" type="checkbox"/> |
| 11 Do containers have appropriate <b>preservation</b> , according to method/SOP or Client specified information? | <input type="checkbox"/>            | <input type="checkbox"/>            | <input checked="" type="checkbox"/> |
| Is there a client indication that the submitted samples are <b>pH</b> preserved?                                 | <input type="checkbox"/>            | <input type="checkbox"/>            | <input checked="" type="checkbox"/> |
| Were <b>VOA vials</b> checked for presence/absence of air bubbles?   | <input type="checkbox"/>            | <input type="checkbox"/>            | <input checked="" type="checkbox"/> |
| Does the client/method/SOP require that the analyst check the sample pH and <u>if necessary</u> alter it?        | <input type="checkbox"/>            | <input type="checkbox"/>            | <input checked="" type="checkbox"/> |
| 12 <b>Tubes:</b> Are the tubes capped and intact?  | <input type="checkbox"/>            | <input type="checkbox"/>            | <input checked="" type="checkbox"/> |
| Do they contain moisture?  | <input type="checkbox"/>            | <input type="checkbox"/>            | <input checked="" type="checkbox"/> |
| 13 <b>Badges:</b> Are the badges properly capped and intact?   | <input type="checkbox"/>            | <input type="checkbox"/>            | <input checked="" type="checkbox"/> |
| Are dual bed badges separated and individually capped and intact?  | <input type="checkbox"/>            | <input type="checkbox"/>            | <input checked="" type="checkbox"/> |

Lab Sample ID	Container Description	Required pH *	Received pH	Adjusted pH	VOA Headspace (Presence/Absence)	Receipt / Preservation Comments
P1203938-001.01	6.0 L Silonite Can					
P1203938-002.01	6.0 L Ambient Can					
P1203938-003.01	6.0 L Ambient Can					
P1203938-004.01	6.0 L Ambient Can					
P1203938-005.01	6.0 L Ambient Can					
P1203938-006.01	6.0 L Silonite Can					
P1203938-007.01	6.0 L Ambient Can					
P1203938-008.01	6.0 L Ambient Can					

Explain any discrepancies: (include lab sample ID numbers): \_\_\_\_\_

Sample -002 has an ID of (Outdoor-C1) on the COC, and (Ambient-C1) on the canister tag.





RESULTS OF ANALYSIS

Page 1 of 3

**Client:** GSI Environmental Inc.  
**Client Sample ID:** Indoor-C1  
**Client Project ID:** ESTCP CSIA / OSA Demonstration / 3585/3669

CAS Project ID: P1203938  
CAS Sample ID: P1203938-001

Test Code: EPA TO-15  
Instrument ID: Tekmar AUTOCAN/Agilent 5975Cinert/6890N/MS16  
Analyst: Lusine Hakobyan  
Sampling Media: 6.0 L Summa Canister  
Test Notes:  
Container ID: AS00243

Date Collected: 9/18/12  
Date Received: 9/25/12  
Date Analyzed: 9/28/12  
Volume(s) Analyzed: 0.014 Liter(s)

Initial Pressure (psig): -3.20 Final Pressure (psig): 3.58

Canister Dilution Factor: 1.59

CAS #	Compound	Result	MRL	Result	MRL	Data Qualifier
		µg/m <sup>3</sup>	µg/m <sup>3</sup>	ppbV	ppbV	
115-07-1	Propene	ND	57	ND	33	
75-71-8	Dichlorodifluoromethane (CFC 12)	ND	57	ND	11	
74-87-3	Chloromethane	ND	23	ND	11	
76-14-2	1,2-Dichloro-1,1,2,2-tetrafluoroethane (CFC 114)	ND	57	ND	8.1	
75-01-4	Vinyl Chloride	ND	11	ND	4.4	
106-99-0	1,3-Butadiene	ND	23	ND	10	
74-83-9	Bromomethane	ND	11	ND	2.9	
75-00-3	Chloroethane	ND	11	ND	4.3	
64-17-5	Ethanol	ND	570	ND	300	
75-05-8	Acetonitrile	ND	57	ND	34	
107-02-8	Acrolein	ND	230	ND	99	
67-64-1	Acetone	<b>54,000</b>	570	<b>23,000</b>	240	
75-69-4	Trichlorofluoromethane	ND	11	ND	2.0	
67-63-0	2-Propanol (Isopropyl Alcohol)	ND	570	ND	230	
107-13-1	Acrylonitrile	ND	57	ND	26	
75-35-4	1,1-Dichloroethene	ND	11	ND	2.9	
75-09-2	Methylene Chloride	ND	57	ND	16	
107-05-1	3-Chloro-1-propene (Allyl Chloride)	ND	11	ND	3.6	
76-13-1	Trichlorotrifluoroethane	ND	11	ND	1.5	
75-15-0	Carbon Disulfide	ND	570	ND	180	
156-60-5	trans-1,2-Dichloroethene	ND	11	ND	2.9	
75-34-3	1,1-Dichloroethane	ND	11	ND	2.8	
1634-04-4	Methyl tert-Butyl Ether	ND	11	ND	3.2	
108-05-4	Vinyl Acetate	ND	570	ND	160	
78-93-3	2-Butanone (MEK)	ND	570	ND	190	

ND = Compound was analyzed for, but not detected above the laboratory reporting limit.

MRL = Method Reporting Limit - The minimum quantity of a target analyte that can be confidently determined by the referenced method.

RESULTS OF ANALYSIS

Page 2 of 3

**Client:** GSI Environmental Inc.

**Client Sample ID:** Indoor-C1

**Client Project ID:** ESTCP CSIA / OSA Demonstration / 3585/3669

CAS Project ID: P1203938

CAS Sample ID: P1203938-001

Test Code: EPA TO-15

Date Collected: 9/18/12

Instrument ID: Tekmar AUTOCAN/Agilent 5975Cinert/6890N/MS16

Date Received: 9/25/12

Analyst: Lusine Hakobyan

Date Analyzed: 9/28/12

Sampling Media: 6.0 L Summa Canister

Volume(s) Analyzed: 0.014 Liter(s)

Test Notes:

Container ID: AS00243

Initial Pressure (psig): -3.20 Final Pressure (psig): 3.58

Canister Dilution Factor: 1.59

CAS #	Compound	Result µg/m <sup>3</sup>	MRL µg/m <sup>3</sup>	Result ppbV	MRL ppbV	Data Qualifier
156-59-2	cis-1,2-Dichloroethene	ND	11	ND	2.9	
141-78-6	Ethyl Acetate	ND	110	ND	32	
110-54-3	n-Hexane	<b>240</b>	57	<b>67</b>	16	
67-66-3	Chloroform	ND	11	ND	2.3	
109-99-9	Tetrahydrofuran (THF)	ND	57	ND	19	
107-06-2	1,2-Dichloroethane	ND	11	ND	2.8	
71-55-6	1,1,1-Trichloroethane	ND	11	ND	2.1	
71-43-2	Benzene	<b>14</b>	11	<b>4.4</b>	3.6	
56-23-5	Carbon Tetrachloride	ND	11	ND	1.8	
110-82-7	Cyclohexane	ND	110	ND	33	
78-87-5	1,2-Dichloropropane	ND	11	ND	2.5	
75-27-4	Bromodichloromethane	ND	11	ND	1.7	
79-01-6	Trichloroethene	<b>48</b>	11	<b>9.0</b>	2.1	
123-91-1	1,4-Dioxane	ND	57	ND	16	
80-62-6	Methyl Methacrylate	ND	110	ND	28	
142-82-5	n-Heptane	<b>5,700</b>	57	<b>1,400</b>	14	
10061-01-5	cis-1,3-Dichloropropene	ND	57	ND	13	
108-10-1	4-Methyl-2-pentanone	ND	57	ND	14	
10061-02-6	trans-1,3-Dichloropropene	ND	57	ND	13	
79-00-5	1,1,2-Trichloroethane	ND	11	ND	2.1	
108-88-3	Toluene	ND	57	ND	15	
591-78-6	2-Hexanone	ND	57	ND	14	
124-48-1	Dibromochloromethane	ND	11	ND	1.3	
106-93-4	1,2-Dibromoethane	ND	11	ND	1.5	
123-86-4	n-Butyl Acetate	ND	57	ND	12	

ND = Compound was analyzed for, but not detected above the laboratory reporting limit.

MRL = Method Reporting Limit - The minimum quantity of a target analyte that can be confidently determined by the referenced method.

RESULTS OF ANALYSIS

Page 3 of 3

**Client:** GSI Environmental Inc.  
**Client Sample ID:** Indoor-C1  
**Client Project ID:** ESTCP CSIA / OSA Demonstration / 3585/3669

CAS Project ID: P1203938  
CAS Sample ID: P1203938-001

Test Code: EPA TO-15  
Instrument ID: Tekmar AUTOCAN/Agilent 5975Cinert/6890N/MS16  
Analyst: Lusine Hakobyan  
Sampling Media: 6.0 L Summa Canister  
Test Notes:  
Container ID: AS00243

Date Collected: 9/18/12  
Date Received: 9/25/12  
Date Analyzed: 9/28/12  
Volume(s) Analyzed: 0.014 Liter(s)

Initial Pressure (psig): -3.20 Final Pressure (psig): 3.58

Canister Dilution Factor: 1.59

CAS #	Compound	Result µg/m <sup>3</sup>	MRL µg/m <sup>3</sup>	Result ppbV	MRL ppbV	Data Qualifier
111-65-9	n-Octane	ND	57	ND	12	
127-18-4	Tetrachloroethene	ND	11	ND	1.7	
108-90-7	Chlorobenzene	ND	11	ND	2.5	
100-41-4	Ethylbenzene	ND	57	ND	13	
179601-23-1	m,p-Xylenes	ND	57	ND	13	
75-25-2	Bromoform	ND	57	ND	5.5	
100-42-5	Styrene	ND	57	ND	13	
95-47-6	o-Xylene	ND	57	ND	13	
111-84-2	n-Nonane	ND	57	ND	11	
79-34-5	1,1,2,2-Tetrachloroethane	ND	11	ND	1.7	
98-82-8	Cumene	ND	57	ND	12	
80-56-8	alpha-Pinene	ND	57	ND	10	
103-65-1	n-Propylbenzene	ND	57	ND	12	
622-96-8	4-Ethyltoluene	ND	57	ND	12	
108-67-8	1,3,5-Trimethylbenzene	ND	57	ND	12	
95-63-6	1,2,4-Trimethylbenzene	ND	57	ND	12	
100-44-7	Benzyl Chloride	ND	57	ND	11	
541-73-1	1,3-Dichlorobenzene	ND	11	ND	1.9	
106-46-7	1,4-Dichlorobenzene	ND	11	ND	1.9	
95-50-1	1,2-Dichlorobenzene	ND	11	ND	1.9	
5989-27-5	d-Limonene	ND	57	ND	10	
96-12-8	1,2-Dibromo-3-chloropropane	ND	57	ND	5.9	
120-82-1	1,2,4-Trichlorobenzene	ND	57	ND	7.7	
91-20-3	Naphthalene	ND	57	ND	11	
87-68-3	Hexachlorobutadiene	ND	57	ND	5.3	

ND = Compound was analyzed for, but not detected above the laboratory reporting limit.

MRL = Method Reporting Limit - The minimum quantity of a target analyte that can be confidently determined by the referenced method.

RESULTS OF ANALYSIS

Page 1 of 3

**Client:** GSI Environmental Inc.

**Client Sample ID:** Outdoor-C1

**Client Project ID:** ESTCP CSIA / OSA Demonstration / 3585/3669

CAS Project ID: P1203938

CAS Sample ID: P1203938-002

Test Code: EPA TO-15

Date Collected: 9/18/12

Instrument ID: Tekmar AUTOCAN/Agilent 5975Cinert/6890N/MS16

Date Received: 9/25/12

Analyst: Lusine Hakobyan

Date Analyzed: 9/28/12

Sampling Media: 6.0 L Summa Canister

Volume(s) Analyzed: 1.00 Liter(s)

Test Notes:

Container ID: AC01931

Initial Pressure (psig): -2.16 Final Pressure (psig): 3.60

Canister Dilution Factor: 1.46

CAS #	Compound	Result	MRL	Result	MRL	Data Qualifier
		µg/m <sup>3</sup>	µg/m <sup>3</sup>	ppbV	ppbV	
115-07-1	Propene	4.8	0.73	2.8	0.42	
75-71-8	Dichlorodifluoromethane (CFC 12)	2.2	0.73	0.44	0.15	
74-87-3	Chloromethane	0.37	0.29	0.18	0.14	
76-14-2	1,2-Dichloro-1,1,2,2-tetrafluoroethane (CFC 114)	ND	0.73	ND	0.10	
75-01-4	Vinyl Chloride	ND	0.15	ND	0.057	
106-99-0	1,3-Butadiene	ND	0.29	ND	0.13	
74-83-9	Bromomethane	ND	0.15	ND	0.038	
75-00-3	Chloroethane	ND	0.15	ND	0.055	
64-17-5	Ethanol	ND	7.3	ND	3.9	
75-05-8	Acetonitrile	ND	0.73	ND	0.43	
107-02-8	Acrolein	ND	2.9	ND	1.3	
67-64-1	Acetone	14	7.3	6.1	3.1	
75-69-4	Trichlorofluoromethane	1.2	0.15	0.21	0.026	
67-63-0	2-Propanol (Isopropyl Alcohol)	14	7.3	5.6	3.0	
107-13-1	Acrylonitrile	ND	0.73	ND	0.34	
75-35-4	1,1-Dichloroethene	ND	0.15	ND	0.037	
75-09-2	Methylene Chloride	ND	0.73	ND	0.21	
107-05-1	3-Chloro-1-propene (Allyl Chloride)	ND	0.15	ND	0.047	
76-13-1	Trichlorotrifluoroethane	0.48	0.15	0.063	0.019	
75-15-0	Carbon Disulfide	ND	7.3	ND	2.3	
156-60-5	trans-1,2-Dichloroethene	ND	0.15	ND	0.037	
75-34-3	1,1-Dichloroethane	ND	0.15	ND	0.036	
1634-04-4	Methyl tert-Butyl Ether	ND	0.15	ND	0.041	
108-05-4	Vinyl Acetate	ND	7.3	ND	2.1	
78-93-3	2-Butanone (MEK)	ND	7.3	ND	2.5	

ND = Compound was analyzed for, but not detected above the laboratory reporting limit.

MRL = Method Reporting Limit - The minimum quantity of a target analyte that can be confidently determined by the referenced method.

RESULTS OF ANALYSIS

Page 2 of 3

**Client:** GSI Environmental Inc.

**Client Sample ID:** Outdoor-C1

**Client Project ID:** ESTCP CSIA / OSA Demonstration / 3585/3669

CAS Project ID: P1203938

CAS Sample ID: P1203938-002

Test Code: EPA TO-15

Date Collected: 9/18/12

Instrument ID: Tekmar AUTOCAN/Agilent 5975Cinert/6890N/MS16

Date Received: 9/25/12

Analyst: Lusine Hakobyan

Date Analyzed: 9/28/12

Sampling Media: 6.0 L Summa Canister

Volume(s) Analyzed: 1.00 Liter(s)

Test Notes:

Container ID: AC01931

Initial Pressure (psig): -2.16 Final Pressure (psig): 3.60

Canister Dilution Factor: 1.46

CAS #	Compound	Result µg/m <sup>3</sup>	MRL µg/m <sup>3</sup>	Result ppbV	MRL ppbV	Data Qualifier
156-59-2	cis-1,2-Dichloroethene	ND	0.15	ND	0.037	
141-78-6	Ethyl Acetate	<b>3.1</b>	1.5	<b>0.86</b>	0.41	
110-54-3	n-Hexane	ND	0.73	ND	0.21	
67-66-3	Chloroform	ND	0.15	ND	0.030	
109-99-9	Tetrahydrofuran (THF)	ND	0.73	ND	0.25	
107-06-2	1,2-Dichloroethane	ND	0.15	ND	0.036	
71-55-6	1,1,1-Trichloroethane	ND	0.15	ND	0.027	
71-43-2	Benzene	<b>0.27</b>	0.15	<b>0.086</b>	0.046	
56-23-5	Carbon Tetrachloride	<b>0.48</b>	0.15	<b>0.077</b>	0.023	
110-82-7	Cyclohexane	ND	1.5	ND	0.42	
78-87-5	1,2-Dichloropropane	ND	0.15	ND	0.032	
75-27-4	Bromodichloromethane	ND	0.15	ND	0.022	
79-01-6	Trichloroethene	<b>0.30</b>	0.15	<b>0.055</b>	0.027	
123-91-1	1,4-Dioxane	ND	0.73	ND	0.20	
80-62-6	Methyl Methacrylate	ND	1.5	ND	0.36	
142-82-5	n-Heptane	<b>0.91</b>	0.73	<b>0.22</b>	0.18	
10061-01-5	cis-1,3-Dichloropropene	ND	0.73	ND	0.16	
108-10-1	4-Methyl-2-pentanone	ND	0.73	ND	0.18	
10061-02-6	trans-1,3-Dichloropropene	ND	0.73	ND	0.16	
79-00-5	1,1,2-Trichloroethane	ND	0.15	ND	0.027	
108-88-3	Toluene	<b>1.2</b>	0.73	<b>0.32</b>	0.19	
591-78-6	2-Hexanone	ND	0.73	ND	0.18	
124-48-1	Dibromochloromethane	ND	0.15	ND	0.017	
106-93-4	1,2-Dibromoethane	ND	0.15	ND	0.019	
123-86-4	n-Butyl Acetate	ND	0.73	ND	0.15	

ND = Compound was analyzed for, but not detected above the laboratory reporting limit.

MRL = Method Reporting Limit - The minimum quantity of a target analyte that can be confidently determined by the referenced method.

RESULTS OF ANALYSIS

Page 3 of 3

**Client:** GSI Environmental Inc.  
**Client Sample ID:** Outdoor-C1  
**Client Project ID:** ESTCP CSIA / OSA Demonstration / 3585/3669

CAS Project ID: P1203938  
CAS Sample ID: P1203938-002

Test Code: EPA TO-15  
Instrument ID: Tekmar AUTOCAN/Agilent 5975Cinert/6890N/MS16  
Analyst: Lusine Hakobyan  
Sampling Media: 6.0 L Summa Canister  
Test Notes:  
Container ID: AC01931

Date Collected: 9/18/12  
Date Received: 9/25/12  
Date Analyzed: 9/28/12  
Volume(s) Analyzed: 1.00 Liter(s)

Initial Pressure (psig): -2.16 Final Pressure (psig): 3.60

Canister Dilution Factor: 1.46

CAS #	Compound	Result µg/m <sup>3</sup>	MRL µg/m <sup>3</sup>	Result ppbV	MRL ppbV	Data Qualifier
111-65-9	n-Octane	ND	0.73	ND	0.16	
127-18-4	Tetrachloroethene	<b>0.52</b>	0.15	<b>0.077</b>	0.022	
108-90-7	Chlorobenzene	ND	0.15	ND	0.032	
100-41-4	Ethylbenzene	ND	0.73	ND	0.17	
179601-23-1	m,p-Xylenes	ND	0.73	ND	0.17	
75-25-2	Bromoform	ND	0.73	ND	0.071	
100-42-5	Styrene	ND	0.73	ND	0.17	
95-47-6	o-Xylene	ND	0.73	ND	0.17	
111-84-2	n-Nonane	ND	0.73	ND	0.14	
79-34-5	1,1,2,2-Tetrachloroethane	ND	0.15	ND	0.021	
98-82-8	Cumene	ND	0.73	ND	0.15	
80-56-8	alpha-Pinene	ND	0.73	ND	0.13	
103-65-1	n-Propylbenzene	ND	0.73	ND	0.15	
622-96-8	4-Ethyltoluene	ND	0.73	ND	0.15	
108-67-8	1,3,5-Trimethylbenzene	ND	0.73	ND	0.15	
95-63-6	1,2,4-Trimethylbenzene	ND	0.73	ND	0.15	
100-44-7	Benzyl Chloride	ND	0.73	ND	0.14	
541-73-1	1,3-Dichlorobenzene	ND	0.15	ND	0.024	
106-46-7	1,4-Dichlorobenzene	ND	0.15	ND	0.024	
95-50-1	1,2-Dichlorobenzene	ND	0.15	ND	0.024	
5989-27-5	d-Limonene	ND	0.73	ND	0.13	
96-12-8	1,2-Dibromo-3-chloropropane	ND	0.73	ND	0.076	
120-82-1	1,2,4-Trichlorobenzene	ND	0.73	ND	0.098	
91-20-3	Naphthalene	ND	0.73	ND	0.14	
87-68-3	Hexachlorobutadiene	ND	0.73	ND	0.068	

ND = Compound was analyzed for, but not detected above the laboratory reporting limit.

MRL = Method Reporting Limit - The minimum quantity of a target analyte that can be confidently determined by the referenced method.

RESULTS OF ANALYSIS

Page 1 of 3

**Client:** GSI Environmental Inc.

**Client Sample ID:** SS-1C

**Client Project ID:** ESTCP CSIA / OSA Demonstration / 3585/3669

CAS Project ID: P1203938

CAS Sample ID: P1203938-003

Test Code: EPA TO-15

Date Collected: 9/18/12

Instrument ID: Tekmar AUTOCAN/Agilent 5975Cinert/6890N/MS16

Date Received: 9/25/12

Analyst: Lusine Hakobyan

Date Analyzed: 9/28/12

Sampling Media: 6.0 L Summa Canister

Volume(s) Analyzed: 0.014 Liter(s)

Test Notes:

Container ID: AC00942

Initial Pressure (psig): -0.73      Final Pressure (psig): 3.53

Canister Dilution Factor: 1.30

CAS #	Compound	Result	MRL	Result	MRL	Data Qualifier
		µg/m <sup>3</sup>	µg/m <sup>3</sup>	ppbV	ppbV	
115-07-1	Propene	ND	46	ND	27	
75-71-8	Dichlorodifluoromethane (CFC 12)	ND	46	ND	9.4	
74-87-3	Chloromethane	ND	19	ND	9.0	
76-14-2	1,2-Dichloro-1,1,2,2-tetrafluoroethane (CFC 114)	ND	46	ND	6.6	
75-01-4	Vinyl Chloride	ND	9.3	ND	3.6	
106-99-0	1,3-Butadiene	ND	19	ND	8.4	
74-83-9	Bromomethane	ND	9.3	ND	2.4	
75-00-3	Chloroethane	ND	9.3	ND	3.5	
64-17-5	Ethanol	ND	460	ND	250	
75-05-8	Acetonitrile	ND	46	ND	28	
107-02-8	Acrolein	ND	190	ND	81	
67-64-1	Acetone	510	460	220	200	
75-69-4	Trichlorofluoromethane	ND	9.3	ND	1.7	
67-63-0	2-Propanol (Isopropyl Alcohol)	ND	460	ND	190	
107-13-1	Acrylonitrile	ND	46	ND	21	
75-35-4	1,1-Dichloroethene	ND	9.3	ND	2.3	
75-09-2	Methylene Chloride	ND	46	ND	13	
107-05-1	3-Chloro-1-propene (Allyl Chloride)	ND	9.3	ND	3.0	
76-13-1	Trichlorotrifluoroethane	ND	9.3	ND	1.2	
75-15-0	Carbon Disulfide	ND	460	ND	150	
156-60-5	trans-1,2-Dichloroethene	ND	9.3	ND	2.3	
75-34-3	1,1-Dichloroethane	ND	9.3	ND	2.3	
1634-04-4	Methyl tert-Butyl Ether	ND	9.3	ND	2.6	
108-05-4	Vinyl Acetate	ND	460	ND	130	
78-93-3	2-Butanone (MEK)	ND	460	ND	160	

ND = Compound was analyzed for, but not detected above the laboratory reporting limit.

MRL = Method Reporting Limit - The minimum quantity of a target analyte that can be confidently determined by the referenced method.

RESULTS OF ANALYSIS

Page 2 of 3

**Client:** GSI Environmental Inc.  
**Client Sample ID:** SS-1C  
**Client Project ID:** ESTCP CSIA / OSA Demonstration / 3585/3669

CAS Project ID: P1203938  
CAS Sample ID: P1203938-003

Test Code: EPA TO-15  
Instrument ID: Tekmar AUTOCAN/Agilent 5975Cinert/6890N/MS16  
Analyst: Lusine Hakobyan  
Sampling Media: 6.0 L Summa Canister  
Test Notes:  
Container ID: AC00942

Date Collected: 9/18/12  
Date Received: 9/25/12  
Date Analyzed: 9/28/12  
Volume(s) Analyzed: 0.014 Liter(s)

Initial Pressure (psig): -0.73 Final Pressure (psig): 3.53

Canister Dilution Factor: 1.30

CAS #	Compound	Result µg/m <sup>3</sup>	MRL µg/m <sup>3</sup>	Result ppbV	MRL ppbV	Data Qualifier
156-59-2	cis-1,2-Dichloroethene	ND	9.3	ND	2.3	
141-78-6	Ethyl Acetate	ND	93	ND	26	
110-54-3	n-Hexane	ND	46	ND	13	
67-66-3	Chloroform	ND	9.3	ND	1.9	
109-99-9	Tetrahydrofuran (THF)	ND	46	ND	16	
107-06-2	1,2-Dichloroethane	ND	9.3	ND	2.3	
71-55-6	1,1,1-Trichloroethane	ND	9.3	ND	1.7	
71-43-2	Benzene	ND	9.3	ND	2.9	
56-23-5	Carbon Tetrachloride	ND	9.3	ND	1.5	
110-82-7	Cyclohexane	ND	93	ND	27	
78-87-5	1,2-Dichloropropane	ND	9.3	ND	2.0	
75-27-4	Bromodichloromethane	ND	9.3	ND	1.4	
79-01-6	Trichloroethene	9.4	9.3	1.7	1.7	
123-91-1	1,4-Dioxane	ND	46	ND	13	
80-62-6	Methyl Methacrylate	ND	93	ND	23	
142-82-5	n-Heptane	ND	46	ND	11	
10061-01-5	cis-1,3-Dichloropropene	ND	46	ND	10	
108-10-1	4-Methyl-2-pentanone	ND	46	ND	11	
10061-02-6	trans-1,3-Dichloropropene	ND	46	ND	10	
79-00-5	1,1,2-Trichloroethane	ND	9.3	ND	1.7	
108-88-3	Toluene	ND	46	ND	12	
591-78-6	2-Hexanone	ND	46	ND	11	
124-48-1	Dibromochloromethane	ND	9.3	ND	1.1	
106-93-4	1,2-Dibromoethane	ND	9.3	ND	1.2	
123-86-4	n-Butyl Acetate	ND	46	ND	9.8	

ND = Compound was analyzed for, but not detected above the laboratory reporting limit.

MRL = Method Reporting Limit - The minimum quantity of a target analyte that can be confidently determined by the referenced method.



RESULTS OF ANALYSIS

Page 3 of 3

**Client:** GSI Environmental Inc.  
**Client Sample ID:** SS-1C  
**Client Project ID:** ESTCP CSIA / OSA Demonstration / 3585/3669

CAS Project ID: P1203938  
CAS Sample ID: P1203938-003

Test Code: EPA TO-15  
Instrument ID: Tekmar AUTOCAN/Agilent 5975Cinert/6890N/MS16  
Analyst: Lusine Hakobyan  
Sampling Media: 6.0 L Summa Canister  
Test Notes:  
Container ID: AC00942

Date Collected: 9/18/12  
Date Received: 9/25/12  
Date Analyzed: 9/28/12  
Volume(s) Analyzed: 0.014 Liter(s)

Initial Pressure (psig): -0.73 Final Pressure (psig): 3.53

Canister Dilution Factor: 1.30

CAS #	Compound	Result µg/m <sup>3</sup>	MRL µg/m <sup>3</sup>	Result ppbV	MRL ppbV	Data Qualifier
111-65-9	n-Octane	ND	46	ND	9.9	
127-18-4	Tetrachloroethene	8,000	9.3	1,200	1.4	
108-90-7	Chlorobenzene	ND	9.3	ND	2.0	
100-41-4	Ethylbenzene	ND	46	ND	11	
179601-23-1	m,p-Xylenes	ND	46	ND	11	
75-25-2	Bromoform	ND	46	ND	4.5	
100-42-5	Styrene	ND	46	ND	11	
95-47-6	o-Xylene	ND	46	ND	11	
111-84-2	n-Nonane	ND	46	ND	8.9	
79-34-5	1,1,2,2-Tetrachloroethane	ND	9.3	ND	1.4	
98-82-8	Cumene	ND	46	ND	9.4	
80-56-8	alpha-Pinene	ND	46	ND	8.3	
103-65-1	n-Propylbenzene	ND	46	ND	9.4	
622-96-8	4-Ethyltoluene	ND	46	ND	9.4	
108-67-8	1,3,5-Trimethylbenzene	ND	46	ND	9.4	
95-63-6	1,2,4-Trimethylbenzene	ND	46	ND	9.4	
100-44-7	Benzyl Chloride	ND	46	ND	9.0	
541-73-1	1,3-Dichlorobenzene	ND	9.3	ND	1.5	
106-46-7	1,4-Dichlorobenzene	ND	9.3	ND	1.5	
95-50-1	1,2-Dichlorobenzene	ND	9.3	ND	1.5	
5989-27-5	d-Limonene	ND	46	ND	8.3	
96-12-8	1,2-Dibromo-3-chloropropane	ND	46	ND	4.8	
120-82-1	1,2,4-Trichlorobenzene	ND	46	ND	6.3	
91-20-3	Naphthalene	ND	46	ND	8.9	
87-68-3	Hexachlorobutadiene	ND	46	ND	4.4	

ND = Compound was analyzed for, but not detected above the laboratory reporting limit.

MRL = Method Reporting Limit - The minimum quantity of a target analyte that can be confidently determined by the referenced method.

## RESULTS OF ANALYSIS

Page 1 of 3

**Client:** GSI Environmental Inc.

**Client Sample ID:** SS-2C

**Client Project ID:** ESTCP CSIA / OSA Demonstration / 3585/3669

CAS Project ID: P1203938

CAS Sample ID: P1203938-004

Test Code: EPA TO-15

Date Collected: 9/18/12

Instrument ID: Tekmar AUTOCAN/Agilent 5975Cinert/6890N/MS16

Date Received: 9/25/12

Analyst: Lusine Hakobyan

Date Analyzed: 9/28/12

Sampling Media: 6.0 L Summa Canister

Volume(s) Analyzed: 0.020 Liter(s)

Test Notes:

Container ID: AC00977

Initial Pressure (psig): -0.30      Final Pressure (psig): 3.54

Canister Dilution Factor: 1.27

CAS #	Compound	Result	MRL	Result	MRL	Data Qualifier
		µg/m <sup>3</sup>	µg/m <sup>3</sup>	ppbV	ppbV	
115-07-1	Propene	ND	32	ND	18	
75-71-8	Dichlorodifluoromethane (CFC 12)	ND	32	ND	6.4	
74-87-3	Chloromethane	ND	13	ND	6.2	
76-14-2	1,2-Dichloro-1,1,2,2-tetrafluoroethane (CFC 114)	ND	32	ND	4.5	
75-01-4	Vinyl Chloride	ND	6.4	ND	2.5	
106-99-0	1,3-Butadiene	ND	13	ND	5.7	
74-83-9	Bromomethane	ND	6.4	ND	1.6	
75-00-3	Chloroethane	ND	6.4	ND	2.4	
64-17-5	Ethanol	ND	320	ND	170	
75-05-8	Acetonitrile	ND	32	ND	19	
107-02-8	Acrolein	ND	130	ND	55	
67-64-1	Acetone	<b>3,300</b>	320	<b>1,400</b>	130	
75-69-4	Trichlorofluoromethane	ND	6.4	ND	1.1	
67-63-0	2-Propanol (Isopropyl Alcohol)	ND	320	ND	130	
107-13-1	Acrylonitrile	ND	32	ND	15	
75-35-4	1,1-Dichloroethene	ND	6.4	ND	1.6	
75-09-2	Methylene Chloride	ND	32	ND	9.1	
107-05-1	3-Chloro-1-propene (Allyl Chloride)	ND	6.4	ND	2.0	
76-13-1	Trichlorotrifluoroethane	ND	6.4	ND	0.83	
75-15-0	Carbon Disulfide	ND	320	ND	100	
156-60-5	trans-1,2-Dichloroethene	ND	6.4	ND	1.6	
75-34-3	1,1-Dichloroethane	ND	6.4	ND	1.6	
1634-04-4	Methyl tert-Butyl Ether	ND	6.4	ND	1.8	
108-05-4	Vinyl Acetate	ND	320	ND	90	
78-93-3	2-Butanone (MEK)	ND	320	ND	110	

ND = Compound was analyzed for, but not detected above the laboratory reporting limit.

MRL = Method Reporting Limit - The minimum quantity of a target analyte that can be confidently determined by the referenced method.

RESULTS OF ANALYSIS

Page 2 of 3

**Client:** GSI Environmental Inc.

**Client Sample ID:** SS-2C

**Client Project ID:** ESTCP CSIA / OSA Demonstration / 3585/3669

CAS Project ID: P1203938

CAS Sample ID: P1203938-004

Test Code: EPA TO-15

Date Collected: 9/18/12

Instrument ID: Tekmar AUTOCAN/Agilent 5975Cinert/6890N/MS16

Date Received: 9/25/12

Analyst: Lusine Hakobyan

Date Analyzed: 9/28/12

Sampling Media: 6.0 L Summa Canister

Volume(s) Analyzed: 0.020 Liter(s)

Test Notes:

Container ID: AC00977

Initial Pressure (psig): -0.30 Final Pressure (psig): 3.54

Canister Dilution Factor: 1.27

CAS #	Compound	Result µg/m <sup>3</sup>	MRL µg/m <sup>3</sup>	Result ppbV	MRL ppbV	Data Qualifier
156-59-2	cis-1,2-Dichloroethene	ND	6.4	ND	1.6	
141-78-6	Ethyl Acetate	ND	64	ND	18	
110-54-3	n-Hexane	<b>1,200</b>	32	<b>350</b>	9.0	
67-66-3	Chloroform	ND	6.4	ND	1.3	
109-99-9	Tetrahydrofuran (THF)	ND	32	ND	11	
107-06-2	1,2-Dichloroethane	ND	6.4	ND	1.6	
71-55-6	1,1,1-Trichloroethane	ND	6.4	ND	1.2	
71-43-2	Benzene	<b>58</b>	6.4	<b>18</b>	2.0	
56-23-5	Carbon Tetrachloride	ND	6.4	ND	1.0	
110-82-7	Cyclohexane	<b>480</b>	64	<b>140</b>	18	
78-87-5	1,2-Dichloropropane	ND	6.4	ND	1.4	
75-27-4	Bromodichloromethane	ND	6.4	ND	0.95	
79-01-6	Trichloroethene	<b>26</b>	6.4	<b>4.8</b>	1.2	
123-91-1	1,4-Dioxane	ND	32	ND	8.8	
80-62-6	Methyl Methacrylate	ND	64	ND	16	
142-82-5	n-Heptane	<b>960</b>	32	<b>230</b>	7.8	
10061-01-5	cis-1,3-Dichloropropene	ND	32	ND	7.0	
108-10-1	4-Methyl-2-pentanone	ND	32	ND	7.8	
10061-02-6	trans-1,3-Dichloropropene	ND	32	ND	7.0	
79-00-5	1,1,2-Trichloroethane	ND	6.4	ND	1.2	
108-88-3	Toluene	<b>52</b>	32	<b>14</b>	8.4	
591-78-6	2-Hexanone	ND	32	ND	7.8	
124-48-1	Dibromochloromethane	ND	6.4	ND	0.75	
106-93-4	1,2-Dibromoethane	ND	6.4	ND	0.83	
123-86-4	n-Butyl Acetate	ND	32	ND	6.7	

ND = Compound was analyzed for, but not detected above the laboratory reporting limit.

MRL = Method Reporting Limit - The minimum quantity of a target analyte that can be confidently determined by the referenced method.

## RESULTS OF ANALYSIS

Page 3 of 3

**Client:** GSI Environmental Inc.  
**Client Sample ID:** SS-2C  
**Client Project ID:** ESTCP CSIA / OSA Demonstration / 3585/3669

**CAS Project ID:** P1203938  
**CAS Sample ID:** P1203938-004

**Test Code:** EPA TO-15  
**Instrument ID:** Tekmar AUTOCAN/Agilent 5975Cinert/6890N/MS16  
**Analyst:** Lusine Hakobyan  
**Sampling Media:** 6.0 L Summa Canister  
**Test Notes:**  
**Container ID:** AC00977

**Date Collected:** 9/18/12  
**Date Received:** 9/25/12  
**Date Analyzed:** 9/28/12  
**Volume(s) Analyzed:** 0.020 Liter(s)

Initial Pressure (psig): -0.30      Final Pressure (psig): 3.54

Canister Dilution Factor: 1.27

CAS #	Compound	Result µg/m <sup>3</sup>	MRL µg/m <sup>3</sup>	Result ppbV	MRL ppbV	Data Qualifier
111-65-9	n-Octane	210	32	45	6.8	
127-18-4	Tetrachloroethene	5,000	6.4	740	0.94	
108-90-7	Chlorobenzene	ND	6.4	ND	1.4	
100-41-4	Ethylbenzene	430	32	98	7.3	
179601-23-1	m,p-Xylenes	770	32	180	7.3	
75-25-2	Bromoform	ND	32	ND	3.1	
100-42-5	Styrene	ND	32	ND	7.5	
95-47-6	o-Xylene	ND	32	ND	7.3	
111-84-2	n-Nonane	51	32	9.8	6.1	
79-34-5	1,1,2,2-Tetrachloroethane	ND	6.4	ND	0.93	
98-82-8	Cumene	34	32	7.0	6.5	
80-56-8	alpha-Pinene	ND	32	ND	5.7	
103-65-1	n-Propylbenzene	130	32	27	6.5	
622-96-8	4-Ethyltoluene	260	32	52	6.5	
108-67-8	1,3,5-Trimethylbenzene	220	32	45	6.5	
95-63-6	1,2,4-Trimethylbenzene	860	32	170	6.5	
100-44-7	Benzyl Chloride	ND	32	ND	6.1	
541-73-1	1,3-Dichlorobenzene	ND	6.4	ND	1.1	
106-46-7	1,4-Dichlorobenzene	ND	6.4	ND	1.1	
95-50-1	1,2-Dichlorobenzene	ND	6.4	ND	1.1	
5989-27-5	d-Limonene	ND	32	ND	5.7	
96-12-8	1,2-Dibromo-3-chloropropane	ND	32	ND	3.3	
120-82-1	1,2,4-Trichlorobenzene	ND	32	ND	4.3	
91-20-3	Naphthalene	ND	32	ND	6.1	
87-68-3	Hexachlorobutadiene	ND	32	ND	3.0	

ND = Compound was analyzed for, but not detected above the laboratory reporting limit.

MRL = Method Reporting Limit - The minimum quantity of a target analyte that can be confidently determined by the referenced method.

## RESULTS OF ANALYSIS

Page 1 of 3

**Client:** GSI Environmental Inc.

**Client Sample ID:** SS-3C

**Client Project ID:** ESTCP CSIA / OSA Demonstration / 3585/3669

CAS Project ID: P1203938

CAS Sample ID: P1203938-005

Test Code: EPA TO-15

Date Collected: 9/18/12

Instrument ID: Tekmar AUTOCAN/Agilent 5975Cinert/6890N/MS16

Date Received: 9/25/12

Analyst: Lusine Hakobyan

Date Analyzed: 9/28/12

Sampling Media: 6.0 L Summa Canister

Volume(s) Analyzed: 1.00 Liter(s)

Test Notes:

0.10 Liter(s)

Container ID: AC01198

Initial Pressure (psig): -1.53      Final Pressure (psig): 3.50

Canister Dilution Factor: 1.38

CAS #	Compound	Result	MRL	Result	MRL	Data Qualifier
		µg/m <sup>3</sup>	µg/m <sup>3</sup>	ppbV	ppbV	
115-07-1	Propene	2.2	0.69	1.3	0.40	
75-71-8	Dichlorodifluoromethane (CFC 12)	2.2	0.69	0.45	0.14	
74-87-3	Chloromethane	ND	0.28	ND	0.13	
76-14-2	1,2-Dichloro-1,1,2,2-tetrafluoroethane (CFC 114)	ND	0.69	ND	0.099	
75-01-4	Vinyl Chloride	ND	0.14	ND	0.054	
106-99-0	1,3-Butadiene	ND	0.28	ND	0.12	
74-83-9	Bromomethane	ND	0.14	ND	0.036	
75-00-3	Chloroethane	ND	0.14	ND	0.052	
64-17-5	Ethanol	ND	6.9	ND	3.7	
75-05-8	Acetonitrile	ND	0.69	ND	0.41	
107-02-8	Acrolein	ND	2.8	ND	1.2	
67-64-1	Acetone	250	6.9	110	2.9	
75-69-4	Trichlorofluoromethane	0.88	0.14	0.16	0.025	
67-63-0	2-Propanol (Isopropyl Alcohol)	ND	6.9	ND	2.8	
107-13-1	Acrylonitrile	ND	0.69	ND	0.32	
75-35-4	1,1-Dichloroethene	ND	0.14	ND	0.035	
75-09-2	Methylene Chloride	ND	0.69	ND	0.20	
107-05-1	3-Chloro-1-propene (Allyl Chloride)	ND	0.14	ND	0.044	
76-13-1	Trichlorotrifluoroethane	0.45	0.14	0.058	0.018	
75-15-0	Carbon Disulfide	ND	6.9	ND	2.2	
156-60-5	trans-1,2-Dichloroethene	ND	0.14	ND	0.035	
75-34-3	1,1-Dichloroethane	ND	0.14	ND	0.034	
1634-04-4	Methyl tert-Butyl Ether	0.45	0.14	0.13	0.038	
108-05-4	Vinyl Acetate	ND	6.9	ND	2.0	
78-93-3	2-Butanone (MEK)	ND	6.9	ND	2.3	

ND = Compound was analyzed for, but not detected above the laboratory reporting limit.

MRL = Method Reporting Limit - The minimum quantity of a target analyte that can be confidently determined by the referenced method.

RESULTS OF ANALYSIS

Page 2 of 3

**Client:** GSI Environmental Inc.

**Client Sample ID:** SS-3C

**Client Project ID:** ESTCP CSIA / OSA Demonstration / 3585/3669

CAS Project ID: P1203938

CAS Sample ID: P1203938-005

Test Code: EPA TO-15

Date Collected: 9/18/12

Instrument ID: Tekmar AUTOCAN/Agilent 5975Cinert/6890N/MS16

Date Received: 9/25/12

Analyst: Lusine Hakobyan

Date Analyzed: 9/28/12

Sampling Media: 6.0 L Summa Canister

Volume(s) Analyzed: 1.00 Liter(s)

Test Notes:

0.10 Liter(s)

Container ID: AC01198

Initial Pressure (psig): -1.53 Final Pressure (psig): 3.50

Canister Dilution Factor: 1.38

CAS #	Compound	Result µg/m <sup>3</sup>	MRL µg/m <sup>3</sup>	Result ppbV	MRL ppbV	Data Qualifier
156-59-2	cis-1,2-Dichloroethene	ND	0.14	ND	0.035	
141-78-6	Ethyl Acetate	ND	1.4	ND	0.38	
110-54-3	n-Hexane	<b>1.2</b>	0.69	<b>0.35</b>	0.20	
67-66-3	Chloroform	<b>0.20</b>	0.14	<b>0.041</b>	0.028	
109-99-9	Tetrahydrofuran (THF)	ND	0.69	ND	0.23	
107-06-2	1,2-Dichloroethane	ND	0.14	ND	0.034	
71-55-6	1,1,1-Trichloroethane	ND	0.14	ND	0.025	
71-43-2	Benzene	<b>0.32</b>	0.14	<b>0.10</b>	0.043	
56-23-5	Carbon Tetrachloride	ND	0.14	ND	0.022	
110-82-7	Cyclohexane	ND	1.4	ND	0.40	
78-87-5	1,2-Dichloropropane	ND	0.14	ND	0.030	
75-27-4	Bromodichloromethane	ND	0.14	ND	0.021	
79-01-6	Trichloroethene	<b>0.63</b>	0.14	<b>0.12</b>	0.026	
123-91-1	1,4-Dioxane	ND	0.69	ND	0.19	
80-62-6	Methyl Methacrylate	ND	1.4	ND	0.34	
142-82-5	n-Heptane	<b>11</b>	0.69	<b>2.6</b>	0.17	
10061-01-5	cis-1,3-Dichloropropene	ND	0.69	ND	0.15	
108-10-1	4-Methyl-2-pentanone	ND	0.69	ND	0.17	
10061-02-6	trans-1,3-Dichloropropene	ND	0.69	ND	0.15	
79-00-5	1,1,2-Trichloroethane	ND	0.14	ND	0.025	
108-88-3	Toluene	<b>1.5</b>	0.69	<b>0.40</b>	0.18	
591-78-6	2-Hexanone	ND	0.69	ND	0.17	
124-48-1	Dibromochloromethane	ND	0.14	ND	0.016	
106-93-4	1,2-Dibromoethane	ND	0.14	ND	0.018	
123-86-4	n-Butyl Acetate	ND	0.69	ND	0.15	

ND = Compound was analyzed for, but not detected above the laboratory reporting limit.

MRL = Method Reporting Limit - The minimum quantity of a target analyte that can be confidently determined by the referenced method.

RESULTS OF ANALYSIS

Page 3 of 3

**Client:** GSI Environmental Inc.  
**Client Sample ID:** SS-3C  
**Client Project ID:** ESTCP CSIA / OSA Demonstration / 3585/3669

CAS Project ID: P1203938  
CAS Sample ID: P1203938-005

Test Code: EPA TO-15  
Instrument ID: Tekmar AUTOCAN/Agilent 5975Cinert/6890N/MS16  
Analyst: Lusine Hakobyan  
Sampling Media: 6.0 L Summa Canister  
Test Notes:  
Container ID: AC01198

Date Collected: 9/18/12  
Date Received: 9/25/12  
Date Analyzed: 9/28/12  
Volume(s) Analyzed: 1.00 Liter(s)  
0.10 Liter(s)

Initial Pressure (psig): -1.53 Final Pressure (psig): 3.50

Canister Dilution Factor: 1.38

CAS #	Compound	Result µg/m <sup>3</sup>	MRL µg/m <sup>3</sup>	Result ppbV	MRL ppbV	Data Qualifier
111-65-9	n-Octane	0.91	0.69	0.20	0.15	
127-18-4	Tetrachloroethene	610	1.4	89	0.20	D
108-90-7	Chlorobenzene	ND	0.14	ND	0.030	
100-41-4	Ethylbenzene	0.92	0.69	0.21	0.16	
179601-23-1	m,p-Xylenes	3.0	0.69	0.70	0.16	
75-25-2	Bromoform	ND	0.69	ND	0.067	
100-42-5	Styrene	ND	0.69	ND	0.16	
95-47-6	o-Xylene	2.2	0.69	0.51	0.16	
111-84-2	n-Nonane	ND	0.69	ND	0.13	
79-34-5	1,1,2,2-Tetrachloroethane	ND	0.14	ND	0.020	
98-82-8	Cumene	ND	0.69	ND	0.14	
80-56-8	alpha-Pinene	2.8	0.69	0.50	0.12	
103-65-1	n-Propylbenzene	ND	0.69	ND	0.14	
622-96-8	4-Ethyltoluene	1.2	0.69	0.24	0.14	
108-67-8	1,3,5-Trimethylbenzene	7.4	0.69	1.5	0.14	
95-63-6	1,2,4-Trimethylbenzene	25	0.69	5.0	0.14	
100-44-7	Benzyl Chloride	ND	0.69	ND	0.13	
541-73-1	1,3-Dichlorobenzene	ND	0.14	ND	0.023	
106-46-7	1,4-Dichlorobenzene	0.14	0.14	0.023	0.023	
95-50-1	1,2-Dichlorobenzene	ND	0.14	ND	0.023	
5989-27-5	d-Limonene	ND	0.69	ND	0.12	
96-12-8	1,2-Dibromo-3-chloropropane	ND	0.69	ND	0.071	
120-82-1	1,2,4-Trichlorobenzene	ND	0.69	ND	0.093	
91-20-3	Naphthalene	11	0.69	2.1	0.13	
87-68-3	Hexachlorobutadiene	ND	0.69	ND	0.065	

ND = Compound was analyzed for, but not detected above the laboratory reporting limit.

MRL = Method Reporting Limit - The minimum quantity of a target analyte that can be confidently determined by the referenced method.

D = The reported result is from a dilution.

RESULTS OF ANALYSIS

Page 1 of 3

**Client:** GSI Environmental Inc.

**Client Sample ID:** Indoor-1-BL

**Client Project ID:** ESTCP CSIA / OSA Demonstration / 3585/3669

CAS Project ID: P1203938

CAS Sample ID: P1203938-006

Test Code: EPA TO-15

Date Collected: 9/19/12

Instrument ID: Tekmar AUTOCAN/Agilent 5975Cinert/6890N/MS16

Date Received: 9/25/12

Analyst: Lusine Hakobyan

Date Analyzed: 9/28/12

Sampling Media: 6.0 L Summa Canister

Volume(s) Analyzed: 0.50 Liter(s)

Test Notes:

0.050 Liter(s)

Container ID: AS00228

Initial Pressure (psig): 0.02 Final Pressure (psig): 3.61

Canister Dilution Factor: 1.24

CAS #	Compound	Result µg/m <sup>3</sup>	MRL µg/m <sup>3</sup>	Result ppbV	MRL ppbV	Data Qualifier
115-07-1	Propene	86	1.2	50	0.72	
75-71-8	Dichlorodifluoromethane (CFC 12)	2.3	1.2	0.47	0.25	
74-87-3	Chloromethane	0.86	0.50	0.42	0.24	
76-14-2	1,2-Dichloro-1,1,2,2-tetrafluoroethane (CFC 114)	ND	1.2	ND	0.18	
75-01-4	Vinyl Chloride	ND	0.25	ND	0.097	
106-99-0	1,3-Butadiene	33	0.50	15	0.22	
74-83-9	Bromomethane	ND	0.25	ND	0.064	
75-00-3	Chloroethane	ND	0.25	ND	0.094	
64-17-5	Ethanol	77	12	41	6.6	
75-05-8	Acetonitrile	2.4	1.2	1.4	0.74	
107-02-8	Acrolein	ND	5.0	ND	2.2	
67-64-1	Acetone	1,100	12	480	5.2	
75-69-4	Trichlorofluoromethane	1.2	0.25	0.22	0.044	
67-63-0	2-Propanol (Isopropyl Alcohol)	21	12	8.5	5.0	
107-13-1	Acrylonitrile	ND	1.2	ND	0.57	
75-35-4	1,1-Dichloroethene	ND	0.25	ND	0.063	
75-09-2	Methylene Chloride	23	1.2	6.7	0.36	
107-05-1	3-Chloro-1-propene (Allyl Chloride)	ND	0.25	ND	0.079	
76-13-1	Trichlorotrifluoroethane	0.49	0.25	0.064	0.032	
75-15-0	Carbon Disulfide	ND	12	ND	4.0	
156-60-5	trans-1,2-Dichloroethene	ND	0.25	ND	0.063	
75-34-3	1,1-Dichloroethane	ND	0.25	ND	0.061	
1634-04-4	Methyl tert-Butyl Ether	ND	0.25	ND	0.069	
108-05-4	Vinyl Acetate	ND	12	ND	3.5	
78-93-3	2-Butanone (MEK)	ND	12	ND	4.2	

ND = Compound was analyzed for, but not detected above the laboratory reporting limit.

MRL = Method Reporting Limit - The minimum quantity of a target analyte that can be confidently determined by the referenced method.



RESULTS OF ANALYSIS

Page 2 of 3

**Client:** GSI Environmental Inc.

**Client Sample ID:** Indoor-1-BL

**Client Project ID:** ESTCP CSIA / OSA Demonstration / 3585/3669

CAS Project ID: P1203938

CAS Sample ID: P1203938-006

Test Code: EPA TO-15

Date Collected: 9/19/12

Instrument ID: Tekmar AUTOCAN/Agilent 5975Cinert/6890N/MS16

Date Received: 9/25/12

Analyst: Lusine Hakobyan

Date Analyzed: 9/28/12

Sampling Media: 6.0 L Summa Canister

Volume(s) Analyzed: 0.50 Liter(s)

Test Notes:

0.050 Liter(s)

Container ID: AS00228

Initial Pressure (psig): 0.02 Final Pressure (psig): 3.61

Canister Dilution Factor: 1.24

CAS #	Compound	Result µg/m <sup>3</sup>	MRL µg/m <sup>3</sup>	Result ppbV	MRL ppbV	Data Qualifier
156-59-2	cis-1,2-Dichloroethene	ND	0.25	ND	0.063	
141-78-6	Ethyl Acetate	ND	2.5	ND	0.69	
110-54-3	n-Hexane	<b>68</b>	1.2	<b>19</b>	0.35	
67-66-3	Chloroform	<b>0.27</b>	0.25	<b>0.055</b>	0.051	
109-99-9	Tetrahydrofuran (THF)	ND	1.2	ND	0.42	
107-06-2	1,2-Dichloroethane	ND	0.25	ND	0.061	
71-55-6	1,1,1-Trichloroethane	ND	0.25	ND	0.045	
71-43-2	Benzene	<b>130</b>	0.25	<b>41</b>	0.078	
56-23-5	Carbon Tetrachloride	<b>0.55</b>	0.25	<b>0.088</b>	0.039	
110-82-7	Cyclohexane	<b>12</b>	2.5	<b>3.6</b>	0.72	
78-87-5	1,2-Dichloropropane	ND	0.25	ND	0.054	
75-27-4	Bromodichloromethane	ND	0.25	ND	0.037	
79-01-6	Trichloroethene	<b>140</b>	0.25	<b>26</b>	0.046	
123-91-1	1,4-Dioxane	ND	1.2	ND	0.34	
80-62-6	Methyl Methacrylate	ND	2.5	ND	0.61	
142-82-5	n-Heptane	<b>130</b>	1.2	<b>32</b>	0.30	
10061-01-5	cis-1,3-Dichloropropene	ND	1.2	ND	0.27	
108-10-1	4-Methyl-2-pentanone	<b>20</b>	1.2	<b>4.9</b>	0.30	
10061-02-6	trans-1,3-Dichloropropene	ND	1.2	ND	0.27	
79-00-5	1,1,2-Trichloroethane	ND	0.25	ND	0.045	
108-88-3	Toluene	<b>410</b>	12	<b>110</b>	3.3	<b>D</b>
591-78-6	2-Hexanone	ND	1.2	ND	0.30	
124-48-1	Dibromochloromethane	ND	0.25	ND	0.029	
106-93-4	1,2-Dibromoethane	ND	0.25	ND	0.032	
123-86-4	n-Butyl Acetate	<b>2.1</b>	1.2	<b>0.45</b>	0.26	

ND = Compound was analyzed for, but not detected above the laboratory reporting limit.

MRL = Method Reporting Limit - The minimum quantity of a target analyte that can be confidently determined by the referenced method.

D = The reported result is from a dilution.

RESULTS OF ANALYSIS

Page 3 of 3

**Client:** GSI Environmental Inc.  
**Client Sample ID:** Indoor-1-BL  
**Client Project ID:** ESTCP CSIA / OSA Demonstration / 3585/3669

CAS Project ID: P1203938  
CAS Sample ID: P1203938-006

Test Code: EPA TO-15  
Instrument ID: Tekmar AUTOCAN/Agilent 5975Cinert/6890N/MS16  
Analyst: Lusine Hakobyan  
Sampling Media: 6.0 L Summa Canister  
Test Notes:  
Container ID: AS00228

Date Collected: 9/19/12  
Date Received: 9/25/12  
Date Analyzed: 9/28/12  
Volume(s) Analyzed: 0.50 Liter(s)  
0.050 Liter(s)

Initial Pressure (psig): 0.02 Final Pressure (psig): 3.61

Canister Dilution Factor: 1.24

CAS #	Compound	Result µg/m <sup>3</sup>	MRL µg/m <sup>3</sup>	Result ppbV	MRL ppbV	Data Qualifier
111-65-9	n-Octane	25	1.2	5.4	0.27	
127-18-4	Tetrachloroethene	1.8	0.25	0.26	0.037	
108-90-7	Chlorobenzene	ND	0.25	ND	0.054	
100-41-4	Ethylbenzene	84	1.2	19	0.29	
179601-23-1	m,p-Xylenes	290	1.2	66	0.29	
75-25-2	Bromoform	ND	1.2	ND	0.12	
100-42-5	Styrene	31	1.2	7.2	0.29	
95-47-6	o-Xylene	100	1.2	24	0.29	
111-84-2	n-Nonane	46	1.2	8.7	0.24	
79-34-5	1,1,2,2-Tetrachloroethane	ND	0.25	ND	0.036	
98-82-8	Cumene	4.3	1.2	0.88	0.25	
80-56-8	alpha-Pinene	ND	1.2	ND	0.22	
103-65-1	n-Propylbenzene	16	1.2	3.2	0.25	
622-96-8	4-Ethyltoluene	36	1.2	7.4	0.25	
108-67-8	1,3,5-Trimethylbenzene	38	1.2	7.8	0.25	
95-63-6	1,2,4-Trimethylbenzene	120	1.2	25	0.25	
100-44-7	Benzyl Chloride	ND	1.2	ND	0.24	
541-73-1	1,3-Dichlorobenzene	ND	0.25	ND	0.041	
106-46-7	1,4-Dichlorobenzene	ND	0.25	ND	0.041	
95-50-1	1,2-Dichlorobenzene	ND	0.25	ND	0.041	
5989-27-5	d-Limonene	23	1.2	4.1	0.22	
96-12-8	1,2-Dibromo-3-chloropropane	ND	1.2	ND	0.13	
120-82-1	1,2,4-Trichlorobenzene	ND	1.2	ND	0.17	
91-20-3	Naphthalene	19	1.2	3.6	0.24	
87-68-3	Hexachlorobutadiene	ND	1.2	ND	0.12	

ND = Compound was analyzed for, but not detected above the laboratory reporting limit.

MRL = Method Reporting Limit - The minimum quantity of a target analyte that can be confidently determined by the referenced method.

RESULTS OF ANALYSIS

Page 1 of 3

**Client:** GSI Environmental Inc.

**Client Sample ID:** Indoor-1-PP

**Client Project ID:** ESTCP CSIA / OSA Demonstration / 3585/3669

CAS Project ID: P1203938

CAS Sample ID: P1203938-007

Test Code: EPA TO-15

Date Collected: 9/19/12

Instrument ID: Tekmar AUTOCAN/Agilent 5975Cinert/6890N/MS16

Date Received: 9/26/12

Analyst: Lusine Hakobyan

Date Analyzed: 9/28/12 & 10/1/12

Sampling Media: 6.0 L Summa Canister

Volume(s) Analyzed: 0.040 Liter(s)

Test Notes:

0.020 Liter(s)

Container ID: AC00376

Initial Pressure (psig): -0.05 Final Pressure (psig): 3.51

Canister Dilution Factor: 1.24

CAS #	Compound	Result	MRL	Result	MRL	Data Qualifier
		µg/m <sup>3</sup>	µg/m <sup>3</sup>	ppbV	ppbV	
115-07-1	Propene	ND	16	ND	9.0	
75-71-8	Dichlorodifluoromethane (CFC 12)	ND	16	ND	3.1	
74-87-3	Chloromethane	ND	6.2	ND	3.0	
76-14-2	1,2-Dichloro-1,1,2,2-tetrafluoroethane (CFC 114)	ND	16	ND	2.2	
75-01-4	Vinyl Chloride	ND	3.1	ND	1.2	
106-99-0	1,3-Butadiene	ND	6.2	ND	2.8	
74-83-9	Bromomethane	ND	3.1	ND	0.80	
75-00-3	Chloroethane	ND	3.1	ND	1.2	
64-17-5	Ethanol	ND	160	ND	82	
75-05-8	Acetonitrile	ND	16	ND	9.2	
107-02-8	Acrolein	ND	62	ND	27	
67-64-1	Acetone	<b>23,000</b>	310	<b>9,500</b>	130	<b>D</b>
75-69-4	Trichlorofluoromethane	ND	3.1	ND	0.55	
67-63-0	2-Propanol (Isopropyl Alcohol)	ND	160	ND	63	
107-13-1	Acrylonitrile	ND	16	ND	7.1	
75-35-4	1,1-Dichloroethene	ND	3.1	ND	0.78	
75-09-2	Methylene Chloride	<b>16</b>	16	<b>4.6</b>	4.5	
107-05-1	3-Chloro-1-propene (Allyl Chloride)	ND	3.1	ND	0.99	
76-13-1	Trichlorotrifluoroethane	ND	3.1	ND	0.40	
75-15-0	Carbon Disulfide	ND	160	ND	50	
156-60-5	trans-1,2-Dichloroethene	ND	3.1	ND	0.78	
75-34-3	1,1-Dichloroethane	ND	3.1	ND	0.77	
1634-04-4	Methyl tert-Butyl Ether	ND	3.1	ND	0.86	
108-05-4	Vinyl Acetate	ND	160	ND	44	
78-93-3	2-Butanone (MEK)	ND	160	ND	53	

ND = Compound was analyzed for, but not detected above the laboratory reporting limit.

MRL = Method Reporting Limit - The minimum quantity of a target analyte that can be confidently determined by the referenced method.

D = The reported result is from a dilution.

RESULTS OF ANALYSIS

Page 2 of 3

**Client:** GSI Environmental Inc.

**Client Sample ID:** Indoor-1-PP

**Client Project ID:** ESTCP CSIA / OSA Demonstration / 3585/3669

CAS Project ID: P1203938

CAS Sample ID: P1203938-007

Test Code: EPA TO-15

Date Collected: 9/19/12

Instrument ID: Tekmar AUTOCAN/Agilent 5975Cinert/6890N/MS16

Date Received: 9/26/12

Analyst: Lusine Hakobyan

Date Analyzed: 9/28/12 & 10/1/12

Sampling Media: 6.0 L Summa Canister

Volume(s) Analyzed: 0.040 Liter(s)

Test Notes:

0.020 Liter(s)

Container ID: AC00376

Initial Pressure (psig): -0.05 Final Pressure (psig): 3.51

Canister Dilution Factor: 1.24

CAS #	Compound	Result µg/m <sup>3</sup>	MRL µg/m <sup>3</sup>	Result ppbV	MRL ppbV	Data Qualifier
156-59-2	cis-1,2-Dichloroethene	ND	3.1	ND	0.78	
141-78-6	Ethyl Acetate	ND	31	ND	8.6	
110-54-3	n-Hexane	ND	16	ND	4.4	
67-66-3	Chloroform	ND	3.1	ND	0.64	
109-99-9	Tetrahydrofuran (THF)	ND	16	ND	5.3	
107-06-2	1,2-Dichloroethane	ND	3.1	ND	0.77	
71-55-6	1,1,1-Trichloroethane	ND	3.1	ND	0.57	
71-43-2	Benzene	7.1	3.1	2.2	0.97	
56-23-5	Carbon Tetrachloride	ND	3.1	ND	0.49	
110-82-7	Cyclohexane	36	31	10	9.0	
78-87-5	1,2-Dichloropropane	ND	3.1	ND	0.67	
75-27-4	Bromodichloromethane	ND	3.1	ND	0.46	
79-01-6	Trichloroethene	70	3.1	13	0.58	
123-91-1	1,4-Dioxane	ND	16	ND	4.3	
80-62-6	Methyl Methacrylate	ND	31	ND	7.6	
142-82-5	n-Heptane	2,300	16	570	3.8	
10061-01-5	cis-1,3-Dichloropropene	ND	16	ND	3.4	
108-10-1	4-Methyl-2-pentanone	ND	16	ND	3.8	
10061-02-6	trans-1,3-Dichloropropene	ND	16	ND	3.4	
79-00-5	1,1,2-Trichloroethane	ND	3.1	ND	0.57	
108-88-3	Toluene	27	16	7.3	4.1	
591-78-6	2-Hexanone	ND	16	ND	3.8	
124-48-1	Dibromochloromethane	ND	3.1	ND	0.36	
106-93-4	1,2-Dibromoethane	ND	3.1	ND	0.40	
123-86-4	n-Butyl Acetate	ND	16	ND	3.3	

ND = Compound was analyzed for, but not detected above the laboratory reporting limit.

MRL = Method Reporting Limit - The minimum quantity of a target analyte that can be confidently determined by the referenced method.

## RESULTS OF ANALYSIS

Page 3 of 3

**Client:** GSI Environmental Inc.  
**Client Sample ID:** Indoor-1-PP  
**Client Project ID:** ESTCP CSIA / OSA Demonstration / 3585/3669

CAS Project ID: P1203938  
 CAS Sample ID: P1203938-007

**Test Code:** EPA TO-15  
**Instrument ID:** Tekmar AUTOCAN/Agilent 5975Cinert/6890N/MS16  
**Analyst:** Lusine Hakobyan  
**Sampling Media:** 6.0 L Summa Canister  
**Test Notes:**  
**Container ID:** AC00376

**Date Collected:** 9/19/12  
**Date Received:** 9/26/12  
**Date Analyzed:** 9/28/12 & 10/1/12  
**Volume(s) Analyzed:** 0.040 Liter(s)  
 0.020 Liter(s)

Initial Pressure (psig): -0.05      Final Pressure (psig): 3.51

Canister Dilution Factor: 1.24

CAS #	Compound	Result µg/m <sup>3</sup>	MRL µg/m <sup>3</sup>	Result ppbV	MRL ppbV	Data Qualifier
111-65-9	n-Octane	ND	16	ND	3.3	
127-18-4	Tetrachloroethene	ND	3.1	ND	0.46	
108-90-7	Chlorobenzene	ND	3.1	ND	0.67	
100-41-4	Ethylbenzene	ND	16	ND	3.6	
179601-23-1	m,p-Xylenes	<b>31</b>	16	<b>7.1</b>	3.6	
75-25-2	Bromoform	ND	16	ND	1.5	
100-42-5	Styrene	ND	16	ND	3.6	
95-47-6	o-Xylene	ND	16	ND	3.6	
111-84-2	n-Nonane	ND	16	ND	3.0	
79-34-5	1,1,2,2-Tetrachloroethane	ND	3.1	ND	0.45	
98-82-8	Cumene	ND	16	ND	3.2	
80-56-8	alpha-Pinene	ND	16	ND	2.8	
103-65-1	n-Propylbenzene	ND	16	ND	3.2	
622-96-8	4-Ethyltoluene	ND	16	ND	3.2	
108-67-8	1,3,5-Trimethylbenzene	ND	16	ND	3.2	
95-63-6	1,2,4-Trimethylbenzene	<b>18</b>	16	<b>3.7</b>	3.2	
100-44-7	Benzyl Chloride	ND	16	ND	3.0	
541-73-1	1,3-Dichlorobenzene	ND	3.1	ND	0.52	
106-46-7	1,4-Dichlorobenzene	ND	3.1	ND	0.52	
95-50-1	1,2-Dichlorobenzene	ND	3.1	ND	0.52	
5989-27-5	d-Limonene	<b>26</b>	16	<b>4.7</b>	2.8	
96-12-8	1,2-Dibromo-3-chloropropane	ND	16	ND	1.6	
120-82-1	1,2,4-Trichlorobenzene	ND	16	ND	2.1	
91-20-3	Naphthalene	ND	16	ND	3.0	
87-68-3	Hexachlorobutadiene	ND	16	ND	1.5	

ND = Compound was analyzed for, but not detected above the laboratory reporting limit.

MRL = Method Reporting Limit - The minimum quantity of a target analyte that can be confidently determined by the referenced method.

RESULTS OF ANALYSIS

Page 1 of 3

**Client:** GSI Environmental Inc.

**Client Sample ID:** Indoor-1-NP

**Client Project ID:** ESTCP CSIA / OSA Demonstration / 3585/3669

CAS Project ID: P1203938

CAS Sample ID: P1203938-008

Test Code: EPA TO-15

Date Collected: 9/19/12

Instrument ID: Tekmar AUTOCAN/Agilent 5975Cinert/6890N/MS16

Date Received: 9/25/12

Analyst: Lusine Hakobyan

Date Analyzed: 9/28/12

Sampling Media: 6.0 L Summa Canister

Volume(s) Analyzed: 0.10 Liter(s)

Test Notes:

0.020 Liter(s)

Container ID: AC01877

Initial Pressure (psig): -0.02 Final Pressure (psig): 4.36

Canister Dilution Factor: 1.30

CAS #	Compound	Result	MRL	Result	MRL	Data Qualifier
		µg/m <sup>3</sup>	µg/m <sup>3</sup>	ppbV	ppbV	
115-07-1	Propene	39	6.5	23	3.8	
75-71-8	Dichlorodifluoromethane (CFC 12)	ND	6.5	ND	1.3	
74-87-3	Chloromethane	ND	2.6	ND	1.3	
76-14-2	1,2-Dichloro-1,1,2,2-tetrafluoroethane (CFC 114)	ND	6.5	ND	0.93	
75-01-4	Vinyl Chloride	ND	1.3	ND	0.51	
106-99-0	1,3-Butadiene	14	2.6	6.5	1.2	
74-83-9	Bromomethane	ND	1.3	ND	0.33	
75-00-3	Chloroethane	ND	1.3	ND	0.49	
64-17-5	Ethanol	80	65	42	35	
75-05-8	Acetonitrile	ND	6.5	ND	3.9	
107-02-8	Acrolein	ND	26	ND	11	
67-64-1	Acetone	9,400	330	4,000	140	D
75-69-4	Trichlorofluoromethane	1.8	1.3	0.32	0.23	
67-63-0	2-Propanol (Isopropyl Alcohol)	ND	65	ND	26	
107-13-1	Acrylonitrile	ND	6.5	ND	3.0	
75-35-4	1,1-Dichloroethene	ND	1.3	ND	0.33	
75-09-2	Methylene Chloride	ND	6.5	ND	1.9	
107-05-1	3-Chloro-1-propene (Allyl Chloride)	ND	1.3	ND	0.42	
76-13-1	Trichlorotrifluoroethane	ND	1.3	ND	0.17	
75-15-0	Carbon Disulfide	ND	65	ND	21	
156-60-5	trans-1,2-Dichloroethene	ND	1.3	ND	0.33	
75-34-3	1,1-Dichloroethane	ND	1.3	ND	0.32	
1634-04-4	Methyl tert-Butyl Ether	ND	1.3	ND	0.36	
108-05-4	Vinyl Acetate	ND	65	ND	18	
78-93-3	2-Butanone (MEK)	ND	65	ND	22	

ND = Compound was analyzed for, but not detected above the laboratory reporting limit.

MRL = Method Reporting Limit - The minimum quantity of a target analyte that can be confidently determined by the referenced method.

D = The reported result is from a dilution.

RESULTS OF ANALYSIS

Page 2 of 3

**Client:** GSI Environmental Inc.

**Client Sample ID:** Indoor-1-NP

**Client Project ID:** ESTCP CSIA / OSA Demonstration / 3585/3669

CAS Project ID: P1203938

CAS Sample ID: P1203938-008

Test Code: EPA TO-15

Date Collected: 9/19/12

Instrument ID: Tekmar AUTOCAN/Agilent 5975Cinert/6890N/MS16

Date Received: 9/25/12

Analyst: Lusine Hakobyan

Date Analyzed: 9/28/12

Sampling Media: 6.0 L Summa Canister

Volume(s) Analyzed: 0.10 Liter(s)

Test Notes:

0.020 Liter(s)

Container ID: AC01877

Initial Pressure (psig): -0.02 Final Pressure (psig): 4.36

Canister Dilution Factor: 1.30

CAS #	Compound	Result µg/m <sup>3</sup>	MRL µg/m <sup>3</sup>	Result ppbV	MRL ppbV	Data Qualifier
156-59-2	cis-1,2-Dichloroethene	ND	1.3	ND	0.33	
141-78-6	Ethyl Acetate	27	13	7.4	3.6	
110-54-3	n-Hexane	120	6.5	34	1.8	
67-66-3	Chloroform	ND	1.3	ND	0.27	
109-99-9	Tetrahydrofuran (THF)	ND	6.5	ND	2.2	
107-06-2	1,2-Dichloroethane	ND	1.3	ND	0.32	
71-55-6	1,1,1-Trichloroethane	ND	1.3	ND	0.24	
71-43-2	Benzene	69	1.3	22	0.41	
56-23-5	Carbon Tetrachloride	ND	1.3	ND	0.21	
110-82-7	Cyclohexane	33	13	9.7	3.8	
78-87-5	1,2-Dichloropropane	ND	1.3	ND	0.28	
75-27-4	Bromodichloromethane	ND	1.3	ND	0.19	
79-01-6	Trichloroethene	15	1.3	2.8	0.24	
123-91-1	1,4-Dioxane	ND	6.5	ND	1.8	
80-62-6	Methyl Methacrylate	ND	13	ND	3.2	
142-82-5	n-Heptane	1,100	6.5	260	1.6	
10061-01-5	cis-1,3-Dichloropropene	ND	6.5	ND	1.4	
108-10-1	4-Methyl-2-pentanone	9.5	6.5	2.3	1.6	
10061-02-6	trans-1,3-Dichloropropene	ND	6.5	ND	1.4	
79-00-5	1,1,2-Trichloroethane	ND	1.3	ND	0.24	
108-88-3	Toluene	170	6.5	44	1.7	
591-78-6	2-Hexanone	ND	6.5	ND	1.6	
124-48-1	Dibromochloromethane	ND	1.3	ND	0.15	
106-93-4	1,2-Dibromoethane	ND	1.3	ND	0.17	
123-86-4	n-Butyl Acetate	ND	6.5	ND	1.4	

ND = Compound was analyzed for, but not detected above the laboratory reporting limit.

MRL = Method Reporting Limit - The minimum quantity of a target analyte that can be confidently determined by the referenced method.

RESULTS OF ANALYSIS

Page 3 of 3

**Client:** GSI Environmental Inc.  
**Client Sample ID:** Indoor-1-NP  
**Client Project ID:** ESTCP CSIA / OSA Demonstration / 3585/3669

CAS Project ID: P1203938  
 CAS Sample ID: P1203938-008

Test Code: EPA TO-15  
 Instrument ID: Tekmar AUTOCAN/Agilent 5975Cinert/6890N/MS16  
 Analyst: Lusine Hakobyan  
 Sampling Media: 6.0 L Summa Canister  
 Test Notes:  
 Container ID: AC01877

Date Collected: 9/19/12  
 Date Received: 9/25/12  
 Date Analyzed: 9/28/12  
 Volume(s) Analyzed: 0.10 Liter(s)  
 0.020 Liter(s)

Initial Pressure (psig): -0.02 Final Pressure (psig): 4.36

Canister Dilution Factor: 1.30

CAS #	Compound	Result µg/m <sup>3</sup>	MRL µg/m <sup>3</sup>	Result ppbV	MRL ppbV	Data Qualifier
111-65-9	n-Octane	15	6.5	3.2	1.4	
127-18-4	Tetrachloroethene	1.8	1.3	0.27	0.19	
108-90-7	Chlorobenzene	ND	1.3	ND	0.28	
100-41-4	Ethylbenzene	50	6.5	11	1.5	
179601-23-1	m,p-Xylenes	180	6.5	41	1.5	
75-25-2	Bromoform	ND	6.5	ND	0.63	
100-42-5	Styrene	21	6.5	4.9	1.5	
95-47-6	o-Xylene	70	6.5	16	1.5	
111-84-2	n-Nonane	14	6.5	2.7	1.2	
79-34-5	1,1,2,2-Tetrachloroethane	ND	1.3	ND	0.19	
98-82-8	Cumene	ND	6.5	ND	1.3	
80-56-8	alpha-Pinene	ND	6.5	ND	1.2	
103-65-1	n-Propylbenzene	12	6.5	2.4	1.3	
622-96-8	4-Ethyltoluene	29	6.5	5.8	1.3	
108-67-8	1,3,5-Trimethylbenzene	34	6.5	7.0	1.3	
95-63-6	1,2,4-Trimethylbenzene	110	6.5	23	1.3	
100-44-7	Benzyl Chloride	ND	6.5	ND	1.3	
541-73-1	1,3-Dichlorobenzene	ND	1.3	ND	0.22	
106-46-7	1,4-Dichlorobenzene	ND	1.3	ND	0.22	
95-50-1	1,2-Dichlorobenzene	ND	1.3	ND	0.22	
5989-27-5	d-Limonene	100	6.5	18	1.2	
96-12-8	1,2-Dibromo-3-chloropropane	ND	6.5	ND	0.67	
120-82-1	1,2,4-Trichlorobenzene	ND	6.5	ND	0.88	
91-20-3	Naphthalene	47	6.5	9.1	1.2	
87-68-3	Hexachlorobutadiene	ND	6.5	ND	0.61	

ND = Compound was analyzed for, but not detected above the laboratory reporting limit.

MRL = Method Reporting Limit - The minimum quantity of a target analyte that can be confidently determined by the referenced method.



## RESULTS OF ANALYSIS

Page 1 of 3

**Client:** GSI Environmental Inc.

**Client Sample ID:** Dup 1

**Client Project ID:** ESTCP CSIA / OSA Demonstration / 3585/3669

CAS Project ID: P1203938

CAS Sample ID: P1203938-009

Test Code: EPA TO-15

Date Collected: 9/19/12

Instrument ID: Tekmar AUTOCAN/Agilent 5975Cinert/6890N/MS16

Date Received: 9/26/12

Analyst: Lusine Hakobyan

Date Analyzed: 9/28/12 &amp; 10/1/12

Sampling Media: 6.0 L Summa Canister

Volume(s) Analyzed: 0.040 Liter(s)

Test Notes:

0.020 Liter(s)

Container ID: AC00745

Initial Pressure (psig): -0.03      Final Pressure (psig): 3.59

Canister Dilution Factor: 1.25

CAS #	Compound	Result	MRL	Result	MRL	Data Qualifier
		µg/m <sup>3</sup>	µg/m <sup>3</sup>	ppbV	ppbV	
115-07-1	Propene	ND	16	ND	9.1	
75-71-8	Dichlorodifluoromethane (CFC 12)	ND	16	ND	3.2	
74-87-3	Chloromethane	ND	6.3	ND	3.0	
76-14-2	1,2-Dichloro-1,1,2,2-tetrafluoroethane (CFC 114)	ND	16	ND	2.2	
75-01-4	Vinyl Chloride	ND	3.1	ND	1.2	
106-99-0	1,3-Butadiene	ND	6.3	ND	2.8	
74-83-9	Bromomethane	ND	3.1	ND	0.81	
75-00-3	Chloroethane	ND	3.1	ND	1.2	
64-17-5	Ethanol	ND	160	ND	83	
75-05-8	Acetonitrile	ND	16	ND	9.3	
107-02-8	Acrolein	ND	63	ND	27	
67-64-1	Acetone	<b>23,000</b>	310	<b>9,800</b>	130	<b>D</b>
75-69-4	Trichlorofluoromethane	ND	3.1	ND	0.56	
67-63-0	2-Propanol (Isopropyl Alcohol)	ND	160	ND	64	
107-13-1	Acrylonitrile	ND	16	ND	7.2	
75-35-4	1,1-Dichloroethene	ND	3.1	ND	0.79	
75-09-2	Methylene Chloride	<b>16</b>	16	<b>4.7</b>	4.5	
107-05-1	3-Chloro-1-propene (Allyl Chloride)	ND	3.1	ND	1.0	
76-13-1	Trichlorotrifluoroethane	ND	3.1	ND	0.41	
75-15-0	Carbon Disulfide	ND	160	ND	50	
156-60-5	trans-1,2-Dichloroethene	ND	3.1	ND	0.79	
75-34-3	1,1-Dichloroethane	ND	3.1	ND	0.77	
1634-04-4	Methyl tert-Butyl Ether	ND	3.1	ND	0.87	
108-05-4	Vinyl Acetate	ND	160	ND	44	
78-93-3	2-Butanone (MEK)	ND	160	ND	53	

ND = Compound was analyzed for, but not detected above the laboratory reporting limit.

MRL = Method Reporting Limit - The minimum quantity of a target analyte that can be confidently determined by the referenced method.

D = The reported result is from a dilution.

## RESULTS OF ANALYSIS

Page 2 of 3

**Client:** GSI Environmental Inc.

**Client Sample ID:** Dup 1

**Client Project ID:** ESTCP CSIA / OSA Demonstration / 3585/3669

CAS Project ID: P1203938

CAS Sample ID: P1203938-009

Test Code: EPA TO-15

Date Collected: 9/19/12

Instrument ID: Tekmar AUTOCAN/Agilent 5975Cinert/6890N/MS16

Date Received: 9/26/12

Analyst: Lusine Hakobyan

Date Analyzed: 9/28/12 &amp; 10/1/12

Sampling Media: 6.0 L Summa Canister

Volume(s) Analyzed: 0.040 Liter(s)

Test Notes:

0.020 Liter(s)

Container ID: AC00745

Initial Pressure (psig): -0.03      Final Pressure (psig): 3.59

Canister Dilution Factor: 1.25

CAS #	Compound	Result µg/m <sup>3</sup>	MRL µg/m <sup>3</sup>	Result ppbV	MRL ppbV	Data Qualifier
156-59-2	cis-1,2-Dichloroethene	ND	3.1	ND	0.79	
141-78-6	Ethyl Acetate	ND	31	ND	8.7	
110-54-3	n-Hexane	ND	16	ND	4.4	
67-66-3	Chloroform	ND	3.1	ND	0.64	
109-99-9	Tetrahydrofuran (THF)	ND	16	ND	5.3	
107-06-2	1,2-Dichloroethane	ND	3.1	ND	0.77	
71-55-6	1,1,1-Trichloroethane	ND	3.1	ND	0.57	
71-43-2	Benzene	<b>6.9</b>	3.1	<b>2.2</b>	0.98	
56-23-5	Carbon Tetrachloride	ND	3.1	ND	0.50	
110-82-7	Cyclohexane	<b>36</b>	31	<b>10</b>	9.1	
78-87-5	1,2-Dichloropropane	ND	3.1	ND	0.68	
75-27-4	Bromodichloromethane	ND	3.1	ND	0.47	
79-01-6	Trichloroethene	<b>73</b>	3.1	<b>14</b>	0.58	
123-91-1	1,4-Dioxane	ND	16	ND	4.3	
80-62-6	Methyl Methacrylate	ND	31	ND	7.6	
142-82-5	n-Heptane	<b>2,600</b>	16	<b>640</b>	3.8	
10061-01-5	cis-1,3-Dichloropropene	ND	16	ND	3.4	
108-10-1	4-Methyl-2-pentanone	ND	16	ND	3.8	
10061-02-6	trans-1,3-Dichloropropene	ND	16	ND	3.4	
79-00-5	1,1,2-Trichloroethane	ND	3.1	ND	0.57	
108-88-3	Toluene	<b>26</b>	16	<b>6.8</b>	4.1	
591-78-6	2-Hexanone	ND	16	ND	3.8	
124-48-1	Dibromochloromethane	ND	3.1	ND	0.37	
106-93-4	1,2-Dibromoethane	ND	3.1	ND	0.41	
123-86-4	n-Butyl Acetate	ND	16	ND	3.3	

ND = Compound was analyzed for, but not detected above the laboratory reporting limit.

MRL = Method Reporting Limit - The minimum quantity of a target analyte that can be confidently determined by the referenced method.

## RESULTS OF ANALYSIS

Page 3 of 3

**Client:** GSI Environmental Inc.  
**Client Sample ID:** Dup 1  
**Client Project ID:** ESTCP CSIA / OSA Demonstration / 3585/3669

CAS Project ID: P1203938  
 CAS Sample ID: P1203938-009

**Test Code:** EPA TO-15  
**Instrument ID:** Tekmar AUTOCAN/Agilent 5975Cinert/6890N/MS16  
**Analyst:** Lusine Hakobyan  
**Sampling Media:** 6.0 L Summa Canister  
**Test Notes:**  
**Container ID:** AC00745

**Date Collected:** 9/19/12  
**Date Received:** 9/26/12  
**Date Analyzed:** 9/28/12 & 10/1/12  
**Volume(s) Analyzed:** 0.040 Liter(s)  
 0.020 Liter(s)

Initial Pressure (psig): -0.03      Final Pressure (psig): 3.59

Canister Dilution Factor: 1.25

CAS #	Compound	Result µg/m <sup>3</sup>	MRL µg/m <sup>3</sup>	Result ppbV	MRL ppbV	Data Qualifier
111-65-9	n-Octane	ND	16	ND	3.3	
127-18-4	Tetrachloroethene	ND	3.1	ND	0.46	
108-90-7	Chlorobenzene	ND	3.1	ND	0.68	
100-41-4	Ethylbenzene	ND	16	ND	3.6	
179601-23-1	m,p-Xylenes	<b>29</b>	16	<b>6.8</b>	3.6	
75-25-2	Bromoform	ND	16	ND	1.5	
100-42-5	Styrene	ND	16	ND	3.7	
95-47-6	o-Xylene	ND	16	ND	3.6	
111-84-2	n-Nonane	ND	16	ND	3.0	
79-34-5	1,1,2,2-Tetrachloroethane	ND	3.1	ND	0.46	
98-82-8	Cumene	ND	16	ND	3.2	
80-56-8	alpha-Pinene	ND	16	ND	2.8	
103-65-1	n-Propylbenzene	ND	16	ND	3.2	
622-96-8	4-Ethyltoluene	ND	16	ND	3.2	
108-67-8	1,3,5-Trimethylbenzene	ND	16	ND	3.2	
95-63-6	1,2,4-Trimethylbenzene	<b>18</b>	16	<b>3.6</b>	3.2	
100-44-7	Benzyl Chloride	ND	16	ND	3.0	
541-73-1	1,3-Dichlorobenzene	ND	3.1	ND	0.52	
106-46-7	1,4-Dichlorobenzene	ND	3.1	ND	0.52	
95-50-1	1,2-Dichlorobenzene	ND	3.1	ND	0.52	
5989-27-5	d-Limonene	<b>33</b>	16	<b>5.8</b>	2.8	
96-12-8	1,2-Dibromo-3-chloropropane	ND	16	ND	1.6	
120-82-1	1,2,4-Trichlorobenzene	ND	16	ND	2.1	
91-20-3	Naphthalene	ND	16	ND	3.0	
87-68-3	Hexachlorobutadiene	ND	16	ND	1.5	

ND = Compound was analyzed for, but not detected above the laboratory reporting limit.

MRL = Method Reporting Limit - The minimum quantity of a target analyte that can be confidently determined by the referenced method.

RESULTS OF ANALYSIS

Page 1 of 3

**Client:** GSI Environmental Inc.  
**Client Sample ID:** Method Blank  
**Client Project ID:** ESTCP CSIA / OSA Demonstration / 3585/3669

CAS Project ID: P1203938  
 CAS Sample ID: P120928-MB

Test Code: EPA TO-15  
 Instrument ID: Tekmar AUTOCAN/Agilent 5975Cinert/6890N/MS16  
 Analyst: Lusine Hakobyan  
 Sampling Media: 6.0 L Summa Canister  
 Test Notes:

Date Collected: NA  
 Date Received: NA  
 Date Analyzed: 9/28/12  
 Volume(s) Analyzed: 1.00 Liter(s)

Canister Dilution Factor: 1.00

CAS #	Compound	Result	MRL	Result	MRL	Data Qualifier
		µg/m <sup>3</sup>	µg/m <sup>3</sup>	ppbV	ppbV	
115-07-1	Propene	ND	0.50	ND	0.29	
75-71-8	Dichlorodifluoromethane (CFC 12)	ND	0.50	ND	0.10	
74-87-3	Chloromethane	ND	0.20	ND	0.097	
76-14-2	1,2-Dichloro-1,1,2,2-tetrafluoroethane (CFC 114)	ND	0.50	ND	0.072	
75-01-4	Vinyl Chloride	ND	0.10	ND	0.039	
106-99-0	1,3-Butadiene	ND	0.20	ND	0.090	
74-83-9	Bromomethane	ND	0.10	ND	0.026	
75-00-3	Chloroethane	ND	0.10	ND	0.038	
64-17-5	Ethanol	ND	5.0	ND	2.7	
75-05-8	Acetonitrile	ND	0.50	ND	0.30	
107-02-8	Acrolein	ND	2.0	ND	0.87	
67-64-1	Acetone	ND	5.0	ND	2.1	
75-69-4	Trichlorofluoromethane	ND	0.10	ND	0.018	
67-63-0	2-Propanol (Isopropyl Alcohol)	ND	5.0	ND	2.0	
107-13-1	Acrylonitrile	ND	0.50	ND	0.23	
75-35-4	1,1-Dichloroethene	ND	0.10	ND	0.025	
75-09-2	Methylene Chloride	ND	0.50	ND	0.14	
107-05-1	3-Chloro-1-propene (Allyl Chloride)	ND	0.10	ND	0.032	
76-13-1	Trichlorotrifluoroethane	ND	0.10	ND	0.013	
75-15-0	Carbon Disulfide	ND	5.0	ND	1.6	
156-60-5	trans-1,2-Dichloroethene	ND	0.10	ND	0.025	
75-34-3	1,1-Dichloroethane	ND	0.10	ND	0.025	
1634-04-4	Methyl tert-Butyl Ether	ND	0.10	ND	0.028	
108-05-4	Vinyl Acetate	ND	5.0	ND	1.4	
78-93-3	2-Butanone (MEK)	ND	5.0	ND	1.7	

ND = Compound was analyzed for, but not detected above the laboratory reporting limit.

MRL = Method Reporting Limit - The minimum quantity of a target analyte that can be confidently determined by the referenced method.

RESULTS OF ANALYSIS

Page 2 of 3

**Client:** GSI Environmental Inc.  
**Client Sample ID:** Method Blank  
**Client Project ID:** ESTCP CSIA / OSA Demonstration / 3585/3669

CAS Project ID: P1203938  
 CAS Sample ID: P120928-MB

Test Code: EPA TO-15  
 Instrument ID: Tekmar AUTOCAN/Agilent 5975Cinert/6890N/MS16  
 Analyst: Lusine Hakobyan  
 Sampling Media: 6.0 L Summa Canister  
 Test Notes:

Date Collected: NA  
 Date Received: NA  
 Date Analyzed: 9/28/12  
 Volume(s) Analyzed: 1.00 Liter(s)

Canister Dilution Factor: 1.00

CAS #	Compound	Result µg/m <sup>3</sup>	MRL µg/m <sup>3</sup>	Result ppbV	MRL ppbV	Data Qualifier
156-59-2	cis-1,2-Dichloroethene	ND	0.10	ND	0.025	
141-78-6	Ethyl Acetate	ND	1.0	ND	0.28	
110-54-3	n-Hexane	ND	0.50	ND	0.14	
67-66-3	Chloroform	ND	0.10	ND	0.020	
109-99-9	Tetrahydrofuran (THF)	ND	0.50	ND	0.17	
107-06-2	1,2-Dichloroethane	ND	0.10	ND	0.025	
71-55-6	1,1,1-Trichloroethane	ND	0.10	ND	0.018	
71-43-2	Benzene	ND	0.10	ND	0.031	
56-23-5	Carbon Tetrachloride	ND	0.10	ND	0.016	
110-82-7	Cyclohexane	ND	1.0	ND	0.29	
78-87-5	1,2-Dichloropropane	ND	0.10	ND	0.022	
75-27-4	Bromodichloromethane	ND	0.10	ND	0.015	
79-01-6	Trichloroethene	ND	0.10	ND	0.019	
123-91-1	1,4-Dioxane	ND	0.50	ND	0.14	
80-62-6	Methyl Methacrylate	ND	1.0	ND	0.24	
142-82-5	n-Heptane	ND	0.50	ND	0.12	
10061-01-5	cis-1,3-Dichloropropene	ND	0.50	ND	0.11	
108-10-1	4-Methyl-2-pentanone	ND	0.50	ND	0.12	
10061-02-6	trans-1,3-Dichloropropene	ND	0.50	ND	0.11	
79-00-5	1,1,2-Trichloroethane	ND	0.10	ND	0.018	
108-88-3	Toluene	ND	0.50	ND	0.13	
591-78-6	2-Hexanone	ND	0.50	ND	0.12	
124-48-1	Dibromochloromethane	ND	0.10	ND	0.012	
106-93-4	1,2-Dibromoethane	ND	0.10	ND	0.013	
123-86-4	n-Butyl Acetate	ND	0.50	ND	0.11	

ND = Compound was analyzed for, but not detected above the laboratory reporting limit.

MRL = Method Reporting Limit - The minimum quantity of a target analyte that can be confidently determined by the referenced method.

RESULTS OF ANALYSIS

Page 3 of 3

**Client:** GSI Environmental Inc.  
**Client Sample ID:** Method Blank  
**Client Project ID:** ESTCP CSIA / OSA Demonstration / 3585/3669

CAS Project ID: P1203938  
 CAS Sample ID: P120928-MB

Test Code: EPA TO-15  
 Instrument ID: Tekmar AUTOCAN/Agilent 5975Cinert/6890N/MS16  
 Analyst: Lusine Hakobyan  
 Sampling Media: 6.0 L Summa Canister  
 Test Notes:

Date Collected: NA  
 Date Received: NA  
 Date Analyzed: 9/28/12  
 Volume(s) Analyzed: 1.00 Liter(s)

Canister Dilution Factor: 1.00

CAS #	Compound	Result µg/m <sup>3</sup>	MRL µg/m <sup>3</sup>	Result ppbV	MRL ppbV	Data Qualifier
111-65-9	n-Octane	ND	0.50	ND	0.11	
127-18-4	Tetrachloroethene	ND	0.10	ND	0.015	
108-90-7	Chlorobenzene	ND	0.10	ND	0.022	
100-41-4	Ethylbenzene	ND	0.50	ND	0.12	
179601-23-1	m,p-Xylenes	ND	0.50	ND	0.12	
75-25-2	Bromoform	ND	0.50	ND	0.048	
100-42-5	Styrene	ND	0.50	ND	0.12	
95-47-6	o-Xylene	ND	0.50	ND	0.12	
111-84-2	n-Nonane	ND	0.50	ND	0.095	
79-34-5	1,1,2,2-Tetrachloroethane	ND	0.10	ND	0.015	
98-82-8	Cumene	ND	0.50	ND	0.10	
80-56-8	alpha-Pinene	ND	0.50	ND	0.090	
103-65-1	n-Propylbenzene	ND	0.50	ND	0.10	
622-96-8	4-Ethyltoluene	ND	0.50	ND	0.10	
108-67-8	1,3,5-Trimethylbenzene	ND	0.50	ND	0.10	
95-63-6	1,2,4-Trimethylbenzene	ND	0.50	ND	0.10	
100-44-7	Benzyl Chloride	ND	0.50	ND	0.097	
541-73-1	1,3-Dichlorobenzene	ND	0.10	ND	0.017	
106-46-7	1,4-Dichlorobenzene	ND	0.10	ND	0.017	
95-50-1	1,2-Dichlorobenzene	ND	0.10	ND	0.017	
5989-27-5	d-Limonene	ND	0.50	ND	0.090	
96-12-8	1,2-Dibromo-3-chloropropane	ND	0.50	ND	0.052	
120-82-1	1,2,4-Trichlorobenzene	ND	0.50	ND	0.067	
91-20-3	Naphthalene	ND	0.50	ND	0.095	
87-68-3	Hexachlorobutadiene	ND	0.50	ND	0.047	

ND = Compound was analyzed for, but not detected above the laboratory reporting limit.

MRL = Method Reporting Limit - The minimum quantity of a target analyte that can be confidently determined by the referenced method.

## RESULTS OF ANALYSIS

Page 1 of 3

**Client:** GSI Environmental Inc.  
**Client Sample ID:** Method Blank  
**Client Project ID:** ESTCP CSIA / OSA Demonstration / 3585/3669

**CAS Project ID:** P1203938  
**CAS Sample ID:** P121001-MB

**Test Code:** EPA TO-15  
**Instrument ID:** Tekmar AUTOCAN/Agilent 5975Cinert/6890N/MS16  
**Analyst:** Lusine Hakobyan  
**Sampling Media:** 6.0 L Summa Canister  
**Test Notes:**

**Date Collected:** NA  
**Date Received:** NA  
**Date Analyzed:** 10/1/12  
**Volume(s) Analyzed:** 1.00 Liter(s)

Canister Dilution Factor: 1.00

CAS #	Compound	Result	MRL	Result	MRL	Data Qualifier
		µg/m <sup>3</sup>	µg/m <sup>3</sup>	ppbV	ppbV	
115-07-1	Propene	ND	0.50	ND	0.29	
75-71-8	Dichlorodifluoromethane (CFC 12)	ND	0.50	ND	0.10	
74-87-3	Chloromethane	ND	0.20	ND	0.097	
76-14-2	1,2-Dichloro-1,1,2,2-tetrafluoroethane (CFC 114)	ND	0.50	ND	0.072	
75-01-4	Vinyl Chloride	ND	0.10	ND	0.039	
106-99-0	1,3-Butadiene	ND	0.20	ND	0.090	
74-83-9	Bromomethane	ND	0.10	ND	0.026	
75-00-3	Chloroethane	ND	0.10	ND	0.038	
64-17-5	Ethanol	ND	5.0	ND	2.7	
75-05-8	Acetonitrile	ND	0.50	ND	0.30	
107-02-8	Acrolein	ND	2.0	ND	0.87	
67-64-1	Acetone	ND	5.0	ND	2.1	
75-69-4	Trichlorofluoromethane	ND	0.10	ND	0.018	
67-63-0	2-Propanol (Isopropyl Alcohol)	ND	5.0	ND	2.0	
107-13-1	Acrylonitrile	ND	0.50	ND	0.23	
75-35-4	1,1-Dichloroethene	ND	0.10	ND	0.025	
75-09-2	Methylene Chloride	ND	0.50	ND	0.14	
107-05-1	3-Chloro-1-propene (Allyl Chloride)	ND	0.10	ND	0.032	
76-13-1	Trichlorotrifluoroethane	ND	0.10	ND	0.013	
75-15-0	Carbon Disulfide	ND	5.0	ND	1.6	
156-60-5	trans-1,2-Dichloroethene	ND	0.10	ND	0.025	
75-34-3	1,1-Dichloroethane	ND	0.10	ND	0.025	
1634-04-4	Methyl tert-Butyl Ether	ND	0.10	ND	0.028	
108-05-4	Vinyl Acetate	ND	5.0	ND	1.4	
78-93-3	2-Butanone (MEK)	ND	5.0	ND	1.7	

ND = Compound was analyzed for, but not detected above the laboratory reporting limit.

MRL = Method Reporting Limit - The minimum quantity of a target analyte that can be confidently determined by the referenced method.

RESULTS OF ANALYSIS

Page 2 of 3

**Client:** GSI Environmental Inc.  
**Client Sample ID:** Method Blank  
**Client Project ID:** ESTCP CSIA / OSA Demonstration / 3585/3669

CAS Project ID: P1203938  
 CAS Sample ID: P121001-MB

Test Code: EPA TO-15  
 Instrument ID: Tekmar AUTOCAN/Agilent 5975Cinert/6890N/MS16  
 Analyst: Lusine Hakobyan  
 Sampling Media: 6.0 L Summa Canister  
 Test Notes:

Date Collected: NA  
 Date Received: NA  
 Date Analyzed: 10/1/12  
 Volume(s) Analyzed: 1.00 Liter(s)

Canister Dilution Factor: 1.00

CAS #	Compound	Result µg/m <sup>3</sup>	MRL µg/m <sup>3</sup>	Result ppbV	MRL ppbV	Data Qualifier
156-59-2	cis-1,2-Dichloroethene	ND	0.10	ND	0.025	
141-78-6	Ethyl Acetate	ND	1.0	ND	0.28	
110-54-3	n-Hexane	ND	0.50	ND	0.14	
67-66-3	Chloroform	ND	0.10	ND	0.020	
109-99-9	Tetrahydrofuran (THF)	ND	0.50	ND	0.17	
107-06-2	1,2-Dichloroethane	ND	0.10	ND	0.025	
71-55-6	1,1,1-Trichloroethane	ND	0.10	ND	0.018	
71-43-2	Benzene	ND	0.10	ND	0.031	
56-23-5	Carbon Tetrachloride	ND	0.10	ND	0.016	
110-82-7	Cyclohexane	ND	1.0	ND	0.29	
78-87-5	1,2-Dichloropropane	ND	0.10	ND	0.022	
75-27-4	Bromodichloromethane	ND	0.10	ND	0.015	
79-01-6	Trichloroethene	ND	0.10	ND	0.019	
123-91-1	1,4-Dioxane	ND	0.50	ND	0.14	
80-62-6	Methyl Methacrylate	ND	1.0	ND	0.24	
142-82-5	n-Heptane	ND	0.50	ND	0.12	
10061-01-5	cis-1,3-Dichloropropene	ND	0.50	ND	0.11	
108-10-1	4-Methyl-2-pentanone	ND	0.50	ND	0.12	
10061-02-6	trans-1,3-Dichloropropene	ND	0.50	ND	0.11	
79-00-5	1,1,2-Trichloroethane	ND	0.10	ND	0.018	
108-88-3	Toluene	ND	0.50	ND	0.13	
591-78-6	2-Hexanone	ND	0.50	ND	0.12	
124-48-1	Dibromochloromethane	ND	0.10	ND	0.012	
106-93-4	1,2-Dibromoethane	ND	0.10	ND	0.013	
123-86-4	n-Butyl Acetate	ND	0.50	ND	0.11	

ND = Compound was analyzed for, but not detected above the laboratory reporting limit.

MRL = Method Reporting Limit - The minimum quantity of a target analyte that can be confidently determined by the referenced method.



RESULTS OF ANALYSIS

Page 3 of 3

**Client:** GSI Environmental Inc.  
**Client Sample ID:** Method Blank  
**Client Project ID:** ESTCP CSIA / OSA Demonstration / 3585/3669

CAS Project ID: P1203938  
 CAS Sample ID: P121001-MB

Test Code: EPA TO-15  
 Instrument ID: Tekmar AUTOCAN/Agilent 5975Cinert/6890N/MS16  
 Analyst: Lusine Hakobyan  
 Sampling Media: 6.0 L Summa Canister  
 Test Notes:

Date Collected: NA  
 Date Received: NA  
 Date Analyzed: 10/1/12  
 Volume(s) Analyzed: 1.00 Liter(s)

Canister Dilution Factor: 1.00

CAS #	Compound	Result µg/m <sup>3</sup>	MRL µg/m <sup>3</sup>	Result ppbV	MRL ppbV	Data Qualifier
111-65-9	n-Octane	ND	0.50	ND	0.11	
127-18-4	Tetrachloroethene	ND	0.10	ND	0.015	
108-90-7	Chlorobenzene	ND	0.10	ND	0.022	
100-41-4	Ethylbenzene	ND	0.50	ND	0.12	
179601-23-1	m,p-Xylenes	ND	0.50	ND	0.12	
75-25-2	Bromoform	ND	0.50	ND	0.048	
100-42-5	Styrene	ND	0.50	ND	0.12	
95-47-6	o-Xylene	ND	0.50	ND	0.12	
111-84-2	n-Nonane	ND	0.50	ND	0.095	
79-34-5	1,1,2,2-Tetrachloroethane	ND	0.10	ND	0.015	
98-82-8	Cumene	ND	0.50	ND	0.10	
80-56-8	alpha-Pinene	ND	0.50	ND	0.090	
103-65-1	n-Propylbenzene	ND	0.50	ND	0.10	
622-96-8	4-Ethyltoluene	ND	0.50	ND	0.10	
108-67-8	1,3,5-Trimethylbenzene	ND	0.50	ND	0.10	
95-63-6	1,2,4-Trimethylbenzene	ND	0.50	ND	0.10	
100-44-7	Benzyl Chloride	ND	0.50	ND	0.097	
541-73-1	1,3-Dichlorobenzene	ND	0.10	ND	0.017	
106-46-7	1,4-Dichlorobenzene	ND	0.10	ND	0.017	
95-50-1	1,2-Dichlorobenzene	ND	0.10	ND	0.017	
5989-27-5	d-Limonene	ND	0.50	ND	0.090	
96-12-8	1,2-Dibromo-3-chloropropane	ND	0.50	ND	0.052	
120-82-1	1,2,4-Trichlorobenzene	ND	0.50	ND	0.067	
91-20-3	Naphthalene	ND	0.50	ND	0.095	
87-68-3	Hexachlorobutadiene	ND	0.50	ND	0.047	

ND = Compound was analyzed for, but not detected above the laboratory reporting limit.

MRL = Method Reporting Limit - The minimum quantity of a target analyte that can be confidently determined by the referenced method.

SURROGATE SPIKE RECOVERY RESULTS

Page 1 of 1

**Client:** GSI Environmental Inc.  
**Client Project ID:** ESTCP CSIA / OSA Demonstration / 3585/3669

CAS Project ID: P1203938

Test Code: EPA TO-15  
 Instrument ID: Tekmar AUTOCAN/Agilent 5975Cinert/6890N/MS16  
 Analyst: Lusine Hakobyan  
 Sampling Media: 6.0 L Summa Canister(s)  
 Test Notes:

Date(s) Collected: 9/18 - 9/19/12  
 Date(s) Received: 9/25 - 9/26/12  
 Date(s) Analyzed: 9/28 - 10/1/12

Client Sample ID	CAS Sample ID	1,2-Dichloroethane-d4	Toluene-d8	Bromofluorobenzene	Acceptance Limits	Data Qualifier
		Percent Recovered	Percent Recovered	Percent Recovered		
Method Blank	P120928-MB	103	96	102	70-130	
Method Blank	P121001-MB	105	101	104	70-130	
Lab Control Sample	P120928-LCS	109	105	101	70-130	
Lab Control Sample	P121001-LCS	102	90	95	70-130	
Indoor-C1	P1203938-001	102	97	111	70-130	
Outdoor-C1	P1203938-002	107	95	106	70-130	
SS-1C	P1203938-003	97	95	104	70-130	
SS-2C	P1203938-004	98	96	103	70-130	
SS-2C	P1203938-004DUP	106	95	105	70-130	
SS-3C	P1203938-005	105	96	103	70-130	
Indoor-1-BL	P1203938-006	104	98	100	70-130	
Indoor-1-PP	P1203938-007	104	100	102	70-130	
Indoor-1-NP	P1203938-008	111	97	104	70-130	
Dup 1	P1203938-009	99	99	104	70-130	

Surrogate percent recovery is verified and accepted based on the on-column result.

Reported results are shown in concentration units and as a result of the calculation, may vary slightly from the on-column percent recovery.

LABORATORY CONTROL SAMPLE SUMMARY

Page 1 of 3

**Client:** GSI Environmental Inc.

**Client Sample ID:** Lab Control Sample

**Client Project ID:** ESTCP CSIA / OSA Demonstration / 3585/3669

CAS Project ID: P1203938

CAS Sample ID: P120928-LCS

Test Code: EPA TO-15

Date Collected: NA

Instrument ID: Tekmar AUTOCAN/Agilent 5975Cinert/6890N/MS16

Date Received: NA

Analyst: Lusine Hakobyan

Date Analyzed: 9/28/12

Sampling Media: 6.0 L Summa Canister

Volume(s) Analyzed: 0.125 Liter(s)

Test Notes:

CAS #	Compound	Spike Amount µg/m <sup>3</sup>	Result µg/m <sup>3</sup>	% Recovery	CAS	Data Qualifier
					Acceptance Limits	
115-07-1	Propene	204	211	103	59-137	
75-71-8	Dichlorodifluoromethane (CFC 12)	202	197	98	63-115	
74-87-3	Chloromethane	196	191	97	59-124	
76-14-2	1,2-Dichloro-1,1,2,2-tetrafluoroethane (CFC 114)	206	211	102	65-113	
75-01-4	Vinyl Chloride	200	199	100	59-121	
106-99-0	1,3-Butadiene	210	224	107	60-138	
74-83-9	Bromomethane	200	199	100	69-129	
75-00-3	Chloroethane	202	193	96	60-120	
64-17-5	Ethanol	958	874	91	58-121	
75-05-8	Acetonitrile	202	215	106	64-129	
107-02-8	Acrolein	204	192	94	54-127	
67-64-1	Acetone	1,040	1020	98	59-114	
75-69-4	Trichlorofluoromethane	210	192	91	66-108	
67-63-0	2-Propanol (Isopropyl Alcohol)	396	354	89	50-113	
107-13-1	Acrylonitrile	206	254	123	72-135	
75-35-4	1,1-Dichloroethene	218	206	94	70-117	
75-09-2	Methylene Chloride	212	208	98	61-108	
107-05-1	3-Chloro-1-propene (Allyl Chloride)	214	196	92	70-131	
76-13-1	Trichlorotrifluoroethane	212	199	94	70-113	
75-15-0	Carbon Disulfide	208	183	88	65-112	
156-60-5	trans-1,2-Dichloroethene	202	217	107	71-119	
75-34-3	1,1-Dichloroethane	206	198	96	71-116	
1634-04-4	Methyl tert-Butyl Ether	204	203	100	67-116	
108-05-4	Vinyl Acetate	988	1160	117	59-142	
78-93-3	2-Butanone (MEK)	212	229	108	68-125	

Laboratory Control Sample percent recovery is verified and accepted based on the on-column result. Reported results are shown in concentration units and as a result of the calculation, may vary slightly.

LABORATORY CONTROL SAMPLE SUMMARY

Page 2 of 3

**Client:** GSI Environmental Inc.

**Client Sample ID:** Lab Control Sample

**Client Project ID:** ESTCP CSIA / OSA Demonstration / 3585/3669

CAS Project ID: P1203938

CAS Sample ID: P120928-LCS

Test Code: EPA TO-15

Date Collected: NA

Instrument ID: Tekmar AUTOCAN/Agilent 5975Cinert/6890N/MS16

Date Received: NA

Analyst: Lusine Hakobyan

Date Analyzed: 9/28/12

Sampling Media: 6.0 L Summa Canister

Volume(s) Analyzed: 0.125 Liter(s)

Test Notes:

CAS #	Compound	Spike Amount µg/m <sup>3</sup>	Result µg/m <sup>3</sup>	% Recovery	CAS	Data Qualifier
					Acceptance Limits	
156-59-2	cis-1,2-Dichloroethene	214	209	98	69-119	
141-78-6	Ethyl Acetate	412	422	102	63-130	
110-54-3	n-Hexane	206	182	88	57-120	
67-66-3	Chloroform	222	204	92	69-111	
109-99-9	Tetrahydrofuran (THF)	208	217	104	57-123	
107-06-2	1,2-Dichloroethane	208	212	102	70-118	
71-55-6	1,1,1-Trichloroethane	204	191	94	73-119	
71-43-2	Benzene	208	186	89	66-121	
56-23-5	Carbon Tetrachloride	212	217	102	74-129	
110-82-7	Cyclohexane	402	356	89	70-113	
78-87-5	1,2-Dichloropropane	204	179	88	69-118	
75-27-4	Bromodichloromethane	204	197	97	75-124	
79-01-6	Trichloroethene	198	194	98	73-115	
123-91-1	1,4-Dioxane	206	188	91	71-123	
80-62-6	Methyl Methacrylate	414	390	94	72-127	
142-82-5	n-Heptane	202	174	86	68-120	
10061-01-5	cis-1,3-Dichloropropene	196	193	98	71-130	
108-10-1	4-Methyl-2-pentanone	210	191	91	69-130	
10061-02-6	trans-1,3-Dichloropropene	218	228	105	76-133	
79-00-5	1,1,2-Trichloroethane	202	182	90	73-120	
108-88-3	Toluene	208	181	87	67-111	
591-78-6	2-Hexanone	228	206	90	70-123	
124-48-1	Dibromochloromethane	216	212	98	75-129	
106-93-4	1,2-Dibromoethane	208	194	93	73-122	
123-86-4	n-Butyl Acetate	228	229	100	68-132	

Laboratory Control Sample percent recovery is verified and accepted based on the on-column result. Reported results are shown in concentration units and as a result of the calculation, may vary slightly.

## LABORATORY CONTROL SAMPLE SUMMARY

Page 3 of 3

**Client:** GSI Environmental Inc.

**Client Sample ID:** Lab Control Sample

**Client Project ID:** ESTCP CSIA / OSA Demonstration / 3585/3669

CAS Project ID: P1203938

CAS Sample ID: P120928-LCS

Test Code: EPA TO-15

Date Collected: NA

Instrument ID: Tekmar AUTOCAN/Agilent 5975Cinert/6890N/MS16

Date Received: NA

Analyst: Lusine Hakobyan

Date Analyzed: 9/28/12

Sampling Media: 6.0 L Summa Canister

Volume(s) Analyzed: 0.125 Liter(s)

Test Notes:

CAS #	Compound	Spike Amount µg/m <sup>3</sup>	Result µg/m <sup>3</sup>	% Recovery	CAS	Data Qualifier
					Acceptance Limits	
111-65-9	n-Octane	206	193	94	68-116	
127-18-4	Tetrachloroethene	190	185	97	67-119	
108-90-7	Chlorobenzene	208	188	90	69-113	
100-41-4	Ethylbenzene	206	178	86	71-117	
179601-23-1	m,p-Xylenes	412	381	92	70-116	
75-25-2	Bromoform	216	207	96	69-127	
100-42-5	Styrene	208	195	94	71-125	
95-47-6	o-Xylene	200	176	88	70-116	
111-84-2	n-Nonane	202	172	85	68-116	
79-34-5	1,1,2,2-Tetrachloroethane	198	174	88	70-119	
98-82-8	Cumene	196	185	94	70-116	
80-56-8	alpha-Pinene	192	182	95	71-119	
103-65-1	n-Propylbenzene	198	189	95	71-119	
622-96-8	4-Ethyltoluene	204	197	97	71-119	
108-67-8	1,3,5-Trimethylbenzene	208	192	92	71-121	
95-63-6	1,2,4-Trimethylbenzene	200	185	93	73-127	
100-44-7	Benzyl Chloride	206	215	104	65-137	
541-73-1	1,3-Dichlorobenzene	206	208	101	68-123	
106-46-7	1,4-Dichlorobenzene	212	201	95	65-120	
95-50-1	1,2-Dichlorobenzene	204	186	91	67-121	
5989-27-5	d-Limonene	206	183	89	67-130	
96-12-8	1,2-Dibromo-3-chloropropane	202	206	102	72-133	
120-82-1	1,2,4-Trichlorobenzene	200	183	92	62-133	
91-20-3	Naphthalene	178	152	85	56-138	
87-68-3	Hexachlorobutadiene	208	182	88	60-128	

Laboratory Control Sample percent recovery is verified and accepted based on the on-column result.  
 Reported results are shown in concentration units and as a result of the calculation, may vary slightly.

## LABORATORY CONTROL SAMPLE SUMMARY

Page 1 of 3

**Client:** GSI Environmental Inc.

**Client Sample ID:** Lab Control Sample

**Client Project ID:** ESTCP CSIA / OSA Demonstration / 3585/3669

CAS Project ID: P1203938

CAS Sample ID: P121001-LCS

Test Code: EPA TO-15

Date Collected: NA

Instrument ID: Tekmar AUTOCAN/Agilent 5975Cinert/6890N/MS16

Date Received: NA

Analyst: Lusine Hakobyan

Date Analyzed: 10/01/12

Sampling Media: 6.0 L Summa Canister

Volume(s) Analyzed: 0.125 Liter(s)

Test Notes:

CAS #	Compound	Spike Amount µg/m <sup>3</sup>	Result µg/m <sup>3</sup>	% Recovery	CAS	Data Qualifier
					Acceptance Limits	
115-07-1	Propene	204	189	93	59-137	
75-71-8	Dichlorodifluoromethane (CFC 12)	202	180	89	63-115	
74-87-3	Chloromethane	196	178	91	59-124	
76-14-2	1,2-Dichloro-1,1,2,2-tetrafluoroethane (CFC 114)	206	196	95	65-113	
75-01-4	Vinyl Chloride	200	186	93	59-121	
106-99-0	1,3-Butadiene	210	211	100	60-138	
74-83-9	Bromomethane	200	180	90	69-129	
75-00-3	Chloroethane	202	181	90	60-120	
64-17-5	Ethanol	958	839	88	58-121	
75-05-8	Acetonitrile	202	199	99	64-129	
107-02-8	Acrolein	204	175	86	54-127	
67-64-1	Acetone	1,040	924	89	59-114	
75-69-4	Trichlorofluoromethane	210	184	88	66-108	
67-63-0	2-Propanol (Isopropyl Alcohol)	396	340	86	50-113	
107-13-1	Acrylonitrile	206	235	114	72-135	
75-35-4	1,1-Dichloroethene	218	199	91	70-117	
75-09-2	Methylene Chloride	212	191	90	61-108	
107-05-1	3-Chloro-1-propene (Allyl Chloride)	214	185	86	70-131	
76-13-1	Trichlorotrifluoroethane	212	203	96	70-113	
75-15-0	Carbon Disulfide	208	178	86	65-112	
156-60-5	trans-1,2-Dichloroethene	202	206	102	71-119	
75-34-3	1,1-Dichloroethane	206	183	89	71-116	
1634-04-4	Methyl tert-Butyl Ether	204	187	92	67-116	
108-05-4	Vinyl Acetate	988	1080	109	59-142	
78-93-3	2-Butanone (MEK)	212	231	109	68-125	

Laboratory Control Sample percent recovery is verified and accepted based on the on-column result. Reported results are shown in concentration units and as a result of the calculation, may vary slightly.

LABORATORY CONTROL SAMPLE SUMMARY

Page 2 of 3

**Client:** GSI Environmental Inc.

**Client Sample ID:** Lab Control Sample

**Client Project ID:** ESTCP CSIA / OSA Demonstration / 3585/3669

CAS Project ID: P1203938

CAS Sample ID: P121001-LCS

Test Code: EPA TO-15

Date Collected: NA

Instrument ID: Tekmar AUTOCAN/Agilent 5975Cinert/6890N/MS16

Date Received: NA

Analyst: Lusine Hakobyan

Date Analyzed: 10/01/12

Sampling Media: 6.0 L Summa Canister

Volume(s) Analyzed: 0.125 Liter(s)

Test Notes:

CAS #	Compound	Spike Amount µg/m <sup>3</sup>	Result µg/m <sup>3</sup>	% Recovery	CAS	Data Qualifier
					Acceptance Limits	
156-59-2	cis-1,2-Dichloroethene	214	196	92	69-119	
141-78-6	Ethyl Acetate	412	427	104	63-130	
110-54-3	n-Hexane	206	183	89	57-120	
67-66-3	Chloroform	222	202	91	69-111	
109-99-9	Tetrahydrofuran (THF)	208	189	91	57-123	
107-06-2	1,2-Dichloroethane	208	199	96	70-118	
71-55-6	1,1,1-Trichloroethane	204	192	94	73-119	
71-43-2	Benzene	208	177	85	66-121	
56-23-5	Carbon Tetrachloride	212	208	98	74-129	
110-82-7	Cyclohexane	402	342	85	70-113	
78-87-5	1,2-Dichloropropane	204	186	91	69-118	
75-27-4	Bromodichloromethane	204	199	98	75-124	
79-01-6	Trichloroethene	198	195	98	73-115	
123-91-1	1,4-Dioxane	206	189	92	71-123	
80-62-6	Methyl Methacrylate	414	401	97	72-127	
142-82-5	n-Heptane	202	177	88	68-120	
10061-01-5	cis-1,3-Dichloropropene	196	200	102	71-130	
108-10-1	4-Methyl-2-pentanone	210	196	93	69-130	
10061-02-6	trans-1,3-Dichloropropene	218	228	105	76-133	
79-00-5	1,1,2-Trichloroethane	202	186	92	73-120	
108-88-3	Toluene	208	165	79	67-111	
591-78-6	2-Hexanone	228	196	86	70-123	
124-48-1	Dibromochloromethane	216	193	89	75-129	
106-93-4	1,2-Dibromoethane	208	175	84	73-122	
123-86-4	n-Butyl Acetate	228	198	87	68-132	

Laboratory Control Sample percent recovery is verified and accepted based on the on-column result. Reported results are shown in concentration units and as a result of the calculation, may vary slightly.

## LABORATORY CONTROL SAMPLE SUMMARY

Page 3 of 3

**Client:** GSI Environmental Inc.

**Client Sample ID:** Lab Control Sample

**Client Project ID:** ESTCP CSIA / OSA Demonstration / 3585/3669

CAS Project ID: P1203938

CAS Sample ID: P121001-LCS

Test Code: EPA TO-15

Date Collected: NA

Instrument ID: Tekmar AUTOCAN/Agilent 5975Cinert/6890N/MS16

Date Received: NA

Analyst: Lusine Hakobyan

Date Analyzed: 10/01/12

Sampling Media: 6.0 L Summa Canister

Volume(s) Analyzed: 0.125 Liter(s)

Test Notes:

CAS #	Compound	Spike Amount µg/m <sup>3</sup>	Result µg/m <sup>3</sup>	% Recovery	CAS	Data Qualifier
					Acceptance Limits	
111-65-9	n-Octane	206	161	78	68-116	
127-18-4	Tetrachloroethene	190	157	83	67-119	
108-90-7	Chlorobenzene	208	183	88	69-113	
100-41-4	Ethylbenzene	206	179	87	71-117	
179601-23-1	m,p-Xylenes	412	351	85	70-116	
75-25-2	Bromoform	216	205	95	69-127	
100-42-5	Styrene	208	180	87	71-125	
95-47-6	o-Xylene	200	169	85	70-116	
111-84-2	n-Nonane	202	159	79	68-116	
79-34-5	1,1,2,2-Tetrachloroethane	198	168	85	70-119	
98-82-8	Cumene	196	153	78	70-116	
80-56-8	alpha-Pinene	192	150	78	71-119	
103-65-1	n-Propylbenzene	198	158	80	71-119	
622-96-8	4-Ethyltoluene	204	166	81	71-119	
108-67-8	1,3,5-Trimethylbenzene	208	176	85	71-121	
95-63-6	1,2,4-Trimethylbenzene	200	163	82	73-127	
100-44-7	Benzyl Chloride	206	196	95	65-137	
541-73-1	1,3-Dichlorobenzene	206	184	89	68-123	
106-46-7	1,4-Dichlorobenzene	212	176	83	65-120	
95-50-1	1,2-Dichlorobenzene	204	168	82	67-121	
5989-27-5	d-Limonene	206	162	79	67-130	
96-12-8	1,2-Dibromo-3-chloropropane	202	178	88	72-133	
120-82-1	1,2,4-Trichlorobenzene	200	184	92	62-133	
91-20-3	Naphthalene	178	148	83	56-138	
87-68-3	Hexachlorobutadiene	208	177	85	60-128	

Laboratory Control Sample percent recovery is verified and accepted based on the on-column result.  
 Reported results are shown in concentration units and as a result of the calculation, may vary slightly.



## LABORATORY DUPLICATE SUMMARY RESULTS

Page 1 of 3

**Client:** GSI Environmental Inc.

**Client Sample ID:** SS-2C

**Client Project ID:** ESTCP CSIA / OSA Demonstration / 3585/3669

CAS Project ID: P1203938

CAS Sample ID: P1203938-004DUP

Test Code: EPA TO-15

Date Collected: 9/18/12

Instrument ID: Tekmar AUTOCAN/Agilent 5975Cinert/6890N/MS16

Date Received: 9/25/12

Analyst: Lusine Hakobyan

Date Analyzed: 9/28/12

Sampling Media: 6.0 L Summa Canister

Volume(s) Analyzed: 0.020 Liter(s)

Test Notes:

Container ID: AC00977

Initial Pressure (psig): -0.30

Final Pressure (psig): 3.54

Canister Dilution Factor: 1.27

Compound	Sample Result		Duplicate Sample Result		Average µg/m <sup>3</sup>	% RPD	RPD Limit	Data Qualifier
	µg/m <sup>3</sup>	ppbV	µg/m <sup>3</sup>	ppbV				
Propene	ND	ND	ND	ND	-	-	25	
Dichlorodifluoromethane (CFC 12)	ND	ND	ND	ND	-	-	25	
Chloromethane	ND	ND	ND	ND	-	-	25	
1,2-Dichloro-1,1,2,2-tetrafluoroethane (CFC 114)	ND	ND	ND	ND	-	-	25	
Vinyl Chloride	ND	ND	ND	ND	-	-	25	
1,3-Butadiene	ND	ND	ND	ND	-	-	25	
Bromomethane	ND	ND	ND	ND	-	-	25	
Chloroethane	ND	ND	ND	ND	-	-	25	
Ethanol	ND	ND	ND	ND	-	-	25	
Acetonitrile	ND	ND	ND	ND	-	-	25	
Acrolein	ND	ND	ND	ND	-	-	25	
Acetone	3,330	1,400	3,570	1,510	3450	7	25	
Trichlorofluoromethane	ND	ND	ND	ND	-	-	25	
2-Propanol (Isopropyl Alcohol)	ND	ND	ND	ND	-	-	25	
Acrylonitrile	ND	ND	ND	ND	-	-	25	
1,1-Dichloroethene	ND	ND	ND	ND	-	-	25	
Methylene Chloride	ND	ND	ND	ND	-	-	25	
3-Chloro-1-propene (Allyl Chloride)	ND	ND	ND	ND	-	-	25	
Trichlorotrifluoroethane	ND	ND	ND	ND	-	-	25	
Carbon Disulfide	ND	ND	ND	ND	-	-	25	
trans-1,2-Dichloroethene	ND	ND	ND	ND	-	-	25	
1,1-Dichloroethane	ND	ND	ND	ND	-	-	25	
Methyl tert-Butyl Ether	ND	ND	ND	ND	-	-	25	
Vinyl Acetate	ND	ND	ND	ND	-	-	25	
2-Butanone (MEK)	ND	ND	ND	ND	-	-	25	

ND = Compound was analyzed for, but not detected above the laboratory reporting limit.

## LABORATORY DUPLICATE SUMMARY RESULTS

Page 2 of 3

**Client:** GSI Environmental Inc.

**Client Sample ID:** SS-2C

**Client Project ID:** ESTCP CSIA / OSA Demonstration / 3585/3669

CAS Project ID: P1203938

CAS Sample ID: P1203938-004DUP

Test Code: EPA TO-15

Date Collected: 9/18/12

Instrument ID: Tekmar AUTOCAN/Agilent 5975Cinert/6890N/MS16

Date Received: 9/25/12

Analyst: Lusine Hakobyan

Date Analyzed: 9/28/12

Sampling Media: 6.0 L Summa Canister

Volume(s) Analyzed: 0.020 Liter(s)

Test Notes:

Container ID: AC00977

Initial Pressure (psig): -0.30

Final Pressure (psig): 3.54

Canister Dilution Factor: 1.27

Compound	Sample Result		Duplicate Sample Result		Average µg/m <sup>3</sup>	% RPD	RPD Limit	Data Qualifier
	µg/m <sup>3</sup>	ppbV	µg/m <sup>3</sup>	ppbV				
cis-1,2-Dichloroethene	ND	ND	ND	ND	-	-	25	
Ethyl Acetate	ND	ND	ND	ND	-	-	25	
n-Hexane	1,220	346	1,270	361	1245	4	25	
Chloroform	ND	ND	ND	ND	-	-	25	
Tetrahydrofuran (THF)	ND	ND	ND	ND	-	-	25	
1,2-Dichloroethane	ND	ND	ND	ND	-	-	25	
1,1,1-Trichloroethane	ND	ND	ND	ND	-	-	25	
Benzene	57.8	18.1	55.1	17.3	56.45	5	25	
Carbon Tetrachloride	ND	ND	ND	ND	-	-	25	
Cyclohexane	479	139	479	139	479	0	25	
1,2-Dichloropropane	ND	ND	ND	ND	-	-	25	
Bromodichloromethane	ND	ND	ND	ND	-	-	25	
Trichloroethene	26.0	4.85	27.0	5.02	26.5	4	25	
1,4-Dioxane	ND	ND	ND	ND	-	-	25	
Methyl Methacrylate	ND	ND	ND	ND	-	-	25	
n-Heptane	958	234	988	241	973	3	25	
cis-1,3-Dichloropropene	ND	ND	ND	ND	-	-	25	
4-Methyl-2-pentanone	ND	ND	ND	ND	-	-	25	
trans-1,3-Dichloropropene	ND	ND	ND	ND	-	-	25	
1,1,2-Trichloroethane	ND	ND	ND	ND	-	-	25	
Toluene	52.5	13.9	53.9	14.3	53.2	3	25	
2-Hexanone	ND	ND	ND	ND	-	-	25	
Dibromochloromethane	ND	ND	ND	ND	-	-	25	
1,2-Dibromoethane	ND	ND	ND	ND	-	-	25	
n-Butyl Acetate	ND	ND	ND	ND	-	-	25	

ND = Compound was analyzed for, but not detected above the laboratory reporting limit.

LABORATORY DUPLICATE SUMMARY RESULTS

Page 3 of 3

**Client:** GSI Environmental Inc.

**Client Sample ID:** SS-2C

**Client Project ID:** ESTCP CSIA / OSA Demonstration / 3585/3669

CAS Project ID: P1203938

CAS Sample ID: P1203938-004DUP

Test Code: EPA TO-15

Date Collected: 9/18/12

Instrument ID: Tekmar AUTOCAN/Agilent 5975Cinert/6890N/MS16

Date Received: 9/25/12

Analyst: Lusine Hakobyan

Date Analyzed: 9/28/12

Sampling Media: 6.0 L Summa Canister

Volume(s) Analyzed: 0.020 Liter(s)

Test Notes:

Container ID: AC00977

Initial Pressure (psig): -0.30

Final Pressure (psig): 3.54

Canister Dilution Factor: 1.27

Compound	Sample Result		Duplicate Sample Result		Average µg/m <sup>3</sup>	% RPD	RPD Limit	Data Qualifier
	µg/m <sup>3</sup>	ppbV	µg/m <sup>3</sup>	ppbV				
n-Octane	210	44.9	207	44.3	208.5	1	25	
Tetrachloroethene	5,030	742	4,840	714	4935	4	25	
Chlorobenzene	ND	ND	ND	ND	-	-	25	
Ethylbenzene	427	98.3	457	105	442	7	25	
m,p-Xylenes	765	176	810	187	787.5	6	25	
Bromoform	ND	ND	ND	ND	-	-	25	
Styrene	ND	ND	ND	ND	-	-	25	
o-Xylene	ND	ND	ND	ND	-	-	25	
n-Nonane	51.5	9.82	51.9	9.91	51.7	0.8	25	
1,1,2,2-Tetrachloroethane	ND	ND	ND	ND	-	-	25	
Cumene	34.4	7.00	35.8	7.29	35.1	4	25	
alpha-Pinene	ND	ND	ND	ND	-	-	25	
n-Propylbenzene	133	27.0	142	28.9	137.5	7	25	
4-Ethyltoluene	257	52.2	273	55.5	265	6	25	
1,3,5-Trimethylbenzene	219	44.6	236	48.1	227.5	7	25	
1,2,4-Trimethylbenzene	857	174	911	185	884	6	25	
Benzyl Chloride	ND	ND	ND	ND	-	-	25	
1,3-Dichlorobenzene	ND	ND	ND	ND	-	-	25	
1,4-Dichlorobenzene	ND	ND	ND	ND	-	-	25	
1,2-Dichlorobenzene	ND	ND	ND	ND	-	-	25	
d-Limonene	ND	ND	ND	ND	-	-	25	
1,2-Dibromo-3-chloropropane	ND	ND	ND	ND	-	-	25	
1,2,4-Trichlorobenzene	ND	ND	ND	ND	-	-	25	
Naphthalene	ND	ND	ND	ND	-	-	25	
Hexachlorobutadiene	ND	ND	ND	ND	-	-	25	

ND = Compound was analyzed for, but not detected above the laboratory reporting limit.

RESULTS OF ANALYSIS

Page 1 of 1

**Client:** GSI Environmental Inc.  
**Client Project ID:** ESTCP CSIA / OSA Demonstration / 3585/3669

CAS Project ID: P1203938

**Method Blank Summary**

Test Code: EPA TO-15  
Instrument ID: Tekmar AUTOCAN/Agilent 5975Cinert/6890N/MS16  
Analyst: Lusine Hakobyan  
Sampling Media: 6.0 L Summa Canister(s)  
Test Notes:

Lab File ID: 09281203.D  
Date Analyzed: 9/28/12  
Time Analyzed: 10:33

Client Sample ID	CAS Sample ID	Lab File ID	Time Analyzed
Lab Control Sample	P120928-LCS	09281204.D	11:08
Indoor-C1	P1203938-001	09281207.D	12:57
SS-2C	P1203938-004	09281209.D	14:06
Outdoor-C1	P1203938-002	09281210.D	14:55
SS-2C (Lab Duplicate)	P1203938-004DUP	09281212.D	16:02
SS-1C	P1203938-003	09281214.D	17:15
SS-3C	P1203938-005	09281215.D	17:48
SS-3C (Dilution)	P1203938-005	09281216.D	18:22
Indoor-1-BL	P1203938-006	09281217.D	18:55
Indoor-1-BL (Dilution)	P1203938-006	09281218.D	19:29
Indoor-1-PP	P1203938-007	09281219.D	20:03
Indoor-1-NP	P1203938-008	09281220.D	20:36
Indoor-1-NP (Dilution)	P1203938-008	09281221.D	21:10
Dup 1	P1203938-009	09281222.D	21:44

RESULTS OF ANALYSIS

Page 1 of 1

**Client:** GSI Environmental Inc. CAS Project ID: P1203938  
**Client Project ID:** ESTCP CSIA / OSA Demonstration / 3585/3669

**Method Blank Summary**

Test Code: EPA TO-15  
Instrument ID: Tekmar AUTOCAN/Agilent 5975Cinert/6890N/MS16 Lab File ID: 10011203.D  
Analyst: Lusine Hakobyan Date Analyzed: 10/01/12  
Sampling Media: 6.0 L Summa Canister(s) Time Analyzed: 10:06  
Test Notes:

Client Sample ID	CAS Sample ID	Lab File ID	Time Analyzed
Lab Control Sample	P121001-LCS	10011204.D	10:48
Dup 1 (Dilution)	P1203938-009	10011207.D	12:33
Indoor-1-PP (Dilution)	P1203938-007	10011209.D	14:02

RESULTS OF ANALYSIS

Page 1 of 1

**Client:** GSI Environmental Inc.  
**Client Project ID:** ESTCP CSIA / OSA Demonstration / 3585/3669

CAS Project ID: P1203938

**Internal Standard Area and RT Summary**

Test Code: EPA TO-15  
 Instrument ID: Tekmar AUTOCAN/Agilent 5975Cinert/6890N/MS16  
 Analyst: Lusine Hakobyan  
 Sampling Media: 6.0 L Summa Canister(s)  
 Test Notes:

Lab File ID: 09281201.D  
 Date Analyzed: 9/28/12  
 Time Analyzed: 09:18

	IS1 (BCM)		IS2 (DFB)		IS3 (CBZ)	
	AREA #	RT #	AREA #	RT #	AREA #	RT #
<b>24 Hour Standard</b>	175739	11.30	771015	13.51	328997	17.46
<b>Upper Limit</b>	246035	11.63	1079421	13.84	460596	17.79
<b>Lower Limit</b>	105443	10.97	462609	13.18	197398	17.13

Client Sample ID		IS1 (BCM)	IS2 (DFB)	IS3 (CBZ)
		AREA #	RT #	AREA #
01	Method Blank	174843	11.29	744034
02	Lab Control Sample	171874	11.31	735716
03	Indoor-C1	171333	11.31	683371
04	SS-2C	144647	11.30	564538
05	Outdoor-C1	183162	11.29	756778
06	SS-2C (Lab Duplicate)	139679	11.30	579632
07	SS-1C	172578	11.29	630876
08	SS-3C	166674	11.30	682369
09	SS-3C (Dilution)	132758	11.29	528587
10	Indoor-1-BL	166859	11.31	672825
11	Indoor-1-BL (Dilution)	133721	11.30	588837
12	Indoor-1-PP	144053	11.31	591128
13	Indoor-1-NP	124064	11.31	538874
14	Indoor-1-NP (Dilution)	139020	11.30	575890
15	Dup 1	141720	11.31	529231
16				
17				
18				
19				
20				

IS1 (BCM) = Bromochloromethane  
 IS2 (DFB) = 1,4-Difluorobenzene  
 IS3 (CBZ) = Chlorobenzene-d5

AREA UPPER LIMIT = 140% of internal standard area  
 AREA LOWER LIMIT = 60% of internal standard area  
 RT UPPER LIMIT = 0.33 minutes of internal standard RT  
 RT LOWER LIMIT = 0.33 minutes of internal standard RT

# Column used to flag values outside QC limits with an I.  
 I = Internal standard not within the specified limits.

RESULTS OF ANALYSIS

Page 1 of 1

**Client:** GSI Environmental Inc.  
**Client Project ID:** ESTCP CSIA / OSA Demonstration / 3585/3669

CAS Project ID: P1203938

**Internal Standard Area and RT Summary**

Test Code: EPA TO-15  
 Instrument ID: Tekmar AUTOCAN/Agilent 5975Cinert/6890N/MS16  
 Analyst: Lusine Hakobyan  
 Sampling Media: 6.0 L Summa Canister(s)  
 Test Notes:

Lab File ID: 10011201.D  
 Date Analyzed: 10/1/12  
 Time Analyzed: 08:50

	IS1 (BCM)		IS2 (DFB)		IS3 (CBZ)	
	AREA #	RT #	AREA #	RT #	AREA #	RT #
<b>24 Hour Standard</b>	173895	11.30	701985	13.51	317585	17.46
<b>Upper Limit</b>	243453	11.63	982779	13.84	444619	17.79
<b>Lower Limit</b>	104337	10.97	421191	13.18	190551	17.13

Client Sample ID		IS1 (BCM)		IS2 (DFB)		IS3 (CBZ)	
		AREA #	RT #	AREA #	RT #	AREA #	RT #
01	Method Blank	160822	11.29	716751	13.51	292160	17.46
02	Lab Control Sample	171059	11.31	678667	13.52	340534	17.46
03	Dup 1 (Dilution)	145877	11.30	593908	13.52	268172	17.46
04	Indoor-1-PP (Dilution)	141213	11.30	580649	13.52	261033	17.46
05							
06							
07							
08							
09							
10							
11							
12							
13							
14							
15							
16							
17							
18							
19							
20							

IS1 (BCM) = Bromochloromethane  
 IS2 (DFB) = 1,4-Difluorobenzene  
 IS3 (CBZ) = Chlorobenzene-d5

AREA UPPER LIMIT = 140% of internal standard area  
 AREA LOWER LIMIT = 60% of internal standard area  
 RT UPPER LIMIT = 0.33 minutes of internal standard RT  
 RT LOWER LIMIT = 0.33 minutes of internal standard RT

# Column used to flag values outside QC limits with an I.  
 I = Internal standard not within the specified limits.

Response Factor Report GCMS-16

Method Path : J:\MS16\METHODS\  
 Method File : R16071312.M  
 Title : EPA TO-15 per SOP VOA-TO15 (CASS TO-15/GC-MS)  
 Last Update : Mon Jul 16 09:59:54 2012  
 Response Via : Initial Calibration

Calibration Files

0.1 =07131207.D 0.2 =07131208.D 0.5 =07131209.D 1.0 =07131210.D 5.0 =07131211.D 25 =07131212.D  
 50 =07131213.D 100 =07131214.D

Compound	0.1	0.2	0.5	1.0	5.0	25	50	100	Avg	%RSD
1) IR Bromochloromethane...										
2) T Propene	1.696	1.340	1.661	1.508	1.517	1.872	1.492	1.343	1.554	11.67
3) T Dichlorodifluo...	3.068	2.698	2.539	2.079	2.094	2.482	1.979	1.839	2.347	17.84
4) T Chloromethane	2.235	1.947	1.800	1.418	1.428	1.736	1.401	1.201	1.646	20.88
5) T 1,2-Dichloro-1...	1.641	1.480	1.428	1.148	1.163	1.337	1.089	1.026	1.289	16.78
6) T Vinyl Chloride	1.999	1.722	1.697	1.389	1.431	1.695	1.369	1.311	1.576	15.13
7) T 1,3-Butadiene	1.417	1.109	1.173	0.947	0.988	1.232	0.995	0.948	1.101	15.10
8) T Bromomethane	1.419	1.204	1.210	0.934	0.939	1.122	0.923	0.879	1.079	17.70
9) T Chloroethane	1.042	0.807	0.858	0.700	0.692	0.816	0.666	0.632	0.776	17.26
10) T Ethanol	1.321	1.022	0.921	0.722	0.644	0.841	0.695	0.658	0.853	27.16
11) T Acetonitrile	2.423	1.952	1.889	1.550	1.455	1.841	1.529	1.461	1.763	18.94
12) T Acrolein	0.728	0.684	0.612	0.474	0.527	0.620	0.506	0.481	0.579	16.60
13) T Acetone	0.971	0.863	0.863	0.675	0.635	0.746	0.602	0.566	0.722	20.44
14) T Trichlorofluor...	2.806	2.335	2.378	1.866	1.902	2.237	1.816	1.702	2.130	17.52
15) T 2-Propanol (Is...	2.275	1.384	1.332	1.384	1.332	1.523	1.259	1.229	1.500	26.25
16) T Acrylonitrile	0.814	0.941	1.159	1.009	1.077	1.346	1.107	1.055	1.063	14.72
17) T 1,1-Dichloroet...	1.230	1.158	1.118	0.911	0.923	1.097	0.902	0.860	1.025	13.77
18) T 2-Methyl-2-Pro...	3.047	3.011	2.321	2.359	1.407				2.429	27.48
19) T Methylene Chlo...	1.302	1.038	0.951	1.118	0.907	1.118	0.907	0.864	1.030	15.68
20) T 3-Chloro-1-pro...	1.964	1.763	1.638	1.329	1.399	1.690	1.374	1.316	1.559	15.35
21) T Trichlorotrifl...	1.457	1.270	1.210	0.988	0.978	1.149	0.930	0.876	1.107	17.97
22) T Carbon Disulfide	5.408	4.597	4.360	3.491	3.567	4.206	3.455	3.268	4.044	18.16
23) T trans-1,2-Dich...	1.733	1.501	1.606	1.343	1.392	1.683	1.380	1.314	1.494	10.85
24) T 1,1-Dichloroet...	2.716	2.180	2.126	1.718	1.746	2.071	1.685	1.592	1.979	18.83
25) T Methyl tert-Bu...	4.329	3.512	3.603	2.819	2.879	3.490	2.836	2.365	3.229	19.19
26) T Vinyl Acetate	0.180	0.193	0.207	0.186	0.200	0.255	0.207	0.176	0.200	12.52
27) T 2-Butanone (MEK)	0.665	0.627	0.689	0.572	0.593	0.691	0.492	0.387	0.589	17.91
28) T cis-1,2-Dichlo...	1.856	1.550	1.599	1.264	1.302	1.592	1.291	1.217	1.459	15.38
29) T Diisopropyl Ether	1.153	0.921	0.911	0.752	0.737	0.882	0.710	0.662	0.841	18.98
30) T Ethyl Acetate	0.354	0.333	0.383	0.338	0.342	0.421	0.339	0.323	0.354	9.15
31) T n-Hexane	2.503	2.061	2.003	1.616	1.603	1.880	1.509	1.399	1.822	19.95



Response Factor Report GCMS-16

Method Path : J:\MS16\METHODS\  
 Method File : R16071312.M

Title	: EPA TO-15 per SOP VOA-TO15 (CASS TO-15/GC-MS)											
32) T	Chloroform	2.590	2.190	2.049	1.627	1.661	1.979	1.601	1.501	1.900	19.59	
33) S	1,2-Dichloroet...	1.293	1.293	1.298	1.309	1.306	1.298	1.297	1.291	1.298	0.49	
34) T	Tetrahydrofura...		0.832	0.621	0.598	0.681	0.556	0.524	0.635	17.40		
35) T	Ethyl tert-But...	1.782	1.419	1.379	1.125	1.138	1.376	1.124	1.050	1.299	18.61	
36) T	1,2-Dichloroet...	1.823	1.593	1.571	1.286	1.275	1.554	1.258	1.176	1.442	15.60	
37) IR	1,4-Difluorobenzen...	-----ISTD-----										
38) T	1,1,1-Trichlor...	0.596	0.468	0.462	0.375	0.375	0.466	0.372	0.347	0.433	19.07	
39) T	Isopropyl Acetate	0.196	0.179	0.167	0.138	0.141	0.176	0.141	0.134	0.159	14.73	
40) T	1-Butanol	0.307	0.262	0.241	0.198	0.212	0.284	0.229	0.215	0.244	15.59	
41) T	Benzene	1.666	1.323	1.162	0.902	0.871	1.063	0.851	0.807	1.081	27.36	
42) T	Carbon Tetrach...	0.442	0.380	0.370	0.296	0.315	0.398	0.321	0.302	0.353	14.86	
43) T	Cyclohexane	0.556	0.460	0.443	0.349	0.349	0.430	0.342	0.324	0.407	19.59	
44) T	tert-Amyl Meth...	0.959	0.888	0.828	0.671	0.687	0.854	0.687	0.650	0.778	15.14	
45) T	1,2-Dichloropr...	0.359	0.301	0.291	0.236	0.235	0.290	0.234	0.224	0.271	17.38	
46) T	Bromodichlorom...	0.449	0.389	0.386	0.311	0.325	0.405	0.324	0.308	0.362	14.40	
47) T	Trichloroethene	0.386	0.352	0.343	0.276	0.279	0.354	0.283	0.268	0.318	14.44	
48) T	1,4-Dioxane	0.276	0.241	0.225	0.179	0.183	0.232	0.187	0.177	0.212	17.19	
49) T	2,2,4-Trimethy...	1.498	1.307	1.250	0.969	0.978	1.205	0.966	0.913	1.136	18.53	
50) T	Methyl Methacr...	0.145	0.122	0.121	0.096	0.102	0.128	0.103	0.098	0.114	15.20	
51) T	n-Heptane	0.369	0.290	0.277	0.221	0.226	0.280	0.224	0.212	0.262	20.30	
52) T	cis-1,3-Dichlo...	0.467	0.434	0.417	0.350	0.384	0.488	0.396	0.377	0.414	11.29	
53) T	4-Methyl-2-pen...	0.294	0.264	0.247	0.205	0.214	0.269	0.218	0.207	0.240	13.97	
54) T	trans-1,3-Dich...	0.373	0.352	0.361	0.311	0.350	0.455	0.369	0.353	0.365	11.19	
55) T	1,1,2-Trichlor...	0.350	0.306	0.296	0.232	0.240	0.297	0.240	0.228	0.274	16.39	
56) IR	Chlorobenzene-d5	-----ISTD-----										
57) S	Toluene-d8 (SS2)	2.300	2.325	2.319	2.315	2.322	2.293	2.307	2.295	2.309	0.54	
58) T	Toluene	3.746	3.082	2.819	2.216	2.227	2.690	2.171	2.017	2.621	22.38	
59) T	2-Hexanone	1.609	1.363	1.391	1.023	1.119	1.379	1.113	1.040	1.255	16.77	
60) T	Dibromochlorom...	0.831	0.767	0.746	0.625	0.662	0.826	0.671	0.629	0.720	11.69	
61) T	1,2-Dibromoethane	0.908	0.762	0.744	0.610	0.643	0.794	0.639	0.601	0.713	15.12	
62) T	n-Butyl Acetate	1.763	1.549	1.525	1.230	1.330	1.678	1.394	1.344	1.477	12.45	
63) T	n-Octane	0.700	0.617	0.590	0.468	0.477	0.567	0.455	0.426	0.538	17.82	
64) T	Tetrachloroethene	1.244	1.079	0.970	0.791	0.800	0.972	0.782	0.729	0.921	19.34	
65) T	Chlorobenzene	2.378	1.941	1.911	1.514	1.524	1.845	1.486	1.391	1.749	18.98	
66) T	Ethylbenzene	4.163	3.380	3.161	2.556	2.571	3.086	2.489	2.303	2.964	20.75	
67) T	m- & p-Xylenes	3.266	2.687	2.524	1.999	2.020	2.438	1.965	1.822	2.340	20.74	
68) T	Bromoform	0.794	0.716	0.712	0.596	0.655	0.842	0.684	0.650	0.706	11.33	
69) T	Styrene	2.309	1.852	1.860	1.497	1.586	1.941	1.572	1.474	1.761	16.20	
70) T	o-Xylene	3.478	2.791	2.674	2.087	2.130	2.558	2.051	1.913	2.460	21.26	

Response Factor Report GCMS-16

Method Path : J:\MS16\METHODS\  
 Method File : R16071312.M

Title	: EPA TO-15 per SOP VOA-TO15 (CASS TO-15/GC-MS)										
71) T	n-Nonane	1.829	1.467	1.422	1.122	1.158	1.374	1.103	1.028	1.313	20.20
72) T	1,1,2,2-Tetrac...	1.471	1.264	1.247	0.975	1.024	1.248	1.005	0.943	1.147	16.33
73) S	Bromofluoroben...	1.181	1.192	1.193	1.209	1.192	1.176	1.198	1.187	1.191	0.85
74) T	Cumene	4.597	4.210	3.523	2.746	2.799	3.341	2.692	2.478	3.298	23.38
75) T	alpha-Pinene	2.024	1.722	1.661	1.325	1.370	1.643	1.331	1.247	1.541	17.30
76) T	n-Propylbenzene	5.361	4.357	4.010	3.255	3.301	3.992	3.205	2.941	3.803	21.01
77) T	3-Ethyltoluene	3.796	3.263	3.263	2.631	2.696	3.211	2.718	2.387	2.995	15.46
78) T	4-Ethyltoluene	3.849	3.230	3.064	2.471	2.442	3.080	2.344	2.295	2.847	19.30
79) T	1,3,5-Trimethy...	3.737	2.685	2.721	2.064	2.135	2.586	2.087	1.932	2.493	23.66
80) T	alpha-Methylst...	1.616	1.424	1.377	1.100	1.187	1.475	1.194	1.115	1.311	14.38
81) T	2-Ethyltoluene	4.529	3.683	3.401	2.634	2.696	3.250	2.616	2.425	3.154	22.55
82) T	1,2,4-Trimethy...	3.895	3.059	2.678	2.129	2.197	2.670	2.149	1.979	2.595	24.69
83) T	n-Decane	1.747	1.516	1.430	1.132	1.184	1.429	1.151	1.079	1.334	17.54
84) T	Benzyl Chloride	1.911	1.943	1.903	1.579	1.822	2.433	1.998	1.880	1.934	12.30
85) T	1,3-Dichlorobe...	2.106	1.761	1.641	1.310	1.360	1.674	1.347	1.258	1.557	18.76
86) T	1,4-Dichlorobe...	2.346	1.807	1.698	1.317	1.377	1.705	1.374	1.279	1.613	22.26
87) T	sec-Butylbenzene	4.502	3.780	3.550	2.891	2.946	3.562	2.857	2.621	3.339	18.75
88) T	4-Isopropyltol...	4.363	3.725	3.526	2.810	2.946	3.576	2.857	2.596	3.300	18.09
89) T	1,2,3-Trimethy...	3.424	2.813	2.714	2.140	2.241	2.735	2.207	2.040	2.539	18.44
90) T	1,2-Dichlorobe...	1.947	1.690	1.619	1.270	1.327	1.631	1.319	1.225	1.503	17.02
91) T	d-Limonene	1.185	0.939	0.960	0.794	0.824	1.018	0.827	0.771	0.915	15.32
92) T	1,2-Dibromo-3-...	0.657	0.582	0.567	0.446	0.512	0.663	0.538	0.505	0.559	13.45
93) T	n-Undecane	1.801	1.459	1.390	1.101	1.227	1.484	1.194	1.103	1.345	17.71
94) T	1,2,4-Trichlor...	1.658	1.351	1.210	0.958	1.130	1.395	1.128	1.051	1.235	18.15
95) T	Naphthalene	5.981	4.526	3.881	2.914	3.404	4.290	3.507	3.229	3.967	24.59
96) T	n-Dodecane	1.537	1.273	1.216	0.987	1.272	1.519	1.238	1.152	1.274	14.27
97) T	Hexachlorobuta...	1.161	0.949	0.852	0.703	0.742	0.894	0.722	0.673	0.837	19.57
98) T	Cyclohexanone	1.306	1.032	0.948	0.742	0.792	0.985	0.795	0.750	0.919	20.94
99) T	tert-Butylbenzene	3.555	2.905	2.747	2.182	2.246	2.688	2.143	1.961	2.554	20.59
100) T	n-Butylbenzene	3.342	2.755	2.672	2.133	2.291	2.767	2.233	2.058	2.531	17.10

(#) = Out of Range

Evaluate Continuing Calibration Report

Data Path : J:\MS16\DATA\2012\_09\28\  
 Data File : 09281201.D  
 Acq On : 28 Sep 2012 9:18  
 Operator : LH  
 Sample : 25ng TO-15 CCV STD  
 Misc : S25-09261201/S25-08301203  
 ALS Vial : 2 Sample Multiplier: 1

Quant Time: Sep 28 11:34:10 2012  
 Quant Method : J:\MS16\METHODS\R16071312.M  
 Quant Title : EPA TO-15 per SOP VOA-TO15 (CASS TO-15/GC-MS)  
 QLast Update : Mon Jul 16 09:59:54 2012  
 Response via : Initial Calibration

Min. RRF : 0.000 Min. Rel. Area : 50% Max. R.T. Dev 0.33min  
 Max. RRF Dev : 30% Max. Rel. Area : 200%

	Compound	AvgRF	CCRF	%Dev	Area%	Dev(min)
1	IR Bromochloromethane (IS1)	1.000	1.000	0.0	118	-0.02
2	T Propene	1.554	1.456	6.3	92	0.00
3	T Dichlorodifluoromethane (CF	2.347	2.208	5.9	105	0.00
4	T Chloromethane	1.646	1.492	9.4	101	-0.01
5	T 1,2-Dichloro-1,1,2,2-tetra	1.289	1.199	7.0	106	-0.01
6	T Vinyl Chloride	1.576	1.485	5.8	103	-0.01
7	T 1,3-Butadiene	1.101	1.103	-0.2	106	-0.01
8	T Bromomethane	1.079	1.033	4.3	109	-0.02
9	T Chloroethane	0.776	0.726	6.4	105	-0.01
10	T Ethanol	0.853	0.780	8.6	109	-0.07
11	T Acetonitrile	1.763	1.665	5.6	107	-0.05
12	T Acrolein	0.579	0.538	7.1	102	-0.02
13	T Acetone	0.722	0.665	7.9	105	-0.05
14	T Trichlorofluoromethane	2.130	2.054	3.6	108	-0.01
15	T 2-Propanol (Isopropanol)	1.500	1.615	-7.7	125	-0.05
16	T Acrylonitrile	1.063	1.187	-11.7	104	-0.03
17	T 1,1-Dichloroethene	1.025	0.971	5.3	104	-0.02
18	T 2-Methyl-2-Propanol (tert-B	2.429	2.625	-8.1	220#	-0.04
19	T Methylene Chloride	1.030	1.047	-1.7	110	-0.02
20	T 3-Chloro-1-propene (Allyl C	1.559	1.516	2.8	106	-0.02
21	T Trichlorotrifluoroethane	1.107	1.080	2.4	111	-0.02
22	T Carbon Disulfide	4.044	3.921	3.0	110	-0.02
23	T trans-1,2-Dichloroethene	1.494	1.490	0.3	104	-0.02
24	T 1,1-Dichloroethane	1.979	1.820	8.0	104	-0.02
25	T Methyl tert-Butyl Ether	3.229	3.075	4.8	104	-0.02
26	T Vinyl Acetate	0.200	0.230	-15.0	106	-0.03
27	T 2-Butanone (MEK)	0.589	0.620	-5.3	106	-0.02
28	T cis-1,2-Dichloroethene	1.459	1.426	2.3	106	-0.02
29	T Diisopropyl Ether	0.841	0.771	8.3	103	-0.02
30	T Ethyl Acetate	0.354	0.361	-2.0	101	-0.03
31	T n-Hexane	1.822	1.623	10.9	102	-0.01
32	T Chloroform	1.900	1.815	4.5	108	-0.03
33	S 1,2-Dichloroethane-d4 (SS1)	1.298	1.407	-8.4	128	-0.02
34	T Tetrahydrofuran (THF)	0.635	0.600	5.5	104	-0.02
35	T Ethyl tert-Butyl Ether	1.299	1.216	6.4	104	-0.02
36	T 1,2-Dichloroethane	1.442	1.433	0.6	109	-0.02
37	IR 1,4-Difluorobenzene (IS2)	1.000	1.000	0.0	129	-0.02
38	T 1,1,1-Trichloroethane	0.433	0.385	11.1	107	-0.01

Evaluate Continuing Calibration Report

Data Path : J:\MS16\DATA\2012\_09\28\  
 Data File : 09281201.D  
 Acq On : 28 Sep 2012 9:18  
 Operator : LH  
 Sample : 25ng TO-15 CCV STD  
 Misc : S25-09261201/S25-08301203  
 ALS Vial : 2 Sample Multiplier: 1

Quant Time: Sep 28 11:34:10 2012  
 Quant Method : J:\MS16\METHODS\R16071312.M  
 Quant Title : EPA TO-15 per SOP VOA-TO15 (CASS TO-15/GC-MS)  
 QLast Update : Mon Jul 16 09:59:54 2012  
 Response via : Initial Calibration

Min. RRF : 0.000 Min. Rel. Area : 50% Max. R.T. Dev 0.33min  
 Max. RRF Dev : 30% Max. Rel. Area : 200%

	Compound	AvgRF	CCRF	%Dev	Area%	Dev(min)
39 T	Isopropyl Acetate	0.159	0.148	6.9	109	-0.02
40 T	1-Butanol	0.244	0.241	1.2	109	-0.05
41 T	Benzene	1.081	0.900	16.7	109	-0.01
42 T	Carbon Tetrachloride	0.353	0.357	-1.1	116	-0.02
43 T	Cyclohexane	0.407	0.360	11.5	108	-0.02
44 T	tert-Amyl Methyl Ether	0.778	0.727	6.6	110	-0.01
45 T	1,2-Dichloropropane	0.271	0.241	11.1	107	-0.01
46 T	Bromodichloromethane	0.362	0.350	3.3	112	-0.01
47 T	Trichloroethene	0.318	0.301	5.3	110	-0.02
48 T	1,4-Dioxane	0.212	0.195	8.0	108	-0.02
49 T	2,2,4-Trimethylpentane (Iso	1.136	0.990	12.9	106	-0.01
50 T	Methyl Methacrylate	0.114	0.108	5.3	109	-0.02
51 T	n-Heptane	0.262	0.231	11.8	107	-0.01
52 T	cis-1,3-Dichloropropene	0.414	0.414	0.0	110	-0.01
53 T	4-Methyl-2-pentanone	0.240	0.221	7.9	106	-0.01
54 T	trans-1,3-Dichloropropene	0.365	0.385	-5.5	110	-0.01
55 T	1,1,2-Trichloroethane	0.274	0.248	9.5	108	-0.01
56 IR	Chlorobenzene-d5 (IS3)	1.000	1.000	0.0	123	0.00
57 S	Toluene-d8 (SS2)	2.309	2.289	0.9	123	-0.01
58 T	Toluene	2.621	2.259	13.8	103	-0.01
59 T	2-Hexanone	1.255	1.133	9.7	101	-0.02
60 T	Dibromochloromethane	0.720	0.706	1.9	105	-0.01
61 T	1,2-Dibromoethane	0.713	0.663	7.0	103	-0.01
62 T	n-Butyl Acetate	1.477	1.357	8.1	99	-0.01
63 T	n-Octane	0.538	0.460	14.5	100	-0.01
64 T	Tetrachloroethene	0.921	0.815	11.5	103	0.00
65 T	Chlorobenzene	1.749	1.531	12.5	102	-0.01
66 T	Ethylbenzene	2.964	2.577	13.1	103	0.00
67 T	m- & p-Xylenes	2.340	2.066	11.7	104	-0.01
68 T	Bromoform	0.706	0.729	-3.3	106	-0.01
69 T	Styrene	1.761	1.539	12.6	97	-0.01
70 T	o-Xylene	2.460	2.160	12.2	104	0.00
71 T	n-Nonane	1.313	1.113	15.2	100	-0.01
72 T	1,1,2,2-Tetrachloroethane	1.147	1.047	8.7	103	0.00
73 S	Bromofluorobenzene (SS3)	1.191	1.286	-8.0	134	0.00
74 T	Cumene	3.298	2.871	12.9	106	0.00
75 T	alpha-Pinene	1.541	1.275	17.3	95	0.00
76 T	n-Propylbenzene	3.803	3.308	13.0	102	0.00

Evaluate Continuing Calibration Report

Data Path : J:\MS16\DATA\2012\_09\28\  
 Data File : 09281201.D  
 Acq On : 28 Sep 2012 9:18  
 Operator : LH  
 Sample : 25ng TO-15 CCV STD  
 Misc : S25-09261201/S25-08301203  
 ALS Vial : 2 Sample Multiplier: 1

Quant Time: Sep 28 11:34:10 2012  
 Quant Method : J:\MS16\METHODS\R16071312.M  
 Quant Title : EPA TO-15 per SOP VOA-TO15 (CASS TO-15/GC-MS)  
 QLast Update : Mon Jul 16 09:59:54 2012  
 Response via : Initial Calibration

Min. RRF : 0.000 Min. Rel. Area : 50% Max. R.T. Dev 0.33min  
 Max. RRF Dev : 30% Max. Rel. Area : 200%

	Compound	AvgRF	CCRF	%Dev	Area%	Dev(min)
77 T	3-Ethyltoluene	2.995	2.687	10.3	103	0.00
78 T	4-Ethyltoluene	2.847	2.545	10.6	102	0.00
79 T	1,3,5-Trimethylbenzene	2.493	2.157	13.5	103	-0.01
80 T	alpha-Methylstyrene	1.311	0.993	24.3	83	-0.01
81 T	2-Ethyltoluene	3.154	2.704	14.3	102	-0.01
82 T	1,2,4-Trimethylbenzene	2.595	2.272	12.4	105	0.00
83 T	n-Decane	1.334	1.168	12.4	101	-0.01
84 T	Benzyl Chloride	1.934	1.992	-3.0	101	-0.01
85 T	1,3-Dichlorobenzene	1.557	1.395	10.4	102	-0.01
86 T	1,4-Dichlorobenzene	1.613	1.483	8.1	107	-0.01
87 T	sec-Butylbenzene	3.339	2.989	10.5	103	0.00
88 T	4-Isopropyltoluene (p-Cymen	3.300	3.004	9.0	103	0.00
89 T	1,2,3-Trimethylbenzene	2.539	2.314	8.9	104	0.00
90 T	1,2-Dichlorobenzene	1.503	1.382	8.1	104	-0.01
91 T	d-Limonene	0.915	0.691	24.5	83	0.00
92 T	1,2-Dibromo-3-Chloropropane	0.559	0.564	-0.9	104	0.00
93 T	n-Undecane	1.345	1.286	4.4	107	0.00
94 T	1,2,4-Trichlorobenzene	1.235	1.177	4.7	104	0.00
95 T	Naphthalene	3.967	3.603	9.2	103	0.00
96 T	n-Dodecane	1.274	1.233	3.2	100	0.00
97 T	Hexachlorobutadiene	0.837	0.754	9.9	104	0.00
98 T	Cyclohexanone	0.919	0.801	12.8	100	-0.01
99 T	tert-Butylbenzene	2.554	2.277	10.8	104	0.00
100 T	n-Butylbenzene	2.531	2.300	9.1	102	0.00

(#) = Out of Range

SPCC's out = 0 CCC's out = 0

Evaluate Continuing Calibration Report

Data Path : J:\MS16\DATA\2012\_10\01\  
 Data File : 10011201.D  
 Acq On : 1 Oct 2012 8:50  
 Operator : LH  
 Sample : 25ng TO-15 CCV STD  
 Misc : S25-09261201/S25-09211205  
 ALS Vial : 2 Sample Multiplier: 1

Quant Time: Oct 01 10:15:40 2012  
 Quant Method : J:\MS16\METHODS\R16071312.M  
 Quant Title : EPA TO-15 per SOP VOA-TO15 (CASS TO-15/GC-MS)  
 QLast Update : Mon Jul 16 09:59:54 2012  
 Response via : Initial Calibration

Min. RRF : 0.000 Min. Rel. Area : 50% Max. R.T. Dev 0.33min  
 Max. RRF Dev : 30% Max. Rel. Area : 200%

	Compound	AvgRF	CCRF	%Dev	Area%	Dev (min)
1	IR Bromochloromethane (IS1)	1.000	1.000	0.0	117	-0.02
2	T Propene	1.554	1.304	16.1	81	0.00
3	T Dichlorodifluoromethane (CF	2.347	2.128	9.3	100	0.00
4	T Chloromethane	1.646	1.469	10.8	99	-0.01
5	T 1,2-Dichloro-1,1,2,2-tetra	1.289	1.170	9.2	102	-0.01
6	T Vinyl Chloride	1.576	1.433	9.1	99	-0.02
7	T 1,3-Butadiene	1.101	1.062	3.5	101	-0.02
8	T Bromomethane	1.079	0.984	8.8	102	-0.02
9	T Chloroethane	0.776	0.683	12.0	98	-0.02
10	T Ethanol	0.853	0.689	19.2	96	-0.08
11	T Acetonitrile	1.763	1.447	17.9	92	-0.05
12	T Acrolein	0.579	0.502	13.3	94	-0.03
13	T Acetone	0.722	0.615	14.8	96	-0.05
14	T Trichlorofluoromethane	2.130	1.979	7.1	103	-0.01
15	T 2-Propanol (Isopropanol)	1.500	1.642	-9.5	126	-0.05
16	T Acrylonitrile	1.063	1.079	-1.5	93	-0.03
17	T 1,1-Dichloroethene	1.025	0.936	8.7	100	-0.02
18	T 2-Methyl-2-Propanol (tert-B	2.429	2.422	0.3	201#	-0.04
19	T Methylene Chloride	1.030	0.931	9.6	97	-0.02
20	T 3-Chloro-1-propene (Allyl C	1.559	1.337	14.2	92	-0.02
21	T Trichlorotrifluoroethane	1.107	0.983	11.2	100	-0.02
22	T Carbon Disulfide	4.044	3.597	11.1	100	-0.02
23	T trans-1,2-Dichloroethene	1.494	1.433	4.1	99	-0.02
24	T 1,1-Dichloroethane	1.979	1.739	12.1	98	-0.02
25	T Methyl tert-Butyl Ether	3.229	3.017	6.6	101	-0.02
26	T Vinyl Acetate	0.200	0.224	-12.0	102	-0.03
27	T 2-Butanone (MEK)	0.589	0.602	-2.2	102	-0.03
28	T cis-1,2-Dichloroethene	1.459	1.350	7.5	99	-0.02
29	T Diisopropyl Ether	0.841	0.755	10.2	100	-0.02
30	T Ethyl Acetate	0.354	0.352	0.6	98	-0.03
31	T n-Hexane	1.822	1.564	14.2	97	-0.02
32	T Chloroform	1.900	1.705	10.3	100	-0.03
33	S 1,2-Dichloroethane-d4 (SS1)	1.298	1.347	-3.8	121	-0.02
34	T Tetrahydrofuran (THF)	0.635	0.576	9.3	99	-0.02
35	T Ethyl tert-Butyl Ether	1.299	1.166	10.2	99	-0.02
36	T 1,2-Dichloroethane	1.442	1.369	5.1	103	-0.02
37	IR 1,4-Difluorobenzene (IS2)	1.000	1.000	0.0	118	-0.02
38	T 1,1,1-Trichloroethane	0.433	0.399	7.9	101	-0.01

en 10/1/12

Evaluate Continuing Calibration Report

Data Path : J:\MS16\DATA\2012\_10\01\  
 Data File : 10011201.D  
 Acq On : 1 Oct 2012 8:50  
 Operator : LH  
 Sample : 25ng TO-15 CCV STD  
 Misc : S25-09261201/S25-09211205  
 ALS Vial : 2 Sample Multiplier: 1

Quant Time: Oct 01 10:15:40 2012  
 Quant Method : J:\MS16\METHODS\R16071312.M  
 Quant Title : EPA TO-15 per SOP VOA-TO15 (CASS TO-15/GC-MS)  
 QLast Update : Mon Jul 16 09:59:54 2012  
 Response via : Initial Calibration

Min. RRF : 0.000 Min. Rel. Area : 50% Max. R.T. Dev 0.33min  
 Max. RRF Dev : 30% Max. Rel. Area : 200%

	Compound	AvgRF	CCRF	%Dev	Area%	Dev (min)
39 T	Isopropyl Acetate	0.159	0.143	10.1	96	-0.02
40 T	1-Butanol	0.244	0.236	3.3	98	-0.05
41 T	Benzene	1.081	0.884	18.2	98	-0.01
42 T	Carbon Tetrachloride	0.353	0.352	0.3	104	-0.02
43 T	Cyclohexane	0.407	0.360	11.5	99	-0.02
44 T	tert-Amyl Methyl Ether	0.778	0.722	7.2	100	-0.01
45 T	1,2-Dichloropropane	0.271	0.236	12.9	96	-0.02
46 T	Bromodichloromethane	0.362	0.347	4.1	101	-0.02
47 T	Trichloroethene	0.318	0.293	7.9	97	-0.02
48 T	1,4-Dioxane	0.212	0.193	9.0	98	-0.02
49 T	2,2,4-Trimethylpentane (Iso	1.136	0.975	14.2	95	-0.01
50 T	Methyl Methacrylate	0.114	0.107	6.1	98	-0.02
51 T	n-Heptane	0.262	0.237	9.5	100	-0.02
52 T	cis-1,3-Dichloropropene	0.414	0.428	-3.4	103	-0.01
53 T	4-Methyl-2-pentanone	0.240	0.227	5.4	99	-0.01
54 T	trans-1,3-Dichloropropene	0.365	0.375	-2.7	97	-0.01
55 T	1,1,2-Trichloroethane	0.274	0.246	10.2	98	-0.01
56 IR	Chlorobenzene-d5 (IS3)	1.000	1.000	0.0	119	0.00
57 S	Toluene-d8 (SS2)	2.309	2.277	1.4	118	-0.01
58 T	Toluene	2.621	2.207	15.8	97	-0.01
59 T	2-Hexanone	1.255	1.107	11.8	95	-0.02
60 T	Dibromochloromethane	0.720	0.698	3.1	100	-0.01
61 T	1,2-Dibromoethane	0.713	0.652	8.6	97	-0.01
62 T	n-Butyl Acetate	1.477	1.368	7.4	97	-0.01
63 T	n-Octane	0.538	0.450	16.4	94	-0.01
64 T	Tetrachloroethene	0.921	0.808	12.3	99	0.00
65 T	Chlorobenzene	1.749	1.546	11.6	99	-0.01
66 T	Ethylbenzene	2.964	2.576	13.1	99	0.00
67 T	m- & p-Xylenes	2.340	2.032	13.2	99	-0.01
68 T	Bromoform	0.706	0.716	-1.4	101	-0.01
69 T	Styrene	1.761	1.584	10.1	97	-0.01
70 T	o-Xylene	2.460	2.121	13.8	98	-0.01
71 T	n-Nonane	1.313	1.092	16.8	94	-0.01
72 T	1,1,2,2-Tetrachloroethane	1.147	1.028	10.4	98	-0.01
73 S	Bromofluorobenzene (SS3)	1.191	1.262	-6.0	127	0.00
74 T	Cumene	3.298	2.767	16.1	98	0.00
75 T	alpha-Pinene	1.541	1.338	13.2	97	0.00
76 T	n-Propylbenzene	3.803	3.326	12.5	99	0.00

*UH 10/1/12*

Evaluate Continuing Calibration Report

Data Path : J:\MS16\DATA\2012\_10\01\  
 Data File : 10011201.D  
 Acq On : 1 Oct 2012 8:50  
 Operator : LH  
 Sample : 25ng TO-15 CCV STD  
 Misc : S25-09261201/S25-09211205  
 ALS Vial : 2 Sample Multiplier: 1

Quant Time: Oct 01 10:15:40 2012  
 Quant Method : J:\MS16\METHODS\R16071312.M  
 Quant Title : EPA TO-15 per SOP VOA-TO15 (CASS TO-15/GC-MS)  
 QLast Update : Mon Jul 16 09:59:54 2012  
 Response via : Initial Calibration

Min. RRF : 0.000 Min. Rel. Area : 50% Max. R.T. Dev 0.33min  
 Max. RRF Dev : 30% Max. Rel. Area : 200%

	Compound	AvgRF	CCRF	%Dev	Area%	Dev(min)
77 T	3-Ethyltoluene	2.995	2.709	9.5	100	0.00
78 T	4-Ethyltoluene	2.847	2.478	13.0	95	0.00
79 T	1,3,5-Trimethylbenzene	2.493	2.130	14.6	98	-0.01
80 T	alpha-Methylstyrene	1.311	1.192	9.1	96	-0.01
81 T	2-Ethyltoluene	3.154	2.694	14.6	98	0.00
82 T	1,2,4-Trimethylbenzene	2.595	2.257	13.0	100	-0.01
83 T	n-Decane	1.334	1.153	13.6	96	-0.01
84 T	Benzyl Chloride	1.934	1.991	-2.9	97	-0.01
85 T	1,3-Dichlorobenzene	1.557	1.403	9.9	99	-0.01
86 T	1,4-Dichlorobenzene	1.613	1.417	12.2	99	-0.01
87 T	sec-Butylbenzene	3.339	2.995	10.3	100	0.00
88 T	4-Isopropyltoluene (p-Cymen	3.300	3.006	8.9	100	0.00
89 T	1,2,3-Trimethylbenzene	2.539	2.303	9.3	100	0.00
90 T	1,2-Dichlorobenzene	1.503	1.359	9.6	99	-0.01
91 T	d-Limonene	0.915	0.828	9.5	97	-0.01
92 T	1,2-Dibromo-3-Chloropropane	0.559	0.549	1.8	98	0.00
93 T	n-Undecane	1.345	1.182	12.1	95	0.00
94 T	1,2,4-Trichlorobenzene	1.235	1.150	6.9	98	0.00
95 T	Naphthalene	3.967	3.554	10.4	98	0.00
96 T	n-Dodecane	1.274	1.215	4.6	95	0.00
97 T	Hexachlorobutadiene	0.837	0.758	9.4	101	0.00
98 T	Cyclohexanone	0.919	0.807	12.2	97	-0.01
99 T	tert-Butylbenzene	2.554	2.266	11.3	100	0.00
100 T	n-Butylbenzene	2.531	2.304	9.0	99	0.00

(#) = Out of Range

SPCC's out = 0 CCC's out = 0

*LH 10/1/12*



RESULTS OF ANALYSIS

Page 1 of 3

**Client:** GSI Environmental Inc.

**Client Sample ID:** Indoor-1-PP

**Client Project ID:** ESTCP CSIA / OSA Demonstration / 3585/3669

CAS Project ID: P1203938

CAS Sample ID: P1203938-007

Test Code: EPA TO-15

Date Collected: 9/19/12

Instrument ID: Tekmar AUTOCAN/Agilent 5975Cinert/6890N/MS16

Date Received: 9/26/12

Analyst: Lusine Hakobyan

Date Analyzed: 10/9/12

Sampling Media: 6.0 L Summa Canister

Volume(s) Analyzed: 0.25 Liter(s)

Test Notes:

Container ID: AC00376

Initial Pressure (psig): -0.05 Final Pressure (psig): 3.51

Canister Dilution Factor: 1.24

CAS #	Compound	Result µg/m <sup>3</sup>	MRL µg/m <sup>3</sup>	Result ppbV	MRL ppbV	Data Qualifier
115-07-1	Propene	3.4	2.5	2.0	1.4	
75-71-8	Dichlorodifluoromethane (CFC 12)	ND	2.5	ND	0.50	
74-87-3	Chloromethane	ND	0.99	ND	0.48	
76-14-2	1,2-Dichloro-1,1,2,2-tetrafluoroethane (CFC 114)	ND	2.5	ND	0.35	
75-01-4	Vinyl Chloride	ND	0.50	ND	0.19	
106-99-0	1,3-Butadiene	ND	0.99	ND	0.45	
74-83-9	Bromomethane	ND	0.50	ND	0.13	
75-00-3	Chloroethane	ND	0.50	ND	0.19	
64-17-5	Ethanol	25	25	13	13	
75-05-8	Acetonitrile	ND	2.5	ND	1.5	
107-02-8	Acrolein	ND	9.9	ND	4.3	
67-64-1	Acetone	18,000	25	7,600	10	E
75-69-4	Trichlorofluoromethane	1.2	0.50	0.22	0.088	
67-63-0	2-Propanol (Isopropyl Alcohol)	ND	25	ND	10	
107-13-1	Acrylonitrile	ND	2.5	ND	1.1	
75-35-4	1,1-Dichloroethene	ND	0.50	ND	0.13	
75-09-2	Methylene Chloride	9.7	2.5	2.8	0.71	
107-05-1	3-Chloro-1-propene (Allyl Chloride)	ND	0.50	ND	0.16	
76-13-1	Trichlorotrifluoroethane	ND	0.50	ND	0.065	
75-15-0	Carbon Disulfide	ND	25	ND	8.0	
156-60-5	trans-1,2-Dichloroethene	ND	0.50	ND	0.13	
75-34-3	1,1-Dichloroethane	ND	0.50	ND	0.12	
1634-04-4	Methyl tert-Butyl Ether	ND	0.50	ND	0.14	
108-05-4	Vinyl Acetate	ND	25	ND	7.0	
78-93-3	2-Butanone (MEK)	ND	25	ND	8.4	

ND = Compound was analyzed for, but not detected above the laboratory reporting limit.

MRL = Method Reporting Limit - The minimum quantity of a target analyte that can be confidently determined by the referenced method.

E = Estimated; concentration exceeded calibration range.

RESULTS OF ANALYSIS

Page 2 of 3

**Client:** GSI Environmental Inc.

**Client Sample ID:** Indoor-1-PP

**Client Project ID:** ESTCP CSIA / OSA Demonstration / 3585/3669

CAS Project ID: P1203938

CAS Sample ID: P1203938-007

Test Code: EPA TO-15

Date Collected: 9/19/12

Instrument ID: Tekmar AUTOCAN/Agilent 5975Cinert/6890N/MS16

Date Received: 9/26/12

Analyst: Lusine Hakobyan

Date Analyzed: 10/9/12

Sampling Media: 6.0 L Summa Canister

Volume(s) Analyzed: 0.25 Liter(s)

Test Notes:

Container ID: AC00376

Initial Pressure (psig): -0.05 Final Pressure (psig): 3.51

Canister Dilution Factor: 1.24

CAS #	Compound	Result µg/m <sup>3</sup>	MRL µg/m <sup>3</sup>	Result ppbV	MRL ppbV	Data Qualifier
156-59-2	cis-1,2-Dichloroethene	ND	0.50	ND	0.13	
141-78-6	Ethyl Acetate	ND	5.0	ND	1.4	
110-54-3	n-Hexane	<b>10</b>	2.5	<b>2.9</b>	0.70	
67-66-3	Chloroform	ND	0.50	ND	0.10	
109-99-9	Tetrahydrofuran (THF)	ND	2.5	ND	0.84	
107-06-2	1,2-Dichloroethane	ND	0.50	ND	0.12	
71-55-6	1,1,1-Trichloroethane	ND	0.50	ND	0.091	
71-43-2	Benzene	<b>5.3</b>	0.50	<b>1.7</b>	0.16	
56-23-5	Carbon Tetrachloride	ND	0.50	ND	0.079	
110-82-7	Cyclohexane	<b>27</b>	5.0	<b>7.8</b>	1.4	
78-87-5	1,2-Dichloropropane	ND	0.50	ND	0.11	
75-27-4	Bromodichloromethane	ND	0.50	ND	0.074	
79-01-6	Trichloroethene	<b>54</b>	0.50	<b>10</b>	0.092	
123-91-1	1,4-Dioxane	ND	2.5	ND	0.69	
80-62-6	Methyl Methacrylate	ND	5.0	ND	1.2	
142-82-5	n-Heptane	<b>1,800</b>	2.5	<b>440</b>	0.61	<b>E</b>
10061-01-5	cis-1,3-Dichloropropene	ND	2.5	ND	0.55	
108-10-1	4-Methyl-2-pentanone	<b>6.0</b>	2.5	<b>1.5</b>	0.61	
10061-02-6	trans-1,3-Dichloropropene	ND	2.5	ND	0.55	
79-00-5	1,1,2-Trichloroethane	ND	0.50	ND	0.091	
108-88-3	Toluene	<b>18</b>	2.5	<b>4.8</b>	0.66	
591-78-6	2-Hexanone	ND	2.5	ND	0.61	
124-48-1	Dibromochloromethane	ND	0.50	ND	0.058	
106-93-4	1,2-Dibromoethane	ND	0.50	ND	0.065	
123-86-4	n-Butyl Acetate	ND	2.5	ND	0.52	

ND = Compound was analyzed for, but not detected above the laboratory reporting limit.

MRL = Method Reporting Limit - The minimum quantity of a target analyte that can be confidently determined by the referenced method.

E = Estimated; concentration exceeded calibration range.

RESULTS OF ANALYSIS

Page 3 of 3

**Client:** GSI Environmental Inc.  
**Client Sample ID:** Indoor-1-PP  
**Client Project ID:** ESTCP CSIA / OSA Demonstration / 3585/3669

CAS Project ID: P1203938  
 CAS Sample ID: P1203938-007

Test Code: EPA TO-15  
 Instrument ID: Tekmar AUTOCAN/Agilent 5975Cinert/6890N/MS16  
 Analyst: Lusine Hakobyan  
 Sampling Media: 6.0 L Summa Canister  
 Test Notes:  
 Container ID: AC00376

Date Collected: 9/19/12  
 Date Received: 9/26/12  
 Date Analyzed: 10/9/12  
 Volume(s) Analyzed: 0.25 Liter(s)

Initial Pressure (psig): -0.05 Final Pressure (psig): 3.51

Canister Dilution Factor: 1.24

CAS #	Compound	Result µg/m <sup>3</sup>	MRL µg/m <sup>3</sup>	Result ppbV	MRL ppbV	Data Qualifier
111-65-9	n-Octane	ND	2.5	ND	0.53	
127-18-4	Tetrachloroethene	<b>0.57</b>	0.50	<b>0.084</b>	0.073	
108-90-7	Chlorobenzene	ND	0.50	ND	0.11	
100-41-4	Ethylbenzene	<b>6.0</b>	2.5	<b>1.4</b>	0.57	
179601-23-1	m,p-Xylenes	<b>21</b>	2.5	<b>4.9</b>	0.57	
75-25-2	Bromoform	ND	2.5	ND	0.24	
100-42-5	Styrene	ND	2.5	ND	0.58	
95-47-6	o-Xylene	<b>8.2</b>	2.5	<b>1.9</b>	0.57	
111-84-2	n-Nonane	<b>3.7</b>	2.5	<b>0.71</b>	0.47	
79-34-5	1,1,2,2-Tetrachloroethane	ND	0.50	ND	0.072	
98-82-8	Cumene	ND	2.5	ND	0.50	
80-56-8	alpha-Pinene	ND	2.5	ND	0.45	
103-65-1	n-Propylbenzene	ND	2.5	ND	0.50	
622-96-8	4-Ethyltoluene	<b>3.3</b>	2.5	<b>0.67</b>	0.50	
108-67-8	1,3,5-Trimethylbenzene	<b>3.8</b>	2.5	<b>0.77</b>	0.50	
95-63-6	1,2,4-Trimethylbenzene	<b>13</b>	2.5	<b>2.7</b>	0.50	
100-44-7	Benzyl Chloride	ND	2.5	ND	0.48	
541-73-1	1,3-Dichlorobenzene	ND	0.50	ND	0.083	
106-46-7	1,4-Dichlorobenzene	ND	0.50	ND	0.083	
95-50-1	1,2-Dichlorobenzene	ND	0.50	ND	0.083	
5989-27-5	d-Limonene	<b>19</b>	2.5	<b>3.5</b>	0.45	
96-12-8	1,2-Dibromo-3-chloropropane	ND	2.5	ND	0.26	
120-82-1	1,2,4-Trichlorobenzene	ND	2.5	ND	0.33	
91-20-3	Naphthalene	<b>2.7</b>	2.5	<b>0.51</b>	0.47	
87-68-3	Hexachlorobutadiene	ND	2.5	ND	0.23	

ND = Compound was analyzed for, but not detected above the laboratory reporting limit.

MRL = Method Reporting Limit - The minimum quantity of a target analyte that can be confidently determined by the referenced method.

RESULTS OF ANALYSIS

Page 1 of 3

**Client:** GSI Environmental Inc.  
**Client Sample ID:** Method Blank  
**Client Project ID:** ESTCP CSIA / OSA Demonstration / 3585/3669

CAS Project ID: P1203938  
CAS Sample ID: P121009-MB

Test Code: EPA TO-15  
Instrument ID: Tekmar AUTOCAN/Agilent 5975Cinert/6890N/MS16  
Analyst: Lusine Hakobyan  
Sampling Media: 6.0 L Summa Canister  
Test Notes:

Date Collected: NA  
Date Received: NA  
Date Analyzed: 10/9/12  
Volume(s) Analyzed: 1.00 Liter(s)

Canister Dilution Factor: 1.00

CAS #	Compound	Result	MRL	Result	MRL	Data Qualifier
		µg/m <sup>3</sup>	µg/m <sup>3</sup>	ppbV	ppbV	
115-07-1	Propene	ND	0.50	ND	0.29	
75-71-8	Dichlorodifluoromethane (CFC 12)	ND	0.50	ND	0.10	
74-87-3	Chloromethane	ND	0.20	ND	0.097	
76-14-2	1,2-Dichloro-1,1,2,2-tetrafluoroethane (CFC 114)	ND	0.50	ND	0.072	
75-01-4	Vinyl Chloride	ND	0.10	ND	0.039	
106-99-0	1,3-Butadiene	ND	0.20	ND	0.090	
74-83-9	Bromomethane	ND	0.10	ND	0.026	
75-00-3	Chloroethane	ND	0.10	ND	0.038	
64-17-5	Ethanol	ND	5.0	ND	2.7	
75-05-8	Acetonitrile	ND	0.50	ND	0.30	
107-02-8	Acrolein	ND	2.0	ND	0.87	
67-64-1	Acetone	ND	5.0	ND	2.1	
75-69-4	Trichlorofluoromethane	ND	0.10	ND	0.018	
67-63-0	2-Propanol (Isopropyl Alcohol)	ND	5.0	ND	2.0	
107-13-1	Acrylonitrile	ND	0.50	ND	0.23	
75-35-4	1,1-Dichloroethene	ND	0.10	ND	0.025	
75-09-2	Methylene Chloride	ND	0.50	ND	0.14	
107-05-1	3-Chloro-1-propene (Allyl Chloride)	ND	0.10	ND	0.032	
76-13-1	Trichlorotrifluoroethane	ND	0.10	ND	0.013	
75-15-0	Carbon Disulfide	ND	5.0	ND	1.6	
156-60-5	trans-1,2-Dichloroethene	ND	0.10	ND	0.025	
75-34-3	1,1-Dichloroethane	ND	0.10	ND	0.025	
1634-04-4	Methyl tert-Butyl Ether	ND	0.10	ND	0.028	
108-05-4	Vinyl Acetate	ND	5.0	ND	1.4	
78-93-3	2-Butanone (MEK)	ND	5.0	ND	1.7	

ND = Compound was analyzed for, but not detected above the laboratory reporting limit.

MRL = Method Reporting Limit - The minimum quantity of a target analyte that can be confidently determined by the referenced method.

RESULTS OF ANALYSIS

Page 2 of 3

**Client:** GSI Environmental Inc.  
**Client Sample ID:** Method Blank  
**Client Project ID:** ESTCP CSIA / OSA Demonstration / 3585/3669

CAS Project ID: P1203938  
 CAS Sample ID: P121009-MB

Test Code: EPA TO-15  
 Instrument ID: Tekmar AUTOCAN/Agilent 5975Cinert/6890N/MS16  
 Analyst: Lusine Hakobyan  
 Sampling Media: 6.0 L Summa Canister  
 Test Notes:

Date Collected: NA  
 Date Received: NA  
 Date Analyzed: 10/9/12  
 Volume(s) Analyzed: 1.00 Liter(s)

Canister Dilution Factor: 1.00

CAS #	Compound	Result µg/m <sup>3</sup>	MRL µg/m <sup>3</sup>	Result ppbV	MRL ppbV	Data Qualifier
156-59-2	cis-1,2-Dichloroethene	ND	0.10	ND	0.025	
141-78-6	Ethyl Acetate	ND	1.0	ND	0.28	
110-54-3	n-Hexane	ND	0.50	ND	0.14	
67-66-3	Chloroform	ND	0.10	ND	0.020	
109-99-9	Tetrahydrofuran (THF)	ND	0.50	ND	0.17	
107-06-2	1,2-Dichloroethane	ND	0.10	ND	0.025	
71-55-6	1,1,1-Trichloroethane	ND	0.10	ND	0.018	
71-43-2	Benzene	ND	0.10	ND	0.031	
56-23-5	Carbon Tetrachloride	ND	0.10	ND	0.016	
110-82-7	Cyclohexane	ND	1.0	ND	0.29	
78-87-5	1,2-Dichloropropane	ND	0.10	ND	0.022	
75-27-4	Bromodichloromethane	ND	0.10	ND	0.015	
79-01-6	Trichloroethene	ND	0.10	ND	0.019	
123-91-1	1,4-Dioxane	ND	0.50	ND	0.14	
80-62-6	Methyl Methacrylate	ND	1.0	ND	0.24	
142-82-5	n-Heptane	ND	0.50	ND	0.12	
10061-01-5	cis-1,3-Dichloropropene	ND	0.50	ND	0.11	
108-10-1	4-Methyl-2-pentanone	ND	0.50	ND	0.12	
10061-02-6	trans-1,3-Dichloropropene	ND	0.50	ND	0.11	
79-00-5	1,1,2-Trichloroethane	ND	0.10	ND	0.018	
108-88-3	Toluene	ND	0.50	ND	0.13	
591-78-6	2-Hexanone	ND	0.50	ND	0.12	
124-48-1	Dibromochloromethane	ND	0.10	ND	0.012	
106-93-4	1,2-Dibromoethane	ND	0.10	ND	0.013	
123-86-4	n-Butyl Acetate	ND	0.50	ND	0.11	

ND = Compound was analyzed for, but not detected above the laboratory reporting limit.

MRL = Method Reporting Limit - The minimum quantity of a target analyte that can be confidently determined by the referenced method.

RESULTS OF ANALYSIS

Page 3 of 3

**Client:** GSI Environmental Inc.  
**Client Sample ID:** Method Blank  
**Client Project ID:** ESTCP CSIA / OSA Demonstration / 3585/3669

CAS Project ID: P1203938  
 CAS Sample ID: P121009-MB

Test Code: EPA TO-15  
 Instrument ID: Tekmar AUTOCAN/Agilent 5975Cinert/6890N/MS16  
 Analyst: Lusine Hakobyan  
 Sampling Media: 6.0 L Summa Canister  
 Test Notes:

Date Collected: NA  
 Date Received: NA  
 Date Analyzed: 10/9/12  
 Volume(s) Analyzed: 1.00 Liter(s)

Canister Dilution Factor: 1.00

CAS #	Compound	Result µg/m <sup>3</sup>	MRL µg/m <sup>3</sup>	Result ppbV	MRL ppbV	Data Qualifier
111-65-9	n-Octane	ND	0.50	ND	0.11	
127-18-4	Tetrachloroethene	ND	0.10	ND	0.015	
108-90-7	Chlorobenzene	ND	0.10	ND	0.022	
100-41-4	Ethylbenzene	ND	0.50	ND	0.12	
179601-23-1	m,p-Xylenes	ND	0.50	ND	0.12	
75-25-2	Bromoform	ND	0.50	ND	0.048	
100-42-5	Styrene	ND	0.50	ND	0.12	
95-47-6	o-Xylene	ND	0.50	ND	0.12	
111-84-2	n-Nonane	ND	0.50	ND	0.095	
79-34-5	1,1,2,2-Tetrachloroethane	ND	0.10	ND	0.015	
98-82-8	Cumene	ND	0.50	ND	0.10	
80-56-8	alpha-Pinene	ND	0.50	ND	0.090	
103-65-1	n-Propylbenzene	ND	0.50	ND	0.10	
622-96-8	4-Ethyltoluene	ND	0.50	ND	0.10	
108-67-8	1,3,5-Trimethylbenzene	ND	0.50	ND	0.10	
95-63-6	1,2,4-Trimethylbenzene	ND	0.50	ND	0.10	
100-44-7	Benzyl Chloride	ND	0.50	ND	0.097	
541-73-1	1,3-Dichlorobenzene	ND	0.10	ND	0.017	
106-46-7	1,4-Dichlorobenzene	ND	0.10	ND	0.017	
95-50-1	1,2-Dichlorobenzene	ND	0.10	ND	0.017	
5989-27-5	d-Limonene	ND	0.50	ND	0.090	
96-12-8	1,2-Dibromo-3-chloropropane	ND	0.50	ND	0.052	
120-82-1	1,2,4-Trichlorobenzene	ND	0.50	ND	0.067	
91-20-3	Naphthalene	ND	0.50	ND	0.095	
87-68-3	Hexachlorobutadiene	ND	0.50	ND	0.047	

ND = Compound was analyzed for, but not detected above the laboratory reporting limit.

MRL = Method Reporting Limit - The minimum quantity of a target analyte that can be confidently determined by the referenced method.

SURROGATE SPIKE RECOVERY RESULTS

Page 1 of 1

**Client:** GSI Environmental Inc.  
**Client Project ID:** ESTCP CSIA / OSA Demonstration / 3585/3669

CAS Project ID: P1203938

Test Code: EPA TO-15  
 Instrument ID: Tekmar AUTOCAN/Agilent 5975Cinert/6890N/MS16  
 Analyst: Lusine Hakobyan  
 Sampling Media: 6.0 L Summa Canister(s)  
 Test Notes:

Date(s) Collected: 9/18 - 9/19/12  
 Date(s) Received: 9/25 - 9/26/12  
 Date(s) Analyzed: 9/28 - 10/9/12

Client Sample ID	CAS Sample ID	1,2-Dichloroethane-d4	Toluene-d8	Bromofluorobenzene	Acceptance Limits	Data Qualifier
		Percent Recovered	Percent Recovered	Percent Recovered		
Method Blank	P120928-MB	103	96	102	70-130	
Method Blank	P121001-MB	105	101	104	70-130	
Method Blank	P121009-MB	111	101	107	70-130	
Lab Control Sample	P120928-LCS	109	105	101	70-130	
Lab Control Sample	P121001-LCS	102	90	95	70-130	
Lab Control Sample	P121009-LCS	102	91	102	70-130	
Indoor-C1	P1203938-001	102	97	111	70-130	
Outdoor-C1	P1203938-002	107	95	106	70-130	
SS-1C	P1203938-003	97	95	104	70-130	
SS-2C	P1203938-004	98	96	103	70-130	
SS-2C	P1203938-004DUP	106	95	105	70-130	
SS-3C	P1203938-005	105	96	103	70-130	
Indoor-1-BL	P1203938-006	104	98	100	70-130	
Indoor-1-PP	P1203938-007	110	93	99	70-130	
Indoor-1-NP	P1203938-008	111	97	104	70-130	
Dup 1	P1203938-009	99	99	104	70-130	

Surrogate percent recovery is verified and accepted based on the on-column result.

Reported results are shown in concentration units and as a result of the calculation, may vary slightly from the on-column percent recovery.

LABORATORY CONTROL SAMPLE SUMMARY

Page 1 of 3

**Client:** GSI Environmental Inc.

**Client Sample ID:** Lab Control Sample

**Client Project ID:** ESTCP CSIA / OSA Demonstration / 3585/3669

CAS Project ID: P1203938

CAS Sample ID: P121009-LCS

Test Code: EPA TO-15

Date Collected: NA

Instrument ID: Tekmar AUTOCAN/Agilent 5975Cinert/6890N/MS16

Date Received: NA

Analyst: Lusine Hakobyan

Date Analyzed: 10/09/12

Sampling Media: 6.0 L Summa Canister

Volume(s) Analyzed: 0.125 Liter(s)

Test Notes:

CAS #	Compound	Spike Amount µg/m <sup>3</sup>	Result µg/m <sup>3</sup>	% Recovery	CAS	Data Qualifier
					Acceptance Limits	
115-07-1	Propene	204	173	85	59-137	
75-71-8	Dichlorodifluoromethane (CFC 12)	202	172	85	63-115	
74-87-3	Chloromethane	196	153	78	59-124	
76-14-2	1,2-Dichloro-1,1,2,2-tetrafluoroethane (CFC 114)	206	173	84	65-113	
75-01-4	Vinyl Chloride	200	161	81	59-121	
106-99-0	1,3-Butadiene	210	182	87	60-138	
74-83-9	Bromomethane	200	166	83	69-129	
75-00-3	Chloroethane	202	158	78	60-120	
64-17-5	Ethanol	958	725	76	58-121	
75-05-8	Acetonitrile	202	167	83	64-129	
107-02-8	Acrolein	204	158	77	54-127	
67-64-1	Acetone	1,040	805	77	59-114	
75-69-4	Trichlorofluoromethane	210	173	82	66-108	
67-63-0	2-Propanol (Isopropyl Alcohol)	396	307	78	50-113	
107-13-1	Acrylonitrile	206	206	100	72-135	
75-35-4	1,1-Dichloroethene	218	181	83	70-117	
75-09-2	Methylene Chloride	212	180	85	61-108	
107-05-1	3-Chloro-1-propene (Allyl Chloride)	214	170	79	70-131	
76-13-1	Trichlorotrifluoroethane	212	178	84	70-113	
75-15-0	Carbon Disulfide	208	160	77	65-112	
156-60-5	trans-1,2-Dichloroethene	202	184	91	71-119	
75-34-3	1,1-Dichloroethane	206	170	83	71-116	
1634-04-4	Methyl tert-Butyl Ether	204	180	88	67-116	
108-05-4	Vinyl Acetate	988	1010	102	59-142	
78-93-3	2-Butanone (MEK)	212	202	95	68-125	

Laboratory Control Sample percent recovery is verified and accepted based on the on-column result. Reported results are shown in concentration units and as a result of the calculation, may vary slightly.



## LABORATORY CONTROL SAMPLE SUMMARY

Page 2 of 3

**Client:** GSI Environmental Inc.

**Client Sample ID:** Lab Control Sample

**Client Project ID:** ESTCP CSIA / OSA Demonstration / 3585/3669

CAS Project ID: P1203938

CAS Sample ID: P121009-LCS

**Test Code:** EPA TO-15

Date Collected: NA

**Instrument ID:** Tekmar AUTOCAN/Agilent 5975Cinert/6890N/MS16

Date Received: NA

**Analyst:** Lusine Hakobyan

Date Analyzed: 10/09/12

**Sampling Media:** 6.0 L Summa Canister

Volume(s) Analyzed: 0.125 Liter(s)

**Test Notes:**

CAS #	Compound	Spike Amount µg/m <sup>3</sup>	Result µg/m <sup>3</sup>	% Recovery	CAS	Data Qualifier
					Acceptance Limits	
156-59-2	cis-1,2-Dichloroethene	214	191	89	69-119	
141-78-6	Ethyl Acetate	412	384	93	63-130	
110-54-3	n-Hexane	206	167	81	57-120	
67-66-3	Chloroform	222	189	85	69-111	
109-99-9	Tetrahydrofuran (THF)	208	179	86	57-123	
107-06-2	1,2-Dichloroethane	208	191	92	70-118	
71-55-6	1,1,1-Trichloroethane	204	195	96	73-119	
71-43-2	Benzene	208	170	82	66-121	
56-23-5	Carbon Tetrachloride	212	213	100	74-129	
110-82-7	Cyclohexane	402	341	85	70-113	
78-87-5	1,2-Dichloropropane	204	173	85	69-118	
75-27-4	Bromodichloromethane	204	201	99	75-124	
79-01-6	Trichloroethene	198	197	99	73-115	
123-91-1	1,4-Dioxane	206	191	93	71-123	
80-62-6	Methyl Methacrylate	414	380	92	72-127	
142-82-5	n-Heptane	202	175	87	68-120	
10061-01-5	cis-1,3-Dichloropropene	196	190	97	71-130	
108-10-1	4-Methyl-2-pentanone	210	188	90	69-130	
10061-02-6	trans-1,3-Dichloropropene	218	228	105	76-133	
79-00-5	1,1,2-Trichloroethane	202	184	91	73-120	
108-88-3	Toluene	208	160	77	67-111	
591-78-6	2-Hexanone	228	186	82	70-123	
124-48-1	Dibromochloromethane	216	193	89	75-129	
106-93-4	1,2-Dibromoethane	208	173	83	73-122	
123-86-4	n-Butyl Acetate	228	191	84	68-132	

Laboratory Control Sample percent recovery is verified and accepted based on the on-column result. Reported results are shown in concentration units and as a result of the calculation, may vary slightly.

LABORATORY CONTROL SAMPLE SUMMARY

Page 3 of 3

**Client:** GSI Environmental Inc.

**Client Sample ID:** Lab Control Sample

**Client Project ID:** ESTCP CSIA / OSA Demonstration / 3585/3669

CAS Project ID: P1203938

CAS Sample ID: P121009-LCS

Test Code: EPA TO-15

Date Collected: NA

Instrument ID: Tekmar AUTOCAN/Agilent 5975Cinert/6890N/MS16

Date Received: NA

Analyst: Lusine Hakobyan

Date Analyzed: 10/09/12

Sampling Media: 6.0 L Summa Canister

Volume(s) Analyzed: 0.125 Liter(s)

Test Notes:

CAS #	Compound	Spike Amount µg/m <sup>3</sup>	Result µg/m <sup>3</sup>	% Recovery	CAS	Data Qualifier
					Acceptance Limits	
111-65-9	n-Octane	206	156	76	68-116	
127-18-4	Tetrachloroethene	190	154	81	67-119	
108-90-7	Chlorobenzene	208	177	85	69-113	
100-41-4	Ethylbenzene	206	171	83	71-117	
179601-23-1	m,p-Xylenes	412	337	82	70-116	
75-25-2	Bromoform	216	198	92	69-127	
100-42-5	Styrene	208	173	83	71-125	
95-47-6	o-Xylene	200	160	80	70-116	
111-84-2	n-Nonane	202	152	75	68-116	
79-34-5	1,1,2,2-Tetrachloroethane	198	155	78	70-119	
98-82-8	Cumene	196	159	81	70-116	
80-56-8	alpha-Pinene	192	158	82	71-119	
103-65-1	n-Propylbenzene	198	163	82	71-119	
622-96-8	4-Ethyltoluene	204	170	83	71-119	
108-67-8	1,3,5-Trimethylbenzene	208	170	82	71-121	
95-63-6	1,2,4-Trimethylbenzene	200	169	85	73-127	
100-44-7	Benzyl Chloride	206	190	92	65-137	
541-73-1	1,3-Dichlorobenzene	206	176	85	68-123	
106-46-7	1,4-Dichlorobenzene	212	172	81	65-120	
95-50-1	1,2-Dichlorobenzene	204	174	85	67-121	
5989-27-5	d-Limonene	206	182	88	67-130	
96-12-8	1,2-Dibromo-3-chloropropane	202	177	88	72-133	
120-82-1	1,2,4-Trichlorobenzene	200	172	86	62-133	
91-20-3	Naphthalene	178	146	82	56-138	
87-68-3	Hexachlorobutadiene	208	174	84	60-128	

Laboratory Control Sample percent recovery is verified and accepted based on the on-column result. Reported results are shown in concentration units and as a result of the calculation, may vary slightly.

RESULTS OF ANALYSIS

Page 1 of 1

**Client:** GSI Environmental Inc. CAS Project ID: P1203938  
**Client Project ID:** ESTCP CSIA / OSA Demonstration / 3585/3669

**Method Blank Summary**

Test Code: EPA TO-15  
Instrument ID: Tekmar AUTOCAN/Agilent 5975Cinert/6890N/MS16 Lab File ID: 10091205.D  
Analyst: Lusine Hakobyan Date Analyzed: 10/09/12  
Sampling Media: 6.0 L Summa Canister(s) Time Analyzed: 10:48  
Test Notes:

Client Sample ID	CAS Sample ID	Lab File ID	Time Analyzed
Lab Control Sample	P121009-LCS	10091207.D	12:18
Indoor-1-PP	P1203938-007	10091227.D	23:35

RESULTS OF ANALYSIS

Page 1 of 1

**Client:** GSI Environmental Inc.  
**Client Project ID:** ESTCP CSIA / OSA Demonstration / 3585/3669

CAS Project ID: P1203938

**Internal Standard Area and RT Summary**

Test Code: EPA TO-15  
 Instrument ID: Tekmar AUTOCAN/Agilent 5975Cinert/6890N/MS16  
 Analyst: Lusine Hakobyan  
 Sampling Media: 6.0 L Summa Canister(s)  
 Test Notes:

Lab File ID: 10091201.D  
 Date Analyzed: 10/9/12  
 Time Analyzed: 08:35

	IS1 (BCM)		IS2 (DFB)		IS3 (CBZ)	
	AREA #	RT #	AREA #	RT #	AREA #	RT #
<b>24 Hour Standard</b>	157971	11.31	619977	13.51	294172	17.46
<b>Upper Limit</b>	221159	11.64	867968	13.84	411841	17.79
<b>Lower Limit</b>	94783	10.98	371986	13.18	176503	17.13

Client Sample ID		IS1 (BCM)		IS2 (DFB)		IS3 (CBZ)	
		AREA #	RT #	AREA #	RT #	AREA #	RT #
01	Method Blank	146180	11.29	608230	13.51	277467	17.46
02	Lab Control Sample	162919	11.31	618051	13.52	298465	17.46
03	Indoor-1-PP	132869	11.33	538170	13.53	264233	17.46
04							
05							
06							
07							
08							
09							
10							
11							
12							
13							
14							
15							
16							
17							
18							
19							
20							

IS1 (BCM) = Bromochloromethane

IS2 (DFB) = 1,4-Difluorobenzene

IS3 (CBZ) = Chlorobenzene-d5

AREA UPPER LIMIT = 140% of internal standard area

AREA LOWER LIMIT = 60% of internal standard area

RT UPPER LIMIT = 0.33 minutes of internal standard RT

RT LOWER LIMIT = 0.33 minutes of internal standard RT

# Column used to flag values outside QC limits with an I.

I = Internal standard not within the specified limits.

Evaluate Continuing Calibration Report

Data Path : J:\MS16\DATA\2012\_10\09\  
 Data File : 10091201.D  
 Acq On : 9 Oct 2012 8:35  
 Operator : LH  
 Sample : 25ng TO-15 CCV STD  
 Misc : S25-09261201/S25-09211205  
 ALS Vial : 2 Sample Multiplier: 1

Quant Time: Oct 09 11:42:38 2012  
 Quant Method : J:\MS16\METHODS\R16071312.M  
 Quant Title : EPA TO-15 per SOP VOA-TO15 (CASS TO-15/GC-MS)  
 QLast Update : Mon Jul 16 09:59:54 2012  
 Response via : Initial Calibration

Min. RRF : 0.000 Min. Rel. Area : 50% Max. R.T. Dev 0.33min  
 Max. RRF Dev : 30% Max. Rel. Area : 200%

	Compound	AvgRF	CCRF	%Dev	Area%	Dev(min)
1 IR	Bromochloromethane (IS1)	1.000	1.000	0.0	106	-0.02
2 T	Propene	1.554	1.258	19.0	71	0.00
3 T	Dichlorodifluoromethane (CF	2.347	2.042	13.0	87	0.00
4 T	Chloromethane	1.646	1.313	20.2	80	-0.01
5 T	1,2-Dichloro-1,1,2,2-tetra	1.289	1.098	14.8	87	-0.01
6 T	Vinyl Chloride	1.576	1.299	17.6	81	-0.01
7 T	1,3-Butadiene	1.101	0.965	12.4	83	-0.01
8 T	Bromomethane	1.079	0.905	16.1	85	-0.02
9 T	Chloroethane	0.776	0.637	17.9	83	-0.01
10 T	Ethanol	0.853	0.663	22.3	84	-0.07
11 T	Acetonitrile	1.763	1.394	20.9	80	-0.05
12 T	Acrolein	0.579	0.466	19.5	80	-0.03
13 T	Acetone	0.722	0.587	18.7	83	-0.05
14 T	Trichlorofluoromethane	2.130	1.973	7.4	93	-0.01
15 T	2-Propanol (Isopropanol)	1.500	1.384	7.7	96	-0.05
16 T	Acrylonitrile	1.063	1.023	3.8	81	-0.03
17 T	1,1-Dichloroethene	1.025	0.858	16.3	83	-0.02
18 T	2-Methyl-2-Propanol (tert-B	2.429	2.226	8.4	168	-0.04
19 T	Methylene Chloride	1.030	0.871	15.4	83	-0.02
20 T	3-Chloro-1-propene (Allyl C	1.559	1.258	19.3	79	-0.02
21 T	Trichlorotrifluoroethane	1.107	0.926	16.4	85	-0.02
22 T	Carbon Disulfide	4.044	3.310	18.2	83	-0.02
23 T	trans-1,2-Dichloroethene	1.494	1.352	9.5	85	-0.02
24 T	1,1-Dichloroethane	1.979	1.649	16.7	84	-0.02
25 T	Methyl tert-Butyl Ether	3.229	2.896	10.3	88	-0.02
26 T	Vinyl Acetate	0.200	0.212	-6.0	88	-0.03
27 T	2-Butanone (MEK)	0.589	0.574	2.5	88	-0.03
28 T	cis-1,2-Dichloroethene	1.459	1.289	11.7	86	-0.02
29 T	Diisopropyl Ether	0.841	0.712	15.3	86	-0.02
30 T	Ethyl Acetate	0.354	0.327	7.6	82	-0.03
31 T	n-Hexane	1.822	1.463	19.7	82	-0.01
32 T	Chloroform	1.900	1.668	12.2	89	-0.03
33 S	1,2-Dichloroethane-d4 (SS1)	1.298	1.393	-7.3	114	-0.02
34 T	Tetrahydrofuran (THF)	0.635	0.636	-0.2	99	-0.02
35 T	Ethyl tert-Butyl Ether	1.299	1.146	11.8	88	-0.02
36 T	1,2-Dichloroethane	1.442	1.385	4.0	94	-0.02
37 IR	1,4-Difluorobenzene (IS2)	1.000	1.000	0.0	104	-0.02
38 T	1,1,1-Trichloroethane	0.433	0.398	8.1	89	-0.01

Evaluate Continuing Calibration Report

Data Path : J:\MS16\DATA\2012\_10\09\  
 Data File : 10091201.D  
 Acq On : 9 Oct 2012 8:35  
 Operator : LH  
 Sample : 25ng TO-15 CCV STD  
 Misc : S25-09261201/S25-09211205  
 ALS Vial : 2 Sample Multiplier: 1

Quant Time: Oct 09 11:42:38 2012  
 Quant Method : J:\MS16\METHODS\R16071312.M  
 Quant Title : EPA TO-15 per SOP VOA-TO15 (CASS TO-15/GC-MS)  
 QLast Update : Mon Jul 16 09:59:54 2012  
 Response via : Initial Calibration

Min. RRF : 0.000 Min. Rel. Area : 50% Max. R.T. Dev 0.33min  
 Max. RRF Dev : 30% Max. Rel. Area : 200%

Compound		AvgRF	CCRF	%Dev	Area%	Dev(min)
39 T	Isopropyl Acetate	0.159	0.136	14.5	80	-0.02
40 T	1-Butanol	0.244	0.228	6.6	83	-0.05
41 T	Benzene	1.081	0.835	22.8	82	-0.01
42 T	Carbon Tetrachloride	0.353	0.351	0.6	92	-0.02
43 T	Cyclohexane	0.407	0.341	16.2	82	-0.02
44 T	tert-Amyl Methyl Ether	0.778	0.720	7.5	88	-0.01
45 T	1,2-Dichloropropane	0.271	0.235	13.3	84	-0.02
46 T	Bromodichloromethane	0.362	0.355	1.9	91	-0.01
47 T	Trichloroethene	0.318	0.301	5.3	88	-0.02
48 T	1,4-Dioxane	0.212	0.192	9.4	86	-0.02
49 T	2,2,4-Trimethylpentane (Iso	1.136	0.957	15.8	83	-0.01
50 T	Methyl Methacrylate	0.114	0.102	10.5	83	-0.02
51 T	n-Heptane	0.262	0.216	17.6	80	-0.02
52 T	cis-1,3-Dichloropropene	0.414	0.407	1.7	87	-0.01
53 T	4-Methyl-2-pentanone	0.240	0.216	10.0	84	-0.01
54 T	trans-1,3-Dichloropropene	0.365	0.372	-1.9	85	-0.01
55 T	1,1,2-Trichloroethane	0.274	0.236	13.9	83	-0.01
56 IR	Chlorobenzene-d5 (IS3)	1.000	1.000	0.0	110	0.00
57 S	Toluene-d8 (SS2)	2.309	2.145	7.1	103	-0.01
58 T	Toluene	2.621	2.046	21.9	84	-0.01
59 T	2-Hexanone	1.255	1.046	16.7	83	-0.02
60 T	Dibromochloromethane	0.720	0.662	8.1	88	-0.01
61 T	1,2-Dibromoethane	0.713	0.626	12.2	87	-0.01
62 T	n-Butyl Acetate	1.477	1.295	12.3	85	-0.01
63 T	n-Octane	0.538	0.431	19.9	84	-0.01
64 T	Tetrachloroethene	0.921	0.785	14.8	89	0.00
65 T	Chlorobenzene	1.749	1.466	16.2	87	-0.01
66 T	Ethylbenzene	2.964	2.373	19.9	85	0.00
67 T	m- & p-Xylenes	2.340	1.907	18.5	86	-0.01
68 T	Bromoform	0.706	0.673	4.7	88	-0.01
69 T	Styrene	1.761	1.535	12.8	87	-0.01
70 T	o-Xylene	2.460	2.083	15.3	90	0.00
71 T	n-Nonane	1.313	1.048	20.2	84	-0.01
72 T	1,1,2,2-Tetrachloroethane	1.147	0.978	14.7	86	-0.01
73 S	Bromofluorobenzene (SS3)	1.191	1.235	-3.7	115	0.00
74 T	Cumene	3.298	2.715	17.7	89	0.00
75 T	alpha-Pinene	1.541	1.214	21.2	81	0.00
76 T	n-Propylbenzene	3.803	3.013	20.8	83	0.00

ea 10/9/12

Evaluate Continuing Calibration Report

Data Path : J:\MS16\DATA\2012\_10\09\  
 Data File : 10091201.D  
 Acq On : 9 Oct 2012 8:35  
 Operator : LH  
 Sample : 25ng TO-15 CCV STD  
 Misc : S25-09261201/S25-09211205  
 ALS Vial : 2 Sample Multiplier: 1

Quant Time: Oct 09 11:42:38 2012  
 Quant Method : J:\MS16\METHODS\R16071312.M  
 Quant Title : EPA TO-15 per SOP VOA-TO15 (CASS TO-15/GC-MS)  
 QLast Update : Mon Jul 16 09:59:54 2012  
 Response via : Initial Calibration

Min. RRF : 0.000 Min. Rel. Area : 50% Max. R.T. Dev 0.33min  
 Max. RRF Dev : 30% Max. Rel. Area : 200%

Compound		AvgRF	CCRF	%Dev	Area%	Dev(min)
77 T	3-Ethyltoluene	2.995	2.464	17.7	84	0.00
78 T	4-Ethyltoluene	2.847	2.284	19.8	82	0.00
79 T	1,3,5-Trimethylbenzene	2.493	1.979	20.6	84	-0.01
80 T	alpha-Methylstyrene	1.311	1.063	18.9	79	-0.01
81 T	2-Ethyltoluene	3.154	2.473	21.6	84	0.00
82 T	1,2,4-Trimethylbenzene	2.595	2.077	20.0	86	0.00
83 T	n-Decane	1.334	1.035	22.4	80	-0.01
84 T	Benzyl Chloride	1.934	1.828	5.5	83	-0.01
85 T	1,3-Dichlorobenzene	1.557	1.277	18.0	84	-0.01
86 T	1,4-Dichlorobenzene	1.613	1.299	19.5	84	-0.01
87 T	sec-Butylbenzene	3.339	2.729	18.3	84	0.00
88 T	4-Isopropyltoluene (p-Cymen	3.300	2.764	16.2	85	0.00
89 T	1,2,3-Trimethylbenzene	2.539	2.114	16.7	85	0.00
90 T	1,2-Dichlorobenzene	1.503	1.251	16.8	84	-0.01
91 T	d-Limonene	0.915	0.736	19.6	80	-0.01
92 T	1,2-Dibromo-3-Chloropropane	0.559	0.507	9.3	84	0.00
93 T	n-Undecane	1.345	1.080	19.7	80	0.00
94 T	1,2,4-Trichlorobenzene	1.235	1.120	9.3	88	0.00
95 T	Naphthalene	3.967	3.418	13.8	88	0.00
96 T	n-Dodecane	1.274	1.145	10.1	83	0.00
97 T	Hexachlorobutadiene	0.837	0.714	14.7	88	0.00
98 T	Cyclohexanone	0.919	0.747	18.7	83	-0.01
99 T	tert-Butylbenzene	2.554	2.077	18.7	85	0.00
100 T	n-Butylbenzene	2.531	2.129	15.9	85	0.00

(#) = Out of Range

SPCC's out = 0 CCC's out = 0



## ANALYTICAL REPORT

Lab Number:	L1216912
Client:	GSI Environmental Inc. 2211 Norfolk Street Suite 1000 Houston, TX 77098
ATTN:	Lila Beckley
Phone:	(713) 522-6300
Project Name:	G-3669
Project Number:	G-3669
Report Date:	09/27/12

The original project report/data package is held by Alpha Analytical. This report/data package is paginated and should be reproduced only in its entirety. Alpha Analytical holds no responsibility for results and/or data that are not consistent with the original.

Certifications & Approvals: NY (11627), CT (PH-0141), NH (2206), NJ NELAP (MA015), RI (LAO00299), PA (68-02089), LA NELAP (03090), FL (E87814), TX (T104704419), WA (C954), DOD (L2217.01), USDA (Permit #P330-11-00109), US Army Corps of Engineers.

---

320 Forbes Boulevard, Mansfield, MA 02048-1806  
508-822-9300 (Fax) 508-822-3288 800-624-9220 - [www.alphalab.com](http://www.alphalab.com)





**Project Name:** G-3669  
**Project Number:** G-3669

**Lab Number:** L1216912  
**Report Date:** 09/27/12

<b>Alpha Sample ID</b>	<b>Client ID</b>	<b>Sample Location</b>	<b>Collection Date/Time</b>
L1216912-01	MW-16	SELFRIDGE BLD 1533	09/18/12 15:30

**Project Name:** G-3669**Lab Number:** L1216912**Project Number:** G-3669**Report Date:** 09/27/12

### Case Narrative

The samples were received in accordance with the Chain of Custody and no significant deviations were encountered during the preparation or analysis unless otherwise noted. Sample Receipt, Container Information, and the Chain of Custody are located at the back of the report.

Results contained within this report relate only to the samples submitted under this Alpha Lab Number and meet all of the requirements of NELAC, for all NELAC accredited parameters. The data presented in this report is organized by parameter (i.e. VOC, SVOC, etc.). Sample specific Quality Control data (i.e. Surrogate Spike Recovery) is reported at the end of the target analyte list for each individual sample, followed by the Laboratory Batch Quality Control at the end of each parameter. If a sample was re-analyzed or re-extracted due to a required quality control corrective action and if both sets of data are reported, the Laboratory ID of the re-analysis or re-extraction is designated with an "R" or "RE", respectively. When multiple Batch Quality Control elements are reported (e.g. more than one LCS), the associated samples for each element are noted in the grey shaded header line of each data table. Any Laboratory Batch, Sample Specific % recovery or RPD value that is outside the listed Acceptance Criteria is bolded in the report. Performance criteria for CAM and RCP methods allow for some LCS compound failures to occur and still be within method compliance. In these instances, the specific failures are not narrated but are noted in the associated QC table. This information is also incorporated in the Data Usability format for our Data Merger tool where it can be reviewed along with any associated usability implications. Soil/sediments, solids and tissues are reported on a dry weight basis unless otherwise noted. Definitions of all data qualifiers and acronyms used in this report are provided in the Glossary located at the back of the report.

In reference to questions H (CAM) or 4 (RCP) when "NO" is checked, the performance criteria for CAM and RCP methods allow for some quality control failures to occur and still be within method compliance. In these instances the specific failure is not narrated but noted in the associated QC table. The information is also incorporated in the Data Usability format of our Data Merger tool where it can be reviewed along with any associated usability implications.

Please see the associated ADEx data file for a comparison of laboratory reporting limits that were achieved with the regulatory Numerical Standards requested on the Chain of Custody.

#### HOLD POLICY

For samples submitted on hold, Alpha's policy is to hold samples free of charge for 30 days from the date the project is completed. After 30 days, we will dispose of all samples submitted including those put on hold unless you have contacted your Client Service Representative and made arrangements for Alpha to continue to hold the samples.

Please contact Client Services at 800-624-9220 with any questions.

Project Name: G-3669

Lab Number: L1216912

Project Number: G-3669

Report Date: 09/27/12

**Case Narrative (continued)**

## Sample Receipt

Headspace was noted in the sample containers submitted for Volatile Organics. The analysis was performed at the client's request.

I, the undersigned, attest under the pains and penalties of perjury that, to the best of my knowledge and belief and based upon my personal inquiry of those responsible for providing the information contained in this analytical report, such information is accurate and complete. This certificate of analysis is not complete unless this page accompanies any and all pages of this report.

Authorized Signature:

 Cynthia McQueen

Title: Technical Director/Representative

Date: 09/27/12

# ORGANICS

# VOLATILES

Project Name: G-3669

Lab Number: L1216912

Project Number: G-3669

Report Date: 09/27/12

## SAMPLE RESULTS

Lab ID: L1216912-01 D  
 Client ID: MW-16  
 Sample Location: SELFRIDGE BLD 1533  
 Matrix: Water  
 Analytical Method: 1,8260C  
 Analytical Date: 09/26/12 20:15  
 Analyst: PD

Date Collected: 09/18/12 15:30  
 Date Received: 09/20/12  
 Field Prep: Not Specified

Parameter	Result	Qualifier	Units	RL	MDL	Dilution Factor
Volatile Organics by GC/MS - Westborough Lab						
Methylene chloride	ND		ug/l	120	--	40
1,1-Dichloroethane	ND		ug/l	30	--	40
Chloroform	ND		ug/l	30	--	40
Carbon tetrachloride	ND		ug/l	20	--	40
1,2-Dichloropropane	ND		ug/l	70	--	40
Dibromochloromethane	ND		ug/l	20	--	40
1,1,2-Trichloroethane	ND		ug/l	30	--	40
Tetrachloroethene	ND		ug/l	20	--	40
Chlorobenzene	ND		ug/l	20	--	40
Trichlorofluoromethane	ND		ug/l	100	--	40
1,2-Dichloroethane	ND		ug/l	20	--	40
1,1,1-Trichloroethane	ND		ug/l	20	--	40
Bromodichloromethane	ND		ug/l	20	--	40
trans-1,3-Dichloropropene	ND		ug/l	20	--	40
cis-1,3-Dichloropropene	ND		ug/l	20	--	40
1,1-Dichloropropene	ND		ug/l	100	--	40
Bromoform	ND		ug/l	80	--	40
1,1,2,2-Tetrachloroethane	ND		ug/l	20	--	40
Benzene	360		ug/l	20	--	40
Toluene	41		ug/l	30	--	40
Ethylbenzene	1400		ug/l	20	--	40
Chloromethane	ND		ug/l	100	--	40
Bromomethane	ND		ug/l	40	--	40
Vinyl chloride	ND		ug/l	40	--	40
Chloroethane	ND		ug/l	40	--	40
1,1-Dichloroethene	ND		ug/l	20	--	40
trans-1,2-Dichloroethene	ND		ug/l	30	--	40
Trichloroethene	ND		ug/l	20	--	40
1,2-Dichlorobenzene	ND		ug/l	100	--	40
1,3-Dichlorobenzene	ND		ug/l	100	--	40
1,4-Dichlorobenzene	ND		ug/l	100	--	40

Project Name: G-3669

Lab Number: L1216912

Project Number: G-3669

Report Date: 09/27/12

## SAMPLE RESULTS

Lab ID: L1216912-01 D  
 Client ID: MW-16  
 Sample Location: SELFRIDGE BLD 1533

Date Collected: 09/18/12 15:30  
 Date Received: 09/20/12  
 Field Prep: Not Specified

Parameter	Result	Qualifier	Units	RL	MDL	Dilution Factor
Volatile Organics by GC/MS - Westborough Lab						
Methyl tert butyl ether	ND		ug/l	40	--	40
p/m-Xylene	4800		ug/l	40	--	40
o-Xylene	ND		ug/l	40	--	40
cis-1,2-Dichloroethene	ND		ug/l	20	--	40
Dibromomethane	ND		ug/l	200	--	40
1,4-Dichlorobutane	ND		ug/l	200	--	40
1,2,3-Trichloropropane	ND		ug/l	200	--	40
Styrene	ND		ug/l	40	--	40
Dichlorodifluoromethane	ND		ug/l	200	--	40
Acetone	ND		ug/l	200	--	40
Carbon disulfide	ND		ug/l	200	--	40
2-Butanone	ND		ug/l	200	--	40
Vinyl acetate	ND		ug/l	200	--	40
4-Methyl-2-pentanone	ND		ug/l	200	--	40
2-Hexanone	ND		ug/l	200	--	40
Ethyl methacrylate	ND		ug/l	200	--	40
Acrylonitrile	ND		ug/l	200	--	40
Bromochloromethane	ND		ug/l	100	--	40
Tetrahydrofuran	ND		ug/l	200	--	40
2,2-Dichloropropane	ND		ug/l	100	--	40
1,2-Dibromoethane	ND		ug/l	80	--	40
1,3-Dichloropropane	ND		ug/l	100	--	40
1,1,1,2-Tetrachloroethane	ND		ug/l	20	--	40
Bromobenzene	ND		ug/l	100	--	40
n-Butylbenzene	32		ug/l	20	--	40
sec-Butylbenzene	ND		ug/l	20	--	40
tert-Butylbenzene	ND		ug/l	100	--	40
o-Chlorotoluene	ND		ug/l	100	--	40
p-Chlorotoluene	ND		ug/l	100	--	40
1,2-Dibromo-3-chloropropane	ND		ug/l	100	--	40
Hexachlorobutadiene	ND		ug/l	20	--	40
Isopropylbenzene	68		ug/l	20	--	40
p-Isopropyltoluene	ND		ug/l	20	--	40
Naphthalene	680		ug/l	100	--	40
n-Propylbenzene	210		ug/l	20	--	40
1,2,3-Trichlorobenzene	ND		ug/l	100	--	40
1,2,4-Trichlorobenzene	ND		ug/l	100	--	40
1,3,5-Trimethylbenzene	570		ug/l	100	--	40
1,2,4-Trimethylbenzene	1800		ug/l	100	--	40

Project Name: G-3669

Lab Number: L1216912

Project Number: G-3669

Report Date: 09/27/12

## SAMPLE RESULTS

Lab ID: L1216912-01 D  
 Client ID: MW-16  
 Sample Location: SELFRIDGE BLD 1533

Date Collected: 09/18/12 15:30  
 Date Received: 09/20/12  
 Field Prep: Not Specified

Parameter	Result	Qualifier	Units	RL	MDL	Dilution Factor
Volatile Organics by GC/MS - Westborough Lab						
trans-1,4-Dichloro-2-butene	ND		ug/l	100	--	40
Ethyl ether	ND		ug/l	100	--	40

Surrogate	% Recovery	Qualifier	Acceptance Criteria
1,2-Dichloroethane-d4	100		70-130
Toluene-d8	102		70-130
4-Bromofluorobenzene	99		70-130
Dibromofluoromethane	97		70-130



Project Name: G-3669

Lab Number: L1216912

Project Number: G-3669

Report Date: 09/27/12

### Method Blank Analysis Batch Quality Control

Analytical Method: 1,8260C  
 Analytical Date: 09/26/12 11:36  
 Analyst: PD

Parameter	Result	Qualifier	Units	RL	MDL
Volatile Organics by GC/MS - Westborough Lab for sample(s): 01 Batch: WG563554-3					
Methylene chloride	ND		ug/l	3.0	--
1,1-Dichloroethane	ND		ug/l	0.75	--
Chloroform	ND		ug/l	0.75	--
Carbon tetrachloride	ND		ug/l	0.50	--
1,2-Dichloropropane	ND		ug/l	1.8	--
Dibromochloromethane	ND		ug/l	0.50	--
1,1,2-Trichloroethane	ND		ug/l	0.75	--
Tetrachloroethene	ND		ug/l	0.50	--
Chlorobenzene	ND		ug/l	0.50	--
Trichlorofluoromethane	ND		ug/l	2.5	--
1,2-Dichloroethane	ND		ug/l	0.50	--
1,1,1-Trichloroethane	ND		ug/l	0.50	--
Bromodichloromethane	ND		ug/l	0.50	--
trans-1,3-Dichloropropene	ND		ug/l	0.50	--
cis-1,3-Dichloropropene	ND		ug/l	0.50	--
1,1-Dichloropropene	ND		ug/l	2.5	--
Bromoform	ND		ug/l	2.0	--
1,1,2,2-Tetrachloroethane	ND		ug/l	0.50	--
Benzene	ND		ug/l	0.50	--
Toluene	ND		ug/l	0.75	--
Ethylbenzene	ND		ug/l	0.50	--
Chloromethane	ND		ug/l	2.5	--
Bromomethane	ND		ug/l	1.0	--
Vinyl chloride	ND		ug/l	1.0	--
Chloroethane	ND		ug/l	1.0	--
1,1-Dichloroethene	ND		ug/l	0.50	--
trans-1,2-Dichloroethene	ND		ug/l	0.75	--
Trichloroethene	ND		ug/l	0.50	--
1,2-Dichlorobenzene	ND		ug/l	2.5	--
1,3-Dichlorobenzene	ND		ug/l	2.5	--
1,4-Dichlorobenzene	ND		ug/l	2.5	--

Project Name: G-3669

Lab Number: L1216912

Project Number: G-3669

Report Date: 09/27/12

### Method Blank Analysis Batch Quality Control

Analytical Method: 1,8260C  
 Analytical Date: 09/26/12 11:36  
 Analyst: PD

Parameter	Result	Qualifier	Units	RL	MDL
Volatile Organics by GC/MS - Westborough Lab for sample(s): 01 Batch: WG563554-3					
Methyl tert butyl ether	ND		ug/l	1.0	--
p/m-Xylene	ND		ug/l	1.0	--
o-Xylene	ND		ug/l	1.0	--
cis-1,2-Dichloroethene	ND		ug/l	0.50	--
Dibromomethane	ND		ug/l	5.0	--
1,4-Dichlorobutane	ND		ug/l	5.0	--
1,2,3-Trichloropropane	ND		ug/l	5.0	--
Styrene	ND		ug/l	1.0	--
Dichlorodifluoromethane	ND		ug/l	5.0	--
Acetone	ND		ug/l	5.0	--
Carbon disulfide	ND		ug/l	5.0	--
2-Butanone	ND		ug/l	5.0	--
Vinyl acetate	ND		ug/l	5.0	--
4-Methyl-2-pentanone	ND		ug/l	5.0	--
2-Hexanone	ND		ug/l	5.0	--
Ethyl methacrylate	ND		ug/l	5.0	--
Acrylonitrile	ND		ug/l	5.0	--
Bromochloromethane	ND		ug/l	2.5	--
Tetrahydrofuran	ND		ug/l	5.0	--
2,2-Dichloropropane	ND		ug/l	2.5	--
1,2-Dibromoethane	ND		ug/l	2.0	--
1,3-Dichloropropane	ND		ug/l	2.5	--
1,1,1,2-Tetrachloroethane	ND		ug/l	0.50	--
Bromobenzene	ND		ug/l	2.5	--
n-Butylbenzene	ND		ug/l	0.50	--
sec-Butylbenzene	ND		ug/l	0.50	--
tert-Butylbenzene	ND		ug/l	2.5	--
o-Chlorotoluene	ND		ug/l	2.5	--
p-Chlorotoluene	ND		ug/l	2.5	--
1,2-Dibromo-3-chloropropane	ND		ug/l	2.5	--
Hexachlorobutadiene	ND		ug/l	0.50	--

Project Name: G-3669

Lab Number: L1216912

Project Number: G-3669

Report Date: 09/27/12

**Method Blank Analysis**  
**Batch Quality Control**

Analytical Method: 1,8260C  
 Analytical Date: 09/26/12 11:36  
 Analyst: PD

Parameter	Result	Qualifier	Units	RL	MDL
Volatile Organics by GC/MS - Westborough Lab for sample(s): 01 Batch: WG563554-3					
Isopropylbenzene	ND		ug/l	0.50	--
p-Isopropyltoluene	ND		ug/l	0.50	--
Naphthalene	ND		ug/l	2.5	--
n-Propylbenzene	ND		ug/l	0.50	--
1,2,3-Trichlorobenzene	ND		ug/l	2.5	--
1,2,4-Trichlorobenzene	ND		ug/l	2.5	--
1,3,5-Trimethylbenzene	ND		ug/l	2.5	--
1,2,4-Trimethylbenzene	ND		ug/l	2.5	--
trans-1,4-Dichloro-2-butene	ND		ug/l	2.5	--
Ethyl ether	ND		ug/l	2.5	--

Surrogate	%Recovery	Qualifier	Acceptance Criteria
1,2-Dichloroethane-d4	99		70-130
Toluene-d8	101		70-130
4-Bromofluorobenzene	105		70-130
Dibromofluoromethane	97		70-130

## Lab Control Sample Analysis

### Batch Quality Control

Project Name: G-3669

Lab Number: L1216912

Project Number: G-3669

Report Date: 09/27/12

Parameter	LCS		LCSD		%Recovery Limits	RPD	Qual	RPD Limits
	%Recovery	Qual	%Recovery	Qual				
Volatile Organics by GC/MS - Westborough Lab Associated sample(s): 01 Batch: WG563554-1 WG563554-2								
Methylene chloride	105		100		70-130	5		20
1,1-Dichloroethane	108		102		70-130	6		20
Chloroform	106		100		70-130	6		20
Carbon tetrachloride	92		88		63-132	4		20
1,2-Dichloropropane	107		103		70-130	4		20
Dibromochloromethane	104		100		63-130	4		20
1,1,2-Trichloroethane	108		104		70-130	4		20
Tetrachloroethene	110		102		70-130	8		20
Chlorobenzene	106		102		75-130	4		25
Trichlorofluoromethane	109		102		62-150	7		20
1,2-Dichloroethane	104		100		70-130	4		20
1,1,1-Trichloroethane	103		99		67-130	4		20
Bromodichloromethane	103		100		67-130	3		20
trans-1,3-Dichloropropene	100		98		70-130	2		20
cis-1,3-Dichloropropene	102		99		70-130	3		20
1,1-Dichloropropene	107		100		70-130	7		20
Bromoform	99		95		54-136	4		20
1,1,2,2-Tetrachloroethane	107		101		67-130	6		20
Benzene	108		103		70-130	5		25
Toluene	109		104		70-130	5		25
Ethylbenzene	108		102		70-130	6		20

## Lab Control Sample Analysis

### Batch Quality Control

Project Name: G-3669

Lab Number: L1216912

Project Number: G-3669

Report Date: 09/27/12

Parameter	LCS		LCSD		%Recovery Limits	RPD	Qual	RPD Limits
	%Recovery	Qual	%Recovery	Qual				
Volatile Organics by GC/MS - Westborough Lab Associated sample(s): 01 Batch: WG563554-1 WG563554-2								
Chloromethane	115		104		64-130	10		20
Bromomethane	104		104		39-139	0		20
Vinyl chloride	114		102		55-140	11		20
Chloroethane	111		104		55-138	7		20
1,1-Dichloroethene	109		100		61-145	9		25
trans-1,2-Dichloroethene	105		98		70-130	7		20
Trichloroethene	107		100		70-130	7		25
1,2-Dichlorobenzene	106		102		70-130	4		20
1,3-Dichlorobenzene	107		100		70-130	7		20
1,4-Dichlorobenzene	106		99		70-130	7		20
Methyl tert butyl ether	90		91		63-130	1		20
p/m-Xylene	108		102		70-130	6		20
o-Xylene	110		102		70-130	8		20
cis-1,2-Dichloroethene	109		103		70-130	6		20
Dibromomethane	102		98		70-130	4		20
1,4-Dichlorobutane	106		100		70-130	6		20
1,2,3-Trichloropropane	106		100		64-130	6		20
Styrene	108		101		70-130	7		20
Dichlorodifluoromethane	106		99		36-147	7		20
Acetone	111		93		58-148	18		20
Carbon disulfide	105		94		51-130	11		20

## Lab Control Sample Analysis

### Batch Quality Control

Project Name: G-3669

Lab Number: L1216912

Project Number: G-3669

Report Date: 09/27/12

Parameter	LCS		LCSD		%Recovery Limits	RPD	Qual	RPD Limits
	%Recovery	Qual	%Recovery	Qual				
Volatile Organics by GC/MS - Westborough Lab Associated sample(s): 01 Batch: WG563554-1 WG563554-2								
2-Butanone	107		107		63-138	0		20
Vinyl acetate	90		97		70-130	7		20
4-Methyl-2-pentanone	96		100		59-130	4		20
2-Hexanone	109		106		57-130	3		20
Ethyl methacrylate	98		102		70-130	4		20
Acrylonitrile	102		99		70-130	3		20
Bromochloromethane	106		103		70-130	3		20
Tetrahydrofuran	96		94		58-130	2		20
2,2-Dichloropropane	95		92		63-133	3		20
1,2-Dibromoethane	104		102		70-130	2		20
1,3-Dichloropropane	106		103		70-130	3		20
1,1,1,2-Tetrachloroethane	109		103		64-130	6		20
Bromobenzene	109		101		70-130	8		20
n-Butylbenzene	94		104		53-136	10		20
sec-Butylbenzene	111		103		70-130	7		20
tert-Butylbenzene	111		103		70-130	7		20
o-Chlorotoluene	111		103		70-130	7		20
p-Chlorotoluene	106		97		70-130	9		20
1,2-Dibromo-3-chloropropane	93		94		41-144	1		20
Hexachlorobutadiene	111		105		63-130	6		20
Isopropylbenzene	115		103		70-130	11		20

## Lab Control Sample Analysis

### Batch Quality Control

**Project Name:** G-3669

**Project Number:** G-3669

**Lab Number:** L1216912

**Report Date:** 09/27/12

Parameter	LCS		LCSD		%Recovery Limits	RPD	Qual	RPD Limits
	%Recovery	Qual	%Recovery	Qual				
Volatile Organics by GC/MS - Westborough Lab Associated sample(s): 01 Batch: WG563554-1 WG563554-2								
p-Isopropyltoluene	104		103		70-130	1		20
Naphthalene	82		116		70-130	34	Q	20
n-Propylbenzene	110		102		69-130	8		20
1,2,3-Trichlorobenzene	91		110		70-130	19		20
1,2,4-Trichlorobenzene	94		109		70-130	15		20
1,3,5-Trimethylbenzene	104		105		64-130	1		20
1,2,4-Trimethylbenzene	101		105		70-130	4		20
trans-1,4-Dichloro-2-butene	99		96		70-130	3		20
Ethyl ether	104		102		59-134	2		20

Surrogate	LCS		LCSD		Acceptance Criteria
	%Recovery	Qual	%Recovery	Qual	
1,2-Dichloroethane-d4	98		99		70-130
Toluene-d8	101		100		70-130
4-Bromofluorobenzene	103		98		70-130
Dibromofluoromethane	100		100		70-130

Project Name: G-3669

Lab Number: L1216912

Project Number: G-3669

Report Date: 09/27/12

**Sample Receipt and Container Information**

Were project specific reporting limits specified? YES

Reagent H2O Preserved Vials Frozen on: NA

**Cooler Information Custody Seal****Cooler**

A Absent

**Container Information**

Container ID	Container Type	Cooler	pH	Temp deg C	Pres	Seal	Analysis(*)
L1216912-01A	Vial HCl preserved	A	N/A	2.6	Y	Absent	8260(14)
L1216912-01B	Vial HCl preserved	A	N/A	2.6	Y	Absent	8260(14)

\*Values in parentheses indicate holding time in days



**Project Name:** G-3669  
**Project Number:** G-3669

**Lab Number:** L1216912  
**Report Date:** 09/27/12

## GLOSSARY

### Acronyms

EPA	- Environmental Protection Agency.
LCS	- Laboratory Control Sample: A sample matrix, free from the analytes of interest, spiked with verified known amounts of analytes or a material containing known and verified amounts of analytes.
LCSD	- Laboratory Control Sample Duplicate: Refer to LCS.
LFB	- Laboratory Fortified Blank: A sample matrix, free from the analytes of interest, spiked with verified known amounts of analytes or a material containing known and verified amounts of analytes.
MDL	- Method Detection Limit: This value represents the level to which target analyte concentrations are reported as estimated values, when those target analyte concentrations are quantified below the reporting limit (RL). The MDL includes any adjustments from dilutions, concentrations or moisture content, where applicable.
MS	- Matrix Spike Sample: A sample prepared by adding a known mass of target analyte to a specified amount of matrix sample for which an independent estimate of target analyte concentration is available.
MSD	- Matrix Spike Sample Duplicate: Refer to MS.
NA	- Not Applicable.
NC	- Not Calculated: Term is utilized when one or more of the results utilized in the calculation are non-detect at the parameter's reporting unit.
NI	- Not Ignitable.
RL	- Reporting Limit: The value at which an instrument can accurately measure an analyte at a specific concentration. The RL includes any adjustments from dilutions, concentrations or moisture content, where applicable.
RPD	- Relative Percent Difference: The results from matrix and/or matrix spike duplicates are primarily designed to assess the precision of analytical results in a given matrix and are expressed as relative percent difference (RPD). Values which are less than five times the reporting limit for any individual parameter are evaluated by utilizing the absolute difference between the values; although the RPD value will be provided in the report.
SRM	- Standard Reference Material: A reference sample of a known or certified value that is of the same or similar matrix as the associated field samples.

### Footnotes

- 1 - The reference for this analyte should be considered modified since this analyte is absent from the target analyte list of the original method.

### Terms

Analytical Method: Both the document from which the method originates and the analytical reference method. (Example: EPA 8260B is shown as 1,8260B.) The codes for the reference method documents are provided in the References section of the Addendum.

### Data Qualifiers

<b>A</b>	- Spectra identified as "Aldol Condensation Product".
<b>B</b>	- The analyte was detected above the reporting limit in the associated method blank. Flag only applies to associated field samples that have detectable concentrations of the analyte at less than five times (5x) the concentration found in the blank. For MCP-related projects, flag only applies to associated field samples that have detectable concentrations of the analyte at less than ten times (10x) the concentration found in the blank. For DOD-related projects, flag only applies to associated field samples that have detectable concentrations of the analyte at less than ten times (10x) the concentration found in the blank AND the analyte was detected above one-half the reporting limit (or above the reporting limit for common lab contaminants) in the associated method blank. For NJ-Air-related projects, flag only applies to associated field samples that have detectable concentrations of the analyte above the reporting limit.
<b>C</b>	- Co-elution: The target analyte co-elutes with a known lab standard (i.e. surrogate, internal standards, etc.) for co-extracted analyses.
<b>D</b>	- Concentration of analyte was quantified from diluted analysis. Flag only applies to field samples that have detectable concentrations of the analyte.
<b>E</b>	- Concentration of analyte exceeds the range of the calibration curve and/or linear range of the instrument.
<b>G</b>	- The concentration may be biased high due to matrix interferences (i.e. co-elution) with non-target compound(s). The result should be considered estimated.
<b>H</b>	- The analysis of pH was performed beyond the regulatory-required holding time of 15 minutes from the time of sample collection.
<b>I</b>	- The RPD between the results for the two columns exceeds the method-specified criteria; however, the lower value has been reported due to obvious interference.
<b>M</b>	- Reporting Limit (RL) exceeds the MCP CAM Reporting Limit for this analyte.
<b>NJ</b>	- Presumptive evidence of compound. This represents an estimated concentration for Tentatively Identified Compounds (TICs), where the identification is based on a mass spectral library search.

Report Format: Data Usability Report



**Project Name:** G-3669  
**Project Number:** G-3669

**Lab Number:** L1216912  
**Report Date:** 09/27/12

**Data Qualifiers**

- P** - The RPD between the results for the two columns exceeds the method-specified criteria.
- Q** - The quality control sample exceeds the associated acceptance criteria. For DOD-related projects, LCS and/or Continuing Calibration Standard exceedences are also qualified on all associated sample results. Note: This flag is not applicable for matrix spike recoveries when the sample concentration is greater than 4x the spike added or for batch duplicate RPD when the sample concentrations are less than 5x the RL. (Metals only.)
- R** - Analytical results are from sample re-analysis.
- RE** - Analytical results are from sample re-extraction.
- J** - Estimated value. This represents an estimated concentration for Tentatively Identified Compounds (TICs).
- ND** - Not detected at the reporting limit (RL) for the sample.

**Project Name:** G-3669

**Lab Number:** L1216912

**Project Number:** G-3669

**Report Date:** 09/27/12

## REFERENCES

- 1 Test Methods for Evaluating Solid Waste: Physical/Chemical Methods. EPA SW-846. Third Edition. Updates I - IIIA, 1997.

## LIMITATION OF LIABILITIES

Alpha Analytical performs services with reasonable care and diligence normal to the analytical testing laboratory industry. In the event of an error, the sole and exclusive responsibility of Alpha Analytical shall be to re-perform the work at it's own expense. In no event shall Alpha Analytical be held liable for any incidental, consequential or special damages, including but not limited to, damages in any way connected with the use of, interpretation of, information or analysis provided by Alpha Analytical.

We strongly urge our clients to comply with EPA protocol regarding sample volume, preservation, cooling, containers, sampling procedures, holding time and splitting of samples in the field.



## Certificate/Approval Program Summary

Last revised August 3, 2012 – Mansfield Facility

The following list includes only those analytes/methods for which certification/approval is currently held. For a complete listing of analytes for the referenced methods, please contact your Alpha Customer Service Representative.

### **Connecticut Department of Public Health** Certificate/Lab ID: PH-0141.

*Wastewater/Non-Potable Water* (Inorganic Parameters: pH, Turbidity, Conductivity, Alkalinity, Aluminum, Antimony, Arsenic, Barium, Beryllium, Boron, Cadmium, Calcium, Chromium, Cobalt, Copper, Iron, Lead, Magnesium, Manganese, Mercury, Molybdenum, Nickel, Potassium, Selenium, Silver, Sodium, Strontium, Thallium, Tin, Titanium, Vanadium, Zinc, Total Residue (Solids), Total Suspended Solids (non-filterable). Organic Parameters: PCBs, Organochlorine Pesticides, Technical Chlordane, Toxaphene, Acid Extractables, Benzidines, Phthalate Esters, Nitrosamines, Nitroaromatics & Isophorone, PAHs, Haloethers, Chlorinated Hydrocarbons, Volatile Organics.)

*Solid Waste/Soil* (Inorganic Parameters: pH, Aluminum, Antimony, Arsenic, Barium, Beryllium, Cadmium, Calcium, Chromium, Hexavalent Chromium, Cobalt, Copper, Iron, Lead, Magnesium, Manganese, Mercury, Molybdenum, Nickel, Potassium, Selenium, Silver, Sodium, Thallium, Titanium, Vanadium, Zinc, Total Organic Carbon, Corrosivity, TCLP 1311, SPLP 1312. Organic Parameters: PCBs, Organochlorine Pesticides, Technical Chlordane, Toxaphene, Volatile Organics, Acid Extractables, Benzidines, Phthalates, Nitrosamines, Nitroaromatics & Cyclic Ketones, PAHs, Haloethers, Chlorinated Hydrocarbons.)

### **Florida Department of Health** Certificate/Lab ID: E87814. NELAP Accredited.

*Non-Potable Water* (Inorganic Parameters: SM2320B, SM2540D, SM2540G.)

*Solid & Chemical Materials* (Inorganic Parameters: 6020, 7470, 7471, 9045. Organic Parameters: EPA 8260, 8270, 8082, 8081.)

*Air & Emissions* (EPA TO-15.)

### **Louisiana Department of Environmental Quality** Certificate/Lab ID: 03090. NELAP Accredited.

*Non-Potable Water* (Inorganic Parameters: EPA 180.1, 245.7, 1631E, 3020A, 6020A, 7470A, 9040, 9050A, SM2320B, 2540D, 2540G, 4500H-B, Organic Parameters: EPA 3510C, 3580A, 3630C, 3640A, 3660B, 3665A, 5030B, 8015D, 3570, 8081B, 8082A, 8260B, 8270C, 8270D.)

*Solid & Chemical Materials* (Inorganic Parameters: EPA 1311, 3050B, 3051A, 3060A, 6020A, 7196A, 7470A, 7471B, 7474, 9040B, 9045C, 9060. Organic Parameters: EPA 3540C, 3570, 3580A, 3630C, 3640A, 3660, 3665A, 5035, 8015D, 8081B, 8082A, 8260B, 8270C, 8270D.)

*Biological Tissue* (Inorganic Parameters: EPA 6020A. Organic Parameters: EPA 3570, 3510C, 3610B, 3630C, 3640A, 8270C, 8270D.)

*Air & Emissions* (EPA TO-15.)

### **New Hampshire Department of Environmental Services** Certificate/Lab ID: 2206. NELAP Accredited.

*Non-Potable Water* (Inorganic Parameters: EPA 180.1, 1631E, 6020A, 7470A, 9040B, 9050A, SM2540D, 2540G, 4500H+B, 2320B, 3020A, . Organic Parameters: EPA 3510C, 3630C, 3640A, 3660B, 8081B, 8082A, 8270C, 8270D, 8015D.)

*Solid & Chemical Materials* (Inorganic Parameters: SW-846 1311, 3050B, 3051A, 6020A, 7471B, 9040B, 9045C. Organic Parameters: SW-846 3540C, 3580A, 3630C, 3640A, 3660B, 3665A, 8270C, 8015D, 8082A, 8081B.)

### **New Jersey Department of Environmental Protection** Certificate/Lab ID: MA015. NELAP Accredited.

*Non-Potable Water* (Inorganic Parameters: SW-846 1312, 3020A, SM2320B, SM2540D, 2540G, 4500H-B, EPA 180.1, 1631E, SW-846 7470A, 9040C, 6020A, 9050A. Organic Parameters: SW-846 3510C, 3580A, 3630C, 3640A, 3660B, 3665A, 8015D, 8081B, 8082A, 8270C, 8270D)

*Solid & Chemical Materials* (Inorganic Parameters: SW-846 1311, 1312, 3050B, 3051A, 6020A, 7471B, 7474, 9040B, 9040C, 9045C, 9045D, 9060. Organic Parameters: SW-846 3540C, 3570, 3580A, 3630C, 3640A, 3660B, 3665A, 8081B, 8082A, 8270C, 8270D, 8015D.)

*Atmospheric Organic Parameters* (EPA 3C, TO-15, TO-10A, TO-13A-SIM.)

*Biological Tissue* (Inorganic Parameters: SW-846 6020A. Organic Parameters: SW-846 8270C, 8270D, 3510C, 3570, 3610C, 3630C, 3640A)

**New York Department of Health** Certificate/Lab ID: 11627. **NELAP Accredited.**

*Non-Potable Water* (Inorganic Parameters: SM2320B, SM2540D, 6020A, 1631E, 7470A, 9050A, EPA 180.1, 3020A. Organic Parameters: EPA 8270C, 8270D, 8081B, 8082A, 3510C.)

*Solid & Hazardous Waste* (Inorganic Parameters: EPA 6020A, 7471B, 7474, 9040C, 9045D. Organic Parameters: EPA 8270C, 8270D, 8081B, 8082A, 1311, 3050B, 3580A, 3570, 3051A.)

*Air & Emissions* (EPA TO-15, TO-10A.)

**Pennsylvania** Certificate/Lab ID: 68-02089 **NELAP Accredited**

*Non-Potable Water* (Inorganic Parameters: 1312, 1631E, 180.1, 3020A, 6020A, 7470A, 9040B, 9050A, 2320B, 2540D, 2540G, SM4500H+-B. Organic Parameters: 3510C, 3580A, 3630C, 3640A, 3660B, 3665A, 8015D, 8081B, 8082A, 8270C, 8270D .)

*Solid & Hazardous Waste* (Inorganic Parameters: EPA 1311, 3051A, 6020A, 7471B, 7474 9040B, 9045C, 9060. Organic Parameters: EPA3050B, 3540C, 3570, 3580A, 3630C, 3640A, 3660B, 3665A, 8270C, 8270D, 8081B, 8015D, 8082A.)

**Rhode Island Department of Health** Certificate/Lab ID: LAO00299. **NELAP Accredited via NJ-DEP.**

Refer to NJ-DEP Certificate for Non-Potable Water.

**Texas Commission of Environmental Quality** Certificate/Lab ID: T104704419-08-TX. **NELAP Accredited.**

*Solid & Chemical Materials* (Inorganic Parameters: EPA 6020, 7470, 7471, 1311, 9040, 9045, 9060. Organic Parameters: EPA 8015, 8270, 8081, 8082.)

*Air* (Organic Parameters: EPA TO-15)

**Virginia Division of Consolidated Laboratory Services** Certificate/Lab ID:460194. **NELAP Accredited.**

*Non-Potable Water* (Inorganic Parameters:EPA 3020A, 6020A, 245.7, 9040B. Organic Parameters: EPA 3510C, 3640A, 3660B, 3665A, 8270C, 8270D, 8082A, 8081B, 8015D.)

*Solid & Chemical Materials* (Inorganic Parameters: EPA 6020A,7470A,7471B,9040B,9045C,3050B,3051, 9060. Organic Parameters: EPA 3540C, 3580A, 3630C, 3640A, 3660B, 3665A, 3570, 8270C, 8270D, 8081B, 8082A, 8015D.)

**Washington State Department of Ecology** Certificate/Lab ID: C954. *Non-Potable Water* (Inorganic Parameters: SM2540D, 180.1, 1631E.)

*Solid & Chemical Materials* (Inorganic Parameters: EPA 6020, 7470, 7471, 7474, 9045C, 9050A, 9060. Organic Parameters: EPA 8081, 8082, 8015, 8270.)

**U.S. Army Corps of Engineers**

**Department of Defense, L-A-B** Certificate/Lab ID: L2217.01.

*Non-Potable Water* (Inorganic Parameters: EPA 6020A, SM4500H-B. Organic Parameters: 3020A, 3510C, 8270C, 8270D, 8270C-ALK-PAH, 8270D-ALK-PAH, 8082A, 8081B, 8015D-SHC, 8015D.)

*Solid & Hazardous Waste* (Inorganic Parameters: EPA 1311, 3050B, 6020A, 7471A, 9045C, 9060, SM 2540G, ASTM D422-63. Organic Parameters: EPA 3580A, 3570, 3540C, 8270C, 8270D, 8270C-ALK-PAH, 8270D-ALK-PAH 8082A, 8081B, 8015D-SHC, 8015D.

*Air & Emissions* (EPA TO-15.)

**Analytes Not Accredited by NELAP**

Certification is not available by NELAP for the following analytes: **8270C**: Biphenyl. **TO-15**: Halothane, 2,4,4-Trimethyl-2-pentene, 2,4,4-Trimethyl-1-pentene, Thiophene, 2-Methylthiophene, 3-Methylthiophene, 2-Ethylthiophene, 1,2,3-Trimethylbenzene, Indan, Indene, 1,2,4,5-Tetramethylbenzene, Benzothiophene, 2-Methylnaphthalene, 1-Methylnaphthalene.

## Certificate/Approval Program Summary

Last revised August 16, 2012 - Westboro Facility

The following list includes only those analytes/methods for which certification/approval is currently held.  
For a complete listing of analytes for the referenced methods, please contact your Alpha Customer Service Representative.

### Connecticut Department of Public Health Certificate/Lab ID: PH-0574. **NELAP Accredited Solid Waste/Soil.**

*Drinking Water* (Inorganic Parameters: Color, pH, Turbidity, Conductivity, Alkalinity, Chloride, Free Residual Chlorine, Fluoride, Calcium Hardness, Sulfate, Nitrate, Nitrite, Aluminum, Antimony, Arsenic, Barium, Beryllium, Cadmium, Calcium, Chromium, Copper, Iron, Lead, Magnesium, Manganese, Mercury, Nickel, Selenium, Silver, Sodium, Thallium, Zinc, Total Dissolved Solids, Total Organic Carbon, Total Cyanide, Perchlorate. Organic Parameters: Volatile Organics 524.2, Total Trihalomethanes 524.2, 1,2-Dibromo-3-chloropropane (DBCP) 504.1, Ethylene Dibromide (EDB) 504.1, 1,4-Dioxane (Mod 8270). Microbiology Parameters: Total Coliform-MF mEndo (SM9222B), Total Coliform – Colilert (SM9223, Enumeration and P/A), E. Coli. – Colilert (SM9223, Enumeration and P/A), HPC – Pour Plate (SM9215B), Fecal Coliform – MF m-FC (SM9222D), Fecal Coliform-EC Medium (SM 9221E).

*Wastewater/Non-Potable Water* (Inorganic Parameters: Color, pH, Conductivity, Acidity, Alkalinity, Chloride, Total Residual Chlorine, Fluoride, Total Hardness, Silica, Sulfate, Sulfide, Ammonia, Kjeldahl Nitrogen, Nitrate, Nitrite, O-Phosphate, Total Phosphorus, Aluminum, Antimony, Arsenic, Barium, Beryllium, Boron, Cadmium, Calcium, Chromium, Hexavalent Chromium, Cobalt, Copper, Iron, Lead, Magnesium, Manganese, Mercury, Molybdenum, Nickel, Potassium, Selenium, Silver, Sodium, Strontium, Thallium, Tin, Titanium, Vanadium, Zinc, Total Residue (Solids), Total Dissolved Solids, Total Suspended Solids (non-filterable), BOD, CBOD, COD, TOC, Total Cyanide, Phenolics, Foaming Agents (MBAS), Bromide, Oil and Grease. Organic Parameters: PCBs, Organochlorine Pesticides, Technical Chlordane, Toxaphene, Acid Extractables (Phenols), Benzidines, Phthalate Esters, Nitrosamines, Nitroaromatics & Isophorone, Polynuclear Aromatic Hydrocarbons, Haloethers, Chlorinated Hydrocarbons, Volatile Organics, TPH (HEM/SGT), CT-Extractable Petroleum Hydrocarbons (ETPH), MA-EPH, MA-VPH. Microbiology Parameters: Total Coliform – MF mEndo (SM9222B), Total Coliform – MTF (SM9221B), E. Coli – Colilert (SM9223 Enumeration), HPC – Pour Plate (SM9215B), Fecal Coliform – MF m-FC (SM9222D), Fecal Coliform – A-1 Broth (SM9221E), Enterococcus - Enterolert.

*Solid Waste/Soil* (Inorganic Parameters: pH, Sulfide, Aluminum, Antimony, Arsenic, Barium, Beryllium, Boron, Cadmium, Calcium, Chromium, Hexavalent Chromium, Cobalt, Copper, Iron, Lead, Magnesium, Manganese, Mercury, Molybdenum, Nickel, Potassium, Selenium, Silver, Sodium, Thallium, Tin, Vanadium, Zinc, Total Cyanide, Ignitability, Phenolics, Corrosivity, TCLP Leach (1311), SPLP Leach (1312 metals only), Reactivity. Organic Parameters: PCBs, PCBs in Oil, Organochlorine Pesticides, Technical Chlordane, Toxaphene, CT-Extractable Petroleum Hydrocarbons (ETPH), MA-EPH, MA-VPH, Dicamba, 2,4-D, 2,4,5-T, 2,4,5-TP (Silvex), Dalapon, Volatile Organics (SW 8260), Acid Extractables (Phenols) (SW 8270), Benzidines (SW 8270), Phthalates (SW 8270), Nitrosamines (SW 8270), Nitroaromatics & Cyclic Ketones (SW 8270), PAHs (SW 8270), Haloethers (SW 8270), Chlorinated Hydrocarbons (SW 8270).)

### Maine Department of Human Services Certificate/Lab ID: 2009024.

*Drinking Water* (Inorganic Parameters: SM9215B, 9222D, 9223B, EPA 180.1, 353.2, SM2130B, 2320B, 2540C, 4500CI-D, 4500CN-C, 4500CN-E, 4500F-C, 4500H+B, 4500NO3-F, EPA 200.7, EPA 200.8, 245.1, EPA 300.0. Organic Parameters: 504.1, 524.2.)

*Wastewater/Non-Potable Water* (Inorganic Parameters: EPA 120.1, 1664A, 350.1, 351.1, 353.2, 410.4, 420.1, SM2320B, 2510B, 2540C, 2540D, 426C, 4500CI-D, 4500CI-E, 4500CN-C, 4500CN-E, 4500F-B, 4500F-C, 4500H+B, 4500Norg-B, 4500Norg-C, 4500NH3-B, 4500NH3-G, 4500NO3-F, 4500P-B, 4500P-E, 5210B, 5220D, 5310C, 9010B, 9040B, 9030B, 7470A, 7196A, 2340B, EPA 200.7, 6010B, 200.8, 6020, 245.1, 1311, 1312, 3005A, Enterolert, 9223D, 9222D. Organic Parameters: 608, 624, 625, 8081A, 8082, 8330, 8151A, 8260B, 8270C, 3510C, 3630C, 5030B, ME-DRO, ME-GRO, MA-EPH, MA-VPH.)

*Solid Waste/Soil* (Inorganic Parameters: 9010B, 9012A, 9014A, 9030B, 9040B, 9045C, 6010B, 7471A, 7196A, 9050A, 1010, 1030, 9065, 1311, 1312, 3005A, 3050B. Organic Parameters: ME-DRO, ME-GRO, MA-EPH, MA-VPH, 8260B, 8270C, 8330, 8151A, 8081A, 8082, 3540C, 3546, 3580A, 3630C, 5030B, 5035.)

### Massachusetts Department of Environmental Protection Certificate/Lab ID: M-MA086.

*Drinking Water* (Inorganic Parameters: (EPA 200.8 for: Sb,As,Ba,Be,Cd,Cr,Cu,Pb,Ni,Se,Tl) (EPA 200.7 for: Ba,Be,Ca,Cd,Cr,Cu,Na,Ni) 245.1, (300.0 for: Nitrate-N, Fluoride, Sulfate); (EPA 353.2 for: Nitrate-N, Nitrite-N); (SM4500NO3-F for: Nitrate-N and Nitrite-N); 4500F-C, 4500CN-CE, EPA 180.1, SM2130B, SM4500CI-D, 2320B, SM2540C, SM4500H-B. Organic Parameters: (EPA 524.2 for: Trihalomethanes, Volatile Organics); (504.1 for: 1,2-Dibromoethane, 1,2-Dibromo-3-Chloropropane), EPA 332. Microbiology Parameters: SM9215B; ENZ. SUB. SM9223; ColilertQT SM9223B; MF-SM9222D.)

for: Al,Sb,As,Be,Cd,Ca,Cr,Co,Cu,Fe,Pb,Mg,Mn,Mo,Ni,K,Se,Ag,Na,Sr,Ti,Tl,V,Zn); 245.1, SM4500H,B, EPA 120.1, SM2510B, 2540C, 2340B, 2320B, 4500CL-E, 4500F-BC, 426C, SM4500NH3-BH, (EPA 350.1 for: Ammonia-N), LACHAT 10-107-06-1-B for Ammonia-N, SM4500NO3-F, 353.2 for Nitrate-N, SM4500NH3-BC-NES, EPA 351.1, SM4500P-E, 4500P-B,E, 5220D, EPA 410.4, SM 5210B, 5310C, 4500CL-D, EPA 1664, SM14 510AC, EPA 420.1, SM4500-CN-CE, SM2540D.

Organic Parameters: (EPA 624 for Volatile Halocarbons, Volatile Aromatics),(608 for: Chlordane, Toxaphene, Aldrin, alpha-BHC, beta-BHC, gamma-BHC, delta-BHC, Dieldrin, DDD, DDE, DDT,Endosulfan I, Endosulfan II, Endosulfan sulfate, Endrin, Endrin Aldehyde, Heptachlor, Heptachlor Epoxide, PCBs-Water), (EPA 625 for SVOC Acid Extractables and SVOC Base/Neutral Extractables), 600/4-81-045-PCB-Oil. Microbiology Parameters: (ColilertQT SM9223B; Enterolert-QT: SM9222D-MF.)

**New Hampshire Department of Environmental Services Certificate/Lab ID: 200307. *NELAP Accredited.***

*Drinking Water* (Inorganic Parameters: SM 9222B, 9223B, 9215B, EPA 200.7, 200.8, 300.0, SM4500CN-E, 4500H+B, 4500NO3-F, 2320B, 2510B, 2540C, 4500F-C, 5310C, 2120B, EPA 332.0. Organic Parameters: 504.1, 524.2.)

*Non-Potable Water* (Inorganic Parameters: SM9222D, 9221B, 9222B, 9221E-EC, EPA 3005A, 200.7, 200.8, 245.1, SW-846 6010B, 6010C, 6020, 6020A, 7196A, 7470A, SM3500-CR-D, EPA 120.1, 300.0, 350.1, 350.2, 351.1, 353.2, 410.4, 420.1, 426C, 1664A, SW-846 9010B, 9030B, 9040B, SM2120B, 2310B, 2320B, 2540B, 2540D, 4500H+B, 4500CL-E, 4500CN-E, 4500NH3-H, 4500NO3-F, 4500NO2-B, 4500P-E, 4500-S2-D, 5210B, 5220D, 2510B, 2540C, 4500F-C, 5310C, 5540C, LACHAT 10-204-00-1-A, LACHAT 10-107-06-2-D, 3060A. Organic Parameters: SW-846 3510C, 3630C, 5030B, 8260B, 8270C, 8270D, 8330, EPA 624, 625, 608, SW-846 8082, 8082A, 8081A, 8081B, 8151A, 8330, 8270C-SIM, 8270D-SIM.)

*Solid & Chemical Materials* (Inorganic Parameters: SW-846 6010B, 6010C, 7196A, 7471A, 1010, 1030, 9010, 9012A, 9014, 9030B, 9040B, 9045C, 9050, 9065,1311, 1312, 3005A, 3050B, 3060A. Organic Parameters: SW-846 3540C, 3546, 3050B, 3580A, 3630C, 5030B, 5035, 8260B, 8270C, 8270D, 8270C-SIM, 8270D-SIM, 8330, 8151A, 8015B, 8015C, 8082, 8082A, 8081A, 8081B.)

**New Jersey Department of Environmental Protection Certificate/Lab ID: MA935. *NELAP Accredited.***

*Drinking Water* (Inorganic Parameters: SM9222B, 9221E, 9223B, 9215B, 4500CN-CE, 4500NO3-F, 4500F-C, EPA 300.0, 200.7, 200.8, 245.1, 2540C, SM2120B, 2320B, 2510B, 5310C, SM4500H-B. Organic Parameters: EPA 332, 504.1, 524.2.)

*Non-Potable Water* (Inorganic Parameters: SM5210B, EPA 410.4, SM5220D, 4500CI-E, EPA 300.0, SM2120B, 2340B, SM4500F-BC, EPA 200.7, 200.8, 351.1, LACHAT 10-107-06-2-D, EPA 353.2, SM4500NO3-F, 4500NO2-B, EPA 1664A, SM5310B, C or D, 4500-PE, EPA 420.1, SM510ABC, SM4500P-B5+E, 2540B, 2540C, 2540D, 2540G, EPA 120.1, SM2510B, SM2520B, SM15 426C, 9222D, 9221B, 9221C, 9221E, 9222B, 9215B, 2310B, 2320B, 4500NH3-H, 4500-S D, EPA 350.1, 350.2, SW-846 1312, 7470A, 5540C, SM4500H-B, 4500SO3-B, SM3500Cr-D, 4500CN-CE, EPA 245.1, SW-846 9040B, 3005A, 3015, EPA 6010B, 6010C, 6020, 6020A, 7196A, 3060A, SW-846 9010B, 9030B. Organic Parameters: SW-846 8260B, 8260C, 8270C, 8270D, 8270C-SIM, 8270D-SIM, 3510C, EPA 608, 624, 625, SW-846 3630C, 5030B, 8015C, 8081A, 8081B, 8082, 8082A, 8151A, 8330, 1,4-Dioxane by NJ Modified 8270, 8015B, NJ EPH.)

*Solid & Chemical Materials* (Inorganic Parameters: SW-846, 6010B, 6010C, 6020, 6020A, 7196A, 3060A, 9010B, 9030B, 1010, 1030, 1311, 1312, 3005A, 3050B, 7471A, 7471B, 9014, 9012A, 9040B, 9040C, 9045C, 9045D, 9050A, 9065, 9251. Organic Parameters: SW-846 8015B, 8015C, 8081A, 8081B, 8082, 8082A, 8151A, 8330, 8260B, 8260C, 8270C, 8270D, 8270C-SIM, 8270D-SIM, 3540C, 3546, 3580A, 3630C, 5030B, 5035L, 5035H, NJ OQA-QAM-025 Rev.7, NJ EPH.)

**New York Department of Health Certificate/Lab ID: 11148. *NELAP Accredited.***

*Drinking Water* (Inorganic Parameters: SM9223B, 9222B, 9215B, EPA 200.8, 200.7, 245.2, SM5310C, EPA 332.0, SM2320B, EPA 300.0, SM2120B, 4500CN-E, 4500F-C, 4500NO3-F, 2540C, SM 2510B. Organic Parameters: EPA 524.2, 504.1.)

*Non-Potable Water* (Inorganic Parameters: SM9221E, 9222D, 9221B, 9222B, 9215B, 5210B, 5310C, EPA 410.4, SM5220D, 2310B-4a, 2320B, EPA 200.7, 300.0, SM4500CL-E, 4500F-C, SM15 426C, EPA 350.1, SM4500NH3-BH, EPA 351.1, LACHAT 10-107-06-2, EPA 353.2, SM4500-NO3-F, 4500-NO2-B, 4500P-E, 2540C, 2540B, 2540D, EPA 200.8, EPA 6010B, 6010C, 6020, 6020A, EPA 7196A, SM3500Cr-D, EPA 245.1, 245.2, 7470A, SM2120B, LACHAT 10-204-00-1-A, 4500CN-CE, EPA 1664A, EPA 420.1, SM14 510C, EPA 120.1, SM2510B, SM4500S-D, SM5540C, EPA 3005A, 3015, 9010B, 9030B. Organic Parameters: EPA 624, 8260B, 8260C, 8270C, 8270D, 8270C-SIM, 8270D-SIM, 625, 608, 8081A, 8081B, 8151A, 8330, 8082, 8082A, EPA 3510C, 5030B.)

*Solid & Hazardous Waste* (Inorganic Parameters: EPA 1010, 1030, EPA 6010B, 6010C, 7196A, 7471A, 7471B, 9012A, 9014, 9065, 9050A, EPA 1311, 1312, 3005A, 3050B, 9010B, 9040C, 9045D. Organic Parameters: EPA 8260B, 8260C, 8270C, 8270D, 8270C-SIM, 8270D-SIM, 8015B, 8015C, 8081A, 8081B, 8151A, 8330, 8082 8082A, 3540C, 3546, 3580, 3580A, 5030B, 5035A-H, 5035A-L.)



**North Carolina Department of the Environment and Natural Resources Certificate/Lab ID : 666. (Inorganic Parameters: SM2310B, 2320B, 4500Cl-E, 4500Cn-E, 9014, Lachat 10-204-00-1-X, 1010A, 1030, 4500NO3-F, 353.2, 4500P-E, 4500SO4-E, 300.0, 4500S-D, 5310B, 5310C, 6010C, 6020A, 200.7, 200.8, 3500Cr-B, 7196A, 245.1, 7471A, 7471B, 1311,1312. Organic Parameters: 608, 8081B, 8082A, 624, 8260B, 625, 8270D, 8151A, 8015C, 504.1, MA-EPH, MA-VPH.)**

*Drinking Water Program Certificate/Lab ID: 25700. (Inorganic Parameters: Chloride EPA 300.0. Organic Parameters: 524.2)*

**Pennsylvania Department of Environmental Protection Certificate/Lab ID : 68-03671. NELAP Accredited.**  
*Drinking Water (Inorganic Parameters: 200.7, 200.8, 245.2, 300.0, 332.0, 2120B, 2320B, 2510B, 2540C, 4500-CN-CE, 4500F-C, 4500H+-B, 4500NO3-F, 5310C. Organic Parameters: EPA 524.2, 504.1)*

*Non-Potable Water (Inorganic Parameters: EPA 120.1, 1312, 3005A,3015, 3060A, 200.7, 200.8, 410.4, 1664A, SM2540D, 5210B, 5220D, 4500-P,BE, 245.1, 300.0, 3501., 350.2, 353.2, 420.1, 6010B, 6010C, 6020, 6020A, 7196A, 7470A, 9010B, 9030B, 9040B, Lachat 10-107-06-2-D, NJ-EPH, 2120B, 2310B, 2320B, 2340B, 2510C, 2540B, 2540C, 3500Cr-D, 436C, 4500CN-CE, 4500Cl-E, 4500F-B, 4500F-C, 4500H+-B, 4500NO2-B, 4500NO3-F, 4500S-D, 4500SO3-B, 5310BCD, 5540C. Organic Parameters: EPA 3510C, 3630C, 5030B, 625, 624, 608, 8081A, 8081B, 8082, 8082A, 8151A, 8260B, 8270C, 8270D, 8330, 8015B, )*

*Solid & Hazardous Waste (Inorganic Parameters: EPA 350.1, 1010, 1030, 1311, 1312, 3005A, 3050B, 3060A, 6010B, 6010C, 6020A, 7196A, 7471A, 7471B, 9010B, 9012A, 9014, 9040B, 9045C, 9050, 9065, SM 4500NH3-BH, 9030B, 9038, 9251. Organic Parameters: 3540C, 3546, 3580A, 3630C, 5035, 8015B, 8015C, 8081A, 8081B, 8082, 8082A, 8151A, 8260B, 8270C, 8270D, 8270C-SIM, 8270D-SIM, 8330, NJ-EPH.)*

**Rhode Island Department of Health Certificate/Lab ID: LAO00065. NELAP Accredited via NJ-DEP.**

Refer to MA-DEP Certificate for Potable and Non-Potable Water.

Refer to NJ-DEP Certificate for Potable and Non-Potable Water.

**Texas Commission on Environmental Quality Certificate/Lab ID: T104704476-09-1. NELAP Accredited.**

*Non-Potable Water (Inorganic Parameters: EPA 120.1, 1664, 200.7, 200.8, 245.1, 245.2, 300.0, 350.1, 351.1, 353.2, 410.4, 420.1, 6010, 6020, 7196, 7470, 9040, SM 2120B, 2310B, 2320B, 2510B, 2540B, 2540C, 2540D, 426C, 4500CL-E, 4500CN-E, 4500F-C, 4500H+B, 4500NH3-H, 4500NO2B, 4500P-E, 4500 S<sup>2-</sup> D, 510C, 5210B, 5220D, 5310C, 5540C. Organic Parameters: EPA 608, 624, 625, 8081, 8082, 8151, 8260, 8270, 8330.)*

*Solid & Hazardous Waste (Inorganic Parameters: EPA 1311, 1312, 9012, 9014, 9040, 9045, 9050, 9065.)*

**Virginia Division of Consolidated Laboratory Services Certificate/Lab ID: 460195. NELAP Accredited.**

*Drinking Water (Inorganic Parameters: EPA 200.7, 200.8, 300.0, 2510B, 2120B, 2540C, 4500CN-CE, 245.2, 2320B, 4500F-C, 4500F-C, 4500NO3-F, 5310C. Organic Parameters: EPA 504.1, 524.2.)*

*Non-Potable Water (Inorganic Parameters: EPA 120.1, 1664A, 200.7, 2.08, 245.1, 300.0, 3005A, 3015, 1312, 6010B, 6010C, 3060A, 353.2, 420.1, 6020, 6020A, SM4500S-D, SM4500-CN-CE, Lachat 10-204-00-1-X, 7196A, 7470A, 9010B, 9040B, 2310B, 2320B, 2510B, 2540B, 2540C, 3500Cr-D, 426C, 4500Cl-E, 4500F-B, 4500F-C, 4500PE, 510AC, 5210B, 5310B 5310C, 5540C. Organic Parameters: EPA 3510C, 3630C, 5030B, 8260B, 608, 624, 625, 8081A, 8081B, 8082, 8082A, 8151A, 8270C, 8270D, 8270C-SIM, 8270D-SIM, 8330, )*

*Solid & Hazardous Waste (Inorganic Parameters: EPA 1010A, 1030, 3060A, 3050B, 1311, 1312, 6010B, 6010C, 6020, , 7196A, 7471A, 7471B, 6020A, 9030B, 9010B, 9012A, 9014 9040B, 9045C, 9050A, 9065. Organic Parameters: EPA 5035, 3540C, 3546, 3550, 3580, 3630C, 8260B, 8015B, 8015C, 8081A, 8081B, 8082, 8082A, 8151A, 8270C, 8270D, 8270C-SIM, 8270D-SIM, 8330.)*

**Department of Defense, L-A-B Certificate/Lab ID: L2217.**

*Drinking Water (Inorganic Parameters: SM 4500H-B. Organic Parameters: EPA 524.2, 504.1.)*

*Non-Potable Water (Inorganic Parameters: EPA 200.7, 200.8, 6010B, 6010C, 6020, 6020A, 245.1, 245.2, 7470A, 9040B, 9010B, 180.1. 300.0, 332.0, 6860, 353.2, 410.4, 9060, 1664A, SM 4500CN-E, 4500H-B, 4500NO3-F, 4500CL-D, 5220D, 5310C, 2130B, 2320B, 2540C, 3005A, 3015, 9010B, 9056. Organic Parameters: EPA 8260B, 8260C, 8270C, 8270D, 8270C-SIM, 8270D-SIM, 8330A, 8082, 8082A, 8081A, 8081B, 3510C, 5030B, MassDEP EPH, MassDEP VPH.)*

*Solid & Hazardous Waste (Inorganic Parameters: EPA 200.7, 6010B, 6010C, 7471A, 6860, 1311, 1312, 3050B, 7196A, 9010B, 9012A, 9040B, 9045C, 3500-CR-D, 4500CN-CE, 2540G, Organic Parameters: EPA 8260B, 8260C, 8270C, 8270D, 8270C-SIM, 8270D-SIM, 8330A/B-prep, 8082, 8082A, 8081A, 8081B, 3540C, 3546, 3580A, 5035A, MassDEP EPH, MassDEP VPH.)*

**The following analytes are not included in our current NELAP/TNI Scope of Accreditation:**

**EPA 8260B:** Freon-113, 1,2,4,5-Tetramethylbenzene, 4-Ethyltoluene. **EPA 8330A:** PETN, Picric Acid, Nitroglycerine, 2,6-DANT, 2,4-DANT. **EPA 8270C:** Methyl naphthalene, Dimethyl naphthalene, Total Methylnaphthalenes, Total Dimethylnaphthalenes, 1,4-Diphenylhydrazine (Azobenzene). **EPA 625:** 4-Chloroaniline, 4-Methylphenol. Total Phosphorus in a soil matrix, Chloride in a soil matrix, TKN in a soil matrix, NO<sub>2</sub> in a soil matrix, NO<sub>3</sub> in a soil matrix, SO<sub>4</sub> in a soil matrix. **EPA 9071:** Total Petroleum Hydrocarbons, Oil & Grease.



CHAIN OF CUSTODY RECORD

L1216912

Prof. No. G-3669		Project Name Selfridge Blvd 1533		No. of Containers 2		Remarks	
Date 9/19		Time 15:30		Station Location MW-16		Remarks	
Date Time 9/18 16:30		Received by: (Signature) <i>[Signature]</i>		Date Time 9/19 10:25		Received by: (Signature) <i>[Signature]</i>	
Date Time 9/20/12 10:00		Received by: (Signature) <i>[Signature]</i>		Date Time 9/20/12 15:15		Received by: (Signature) <i>[Signature]</i>	
Date Time 9/12/12 15:25		Received for Laboratory by: <i>[Signature]</i>		Remarks			

Radon Analysis (EPA Method GS: Grab Sample/Scintillation Cell counting)																	
<b>For GSI Environmental</b>					Client Project Number: ESTCP C51A/OSA Dem												
Samples Collected by: T. McHugh/L. Beckley					Sample Dates: 09/19/12												
Site: Mt. Clement, MI					Sample containers: Tedar bags w/ nylon fittings												
Analysts: Doug Hammond					Assumed Site Pressure: <b>0.97</b> atm												
Phone: 310-490-7896					based on an elevation of 608 ft												
email: dhammond@usc.edu					Time Zone adjustment: add to decay time												
					3 hours												
					Collect Run (EDT)												
					Run (PDT)												
Summary																	
Received	Collection		Analysis		Vol run (cc)	Conc. pCi/L	±1 sig pCi/L	Lab Duplicates		Notes							
	Date	Time (EDT)	Date	Time (PDT)				mean pCi/L	±1 ssd pCi/L								
Received 09/20/12																	
1	Amb-1-BL	9/19/12 11:10	9/20/12 12:08	120	0.08	0.04											
2	Ind-1-BL	9/19/12 11:10	9/20/12 12:11	120	0.42	0.06	0.37	0.07									
	lab dupe	9/19/12 11:10	9/21/12 8:35	120	0.32	0.09											
3	Ind-1-PP	9/19/12 14:05	9/20/12 14:05	60	0.19	0.07											
4	Ind-1-NP	9/19/12 16:30	9/20/12 12:16	120	0.28	0.05											
5	Dup-1 (field duplicate)	9/19/12 14:05	9/20/12 12:19	120	0.09	0.04											
Uncertainty given in pCi/liter is based on counting statistics for low activity samples. For high activity samples uncertainty is ±5%.																	
The Lower Limit of Detection for Rn (95% confidence level as recommended by EPA 402-R-95-012, Oct. 97) is 0.14 pCi/liter.																	
Results are reported based on standardization with NIST-traceable radon sources.																	
These results are for application of naturally-occurring radon as a tracer of soil vapor intrusion, but are not intended for evaluation of radon hazards.																	
Note Details:																	
Results corrected to in situ pressure as noted above																	
Raw Data, Calculation factors, and Analytical Details																	
Sample ID	Collection		Analysis		Count in cell/ch	He eff	Air/He eff	Vol run (cc)	Press factor	obs dpm	sig dpm	Decay T (hours)	Decay factor	Concentration		count stats pCi/liter ±1 sig	Notes
	Date	Time (EDT)	Date	Time (PDT)										dpm/liter	pCi/liter		
Received 09/20/12																	
1	Amb-1-BL	9/19/12 11:10	9/20/12 12:08	82/32	0.743	0.95	120	0.97	0.012	0.006	28.0	1.235	0.17	0.08	0.04		
2	Ind-1-BL	9/19/12 11:10	9/20/12 12:11	81/31	0.818	0.95	120	0.97	0.072	0.010	28.0	1.236	0.93	0.42	0.06		
	lab dupe	9/19/12 11:10	9/21/12 8:35	82/32	0.743	0.95	120	0.97	0.043	0.012	48.4	1.442	0.71	0.32	0.09		
3	Ind-1-PP	9/19/12 14:05	9/20/12 14:05	76/22	0.912	0.98	60	0.97	0.019	0.007	27.0	1.226	0.42	0.19	0.07		
4	Ind-1-NP	9/19/12 16:30	9/20/12 12:16	84/11	0.785	0.95	120	0.97	0.048	0.008	22.8	1.188	0.62	0.28	0.05		
5	Dup-1 (field duplicate)	9/19/12 14:05	9/20/12 12:19	83/33	0.806	0.95	120	0.97	0.015	0.007	25.2	1.210	0.19	0.09	0.04		
Decay corrections based on Rn decay constant of			0.1813 per day		Radon Conc = {(0.4504)(1000)(obs dpm)(decay factor)(Press factor)}/((cc used)(He eff)(Air/He))												
Conversion from dpm based on			0.4504 pCi/dpm		(in pCi/liter)												
Blanks are negligible.																	
<b>Definitions:</b>																	
Cell/ch:	Counting cell and channel used							sig dpm:	uncertainty (± 1 sig) in dpm based on counting statistics								
He eff:	Cell and counter efficiency using helium matrix							Decay T:	time elapsed from sampling to analysis								
Air/He:	Correction for matrix counting gas density							Decay factor:	Correction factor for decay from collection to analysis								
Sample vol:	Volume analyzed (cc)							dpm/liter:	Radon concentration in disintegrations per minute per liter of sample								
Press factor:	Correction to in situ pressure based on collection altitude							pCi/liter:	Radon concentration in picoCuries per liter								
obs dpm:	observed radon activity (disintegrations per minute) when analyzed							count stats:	uncertainty in observed radon based on counting statistics								

CHAIN OF CUSTODY RECORD

Proj No.	Project Name	Station Location		No. of Containers	Remarks																				
		Site	Time																						
3669	ESTEP C510/05A Dem				Results for: Tom Metchugh tometchugh@gsi.net Mike Beckley mbeckley@gsi.net FAR to 512-346-4476																				
Samples (Signature) TEM/LMB		Set Fringe ANG Dis - Building 1533																							
Sta. No.	Date	Time	Site	No. of Containers	Remarks																				
Amb-1-BL	9/19	1110	✓	1	Ambient-1-BL 500 mL in IL Tube																				
Ind-1-BL	9/19	1110	✓	1	Indoor-1-BL																				
Ind-1-PP	9/19	1405	✓	1	Indoor-1-PP																				
Ind-1-NP	9/19	1630	✓	1	Indoor-1-NP																				
DUP 1	9/19		✓	1	DUP 1 ↓																				
<table border="1" style="width:100%; border-collapse: collapse;"> <thead> <tr> <th>Retinquished by: (Signature)</th> <th>Date Time</th> <th>Received by: (Signature)</th> <th>Date Time</th> </tr> </thead> <tbody> <tr> <td><i>[Signature]</i></td> <td>9/19/12 1800</td> <td><i>[Signature]</i></td> <td>9/29/12</td> </tr> <tr> <td></td> <td></td> <td></td> <td>11:35</td> </tr> <tr> <th>Retinquished by: (Signature)</th> <th>Date Time</th> <th>Received for Laboratory by: (Signature)</th> <th>Date Time</th> </tr> <tr> <td></td> <td></td> <td></td> <td></td> </tr> </tbody> </table>						Retinquished by: (Signature)	Date Time	Received by: (Signature)	Date Time	<i>[Signature]</i>	9/19/12 1800	<i>[Signature]</i>	9/29/12				11:35	Retinquished by: (Signature)	Date Time	Received for Laboratory by: (Signature)	Date Time				
Retinquished by: (Signature)	Date Time	Received by: (Signature)	Date Time																						
<i>[Signature]</i>	9/19/12 1800	<i>[Signature]</i>	9/29/12																						
			11:35																						
Retinquished by: (Signature)	Date Time	Received for Laboratory by: (Signature)	Date Time																						

reruns of OU#613 (the older sample set), analyzed in the week of October 22nd

RUN #	Date of Analysis	SAMPLE ID	AIRTUBE #	TCE
9068	10/22/2012	3-SS-2-CSI	C16_J03553	-19.5
9069	10/22/2012	1-SS-2-CSI	C16_J07342	no peak
9071	10/22/2012	1-IA-1-CSI	C16_J07242	peak coelutes

OU#631 (the newer sample set)

Dup = split of the sample recollected on Cx1016

**Benzene**

RUN #	Date of Analysis	SAMPLE ID	AIRTUBE #	Benzene
9020	10/9/2012	SS-2 Low	C16_J04853	-28.9
9024	10/10/2012	SS-2 1hr	C16_K08430	-29.4
9025	10/10/2012	SS-2 High	C16_J06645	-31.1
9029	10/11/2012	Dup of SS-2 High	C16_J03770	-31.0
9082	10/24/2012	Dup of SS-2 High	C16_J03770	-31.4
9030	10/11/2012	SS-1	C16_J03738	-29.8
9023	10/10/2012	SS-1	C16_J03973	-29.9
9038	10/15/2012	Dup of Indoor 1	C16_K08440	-29.4
9042	10/16/2012	Indoor 1	C16_K08448	-29.0
9043	10/16/2012	Indoor 1 overnight	C16_J03120	-29.9
9081	10/24/2012	Dup of Indoor 1 overnight	C16_K08412	-29.7
1876	10/24/2012	ground water sample		-26.5
1878	10/24/2012	ground water sample		-26.6

**TCE**

RUN #	Date of Analysis	SAMPLE ID	AIRTUBE #	TCE
9076	10/23/2012	SS-2 1 hr	C16_J03150	-26.0
9065	10/21/2012	Dup of SS-2 High	C16_J03770	-25.0
9066	10/21/2012	Dup of SS-2 High	C16_J03770	-25.6
9074	10/22/2012	Dup of SS-1	C16_J03738	-18.8
9072	10/22/2012	Dup of Indoor 1	C16_K08440	-32.3
9077	10/23/2012	Dup of Indoor 1	C16_K08448	-32.4
9079	10/24/2012	Indoor 1 overnight	C16_K08412	-30.7

this number is likely 1-2 permit to peak was too tall, resulting with c may be rerun if there is spare mat

o heavy;  
ombusion problem;  
terial after PCE analysis.



Received by GSI, 3 May 2013

Results of additional analyses of SANG samples:

**OU#631 benzene**

Dup = split of the sample recollected on Cx1016

all tube numbers refer to the original samples collected in the field

analytical uncertainty defined by the standards  $\pm 0.2$  (2 stdevs at n=13 in Oct-12, n=6 in April-13)

**NOTE: Only 10-20 ng of benzene on "SS-2 low". Possible problems caused by low level carryover or adsorbent pyrolysis byproduct**

run #	date analyzed	sample ID	original airtube #	del benzene VPDB	remarks
1876		ground water sample	na	-26.5	
1878		ground water sample	na	-26.6	
9042	10/16/2012	Indoor 1	C16_K08448	-29.1	intact original tube
9038	10/15/2012	Dup Indoor 1	C16_K08440	-29.0	
9498	4/24/2013	Dup Indoor 1	C16_K08421	-28.9	split of an intact original tube, collected in April 2013
9500	4/24/2013	Dup Indoor 1	C16_K08421	-28.8	split of run #9498
9043	10/16/2012	Indoor 1 overnight	C16_J03120	-30.0	intact original tube
9081	10/24/2012	Dup Indoor 1 overnight	C16_K08412	-29.8	
9023	10/10/2012	SS-1	C16_J03973	-29.9	intact original tube
9030	10/11/2012	SS-1	C16_J03738	-29.8	intact original tube
9491	4/19/2013	SS-1	C16_K08431	-29.7	intact original tube
9493	4/19/2013	Dup SS-1	C16_K08431	-29.8	split of run #9491
9024	10/10/2012	SS-2 1hr	C16_K08430	-29.4	intact original tube
9496	4/23/2013	SS-2 1 hr	C16_J03150	-29.4	split of the original tube, collected in October 2012
9499	4/24/2013	Dup SS-2 1 hr	C16_J03150	-29.3	split of run #9496
9020	10/9/2012	SS-2 Low	C16_J04853	-28.9	intact original tube
9492	4/19/2013	SS-2 Low	C16_J07661	-30.2	intact original tube
9025	10/10/2012	SS-2 High	C16_J06645	-31.1	intact original tube
9029	10/11/2012	Dup SS-2 High	C16_J03770	-31.0	
9082	10/24/2012	Dup SS-2 High	C16_J03770	-31.5	

Received by GSI, 3 May 2013

Results of additional analyses of SANG samples:

**OU#631 TCE**

Dup = split of the sample recollected on Cx1016

all tube numbers refer to the original samples collected in the field

analytical uncertainty defined by the standards: Oct-12  $\pm$  0.6 (2 stdevs at n=7); April-13  $\pm$  0.4 (2 stdevs at n=10)

**NOTE: samples from Oct-2012 suffered from noisy background. Possible accuracy offsets by a few tenths of permil**

run #	date analyzed	sample ID	original airtube #	del TCE VPDB	remarks	
9072	10/22/2012	Dup Indoor 1	C16_K08440	-32.5		
9077	10/23/2012	Dup Indoor 1	C16_K08448	-32.6		
9485	4/17/2013	Indoor 1	C16_K08457	-31.8	intact original tube	
9488	4/18/2013	Dup Indoor 1	C16_J03146	-31.8	split of run #9485	
9079	10/23/2012	Indoor 1 overnight	C16_K08412	-31.0	intact original tube	this number is likely 1-2 permil too heavy; peak was too tall, resultin
9074	10/22/2012	Dup SS-1	C16_J03738	-18.7		
9076	10/23/2012	SS-2 1 hr	C16_J03150	-26.2	intact original tube	
9065	10/21/2012	Dup SS-2 High	C16_J03770	-25.2		
9066	10/21/2012	Dup SS-2 High	C16_J03770	-25.8		
9484	4/17/2013	SS-2 High	C16_J07356	-24.6	intact original tube	

Received by GSI, 3 May 2013

Results of additional analyses of SANG samples:

**OU#631 PCE**

Dup = split of the sample recollected on Cx1016

all tube numbers refer to the original samples collected in the field

analytical uncertainty defined by the standards:  $\pm 0.3$  (2 stdevs at n=8)

**NOTE: the indoor samples likely affected by too low signal and proportionally high background noise.**

run #	date analyzed	sample ID	original airtube #	del PCE VPDB	remarks	
9421	4/1/2013	Indoor 1	C16_K08448	-27.8	split of an intact original tube, collected in Oct 2012	peak amplitude below the calibration range
9414	3/29/2013	Indoor 1 overnight	C16_J03120	-27.8	split of an intact original tube, collected in Oct 2012	peak amplitude below the calibration range
9434	4/4/2013	Indoor 1 overnight	C16_J07366	-26.3	intact original tube	peak amplitude at the lower end of calibration range
9436	4/5/2013	Indoor 1 overnight	C16_J07064	-26.2	intact original tube	peak amplitude below the calibration range
9427	4/3/2013	SS-1	C16_J03738	-26.5	split of an intact original tube, collected in Oct 2012	
9429	4/3/2013	Dup SS-1	C16_J03703	-26.8	split of run #9427	
9437		SS-1	C16_M17689	-26.1	split of run #9429	
9425	4/1/2013	SS-2 1 hr	C16_J03116	-25.3	split of an intact original tube, collected in April 2013	
9433	4/4/2013	Dup SS-2 1 hr (#9425)	C16_J03116	-25.3	split of run #9425	
9428	4/3/2013	SS-2 Low (#9415)	C16_J04342	-25.7	split of an intact original tube, collected in April 2013	
9438	4/5/2013	SS-2 Low (NEW)	C16_J03146	-25.5	intact original tube	
9419	4/1/2013	SS-2 High	C16_J03770	-25.5	split of an intact original tube, collected in Oct 2012	

# **Tyndall Air Force Base, Florida**

## LABORATORY REPORT

March 13, 2013

Tom McHugh  
GSI Environmental Inc.  
2211 Norfolk, Suite 1000  
Houston, TX 77098

**RE: ESTCP VI Study - Tyndall AFB / 3585/3669**

Dear Tom:

Enclosed are the results of the samples submitted to our laboratory on February 28, 2013. For your reference, these analyses have been assigned our service request number P1300816.

All analyses were performed according to our laboratory's NELAP and DoD-ELAP-approved quality assurance program. The test results meet requirements of the current NELAP and DoD-ELAP standards, where applicable, and except as noted in the laboratory case narrative provided. For a specific list of NELAP and DoD-ELAP-accredited analytes, refer to the certifications section at [www.caslab.com](http://www.caslab.com). Results are intended to be considered in their entirety and apply only to the samples analyzed and reported herein.

If you have any questions, please call me at (805) 526-7161.

Respectfully submitted,

**ALS | Environmental**



By Sue Anderson at 2:55 pm, Mar 13, 2013

Sue Anderson  
Project Manager

Client: GSI Environmental Inc.  
Project: ESTCP VI Study - Tyndall AFB / 3585/3669

Service Request No: P1300816

---

## CASE NARRATIVE

The samples were received intact under chain of custody on February 28, 2013 and were stored in accordance with the analytical method requirements. Please refer to the sample acceptance check form for additional information. The results reported herein are applicable only to the condition of the samples at the time of sample receipt.

### Volatile Organic Compound Analysis

The samples were analyzed in SIM mode for selected volatile organic compounds in accordance with EPA Method TO-15 from the Compendium of Methods for the Determination of Toxic Organic Compounds in Ambient Air, Second Edition (EPA/625/R-96/010b), January, 1999. The analytical system was comprised of a gas chromatograph / mass spectrometer (GC/MS) interfaced to a whole-air preconcentrator.

The response for the 3rd internal standard in samples 219-SS-2 (P1300816-013) and 219-SS-3 (P1300816-014) was outside control criteria because of suspected matrix interference. The samples were diluted in an attempt to eliminate the effects of the matrix interference. The results are reported from the dilution; therefore, the associated method reporting limits have been elevated accordingly.

The Summa canisters were cleaned, prior to sampling, down to the method reporting limit (MRL) reported for this project. Please note, projects which require reporting below the MRL could have results between the MRL and method detection limit (MDL) that are biased high.

---

*The results of analyses are given in the attached laboratory report. All results are intended to be considered in their entirety, and Columbia Analytical Services, Inc. dba ALS Environmental (ALS) is not responsible for utilization of less than the complete report.*

*Use of Columbia Analytical Services, Inc. dba ALS Environmental (ALS)'s Name. Client shall not use ALS's name or trademark in any marketing or reporting materials, press releases or in any other manner ("Materials") whatsoever and shall not attribute to ALS any test result, tolerance or specification derived from ALS's data ("Attribution") without ALS's prior written consent, which may be withheld by ALS for any reason in its sole discretion. To request ALS's consent, Client shall provide copies of the proposed Materials or Attribution and describe in writing Client's proposed use of such Materials or Attribution. If ALS has not provided written approval of the Materials or Attribution within ten (10) days of receipt from Client, Client's request to use ALS's name or trademark in any Materials or Attribution shall be deemed denied. ALS may, in its discretion, reasonably charge Client for its time in reviewing Materials or Attribution requests. Client acknowledges and agrees that the unauthorized use of ALS's name or trademark may cause ALS to incur irreparable harm for which the recovery of money damages will be inadequate. Accordingly, Client acknowledges and agrees that a violation shall justify preliminary injunctive relief. For questions contact the laboratory.*

Columbia Analytical Services, Inc. dba ALS Environmental – Simi Valley  
 Certifications, Accreditations, and Registrations

Agency	Web Site	Number
AIHA	<a href="http://www.aihaaccreditedlabs.org">http://www.aihaaccreditedlabs.org</a>	101661
Arizona DHS	<a href="http://www.azdhs.gov/lab/license/env.htm">http://www.azdhs.gov/lab/license/env.htm</a>	AZ0694
DoD ELAP	<a href="http://www.pjlabs.com/search-accredited-labs">http://www.pjlabs.com/search-accredited-labs</a>	L11-203
Florida DOH (NELAP)	<a href="http://www.doh.state.fl.us/lab/EnvLabCert/WaterCert.htm">http://www.doh.state.fl.us/lab/EnvLabCert/WaterCert.htm</a>	E871020
Maine DHHS	<a href="http://www.maine.gov/dhhs/mecdc/environmental-health/water/dwp-services/labcert/labcert.htm">http://www.maine.gov/dhhs/mecdc/environmental-health/water/dwp-services/labcert/labcert.htm</a>	2012039
Minnesota DOH (NELAP)	<a href="http://www.health.state.mn.us/accreditation">http://www.health.state.mn.us/accreditation</a>	494864
New Jersey DEP (NELAP)	<a href="http://www.nj.gov/dep/oqa/">http://www.nj.gov/dep/oqa/</a>	CA009
New York DOH (NELAP)	<a href="http://www.wadsworth.org/labcert/elap/elap.html">http://www.wadsworth.org/labcert/elap/elap.html</a>	11221
Oregon PHD (NELAP)	<a href="http://public.health.oregon.gov/LaboratoryServices/EnvironmentalLaboratoryAccreditation/Pages/index.aspx">http://public.health.oregon.gov/LaboratoryServices/EnvironmentalLaboratoryAccreditation/Pages/index.aspx</a>	CA200007
Pennsylvania DEP	<a href="http://www.depweb.state.pa.us/labs">http://www.depweb.state.pa.us/labs</a>	68-03307 (Registration)
Texas CEQ (NELAP)	<a href="http://www.tceq.texas.gov/field/qa/env_lab_accreditation.html">http://www.tceq.texas.gov/field/qa/env_lab_accreditation.html</a>	T104704413-12-3
Utah DOH (NELAP)	<a href="http://www.health.utah.gov/lab/labimp/certification/index.html">http://www.health.utah.gov/lab/labimp/certification/index.html</a>	CA01527201 2-2
Washington DOE	<a href="http://www.ecy.wa.gov/programs/eap/labs/lab-accreditation.html">http://www.ecy.wa.gov/programs/eap/labs/lab-accreditation.html</a>	C946

Analyses were performed according to our laboratory’s NELAP and DoD-ELAP approved quality assurance program. A complete listing of specific NELAP and DoD-ELAP certified analytes can be found in the certifications section at [www.caslab.com](http://www.caslab.com), [www.alsglobal.com](http://www.alsglobal.com), or at the accreditation body’s website.

Each of the certifications listed above have an explicit Scope of Accreditation that applies to specific matrices/methods/analytes; therefore, please contact the laboratory for information corresponding to a particular certification.

DETAIL SUMMARY REPORT

Client: GSI Environmental Inc.  
 Project ID: ESTCP VI Study - Tyndall AFB / 3585/3669

Service Request: P1300816

Date Received: 2/28/2013  
 Time Received: 09:05

TO-15 - VOC SIM

Client Sample ID	Lab Code	Matrix	Date Collected	Time Collected	Container ID	Pi1 (psig)	Pf1 (psig)	
156-IA-1	P1300816-001	Air	2/20/2013	16:18	AS00290	-1.97	3.63	X
156-IA-2	P1300816-002	Air	2/20/2013	16:19	AS00217	-4.69	3.50	X
156-IA-3	P1300816-003	Air	2/20/2013	16:19	AC01816	-3.63	3.50	X
219-AA-1	P1300816-004	Air	2/20/2013	16:41	AS00341	-3.12	3.50	X
219-IA-1	P1300816-005	Air	2/20/2013	16:00	AS00230	-3.02	3.59	X
219-IA-3	P1300816-006	Air	2/20/2013	16:38	AC01904	-3.58	3.60	X
156-IA-4-NP	P1300816-007	Air	2/21/2013	15:57	AS00216	0.18	3.60	X
156-IA-5-NP	P1300816-008	Air	2/21/2013	15:57	AS00166	-0.67	3.64	X
156-SS-1	P1300816-009	Air	2/21/2013	11:53	AS00198	-0.40	3.78	X
156-SS-2	P1300816-010	Air	2/21/2013	11:42	AS00141	-0.02	3.82	X
156-SS-3	P1300816-011	Air	2/21/2013	11:26	AS00336	-1.37	3.56	X
219-SS-1	P1300816-012	Air	2/21/2013	16:16	AS00168	-0.25	3.62	X
219-SS-2	P1300816-013	Air	2/21/2013	16:28	AS00182	0.02	3.67	X
219-SS-3	P1300816-014	Air	2/21/2013	16:45	AS00310	0.12	3.81	X
156-IA-4-BL	P1300816-015	Air	2/22/2013	08:04	AS00199	-0.03	3.75	X





2655 Park Center Drive, Suite A  
 Simi Valley, California 93065  
 Phone (805) 526-7161  
 Fax (805) 526-7270

# Air - Chain of Custody Record & Analytical Service Request

Requested Turnaround Time in Business Days (Surcharges) please circle  
 1 Day (100%) 2 Day (75%) 3 Day (50%) 4 Day (35%) 5 Day (25%) 10 Day-Standard

CAS Project No. K300816

Company Name & Address (Reporting Information) <i>GSI Environmental 2201 Norfolk St 1000 Houston TX 77098</i>		Project Name <i>ESTCP VI Study - Tyndall AFB</i>		CAS Contact: <i>Sue Anderson</i>		Analysis Method <i>10-15 SIM *PC6, TC6, CS, VC Trans, 110CE, VC</i>		Comments e.g. Actual Preservative or specific instructions	
Project Manager <i>Tom McHugh / Lila Beckley</i>		Project Number <i>3585/3669</i>		Flow Controller ID (Bar code # - FC #)		Canister Start Pressure "Hg		Canister End Pressure "Hg/psig	
P.O. # / Billing Information		Sampler (Print & Sign) <i>TEM/ED/MB/VPS</i>		Canister ID (Bar code # - AC, SC, etc.)		Canister Start Pressure "Hg		Canister End Pressure "Hg/psig	
Laboratory ID Number		Date Collected		Time Collected		Sample Volume			
Client Sample ID		Date Collected		Time Collected		Sample Volume			
Email Address for Result Reporting <i>lbeckley@gsi-net.com</i>		Date Collected		Time Collected		Sample Volume			
Phone <i>713-522-6300</i>		Date Collected		Time Collected		Sample Volume			
Fax <i>713-522-6300</i>		Date Collected		Time Collected		Sample Volume			
Tier I - Results (Default if not specified)		Tier II (Results + QC Summaries)		Tier III (Results + QC & Calibration Summaries)		Tier IV (Data Validation Package) 10% Surcharge		EDD required (Yes/No) Type: <i>1/29/13</i>	
Relinquished by: (Signature) <i>[Signature]</i>		Date: <i>4/22/13</i> Time: <i>1050</i>		Received by: (Signature) <i>[Signature]</i>		Date: <i>2/29/13</i> Time: <i>0905</i>		Project Requirements (MRLs, QAPP)	
Relinquished by: (Signature) <i>[Signature]</i>		Date: _____ Time: _____		Received by: (Signature)		Date: _____ Time: _____		Cooler / Blank Temperature _____ °C	



**Sample Acceptance Check Form**

Client: GSI Environmental Inc. Work order: P1300816

Project: ESTCP VI Study - Tyndall AFB / 3585/3669

Sample(s) received on: 2/28/13 Date opened: 2/28/13 by: RMARTENIES

**Note:** This form is used for all samples received by ALS. The use of this form for custody seals is strictly meant to indicate presence/absence and not as an indication of compliance or nonconformity. Thermal preservation and pH will only be evaluated either at the request of the client and/or as required by the method/SOP.

- |  | <b>Yes</b>                          | <b>No</b>                           | <b>N/A</b>                          |
|--|-------------------------------------|-------------------------------------|-------------------------------------|
| 1 Were <b>sample containers</b> properly marked with client sample ID?   | <input checked="" type="checkbox"/> | <input type="checkbox"/>            | <input type="checkbox"/>            |
| 2 Container(s) <b>supplied by ALS</b> ?  | <input checked="" type="checkbox"/> | <input type="checkbox"/>            | <input type="checkbox"/>            |
| 3 Did <b>sample containers</b> arrive in good condition?   | <input checked="" type="checkbox"/> | <input type="checkbox"/>            | <input type="checkbox"/>            |
| 4 Were <b>chain-of-custody</b> papers used and filled out?   | <input checked="" type="checkbox"/> | <input type="checkbox"/>            | <input type="checkbox"/>            |
| 5 Did <b>sample container labels</b> and/or tags agree with custody papers?                                      | <input checked="" type="checkbox"/> | <input type="checkbox"/>            | <input type="checkbox"/>            |
| 6 Was <b>sample volume</b> received adequate for analysis?   | <input checked="" type="checkbox"/> | <input type="checkbox"/>            | <input type="checkbox"/>            |
| 7 Are samples within specified holding times?  | <input checked="" type="checkbox"/> | <input type="checkbox"/>            | <input type="checkbox"/>            |
| 8 Was proper <b>temperature</b> (thermal preservation) of cooler at receipt adhered to?                          | <input type="checkbox"/>            | <input type="checkbox"/>            | <input checked="" type="checkbox"/> |
| 9 Was a <b>trip blank</b> received?  | <input type="checkbox"/>            | <input checked="" type="checkbox"/> | <input type="checkbox"/>            |
| 10 Were <b>custody seals</b> on outside of cooler/Box?   | <input type="checkbox"/>            | <input checked="" type="checkbox"/> | <input type="checkbox"/>            |
| Location of seal(s)? _____ Sealing Lid?  | <input type="checkbox"/>            | <input type="checkbox"/>            | <input checked="" type="checkbox"/> |
| Were signature and date included?  | <input type="checkbox"/>            | <input type="checkbox"/>            | <input checked="" type="checkbox"/> |
| Were seals intact?   | <input type="checkbox"/>            | <input type="checkbox"/>            | <input checked="" type="checkbox"/> |
| Were custody seals on outside of sample container?   | <input type="checkbox"/>            | <input checked="" type="checkbox"/> | <input type="checkbox"/>            |
| Location of seal(s)? _____ Sealing Lid?  | <input type="checkbox"/>            | <input type="checkbox"/>            | <input checked="" type="checkbox"/> |
| Were signature and date included?  | <input type="checkbox"/>            | <input type="checkbox"/>            | <input checked="" type="checkbox"/> |
| Were seals intact?   | <input type="checkbox"/>            | <input type="checkbox"/>            | <input checked="" type="checkbox"/> |
| 11 Do containers have appropriate <b>preservation</b> , according to method/SOP or Client specified information? | <input type="checkbox"/>            | <input type="checkbox"/>            | <input checked="" type="checkbox"/> |
| Is there a client indication that the submitted samples are <b>pH</b> preserved?                                 | <input type="checkbox"/>            | <input type="checkbox"/>            | <input checked="" type="checkbox"/> |
| Were <b>VOA vials</b> checked for presence/absence of air bubbles?   | <input type="checkbox"/>            | <input type="checkbox"/>            | <input checked="" type="checkbox"/> |
| Does the client/method/SOP require that the analyst check the sample pH and <u>if necessary</u> alter it?        | <input type="checkbox"/>            | <input type="checkbox"/>            | <input checked="" type="checkbox"/> |
| 12 <b>Tubes:</b> Are the tubes capped and intact?  | <input type="checkbox"/>            | <input type="checkbox"/>            | <input checked="" type="checkbox"/> |
| Do they contain moisture?  | <input type="checkbox"/>            | <input type="checkbox"/>            | <input checked="" type="checkbox"/> |
| 13 <b>Badges:</b> Are the badges properly capped and intact?   | <input type="checkbox"/>            | <input type="checkbox"/>            | <input checked="" type="checkbox"/> |
| Are dual bed badges separated and individually capped and intact?  | <input type="checkbox"/>            | <input type="checkbox"/>            | <input checked="" type="checkbox"/> |

Lab Sample ID	Container Description	Required pH *	Received pH	Adjusted pH	VOA Headspace (Presence/Absence)	Receipt / Preservation Comments
P1300816-001.01	6.0 L Silonite Can					
P1300816-002.01	6.0 L Silonite Can					
P1300816-003.01	6.0 L Ambient Can					
P1300816-004.01	6.0 L Silonite Can					
P1300816-005.01	6.0 L Silonite Can					
P1300816-006.01	6.0 L Ambient Can					
P1300816-007.01	6.0 L Silonite Can					
P1300816-008.01	6.0 L Silonite Can					

Explain any discrepancies: (include lab sample ID numbers): \_\_\_\_\_



RESULTS OF ANALYSIS

Page 1 of 1

**Client:** GSI Environmental Inc.

**Client Sample ID:** 156-IA-1

**Client Project ID:** ESTCP VI Study - Tyndall AFB / 3585/3669

CAS Project ID: P1300816

CAS Sample ID: P1300816-001

Test Code: EPA TO-15 SIM

Date Collected: 2/20/13

Instrument ID: Tekmar AUTOCAN/Agilent 5975Cinert/7890A/MS19

Date Received: 2/28/13

Analyst: Wida Ang

Date Analyzed: 3/6/13

Sample Type: 6.0 L Summa Canister

Volume(s) Analyzed: 1.00 Liter(s)

Test Notes:

Container ID: AS00290

Initial Pressure (psig): -1.97      Final Pressure (psig): 3.63

Canister Dilution Factor: 1.44

CAS #	Compound	Result	MRL	Result	MRL	Data Qualifier
		µg/m <sup>3</sup>	µg/m <sup>3</sup>	ppbV	ppbV	
75-01-4	Vinyl Chloride	ND	0.036	ND	0.014	
75-35-4	1,1-Dichloroethene	ND	0.036	ND	0.0091	
156-60-5	trans-1,2-Dichloroethene	ND	0.036	ND	0.0091	
156-59-2	cis-1,2-Dichloroethene	ND	0.036	ND	0.0091	
79-01-6	Trichloroethene	ND	0.036	ND	0.0067	
127-18-4	Tetrachloroethene	<b>0.054</b>	0.036	<b>0.0080</b>	0.0053	

ND = Compound was analyzed for, but not detected above the laboratory reporting limit.

MRL = Method Reporting Limit - The minimum quantity of a target analyte that can be confidently determined by the referenced method.

RESULTS OF ANALYSIS

Page 1 of 1

**Client:** GSI Environmental Inc.

**Client Sample ID:** 156-IA-2

**Client Project ID:** ESTCP VI Study - Tyndall AFB / 3585/3669

CAS Project ID: P1300816

CAS Sample ID: P1300816-002

Test Code: EPA TO-15 SIM

Date Collected: 2/20/13

Instrument ID: Tekmar AUTOCAN/Agilent 5975Cinert/7890A/MS19

Date Received: 2/28/13

Analyst: Wida Ang

Date Analyzed: 3/6/13

Sample Type: 6.0 L Summa Canister

Volume(s) Analyzed: 1.00 Liter(s)

Test Notes:

Container ID: AS00217

Initial Pressure (psig): -4.69      Final Pressure (psig): 3.50

Canister Dilution Factor: 1.82

CAS #	Compound	Result	MRL	Result	MRL	Data Qualifier
		µg/m <sup>3</sup>	µg/m <sup>3</sup>	ppbV	ppbV	
75-01-4	Vinyl Chloride	ND	0.046	ND	0.018	
75-35-4	1,1-Dichloroethene	ND	0.046	ND	0.011	
156-60-5	trans-1,2-Dichloroethene	ND	0.046	ND	0.011	
156-59-2	cis-1,2-Dichloroethene	ND	0.046	ND	0.011	
79-01-6	Trichloroethene	ND	0.046	ND	0.0085	
127-18-4	Tetrachloroethene	<b>0.063</b>	0.046	<b>0.0092</b>	0.0067	

ND = Compound was analyzed for, but not detected above the laboratory reporting limit.

MRL = Method Reporting Limit - The minimum quantity of a target analyte that can be confidently determined by the referenced method.

RESULTS OF ANALYSIS

Page 1 of 1

**Client:** GSI Environmental Inc.

**Client Sample ID:** 156-IA-3

**Client Project ID:** ESTCP VI Study - Tyndall AFB / 3585/3669

CAS Project ID: P1300816

CAS Sample ID: P1300816-003

Test Code: EPA TO-15 SIM

Date Collected: 2/20/13

Instrument ID: Tekmar AUTOCAN/Agilent 5975Cinert/7890A/MS19

Date Received: 2/28/13

Analyst: Wida Ang

Date Analyzed: 3/6/13

Sample Type: 6.0 L Summa Canister

Volume(s) Analyzed: 1.00 Liter(s)

Test Notes:

Container ID: AC01816

Initial Pressure (psig): -3.63      Final Pressure (psig): 3.50

Canister Dilution Factor: 1.64

CAS #	Compound	Result	MRL	Result	MRL	Data Qualifier
		µg/m <sup>3</sup>	µg/m <sup>3</sup>	ppbV	ppbV	
75-01-4	Vinyl Chloride	ND	0.041	ND	0.016	
75-35-4	1,1-Dichloroethene	ND	0.041	ND	0.010	
156-60-5	trans-1,2-Dichloroethene	ND	0.041	ND	0.010	
156-59-2	cis-1,2-Dichloroethene	ND	0.041	ND	0.010	
79-01-6	Trichloroethene	ND	0.041	ND	0.0076	
127-18-4	Tetrachloroethene	<b>0.60</b>	0.041	<b>0.088</b>	0.0060	

ND = Compound was analyzed for, but not detected above the laboratory reporting limit.

MRL = Method Reporting Limit - The minimum quantity of a target analyte that can be confidently determined by the referenced method.

RESULTS OF ANALYSIS

Page 1 of 1

**Client:** GSI Environmental Inc.

**Client Sample ID:** 219-AA-1

**Client Project ID:** ESTCP VI Study - Tyndall AFB / 3585/3669

CAS Project ID: P1300816

CAS Sample ID: P1300816-004

Test Code: EPA TO-15 SIM

Date Collected: 2/20/13

Instrument ID: Tekmar AUTOCAN/Agilent 5975Cinert/7890A/MS19

Date Received: 2/28/13

Analyst: Wida Ang

Date Analyzed: 3/6/13

Sample Type: 6.0 L Summa Canister

Volume(s) Analyzed: 1.00 Liter(s)

Test Notes:

Container ID: AS00341

Initial Pressure (psig): -3.12      Final Pressure (psig): 3.50

Canister Dilution Factor: 1.57

CAS #	Compound	Result µg/m <sup>3</sup>	MRL µg/m <sup>3</sup>	Result ppbV	MRL ppbV	Data Qualifier
75-01-4	Vinyl Chloride	ND	0.039	ND	0.015	
75-35-4	1,1-Dichloroethene	ND	0.039	ND	0.0099	
156-60-5	trans-1,2-Dichloroethene	ND	0.039	ND	0.0099	
156-59-2	cis-1,2-Dichloroethene	ND	0.039	ND	0.0099	
79-01-6	Trichloroethene	ND	0.039	ND	0.0073	
127-18-4	Tetrachloroethene	ND	0.039	ND	0.0058	

ND = Compound was analyzed for, but not detected above the laboratory reporting limit.

MRL = Method Reporting Limit - The minimum quantity of a target analyte that can be confidently determined by the referenced method.



RESULTS OF ANALYSIS

Page 1 of 1

**Client:** GSI Environmental Inc.

**Client Sample ID:** 219-IA-1

**Client Project ID:** ESTCP VI Study - Tyndall AFB / 3585/3669

CAS Project ID: P1300816

CAS Sample ID: P1300816-005

Test Code: EPA TO-15 SIM

Date Collected: 2/20/13

Instrument ID: Tekmar AUTOCAN/Agilent 5975Cinert/7890A/MS19

Date Received: 2/28/13

Analyst: Wida Ang

Date Analyzed: 3/6/13

Sample Type: 6.0 L Summa Canister

Volume(s) Analyzed: 1.00 Liter(s)

Test Notes:

Container ID: AS00230

Initial Pressure (psig): -3.02      Final Pressure (psig): 3.59

Canister Dilution Factor: 1.57

CAS #	Compound	Result	MRL	Result	MRL	Data Qualifier
		µg/m <sup>3</sup>	µg/m <sup>3</sup>	ppbV	ppbV	
75-01-4	Vinyl Chloride	ND	0.039	ND	0.015	
75-35-4	1,1-Dichloroethene	ND	0.039	ND	0.0099	
156-60-5	trans-1,2-Dichloroethene	ND	0.039	ND	0.0099	
156-59-2	cis-1,2-Dichloroethene	ND	0.039	ND	0.0099	
79-01-6	Trichloroethene	<b>0.086</b>	0.039	<b>0.016</b>	0.0073	
127-18-4	Tetrachloroethene	<b>0.048</b>	0.039	<b>0.0071</b>	0.0058	

ND = Compound was analyzed for, but not detected above the laboratory reporting limit.

MRL = Method Reporting Limit - The minimum quantity of a target analyte that can be confidently determined by the referenced method.

RESULTS OF ANALYSIS

Page 1 of 1

**Client:** GSI Environmental Inc.

**Client Sample ID:** 219-IA-3

**Client Project ID:** ESTCP VI Study - Tyndall AFB / 3585/3669

CAS Project ID: P1300816

CAS Sample ID: P1300816-006

Test Code: EPA TO-15 SIM

Date Collected: 2/20/13

Instrument ID: Tekmar AUTOCAN/Agilent 5975Cinert/7890A/MS19

Date Received: 2/28/13

Analyst: Wida Ang

Date Analyzed: 3/6/13

Sample Type: 6.0 L Summa Canister

Volume(s) Analyzed: 1.00 Liter(s)

Test Notes:

Container ID: AC01904

Initial Pressure (psig): -3.58      Final Pressure (psig): 3.60

Canister Dilution Factor: 1.65

CAS #	Compound	Result	MRL	Result	MRL	Data Qualifier
		µg/m <sup>3</sup>	µg/m <sup>3</sup>	ppbV	ppbV	
75-01-4	Vinyl Chloride	ND	0.041	ND	0.016	
75-35-4	1,1-Dichloroethene	ND	0.041	ND	0.010	
156-60-5	trans-1,2-Dichloroethene	ND	0.041	ND	0.010	
156-59-2	cis-1,2-Dichloroethene	ND	0.041	ND	0.010	
79-01-6	Trichloroethene	<b>0.087</b>	0.041	<b>0.016</b>	0.0077	
127-18-4	Tetrachloroethene	ND	0.041	ND	0.0061	

ND = Compound was analyzed for, but not detected above the laboratory reporting limit.

MRL = Method Reporting Limit - The minimum quantity of a target analyte that can be confidently determined by the referenced method.

RESULTS OF ANALYSIS

Page 1 of 1

**Client:** GSI Environmental Inc.

**Client Sample ID:** 156-IA-4-NP

**Client Project ID:** ESTCP VI Study - Tyndall AFB / 3585/3669

CAS Project ID: P1300816

CAS Sample ID: P1300816-007

Test Code: EPA TO-15 SIM

Date Collected: 2/21/13

Instrument ID: Tekmar AUTOCAN/Agilent 5975Cinert/7890A/MS19

Date Received: 2/28/13

Analyst: Wida Ang

Date Analyzed: 3/6/13

Sample Type: 6.0 L Summa Canister

Volume(s) Analyzed: 1.00 Liter(s)

Test Notes:

Container ID: AS00216

Initial Pressure (psig): 0.18      Final Pressure (psig): 3.60

Canister Dilution Factor: 1.23

CAS #	Compound	Result	MRL	Result	MRL	Data Qualifier
		µg/m <sup>3</sup>	µg/m <sup>3</sup>	ppbV	ppbV	
75-01-4	Vinyl Chloride	ND	0.031	ND	0.012	
75-35-4	1,1-Dichloroethene	ND	0.031	ND	0.0078	
156-60-5	trans-1,2-Dichloroethene	ND	0.031	ND	0.0078	
156-59-2	cis-1,2-Dichloroethene	ND	0.031	ND	0.0078	
79-01-6	Trichloroethene	ND	0.031	ND	0.0057	
127-18-4	Tetrachloroethene	<b>0.061</b>	0.031	<b>0.0090</b>	0.0045	

ND = Compound was analyzed for, but not detected above the laboratory reporting limit.

MRL = Method Reporting Limit - The minimum quantity of a target analyte that can be confidently determined by the referenced method.

RESULTS OF ANALYSIS

Page 1 of 1

**Client:** GSI Environmental Inc.

**Client Sample ID:** 156-IA-5-NP

**Client Project ID:** ESTCP VI Study - Tyndall AFB / 3585/3669

CAS Project ID: P1300816

CAS Sample ID: P1300816-008

Test Code: EPA TO-15 SIM

Date Collected: 2/21/13

Instrument ID: Tekmar AUTOCAN/Agilent 5975Cinert/7890A/MS19

Date Received: 2/28/13

Analyst: Wida Ang

Date Analyzed: 3/6/13

Sample Type: 6.0 L Summa Canister

Volume(s) Analyzed: 1.00 Liter(s)

Test Notes:

Container ID: AS00166

Initial Pressure (psig): -0.67      Final Pressure (psig): 3.64

Canister Dilution Factor: 1.31

CAS #	Compound	Result	MRL	Result	MRL	Data Qualifier
		µg/m <sup>3</sup>	µg/m <sup>3</sup>	ppbV	ppbV	
75-01-4	Vinyl Chloride	ND	0.033	ND	0.013	
75-35-4	1,1-Dichloroethene	ND	0.033	ND	0.0083	
156-60-5	trans-1,2-Dichloroethene	ND	0.033	ND	0.0083	
156-59-2	cis-1,2-Dichloroethene	ND	0.033	ND	0.0083	
79-01-6	Trichloroethene	ND	0.033	ND	0.0061	
127-18-4	Tetrachloroethene	<b>0.062</b>	0.033	<b>0.0092</b>	0.0048	

ND = Compound was analyzed for, but not detected above the laboratory reporting limit.

MRL = Method Reporting Limit - The minimum quantity of a target analyte that can be confidently determined by the referenced method.

RESULTS OF ANALYSIS

Page 1 of 1

**Client:** GSI Environmental Inc.

**Client Sample ID:** 156-SS-1

**Client Project ID:** ESTCP VI Study - Tyndall AFB / 3585/3669

CAS Project ID: P1300816

CAS Sample ID: P1300816-009

Test Code: EPA TO-15 SIM

Date Collected: 2/21/13

Instrument ID: Tekmar AUTOCAN/Agilent 5975Cinert/7890A/MS19

Date Received: 2/28/13

Analyst: Wida Ang

Date Analyzed: 3/6/13

Sample Type: 6.0 L Summa Canister

Volume(s) Analyzed: 1.00 Liter(s)

Test Notes:

Container ID: AS00198

Initial Pressure (psig): -0.40      Final Pressure (psig): 3.78

Canister Dilution Factor: 1.29

CAS #	Compound	Result	MRL	Result	MRL	Data Qualifier
		µg/m <sup>3</sup>	µg/m <sup>3</sup>	ppbV	ppbV	
75-01-4	Vinyl Chloride	ND	0.032	ND	0.013	
75-35-4	1,1-Dichloroethene	ND	0.032	ND	0.0081	
156-60-5	trans-1,2-Dichloroethene	ND	0.032	ND	0.0081	
156-59-2	cis-1,2-Dichloroethene	ND	0.032	ND	0.0081	
79-01-6	Trichloroethene	<b>0.37</b>	0.032	<b>0.068</b>	0.0060	
127-18-4	Tetrachloroethene	<b>0.26</b>	0.032	<b>0.039</b>	0.0048	

ND = Compound was analyzed for, but not detected above the laboratory reporting limit.

MRL = Method Reporting Limit - The minimum quantity of a target analyte that can be confidently determined by the referenced method.

RESULTS OF ANALYSIS

Page 1 of 1

**Client:** GSI Environmental Inc.

**Client Sample ID:** 156-SS-2

**Client Project ID:** ESTCP VI Study - Tyndall AFB / 3585/3669

CAS Project ID: P1300816

CAS Sample ID: P1300816-010

Test Code: EPA TO-15 SIM

Date Collected: 2/21/13

Instrument ID: Tekmar AUTOCAN/Agilent 5975Cinert/7890A/MS19

Date Received: 2/28/13

Analyst: Wida Ang

Date Analyzed: 3/6/13

Sample Type: 6.0 L Summa Canister

Volume(s) Analyzed: 1.00 Liter(s)

Test Notes:

Container ID: AS00141

Initial Pressure (psig): -0.02      Final Pressure (psig): 3.82

Canister Dilution Factor: 1.26

CAS #	Compound	Result	MRL	Result	MRL	Data Qualifier
		µg/m <sup>3</sup>	µg/m <sup>3</sup>	ppbV	ppbV	
75-01-4	Vinyl Chloride	ND	0.032	ND	0.012	
75-35-4	1,1-Dichloroethene	ND	0.032	ND	0.0079	
156-60-5	trans-1,2-Dichloroethene	ND	0.032	ND	0.0079	
156-59-2	cis-1,2-Dichloroethene	ND	0.032	ND	0.0079	
79-01-6	Trichloroethene	<b>1.2</b>	0.032	<b>0.23</b>	0.0059	
127-18-4	Tetrachloroethene	<b>0.16</b>	0.032	<b>0.023</b>	0.0046	

ND = Compound was analyzed for, but not detected above the laboratory reporting limit.

MRL = Method Reporting Limit - The minimum quantity of a target analyte that can be confidently determined by the referenced method.

RESULTS OF ANALYSIS

Page 1 of 1

**Client:** GSI Environmental Inc.

**Client Sample ID:** 156-SS-3

**Client Project ID:** ESTCP VI Study - Tyndall AFB / 3585/3669

CAS Project ID: P1300816

CAS Sample ID: P1300816-011

Test Code: EPA TO-15 SIM

Date Collected: 2/21/13

Instrument ID: Tekmar AUTOCAN/Agilent 5975Cinert/7890A/MS19

Date Received: 2/28/13

Analyst: Wida Ang

Date Analyzed: 3/6/13

Sample Type: 6.0 L Summa Canister

Volume(s) Analyzed: 1.00 Liter(s)

Test Notes:

Container ID: AS00336

Initial Pressure (psig): -1.37      Final Pressure (psig): 3.56

Canister Dilution Factor: 1.37

CAS #	Compound	Result	MRL	Result	MRL	Data Qualifier
		µg/m <sup>3</sup>	µg/m <sup>3</sup>	ppbV	ppbV	
75-01-4	Vinyl Chloride	ND	0.034	ND	0.013	
75-35-4	1,1-Dichloroethene	ND	0.034	ND	0.0086	
156-60-5	trans-1,2-Dichloroethene	<b>0.051</b>	0.034	<b>0.013</b>	0.0086	
156-59-2	cis-1,2-Dichloroethene	<b>0.085</b>	0.034	<b>0.021</b>	0.0086	
79-01-6	Trichloroethene	<b>24</b>	0.034	<b>4.4</b>	0.0064	
127-18-4	Tetrachloroethene	<b>0.45</b>	0.034	<b>0.066</b>	0.0051	

ND = Compound was analyzed for, but not detected above the laboratory reporting limit.

MRL = Method Reporting Limit - The minimum quantity of a target analyte that can be confidently determined by the referenced method.

RESULTS OF ANALYSIS

Page 1 of 1

**Client:** GSI Environmental Inc.

**Client Sample ID:** 219-SS-1

**Client Project ID:** ESTCP VI Study - Tyndall AFB / 3585/3669

CAS Project ID: P1300816

CAS Sample ID: P1300816-012

Test Code: EPA TO-15 SIM

Date Collected: 2/21/13

Instrument ID: Tekmar AUTOCAN/Agilent 5975Cinert/7890A/MS19

Date Received: 2/28/13

Analyst: Wida Ang

Date Analyzed: 3/6/13

Sample Type: 6.0 L Summa Canister

Volume(s) Analyzed: 1.00 Liter(s)

Test Notes:

Container ID: AS00168

Initial Pressure (psig): -0.25      Final Pressure (psig): 3.62

Canister Dilution Factor: 1.27

CAS #	Compound	Result	MRL	Result	MRL	Data Qualifier
		µg/m <sup>3</sup>	µg/m <sup>3</sup>	ppbV	ppbV	
75-01-4	Vinyl Chloride	ND	0.032	ND	0.012	
75-35-4	1,1-Dichloroethene	ND	0.032	ND	0.0080	
156-60-5	trans-1,2-Dichloroethene	<b>0.14</b>	0.032	<b>0.036</b>	0.0080	
156-59-2	cis-1,2-Dichloroethene	ND	0.032	ND	0.0080	
79-01-6	Trichloroethene	<b>0.083</b>	0.032	<b>0.015</b>	0.0059	
127-18-4	Tetrachloroethene	<b>4.5</b>	0.032	<b>0.67</b>	0.0047	

ND = Compound was analyzed for, but not detected above the laboratory reporting limit.

MRL = Method Reporting Limit - The minimum quantity of a target analyte that can be confidently determined by the referenced method.



RESULTS OF ANALYSIS

Page 1 of 1

**Client:** GSI Environmental Inc.

**Client Sample ID:** 219-SS-2

**Client Project ID:** ESTCP VI Study - Tyndall AFB / 3585/3669

CAS Project ID: P1300816

CAS Sample ID: P1300816-013

Test Code: EPA TO-15 SIM

Date Collected: 2/21/13

Instrument ID: Tekmar AUTOCAN/Agilent 5975Cinert/7890A/MS19

Date Received: 2/28/13

Analyst: Wida Ang

Date Analyzed: 3/7/13

Sample Type: 6.0 L Summa Canister

Volume(s) Analyzed: 0.25 Liter(s)

Test Notes:

Container ID: AS00182

Initial Pressure (psig): 0.02      Final Pressure (psig): 3.67

Canister Dilution Factor: 1.25

CAS #	Compound	Result	MRL	Result	MRL	Data Qualifier
		µg/m <sup>3</sup>	µg/m <sup>3</sup>	ppbV	ppbV	
75-01-4	Vinyl Chloride	ND	0.13	ND	0.049	
75-35-4	1,1-Dichloroethene	ND	0.13	ND	0.032	
156-60-5	trans-1,2-Dichloroethene	<b>0.41</b>	0.13	<b>0.10</b>	0.032	
156-59-2	cis-1,2-Dichloroethene	ND	0.13	ND	0.032	
79-01-6	Trichloroethene	<b>0.31</b>	0.13	<b>0.057</b>	0.023	
127-18-4	Tetrachloroethene	<b>7.5</b>	0.13	<b>1.1</b>	0.018	

ND = Compound was analyzed for, but not detected above the laboratory reporting limit.

MRL = Method Reporting Limit - The minimum quantity of a target analyte that can be confidently determined by the referenced method.

RESULTS OF ANALYSIS

Page 1 of 1

**Client:** GSI Environmental Inc.

**Client Sample ID:** 219-SS-3

**Client Project ID:** ESTCP VI Study - Tyndall AFB / 3585/3669

CAS Project ID: P1300816

CAS Sample ID: P1300816-014

Test Code: EPA TO-15 SIM

Date Collected: 2/21/13

Instrument ID: Tekmar AUTOCAN/Agilent 5975Cinert/7890A/MS19

Date Received: 2/28/13

Analyst: Wida Ang

Date Analyzed: 3/7/13

Sample Type: 6.0 L Summa Canister

Volume(s) Analyzed: 0.50 Liter(s)

Test Notes:

Container ID: AS00310

Initial Pressure (psig): 0.12      Final Pressure (psig): 3.81

Canister Dilution Factor: 1.25

CAS #	Compound	Result	MRL	Result	MRL	Data Qualifier
		µg/m <sup>3</sup>	µg/m <sup>3</sup>	ppbV	ppbV	
75-01-4	Vinyl Chloride	ND	0.063	ND	0.024	
75-35-4	1,1-Dichloroethene	ND	0.063	ND	0.016	
156-60-5	trans-1,2-Dichloroethene	ND	0.063	ND	0.016	
156-59-2	cis-1,2-Dichloroethene	ND	0.063	ND	0.016	
79-01-6	Trichloroethene	<b>1.3</b>	0.063	<b>0.24</b>	0.012	
127-18-4	Tetrachloroethene	<b>0.97</b>	0.063	<b>0.14</b>	0.0092	

ND = Compound was analyzed for, but not detected above the laboratory reporting limit.

MRL = Method Reporting Limit - The minimum quantity of a target analyte that can be confidently determined by the referenced method.

RESULTS OF ANALYSIS

Page 1 of 1

**Client:** GSI Environmental Inc.

**Client Sample ID:** 156-IA-4-BL

**Client Project ID:** ESTCP VI Study - Tyndall AFB / 3585/3669

CAS Project ID: P1300816

CAS Sample ID: P1300816-015

Test Code: EPA TO-15 SIM

Date Collected: 2/22/13

Instrument ID: Tekmar AUTOCAN/Agilent 5975Cinert/7890A/MS19

Date Received: 2/28/13

Analyst: Wida Ang

Date Analyzed: 3/6/13

Sample Type: 6.0 L Summa Canister

Volume(s) Analyzed: 1.00 Liter(s)

Test Notes:

Container ID: AS00199

Initial Pressure (psig): -0.03      Final Pressure (psig): 3.75

Canister Dilution Factor: 1.26

CAS #	Compound	Result	MRL	Result	MRL	Data Qualifier
		µg/m <sup>3</sup>	µg/m <sup>3</sup>	ppbV	ppbV	
75-01-4	Vinyl Chloride	ND	0.032	ND	0.012	
75-35-4	1,1-Dichloroethene	ND	0.032	ND	0.0079	
156-60-5	trans-1,2-Dichloroethene	ND	0.032	ND	0.0079	
156-59-2	cis-1,2-Dichloroethene	ND	0.032	ND	0.0079	
79-01-6	Trichloroethene	ND	0.032	ND	0.0059	
127-18-4	Tetrachloroethene	<b>0.077</b>	0.032	<b>0.011</b>	0.0046	

ND = Compound was analyzed for, but not detected above the laboratory reporting limit.

MRL = Method Reporting Limit - The minimum quantity of a target analyte that can be confidently determined by the referenced method.

RESULTS OF ANALYSIS

Page 1 of 1

**Client:** GSI Environmental Inc.  
**Client Sample ID:** Method Blank  
**Client Project ID:** ESTCP VI Study - Tyndall AFB / 3585/3669

CAS Project ID: P1300816  
 CAS Sample ID: P130305-MB

Test Code: EPA TO-15 SIM  
 Instrument ID: Tekmar AUTOCAN/Agilent 5975Cinert/7890A/MS19  
 Analyst: Wida Ang  
 Sample Type: 6.0 L Summa Canister  
 Test Notes:

Date Collected: NA  
 Date Received: NA  
 Date Analyzed: 3/5/13  
 Volume(s) Analyzed: 1.00 Liter(s)

Canister Dilution Factor: 1.00

CAS #	Compound	Result µg/m <sup>3</sup>	MRL µg/m <sup>3</sup>	Result ppbV	MRL ppbV	Data Qualifier
75-01-4	Vinyl Chloride	ND	0.025	ND	0.0098	
75-35-4	1,1-Dichloroethene	ND	0.025	ND	0.0063	
156-60-5	trans-1,2-Dichloroethene	ND	0.025	ND	0.0063	
156-59-2	cis-1,2-Dichloroethene	ND	0.025	ND	0.0063	
79-01-6	Trichloroethene	ND	0.025	ND	0.0047	
127-18-4	Tetrachloroethene	ND	0.025	ND	0.0037	

ND = Compound was analyzed for, but not detected above the laboratory reporting limit.

MRL = Method Reporting Limit - The minimum quantity of a target analyte that can be confidently determined by the referenced method.

RESULTS OF ANALYSIS

Page 1 of 1

**Client:** GSI Environmental Inc.  
**Client Sample ID:** Method Blank  
**Client Project ID:** ESTCP VI Study - Tyndall AFB / 3585/3669

CAS Project ID: P1300816  
 CAS Sample ID: P130306-MB

Test Code: EPA TO-15 SIM  
 Instrument ID: Tekmar AUTOCAN/Agilent 5975Cinert/7890A/MS19  
 Analyst: Wida Ang  
 Sample Type: 6.0 L Summa Canister  
 Test Notes:

Date Collected: NA  
 Date Received: NA  
 Date Analyzed: 3/6/13  
 Volume(s) Analyzed: 1.00 Liter(s)

Canister Dilution Factor: 1.00

CAS #	Compound	Result µg/m <sup>3</sup>	MRL µg/m <sup>3</sup>	Result ppbV	MRL ppbV	Data Qualifier
75-01-4	Vinyl Chloride	ND	0.025	ND	0.0098	
75-35-4	1,1-Dichloroethene	ND	0.025	ND	0.0063	
156-60-5	trans-1,2-Dichloroethene	ND	0.025	ND	0.0063	
156-59-2	cis-1,2-Dichloroethene	ND	0.025	ND	0.0063	
79-01-6	Trichloroethene	ND	0.025	ND	0.0047	
127-18-4	Tetrachloroethene	ND	0.025	ND	0.0037	

ND = Compound was analyzed for, but not detected above the laboratory reporting limit.

MRL = Method Reporting Limit - The minimum quantity of a target analyte that can be confidently determined by the referenced method.

SURROGATE SPIKE RECOVERY RESULTS

Page 1 of 1

**Client:** GSI Environmental Inc.  
**Client Project ID:** ESTCP VI Study - Tyndall AFB / 3585/3669

CAS Project ID: P1300816

**Test Code:** EPA TO-15 SIM  
**Instrument ID:** Tekmar AUTOCAN/Agilent 5975Cinert/7890A/MS19  
**Analyst:** Wida Ang  
**Sample Type:** 6.0 L Summa Canister(s)  
**Test Notes:**

**Date(s) Collected:** 2/20 - 2/22/13  
**Date(s) Received:** 2/28/13  
**Date(s) Analyzed:** 3/5 - 3/7/13

Client Sample ID	CAS Sample ID	1,2-Dichloroethane-d4	Toluene-d8	Bromofluorobenzene	Acceptance Limits	Data Qualifier
		% Recovered	% Recovered	% Recovered		
Method Blank	P130305-MB	97	100	106	70-130	
Method Blank	P130306-MB	100	101	98	70-130	
Lab Control Sample	P130305-LCS	99	99	107	70-130	
Lab Control Sample	P130306-LCS	99	100	99	70-130	
156-IA-1	P1300816-001	98	101	99	70-130	
156-IA-2	P1300816-002	97	100	94	70-130	
156-IA-3	P1300816-003	97	101	97	70-130	
219-AA-1	P1300816-004	97	101	99	70-130	
219-AA-1	P1300816-004DUP	99	101	99	70-130	
219-IA-1	P1300816-005	95	100	104	70-130	
219-IA-3	P1300816-006	96	101	100	70-130	
156-IA-4-NP	P1300816-007	96	102	99	70-130	
156-IA-5-NP	P1300816-008	99	105	95	70-130	
156-SS-1	P1300816-009	96	105	96	70-130	
156-SS-2	P1300816-010	90	99	92	70-130	
156-SS-3	P1300816-011	97	102	97	70-130	
219-SS-1	P1300816-012	100	103	96	70-130	
219-SS-2	P1300816-013	101	106	82	70-130	
219-SS-3	P1300816-014	98	101	73	70-130	
156-IA-4-BL	P1300816-015	98	103	96	70-130	

Surrogate percent recovery is verified and accepted based on the on-column result.

Reported results are shown in concentration units and as a result of the calculation, may vary slightly from the on-column percent recovery.

LABORATORY CONTROL SAMPLE SUMMARY

Page 1 of 1

**Client:** GSI Environmental Inc.

**Client Sample ID:** Lab Control Sample

**Client Project ID:** ESTCP VI Study - Tyndall AFB / 3585/3669

CAS Project ID: P1300816

CAS Sample ID: P130305-LCS

Test Code: EPA TO-15 SIM

Date Collected: NA

Instrument ID: Tekmar AUTOCAN/Agilent 5975Cinert/7890A/MS19

Date Received: NA

Analyst: Wida Ang

Date Analyzed: 3/05/13

Sample Type: 6.0 L Summa Canister

Volume(s) Analyzed: 0.125 Liter(s)

Test Notes:

CAS #	Compound	Spike Amount µg/m <sup>3</sup>	Result µg/m <sup>3</sup>	% Recovery	CAS	Data Qualifier
					Acceptance Limits	
75-01-4	Vinyl Chloride	4.00	<b>3.19</b>	<b>80</b>	56-117	
75-35-4	1,1-Dichloroethene	4.36	<b>3.52</b>	<b>81</b>	62-113	
156-60-5	trans-1,2-Dichloroethene	4.04	<b>3.11</b>	<b>77</b>	61-111	
156-59-2	cis-1,2-Dichloroethene	4.28	<b>3.30</b>	<b>77</b>	63-112	
79-01-6	Trichloroethene	3.96	<b>3.04</b>	<b>77</b>	58-113	
127-18-4	Tetrachloroethene	3.80	<b>3.12</b>	<b>82</b>	60-111	

Laboratory Control Sample percent recovery is verified and accepted based on the on-column result. Reported results are shown in concentration units and as a result of the calculation, may vary slightly.

LABORATORY CONTROL SAMPLE SUMMARY

Page 1 of 1

**Client:** GSI Environmental Inc.  
**Client Sample ID:** Lab Control Sample  
**Client Project ID:** ESTCP VI Study - Tyndall AFB / 3585/3669  
 CAS Project ID: P1300816  
 CAS Sample ID: P130306-LCS  
 Test Code: EPA TO-15 SIM  
 Instrument ID: Tekmar AUTOCAN/Agilent 5975Cinert/7890A/MS19  
 Analyst: Wida Ang  
 Sample Type: 6.0 L Summa Canister  
 Test Notes:  
 Date Collected: NA  
 Date Received: NA  
 Date Analyzed: 3/06/13  
 Volume(s) Analyzed: 0.125 Liter(s)

CAS #	Compound	Spike Amount µg/m <sup>3</sup>	Result µg/m <sup>3</sup>	% Recovery	CAS	Data Qualifier
					Acceptance Limits	
75-01-4	Vinyl Chloride	4.00	<b>3.18</b>	<b>80</b>	56-117	
75-35-4	1,1-Dichloroethene	4.36	<b>3.58</b>	<b>82</b>	62-113	
156-60-5	trans-1,2-Dichloroethene	4.04	<b>3.15</b>	<b>78</b>	61-111	
156-59-2	cis-1,2-Dichloroethene	4.28	<b>3.33</b>	<b>78</b>	63-112	
79-01-6	Trichloroethene	3.96	<b>3.04</b>	<b>77</b>	58-113	
127-18-4	Tetrachloroethene	3.80	<b>3.00</b>	<b>79</b>	60-111	

Laboratory Control Sample percent recovery is verified and accepted based on the on-column result. Reported results are shown in concentration units and as a result of the calculation, may vary slightly.



LABORATORY DUPLICATE SUMMARY RESULTS

Page 1 of 1

**Client:** GSI Environmental Inc.

**Client Sample ID:** 219-AA-1

**Client Project ID:** ESTCP VI Study - Tyndall AFB / 3585/3669

CAS Project ID: P1300816

CAS Sample ID: P1300816-004DUP

Test Code: EPA TO-15 SIM

Date Collected: 2/20/13

Instrument ID: Tekmar AUTOCAN/Agilent 5975Cinert/7890A/MS19

Date Received: 2/28/13

Analyst: Wida Ang

Date Analyzed: 3/6/13

Sample Type: 6.0 L Summa Canister

Volume(s) Analyzed: 1.00 Liter(s)

Test Notes:

Container ID: AS00341

Initial Pressure (psig): -3.12

Final Pressure (psig): 3.50

Canister Dilution Factor: 1.57

CAS #	Compound	Sample Result		Duplicate Sample Result		Average µg/m <sup>3</sup>	% RPD	RPD Limit	Data Qualifier
		µg/m <sup>3</sup>	ppbV	µg/m <sup>3</sup>	ppbV				
75-01-4	Vinyl Chloride	ND	ND	ND	ND	-	-	25	
75-35-4	1,1-Dichloroethene	ND	ND	ND	ND	-	-	25	
156-60-5	trans-1,2-Dichloroethene	ND	ND	ND	ND	-	-	25	
156-59-2	cis-1,2-Dichloroethene	ND	ND	ND	ND	-	-	25	
79-01-6	Trichloroethene	ND	ND	ND	ND	-	-	25	
127-18-4	Tetrachloroethene	ND	ND	ND	ND	-	-	25	

ND = Compound was analyzed for, but not detected above the laboratory reporting limit.

RESULTS OF ANALYSIS

Page 1 of 1

**Client:** GSI Environmental Inc.  
**Client Project ID:** ESTCP VI Study - Tyndall AFB / 3585/3669 CAS Project ID: P1300816

**Method Blank Summary**

Test Code: EPA TO-15 SIM  
Instrument ID: Tekmar AUTOCAN/Agilent 5975Cinert/7890A/MS19 Lab File ID: 03051334.D  
Analyst: Wida Ang Date Analyzed: 3/05/13  
Sample Type: 6.0 L Summa Canister(s) Time Analyzed: 23:20  
Test Notes:

Client Sample ID	CAS Sample ID	Lab File ID	Time Analyzed
Lab Control Sample	P130305-LCS	03051335.D	23:52
156-IA-1	P1300816-001	03051340.D	07:10
156-IA-2	P1300816-002	03051341.D	07:43
156-IA-3	P1300816-003	03051342.D	08:15
219-AA-1	P1300816-004	03051343.D	08:47
219-AA-1 (Lab Duplicate)	P1300816-004DUP	03051344.D	09:19
219-IA-1	P1300816-005	03051345.D	09:51
219-IA-3	P1300816-006	03051346.D	10:24
156-IA-4-NP	P1300816-007	03051347.D	10:57
156-IA-5-NP	P1300816-008	03051348.D	11:29
156-SS-1	P1300816-009	03051349.D	12:01
156-SS-2	P1300816-010	03051350.D	12:34
156-SS-3	P1300816-011	03051351.D	13:07
219-SS-1	P1300816-012	03051352.D	13:39
156-IA-4-BL	P1300816-015	03051355.D	16:14

## RESULTS OF ANALYSIS

Page 1 of 1

**Client:** GSI Environmental Inc.  
**Client Project ID:** ESTCP VI Study - Tyndall AFB / 3585/3669 CAS Project ID: P1300816

**Method Blank Summary**

Test Code: EPA TO-15 SIM  
Instrument ID: Tekmar AUTOCAN/Agilent 5975Cinert/7890A/MS19 Lab File ID: 03061304.D  
Analyst: Wida Ang Date Analyzed: 3/06/13  
Sample Type: 6.0 L Summa Canister(s) Time Analyzed: 19:18  
Test Notes:

Client Sample ID	CAS Sample ID	Lab File ID	Time Analyzed
Lab Control Sample	P130306-LCS	03061305.D	19:50
219-SS-3	P1300816-014	03061316.D	08:09
219-SS-2	P1300816-013	03061318.D	09:40

RESULTS OF ANALYSIS

Page 1 of 1

**Client:** GSI Environmental Inc.  
**Client Project ID:** ESTCP VI Study - Tyndall AFB / 3585/3669 **CAS Project ID:** P1300816

**Internal Standard Area and RT Summary**

**Test Code:** EPA TO-15 SIM  
**Instrument ID:** Tekmar AUTOCAN/Agilent 5975Cinert/7890A/MS19 **Lab File ID:** 03051332.D  
**Analyst:** Wida Ang **Date Analyzed:** 3/5/13  
**Sample Type:** 6.0 L Summa Canister(s) **Time Analyzed:** 22:14  
**Test Notes:**

	IS1 (BCM)		IS2 (DFB)		IS3 (CBZ)						
	AREA	#	RT	#	AREA	#	RT	#			
<b>24 Hour Standard</b>	59632		11.66		246745		13.40		27518		17.09
<b>Upper Limit</b>	83485		11.99		345443		13.73		38525		17.42
<b>Lower Limit</b>	35779		11.33		148047		13.07		16511		16.76

Client Sample ID		IS1 (BCM)	IS2 (DFB)	IS3 (CBZ)			
Client Sample ID		AREA	RT	AREA	RT	AREA	RT
01	Method Blank	59530	11.66	243742	13.41	27667	17.09
02	Lab Control Sample	60103	11.66	250192	13.40	27840	17.09
03	156-IA-1	66682	11.65	279416	13.40	32769	17.09
04	156-IA-2	64825	11.66	276641	13.40	31874	17.09
05	156-IA-3	63874	11.66	272688	13.40	32519	17.09
06	219-AA-1	63890	11.65	273069	13.40	32084	17.09
07	219-AA-1 (Lab Duplicate)	61616	11.65	278003	13.40	33030	17.09
08	219-IA-1	61631	11.66	256625	13.40	29557	17.09
09	219-IA-3	62201	11.65	260120	13.40	30924	17.09
10	156-IA-4-NP	63527	11.66	268633	13.40	32561	17.09
11	156-IA-5-NP	63520	11.66	276155	13.41	34052	17.09
12	156-SS-1	60341	11.66	256493	13.41	34419	17.09
13	156-SS-2	66494	11.66	272563	13.41	33185	17.09
14	156-SS-3	65624	11.67	277989	13.41	33982	17.09
15	219-SS-1	65859	11.66	287746	13.41	35714	17.09
16	156-IA-4-BL	65583	11.66	281342	13.40	35185	17.09
17							
18							
19							
20							

IS1 (BCM) = Bromochloromethane  
 IS2 (DFB) = 1,4-Difluorobenzene  
 IS3 (CBZ) = Chlorobenzene-d5

AREA UPPER LIMIT = 140% of internal standard area  
 AREA LOWER LIMIT = 60% of internal standard area  
 RT UPPER LIMIT = 0.33 minutes of internal standard RT  
 RT LOWER LIMIT = 0.33 minutes of internal standard RT

# Column used to flag values outside QC limits with an I.  
 I = Internal standard not within the specified limits. See case narrative.

RESULTS OF ANALYSIS

Page 1 of 1

**Client:** GSI Environmental Inc.  
**Client Project ID:** ESTCP VI Study - Tyndall AFB / 3585/3669 **CAS Project ID:** P1300816

**Internal Standard Area and RT Summary**

Test Code: EPA TO-15 SIM  
 Instrument ID: Tekmar AUTOCAN/Agilent 5975Cinert/7890A/MS19 Lab File ID: 03061302.D  
 Analyst: Wida Ang Date Analyzed: 3/6/13  
 Sample Type: 6.0 L Summa Canister(s) Time Analyzed: 18:13  
 Test Notes:

	IS1 (BCM)		IS2 (DFB)		IS3 (CBZ)	
	AREA	#	AREA	#	AREA	#
<b>24 Hour Standard</b>	64786	11.66	276779	13.40	32082	17.09
<b>Upper Limit</b>	90700	11.99	387491	13.73	44915	17.42
<b>Lower Limit</b>	38872	11.33	166067	13.07	19249	16.76

Client Sample ID		IS1 (BCM)	IS2 (DFB)	IS3 (CBZ)
		AREA	RT	AREA
01	Method Blank	64670	11.66	271639
02	Lab Control Sample	65455	11.66	274873
03	219-SS-3	66099	11.66	278647
04	219-SS-2	65278	11.66	267574
05				
06				
07				
08				
09				
10				
11				
12				
13				
14				
15				
16				
17				
18				
19				
20				

IS1 (BCM) = Bromochloromethane  
 IS2 (DFB) = 1,4-Difluorobenzene  
 IS3 (CBZ) = Chlorobenzene-d5

AREA UPPER LIMIT = 140% of internal standard area  
 AREA LOWER LIMIT = 60% of internal standard area  
 RT UPPER LIMIT = 0.33 minutes of internal standard RT  
 RT LOWER LIMIT = 0.33 minutes of internal standard RT

# Column used to flag values outside QC limits with an I.  
 I = Internal standard not within the specified limits. See case narrative.

Response Factor Report MS19

Method Path : J:\MS19\METHODS\  
 Method File : X19022213.M  
 Title : EPA TO-15 per SOP VOA-TO15 (CASS TO-15/GC-MS)  
 Last Update : Mon Feb 25 07:18:53 2013  
 Response Via : Initial Calibration

Calibration Files

10 =02221314.D 20 =02221315.D 50 =02221316.D 100 =02221317.D 500 =02221318.D 1000=02221319.D  
 2500=02221320.D 9999=02221321.D 20K =02221322.D

Compound	10	20	50	100	500	1000	2500	9999	20K	Avg	%RSD
-----ISTD-----											
1) I Bromochloromethane...											
2) T Dichlorodifluo...	2.711	2.546	2.436	2.153	2.239	2.220	2.168	2.089	2.071	2.293	9.67
3) T Chloromethane		0.608	0.483	0.417	0.413	0.445	0.335	0.427	0.402	0.441	17.98
4) T Vinyl Chloride	1.909	1.786	1.713	1.531	1.461	1.579	1.529	1.419	1.355	1.587	11.45
5) T Bromomethane		1.203	0.898	0.854	0.876	0.866	0.786	0.786	0.836	0.888	15.02
6) T Chloroethane	0.753	0.708	0.617	0.580	0.605	0.599	0.538	0.526	0.563	0.610	12.40
7) T Acetone			0.679	0.520	0.495	0.470	0.439	0.376	0.376	0.479	21.68
8) T Trichlorofluor...	1.925	1.853	1.738	1.588	1.688	1.675	1.594	1.589	1.565	1.691	7.52
9) T 1,1-Dichloroet...	1.369	1.254	1.167	1.057	1.120	1.126	1.079	1.111	1.089	1.152	8.66
10) T Methylene Chlo...			1.687	1.179	1.182	1.139	1.075	1.070	1.074	1.201	18.32
11) T Trichlorotrifl...	1.529	1.501	1.405	1.182	1.290	1.287	1.213	1.192	1.197	1.311	10.34
12) T trans-1,2-Dich...	1.982	1.671	1.423	1.182	1.274	1.257	1.202	1.234	1.251	1.386	19.50
13) T 1,1-Dichloroet...	1.918	1.828	1.648	1.536	1.578	1.551	1.489	1.587	1.580	1.635	8.76
14) T Methyl tert-Bu...	3.105	3.009	2.886	2.503	2.735	2.705	2.794	2.847	2.941	2.836	6.30
15) T cis-1,2-Dichlo...	1.999	1.649	1.430	1.183	1.281	1.265	1.218	1.257	1.256	1.393	19.25
16) T Chloroform	2.217	2.076	1.882	1.659	1.776	1.709	1.653	1.706	1.707	1.821	11.00
17) S 1,2-Dichloroet...	1.004	1.006	0.999	0.997	0.990	0.956	0.935	0.973	0.932	0.977	2.99
18) T 1,2-Dichloroet...	1.746	1.517	1.332	1.109	1.192	1.156	1.118	1.144	1.099	1.268	17.74
19) T 1,1,1-Trichlor...	1.952	1.902	1.776	1.550	1.678	1.688	1.648	1.706	1.658	1.729	7.38
20) T Benzene			4.718	3.881	4.021	3.951	3.825	3.733	3.569	3.957	9.27
21) T Carbon Tetrach...	1.331	1.381	1.337	1.192	1.372	1.389	1.379	1.438	1.422	1.360	5.29
-----ISTD-----											
22) I 1,4-Difluorobenzen...											
23) T 1,2-Dichloropr...	0.275	0.260	0.235	0.209	0.217	0.214	0.210	0.215	0.216	0.228	10.54
24) T Bromodichlorom...	0.365	0.344	0.315	0.283	0.305	0.303	0.305	0.326	0.329	0.319	7.70
25) T Trichloroethene	0.596	0.525	0.442	0.373	0.374	0.363	0.349	0.359	0.363	0.416	21.14
26) T 1,4-Dioxane	0.286	0.253	0.230	0.182	0.202	0.208	0.201	0.219	0.217	0.222	14.14
27) T cis-1,3-Dichlo...	0.449	0.389	0.354	0.286	0.341	0.351	0.360	0.379	0.389	0.367	12.04
28) T trans-1,3-Dich...	0.324	0.297	0.286	0.202	0.274	0.298	0.314	0.349	0.364	0.301	15.69
29) T 1,1,2-Trichlor...	0.267	0.245	0.228	0.198	0.212	0.214	0.207	0.215	0.219	0.223	9.50
30) S Toluene-d8 (SS2)	0.940	0.940	0.931	0.951	0.924	0.915	0.924	0.943	0.976	0.938	1.93

Method Path : J:\MS19\METHODS\  
 Method File : X19022213.M  
 Title : EPA TO-15 per SOP VOA-TO15 (CASS TO-15/GC-MS)

	1.505	1.281	1.091	1.109	1.081	1.058	1.069	1.075	1.159	13.57
31) T Toluene	0.439	0.372	0.332	0.258	0.302	0.299	0.317	0.328	0.327	15.92
32) T 1,2-Dibromoethane	0.555	0.521	0.472	0.431	0.431	0.418	0.430	0.442	0.460	10.24
33) T Tetrachloroethene										
34) I Chlorobenzene-d5 (...										
35) T Chlorobenzene	1.261	1.180	1.085	0.957	1.077	1.077	1.053	0.971	1.084	8.68
36) T Ethylbenzene	9.563	8.980	8.460	7.418	8.708	8.857	8.240	7.560	8.485	7.97
37) T m,p-Xylene	1.084	1.069	0.987	0.828	0.902	0.944	0.899	0.806	0.931	10.61
38) T o-Xylene	3.326	3.493	3.460	3.182	3.761	4.095	3.915	3.847	3.638	8.15
39) T 1,1,2,2-Tetrac...	4.733	4.764	4.813	4.564	4.865	4.942	4.762	4.569	4.401	3.61
40) S Bromofluoroben...	8.921	7.734	6.525	7.059	6.988	6.307	6.486	6.039	7.007	13.35
41) T 1,3-Dichlororobe...	9.757	7.984	6.566	7.161	7.099	6.449	6.545	6.091	7.206	16.41
42) T 1,4-Dichlororobe...	8.265	7.172	6.290	6.852	6.752	6.223	6.243	5.814	6.701	11.40
43) T 1,2-Dichlororobe...	6.540	5.369	4.387	4.705	4.826	4.652	5.106	4.850	5.054	13.24
44) T 1,2,4-Trichlor...	1.779	1.420	1.156	1.308	1.387	1.340	1.629	1.521	1.442	13.58
45) T Naphthalene	3.649	3.575	3.198	2.960	3.090	3.023	3.094	2.965	3.189	7.93
46) T Hexachlorobuta...										

(#) = Out of Range

Evaluate Continuing Calibration Report

Data File: I:\MS19\DATA\2013\_03\05\03051332.D

Acq On : 5 Mar 2013 22:14

Operator: WA

Sample : 500pg TO-15SIM CCV STD

Inst : MS19

Misc : S25-02221305/S25-02071307 (3/8)

ALS Vial : 15 Sample Multiplier: 1

Quant Time: Mar 06 06:07:52 2013

Quant Method : J:\MS19\METHODS\X19022213.M

Quant Title : EPA TO-15 per SOP VOA-TO15 (CASS TO-15/GC-MS)

QLast Update : Mon Feb 25 07:18:53 2013

Response via : Initial Calibration

DataAcq Meth:TO15SIM2.M

Min. RRF : 0.000 Min. Rel. Area : 50% Max. R.T. Dev 0.33min  
 Max. RRF Dev : 30% Max. Rel. Area : 200%

	Compound	AvgRF	CCRF	%Dev	Area%	Dev(min)
1 I	Bromochloromethane (IS1)	1.000	1.000	0.0	98	-0.01
2 T	Dichlorodifluoromethane (CF)	2.293	1.892	17.5	83	0.03
3 T	Chloromethane	0.441	0.367	16.8	87	0.04
4 T	Vinyl Chloride	1.587	1.273	19.8	85	0.03
5 T	Bromomethane	0.888	0.738	16.9	82	0.02
6 T	Chloroethane	0.610	0.500	18.0	81	0.02
7 T	Acetone	0.479	0.429	10.4	85	0.00
8 T	Trichlorofluoromethane	1.691	1.378	18.5	80	0.01
9 T	1,1-Dichloroethene	1.152	0.946	17.9	83	0.00
10 T	Methylene Chloride	1.201	0.976	18.7	81	0.00
11 T	Trichlorotrifluoroethane	1.311	1.073	18.2	81	0.00
12 T	trans-1,2-Dichloroethene	1.386	1.060	23.5	81	0.00
13 T	1,1-Dichloroethane	1.635	1.370	16.2	85	0.00
14 T	Methyl tert-Butyl Ether	2.836	2.369	16.5	85	0.01
15 T	cis-1,2-Dichloroethene	1.393	1.086	22.0	83	0.00
16 T	Chloroform	1.821	1.487	18.3	82	-0.01
17 S	1,2-Dichloroethane-d4 (SS1)	0.977	0.970	0.7	96	0.00
18 T	1,2-Dichloroethane	1.268	0.995	21.5	82	-0.01
19 T	1,1,1-Trichloroethane	1.729	1.439	16.8	84	0.00
20 T	Benzene	3.957	3.334	15.7	81	0.00
21 T	Carbon Tetrachloride	1.360	1.155	15.1	82	0.00
22 I	1,4-Difluorobenzene (IS2)	1.000	1.000	0.0	95	0.00
23 T	1,2-Dichloropropane	0.228	0.185	18.9	81	0.00
24 T	Bromodichloromethane	0.319	0.262	17.9	82	0.00
25 T	Trichloroethene	0.416	0.309	25.7	79	0.00
26 T	1,4-Dioxane	0.222	0.171	23.0	81	0.00
27 T	cis-1,3-Dichloropropene	0.367	0.301	18.0	84	0.00
28 T	trans-1,3-Dichloropropene	0.301	0.251	16.6	87	0.00
29 T	1,1,2-Trichloroethane	0.223	0.180	19.3	81	0.00
30 S	Toluene-d8 (SS2)	0.938	0.933	0.5	96	0.00
31 T	Toluene	1.159	0.953	17.8	82	0.00
32 T	1,2-Dibromoethane	0.327	0.255	22.0	82	0.00
33 T	Tetrachloroethene	0.460	0.380	17.4	82	0.00
34 I	Chlorobenzene-d5 (IS3)	1.000	1.000	0.0	96	0.00
35 T	Chlorobenzene	7.509	6.323	15.8	81	0.00
36 T	Ethylbenzene	10.836	9.177	15.3	81	0.00
37 T	m,p-Xylene	8.485	7.437	12.4	82	0.00
38 T	o-Xylene	9.314	8.015	13.9	85	0.00



Evaluate Continuing Calibration Report

Data File: I:\MS19\DATA\2013\_03\05\03051332.D

Acq On : 5 Mar 2013 22:14 Operator: WA  
 Sample : 500pg TO-15SIM CCV STD Inst : MS19  
 Misc : S25-02221305/S25-02071307 (3/8)  
 ALS Vial : 15 Sample Multiplier: 1

Quant Time: Mar 06 06:07:52 2013  
 Quant Method : J:\MS19\METHODS\X19022213.M  
 Quant Title : EPA TO-15 per SOP VOA-TO15 (CASS TO-15/GC-MS)  
 QLast Update : Mon Feb 25 07:18:53 2013  
 Response via : Initial Calibration  
 DataAcq Meth:TO15SIM2.M

Min. RRF : 0.000 Min. Rel. Area : 50% Max. R.T. Dev 0.33min  
 Max. RRF Dev : 30% Max. Rel. Area : 200%

	Compound	AvgRF	CCRF	%Dev	Area%	Dev(min)
39 T	1,1,2,2-Tetrachloroethane	3.638	3.451	5.1	88	0.00
40 S	Bromofluorobenzene (SS3)	4.712	5.114	-8.5	100	0.00
41 T	1,3-Dichlorobenzene	7.007	5.988	14.5	81	0.00
42 T	1,4-Dichlorobenzene	7.206	5.999	16.7	80	0.00
43 T	1,2-Dichlorobenzene	6.701	5.758	14.1	80	0.00
44 T	1,2,4-Trichlorobenzene	5.054	4.144	18.0	84	0.00
45 T	Naphthalene	14.424	11.361	21.2	83	0.00
46 T	Hexachlorobutadiene	3.189	2.755	13.6	85	0.00

(#) = Out of Range

SPCC's out = 0 CCC's out = 0

Evaluate Continuing Calibration Report

Data File: I:\MS19\DATA\2013\_03\06\03061302.D

Acq On : 6 Mar 2013 18:13

Operator: WA

Sample : 500pg TO-15SIM CCV STD

Inst : MS19

Misc : S25-02221305/S25-02251303 (3/26)

ALS Vial : 15 Sample Multiplier: 1

Quant Time: Mar 07 06:20:06 2013

Quant Method : J:\MS19\METHODS\X19022213.M

Quant Title : EPA TO-15 per SOP VOA-TO15 (CASS TO-15/GC-MS)

QLast Update : Mon Feb 25 07:18:53 2013

Response via : Initial Calibration

DataAcq Meth:TO15SIM2.M

Min. RRF : 0.000 Min. Rel. Area : 50% Max. R.T. Dev 0.33min  
 Max. RRF Dev : 30% Max. Rel. Area : 200%

	Compound	AvgRF	CCRF	%Dev	Area%	Dev(min)
1 I	Bromochloromethane (IS1)	1.000	1.000	0.0	106	-0.01
2 T	Dichlorodifluoromethane (CF)	2.293	2.131	7.1	101	0.03
3 T	Chloromethane	0.441	0.436	1.1	112	0.03
4 T	Vinyl Chloride	1.587	1.488	6.2	108	0.03
5 T	Bromomethane	0.888	0.835	6.0	101	0.02
6 T	Chloroethane	0.610	0.588	3.6	103	0.02
7 T	Acetone	0.479	0.480	-0.2	103	0.00
8 T	Trichlorofluoromethane	1.691	1.548	8.5	98	0.01
9 T	1,1-Dichloroethene	1.152	1.114	3.3	106	0.00
10 T	Methylene Chloride	1.201	1.159	3.5	104	0.00
11 T	Trichlorotrifluoroethane	1.311	1.188	9.4	98	0.00
12 T	trans-1,2-Dichloroethene	1.386	1.245	10.2	104	0.00
13 T	1,1-Dichloroethane	1.635	1.633	0.1	110	0.00
14 T	Methyl tert-Butyl Ether	2.836	2.845	-0.3	111	0.01
15 T	cis-1,2-Dichloroethene	1.393	1.263	9.3	105	0.00
16 T	Chloroform	1.821	1.722	5.4	103	-0.01
17 S	1,2-Dichloroethane-d4 (SS1)	0.977	1.017	-4.1	109	0.00
18 T	1,2-Dichloroethane	1.268	1.162	8.4	104	-0.01
19 T	1,1,1-Trichloroethane	1.729	1.649	4.6	105	0.00
20 T	Benzene	3.957	3.891	1.7	103	0.00
21 T	Carbon Tetrachloride	1.360	1.347	1.0	104	0.00
22 I	1,4-Difluorobenzene (IS2)	1.000	1.000	0.0	107	0.00
23 T	1,2-Dichloropropane	0.228	0.217	4.8	107	0.00
24 T	Bromodichloromethane	0.319	0.299	6.3	105	0.00
25 T	Trichloroethene	0.416	0.351	15.6	100	0.00
26 T	1,4-Dioxane	0.222	0.199	10.4	106	0.00
27 T	cis-1,3-Dichloropropene	0.367	0.351	4.4	110	0.00
28 T	trans-1,3-Dichloropropene	0.301	0.287	4.7	112	0.00
29 T	1,1,2-Trichloroethane	0.223	0.204	8.5	103	0.00
30 S	Toluene-d8 (SS2)	0.938	0.943	-0.5	109	0.00
31 T	Toluene	1.159	1.084	6.5	104	0.00
32 T	1,2-Dibromoethane	0.327	0.280	14.4	101	0.00
33 T	Tetrachloroethene	0.460	0.410	10.9	99	0.00
34 I	Chlorobenzene-d5 (IS3)	1.000	1.000	0.0	111	0.00
35 T	Chlorobenzene	7.509	6.773	9.8	101	0.00
36 T	Ethylbenzene	10.836	10.071	7.1	104	0.00
37 T	m,p-Xylene	8.485	8.135	4.1	104	0.00
38 T	o-Xylene	9.314	8.691	6.7	107	0.00

Evaluate Continuing Calibration Report

Data File: I:\MS19\DATA\2013\_03\06\03061302.D

Acq On : 6 Mar 2013 18:13 Operator: WA  
 Sample : 500pg TO-15SIM CCV STD Inst : MS19  
 Misc : S25-02221305/S25-02251303 (3/26)  
 ALS Vial : 15 Sample Multiplier: 1

Quant Time: Mar 07 06:20:06 2013  
 Quant Method : J:\MS19\METHODS\X19022213.M  
 Quant Title : EPA TO-15 per SOP VOA-TO15 (CASS TO-15/GC-MS)  
 QLast Update : Mon Feb 25 07:18:53 2013  
 Response via : Initial Calibration  
 DataAcq Meth:TO15SIM2.M

Min. RRF : 0.000 Min. Rel. Area : 50% Max. R.T. Dev 0.33min  
 Max. RRF Dev : 30% Max. Rel. Area : 200%

	Compound	AvgRF	CCRF	%Dev	Area%	Dev (min)
39 T	1,1,2,2-Tetrachloroethane	3.638	3.592	1.3	106	0.00
40 S	Bromofluorobenzene (SS3)	4.712	4.695	0.4	107	0.00
41 T	1,3-Dichlorobenzene	7.007	6.258	10.7	99	0.00
42 T	1,4-Dichlorobenzene	7.206	6.305	12.5	98	0.00
43 T	1,2-Dichlorobenzene	6.701	6.009	10.3	98	0.00
44 T	1,2,4-Trichlorobenzene	5.054	4.401	12.9	104	0.00
45 T	Naphthalene	14.424	13.219	8.4	113	0.00
46 T	Hexachlorobutadiene	3.189	2.760	13.5	99	0.00

(#) = Out of Range

SPCC's out = 0 CCC's out = 0

**Radon Analysis (EPA Method GS: Grab Sample/Scintillation Cell counting)**

**For GSI Environmental**

Samples Collected by: T. McHugh/L. Beckley  
 Client Project Number: ESTCPVI Study - Tyndall AFB 3585/3669  
 Sample Dates: 02/21/13  
 Sample containers: Tedlar bags w/ nylon fittings  
 Site: Tyndall AFB  
 Assumed Site Pressure: 1.00 atm  
 Analysts: Doug Hammond  
 based on an elevation of 15 ft  
 Phone: 310-490-7896  
 Time Zone adjustment: add to decay time  
 email: dhammond@usc.edu  
 3 hours  
 Collect Run (EST) (PST)

Summary	Collection		Analysis		Vol run (cc)	Conc. pCi/L	±1 sig pCi/L	Lab Duplicates		Notes
	Date (EST)	Time (EST)	Date (PST)	Time (PST)				mean pCi/L	±1ssd pCi/L	
Received 02/25/13										
1	156-AA-1	2/21/13	16:05	2/25/13	13:52	120	0.03	0.06		
2	156-IA-4	2/21/13	16:05	2/25/13	13:57	120	0.00	0.07	0.02	*
	lab dupe	2/21/13	16:05	2/25/13	14:00	120	0.03	0.07		
3	156-IA-4-BL	2/22/13	8:04	2/25/13	14:03	120	0.07	0.05		

Uncertainty given in pCi/liter is based on counting statistics for low activity samples. For high activity samples uncertainty is ±5%.  
 The Lower Limit of Detection for Rn (95% confidence level as recommended by EPA 402-R-95-012, Oct. 97) is 0.14 pCi/liter.  
 Results are reported based on standardization with NIST-traceable radon sources.  
 These results are for application of naturally-occurring radon as a tracer of soil vapor intrusion, but are not intended for evaluation of radon hazards.  
 Results corrected to in situ pressure as noted above  
 Note Details:  
 \*This analysis had an observed dpm of -0.002, less than cell background but within counting uncertainty of zero. Result is below the detection limit and reported as observed dpm of 0.0001.

**Raw Data, Calculation factors, and Analytical Details**

Sample ID	Collection		Analysis		Count in cell/ch	He eff	Air/He eff	Vol run (cc)	Press factor	obs dpm	sig dpm	Decay T (hours)	Decay factor	Concentration dpm/liter	pCi/liter	count stats pCi/liter ±1 sig	Notes
	Date (EST)	Time (EST)	Date (PST)	Time (PST)													
Received 02/25/13																	
1	156-AA-1	2/21/13	16:05	2/25/13	13:52	83/33	0.806	0.95	120	1.00	0.003	0.006	96.8	2.077	0.07	0.03	0.06
2	156-IA-4	2/21/13	16:05	2/25/13	13:57	82/32	0.743	0.95	120	1.00	0.000	0.006	96.9	2.079	0.00	0.00	0.07
	lab dupe	2/21/13	16:05	2/25/13	14:00	84/11	0.785	0.95	120	1.00	0.003	0.007	96.9	2.079	0.07	0.03	0.07
3	156-IA-4-BL	2/22/13	8:04	2/25/13	14:03	81/31	0.818	0.95	120	1.00	0.008	0.006	81.0	1.844	0.16	0.07	0.05

Decay corrections based on Rn decay constant of 0.1813 per day  
 Conversion from dpm based on 0.4504 pCi/dpm  
 Blanks are negligible  
 Radon Conc =  $\frac{((0.4504)(1000)(\text{obs dpm})(\text{decay factor})(\text{Press factor}))}{((\text{cc used})(\text{He eff})(\text{Air/He}))}$   
 (in pCi/liter)

**Definitions:**  
 Cell/ch: Counting cell and channel used  
 He eff: Cell and counter efficiency using helium matrix  
 Air/He: Correction for matrix counting gas density  
 Sample vol: Volume analyzed (cc)  
 Press factor: Correction to in situ pressure based on collection altitude  
 obs dpm: observed radon activity (disintegrations per minute) when analyzed  
 sig dpm: uncertainty (± 1 sig) in dpm based on counting statistics  
 Decay T: time elapsed from sampling to analysis  
 Decay factor: Correction factor for decay from collection to analysis  
 dpm/liter: Radon concentration in disintegrations per minute per liter of sample  
 pCi/liter: Radon concentration in pCi/liter  
 count stats: uncertainty in observed radon based on counting statistics



**OU #677 and 677a**  
**ER-201025, Tndall AFB**

**analyses completed:**

C CSIA -- tubes 3/14/2013

C CSIA -- water 3/15/2013

Cl CSIA -- tubes 3/20/2013

Cl CSIA -- water 3/06/2013

<b>Sample ID</b>	<b>average TCE <math>\delta^{13}C</math></b>	<b>average TCE <math>\delta^{37}Cl</math></b>
156-SS-3	-9.6	6.3
219-SS-3	-1.9	6.3
219-IA-3 P1	-29.0	-3.5
219-IA-3 P2	-28.8	-3.2
MW-8	13.8	10.1
MW-20S	-18.4	4.7

Note: For Sample ID MW-8, the actual well sampled was MW-5.

Run #	Sample ID	Tube #	Split X	TCE $\delta^{13}C$	notes	Sample ID	average TCE $\delta^{13}C$
9350	156-SS-3	C16_M17855	splitless	-9.8		156-SS-3	-9.6
9352	156-SS-3	C16_M16576	1:1	-9.4		219-SS-3	-1.9
9354	219-SS-3	C16_M17784	1:3		peak too small	219-IA-3 P1	-29.0
9355	219-SS-3	C16_M17784 (via M17789)	splitless	-1.6		219-IA-3 P2	-28.8
9363	219-SS-3	C16_M17751	splitless	-2.2		MW-8	13.8
9357	219-IA-3 P1	C16_M17686	1:25		peak too large	MW-20S	-18.4
9359	219-IA-3 P1	C16_M17787 (via M17860)	1:80	-28.7			
9362	219-IA-3 P1	C16_M17787 (via M17718)	1:80	-29.3			
9358	219-IA-3 P2	C16_M17822	1:25		peak too large		
9361	219-IA-3 P2	C16_M17688 (via M17856)	1:80	-28.8			

Run #	Sample ID	Water volume (mL)	Split X	TCE $\delta^{13}C$
9365	MW-8	25	splitless	13.8
9366	MW-20S	8	splitless	-18.3
9367	MW-20S	4	splitless	-18.4

#### Standards

Run #	Sample ID	Tube #	Split X	TCE $\delta^{13}C$
9348	TCE stand. 100 ng	C16_J03738	splitless	-30.5
9349	TCE stand. 100 ng	C16_M17859	splitless	-30.0
9351	TCE stand. 100 ng	C16_M17825	splitless	-30.3
9353	TCE stand. 100 ng	C16_J03664	splitless	-30.2
9356	TCE stand. 100 ng	C16_J03729	splitless	-30.0
9360	TCE stand. 100 ng	C16_M16543	splitless	-29.6
9364	TCE stand. 100 ng	aqueous by PT	splitless	-30.2
9370	TCE stand. 100 ng	aqueous by PT	splitless	-30.0
		average		-30.1
		stdev		0.3
		off-line $\delta^{13}C$ of the stand. correction (x)		-30.8 -0.7

Run #	Sample ID	Tube #	Split X	TCE δ37Cl	Sample ID	average TCE δ37Cl
3298	156-SS-3	C16-M17818 (via C16_M17758)	1:1	6.1	156-SS-3	6.3
3302	156-SS-3	C16-M17818 (via C16_M17859)	splitless	6.4	219-SS-3	6.3
3293	219-SS-3	C16_M17717	splitless	6.3	219-IA-3 P1	-3.5
					219-IA-3 P2	-3.2
					MW-8	10.1
3289	219-1A-3 Pump 1	C16_M17787 (via C16_M16587)	1:13	-3.5	MW-20S	4.7
3305	219-1A-3 Pump 1	C16_M17787 (via C16_M17857)	1:15	-3.5		
3291	219-1A-3 Pump 2	C16_M17688 (via C16_M17786)	1:14	-2.9		
3292	219-1A-3 Pump 2	C16_M17688 (via C16_J03132)	1:14	-2.9		
3306	219-1A-3 Pump 2	C16_M17688 (via C16_M17723)	1:15	-3.7		

Run #	Sample ID	Water volume (mL)	Split X	TCE δ37Cl
3274	MW8	26	splitless	10.0
3281	MW8	25	splitless	10.2
3283	MW8	25	splitless	10.1
3275	MW20S	3	splitless	4.5
3282	MW20S	3	splitless	4.8

#### Standards

Run #	Sample ID	Tube #	Split X	TCE δ37Cl
3286	TCE stand 70 ng	C16_J05145	splitless	3.1
3287	TCE stand 70 ng	C16_M17690	splitless	3.4
3288	TCE stand 70 ng	C16_M16587	splitless	3.4
3290	TCE stand 70 ng	C16_K08451	splitless	3.2
3294	TCE stand 70 ng	C16_M17783	splitless	3.2
3295	TCE stand 70 ng	C16_K08458	splitless	3.4
3296	TCE stand 70 ng	C16_K08449	splitless	3.0
3301	TCE stand 70 ng	C16_M17750	splitless	3.5
3303	TCE stand 70 ng	C16_J03150	splitless	3.4
3304	TCE stand 70 ng	C16_M17683	splitless	3.2
3268	TCE stand 70 ng	aqueous by PT	splitless	3.1
3269	TCE stand 70 ng	aqueous by PT	splitless	3.3
3270	TCE stand 70 ng	aqueous by PT	splitless	3.5
3272	TCE stand 70 ng	aqueous by PT	splitless	3.3
3277	TCE stand 70 ng	aqueous by PT	splitless	3.5
3278	TCE stand 70 ng	aqueous by PT	splitless	3.1
3279	TCE stand 70 ng	aqueous by PT	splitless	3.1
3280	TCE stand 70 ng	aqueous by PT	splitless	3.4
3284	TCE stand 70 ng	aqueous by PT	splitless	3.4
3285	TCE stand 70 ng	aqueous by PT	splitless	3.3
		average		3.3
		stdev		0.2
		off-line δ37Cl of the stand. correction (x)		3.3 0.0



**OU #677 and 677a**  
**ER-201025, Tndall AFB**

**analyses completed:**

C CSIA -- tubes 3/14/2013

C CSIA -- water 3/15/2013

CI CSIA -- tubes 3/20/2013

CI CSIA -- water 3/06/2013

reanalyzed CI CSIA -- 5/23/2013

<b>Sample ID</b>	<b>average TCE <math>\delta^{13}C</math></b>	<b>average TCE <math>\delta^{37}Cl</math></b>
156-SS-3	-9.6	6.3
219-SS-3	-1.9	6.3
219-IA-3 P1	-29.0	-3.5
219-IA-3 P2	-28.8	-3.2
MW-8	13.8	10.1
MW-20S	-18.4	4.7

Run #	Sample ID	Tube #	Split X	TCE $\delta^{13}C$	notes	Sample ID	average TCE $\delta^{13}C$
9350	156-SS-3	C16_M17855	splitless	-9.8		156-SS-3	-9.6
9352	156-SS-3	C16_M16576	1:1	-9.4		219-SS-3	-1.9
9354	219-SS-3	C16_M17784	1:3		peak too small	219-IA-3 P1	-29.0
9355	219-SS-3	C16_M17784 (via M17789)	splitless	-1.6		219-IA-3 P2	-28.8
9363	219-SS-3	C16_M17751	splitless	-2.2		MW-8	13.8
						MW-20S	-18.4
9357	219-IA-3 P1	C16_M17686	1:25		peak too large		
9359	219-IA-3 P1	C16_M17787 (via M17860)	1:80	-28.7			
9362	219-IA-3 P1	C16_M17787 (via M17718)	1:80	-29.3			
9358	219-IA-3 P2	C16_M17822	1:25		peak too large		
9361	219-IA-3 P2	C16_M17688 (via M17856)	1:80	-28.8			

Run #	Sample ID	Water volume (mL)	Split X	TCE $\delta^{13}C$
9365	MW-8	25	splitless	13.8
9366	MW-20S	8	splitless	-18.3
9367	MW-20S	4	splitless	-18.4

#### Standards

Run #	Sample ID	Tube #	Split X	TCE $\delta^{13}C$
9348	TCE stand. 100 ng	C16_J03738	splitless	-30.5
9349	TCE stand. 100 ng	C16_M17859	splitless	-30.0
9351	TCE stand. 100 ng	C16_M17825	splitless	-30.3
9353	TCE stand. 100 ng	C16_J03664	splitless	-30.2
9356	TCE stand. 100 ng	C16_J03729	splitless	-30.0
9360	TCE stand. 100 ng	C16_M16543	splitless	-29.6
9364	TCE stand. 100 ng	aqueous by PT	splitless	-30.2
9370	TCE stand. 100 ng	aqueous by PT	splitless	-30.0
		average		-30.1
		stdev		0.3
		off-line $\delta^{13}C$ of the stand. correction (x)		-30.8 -0.7

Run #	Sample ID	Tube #	Split X	TCE 637CI	remarks	Sample ID	average TCE 637CI	averages with May 2013
3298	156-SS-3	C16-M17818 (via C16_M17758)	1:1	6.1		156-SS-3	6.3	6.3
3302	156-SS-3	C16-M17818 (via C16_M17859)	splitless	6.4		219-SS-3	6.3	6.3
3583	156-SS-3	C16_M17853	1:2	6.3	analyzed May-22-2013	219-IA-3 P1	-3.5	-3.4
3592	156-SS-3 (split of #3583)	C16_M17853	1:1	6.2	analyzed May-23-2013	219-IA-3 P2	-3.2	-3.2
						MW-8	10.1	10.1
3293	219-SS-3	C16_M17717	splitless	6.3		MW-205	4.7	4.7
3289	219-1A-3 Pump 1	C16_M17787 (via C16_M16587)	1:13	-3.5				
3305	219-1A-3 Pump 1	C16_M17787 (via C16_M17857)	1:15	-3.5				
3585	219-1A-3 Pump 1 (split of #3305)	C16_M17787 (via C16_M17855)	1:9	-3.3	analyzed May-22-2013			
3291	219-1A-3 Pump 2	C16_M17688 (via C16_M17786)	1:14	-2.9				
3292	219-1A-3 Pump 2	C16_M17688 (via C16_J03132)	1:14	-2.9				
3306	219-1A-3 Pump 2	C16_M17688 (via C16_M17723)	1:15	-3.7				
3586	219-1A-3 Pump 2 (split of #3306)	C16_M17688 (via C16_M17856)	1:9	-3.3	analyzed May-22-2013			

Run #	Sample ID	Water volume (mL)	Split X	TCE 637CI
3274	MW8	26	splitless	10.0
3281	MW8	25	splitless	10.2
3283	MW8	25	splitless	10.1
3275	MW205	3	splitless	4.5
3282	MW205	3	splitless	4.8

#### Standards

Run #	Sample ID	Tube #	Split X	TCE 637CI
3286	TCE stand 70 ng	C16_J05145	splitless	3.1
3287	TCE stand 70 ng	C16_M17690	splitless	3.4
3288	TCE stand 70 ng	C16_M16587	splitless	3.4
3290	TCE stand 70 ng	C16_K08451	splitless	3.2
3294	TCE stand 70 ng	C16_M17783	splitless	3.2
3295	TCE stand 70 ng	C16_K08458	splitless	3.4
3296	TCE stand 70 ng	C16_K08449	splitless	3.0
3301	TCE stand 70 ng	C16_M17750	splitless	3.5
3303	TCE stand 70 ng	C16_J03150	splitless	3.4
3304	TCE stand 70 ng	C16_M17683	splitless	3.2
3268	TCE stand 70 ng	aqueous by PT	splitless	3.1
3269	TCE stand 70 ng	aqueous by PT	splitless	3.3
3270	TCE stand 70 ng	aqueous by PT	splitless	3.5
3272	TCE stand 70 ng	aqueous by PT	splitless	3.3
3277	TCE stand 70 ng	aqueous by PT	splitless	3.5
3278	TCE stand 70 ng	aqueous by PT	splitless	3.1
3279	TCE stand 70 ng	aqueous by PT	splitless	3.1
3280	TCE stand 70 ng	aqueous by PT	splitless	3.4
3284	TCE stand 70 ng	aqueous by PT	splitless	3.4
3285	TCE stand 70 ng	aqueous by PT	splitless	3.3
		average		3.3
		stdev		0.2
		off-line 637CI of the stand. correction (x)		3.3 0.0

# **Former Raritan Arsenal Site, New Jersey**

## LABORATORY REPORT

April 24, 2013

Lila Beckley  
GSI Environmental Inc.  
2211 Norfolk, Suite 1000  
Houston, TX 77098

**RE: ESTCP VI Study - Raritan / 3585/3669**

Dear Lila:

Your report number P1301371 has been amended for the samples submitted to our laboratory on April 2, 2013. The results have been reported down to the Method Detection Limit (MDL) per client request. The revised pages have been indicated by the "Revised Page" footer located at the bottom right of the page.

All analyses were performed according to our laboratory's NELAP and DoD-ELAP-approved quality assurance program. The test results meet requirements of the current NELAP and DoD-ELAP standards, where applicable, and except as noted in the laboratory case narrative provided. For a specific list of NELAP and DoD-ELAP-accredited analytes, refer to the certifications section at [www.caslab.com](http://www.caslab.com). Results are intended to be considered in their entirety and apply only to the samples analyzed and reported herein.

If you have any questions, please call me at (805) 526-7161.

Respectfully submitted,

**ALS | Environmental**



By Sue Anderson at 11:09 am, Apr 24, 2013

Sue Anderson  
Project Manager

Client: GSI Environmental Inc.  
Project: ESTCP VI Study - Raritan / 3585/3669

Service Request No: P1301371

---

## CASE NARRATIVE

The samples were received intact under chain of custody on April 2, 2013 and were stored in accordance with the analytical method requirements. Please refer to the sample acceptance check form for additional information. The results reported herein are applicable only to the condition of the samples at the time of sample receipt.

### Volatile Organic Compound Analysis

The samples were analyzed in SIM mode for selected volatile organic compounds in accordance with EPA Method TO-15 from the Compendium of Methods for the Determination of Toxic Organic Compounds in Ambient Air, Second Edition (EPA/625/R-96/010b), January, 1999. The analytical system was comprised of a gas chromatograph / mass spectrometer (GC/MS) interfaced to a whole-air preconcentrator.

Samples 209-SG-09 (P1301371-008) and 209-IA-09 (P1301371-009) required dilution due to the presence of elevated levels of Methylene Chloride, a non-target analyte. The reporting limits have been adjusted to reflect the dilutions.

The responses for the #3 internal standard in sample CP4-IA-5-NP (P1301371-013) and DUP-1 (P1301371-014) were outside control criteria because of suspected matrix interference. The samples were diluted in an attempt to eliminate the effects of the matrix interference. The results have been reported from the dilutions; therefore, the associated method reporting limits have been elevated accordingly.

The Summa canisters were cleaned, prior to sampling, down to the method reporting limit (MRL) reported for this project. Please note, projects which require reporting below the MRL could have results between the MRL and method detection limit (MDL) that are biased high.

---

*The results of analyses are given in the attached laboratory report. All results are intended to be considered in their entirety, and Columbia Analytical Services, Inc. dba ALS Environmental (ALS) is not responsible for utilization of less than the complete report.*

*Use of Columbia Analytical Services, Inc. dba ALS Environmental (ALS)'s Name. Client shall not use ALS's name or trademark in any marketing or reporting materials, press releases or in any other manner ("Materials") whatsoever and shall not attribute to ALS any test result, tolerance or specification derived from ALS's data ("Attribution") without ALS's prior written consent, which may be withheld by ALS for any reason in its sole discretion. To request ALS's consent, Client shall provide copies of the proposed Materials or Attribution and describe in writing Client's proposed use of such Materials or Attribution. If ALS has not provided written approval of the Materials or Attribution within ten (10) days of receipt from Client, Client's request to use ALS's name or trademark in any Materials or Attribution shall be deemed denied. ALS may, in its discretion, reasonably charge Client for its time in reviewing Materials or Attribution requests. Client acknowledges and agrees that the unauthorized use of ALS's name or trademark may cause ALS to incur irreparable harm for which the recovery of money damages will be inadequate. Accordingly, Client acknowledges and agrees that a violation shall justify preliminary injunctive relief. For questions contact the laboratory.*

Columbia Analytical Services, Inc. dba ALS Environmental – Simi Valley  
 Certifications, Accreditations, and Registrations

Agency	Web Site	Number
AIHA	<a href="http://www.aihaaccreditedlabs.org">http://www.aihaaccreditedlabs.org</a>	101661
Arizona DHS	<a href="http://www.azdhs.gov/lab/license/env.htm">http://www.azdhs.gov/lab/license/env.htm</a>	AZ0694
DoD ELAP	<a href="http://www.pjlabs.com/search-accredited-labs">http://www.pjlabs.com/search-accredited-labs</a>	L11-203
Florida DOH (NELAP)	<a href="http://www.doh.state.fl.us/lab/EnvLabCert/WaterCert.htm">http://www.doh.state.fl.us/lab/EnvLabCert/WaterCert.htm</a>	E871020
Maine DHHS	<a href="http://www.maine.gov/dhhs/mecdc/environmental-health/water/dwp-services/labcert/labcert.htm">http://www.maine.gov/dhhs/mecdc/environmental-health/water/dwp-services/labcert/labcert.htm</a>	2012039
Minnesota DOH (NELAP)	<a href="http://www.health.state.mn.us/accreditation">http://www.health.state.mn.us/accreditation</a>	494864
New Jersey DEP (NELAP)	<a href="http://www.nj.gov/dep/oqa/">http://www.nj.gov/dep/oqa/</a>	CA009
New York DOH (NELAP)	<a href="http://www.wadsworth.org/labcert/elap/elap.html">http://www.wadsworth.org/labcert/elap/elap.html</a>	11221
Oregon PHD (NELAP)	<a href="http://public.health.oregon.gov/LaboratoryServices/EnvironmentalLaboratoryAccreditation/Pages/index.aspx">http://public.health.oregon.gov/LaboratoryServices/EnvironmentalLaboratoryAccreditation/Pages/index.aspx</a>	CA200007
Pennsylvania DEP	<a href="http://www.depweb.state.pa.us/labs">http://www.depweb.state.pa.us/labs</a>	68-03307 (Registration)
Texas CEQ (NELAP)	<a href="http://www.tceq.texas.gov/field/qa/env_lab_accreditation.html">http://www.tceq.texas.gov/field/qa/env_lab_accreditation.html</a>	T104704413-12-3
Utah DOH (NELAP)	<a href="http://www.health.utah.gov/lab/labimp/certification/index.html">http://www.health.utah.gov/lab/labimp/certification/index.html</a>	CA01527201 2-2
Washington DOE	<a href="http://www.ecy.wa.gov/programs/eap/labs/lab-accreditation.html">http://www.ecy.wa.gov/programs/eap/labs/lab-accreditation.html</a>	C946

Analyses were performed according to our laboratory’s NELAP and DoD-ELAP approved quality assurance program. A complete listing of specific NELAP and DoD-ELAP certified analytes can be found in the certifications section at [www.caslab.com](http://www.caslab.com), [www.alsglobal.com](http://www.alsglobal.com), or at the accreditation body’s website.

Each of the certifications listed above have an explicit Scope of Accreditation that applies to specific matrices/methods/analytes; therefore, please contact the laboratory for information corresponding to a particular certification.

DETAIL SUMMARY REPORT

Client: GSI Environmental Inc.  
 Project ID: ESTCP VI Study - Raritan / 3585/3669

Service Request: P1301371

Date Received: 4/2/2013  
 Time Received: 09:20

TO-15 - VOC SIM

Client Sample ID	Lab Code	Matrix	Date Collected	Time Collected	Container ID	Pi1 (psig)	Pf1 (psig)	
CP4-AA-1	P1301371-001	Air	3/26/2013	16:42	AS00366	-3.23	3.73	X
CP4-IA-1	P1301371-002	Air	3/26/2013	16:44	AC01464	-4.22	3.72	X
CP4-IA-2	P1301371-003	Air	3/26/2013	16:45	AC01662	-1.75	3.69	X
CP4-IA-3	P1301371-004	Air	3/26/2013	16:30	AS00452	-0.10	3.81	X
CP4-SG-6	P1301371-005	Air	3/26/2013	15:00	AS00364	-1.37	3.58	X
CP4-SG-3	P1301371-006	Air	3/26/2013	09:00	AC01810	-1.27	3.62	X
209-SG-06	P1301371-007	Air	3/27/2013	10:50	AC01785	-2.01	3.61	X
209-SG-09	P1301371-008	Air	3/27/2013	10:00	AS00370	-1.85	3.63	X
209-IA-09	P1301371-009	Air	3/27/2013	16:09	AS00288	-3.92	3.69	X
209-IA-10	P1301371-010	Air	3/27/2013	16:08	AC01788	-3.91	3.77	X
209-AA-1	P1301371-011	Air	3/27/2013	16:10	AC00791	-3.42	3.76	X
CP4-IA-5-BL	P1301371-012	Air	3/28/2013	08:45	AC01855	0.55	3.60	X
CP4-IA-5-NP	P1301371-013	Air	3/28/2013	11:05	AC00389	0.11	3.76	X
DUP-1	P1301371-014	Air	3/28/2013	00:00	AC01263	0.44	3.58	X





2655 Park Center Drive, Suite A  
 Simi Valley, California 93065  
 Phone (805) 526-7161  
 Fax (805) 526-7270

# Air - Chain of Custody Record & Analytical Service Request

Requested Turnaround Time in Business Days (Surcharges) please circle  
 1 Day (100%) 2 Day (75%) 3 Day (50%) 4 Day (35%) 5 Day (25%) 10 Day-Standard

CAS Project No. **P130371**

Company Name & Address (Reporting Information)  
 GSI Environmental  
 2211 Norfolk Suite 1000  
 Houston TX 77078

Project Manager  
 Ula Beckley  
 Phone 713 367 4775 Fax

Email Address for Result Reporting  
 Ulbeckley@gssi-net.com

Project Name  
 ESTEP VI Study - Ravitan

Project Number  
 3585/3669

P.O. # / Billing Information

CAS Contact:  
 Sue Anderson

Client Sample ID	Laboratory ID Number	Date Collected	Time Collected	Canister ID (Bar code # - AC, SC, etc.)	Flow Controller ID (Bar code # - FC #)	Canister Start Pressure "Hg	Canister End Pressure "Hg/psig	Sample Volume	Comments e.g. Actual Preservative or specific instructions
CP4-AA-1	1-394	3/26/13	0930-1642	AS00366	FCA00151	-29.2	-9.5	6L	✓
CP4-IA-1	1-414	3/26/13	0934-1644	AC01464	00040	-29.3	-10		
CP4-IA-2	3-178	3/26/13	0930-1645	AC01662	00714	-29.3	-5		
CP4-IA-3	4-219	3/26/13	1630	AS00452	-	-29.3	-1		
CP4-SG-6	5-135	3/26/13	1500	AS00364	-	-29.3	-4.5		
CP4-SG-3	6-133	3/26/13	0900	AC01810	-	-29.3	-4		
209-SG-06	7-208	3/27/13	1050	AC01785	-	-29.3	-6		
209-SG-09	8-146	3/27/13	1000	AS00370	-	-29.3	-5		
209-IA-09	9-195	3/27/13	1609	AS00288	FCA00686	-29.2	-9.5		
209-IA-10	10-395	3/27/13	1608	AC01788	FCA00553	-29.2	-9.6		
209-AA-1	11-342	3/27/13	1610	AC00791	FCA00109	-29.3	-8.5		
CP4-IA-5-BL	12-060	3/28/13	0845	AC01855	-	-29.2	Ø		
CP4-IA-5-NP	13-009	3/28/13	1105	AC00389	-	-29.2	Ø		
Dup-1	14-043	3/28/13		AC01263	-	-29.1	Ø	✓	

Project Requirements (MRLs, QAPP)

Relinquished by: (Signature) *Ula Beckley* Date: 3/28/13 Time: 1700

Relinquished by: (Signature) \_\_\_\_\_ Date: \_\_\_\_\_ Time: \_\_\_\_\_

Report Tier Levels - please select  
 Tier I - Results (Default if not specified) \_\_\_\_\_  
 Tier II (Results + QC Summaries) \_\_\_\_\_  
 Tier III (Results + QC & Calibration Summaries)   
 Tier IV (Data Validation Package) 10% Surcharge \_\_\_\_\_

Notes: 14 sps  
 6 cans returned EDD required Yes/No  
 unused (1 of bond vol) 129/123

Received by: (Signature) *[Signature]* Date: 4/2/13 Time: 0900

Received by: (Signature) \_\_\_\_\_ Date: \_\_\_\_\_ Time: \_\_\_\_\_

Project Requirements (MRLs, QAPP)

Cooler / Blank Temperature \_\_\_\_\_ °C

**Sample Acceptance Check Form**

Client: GSI Environmental Inc. Work order: P1301371  
 Project: ESTCP VI Study - Raritan / 3585/3669  
 Sample(s) received on: 4/2/13 Date opened: 4/2/13 by: MZAMORA

**Note:** This form is used for all samples received by ALS. The use of this form for custody seals is strictly meant to indicate presence/absence and not as an indication of compliance or nonconformity. Thermal preservation and pH will only be evaluated either at the request of the client and/or as required by the method/SOP.

- |  | <b>Yes</b>                          | <b>No</b>                           | <b>N/A</b>                          |
|--|-------------------------------------|-------------------------------------|-------------------------------------|
| 1 Were <b>sample containers</b> properly marked with client sample ID?   | <input checked="" type="checkbox"/> | <input type="checkbox"/>            | <input type="checkbox"/>            |
| 2 Container(s) <b>supplied by ALS</b> ?  | <input checked="" type="checkbox"/> | <input type="checkbox"/>            | <input type="checkbox"/>            |
| 3 Did <b>sample containers</b> arrive in good condition?   | <input checked="" type="checkbox"/> | <input type="checkbox"/>            | <input type="checkbox"/>            |
| 4 Were <b>chain-of-custody</b> papers used and filled out?   | <input checked="" type="checkbox"/> | <input type="checkbox"/>            | <input type="checkbox"/>            |
| 5 Did <b>sample container labels</b> and/or tags agree with custody papers?                                      | <input checked="" type="checkbox"/> | <input type="checkbox"/>            | <input type="checkbox"/>            |
| 6 Was <b>sample volume</b> received adequate for analysis?   | <input checked="" type="checkbox"/> | <input type="checkbox"/>            | <input type="checkbox"/>            |
| 7 Are samples within specified holding times?  | <input checked="" type="checkbox"/> | <input type="checkbox"/>            | <input type="checkbox"/>            |
| 8 Was proper <b>temperature</b> (thermal preservation) of cooler at receipt adhered to?                          | <input type="checkbox"/>            | <input type="checkbox"/>            | <input checked="" type="checkbox"/> |
| 9 Was a <b>trip blank</b> received?  | <input type="checkbox"/>            | <input checked="" type="checkbox"/> | <input type="checkbox"/>            |
| 10 Were <b>custody seals</b> on outside of cooler/Box?   | <input type="checkbox"/>            | <input checked="" type="checkbox"/> | <input type="checkbox"/>            |
| Location of seal(s)? _____ Sealing Lid?  | <input type="checkbox"/>            | <input type="checkbox"/>            | <input checked="" type="checkbox"/> |
| Were signature and date included?  | <input type="checkbox"/>            | <input type="checkbox"/>            | <input checked="" type="checkbox"/> |
| Were seals intact?   | <input type="checkbox"/>            | <input type="checkbox"/>            | <input checked="" type="checkbox"/> |
| Were custody seals on outside of sample container?   | <input type="checkbox"/>            | <input checked="" type="checkbox"/> | <input type="checkbox"/>            |
| Location of seal(s)? _____ Sealing Lid?  | <input type="checkbox"/>            | <input type="checkbox"/>            | <input checked="" type="checkbox"/> |
| Were signature and date included?  | <input type="checkbox"/>            | <input type="checkbox"/>            | <input checked="" type="checkbox"/> |
| Were seals intact?   | <input type="checkbox"/>            | <input type="checkbox"/>            | <input checked="" type="checkbox"/> |
| 11 Do containers have appropriate <b>preservation</b> , according to method/SOP or Client specified information? | <input type="checkbox"/>            | <input type="checkbox"/>            | <input checked="" type="checkbox"/> |
| Is there a client indication that the submitted samples are <b>pH</b> preserved?                                 | <input type="checkbox"/>            | <input type="checkbox"/>            | <input checked="" type="checkbox"/> |
| Were <b>VOA vials</b> checked for presence/absence of air bubbles?   | <input type="checkbox"/>            | <input type="checkbox"/>            | <input checked="" type="checkbox"/> |
| Does the client/method/SOP require that the analyst check the sample pH and <u>if necessary</u> alter it?        | <input type="checkbox"/>            | <input type="checkbox"/>            | <input checked="" type="checkbox"/> |
| 12 <b>Tubes:</b> Are the tubes capped and intact?  | <input type="checkbox"/>            | <input type="checkbox"/>            | <input checked="" type="checkbox"/> |
| Do they contain moisture?  | <input type="checkbox"/>            | <input type="checkbox"/>            | <input checked="" type="checkbox"/> |
| 13 <b>Badges:</b> Are the badges properly capped and intact?   | <input type="checkbox"/>            | <input type="checkbox"/>            | <input checked="" type="checkbox"/> |
| Are dual bed badges separated and individually capped and intact?  | <input type="checkbox"/>            | <input type="checkbox"/>            | <input checked="" type="checkbox"/> |

Lab Sample ID	Container Description	Required pH *	Received pH	Adjusted pH	VOA Headspace (Presence/Absence)	Receipt / Preservation Comments
P1301371-001.01	6.0 L Silonite Can					
P1301371-002.01	6.0 L Ambient Can					
P1301371-003.01	6.0 L Ambient Can					
P1301371-004.01	6.0 L Silonite Can					
P1301371-005.01	6.0 L Silonite Can					
P1301371-006.01	6.0 L Ambient Can					
P1301371-007.01	6.0 L Ambient Can					
P1301371-008.01	6.0 L Silonite Can					

Explain any discrepancies: (include lab sample ID numbers): \_\_\_\_\_



RESULTS OF ANALYSIS

Page 1 of 1

**Client:** GSI Environmental Inc.  
**Client Sample ID:** CP4-AA-1  
**Client Project ID:** ESTCP VI Study - Raritan / 3585/3669

CAS Project ID: P1301371  
 CAS Sample ID: P1301371-001

Test Code: EPA TO-15 SIM  
 Instrument ID: Tekmar AUTOCAN/Agilent 5975Cinert/7890A/MS19  
 Analyst: Wida Ang  
 Sample Type: 6.0 L Summa Canister  
 Test Notes:  
 Container ID: AS00366

Date Collected: 3/26/13  
 Date Received: 4/2/13  
 Date Analyzed: 4/6/13  
 Volume(s) Analyzed: 1.00 Liter(s)

Initial Pressure (psig): -3.23      Final Pressure (psig): 3.73

Canister Dilution Factor: 1.61

CAS #	Compound	Result µg/m <sup>3</sup>	MRL µg/m <sup>3</sup>	MDL µg/m <sup>3</sup>	Result ppbV	MRL ppbV	MDL ppbV	Data Qualifier
75-01-4	Vinyl Chloride	ND	0.040	0.0040	ND	0.016	0.0016	
75-35-4	1,1-Dichloroethene	ND	0.040	0.0050	ND	0.010	0.0013	
156-60-5	trans-1,2-Dichloroethene	ND	0.040	0.018	ND	0.010	0.0045	
156-59-2	cis-1,2-Dichloroethene	ND	0.040	0.016	ND	0.010	0.0040	
79-01-6	Trichloroethene	<b>0.057</b>	0.040	0.0093	<b>0.011</b>	0.0075	0.0017	
127-18-4	Tetrachloroethene	<b>0.096</b>	0.040	0.0045	<b>0.014</b>	0.0059	0.00067	

ND = Compound was analyzed for, but not detected above the laboratory detection limit.

MRL = Method Reporting Limit - The minimum quantity of a target analyte that can be confidently determined by the referenced method.

RESULTS OF ANALYSIS

Page 1 of 1

**Client:** GSI Environmental Inc.  
**Client Sample ID:** CP4-IA-1  
**Client Project ID:** ESTCP VI Study - Raritan / 3585/3669

CAS Project ID: P1301371  
 CAS Sample ID: P1301371-002

Test Code: EPA TO-15 SIM  
 Instrument ID: Tekmar AUTOCAN/Agilent 5975Cinert/7890A/MS19  
 Analyst: Wida Ang  
 Sample Type: 6.0 L Summa Canister  
 Test Notes:  
 Container ID: AC01464

Date Collected: 3/26/13  
 Date Received: 4/2/13  
 Date Analyzed: 4/6/13  
 Volume(s) Analyzed: 1.00 Liter(s)

Initial Pressure (psig): -4.22      Final Pressure (psig): 3.72

Canister Dilution Factor: 1.76

CAS #	Compound	Result µg/m <sup>3</sup>	MRL µg/m <sup>3</sup>	MDL µg/m <sup>3</sup>	Result ppbV	MRL ppbV	MDL ppbV	Data Qualifier
75-01-4	Vinyl Chloride	ND	0.044	0.0044	ND	0.017	0.0017	
75-35-4	1,1-Dichloroethene	ND	0.044	0.0055	ND	0.011	0.0014	
156-60-5	trans-1,2-Dichloroethene	ND	0.044	0.019	ND	0.011	0.0049	
156-59-2	cis-1,2-Dichloroethene	ND	0.044	0.017	ND	0.011	0.0044	
79-01-6	Trichloroethene	<b>1.3</b>	0.044	0.010	<b>0.25</b>	0.0082	0.0019	
127-18-4	Tetrachloroethene	<b>0.30</b>	0.044	0.0049	<b>0.045</b>	0.0065	0.00073	

ND = Compound was analyzed for, but not detected above the laboratory detection limit.

MRL = Method Reporting Limit - The minimum quantity of a target analyte that can be confidently determined by the referenced method.

RESULTS OF ANALYSIS

Page 1 of 1

**Client:** GSI Environmental Inc.  
**Client Sample ID:** CP4-IA-2  
**Client Project ID:** ESTCP VI Study - Raritan / 3585/3669

CAS Project ID: P1301371  
 CAS Sample ID: P1301371-003

Test Code: EPA TO-15 SIM  
 Instrument ID: Tekmar AUTOCAN/Agilent 5975Cinert/7890A/MS19  
 Analyst: Wida Ang  
 Sample Type: 6.0 L Summa Canister  
 Test Notes:  
 Container ID: AC01662

Date Collected: 3/26/13  
 Date Received: 4/2/13  
 Date Analyzed: 4/6/13  
 Volume(s) Analyzed: 1.00 Liter(s)

Initial Pressure (psig): -1.75      Final Pressure (psig): 3.69

Canister Dilution Factor: 1.42

CAS #	Compound	Result µg/m <sup>3</sup>	MRL µg/m <sup>3</sup>	MDL µg/m <sup>3</sup>	Result ppbV	MRL ppbV	MDL ppbV	Data Qualifier
75-01-4	Vinyl Chloride	ND	0.036	0.0036	ND	0.014	0.0014	
75-35-4	1,1-Dichloroethene	ND	0.036	0.0044	ND	0.0090	0.0011	
156-60-5	trans-1,2-Dichloroethene	<b>0.018</b>	0.036	0.016	<b>0.0045</b>	0.0090	0.0039	<b>J</b>
156-59-2	cis-1,2-Dichloroethene	ND	0.036	0.014	ND	0.0090	0.0035	
79-01-6	Trichloroethene	<b>2.1</b>	0.036	0.0082	<b>0.39</b>	0.0066	0.0015	
127-18-4	Tetrachloroethene	<b>0.27</b>	0.036	0.0040	<b>0.040</b>	0.0052	0.00059	

ND = Compound was analyzed for, but not detected above the laboratory detection limit.

MRL = Method Reporting Limit - The minimum quantity of a target analyte that can be confidently determined by the referenced method.

J = The result is an estimated concentration that is less than the MRL but greater than or equal to the MDL.

RESULTS OF ANALYSIS

Page 1 of 1

**Client:** GSI Environmental Inc.  
**Client Sample ID:** CP4-IA-3  
**Client Project ID:** ESTCP VI Study - Raritan / 3585/3669

CAS Project ID: P1301371  
 CAS Sample ID: P1301371-004

Test Code: EPA TO-15 SIM  
 Instrument ID: Tekmar AUTOCAN/Agilent 5975Cinert/7890A/MS19  
 Analyst: Wida Ang  
 Sample Type: 6.0 L Summa Canister  
 Test Notes:  
 Container ID: AS00452

Date Collected: 3/26/13  
 Date Received: 4/2/13  
 Date Analyzed: 4/6/13  
 Volume(s) Analyzed: 1.00 Liter(s)

Initial Pressure (psig): -0.10      Final Pressure (psig): 3.81

Canister Dilution Factor: 1.27

CAS #	Compound	Result µg/m <sup>3</sup>	MRL µg/m <sup>3</sup>	MDL µg/m <sup>3</sup>	Result ppbV	MRL ppbV	MDL ppbV	Data Qualifier
75-01-4	Vinyl Chloride	ND	0.032	0.0032	ND	0.012	0.0012	
75-35-4	1,1-Dichloroethene	ND	0.032	0.0039	ND	0.0080	0.00099	
156-60-5	trans-1,2-Dichloroethene	ND	0.032	0.014	ND	0.0080	0.0035	
156-59-2	cis-1,2-Dichloroethene	ND	0.032	0.012	ND	0.0080	0.0031	
79-01-6	Trichloroethene	<b>2.4</b>	0.032	0.0074	<b>0.44</b>	0.0059	0.0014	
127-18-4	Tetrachloroethene	<b>0.16</b>	0.032	0.0036	<b>0.024</b>	0.0047	0.00052	

ND = Compound was analyzed for, but not detected above the laboratory detection limit.

MRL = Method Reporting Limit - The minimum quantity of a target analyte that can be confidently determined by the referenced method.

RESULTS OF ANALYSIS

Page 1 of 1

**Client:** GSI Environmental Inc.  
**Client Sample ID:** CP4-SG-6  
**Client Project ID:** ESTCP VI Study - Raritan / 3585/3669

CAS Project ID: P1301371  
 CAS Sample ID: P1301371-005

Test Code: EPA TO-15 SIM  
 Instrument ID: Tekmar AUTOCAN/Agilent 5975Cinert/7890A/MS19  
 Analyst: Wida Ang  
 Sample Type: 6.0 L Summa Canister  
 Test Notes:  
 Container ID: AS00364

Date Collected: 3/26/13  
 Date Received: 4/2/13  
 Date Analyzed: 4/6/13  
 Volume(s) Analyzed: 1.00 Liter(s)

Initial Pressure (psig): -1.37      Final Pressure (psig): 3.58

Canister Dilution Factor: 1.37

CAS #	Compound	Result µg/m <sup>3</sup>	MRL µg/m <sup>3</sup>	MDL µg/m <sup>3</sup>	Result ppbV	MRL ppbV	MDL ppbV	Data Qualifier
75-01-4	Vinyl Chloride	ND	0.034	0.0034	ND	0.013	0.0013	
75-35-4	1,1-Dichloroethene	ND	0.034	0.0042	ND	0.0086	0.0011	
156-60-5	trans-1,2-Dichloroethene	<b>0.023</b>	0.034	0.015	<b>0.0058</b>	0.0086	0.0038	<b>J</b>
156-59-2	cis-1,2-Dichloroethene	<b>0.014</b>	0.034	0.013	<b>0.0034</b>	0.0086	0.0034	<b>J</b>
79-01-6	Trichloroethene	<b>15</b>	0.034	0.0079	<b>2.9</b>	0.0064	0.0015	
127-18-4	Tetrachloroethene	<b>7.3</b>	0.034	0.0038	<b>1.1</b>	0.0051	0.00057	

ND = Compound was analyzed for, but not detected above the laboratory detection limit.

MRL = Method Reporting Limit - The minimum quantity of a target analyte that can be confidently determined by the referenced method.

J = The result is an estimated concentration that is less than the MRL but greater than or equal to the MDL.



RESULTS OF ANALYSIS

Page 1 of 1

**Client:** GSI Environmental Inc.  
**Client Sample ID:** CP4-SG-3  
**Client Project ID:** ESTCP VI Study - Raritan / 3585/3669

CAS Project ID: P1301371  
 CAS Sample ID: P1301371-006

Test Code: EPA TO-15 SIM  
 Instrument ID: Tekmar AUTOCAN/Agilent 5975Cinert/7890A/MS19  
 Analyst: Wida Ang  
 Sample Type: 6.0 L Summa Canister  
 Test Notes:  
 Container ID: AC01810

Date Collected: 3/26/13  
 Date Received: 4/2/13  
 Date Analyzed: 4/6/13 & 4/8/13  
 Volume(s) Analyzed: 1.00 Liter(s)  
 0.10 Liter(s)

Initial Pressure (psig): -1.27      Final Pressure (psig): 3.62

Canister Dilution Factor: 1.36

CAS #	Compound	Result µg/m <sup>3</sup>	MRL µg/m <sup>3</sup>	MDL µg/m <sup>3</sup>	Result ppbV	MRL ppbV	MDL ppbV	Data Qualifier
75-01-4	Vinyl Chloride	ND	0.034	0.0034	ND	0.013	0.0013	
75-35-4	1,1-Dichloroethene	ND	0.034	0.0042	ND	0.0086	0.0011	
156-60-5	trans-1,2-Dichloroethene	<b>0.30</b>	0.034	0.015	<b>0.076</b>	0.0086	0.0038	
156-59-2	cis-1,2-Dichloroethene	<b>1.1</b>	0.034	0.013	<b>0.28</b>	0.0086	0.0034	
79-01-6	Trichloroethene	<b>93</b>	0.34	0.079	<b>17</b>	0.063	0.015	<b>D</b>
127-18-4	Tetrachloroethene	<b>12</b>	0.034	0.0038	<b>1.7</b>	0.0050	0.00056	

ND = Compound was analyzed for, but not detected above the laboratory detection limit.

MRL = Method Reporting Limit - The minimum quantity of a target analyte that can be confidently determined by the referenced method.

D = The reported result is from a dilution.

RESULTS OF ANALYSIS

Page 1 of 1

**Client:** GSI Environmental Inc.  
**Client Sample ID:** 209-SG-06  
**Client Project ID:** ESTCP VI Study - Raritan / 3585/3669

CAS Project ID: P1301371  
 CAS Sample ID: P1301371-007

Test Code: EPA TO-15 SIM  
 Instrument ID: Tekmar AUTOCAN/Agilent 5975Cinert/7890A/MS19  
 Analyst: Wida Ang  
 Sample Type: 6.0 L Summa Canister  
 Test Notes:  
 Container ID: AC01785

Date Collected: 3/27/13  
 Date Received: 4/2/13  
 Date Analyzed: 4/6/13  
 Volume(s) Analyzed: 1.00 Liter(s)

Initial Pressure (psig): -2.01      Final Pressure (psig): 3.61

Canister Dilution Factor: 1.44

CAS #	Compound	Result µg/m <sup>3</sup>	MRL µg/m <sup>3</sup>	MDL µg/m <sup>3</sup>	Result ppbV	MRL ppbV	MDL ppbV	Data Qualifier
75-01-4	Vinyl Chloride	ND	0.036	0.0036	ND	0.014	0.0014	
75-35-4	1,1-Dichloroethene	<b>0.028</b>	0.036	0.0045	<b>0.0072</b>	0.0091	0.0011	<b>J</b>
156-60-5	trans-1,2-Dichloroethene	ND	0.036	0.016	ND	0.0091	0.0040	
156-59-2	cis-1,2-Dichloroethene	ND	0.036	0.014	ND	0.0091	0.0036	
79-01-6	Trichloroethene	<b>0.55</b>	0.036	0.0084	<b>0.10</b>	0.0067	0.0016	
127-18-4	Tetrachloroethene	<b>13</b>	0.036	0.0040	<b>1.9</b>	0.0053	0.00059	

ND = Compound was analyzed for, but not detected above the laboratory detection limit.

MRL = Method Reporting Limit - The minimum quantity of a target analyte that can be confidently determined by the referenced method.

J = The result is an estimated concentration that is less than the MRL but greater than or equal to the MDL.

RESULTS OF ANALYSIS

Page 1 of 1

**Client:** GSI Environmental Inc.  
**Client Sample ID:** 209-SG-09  
**Client Project ID:** ESTCP VI Study - Raritan / 3585/3669

CAS Project ID: P1301371  
 CAS Sample ID: P1301371-008

Test Code: EPA TO-15 SIM  
 Instrument ID: Tekmar AUTOCAN/Agilent 5975Cinert/7890A/MS19  
 Analyst: Wida Ang  
 Sample Type: 6.0 L Summa Canister  
 Test Notes:  
 Container ID: AS00370

Date Collected: 3/27/13  
 Date Received: 4/2/13  
 Date Analyzed: 4/6/13  
 Volume(s) Analyzed: 0.20 Liter(s)

Initial Pressure (psig): -1.85      Final Pressure (psig): 3.63

Canister Dilution Factor: 1.43

CAS #	Compound	Result µg/m <sup>3</sup>	MRL µg/m <sup>3</sup>	MDL µg/m <sup>3</sup>	Result ppbV	MRL ppbV	MDL ppbV	Data Qualifier
75-01-4	Vinyl Chloride	ND	0.18	0.018	ND	0.070	0.0070	
75-35-4	1,1-Dichloroethene	<b>0.050</b>	0.18	0.022	<b>0.013</b>	0.045	0.0056	<b>J</b>
156-60-5	trans-1,2-Dichloroethene	ND	0.18	0.079	ND	0.045	0.020	
156-59-2	cis-1,2-Dichloroethene	ND	0.18	0.070	ND	0.045	0.018	
79-01-6	Trichloroethene	<b>8.1</b>	0.18	0.041	<b>1.5</b>	0.033	0.0077	
127-18-4	Tetrachloroethene	<b>6.4</b>	0.18	0.020	<b>0.95</b>	0.026	0.0030	

ND = Compound was analyzed for, but not detected above the laboratory detection limit.

MRL = Method Reporting Limit - The minimum quantity of a target analyte that can be confidently determined by the referenced method.

J = The result is an estimated concentration that is less than the MRL but greater than or equal to the MDL.

RESULTS OF ANALYSIS

Page 1 of 1

**Client:** GSI Environmental Inc.  
**Client Sample ID:** 209-IA-09  
**Client Project ID:** ESTCP VI Study - Raritan / 3585/3669

CAS Project ID: P1301371  
 CAS Sample ID: P1301371-009

Test Code: EPA TO-15 SIM  
 Instrument ID: Tekmar AUTOCAN/Agilent 5975Cinert/7890A/MS19  
 Analyst: Wida Ang  
 Sample Type: 6.0 L Summa Canister  
 Test Notes:  
 Container ID: AS00288

Date Collected: 3/27/13  
 Date Received: 4/2/13  
 Date Analyzed: 4/6/13  
 Volume(s) Analyzed: 0.20 Liter(s)

Initial Pressure (psig): -3.92      Final Pressure (psig): 3.69

Canister Dilution Factor: 1.71

CAS #	Compound	Result µg/m <sup>3</sup>	MRL µg/m <sup>3</sup>	MDL µg/m <sup>3</sup>	Result ppbV	MRL ppbV	MDL ppbV	Data Qualifier
75-01-4	Vinyl Chloride	ND	0.21	0.021	ND	0.084	0.0084	
75-35-4	1,1-Dichloroethene	<b>0.063</b>	0.21	0.027	<b>0.016</b>	0.054	0.0067	<b>J</b>
156-60-5	trans-1,2-Dichloroethene	ND	0.21	0.094	ND	0.054	0.024	
156-59-2	cis-1,2-Dichloroethene	ND	0.21	0.084	ND	0.054	0.021	
79-01-6	Trichloroethene	ND	0.21	0.050	ND	0.040	0.0092	
127-18-4	Tetrachloroethene	<b>0.073</b>	0.21	0.024	<b>0.011</b>	0.032	0.0035	<b>J</b>

ND = Compound was analyzed for, but not detected above the laboratory detection limit.

MRL = Method Reporting Limit - The minimum quantity of a target analyte that can be confidently determined by the referenced method.

J = The result is an estimated concentration that is less than the MRL but greater than or equal to the MDL.

RESULTS OF ANALYSIS

Page 1 of 1

**Client:** GSI Environmental Inc.  
**Client Sample ID:** 209-IA-10  
**Client Project ID:** ESTCP VI Study - Raritan / 3585/3669

CAS Project ID: P1301371  
 CAS Sample ID: P1301371-010

Test Code: EPA TO-15 SIM  
 Instrument ID: Tekmar AUTOCAN/Agilent 5975Cinert/7890A/MS19  
 Analyst: Wida Ang  
 Sample Type: 6.0 L Summa Canister  
 Test Notes:  
 Container ID: AC01788

Date Collected: 3/27/13  
 Date Received: 4/2/13  
 Date Analyzed: 4/6/13  
 Volume(s) Analyzed: 1.00 Liter(s)

Initial Pressure (psig): -3.91      Final Pressure (psig): 3.77

Canister Dilution Factor: 1.71

CAS #	Compound	Result µg/m <sup>3</sup>	MRL µg/m <sup>3</sup>	MDL µg/m <sup>3</sup>	Result ppbV	MRL ppbV	MDL ppbV	Data Qualifier
75-01-4	Vinyl Chloride	ND	0.043	0.0043	ND	0.017	0.0017	
75-35-4	1,1-Dichloroethene	ND	0.043	0.0053	ND	0.011	0.0013	
156-60-5	trans-1,2-Dichloroethene	ND	0.043	0.019	ND	0.011	0.0047	
156-59-2	cis-1,2-Dichloroethene	ND	0.043	0.017	ND	0.011	0.0042	
79-01-6	Trichloroethene	<b>0.064</b>	0.043	0.0099	<b>0.012</b>	0.0080	0.0018	
127-18-4	Tetrachloroethene	<b>0.058</b>	0.043	0.0048	<b>0.0086</b>	0.0063	0.00071	

ND = Compound was analyzed for, but not detected above the laboratory detection limit.

MRL = Method Reporting Limit - The minimum quantity of a target analyte that can be confidently determined by the referenced method.

RESULTS OF ANALYSIS

Page 1 of 1

**Client:** GSI Environmental Inc.  
**Client Sample ID:** 209-AA-1  
**Client Project ID:** ESTCP VI Study - Raritan / 3585/3669

CAS Project ID: P1301371  
 CAS Sample ID: P1301371-011

Test Code: EPA TO-15 SIM  
 Instrument ID: Tekmar AUTOCAN/Agilent 5975Cinert/7890A/MS19  
 Analyst: Wida Ang  
 Sample Type: 6.0 L Summa Canister  
 Test Notes:  
 Container ID: AC00791

Date Collected: 3/27/13  
 Date Received: 4/2/13  
 Date Analyzed: 4/6/13  
 Volume(s) Analyzed: 1.00 Liter(s)

Initial Pressure (psig): -3.42      Final Pressure (psig): 3.76

Canister Dilution Factor: 1.64

CAS #	Compound	Result µg/m <sup>3</sup>	MRL µg/m <sup>3</sup>	MDL µg/m <sup>3</sup>	Result ppbV	MRL ppbV	MDL ppbV	Data Qualifier
75-01-4	Vinyl Chloride	ND	0.041	0.0041	ND	0.016	0.0016	
75-35-4	1,1-Dichloroethene	ND	0.041	0.0051	ND	0.010	0.0013	
156-60-5	trans-1,2-Dichloroethene	ND	0.041	0.018	ND	0.010	0.0046	
156-59-2	cis-1,2-Dichloroethene	ND	0.041	0.016	ND	0.010	0.0041	
79-01-6	Trichloroethene	<b>0.017</b>	0.041	0.0095	<b>0.0032</b>	0.0076	0.0018	<b>J</b>
127-18-4	Tetrachloroethene	<b>0.042</b>	0.041	0.0046	<b>0.0062</b>	0.0060	0.00068	

ND = Compound was analyzed for, but not detected above the laboratory detection limit.

MRL = Method Reporting Limit - The minimum quantity of a target analyte that can be confidently determined by the referenced method.

J = The result is an estimated concentration that is less than the MRL but greater than or equal to the MDL.

RESULTS OF ANALYSIS

Page 1 of 1

**Client:** GSI Environmental Inc.  
**Client Sample ID:** CP4-IA-5-BL  
**Client Project ID:** ESTCP VI Study - Raritan / 3585/3669

CAS Project ID: P1301371  
 CAS Sample ID: P1301371-012

Test Code: EPA TO-15 SIM  
 Instrument ID: Tekmar AUTOCAN/Agilent 5975Cinert/7890A/MS19  
 Analyst: Wida Ang  
 Sample Type: 6.0 L Summa Canister  
 Test Notes:  
 Container ID: AC01855

Date Collected: 3/28/13  
 Date Received: 4/2/13  
 Date Analyzed: 4/8/13  
 Volume(s) Analyzed: 1.00 Liter(s)

Initial Pressure (psig): 0.55      Final Pressure (psig): 3.60

Canister Dilution Factor: 1.20

CAS #	Compound	Result µg/m <sup>3</sup>	MRL µg/m <sup>3</sup>	MDL µg/m <sup>3</sup>	Result ppbV	MRL ppbV	MDL ppbV	Data Qualifier
75-01-4	Vinyl Chloride	ND	0.030	0.0030	ND	0.012	0.0012	
75-35-4	1,1-Dichloroethene	ND	0.030	0.0037	ND	0.0076	0.00094	
156-60-5	trans-1,2-Dichloroethene	<b>0.041</b>	0.030	0.013	<b>0.010</b>	0.0076	0.0033	
156-59-2	cis-1,2-Dichloroethene	ND	0.030	0.012	ND	0.0076	0.0030	
79-01-6	Trichloroethene	<b>0.43</b>	0.030	0.0070	<b>0.080</b>	0.0056	0.0013	
127-18-4	Tetrachloroethene	<b>0.066</b>	0.030	0.0034	<b>0.0098</b>	0.0044	0.00050	

ND = Compound was analyzed for, but not detected above the laboratory detection limit.

MRL = Method Reporting Limit - The minimum quantity of a target analyte that can be confidently determined by the referenced method.

RESULTS OF ANALYSIS

Page 1 of 1

**Client:** GSI Environmental Inc.  
**Client Sample ID:** CP4-IA-5-NP  
**Client Project ID:** ESTCP VI Study - Raritan / 3585/3669

CAS Project ID: P1301371  
 CAS Sample ID: P1301371-013

Test Code: EPA TO-15 SIM  
 Instrument ID: Tekmar AUTOCAN/Agilent 5975Cinert/7890A/MS19  
 Analyst: Wida Ang  
 Sample Type: 6.0 L Summa Canister  
 Test Notes:  
 Container ID: AC00389

Date Collected: 3/28/13  
 Date Received: 4/2/13  
 Date Analyzed: 4/8/13  
 Volume(s) Analyzed: 0.20 Liter(s)

Initial Pressure (psig): 0.11      Final Pressure (psig): 3.76

Canister Dilution Factor: 1.25

CAS #	Compound	Result µg/m <sup>3</sup>	MRL µg/m <sup>3</sup>	MDL µg/m <sup>3</sup>	Result ppbV	MRL ppbV	MDL ppbV	Data Qualifier
75-01-4	Vinyl Chloride	ND	0.16	0.016	ND	0.061	0.0061	
75-35-4	1,1-Dichloroethene	ND	0.16	0.019	ND	0.039	0.0049	
156-60-5	trans-1,2-Dichloroethene	ND	0.16	0.069	ND	0.039	0.017	
156-59-2	cis-1,2-Dichloroethene	ND	0.16	0.061	ND	0.039	0.015	
79-01-6	Trichloroethene	<b>0.32</b>	0.16	0.036	<b>0.060</b>	0.029	0.0067	
127-18-4	Tetrachloroethene	<b>0.097</b>	0.16	0.018	<b>0.014</b>	0.023	0.0026	<b>J</b>

ND = Compound was analyzed for, but not detected above the laboratory detection limit.

MRL = Method Reporting Limit - The minimum quantity of a target analyte that can be confidently determined by the referenced method.

J = The result is an estimated concentration that is less than the MRL but greater than or equal to the MDL.



RESULTS OF ANALYSIS

Page 1 of 1

**Client:** GSI Environmental Inc.  
**Client Sample ID:** DUP-1  
**Client Project ID:** ESTCP VI Study - Raritan / 3585/3669

CAS Project ID: P1301371  
 CAS Sample ID: P1301371-014

Test Code: EPA TO-15 SIM  
 Instrument ID: Tekmar AUTOCAN/Agilent 5975Cinert/7890A/MS19  
 Analyst: Wida Ang  
 Sample Type: 6.0 L Summa Canister  
 Test Notes:  
 Container ID: AC01263

Date Collected: 3/28/13  
 Date Received: 4/2/13  
 Date Analyzed: 4/8/13  
 Volume(s) Analyzed: 0.20 Liter(s)

Initial Pressure (psig): 0.44      Final Pressure (psig): 3.58

Canister Dilution Factor: 1.21

CAS #	Compound	Result µg/m <sup>3</sup>	MRL µg/m <sup>3</sup>	MDL µg/m <sup>3</sup>	Result ppbV	MRL ppbV	MDL ppbV	Data Qualifier
75-01-4	Vinyl Chloride	ND	0.15	0.015	ND	0.059	0.0059	
75-35-4	1,1-Dichloroethene	ND	0.15	0.019	ND	0.038	0.0047	
156-60-5	trans-1,2-Dichloroethene	<b>0.25</b>	0.15	0.067	<b>0.064</b>	0.038	0.017	
156-59-2	cis-1,2-Dichloroethene	ND	0.15	0.059	ND	0.038	0.015	
79-01-6	Trichloroethene	<b>0.33</b>	0.15	0.035	<b>0.062</b>	0.028	0.0065	
127-18-4	Tetrachloroethene	<b>0.17</b>	0.15	0.017	<b>0.025</b>	0.022	0.0025	

ND = Compound was analyzed for, but not detected above the laboratory detection limit.

MRL = Method Reporting Limit - The minimum quantity of a target analyte that can be confidently determined by the referenced method.

RESULTS OF ANALYSIS

Page 1 of 1

**Client:** GSI Environmental Inc.  
**Client Sample ID:** Method Blank  
**Client Project ID:** ESTCP VI Study - Raritan / 3585/3669

CAS Project ID: P1301371  
 CAS Sample ID: P130406-MB

Test Code: EPA TO-15 SIM  
 Instrument ID: Tekmar AUTOCAN/Agilent 5975Cinert/7890A/MS19  
 Analyst: Wida Ang  
 Sample Type: 6.0 L Summa Canister  
 Test Notes:

Date Collected: NA  
 Date Received: NA  
 Date Analyzed: 4/6/13  
 Volume(s) Analyzed: 1.00 Liter(s)

Canister Dilution Factor: 1.00

CAS #	Compound	Result µg/m <sup>3</sup>	MRL µg/m <sup>3</sup>	MDL µg/m <sup>3</sup>	Result ppbV	MRL ppbV	MDL ppbV	Data Qualifier
75-01-4	Vinyl Chloride	ND	0.025	0.0025	ND	0.0098	0.00098	
75-35-4	1,1-Dichloroethene	ND	0.025	0.0031	ND	0.0063	0.00078	
156-60-5	trans-1,2-Dichloroethene	ND	0.025	0.011	ND	0.0063	0.0028	
156-59-2	cis-1,2-Dichloroethene	ND	0.025	0.0098	ND	0.0063	0.0025	
79-01-6	Trichloroethene	ND	0.025	0.0058	ND	0.0047	0.0011	
127-18-4	Tetrachloroethene	ND	0.025	0.0028	ND	0.0037	0.00041	

ND = Compound was analyzed for, but not detected above the laboratory detection limit.

MRL = Method Reporting Limit - The minimum quantity of a target analyte that can be confidently determined by the referenced method.

RESULTS OF ANALYSIS

Page 1 of 1

**Client:** GSI Environmental Inc.  
**Client Sample ID:** Method Blank  
**Client Project ID:** ESTCP VI Study - Raritan / 3585/3669

CAS Project ID: P1301371  
 CAS Sample ID: P130408-MB

Test Code: EPA TO-15 SIM  
 Instrument ID: Tekmar AUTOCAN/Agilent 5975Cinert/7890A/MS19  
 Analyst: Wida Ang  
 Sample Type: 6.0 L Summa Canister  
 Test Notes:

Date Collected: NA  
 Date Received: NA  
 Date Analyzed: 4/8/13  
 Volume(s) Analyzed: 1.00 Liter(s)

Canister Dilution Factor: 1.00

CAS #	Compound	Result µg/m <sup>3</sup>	MRL µg/m <sup>3</sup>	MDL µg/m <sup>3</sup>	Result ppbV	MRL ppbV	MDL ppbV	Data Qualifier
75-01-4	Vinyl Chloride	ND	0.025	0.0025	ND	0.0098	0.00098	
75-35-4	1,1-Dichloroethene	ND	0.025	0.0031	ND	0.0063	0.00078	
156-60-5	trans-1,2-Dichloroethene	ND	0.025	0.011	ND	0.0063	0.0028	
156-59-2	cis-1,2-Dichloroethene	ND	0.025	0.0098	ND	0.0063	0.0025	
79-01-6	Trichloroethene	ND	0.025	0.0058	ND	0.0047	0.0011	
127-18-4	Tetrachloroethene	ND	0.025	0.0028	ND	0.0037	0.00041	

ND = Compound was analyzed for, but not detected above the laboratory detection limit.

MRL = Method Reporting Limit - The minimum quantity of a target analyte that can be confidently determined by the referenced method.

SURROGATE SPIKE RECOVERY RESULTS

Page 1 of 1

**Client:** GSI Environmental Inc.  
**Client Project ID:** ESTCP VI Study - Raritan / 3585/3669

CAS Project ID: P1301371

Test Code: EPA TO-15 SIM  
 Instrument ID: Tekmar AUTOCAN/Agilent 5975Cinert/7890A/MS19  
 Analyst: Wida Ang  
 Sample Type: 6.0 L Summa Canister(s)  
 Test Notes:

Date(s) Collected: 3/26 - 3/28/13  
 Date(s) Received: 4/2/13  
 Date(s) Analyzed: 4/6 - 4/8/13

Client Sample ID	CAS Sample ID	1,2-Dichloroethane-d4	Toluene-d8	Bromofluorobenzene	Acceptance Limits	Data Qualifier
		% Recovered	% Recovered	% Recovered		
Method Blank	P130406-MB	91	104	92	70-130	
Method Blank	P130408-MB	88	103	95	70-130	
Lab Control Sample	P130406-LCS	94	103	93	70-130	
Lab Control Sample	P130408-LCS	91	103	95	70-130	
CP4-AA-1	P1301371-001	91	105	89	70-130	
CP4-IA-1	P1301371-002	91	104	86	70-130	
CP4-IA-1	P1301371-002DUP	90	104	87	70-130	
CP4-IA-2	P1301371-003	90	105	82	70-130	
CP4-IA-3	P1301371-004	90	104	82	70-130	
CP4-SG-6	P1301371-005	90	105	88	70-130	
CP4-SG-3	P1301371-006	89	106	80	70-130	
209-SG-06	P1301371-007	91	102	88	70-130	
209-SG-09	P1301371-008	91	106	90	70-130	
209-IA-09	P1301371-009	91	104	92	70-130	
209-IA-10	P1301371-010	90	103	90	70-130	
209-AA-1	P1301371-011	90	103	92	70-130	
CP4-IA-5-BL	P1301371-012	88	102	77	70-130	
CP4-IA-5-NP	P1301371-013	90	104	77	70-130	
DUP-1	P1301371-014	89	105	75	70-130	

Surrogate percent recovery is verified and accepted based on the on-column result.

Reported results are shown in concentration units and as a result of the calculation, may vary slightly from the on-column percent recovery.

LABORATORY CONTROL SAMPLE SUMMARY

Page 1 of 1

**Client:** GSI Environmental Inc.  
**Client Sample ID:** Lab Control Sample  
**Client Project ID:** ESTCP VI Study - Raritan / 3585/3669  
 CAS Project ID: P1301371  
 CAS Sample ID: P130406-LCS  
 Test Code: EPA TO-15 SIM  
 Instrument ID: Tekmar AUTOCAN/Agilent 5975Cinert/7890A/MS19  
 Analyst: Wida Ang  
 Sample Type: 6.0 L Summa Canister  
 Test Notes:  
 Date Collected: NA  
 Date Received: NA  
 Date Analyzed: 4/06/13  
 Volume(s) Analyzed: 0.125 Liter(s)

CAS #	Compound	Spike Amount µg/m <sup>3</sup>	Result µg/m <sup>3</sup>	% Recovery	CAS	Data Qualifier
					Acceptance Limits	
75-01-4	Vinyl Chloride	4.00	<b>4.15</b>	<b>104</b>	56-117	
75-35-4	1,1-Dichloroethene	4.36	<b>3.88</b>	<b>89</b>	62-113	
156-60-5	trans-1,2-Dichloroethene	4.04	<b>3.54</b>	<b>88</b>	61-111	
156-59-2	cis-1,2-Dichloroethene	4.28	<b>3.73</b>	<b>87</b>	63-112	
79-01-6	Trichloroethene	3.96	<b>3.09</b>	<b>78</b>	58-113	
127-18-4	Tetrachloroethene	3.80	<b>2.84</b>	<b>75</b>	60-111	

Laboratory Control Sample percent recovery is verified and accepted based on the on-column result. Reported results are shown in concentration units and as a result of the calculation, may vary slightly.

LABORATORY CONTROL SAMPLE SUMMARY

Page 1 of 1

**Client:** GSI Environmental Inc.  
**Client Sample ID:** Lab Control Sample  
**Client Project ID:** ESTCP VI Study - Raritan / 3585/3669  
 CAS Project ID: P1301371  
 CAS Sample ID: P130408-LCS  
 Test Code: EPA TO-15 SIM  
 Instrument ID: Tekmar AUTOCAN/Agilent 5975Cinert/7890A/MS19  
 Analyst: Wida Ang  
 Sample Type: 6.0 L Summa Canister  
 Test Notes:  
 Date Collected: NA  
 Date Received: NA  
 Date Analyzed: 4/08/13  
 Volume(s) Analyzed: 0.125 Liter(s)

CAS #	Compound	Spike Amount µg/m <sup>3</sup>	Result µg/m <sup>3</sup>	% Recovery	CAS Acceptance Limits	Data Qualifier
75-01-4	Vinyl Chloride	4.00	3.95	99	56-117	
75-35-4	1,1-Dichloroethene	4.36	3.88	89	62-113	
156-60-5	trans-1,2-Dichloroethene	4.04	3.55	88	61-111	
156-59-2	cis-1,2-Dichloroethene	4.28	3.81	89	63-112	
79-01-6	Trichloroethene	3.96	3.19	81	58-113	
127-18-4	Tetrachloroethene	3.80	2.93	77	60-111	

Laboratory Control Sample percent recovery is verified and accepted based on the on-column result. Reported results are shown in concentration units and as a result of the calculation, may vary slightly.

LABORATORY DUPLICATE SUMMARY RESULTS

Page 1 of 1

**Client:** GSI Environmental Inc.

**Client Sample ID:** CP4-IA-1

**Client Project ID:** ESTCP VI Study - Raritan / 3585/3669

CAS Project ID: P1301371

CAS Sample ID: P1301371-002DUP

Test Code: EPA TO-15 SIM

Date Collected: 3/26/13

Instrument ID: Tekmar AUTOCAN/Agilent 5975Cinert/7890A/MS19

Date Received: 4/2/13

Analyst: Wida Ang

Date Analyzed: 4/6/13

Sample Type: 6.0 L Summa Canister

Volume(s) Analyzed: 1.00 Liter(s)

Test Notes:

Container ID: AC01464

Initial Pressure (psig): -4.22

Final Pressure (psig): 3.72

Canister Dilution Factor: 1.76

CAS #	Compound	Sample Result		Duplicate Sample Result		Average µg/m <sup>3</sup>	% RPD	RPD Limit	Data Qualifier
		µg/m <sup>3</sup>	ppbV	µg/m <sup>3</sup>	ppbV				
75-01-4	Vinyl Chloride	ND	ND	ND	ND	-	-	25	
75-35-4	1,1-Dichloroethene	ND	ND	ND	ND	-	-	25	
156-60-5	trans-1,2-Dichloroethene	ND	ND	ND	ND	-	-	25	
156-59-2	cis-1,2-Dichloroethene	ND	ND	ND	ND	-	-	25	
79-01-6	Trichloroethene	1.35	0.251	1.36	0.253	1.355	<b>0.7</b>	25	
127-18-4	Tetrachloroethene	0.302	0.0446	0.302	0.0446	0.302	<b>0</b>	25	

ND = Compound was analyzed for, but not detected above the laboratory reporting limit.

RESULTS OF ANALYSIS

Page 1 of 1

**Client:** GSI Environmental Inc.  
**Client Project ID:** ESTCP VI Study - Raritan / 3585/3669 CAS Project ID: P1301371

**Method Blank Summary**

Test Code: EPA TO-15 SIM  
 Instrument ID: Tekmar AUTOCAN/Agilent 5975Cinert/7890A/MS19 Lab File ID: 04061303.D  
 Analyst: Wida Ang Date Analyzed: 4/06/13  
 Sample Type: 6.0 L Summa Canister(s) Time Analyzed: 02:34  
 Test Notes:

Client Sample ID	CAS Sample ID	Lab File ID	Time Analyzed
Lab Control Sample	P130406-LCS	04061304.D	03:07
CP4-AA-1	P1301371-001	04061315.D	13:48
CP4-IA-1	P1301371-002	04061316.D	14:21
CP4-IA-1 (Lab Duplicate)	P1301371-002DUP	04061317.D	14:54
CP4-IA-2	P1301371-003	04061318.D	15:26
CP4-IA-3	P1301371-004	04061319.D	15:59
CP4-SG-6	P1301371-005	04061320.D	16:32
CP4-SG-3	P1301371-006	04061321.D	17:05
209-SG-06	P1301371-007	04061322.D	17:37
209-SG-09	P1301371-008	04061323.D	18:10
209-IA-09	P1301371-009	04061324.D	18:43
209-IA-10	P1301371-010	04061325.D	19:15
209-AA-1	P1301371-011	04061326.D	19:48



RESULTS OF ANALYSIS

Page 1 of 1

**Client:** GSI Environmental Inc.  
**Client Project ID:** ESTCP VI Study - Raritan / 3585/3669 CAS Project ID: P1301371

**Method Blank Summary**

Test Code: EPA TO-15 SIM  
Instrument ID: Tekmar AUTOCAN/Agilent 5975Cinert/7890A/MS19 Lab File ID: 04081303.D  
Analyst: Wida Ang Date Analyzed: 4/08/13  
Sample Type: 6.0 L Summa Canister(s) Time Analyzed: 08:39  
Test Notes:

Client Sample ID	CAS Sample ID	Lab File ID	Time Analyzed
Lab Control Sample	P130408-LCS	04081304.D	09:12
CP4-SG-3 (Dilution)	P1301371-006	04081306.D	10:31
CP4-IA-5-BL	P1301371-012	04081312.D	14:12
CP4-IA-5-NP	P1301371-013	04081317.D	17:09
DUP-1	P1301371-014	04081318.D	17:41

RESULTS OF ANALYSIS

Page 1 of 1

**Client:** GSI Environmental Inc.  
**Client Project ID:** ESTCP VI Study - Raritan / 3585/3669

CAS Project ID: P1301371

**Internal Standard Area and RT Summary**

Test Code: EPA TO-15 SIM  
 Instrument ID: Tekmar AUTOCAN/Agilent 5975Cinert/7890A/MS19  
 Analyst: Wida Ang  
 Sample Type: 6.0 L Summa Canister(s)  
 Test Notes:  
 Lab File ID: 04061302.D  
 Date Analyzed: 4/6/13  
 Time Analyzed: 02:01

	IS1 (BCM)		IS2 (DFB)		IS3 (CBZ)						
	AREA	#	RT	#	AREA	#	RT	#			
<b>24 Hour Standard</b>	50217		11.66		220840		13.41		30322		17.09
<b>Upper Limit</b>	70304		11.99		309176		13.74		42451		17.42
<b>Lower Limit</b>	30130		11.33		132504		13.08		18193		16.76

Client Sample ID		IS1 (BCM)	IS2 (DFB)	IS3 (CBZ)			
Client Sample ID	Sample Name	AREA	RT	AREA	RT	AREA	RT
01	Method Blank	49826	11.66	214849	13.41	30678	17.09
02	Lab Control Sample	49938	11.66	219672	13.41	30468	17.09
03	CP4-AA-1	50552	11.66	226086	13.41	31534	17.09
04	CP4-IA-1	50432	11.66	223569	13.40	33583	17.09
05	CP4-IA-1 (Lab Duplicate)	50409	11.66	222053	13.40	32807	17.09
06	CP4-IA-2	50028	11.66	221254	13.41	34539	17.09
07	CP4-IA-3	50867	11.66	225392	13.41	34757	17.09
08	CP4-SG-6	50559	11.66	223155	13.41	32601	17.09
09	CP4-SG-3	50604	11.66	223687	13.41	35978	17.09
10	209-SG-06	50840	11.66	230789	13.41	33313	17.09
11	209-SG-09	50984	11.66	222513	13.41	31646	17.09
12	209-IA-09	50518	11.66	220404	13.41	30064	17.09
13	209-IA-10	49238	11.66	220213	13.41	30839	17.09
14	209-AA-1	49248	11.66	218196	13.40	29491	17.09
15							
16							
17							
18							
19							
20							

IS1 (BCM) = Bromochloromethane  
 IS2 (DFB) = 1,4-Difluorobenzene  
 IS3 (CBZ) = Chlorobenzene-d5

AREA UPPER LIMIT = 140% of internal standard area  
 AREA LOWER LIMIT = 60% of internal standard area  
 RT UPPER LIMIT = 0.33 minutes of internal standard RT  
 RT LOWER LIMIT = 0.33 minutes of internal standard RT

# Column used to flag values outside QC limits with an I.  
 I = Internal standard not within the specified limits. See case narrative.

RESULTS OF ANALYSIS

Page 1 of 1

**Client:** GSI Environmental Inc.  
**Client Project ID:** ESTCP VI Study - Raritan / 3585/3669

CAS Project ID: P1301371

**Internal Standard Area and RT Summary**

Test Code: EPA TO-15 SIM  
 Instrument ID: Tekmar AUTOCAN/Agilent 5975Cinert/7890A/MS19  
 Analyst: Wida Ang  
 Sample Type: 6.0 L Summa Canister(s)  
 Test Notes:

Lab File ID: 04081302.D  
 Date Analyzed: 4/8/13  
 Time Analyzed: 08:06

	IS1 (BCM)		IS2 (DFB)		IS3 (CBZ)						
	AREA	#	RT	#	AREA	#	RT	#			
<b>24 Hour Standard</b>	50663		11.66		220706		13.41		29173		17.09
<b>Upper Limit</b>	70928		11.99		308988		13.74		40842		17.42
<b>Lower Limit</b>	30398		11.33		132424		13.08		17504		16.76

Client Sample ID		IS1 (BCM)	IS2 (DFB)	IS3 (CBZ)			
Client Sample ID	Description	AREA	RT	AREA	RT	AREA	RT
01	Method Blank	49936	11.66	217389	13.41	28648	17.09
02	Lab Control Sample	51082	11.66	222836	13.41	29396	17.09
03	CP4-SG-3 (Dilution)	51745	11.66	219682	13.41	31358	17.09
04	CP4-IA-5-BL	53900	11.66	235852	13.41	37656	17.09
05	CP4-IA-5-NP	51790	11.66	226392	13.41	37454	17.09
06	DUP-1	49347	11.65	215068	13.40	36550	17.09
07							
08							
09							
10							
11							
12							
13							
14							
15							
16							
17							
18							
19							
20							

IS1 (BCM) = Bromochloromethane  
 IS2 (DFB) = 1,4-Difluorobenzene  
 IS3 (CBZ) = Chlorobenzene-d5

AREA UPPER LIMIT = 140% of internal standard area  
 AREA LOWER LIMIT = 60% of internal standard area  
 RT UPPER LIMIT = 0.33 minutes of internal standard RT  
 RT LOWER LIMIT = 0.33 minutes of internal standard RT

# Column used to flag values outside QC limits with an I.  
 I = Internal standard not within the specified limits. See case narrative.

Response Factor Report MS19

Method Path : I:\MS19\METHODS\  
 Method File : X19032813.M  
 Title : EPA TO-15 per SOP VOA-TO15 (CASS TO-15/GC-MS)  
 Last Update : Thu Mar 28 14:08:39 2013  
 Response Via : Initial Calibration

Calibration Files

10 =03281302.D 20 =03281303.D 50 =03281304.D 100 =03281305.D 500 =03281306.D 1000=03281307.D  
 2500=03281308.D 9999=03281309.D 20K =03281310.D

Compound	10	20	50	100	500	1000	2500	9999	20K	Avg	%RSD
1) I Bromochloromethane...				ISTD							
2) T Dichlorodifluo...	3.095	2.831	2.652	2.598	2.581	2.480	2.350	2.276	2.228	2.566	10.77
3) T Chloromethane		0.578	0.478	0.433	0.437	0.414	0.358	0.420	0.442	0.445	14.29
4) T Vinyl Chloride	1.727	1.625	1.507	1.474	1.448	1.416	1.363	1.355	1.399	1.479	8.41
5) T Bromomethane		1.165	0.924	0.806	0.827	0.779	0.735	0.815	0.819	0.859	15.69
6) T Chloroethane	0.776	0.719	0.611	0.590	0.585	0.560	0.543	0.588	0.591	0.618	12.47
7) T Acetone					0.497	0.464	0.437	0.444	0.444	0.457	5.32
8) T Trichlorofluor...	2.336	2.155	1.978	1.947	1.937	1.857	1.807	1.842	1.800	1.962	9.09
9) T 1,1-Dichloroet...	1.355	1.179	1.109	1.068	1.096	1.057	1.037	1.103	1.112	1.124	8.50
10) T Methylene Chloro...		1.653	1.397	1.217	1.152	1.100	1.100	1.103	1.094	1.245	16.81
11) T Trichlorotrifl...	1.574	1.432	1.359	1.287	1.240	1.171	1.140	1.111	1.156	1.275	12.17
12) T trans-1,2-Dich...	1.551	1.408	1.291	1.239	1.251	1.209	1.177	1.222	1.229	1.286	9.28
13) T 1,1-Dichloroet...	2.232	1.977	1.777	1.707	1.776	1.671	1.615	1.740	1.706	1.800	10.60
14) T Methyl tert-Bu...	3.186	2.899	2.697	2.678	2.731	2.760	2.860	2.950	3.079	2.871	6.15
15) T cis-1,2-Dichlo...	1.557	1.371	1.287	1.252	1.279	1.230	1.204	1.258	1.238	1.297	8.35
16) T Chloroform	2.438	2.212	2.046	1.934	1.999	1.909	1.818	1.886	1.833	2.008	10.03
17) S 1,2-Dichloroet...	1.294	1.283	1.287	1.249	1.255	1.249	1.207	1.195	1.187	1.245	3.25
18) T 1,2-Dichloroet...	1.835	1.643	1.547	1.491	1.487	1.429	1.382	1.387	1.358	1.506	10.14
19) T 1,1,1-Trichlor...	2.304	2.125	1.972	1.905	1.905	1.831	1.797	1.850	1.848	1.948	8.47
20) T Benzene		4.709	4.324	4.145	3.975	3.874	3.874	3.890	3.825	4.106	7.76
21) T Carbon Tetrach...	1.628	1.582	1.520	1.493	1.549	1.515	1.504	1.570	1.582	1.549	2.88
22) I 1,4-Difluorobenzen...				ISTD							
23) T 1,2-Dichloropr...	0.282	0.267	0.246	0.240	0.233	0.223	0.218	0.229	0.226	0.241	8.88
24) T Bromodichlorom...	0.398	0.395	0.361	0.353	0.352	0.339	0.336	0.357	0.354	0.361	6.14
25) T Trichloroethene	0.482	0.444	0.388	0.366	0.362	0.342	0.329	0.341	0.333	0.376	14.16
26) T 1,4-Dioxane	0.243	0.217	0.199	0.201	0.203	0.199	0.202	0.217	0.217	0.211	6.90
27) T cis-1,3-Dichlo...	0.364	0.355	0.340	0.346	0.364	0.367	0.379	0.411	0.411	0.371	6.88
28) T trans-1,3-Dich...	0.273	0.284	0.278	0.295	0.306	0.314	0.333	0.371	0.379	0.315	12.31
29) T 1,1,2-Trichlor...	0.272	0.251	0.232	0.229	0.223	0.212	0.208	0.217	0.216	0.229	9.00
30) S Toluene-d8 (SS2)	0.980	1.001	0.984	0.989	0.962	0.952	0.954	0.956	0.964	0.971	1.83
31) T Toluene		1.381	1.192	1.142	1.110	1.061	1.037	1.075	1.036	1.129	10.18
32) T 1,2-Dibromoethane	0.341	0.323	0.299	0.299	0.299	0.291	0.290	0.309	0.309	0.307	5.34
33) T Tetrachloroethene	0.502	0.485	0.443	0.426	0.422	0.397	0.382	0.397	0.391	0.427	9.91
34) I Chlorobenzene-d5 (...)				ISTD							
35) T Chlorobenzene	6.577	6.070	5.519	5.330	5.441	5.260	5.142	5.318	4.956	5.512	9.14
36) T Ethylbenzene	8.499	7.729	7.277	7.300	7.705	7.808	8.021	8.444	7.774	7.840	5.48
37) T m,p-Xylene	6.215	5.808	5.496	5.641	6.343	6.458	6.535	6.752	6.144	6.155	6.92

Method Path : I:\MS19\METHODS\  
 Method File : X19032813.M  
 Title : EPA TO-15 per SOP VOA-TO15 (CASS TO-15/GC-MS)

38) T	o-Xylene	7.131	6.650	6.342	6.460	6.936	6.917	6.913	7.118	6.489	6.773	4.35
39) T	1,1,2,2-Tetrac...	2.830	2.807	2.856	2.979	3.134	3.081	3.162	3.255	3.029	3.015	5.28
40) S	Bromofluoroben...	3.827	3.840	3.782	3.877	3.997	4.026	4.051	3.906	3.717	3.891	2.94
41) T	1,3-Dichlororobe...	6.005	5.213	4.859	4.773	5.080	4.797	4.772	4.935	4.522	4.995	8.55
42) T	1,4-Dichlororobe...	6.869	5.667	5.053	4.914	5.054	4.888	4.876	4.966	4.614	5.211	13.10
43) T	1,2-Dichlororobe...	5.771	5.108	4.783	4.640	4.936	4.702	4.631	4.752	4.378	4.856	8.21
44) T	1,2,4-Trichlor...	4.941	3.975	3.519	3.338	3.542	3.453	3.457	3.718	3.444	3.710	13.45
45) T	Naphthalene	1.424	1.102	0.964	0.929	1.069	1.073	1.094	1.205	1.086	1.105	E1 13.02
46) T	Hexachlorobuta...	2.649	2.441	2.265	2.154	2.259	2.168	2.132	2.269	2.115	2.272	7.62

(#) = Out of Range

Evaluate Continuing Calibration Report

Data File: I:\MS19\DATA\2013\_04\06\04061302.D

Acq On : 6 Apr 2013 2:01 am Operator: WA/KR  
 Sample : 500pg TO-15SIM CCV STD Inst : MS19  
 Misc : S25-03191301/S25-03221308 (4/20)  
 ALS Vial : 15 Sample Multiplier: 1

Quant Time: Apr 06 06:21:52 2013  
 Quant Method : I:\MS19\METHODS\X19032813.M  
 Quant Title : EPA TO-15 per SOP VOA-TO15 (CASS TO-15/GC-MS)  
 QLast Update : Thu Mar 28 14:08:39 2013  
 Response via : Initial Calibration  
 DataAcq Meth: TO15SIM2.M

Min. RRF : 0.000 Min. Rel. Area : 50% Max. R.T. Dev 0.33min  
 Max. RRF Dev : 30% Max. Rel. Area : 200%

	Compound	AvgRF	CCRF	%Dev	Area%	Dev(min)
1 I	Bromochloromethane (IS1)	1.000	1.000	0.0	96	0.00
2 T	Dichlorodifluoromethane (CF	2.566	2.158	15.9	80	0.03
3 T	Chloromethane	0.445	0.486	-9.2	107	0.04
4 T	Vinyl Chloride	1.479	1.590	-7.5	105	0.03
5 T	Bromomethane	0.859	0.891	-3.7	103	0.02
6 T	Chloroethane	0.618	0.725	-17.3	119	0.02
7 T	Acetone	0.457	0.646	-41.4#	125	0.00
8 T	Trichlorofluoromethane	1.962	1.707	13.0	85	0.01
9 T	1,1-Dichloroethene	1.124	1.075	4.4	94	0.00
10 T	Methylene Chloride	1.245	1.165	6.4	92	0.00
11 T	Trichlorotrifluoroethane	1.275	1.064	16.5	82	0.00
12 T	trans-1,2-Dichloroethene	1.286	1.205	6.3	92	0.00
13 T	1,1-Dichloroethane	1.800	1.765	1.9	95	0.00
14 T	Methyl tert-Butyl Ether	2.871	2.849	0.8	100	0.02
15 T	cis-1,2-Dichloroethene	1.297	1.226	5.5	92	0.00
16 T	Chloroform	2.008	1.764	12.2	85	0.00
17 S	1,2-Dichloroethane-d4 (SS1)	1.245	1.169	6.1	89	0.00
18 T	1,2-Dichloroethane	1.506	1.239	17.7	80	0.00
19 T	1,1,1-Trichloroethane	1.948	1.617	17.0	81	0.00
20 T	Benzene	4.106	4.095	0.3	95	0.00
21 T	Carbon Tetrachloride	1.549	1.300	16.1	81	0.00
22 I	1,4-Difluorobenzene (IS2)	1.000	1.000	0.0	101	0.00
23 T	1,2-Dichloropropane	0.241	0.232	3.7	100	0.00
24 T	Bromodichloromethane	0.361	0.295	18.3	85	0.00
25 T	Trichloroethene	0.376	0.310	17.6	87	0.00
26 T	1,4-Dioxane	0.211	0.205	2.8	102	0.01
27 T	cis-1,3-Dichloropropene	0.371	0.345	7.0	96	0.00
28 T	trans-1,3-Dichloropropene	0.315	0.283	10.2	93	0.00
29 T	1,1,2-Trichloroethane	0.229	0.203	11.4	92	0.00
30 S	Toluene-d8 (SS2)	0.971	0.997	-2.7	105	0.00
31 T	Toluene	1.129	1.046	7.4	95	0.00
32 T	1,2-Dibromoethane	0.307	0.265	13.7	90	0.00
33 T	Tetrachloroethene	0.427	0.341	20.1	82	0.00
34 I	Chlorobenzene-d5 (IS3)	1.000	1.000	0.0	93	0.00
35 T	Chlorobenzene	5.512	5.217	5.4	89	0.00
36 T	Ethylbenzene	7.840	8.211	-4.7	99	0.00
37 T	m,p-Xylene	6.155	6.544	-6.3	96	0.00
38 T	o-Xylene	6.773	7.042	-4.0	94	0.00
39 T	1,1,2,2-Tetrachloroethane	3.015	3.106	-3.0	92	0.00
40 S	Bromofluorobenzene (SS3)	3.891	3.709	4.7	86	0.00
41 T	1,3-Dichlorobenzene	4.995	4.587	8.2	84	0.00
42 T	1,4-Dichlorobenzene	5.211	4.587	12.0	84	0.00
43 T	1,2-Dichlorobenzene	4.856	4.414	9.1	83	0.00
44 T	1,2,4-Trichlorobenzene	3.710	3.080	17.0	81	0.00
45 T	Naphthalene	11.050	10.314	6.7	90	0.00
46 T	Hexachlorobutadiene	2.272	1.936	14.8	80	0.00

(#) = Out of Range

SPCC's out = 0 CCC's out = 0

Evaluate Continuing Calibration Report

Data File: I:\MS19\DATA\2013\_04\08\04081302.D

Acq On : 8 Apr 2013 8:06 am

Operator: WA

Sample : 500pg TO-15SIM CCV STD

Inst : MS19

Misc : S25-03191301/S25-03221308 (4/20)

ALS Vial : 15 Sample Multiplier: 1

Quant Time: Apr 08 08:39:40 2013

Quant Method : I:\MS19\METHODS\X19032813.M

Quant Title : EPA TO-15 per SOP VOA-TO15 (CASS TO-15/GC-MS)

QLast Update : Thu Mar 28 14:08:39 2013

Response via : Initial Calibration

DataAcq Meth:TO15SIM2.M

Min. RRF : 0.000 Min. Rel. Area : 50% Max. R.T. Dev 0.33min

Max. RRF Dev : 30% Max. Rel. Area : 200%

	Compound	AvgRF	CCRF	%Dev	Area%	Dev(min)
1 I	Bromochloromethane (IS1)	1.000	1.000	0.0	97	0.00
2 T	Dichlorodifluoromethane (CF	2.566	2.104	18.0	79	0.04
3 T	Chloromethane	0.445	0.473	-6.3	105	0.04
4 T	Vinyl Chloride	1.479	1.552	-4.9	104	0.03
5 T	Bromomethane	0.859	0.887	-3.3	104	0.03
6 T	Chloroethane	0.618	0.708	-14.6	117	0.03
7 T	Acetone	0.457	0.639	-39.8#	124	0.00
8 T	Trichlorofluoromethane	1.962	1.684	14.2	84	0.01
9 T	1,1-Dichloroethene	1.124	1.067	5.1	94	0.00
10 T	Methylene Chloride	1.245	1.151	7.6	92	0.00
11 T	Trichlorotrifluoroethane	1.275	1.086	14.8	85	0.00
12 T	trans-1,2-Dichloroethene	1.286	1.202	6.5	93	0.00
13 T	1,1-Dichloroethane	1.800	1.697	5.7	92	0.00
14 T	Methyl tert-Butyl Ether	2.871	2.903	-1.1	103	0.02
15 T	cis-1,2-Dichloroethene	1.297	1.227	5.4	93	0.00
16 T	Chloroform	2.008	1.751	12.8	85	0.00
17 S	1,2-Dichloroethane-d4 (SS1)	1.245	1.127	9.5	87	0.00
18 T	1,2-Dichloroethane	1.506	1.208	19.8	79	0.00
19 T	1,1,1-Trichloroethane	1.948	1.613	17.2	82	0.00
20 T	Benzene	4.106	4.108	-0.0	96	0.00
21 T	Carbon Tetrachloride	1.549	1.284	17.1	80	0.00
22 I	1,4-Difluorobenzene (IS2)	1.000	1.000	0.0	101	0.00
23 T	1,2-Dichloropropane	0.241	0.232	3.7	101	0.00
24 T	Bromodichloromethane	0.361	0.297	17.7	85	0.00
25 T	Trichloroethene	0.376	0.314	16.5	88	0.00
26 T	1,4-Dioxane	0.211	0.205	2.8	102	0.01
27 T	cis-1,3-Dichloropropene	0.371	0.352	5.1	98	0.00
28 T	trans-1,3-Dichloropropene	0.315	0.288	8.6	95	0.00
29 T	1,1,2-Trichloroethane	0.229	0.204	10.9	92	0.00
30 S	Toluene-d8 (SS2)	0.971	0.992	-2.2	104	0.00
31 T	Toluene	1.129	1.058	6.3	96	0.00
32 T	1,2-Dibromoethane	0.307	0.269	12.4	91	0.00
33 T	Tetrachloroethene	0.427	0.352	17.6	84	0.00
34 I	Chlorobenzene-d5 (IS3)	1.000	1.000	0.0	89	0.00
35 T	Chlorobenzene	5.512	5.508	0.1	90	0.00
36 T	Ethylbenzene	7.840	8.638	-10.2	100	0.00
37 T	m,p-Xylene	6.155	6.871	-11.6	97	0.00
38 T	o-Xylene	6.773	7.384	-9.0	95	0.00
39 T	1,1,2,2-Tetrachloroethane	3.015	3.231	-7.2	92	0.00
40 S	Bromofluorobenzene (SS3)	3.891	3.706	4.8	83	0.00
41 T	1,3-Dichlorobenzene	4.995	4.741	5.1	83	0.00
42 T	1,4-Dichlorobenzene	5.211	4.777	8.3	84	0.00
43 T	1,2-Dichlorobenzene	4.856	4.606	5.1	83	0.00
44 T	1,2,4-Trichlorobenzene	3.710	3.239	12.7	82	0.00
45 T	Naphthalene	11.050	10.656	3.6	89	0.00
46 T	Hexachlorobutadiene	2.272	2.050	9.8	81	0.00

(#) = Out of Range

SPCC's out = 0 CCC's out = 0

Radon Analysis (EPA Method GS: Grab Sample/Scintillation Cell counting)																		
<b>For GSI</b>																		
Samples Collected by: Lila Beckley										Client Project Number: 3585/3669								
Site: ESTCP VI Study, Raritan NJ										Sample Dates: 3/28/13								
										Sample containers: Tedlar bags								
										Assumed Site Pressure 1.00 atm								
Analysts: Doug Hammond										based on an elevation of 125 ft								
Phone: 310-490-7896										Time Zone adjustment: add to decay time								
email: dhammond@usc.edu										3 hours								
										Collect (EDT)								
										Run (PDT)								
Summary		Collection		Analysis		Vol run		Conc.		±1 sig		Lab Duplicates		Notes				
	Date	time	Date	time	Vol run	Conc.	±1 sig	mean	±1ssd									
		(EDT)		(PDT)	(cc)	pCi/L	pCi/L	pCi/L	pCi/L									
Received 3/29/13																		
1	CP4-AA-BL	3/28/13	8:50	3/29/13	13:10	120	0.03	0.02	0.08	0.07								
	lab dupe	3/28/13	8:50	3/29/13	13:15	60	0.13	0.04										
2	CP4-IA-5-BL	3/28/13	8:45	3/29/13	13:19	120	0.23	0.02										
3	CP4-IA-5-NP	3/28/13	11:05	3/29/13	13:24	65	0.11	0.03										
4	DUP-1	3/28/13	11:05	3/29/13	13:30	120	0.15	0.02										
Uncertainty given in pCi/liter is based on counting statistics for low activity samples. For high activity samples uncertainty is ±5%.																		
The Lower Limit of Detection for Rn (95% confidence level as recommended by EPA 402-R-95-012, Oct. 97) is 0.14 pCi/liter.																		
Results are reported based on standardization with NIST-traceable radon sources.																		
These results are for application of naturally-occurring radon as a tracer of soil vapor intrusion, but are not intended for evaluation of radon hazards.																		
Results corrected to in situ pressure as noted above																		
Raw Data, Calculation factors, and Analytical Details																		
Sample ID	Collection		Analysis		Count in cell/ch	He eff	Air/He eff	Vol run (cc)	Press factor	obs dpm	sig dpm	Decay T (hours)	Decay factor	Concentration		count stats	Notes	
	Date	Time (EDT)	Date	Time (PDT)										dpm/liter	pCi/liter			pCi/liter
Received 3/29/13																		
1	CP4-AA-BL	3/28/13	8:50	3/29/13	13:10	82/32	0.743	0.95	120	1.00	0.01	0.00	31.3	1.267	0.07	0.03	0.02	
	lab dupe	3/28/13	8:50	3/29/13	13:15	76/22	0.912	0.98	60	1.00	0.01	0.00	31.4	1.268	0.28	0.13	0.04	
2	CP4-IA-5-BL	3/28/13	8:45	3/29/13	13:19	81/31	0.818	0.95	120	1.00	0.04	0.00	31.6	1.269	0.50	0.23	0.02	
3	CP4-IA-5-NP	3/28/13	11:05	3/29/13	13:24	84/11	0.785	0.98	65	1.00	0.01	0.00	29.3	1.248	0.25	0.11	0.03	
4	DUP-1	3/28/13	11:05	3/29/13	13:30	83/11	0.806	0.95	120	1.00	0.03	0.00	29.4	1.249	0.34	0.15	0.02	
Decay corrections based on Rn decay constant of				0.1813 per day		Radon Conc = ((0.4504)(1000)(obs dpm)(decay factor)(Press factor))/((cc used)(He eff)(Air/He))												
Conversion from dpm based on				0.4504 pCi/dpm		(in pCi/liter)												
Blanks are negligible.																		
<b>Definitions:</b>																		
Cell/ch:	Counting cell and channel used										sig dpm	uncertainty (± 1 sig) in dpm based on counting statistics						
He eff:	Cell and counter efficiency using helium matrix										Decay T:	time elapsed from sampling to analysis						
Air/He:	Correction for matrix counting gas density										Decay factor:	Correction factor for decay from collection to analysis						
Sample vol:	Volume analyzed (cc)										dpm/liter:	Radon concentration in disintegrations per minute per liter of sample						
Press factor:	Correction to in situ pressure based on collection altitude										pCi/liter:	Radon concentration in pCi/liter						
obs dpm:	observed radon activity (disintegrations per minute) when analyzed										count stats:	uncertainty in observed radon based on counting statistics						





Received by GSI, 3 May 2013

Results of FRAS samples:

SAMPLE ID	C	CI	
209-SG-09	-10.6	3.3	
CP4-IA-3	-31.2		-1.3
CP4-IA-4	-30.9		-0.4
CP4-IA-4B	-30.5		0.1
CP4-SG-6	-5.4	3.4	
MW-136	-22.2	1.5	
MW-139	-16.5	4.6	
MW-156	-25.3	1.9	
MW-CP-IV-1	-20.9	3.1	

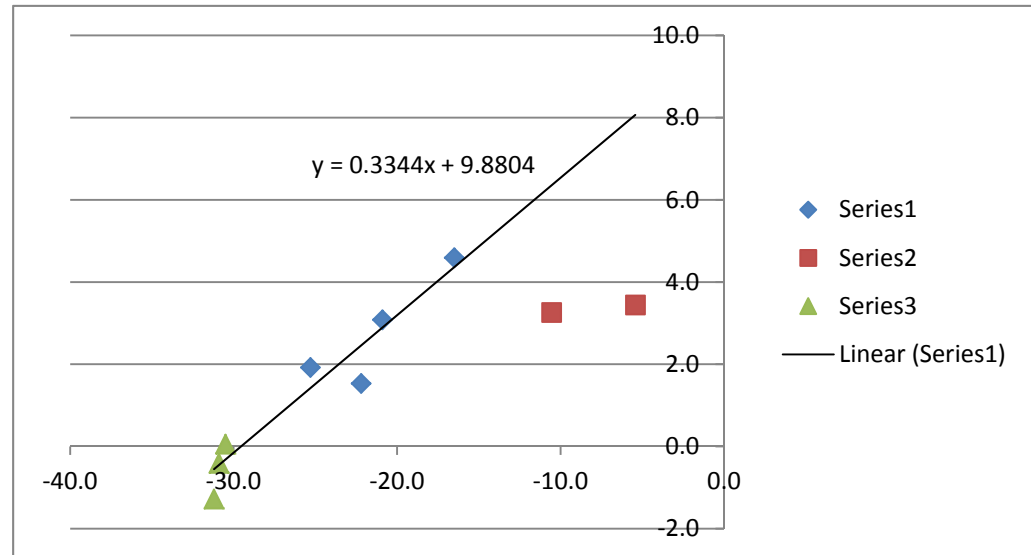

**Notes**

correction [X] accounts for the method bias, based on the external standard runs, see QAQC dat:

"corrected  $\delta = \delta + X$ " should be used to compare data from the present sampling event with those from past or future sampling event date analyzed

RUN #	SAMPLE ID	AIRTUBE #	TCE del VPDB	AVERAGES		
				SAMPLE ID	TCE del VPDB	stdev
9452	209-SG-09	C16_M17715	-10.7	209-SG-09	-10.6	0.2
9476	209-SG-09	C16_J03132	-10.4	CP4-IA-3	-31.2	0.1
				CP4-IA-4	-30.9	
9446	CP4-IA-3	C16_M16576	-31.1	CP4-IA-4B	-30.5	
9456	CP4-IA-3	C16_M17718	-31.3	CP4-SG-6	-5.4	0.4
9447	CP4-IA-4	C16_M17824	-30.9	MW-136	-22.2	
				MW-139	-16.5	0.4
9448	CP4-IA-4B	C16_M17859	-30.5	MW-156	-25.3	0.0
				MW-CP-IV-1	-20.9	
9449	CP4-SG-6	C16_M17758	-5.7			
9461	CP4-SG-6	C16_M17824	-5.8			
9474	CP4-SG-6	C16_M17758	-5.3			
9475	CP4-SG-6	C16_J05145	-4.9			
9444	TCE standard	C16_K08421	-30.0			
9445	TCE standard	C16_J03696	-30.0			
9450	TCE standard	C16_M16542	-30.1			
9451	TCE standard	C16_M17687	-30.1			
9454	TCE standard	C16_M17787	-30.3			
9473	TCE standard	C16_M17715	-30.0			
9477	TCE standard	C16_J07064	-29.7			
9478	TCE standard	C16_M17821	-30.2			

RUN #	SAMPLE ID	volume (ul)	TCE del VPDB
9467	MW-136	12000	-22.2
9465	MW-139	3000	-16.8
9470	MW-139	3000	-16.2
9469	MW-156	450	-25.3
9471	MW-156	450	-25.3
9468	MW-CP-IV-1	25000	-20.9
9462	TCE standard	3	-29.9
9463	TCE standard	3	-30.1
9466	TCE standard	3	-30.3
9472	TCE standard	3	-30.1

**Notes**

correction [X] accounts for the method bias, based on the external standard runs, see QAQC data  
 "corrected  $\delta = \delta + X$ " should be used to compare data from the present sampling event with those from past or future sampling events  
 date analyzed

RUN #	SAMPLE ID	AIRTUBE	TCE deI SMOC	AVERAGES		
				SAMPLE ID	TCE deI SMOC	stdev
3389	209-SG-09	C16_M17789	3.3	209-SG-09	3.3	
				CP4-IA-3	-1.3	0.5
3385	CP4-IA-3	C16_M17784	-1.6	CP4-IA-4	-0.4	
3394	CP4-IA-3	C16_M17825	-0.9	CP4-IA-4B	0.1	0.4
				CP4-SG-6	3.4	
3387	CP4-IA-4	C16_J03738	-0.4			
				MW-136	1.5	0.2
3386	CP4-IA-4B	C16_M17817	-0.2	MW-139	4.6	0.1
3395	CP4-IA-4B	C16_M17687	0.3	MW-156	1.9	0.1
				MW-CP-IV-1	3.1	
3382	CP4-SG-6	C16_M17820	3.4			

RUN #	SAMPLE ID	AIRTUBE	TCE deI SMOC
3379	TCE standard	C16_K08421	2.7
3380	TCE standard	C16_M17787	3.2
3381	TCE standard	C16_J03146	3.2
3384	TCE standard	C16_M17857	3.2
3388	TCE standard	C16_M17722	3.4
3390	TCE standard	C16_J06979	3.3
3391	TCE standard	C16_M17758	3.6
3392	TCE standard	C16_J03116	3.6
3393	TCE standard	C16_K08440	3.5

average	3.3
stdev	0.2
off-line $\delta$ 37Cl of the stand.	3.3
correction (x)	0.0

RUN #	SAMPLE ID	volume (ul)	TCE deI SMOC
3361	MW-136	5000	1.7
3366	MW-136	4250	1.4
3360	MW-139	1850	4.6
3365	MW-139	1900	4.6
3353	MW-156	180	1.8
3359	MW-156	240	2.0
3362	MW-CP-IV-1	20500	3.1

RUN #	SAMPLE ID	TCE deI SMOC
3350	TCE standard	3.6
3354	TCE standard	3.2
3355	TCE standard	3.0
3363	TCE standard	3.0
3364	TCE standard	3.9
3367	TCE standard	3.2

average	3.3
stdev	0.3
off-line $\delta$ 37Cl of the stand.	3.3
correction (x)	0.0

# **Supplemental CSIA Results**

<b>RUN #</b>	<b>SAMPLE ID</b>	<b>TUBE #</b>	<b>date analyzed</b>	<b>bnz (ng)</b>	<b>tce (ng)</b>	<b>pce (ng)</b>
3244	BLANK CLEANED TUBE			0.4	0.0	0.0
3245	BLANK CLEANED TUBE			0.3	0.0	0.0
3246	BLANK CLEANED TUBE			0.3	0.0	0.0
3247	BLANK CLEANED TUBE			0.4	0.0	0.0
3252	613 TRIP BLANK	C16_K08449	Jan-10-2013	0.2	0.0	0.0
3257	613 TRIP BLANK	C16_K08458	Jan-11-2013	0.2	0.0	0.0
3251	631 TRIP BLANK	C16_J03703	Jan-10-2013	0.4	0.1	0.0
3255	631 TRIP BLANK	C16_K08451	Jan-11-2013	1.2	0.2	0.2
3256	631 TRIP BLANK	C16_J03115	Jan-11-2013	0.4	0.0	0.0
3309	677 TRIP BLANK	C16_M16542	Mar-22-2013	0.3	0.0	0.0
3311	677 TRIP BLANK	C16_M17854	Mar-22-2013	0.2	0.0	0.0
3398	687 TRIP BLANK	C16_K08451	Apr-15-2013	0.1	0.1	0.0
3401	687 TRIP BLANK	C16_M17860	Apr-15-2013	0.4	1.3	0.1
3402	687 TRIP BLANK	C16_M16587	Apr-15-2013	0.2	0.2	0.0

OU #712

ER-201025, city gas samples

analyses completed:

C CSIA -- 5/23/2013

Run #	Sample ID	volume (ml)	Split X	benzene $\delta^{13}C$	Sample ID	benzene $\delta^{13}C$	stdev
9577	Houston Natural Gas	2	1 : 9	-22.3	Houston Natural Gas	-22.2	0.1
9578	Houston Natural Gas	2	1 : 4	-22.2	Austin Natural Gas	-22.0	0.3
9580	Houston Natural Gas	2	1 : 3	-22.2			
9583	Austin Natural Gas	2	splitless	-22.2			
9584	Austin Natural Gas	2	splitless	-21.8			

Run #	Sample ID	Split X	benzene $\delta^{13}C$
9575	BZ standard	splitless	-28.1
9576	BZ standard	splitless	-28.0
9581	BZ standard	splitless	-28.1
9582	BZ standard	splitless	-27.9
	average		-28.025
	stdev		0.1
	off-line $\delta^{13}C$ of the stand.		-28.1
	correction (x)		-0.1

OU project #712a

Cleint: GSI, Project ER-201025

Two samples in Summa canisters

Analyzed August 21-22, 2013

<b>Run #</b>	<b>Sample ID</b>	<b><math>\delta^2\text{H}</math></b>
7868	Austin Nat. Gas; 25 ML	-84
7870	Houston Nat. Gas; 20 ML	-80
7871	Houston Nat. Gas; 6 ML	-75
7865	standard	-79
7866	standard	-78
7867	standard	-68
7869	standard	-70
7873	standard	-78
	average	-75
	stdev	5
	off-line $\delta$ of the standard	-75



# **Appendix E: Recommended Protocol**

---

## **Use of On-Site GC/MS Analysis to Distinguish between Vapor Intrusion and Indoor Sources of VOCs**



# **ON-SITE GC/MS ANALYSIS PROTOCOL FOR VAPOR INTRUSION INVESTIGATIONS**

---

**Use of On-Site GC/MS Analysis to Distinguish between  
Vapor Intrusion and Indoor Sources of VOCs**

**ESTCP Project ER-201119**

**Version 2  
November 2013**

**Lila Beckley and Thomas McHugh, GSI Environmental Inc.  
Kyle Gorder and Erik Dettenmaier, Hill AFB  
Ignacio Rivera-Duarte, SSC Pacific**



# Table of Contents

1.0	INTRODUCTION .....	1
2.0	APPLICABILITY .....	1
2.1	Building-Specific Considerations .....	1
2.2	Vapor Intrusion COCs .....	2
2.3	Use of On-Site GC/MS Analysis for Initial Building Investigations .....	2
2.4	Tools for On-site GC/MS Analysis.....	4
3.0	GENERAL INVESTIGATION PROTOCOL.....	4
3.1	Pre-Sampling Activities .....	6
3.2	Analytical Methods.....	7
3.3	Instrument Calibration and QC.....	7
3.4	Building Operating Conditions.....	8
3.5	Sampling Program .....	9
3.6	Building Pressure Control (Optional).....	15
4.0	DOCUMENTATION .....	17
4.1	Field Notes.....	17
4.2	Report.....	18
5.0	HAPSITE USE AND INSTRUCTIONS.....	19
5.1	Customized HAPSITE Analytical Methods .....	19
5.1.1	HAPSITE Quantitative Methods .....	19
5.1.2	HAPSITE Survey Analytical Methods.....	27
5.2	Calibration Procedures for Quantitative Analytical Methods.....	31
5.3	Testing Specific VOC Sources with the HAPSITE and Isolation Device.....	33
5.3.1	Indoor VOC Sources.....	33
5.3.2	Subsurface Source Isolation and Testing.....	35
5.3.3	Estimated Costs.....	37
6.0	REFERENCES .....	38

## TABLES

Table 1: Likelihood of VOC to be a Problematic Indoor Source .....	3
Table 2: Typical Equipment Requirements for On-Site Analysis Procedure.....	7
Table 3: Example Indoor Sources of VOCs .....	11
Table 4: Sensitivity of HAPSITE Quantitative Mode .....	20
Table 5: Target Compounds in the cVOC Method.....	21
Table 6: Target Compounds in the Petroleum VOCs Method.....	24
Table 7: Example Concentrations Utilized in the cVOC and Petroleum VOC Calibration Curves .....	31
Table 8: Estimated Costs for Implementing the On-Site Analysis Protocol at Four Buildings ...	38

## FIGURES

Figure 1: On-Site GC/MS Analysis Building Investigation Process .....	5
Figure 2: Example Initial Sampling Program Results .....	10
Figure 3: Example Second Round Sampling Results .....	10

Figure 4: Testing a Sealed Crack in a Concrete Floor .....	13
Figure 5: VOC Responses to Building Pressure Manipulation .....	16
Figure 6: Initial Temperature Settings in the cVOC Method .....	21
Figure 7: Volume/duration of inlet states, GC temperature profile, and timing of SIM sets in the cVOC Method.....	22
Figure 8: Specific masses and search parameters in each SIM set in the cVOC Method .....	23
Figure 9: Initial Temperature Settings in the Petroleum VOCs Method .....	24
Figure 10: Volume/duration of inlet states, GC temperature profile, and timing of SIM sets in the Petroleum VOCs Method.....	25
Figure 11: Specific masses and search parameters in each SIM set in the Petroleum VOCs Method .....	26
Figure 12: Temperature Settings in the PCE 3-ion Survey Method .....	28
Figure 13: Specific Masses and Search Parameters in the PCE 3-ion Survey Method .....	28
Figure 14: Temperature Settings in the TCE Survey Method .....	29
Figure 15: Specific Masses and Search Parameters in the TCE Survey Method .....	29
Figure 16: Temperature Settings in the Benzene Survey Method .....	30
Figure 17: Specific Masses and Search Parameters in the Benzene Survey Method .....	30
Figure 18: Testing a Potential Indoor VOC Source.....	33
Figure 19: Indoor Source Flux Chamber Construction.....	33
Figure 20: Examples of Vapor Entry Point Isolation and Testing.....	36

## 1.0 INTRODUCTION

This guide provides a standardized protocol for the use of on-site gas chromatography/mass spectrometry (GC/MS) analysis to evaluate the potential for vapor intrusion in a building, including the ability to distinguish between vapor intrusion and indoor or other sources of volatile organic chemicals (VOCs). This vapor intrusion investigation approach provides an alternative to the conventional investigation method of indoor air and sub-slab testing using Summa canisters and off-site laboratory analysis. The protocol was developed and validated as part of Environmental Security Technology Certification Program (ESTCP) Project No. ER-201119 (GSI, 2013).

This investigation protocol relies on use of a commercially-available off the shelf (COTS) field-portable GC/MS instrument and real-time decision making. The use of on-site analysis significantly improves an investigator's ability to distinguish between vapor intrusion and other sources of VOCs detected in indoor air.

This standardized investigation protocol includes:

- Building operating procedures to minimize air mixing prior to sample collection;
- Systematic sample collection and analysis to determine the distribution of VOCs within the building and to identify likely indoor sources of VOCs and/or vapor entry points;
- Procedures to test specific sources and entry points;
- Confirmation sampling following source isolation and/or removal; and
- Optional procedures for additional testing under controlled building pressure conditions to further evaluate VOC sources as well as potential temporal variability in vapor intrusion.

## 2.0 APPLICABILITY

Building-specific investigations of vapor intrusion are typically required when VOCs have been detected above applicable screening concentrations within 30 to 100 feet (ft) of the buildings and the results of subsurface testing (i.e., groundwater and/or soil gas) indicate a potential vapor intrusion concern (USEPA, 2002; ITRC, 2007).

When a building-specific investigation is required, the on-site GC/MS investigation procedure is broadly applicable to a wide variety of building types and constituents of concern (COCs). The investigation procedure can be applied either i) as an **initial investigation tool** at buildings without prior vapor intrusion testing or ii) at buildings where preliminary testing of indoor air has identified VOC concentrations above regulatory screening values and there is some **uncertainty concerning the source of the VOCs**. Specific considerations for the selection of this investigation procedure are discussed in Section 2.1-2.4 below.

### 2.1 Building-Specific Considerations

The use of on-site analysis relies on the difference in COC concentrations within a building in order to identify sources (e.g., vapor entry points or specific products and/or materials within the

building). As a result, the method is most effective in buildings comprised of discrete spaces (i.e., rooms). However, even in buildings that consist of large, open spaces (e.g., warehouses), the concentration gradients observed within the building are commonly large enough so that the source can be identified. The effectiveness of the method is improved when mixing of air within the building can be minimized (i.e., doors closed and heating, ventilation and air conditioning (HVAC) system turned off).

## 2.2 Vapor Intrusion COCs

On-site GC/MS analysis is most effective for the identification of sources of chlorinated VOCs (cVOCs). Indoor sources of cVOCs typically contain high concentrations of one or two individual chlorinated compounds (i.e., strong sources). Additionally, an individual building typically contains only a small number of sources. These sources (e.g., tube of glue) cannot often be identified by standard methods (e.g., visual inspection), but can usually be identified based on the observed distribution of cVOCs within the building.

In contrast to cVOCs, petroleum VOCs typically occur in complex mixtures where the risk drivers (e.g., benzene and ethylbenzene) are present only in low concentrations (i.e., weak sources). Buildings may contain a large number of these indoor sources of petroleum VOCs resulting in a distribution within the building that makes it difficult to identify all of the individual sources. On-site analysis can be used to identify strong indoor sources of petroleum VOCs or significant vapor entry points. However, for petroleum VOCs, the method has a greater potential to yield equivocal results. Because petroleum VOCs are found in a wide range of consumer products, the background level is also likely to be higher, making it more difficult to isolate weak or moderate sources.

## 2.3 Use of On-Site GC/MS Analysis for Initial Building Investigations

As indicated above, on-site GC/MS analysis may be used i) for **initial building investigations** or ii) at buildings where preliminary testing of indoor air has identified VOC concentrations above regulatory screening values, and there is some **uncertainty concerning the source of the VOCs**. The presence of the three site conditions discussed below would favor the use of this method as an initial investigation tool. However, other factors are also likely to be important at some sites. The decision of whether to use on-site analysis for initial investigation or follow-up will inevitably involve professional judgment.

- **Likely Indoor Source of Target VOCs:** The prevalence of indoor sources varies significantly for different chlorinated VOCs. For example, tetrachloroethylene (PCE) is used in a wide variety of consumer products including hobby craft glues, oven cleaner, silver polish, water-proofing spray, lubricant spray, and other products. 1,2-dichloroethane (1,2-DCA) is commonly emitted from plastic decorations present in most houses (Doucette et al., 2010). Trichloroethylene (TCE) is less common but is found in gun cleaner, “industrial strength” cleaner, self-defense “pepper” spray, and other products. In contrast, cis-1,2-dichloroethene (cis-1,2-DCE), 1,1-dichloroethene (1,1-DCE), and vinyl chloride (VC) are rarely present in consumer products, although low concentrations of some of these VOCs can be generated by the reaction of bleach with other organic materials in bleach cleaners (Odabasi, 2008). The relative potential for

indoor sources of various VOCs to result in exceedances of indoor air screening concentrations is illustrated in Table 1.

**Table 1: Likelihood of VOC to be a Problematic Indoor Source**

 <p><b>Higher</b></p>	Benzene, 1,2-DCA (EDC), Naphthalene
	Ethylbenzene, Carbon Tetrachloride, Chloroform
	PCE
	TCE, trans-1,2-DCE
	Toluene, Xylenes, 1,1,1-TCA
	<b>Lower</b>

Note: “Problematic” source based on potential for indoor source to result in an exceedance of the indoor air screening value. Although toluene and xylene are commonly detected in indoor air, the concentrations are typically well below the indoor air screening value. The analysis is qualitative and is based on field experience and comparison of typical background range from literature (e.g., Dawson and McAlary, 2009) to indoor air screening values (USEPA, 2013). See Gorder and Dettenmaier, 2011, for information on indoor sources of trans-1,2-DCE. Although benzene, ethylbenzene, and naphthalene commonly have problematic indoor sources, the on-site analysis method may be less effective for these constituents (see Section 2.2). Carbon tetrachloride can be an ingredient in adhesives. However, carbon tetrachloride and chloroform are also associated with household cleaning products containing chlorine bleach (Odabasi, 2008).

If the VOCs for the vapor intrusion investigation include one or more VOCs where indoor sources are likely to result in exceedances of the applicable indoor screening concentrations, then on-site analysis is favored due to its ability to identify indoor sources which can then be removed prior to collection of indoor air samples for vapor intrusion decision-making.

- **High Stakeholder Concern:** At sites with high stakeholder concern regarding vapor intrusion, the investigation results are usually interpreted with a higher level of conservatism. For example, at sites with high concern, a foundation attenuation factor of 0.1 to 1 may be used for evaluation of sub-slab samples rather than the more common range of 0.01 to 0.1. Alternatively, multiple rounds of conventional testing may be required to evaluate potential temporal variability in vapor intrusion. High stakeholder concern favors the use of the on-site analysis method because a highly conservative evaluation of the results from conventional testing is more likely to yield inconclusive results.
- **Need for Rapid Source Identification and Mitigation:** For some buildings (e.g., schools), the identification of VOCs in indoor air at concentrations above screening levels could cause an immediate concern. The on-site analysis method allows the identification and removal of indoor sources during the initial testing. In cases of vapor intrusion, the

method allows the identification of specific vapor entry points or areas which may allow immediate measures to reduce vapor intrusion. The need for rapid mitigation of indoor air exceedances favors the use of the on-site analysis method. In the event that immediate measures must be taken, the on-site analysis method also allows the user to quickly evaluate whether these measures are improving indoor air quality.

If conventional testing is used for the initial building-specific vapor intrusion investigation, then the on-site analysis method may be used for follow-up testing at buildings where the conventional program did not yield definitive results.

## **2.4 Tools for On-site GC/MS Analysis**

This investigation protocol requires a field-portable instrument that provides i) sufficient compound specificity and sensitivity to measure VOCs in indoor air at levels of regulatory concern (i.e.,  $<1 \text{ ug/m}^3$  for cVOCs, and  $<5 \text{ ug/m}^3$  for petroleum VOCs), with ii) sufficient precision to measure concentration gradients within a building. The general investigation procedures (Section 3.0) can be implemented using any field-portable instrument meeting these requirements.

This investigation protocol was developed using the Smart Plus model of the HAPSITE GC/MS as the on-site analysis tool. Additional information specific to the HAPSITE is provided in Section 5.0. This information includes analytical method specifications, calibration procedures, and costs.

## **3.0 GENERAL INVESTIGATION PROTOCOL**

The investigation protocol for use of on-site GC/MS analysis for the evaluation of vapor intrusion is illustrated in Figure 1.



**Figure 1: On-Site GC/MS Analysis Building Investigation Process**

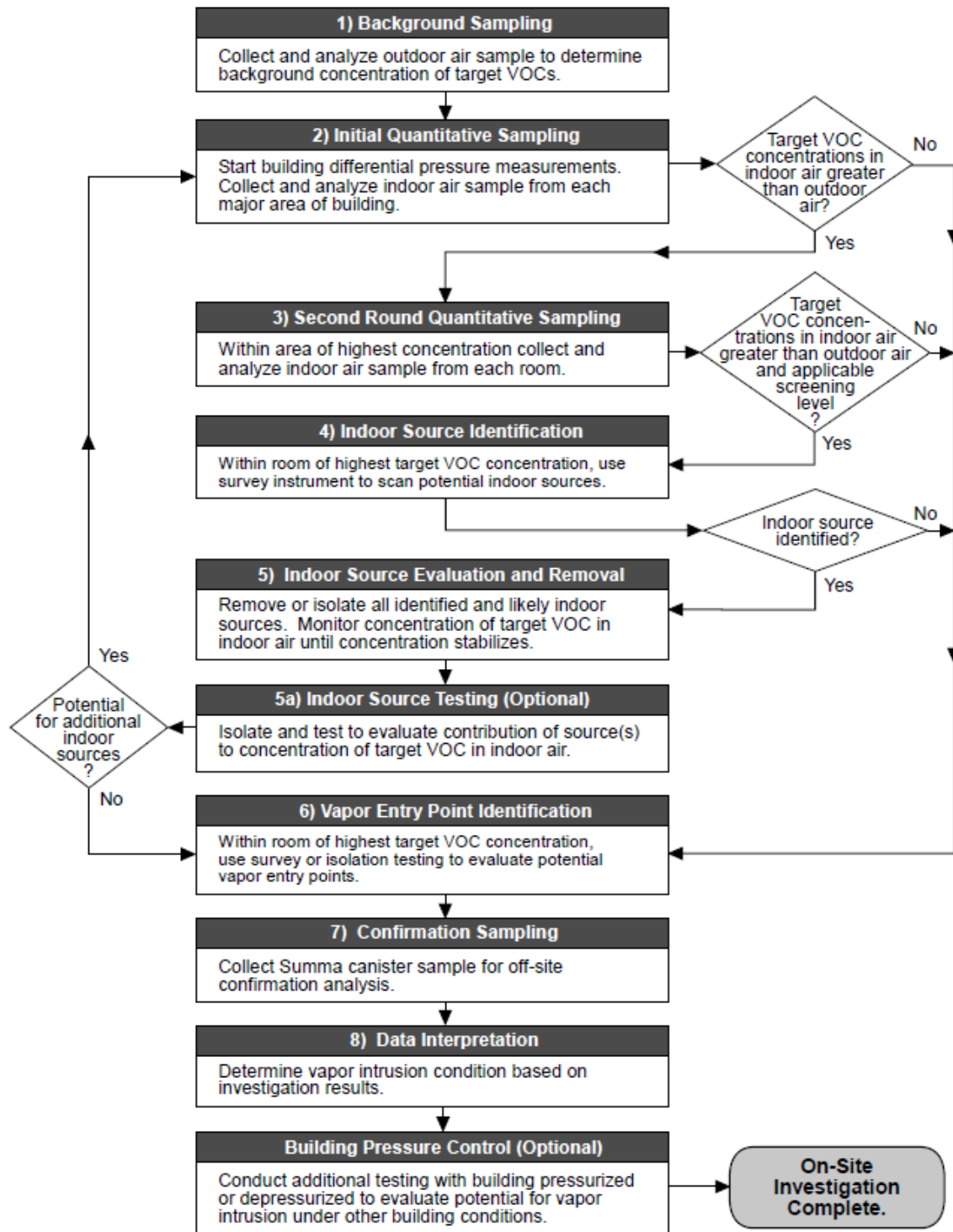

Notes: 1) QA steps are not shown in the flowchart. 2) The last step of the process (on-site investigation complete) refers to the field investigation program. Preliminary interpretations regarding vapor intrusion can be made based on on-site results. Additional investigation of the building may or may not be required, depending on final evaluation of the results including results from confirmation samples (collected in Step 7) analyzed by an off-site laboratory. 3) The flow chart illustrates the recommended investigation process. Deviations from the process may be warranted based on site-specific factors.

### 3.1 Pre-Sampling Activities

The technical team should determine the activities to be completed prior to mobilization. These pre-sampling activities include:

- 1) **Identify specific structures for sampling:** Select specific structures based on factors such as the distance from and nature of the potential subsurface source.
- 2) **Determine target VOCs for on-site analysis:** Identify the VOCs to be included in the on-site investigation program. The target VOCs should be the one or two vapor intrusion COCs of greatest concern based on consideration of subsurface concentrations and indoor air screening concentrations. Additionally, consider the sensitivity of the on-site analysis tool relative to the desired screening level.

Note that buildings may contain a large number of the indoor sources of petroleum VOCs resulting in a distribution of petroleum VOCs within the building that makes it difficult to identify all of the individual sources. On-site analysis can be used to identify strong indoor sources of petroleum VOCs or significant vapor entry points. However, for petroleum VOCs, the method has a greater potential to yield equivocal results.

- 3) **Obtain necessary equipment:** Equipment typically required to implement the on-site analysis procedure is listed in Table 2 below. The list should be modified to reflect site-specific requirements. At a minimum, the procedure requires a HAPSITE or other instrument for quantitative on-site analysis and chemical-specific qualitative analysis. The user should confirm that analytical methods are available and appropriate for the target VOCs identified in Item 2 above.

Additional equipment is required for other procedures such as product/vapor entry point isolation testing and building depressurization.

- 4) **Building access:** Request permission to access the building, determine an acceptable schedule, describe the procedure to building owner/operator, and inform the owner/occupant how and when they may be able to obtain the results. The building owner/operator may also be able to provide information on the building history, use, and chemical storage for general context prior to the investigation. Occupants should be asked to avoid use of materials containing target VOCs prior to testing.

**Table 2: Typical Equipment Requirements for On-Site Analysis Procedure**

<b>Program</b>	<b>Equipment/Supplies</b>
On-site GC/MS Analysis	<u>Quantitative Analysis</u> : Inficon HAPSITE portable GC/MS or equivalent quantitative instrument, and related supplies <u>Survey Mode</u> : Inficon HAPSITE MS survey mode or equivalent continuous-read instrument, and related supplies
Confirmation Sampling	Certified clean, evacuated Summa canisters for indoor confirmation sampling, and related supplies
Product/Vapor Entry Point Isolation Testing (Optional)	Container for testing potential indoor VOC sources (see Section 5.3.1). Container or plastic sheeting for testing potential vapor entry points (see Section 5.3.2). Related supplies (e.g., 3-way valves, tubing, tape [e.g., painters tape])
Building Depressurization (Optional)	Box or floor fan(s), depending on building size
	Related supplies (e.g., plastic sheeting, tape)
	Pressure transducer, and related supplies

### 3.2 Analytical Methods

Analytical methods for the on-site analysis should be prepared and tested prior to mobilization. HAPSITE method descriptions are provided in Section 5.1, for reference.

Quantitative Analytical Methods: The on-site instrument should use a quantitative analytical method that detects and quantifies the target VOCs. If possible, the analytical method should have a sensitivity below the applicable indoor air screening concentration for the target VOCs. However, because the VOC concentrations are higher in close proximity to the source (either an indoor source or a vapor entry point), a sensitivity that is 2-3 times above the screening level should be sufficient for the identification of sources causing an exceedance of the screening level within the bulk indoor air.

Qualitative Analytical Methods: The instrument used for continuous-reading qualitative analysis should use a method or methods that provide a compound-specific response for the target VOCs.

### 3.3 Instrument Calibration and QC

This protocol uses the on-site results primarily for source identification (i.e., vapor intrusion vs. indoor source) and uses the confirmation results from the off-site lab as the primary data for

comparison of VOC concentrations in indoor air to regulatory screening values. As a result, there are fewer QA requirements than would be needed if the on-site results were being used for definitive decision-making. Note that, although the on-site instrument's analytical methods may include several VOCs, the QA requirements apply to the 1-2 target VOCs identified for the site (see Section 3.1).

Prior to on-site use, startup protocols recommended by the GC/MS instrument manufacturer should be followed. These include automated self-checks and instrument tuning. In addition, continuing calibration verification (CCV) analyses are recommended each day prior to on-site use. If the results of the CCV analyses demonstrate an error greater than the acceptable limit previously established by the operator, the instrument should be recalibrated. Calibration curves should be developed using a standard gas mixture containing known concentrations of the target VOCs. The standard gas is diluted with nitrogen gas or blank air to create a series of samples with known concentrations that span the range of typical indoor air VOC concentrations (e.g., 0 to 10 ppbV). The calibration curve is fit to the results from these samples, and the fit is checked to determine whether the calibration is acceptable.

The quality of each calibration curve is assessed by examining the relative standard deviation (RSD), which is a measure of the linearity of calibration curve, and the Response Factor, which is a measure of the relative response (ion count) of a compound compared to that of an internal standard. For use in the protocol, the curve is acceptable if the RSD is less than 20% and the RSD of the Response Factor is less than 30%. An  $R^2$  criteria ( $\geq 0.98$ ) can also be used to evaluate the quality of the calibration curve (see Section 5.2).

After recalibration, a standard sample (i.e., CCV sample) should be analyzed to further confirm the instrument response. Other quality control samples include method blanks (i.e., samples consisting of nitrogen or blank air).

During the course of the field investigation, field duplicates can be collected to confirm that the on-site GC/MS instrument is operating correctly. This can be done on a prescribed basis (i.e., 1 duplicate for every 20 samples). However, note that an optional part of the protocol involves sampling during a period when the building pressure is intentionally manipulated. Because VOC concentrations can change quickly during pressure manipulation, it is not recommended that duplicates be analyzed while this part of the test is being conducted.

After completion of the day's work, additional CCV and blank samples should be run to confirm the results and determine the degree to which the instrument maintained calibration during the course of the day.

### **3.4 Building Operating Conditions**

The on-site investigation procedure relies on differences in VOC concentrations within the building to locate sources (either indoor sources or vapor entry points). As a result, the building operating conditions should minimize the mixing of indoor air prior to and during the investigation program. This serves to maximize the differences in VOC concentrations within the buildings with the highest concentrations occurring in the areas of indoor sources or vapor entry points. The desired operating procedures include:

- Doors and Windows: Interior and exterior doors and windows should be kept closed to the extent possible. Both interior and exterior doors may be opened during the investigation to allow ingress and egress of investigators and other building occupants. However, the doors should be closed when not in use.
- HVAC System: The HVAC system (including the circulating fan) may need to be turned off. Air circulation within the building should be minimized, but the baseline building pressure should be considered before making the decision to turn off the HVAC system.
- Other Fans: Any other fans that circulate air through the building or within individual rooms should be turned off.

The pressure difference between indoors and outdoors should be measured at the beginning of the investigation. If the building is depressurized under normal operating conditions, consider not changing these conditions right away (i.e., by manipulating the HVAC system), and proceeding with the baseline sampling. Note that depressurized building conditions are conducive to vapor intrusion. Artificially pressurizing a building during the baseline sampling may result in reduced VOC concentrations, and may make subsequent sample results more difficult to interpret.

Procedures used during the investigation should be implemented to the extent practicable without compromising safe building conditions. Building occupants may remain in the building during the investigation and normal building activities can continue.

### 3.5 Sampling Program

The sampling program involves an iterative procedure to find and evaluate VOC sources. This program includes: i) initial quantitative sampling, ii) second round quantitative sampling, iii) qualitative screening for source identification, and iv) source evaluation. If one or more sources are identified and removed or isolated, then the process may need to be repeated (see Figure 1).

- 1) Background (Outdoor Air) Sampling: In order to define the ambient (outdoor) concentration of the target VOCs, collect and analyze an outdoor air sample upwind of the building.
- 2) Initial Quantitative Sampling: The initial sampling and analysis program is conducted using the on-site GC/MS instrument. A sample for quantitative analysis should be collected from each major space within the building, for example, from the basement, main floor, and second floor of a residence (see Figure 2). Additional samples may be collected from likely source areas such as an attached garage.

If the concentration of target VOCs in all areas is less than or equal to the outdoor air concentration, then this portion of the investigation is complete; there is no evidence of current vapor intrusion. If desired, the potential for vapor intrusion under other building conditions can be evaluated by i) screening potential vapor entry points (see Step 6, below) and/or ii) using building depressurization to create conditions favorable for vapor intrusion (See Section 3.6). If

the concentration of target VOCs in one or more areas is greater than the outdoor air concentration, then proceed to Step 3.

**Figure 2: Example Initial Sampling Program Results**

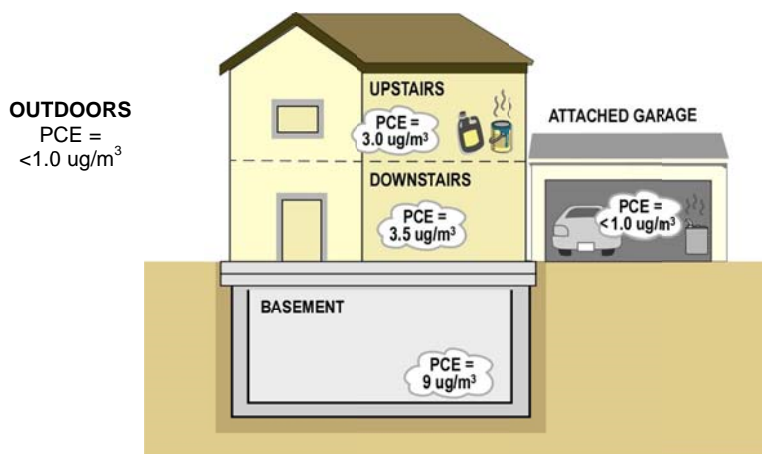

3) Second Round Quantitative Sampling: Additional quantitative samples are collected from within the area found to contain the highest concentrations of the target VOCs. A sample should be collected from the room or other discrete space within the area with highest target VOC concentration identified from the first round (see Figure 3). For example, if the VOC concentrations from the first round were highest in the basement, each room in the basement would be sampled in the second round. In order to minimize air exchange within the building and to decrease the invasiveness of the investigation program, samples can be collected from individual rooms by inserting a sample collection tube under the closed door of the room.

**Figure 3: Example Second Round Sampling Results**

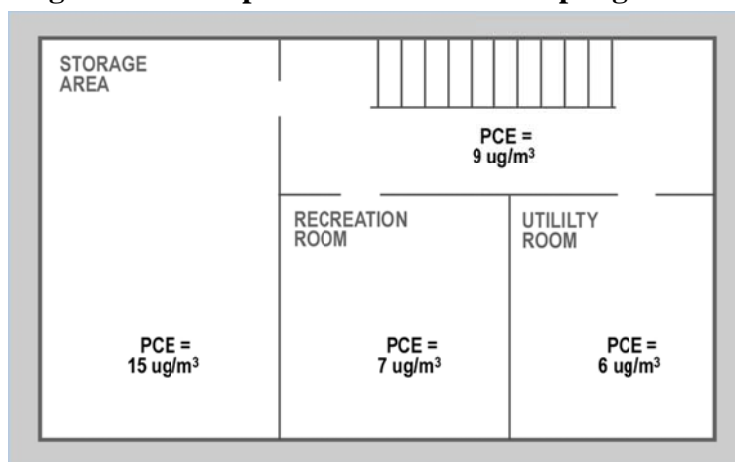

If, based on this additional testing, the concentration of target VOCs in all areas are consistent with the outdoor air concentration or are below indoor screening concentrations, then this portion

of the investigation is complete; there is no evidence of current vapor intrusion. If desired, the potential for vapor intrusion under other building conditions can be evaluated by i) screening potential vapor entry points (see Step 6) and/or ii) using building depressurization to create conditions favorable for vapor intrusion (See Section 3.5). If the concentration of target VOCs in one or more locations is greater than the outdoor air concentration, then proceed to Step 4.

4) **Indoor Source Identification:** Consumer products and household items are commonly found to be significant sources of VOCs in indoor air (See Table 3). Some products contain significant amounts of VOCs not identified on the ingredient label.

**Table 3: Example Indoor Sources of VOCs**

Chemical <sup>1</sup>	General Categories	Examples of Brand Name Products containing Chemical <sup>2</sup>
Benzene	Motor vehicle exhaust, tobacco smoke	ExxonMobil Unleaded Automotive Gasoline, Classic Aerosol Wax
1,2-DCA	Molded plastic products, air freshener	Bravo Platinum Series Metered Air Freshener, Time Mist Fragrance of the Islands
Naphthalene	Insect repellent, diaper pail and toilet deodorizer	STP Auto Products, Enoz Moth Balls and Flakes
Ethylbenzene	Some paints	Many Sherwin Williams and Krylon Paint products
Carbon Tetrachloride	Aerosol cans, refrigerants, dry cleaned clothes, varnish	Radio Shack Plastic Bonder, Radio Shack Anti Static Foaming Cleaner
Chloroform	Dry cleaned clothes, fire extinguishers, adhesive remover, chlorinated drinking water	Time Mist Air Freshener, Evercare Glass Wipes
PCE	Dry cleaned clothes, automotive brake cleaners, metal degreasers, hobby craft glue	Plumbers Goop Adhesive and Sealant, Lectra Motive Auto Care, Sprayway Cleaners and Fabric Protector
TCE	Self-defense pepper spray, degreaser, rug-cleaners	Sprayway Cleaners and Degreasers, Lectra Clean, Trouble Free Rust Buster
Trans-1,2-DCE	Taxidermy foam, refrigerants, cleaning solutions	3M Novec 71DE Engineered Fluid
Toluene	Some paints and adhesives	SprayPAK Enamel, Minwax Wood Finish
Xylenes	Adhesives, paints, gasoline	Bonide Tree Sprays and Insecticides
1,1,1-TCA	Cleaners, adhesive, aerosol cans	Evercare Glass Wipes

Notes: 1) Data sources: U.S. Department of Health and Human Services. Household Products Database. 2012. Available at <http://hpd.nlm.nih.gov/index.htm>. Accessed 1/23/2012; Gorder and Dettenmaier, 2011. 2) Partial list; many other products may contain VOCs.

The indoor source identification procedure involves using a combination of i) continuous-read qualitative analysis with the on-site instrument, ii) visual inspection, and iii) isolation and further testing of potential sources (see Section 5.3).

When using the HAPSITE, source identification includes real-time screening of potential sources using a continuous reading mode. The HAPSITE provides a real-time chemical-specific semi-

quantitative response. In continuous-reading mode, the instrument intake port is used to scan potential sources for the specific target analyte. When using a mobile laboratory for GC/MS analyses, this step involves a real-time screening using an alternate instrument such as a PID with ppb-level sensitivity. When conducting real-time screening with a PID or other instrument that does not provide a chemical-specific response, additional investigation will be required to confirm that responses are associated with the target VOC rather than a non-target VOC. This confirmation may include identification of the target VOC on the product label and/or flux or emission testing (Step 5; see also Section 5.3). An alternative to this testing is to remove the potential VOC source and re-sample the indoor air to see if the concentrations change.

Using the real-time screening instrument, scan storage units (e.g., cabinets, closets, storage containers, etc.) and product containers found in the room(s) with the highest concentration of the target VOCs. If an instrument response is observed for a storage unit, screen individual items and containers within the unit. Also examine the product labels to see if the target VOC is identified on the label.

If one or more items are identified as potential indoor sources, then proceed to Step 5. Otherwise, proceed to Step 6.

**5) Indoor Source Evaluation and Removal:** All potential indoor sources should be removed from the building, if possible. If removal is not possible, then the sources should be isolated to the extent possible by placement in a tight container or covering with plastic. Many plastics are permeable to VOCs, so isolation may only serve to temporarily reduce the release from the source. Following source removal, indoor air concentrations should be measured to observe any changes in target VOC concentrations (e.g., every 10 to 15 minutes at the beginning, then less often thereafter [every 15 to 30 minutes until concentrations stabilize]). Three building air exchanges are typically needed for the VOC concentration in indoor air to attain a new steady-state concentration following source removal. This would require three hours or less for a building with 24 or more air exchanges per day (common for commercial/industrial buildings), but could require 12 hours for a building with 6 air exchanges per day (low end for an energy efficient residential building).

Optionally, the target VOC emission rate from the indoor source(s) can be measured in order to determine if the identified source(s) are likely the primary source(s) of target VOCs in indoor air. The testing procedure is provided in Section 5.3.

Following the removal of identified indoor sources, if the concentrations of target VOCs in all areas are consistent with the outdoor air concentration or are below indoor screening concentrations, then this portion of the investigation is complete; there is no evidence of current vapor intrusion. If desired, the potential for vapor intrusion under other building conditions can be evaluated by i) screening potential vapor entry points (see Step 6, below) and/or ii) using building depressurization to create conditions favorable for vapor intrusion (See Section 3.6). If the concentration of target VOCs in one or more locations is greater than the outdoor air concentration, then either i) repeat Steps 2 to 5 if additional indoor sources are suspected or ii) proceed to Step 6 if vapor intrusion is suspected.



6) Vapor Entry Point Identification: Using the continuous-read survey instrument, scan potential vapor entry points such as floor drains, expansion joints, plumbing penetrations, or cracks. Potential entry points can also be covered with plastic (Figure 4; see also Section 5.3) or with a metal isolation device and the air in the space can be sampled quantitatively. Use of plastic to isolate the crack is acceptable, but a metal device is more reliable because VOCs can diffuse through plastic. Electrical outlets or wall cracks can be screened to check for elevated concentrations of target VOCs in the wall space.

**Figure 4: Testing a Sealed Crack in a Concrete Floor**



Advection is the most common vapor entry mechanism. Less commonly, diffusion through the concrete floor can occur. Diffusion through a concrete (or dirt) floor can be tested by sealing a section of floor under plastic sheeting or a metal device and sampling the trapped air (see Section 5.3.2).

7) Confirmation Sampling: At the end of the baseline on-site investigation program (i.e., before manipulating building pressure conditions), a confirmation sample should be collected to verify the accuracy of the on-site analysis. If one or more indoor sources were removed during the investigation, the confirmation sample should be collected after the concentration of the target VOC has decreased and stabilized following source removal. One confirmation Summa sample should be collected from the room with the highest concentration of target VOC at that time. The confirmation sample may be a grab sample, an 8-hr sample, or a 24-hr sample, depending on regulatory requirements and other project considerations.

8) Data Interpretation: Data interpretation answers two primary questions: i) what is the source of the target VOC (i.e., vapor intrusion vs. indoor or ambient source), and ii) are VOC concentrations above applicable indoor air screening values.

Source Identification: At the end of the baseline characterization (and after concentrations have stabilized after indoor source removal), the investigators make a preliminary interpretation of the source of VOCs using the following guidelines:

1. Comparison of target VOC concentrations in indoor air to ambient (outdoor) air: Do indoor concentrations of the key VOC exceed outdoor concentrations? A “Yes” response is evidence of either vapor intrusion or an indoor source of the target VOC.

2. Baseline building pressure: Is baseline building pressure negative (i.e., less than ambient [outdoor] pressure)? A “No” provides evidence of an indoor source because a positive building pressure does not support the flow of soil gas into the building. A “Yes” response is potentially consistent with vapor intrusion. However, this line of evidence is not definitive with respect to vapor intrusion because negative building pressure does not eliminate the possibility of an indoor source.
3. Remaining indoor sources: Were any known or discovered indoor sources of target VOCs removed prior to the end of the baseline period such that no (known) indoor sources remain in the building? If no known indoor sources remain in the building then target VOC concentrations above ambient concentrations is consistent with vapor intrusion. If known indoor sources remain, and these indoor sources may be the primary source(s) of VOCs in indoor air. This question does not apply if the on-site results for the target VOC are below detection limits or equal to ambient concentrations.
4. Vapor entry point: Were vapor entry points found? If “Yes”, then vapor intrusion could contribute to target VOCs in indoor air. However, if VOC concentrations at the identified entry points are only modestly above indoor air concentrations, then it is possible that indoor sources are also contributing.

These lines of evidence and any other relevant information are considered together to determine the source of the target VOC and the level of confidence in the source determination.

Exposure Concentration: Within the context of a regulatory response action, the determination of whether or not target VOC concentrations exceed an applicable screening level typically requires the use of concentration data that meet defined data quality standards. Therefore, the confirmation results from an analytical laboratory should be used for comparison with regulatory criteria. Many regulatory guidance documents recommend the use of 8 hr or 24 hr samples for the evaluation of exposure concentrations; however, the grab confirmation samples should be suitable for making a preliminary estimate of the exposure concentration. Due to concerns regarding temporal variability in vapor intrusion, some regulators require more than one indoor air sampling event regardless of whether the sample duration is grab, 8 hr, or 24 hr. Additional measures to address temporal variability are discussed in Section 3.6 below.

Although the QA documentation for the on-site results may not support their use for definitive decision-making, the result will provide supporting evidence regarding the exposure concentration by serving to document the spatial and short-term temporal variability within the building.

Note that, while sufficient QA/QC steps *can* be taken to support on-site analysis for definitive decision-making, it may not be practical to do in the field. Additionally, the power of the on-site analysis protocol is rooted in high precision of the instrument which allows the user measure relative concentration differences in a building. These differences are used locate sources of VOCs during building characterization. As the protocol is designed, instrument accuracy and developing “definitive” data using the on-site instrument (e.g., HAPSITE) are less important.

### 3.6 Building Pressure Control (Optional)

#### Basis for Pressure Control Lines of Evidence

Changes in building pressure relative to the subsurface can cause temporal variations in vapor intrusion. As a result, a one-day investigation program with uncontrolled building conditions may not identify vapor intrusion that could occur under other building pressure conditions.

Building pressure control can be used as a tool to control the advective flow of soil gas into the building. If advection (rather than diffusion) is the primary mode of vapor intrusion for a building, then building pressure control can be used to provide an improved understanding of the potential for vapor intrusion under other building operating conditions (McHugh et al., 2012, USEPA, 2011). If VOC concentrations in indoor air are below screening levels under both baseline (uncontrolled) conditions and depressurized conditions, then this provides strong evidence that vapor intrusion is not a concern. If VOC concentrations in indoor air are below screening levels under baseline (uncontrolled) conditions but above screening levels under depressurized conditions, then additional evaluation may be required to determine if temporally-variable unacceptable vapor intrusion may occur under realistic building operating conditions.

Lines of evidence for the optional pressure control evaluation focus on change in target VOC concentrations relative to baseline, and relative to the building pressure condition.

1. Building pressurization: Are target VOC concentrations suppressed by building pressurization? A “Yes” response is consistent with VI.
2. Building depressurization: Are target VOC concentrations enhanced by depressurization? A “Yes” response is consistent with VI.

A positive pressure cycle followed by a negative pressure cycle provides information concerning the source of the target analyte in indoor air (i.e., subsurface source vs. indoor source). If the target analyte concentration is similar under positive and negative pressure (or concentrations decline), an indoor source is indicated. If the target analyte concentration is higher under the negative pressure condition, a subsurface source is indicated.

Note that VOC concentrations in indoor air are likely to decrease somewhat even for VOCs from indoor sources due to the increase in air exchange rate caused by the building pressure control. As a result, the overall interpretation of the building pressure control results depends on the combined responses to building pressurization and depressurization. A decrease in target VOC concentration with building pressurization followed by a rebound with building depressurization is strong evidence of vapor intrusion (Figure 5, middle). A modest decrease in VOC concentration with building pressurization that persists during building depressurization is strong evidence of an indoor source (Figure 5, bottom).

**Figure 5: VOC Responses to Building Pressure Manipulation**

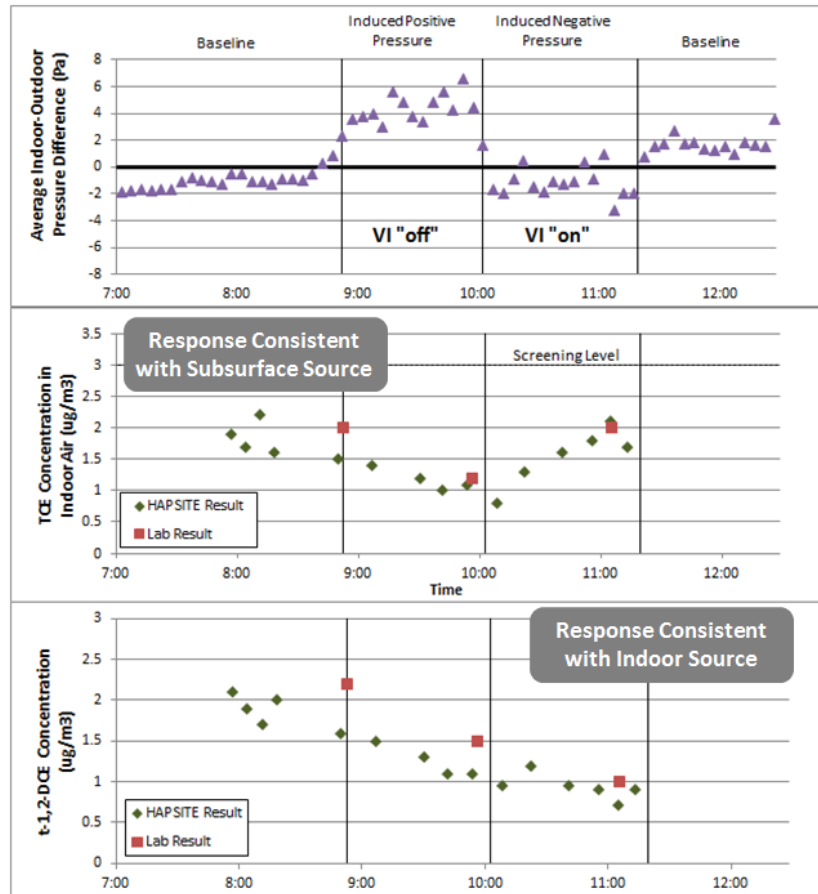

### Pressure Control Procedure

If the target analyte concentration is below the screening level under baseline conditions, then after collecting the baseline samples, negative pressure can be induced in the building by installing a fan in a window or doorway to pull air from inside the building and direct it outside. A differential pressure transducer is used to measure and record the difference between indoors and outdoors and the fan should be set at a speed that maintains at least 1 Pa negative pressure (i.e., vacuum) relative to the outdoors.

After the depressurized condition is initiated, the concentration of target VOCs in indoor air should be measured to observe any changes in target VOC concentrations (e.g., every 10 to 15 minutes at the beginning, then less often thereafter (every 15 to 30 minutes) until concentrations stabilize). Concentrations of target VOCs tend to respond quickly to changes in building pressure. Using on-site analysis, the impact of pressure control is often clear within one hour allowing for pressurization and depressurization to be completed in approximately two hours. When concentration changes are small or higher than usual variability is observed, longer times

may be required to obtain clear results. Note, however, that for cases where the instrument sensitivity is higher than the applicable indoor air screening level, the instrument may not be able to detect an increase in vapor intrusion through testing of bulk indoor air.

During each pressurization phase, the HAPSITE portable GC/MS, or equivalent, is moved throughout the building, area by area. Indoor air sampling and vapor entry point screening (i.e., Steps 2, 3, and 6 from Section 3.5) should be repeated. Periodic samples are collected from each area of the building until one of the following conditions is observed:

1. The indoor air concentration of the target analyte changes and then stabilizes.
2. No concentration changes are observed (minimum 1 hour observation time).

As with the baseline sampling (Section 3.5, Step 7), a confirmation sample for off-site VOC analysis should be collected at the end of each pressure cycle. If building pressure manipulation is planned, radon samples can optionally be collected at the end of the baseline and pressure cycles. Radon is used as a subsurface tracer. A radon concentration is higher under the negative pressure condition can confirm upward soil gas flow from the subsurface into the building.

Within the context of a regulatory response action, the determination of whether or not target VOC concentrations exceed an applicable screening level typically requires the use of concentration data that meet defined data quality standards. Therefore, the confirmation results from the analytical laboratory should be included in the final data interpretations and used for comparison with regulatory criteria.

## **4.0 DOCUMENTATION**

The results of the on-site analysis program should be documented through field notes and a report that presents the analytical results, interpretation, and overall findings.

### **4.1 Field Notes**

Much of the information to record in field notes is typical of any investigation program (i.e., dates, times, activities, locations, and personnel). Additional information pertinent to the on-site program includes, but is not limited to:

- On-site instrument type, manufacturer, model
- Calibration gas specifications, if applicable
- QA/QC measures
- GC/MS instrument settings (e.g., temperature and other settings, identifying ions for target compounds, predicted elution time as indicated in field notes or instrument reports)
- Detailed sampling location descriptions, including observations of storage conditions in the area/room being sampled
- Detailed descriptions of indoor sources identified (product type, brand name, ingredients listed on labels). Note that the amount of information recorded may be limited by the time allotted for the investigation and the size and contents of the building.

- Photographs. Photographs of specific indoor VOC sources, product labels, and storage areas can be helpful. Photographs of each on-site sampling location are also helpful. The field team, however, should be mindful of privacy or similar concerns.

## 4.2 Report

The investigation report documenting use of on-site analysis should include the following:

- **Introduction:** Identify the purpose and context of the investigation program. Provide a description of the site and building(s). Discuss the scope of the investigation. For example, evaluation of current vapor intrusion (baseline sampling) or current and potential vapor intrusion (baseline plus building depressurization).
- **Methods:** Describe the GC/MS instrument and functions utilized during the investigation (e.g., quantitative sampling, qualitative/survey); describe the investigation process. Instrument calibration and QA procedures and results should be documented in an appendix.
- **Results:** Tabulate all quantitative results from the on-site analysis. Sample locations should be summarized on a map. Tabulate results for confirmation samples analyzed off-site. Provide a summary of survey mode results that identifies the rooms or areas included in the survey and all locations, products, and buildings features that yielded an instrument response.

If building pressure was manipulated during the investigation, provide pressure transducer readings. Clearly indicate which results were obtained under baseline conditions vs. pressurized/depressurization conditions. Note the initial baseline pressure condition.

- **Data Interpretation:** Discuss the results from each step in the investigation process and key decision points in the investigation process. Discuss any potential indoor sources that were identified and the basis for identification. If the sources were removed, discuss the impact on the concentration of target VOCs in indoor air. If flux testing was conducted, discuss the findings (i.e., was the tested item a significant source of the target VOC). Discuss any vapor entry points that were identified and the basis for identification. Discuss the overall conclusion regarding the presence or absence of vapor intrusion.
- **Supplemental Information:** Field notes, laboratory analytical reports, and other investigation details may be provided in appendices, as appropriate.

## 5.0 HAPSITE USE AND INSTRUCTIONS

The on-site analysis protocol was validated using a HAPSITE GC/MS (i.e., SMART PLUS). Information developed during the validation process is provided below, for reference. Field personnel should familiarize themselves with the protocol before attempting to use it. Additionally, they should have experience with vapor intrusion field investigations and a sound understanding of vapor intrusion processes. This is important because of the dynamic nature of decision-making in the field required by the protocol. It is also recommended that users of the protocol be familiar with operation of the on-site GC/MS analysis instrument so that they have a practical understanding of typical instrument performance and response. This is to better identify and remedy operational issues while in the field.

Sections 5.1 and 5.2 below summarize analytical methods and HAPSITE calibration, respectively. This information was developed during protocol validation and is provided for reference. Specific procedures may be modified depending upon site-specific needs and data quality objectives. Section 5.3 describes approaches to testing potential indoor VOC sources and subsurface vapor entry points. Section 5.4 provides cost estimates for using a HAPSITE in the on-site GC/MS analysis protocol.

### 5.1 Customized HAPSITE Analytical Methods

The HAPSITE methods described in this section were developed by Erik Dettenmaier (Erik.Dettenmaier@hill.af.mil) and Kyle Gorder (Kyle.Gorder@hill.af.mil) at Hill Air Force Base. Key instrument parameters are discussed below for reference. The user should make adjustments to tailor the method to account for his particular instrument (e.g., retention times on a HAPSITE SMART PLUS (30 m column) will be different than those on an ER (15 m column)) and site-specific requirements (e.g., key target VOCs).

#### 5.1.1 HAPSITE Quantitative Methods

On the HAPSITE, “Analyze” (GC/MS) methods are used to quantify target VOCs. Different methods can be developed to identify specific compounds as well as different concentration ranges. For many indoor air sampling applications where VOC concentrations are low, the selective ion monitoring (SIM) mode can be used to increase the detector sensitivity for the target analytes.

Two customized HAPSITE methods were developed for use with this investigation protocol:

- i) **Chlorinated VOCs SIM Method:** a chlorinated VOC method that targets nine common chlorinated VOCs: vinyl chloride (VC), 1,1-dichloroethylene (1,1-DCE), trans-1,2-dichloroethylene (trans-1,2-DCE), 1,1-dichloroethane (1,1-DCA), cis-1,2-dichloroethylene (cis-1,2-DCE), 1,2-dichloroethane (1,2-DCA), carbon tetrachloride (CTCL), trichloroethylene (TCE), and tetrachloroethylene (PCE).
- ii) **Petroleum VOCs SIM Method:** a petroleum VOC method that targets methyl tert-butyl ether (MTBE), benzene, toluene, ethylbenzene, and xylenes.

The accuracy, precision, and sensitivity of these methods were documented through a laboratory validation study and field demonstrations (GSI, 2012, 2013). The cVOC method has a sensitivity of 0.5 to 1.0 ug/m<sup>3</sup> and the petroleum VOC method has a sensitivity of 1.0 to 5.0 ug/m<sup>3</sup>.

**Table 4: Sensitivity of HAPSITE Quantitative Mode**

VOC Class	Typical Sensitivity
Chlorinated VOCs	0.5 to 1.0 ug/m <sup>3</sup>
Petroleum VOCs	1.0 to 5.0 ug/m <sup>3</sup>

Note: Actual instrument sensitivity may vary depending on background ion counts and other field conditions.

The customized methods for the HAPSITE are provided below, including the selected characteristic ions for each compound targeted in the methods, the temperature settings, GC temperature profiles including ramp times and rates, and the timing and mass measurements associated with each scan set in the method. These methods were designed for low concentration samples (i.e., 0 – 10 ppbV range).

For samples anticipated to have high concentrations (e.g., in the 100 – 1000 ppbv range), these methods can be modified simply by reducing the sample volume (i.e., decrease the sampling duration from 1 minute to 10 seconds in Inlet State 2 on Figure 7).

These analytical method specifications are provided as examples. As noted above, adjustments may be needed depending on the particular site target VOCs and instrument model used.



### 5.1.1.1 Chlorinated VOCs SIM Method

This analytical method was developed for nine cVOCs. The target compounds and characteristic ions used to identify and quantify each compound are summarized in Table 5. TCE and PCE are common drivers for vapor intrusion investigations. Based on the laboratory study and field demonstrations (GSI, 2013), identification of these compounds using this HAPSITE method is reliable. Other compounds such as vinyl chloride and cis-1,2-dichloroethylene may require more effort to identify and quantify accurately. To mitigate this issue, the analytical method can be modified to better measure these compounds at sites where they are the key target VOCs.

**Table 5: Target Compounds in the cVOC Method**

Compound	Selected Characteristic Ions in Order of Decreasing Intensity
Vinyl Chloride	<b>62</b> , 61, 65, 63, 96
1,1-DCE	<b>61</b> , 63, 96, 62
Trans-1,2-DCE	<b>61</b> , 63, 96, 62, 65
1,1-DCA	<b>63</b> , 65, 61, 96, 62
Cis-1,2-DCE	<b>61</b> , 96, 63, 62
1,2-DCA	<b>62</b> , 64
CTCL	<b>117</b> , 119
TCE	<b>130</b> , 95, 62
PCE	<b>166</b> , 164

Note: Bold font indicates primary identifying ion. Compounds listed in order of elution.

Important instrument settings include startup settings (initial target temperatures [Figure 6]), inlet states and temperature profiles (Figure 7), and compound search parameters (Figure 8). The settings shown were developed for a SMART PLUS.

**Figure 6: Initial Temperature Settings in the cVOC Method**

The screenshot displays the 'HAPSITE Temperatures (C)' window. It features a table with two columns: 'Component' and 'Target Setting'. The table lists the following settings:

Component	Target Setting
Column	65.0
Membrane	60.0
Valve Oven	70.0
Heated Lines	70.0
Probe	40.0

To the right of the table is a 'Sample Input Device' dropdown menu, which is currently set to 'Probe'.

**Figure 7: Volume/duration of inlet states, GC temperature profile, and timing of SIM sets in the cVOC Method**

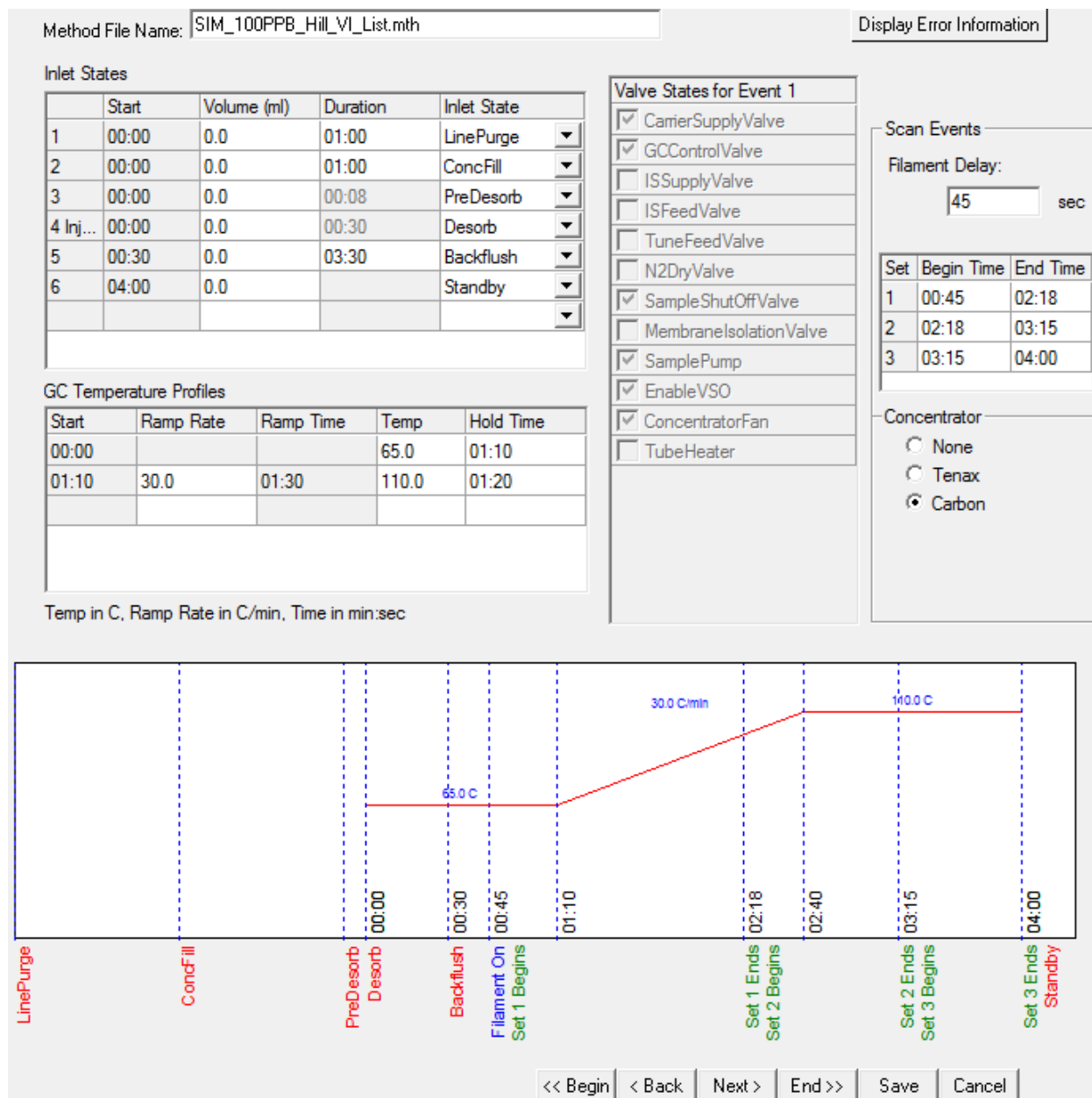

**Figure 8: Specific masses and search parameters in each SIM set in the cVOC Method**

Method File Name:  Display Error Information

Scan Sets Filament Delay:  sec

Set	Name	Round Trip Time (sec)	Begin Time (min:sec)	End Time (min:sec)
1		0.800	00:45	02:18
2		0.960	02:18	03:15
3		0.800	03:15	04:00

Mass Measurements for Scan Set 1

Mass	Mass Width	Extra	Dwell (us)	Lead In
61.0	0.6	10	2000	3
62.0	0.6	10	2000	3
63.0	0.6	10	2000	3
65.0	0.6	10	2000	3
96.0	0.6	10	2000	3

Mass Measurements for Scan Set 2

Mass	Mass Width	Extra	Dwell (us)	Lead In
62.0	0.6	10	2000	3
64.0	0.6	10	2000	3
95.0	0.6	10	2000	3
117.0	0.6	10	2000	3
119.0	0.6	10	2000	3
130.0	0.6	10	2000	3

Mass Measurements for Scan Set 3

Mass	Mass Width	Extra	Dwell (us)	Lead In
164.0	0.6	10	5000	3
166.0	0.6	10	5000	3

Note: Scan Set 1 – VC, 1,1-DCE, trans-1,2-DCE, 1,1-DCA, cis-1,2-DCE; Scan Set 2 – 1,2-DCA, CTCL, TCE; Scan Set 3 – PCE.

### 5.1.1.2 Petroleum VOCs SIM Method

This analytical method was developed for seven target VOCs. The target compounds and characteristic ions used to identify and quantify each compound are summarized in Table 6. Benzene and ethylbenzene are common drivers for vapor intrusion investigations. Based on the laboratory study and field demonstrations, identification of these compounds using this HAPSITE method is reliable. Compounds such as MTBE may require more effort to identify and quantify accurately. To mitigate this concern, the method can be modified to better measure these compounds at sites where they are the key target VOCs.

**Table 6: Target Compounds in the Petroleum VOCs Method**

Compound	Selected Characteristic Ions in Order of Decreasing Intensity
MTBE	<b>73</b> , 57
Benzene	<b>78</b> , 77, 73
Toluene	<b>91</b> , 92, 77
Ethylbenzene	<b>91</b> , 106, 77, 92
m,p-xylene	<b>91</b> , 106, 77, 92
o-xylene	<b>91</b> , 106, 77, 92

Note: Bold font indicates primary identifying ion. Compounds listed in order of elution.

Important instrument settings include startup settings (initial target temperatures [Figure 9]), inlet states and temperature profiles (Figure 10), and compound search parameters (Figure 11). The settings shown were developed for a SMART PLUS.

**Figure 9: Initial Temperature Settings in the Petroleum VOCs Method**

The screenshot displays the 'HAPSITE Temperatures (C)' window. It features a table with two columns: 'Component' and 'Target Setting'. The table lists the following settings:

Component	Target Setting
Column	65.0
Membrane	60.0
Valve Oven	70.0
Heated Lines	70.0
Probe	40.0

To the right of the table is a 'Sample Input Device' dropdown menu, which is currently set to 'Probe'.

**Figure 10: Volume/duration of inlet states, GC temperature profile, and timing of SIM sets in the Petroleum VOCs Method**



The graph displays the GC temperature profile over time. The y-axis represents temperature in degrees Celsius, and the x-axis represents time in minutes and seconds. Key events are marked with vertical dashed lines and labels:

- LinePurge:** 00:00
- ConcFill:** 00:00
- PreDesorb Desorb:** 00:00
- Filament On:** 00:15
- Foreflush:** 00:30
- Set Set 1 Begins:** 00:45
- Backflush:** 02:15
- Set Set 1 Ends:** 02:30
- Set Set 2 Begins:** 02:40
- Set Set 2 Ends Standby:** 05:05

The temperature profile shows a constant temperature of 65.0 C until 00:45, followed by a ramp at 30.0 C/min to 110.0 C at 01:30. It remains at 110.0 C until 03:45, then ramps at 30.0 C/min to 150.0 C.

**Figure 11: Specific masses and search parameters in each SIM set in the Petroleum VOCs Method**

Method File Name:

Scan Sets Filament Delay:  sec

Set	Name	Round Trip Time (sec)	Begin Time (min:sec)	End Time (min:sec)
1	Set 1	0.640	00:45	02:40
2	Set 2	0.640	02:40	05:05

Mass Measurements for Scan Set 1

Mass	Mass Width	Extra	Dwell (us)	Lead In
57.0	0.6	10	2000	3
73.0	0.6	10	2000	3
77.0	0.6	10	2000	3
78.0	0.6	10	2000	3

Mass Measurements for Scan Set 2

Mass	Mass Width	Extra	Dwell (us)	Lead In
77.0	0.6	10	2000	3
91.0	0.6	10	2000	3
92.0	0.6	10	2000	3
106.0	0.6	10	2000	3

Note: Scan Set 1 - MTBE, benzene; Scan Set 2 – toluene, ethylbenzene, m,p-xylene, o-xylene.

### 5.1.2 HAPSITE Survey Analytical Methods

When operated in the continuous-read survey mode, the HAPSITE by-passes the GC column and sends a continuous sample directly to the mass spectrometer detector. For vapor intrusion investigations, survey mode is used to detect ions associated with one or two specific target analytes. Three customized HAPSITE survey analytical methods are provided below as examples.

- i) a three-ion method for the detection of PCE (Figures 12-13);
- ii) a three-ion method for the detection of TCE (Figures 14-15); and
- iii) a three-ion method for the detection of Benzene (Figures 16-17).

Details of the survey methods, including the HAPSITE temperature settings and target masses are provided below.

### 5.1.2.1 PCE 3-ion Survey Method

**Figure 12: Temperature Settings in the PCE 3-ion Survey Method**

HAPSITE Temperatures (C)	
Component	Target Setting
Column	65.0
Membrane	60.0
Valve Oven	70.0
Heated Lines	-1.0
Probe	40.0

**Figure 13: Specific Masses and Search Parameters in the PCE 3-ion Survey Method**

Scan Set Name:

Mass	Mass Width	Extra	Dwell (us)	Lead In
131.0	0.6	10	5000	3
164.0	0.6	10	5000	3
166.0	0.6	10	5000	3

Mode:  Timed  Trigger

Scans to Average:

RoundTrip Time (sec):



5.1.2.2 TCE 3-ion Survey Method

Figure 14: Temperature Settings in the TCE Survey Method

HAPSITE Temperatures (C)

Component	Target Setting
Column	65.0
Membrane	60.0
Valve Oven	70.0
Heated Lines	-1.0
Probe	40.0

Figure 15: Specific Masses and Search Parameters in the TCE Survey Method

Scan Set Name:

Mass	Mass Width	Extra	Dwell (us)	Lead In
95.0	0.6	10	2000	3
130.0	0.6	10	2000	3
132.0	0.6	10	2000	3

Mode:  Timed  Trigger

Scans to Average:

Round Trip Time (sec):

### 5.1.2.3 Benzene 3-ion Survey Method

**Figure 16: Temperature Settings in the Benzene Survey Method**

HAPSITE Temperatures (C)	
Component	Target Setting
Column	60.0
Membrane	60.0
Valve Oven	70.0
Heated Lines	-1.0
Probe	40.0

**Figure 17: Specific Masses and Search Parameters in the Benzene Survey Method**

Method File Name:

Scan Set Name:

Mass	Mass Width	Extra	Dwell (us)	Lead In
51.0	0.6	10	1000	3
77.0	0.6	10	1000	3
78.0	0.6	10	1000	3

Mode:  Timed  Trigger

Scans to Average:

RoundTrip Time (sec):

## 5.2 Calibration Procedures for Quantitative Analytical Methods

Instrument performance goals should be established during workplan development, and the on-site instrument should be checked prior to fieldwork to verify that it is operating properly. The initial equipment checks and QA analyses can be done using an existing method and calibration library. If the QA results fall outside of the desired performance goals, the instrument should be recalibrated. Example QA samples and data quality objectives (DQOs) include:

- Method blanks (i.e., outdoor air or a sample of VOC-free nitrogen). Example DQO: result for key target VOC less than lower calibration limit; and
- CCV sample(s). Example DQO: RPD < 100% for key target VOC.

A calibration curve with a minimum of five points is recommended for quantification of air samples. Because sample results will be used to distinguish between vapor intrusion and indoor sources of VOCs, the calibration range should span VOC concentrations expected in typical indoor air (i.e., 0 to 10 ppbv).

Standard mixes at different concentrations within the calibration range are created by diluting a standard gas with blank air. Standard gases containing known quantities of the target VOCs can be obtained from specialty gas vendors. Laboratory-grade nitrogen to dilute the standard can also be obtained from specialty gas vendors. Note that if ambient (e.g., outdoor) air is sufficiently “clean”, it may be used to dilute the standard gas in lieu of lab grade nitrogen.

An example series of dilutions is provided in Table 7. The proportions shown in Table 7 have been found to minimize dilution errors (GSI, 2013). However, specific proportions of blank vs. parent/standard gas may vary and should be tailored to project-specific needs and data quality requirements. The example below assumes a pure standard gas with 1 ppm (1000 ppb) of each target VOC as a starting point. We also assume that the standard mixes are prepared in 1-L Tedlar bags. Additional recommendations to minimize errors during the calibration process include i) adding the appropriate quantity of blank air to each Tedlar bag first, then adding the appropriate quantity from the VOC parent bag; ii) reusing Tedlar bags a maximum of 10 times; and iii) analyzing the dilution bag samples within 1-2 days of preparation.

**Table 7: Example Concentrations Utilized in the cVOC and Petroleum VOC Calibration Curves**

Tedlar Bag No.	Standard Mix Goal (ppb)	Blank Air for Dilution	+	Volume / Parent Bag Concentration	Total Volume Available for Analysis (mL)
1	Pure Standard	n/a		Need at least 90 mL	
2	100	810 mL Blank Air	+	90 mL of pure standard (1000 ppb)	900
3	30	525 mL Blank Air	+	225 mL from 100 ppb bag	750
4	10	810 mL Blank Air	+	90 mL from 100 ppb bag	900
5	5	750 mL Blank Air	+	150 mL from 30 ppb bag	900
6	3	525 mL Blank Air	+	225 mL from 10 ppb bag	750
7	1	810 mL Blank Air	+	90 mL from 10 ppb bag	900
8	0.5	855 mL Blank Air	+	45 mL from 10 ppb bag	900

Note: Blank air is either laboratory-grade nitrogen or “clean” outdoor air.

Standard mixes of the desired dilutions are made in order of high to low concentrations (i.e., Bag Nos. 1 through 8, in order).

These mixes are analyzed in order from low to high concentrations (e.g., Bag No. 8, 7, 6, 5, 4, 3, in that order). The results are used to build the calibration curve using the instrument software. Each calibration curve may be forced through the origin (zero concentration). This curve fitting method is often helpful to quantify VOCs at low concentrations. For certain compounds such as vinyl chloride and MTBE, analysis of the lowest (i.e., 0.5 ppbv) standard may result in a non-linear response. This lowest point may be removed from the calibration curve for those specific compounds.

### **Criteria Utilized to Assess the Quality of Each Calibration Curve**

The basic procedure for developing the calibration curves is described above. QA criteria for calibration curve acceptability are project-specific. However, criteria demonstrated to be suitable for implementation of the on-site analysis protocol (GSI, 2013) include: i) RSD <20%, ii) RSD of RF < 30% , and iii) curve fit  $R^2 \geq 0.98$ , where

- a) Relative Standard Deviation (RSD %) is the measure of the linearity of the concentration levels (ion counts) in the calibration curve for each compound.
- b) Relative Standard Deviation of the Response Factor (RSD of RF %) is the measure of the linearity of the response factors for each compound in the calibration curve, where the response factor is a measure of the relative response (ion count) of an analyte compared to that of an internal standard.

### 5.3 Testing Specific VOC Sources with the HAPSITE and Isolation Device

Specific indoor sources (i.e., consumer products) and potential vapor entry points can be isolated and tested to determine the degree to which they may be impacting indoor air quality. This section describes different options for construction, use, data analysis, and interpretation of results.

#### 5.3.1 Indoor VOC Sources

“Flux” or “emission” chambers can be used to isolate potential VOC sources and test the degree to which they may be impacting indoor air quality. Items can be identified for testing based on results of a HAPSITE survey or other method such as product type or information on the label. The testing process includes isolating the item(s) in a sealed container, allowing the items to off-gas for several minutes, and then collecting a quantitative sample of the air in the container.

#### Construction

The container or chamber should be large enough to contain one or two typical consumer products (e.g., aerosol cans). The chamber can simply be a tote used to isolate the items. The chambers can also be constructed to be air-tight, with two ports and tubing installed through the cap. A syringe and a Tedlar bag can be attached to mix air in the system and collect a sample, respectively (Figure 18). Non-reactive materials (e.g., glass jar, Teflon tubing) may be used to minimize adsorptive loss of VOCs and allow the chamber to be re-used with minimal carry-over. The components of such a chamber are shown in Figure 19.

**Figure 18: Testing a Potential Indoor VOC Source**



**Figure 19: Indoor Source Flux Chamber Construction**

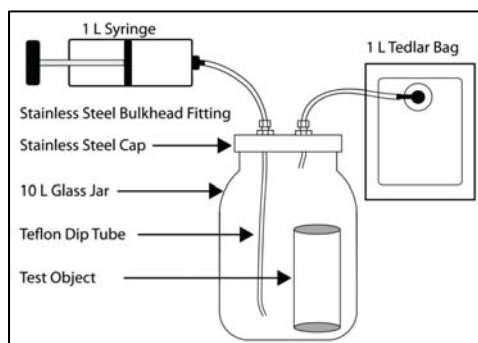

## Use: Step-by-Step

Emission chambers can be used to simply evaluate whether the indoor source is significant or not. In this case, the chamber is closed for several minutes to allow the items to off-gas. Then, the HAPSITE probe is inserted to collect the sample from within the chamber. If the concentrations in the chamber are significantly (i.e., 10x) higher than the air at the testing location, then the items are likely significant sources of the target VOCs. Note that, because of the potentially high concentrations in the chambers, it is advisable to switch to an analytical method suitable for high concentrations prior to doing the testing.

If a more quantitative result is desired, we recommend the following steps using the equipment illustrated in Figures 18 and 19 above.

1. Place the item for testing in the chamber and close the lid. Attach the syringe and Tedlar bag, and check that the connections are secure.
2. Record the time the item was sealed in the chamber. Allow the item to flux (i.e., off-gas) within the chamber for approximately 2 minutes. Pump the syringe to mix air in the system during this time.
3. Select an appropriate quantitative analytical method for low ppm concentrations of target VOC. For the HAPSITE, use either the Chlorinated VOCs PPM Method or Petroleum VOCs PPM Method (Section 5.1.1). Expel the air from the syringe and then detach the Tedlar bag. Using the HAPSITE in quantitative mode, measure the concentration of the target VOC from the air sample in the Tedlar bag.
4. Record the time the sample was collected (i.e., elapsed time), and concentrations of the target VOCs. If the VOC concentration is non-detect, a more sensitive analytical method can be used. For example, use either the Chlorinated VOCs SIM Method or Petroleum VOCs SIM Method (Section 5.1.1). If the VOC concentration is above the linear range of the instrument, the sample can be diluted to obtain a more accurate concentration measurement.
5. Calculate the Emission Rate:

$$E = (C \times V_t)/t$$

Where:

Parameter	Description	Units
E	Emission Rate	ug/min
C	Concentration of Target VOC in Chamber	ug/m <sup>3</sup>
V <sub>t</sub>	Volume of Emission Chamber (total flux volume)	m <sup>3</sup>
t	Emission time (flux sampling time)	min

Note: Concentration (ug/m<sup>3</sup>) = Concentration (ppbV) x Molecular Weight / 24.45

- Estimate the predicted indoor air concentration corresponding to the measured emission rate.

$$C_{\text{air}} = E/(I \times V)$$

Where:

Parameter	Description	Units
$C_{\text{air}}$	Predicted Concentration in Indoor Air	$\mu\text{g}/\text{m}^3$
E	Emission Rate	$\mu\text{g}/\text{min}$
V	Volume of Building (or part of building with higher VOC concentration)	$\text{m}^3$
I	Estimated Building Air Exchange Rate*	$\text{min}^{-1}$

Note: Air exchange rate for a residence is typically 6 to 20  $\text{day}^{-1}$  (0.004 to 0.014  $\text{min}^{-1}$ ). An assumption of 12  $\text{day}^{-1}$  is generally acceptable (0.5 per hour, or approximately 0.01 per minute).

- Compare the measured concentration of the target VOC in indoor air to the predicted concentration based on the flux measurement. Note that the predicted concentration will have significant uncertainty due to the semi-quantitative nature of the flux testing and the uncertainty associated with the air exchange rate. However, if the measured and predicted concentrations are within a factor of 2 to 3, then the tested item is likely the primary source of the target VOC in indoor air.

### 5.3.2 Subsurface Source Isolation and Testing

Floor cracks or other areas can be isolated to test the degree to which vapors may be migrating into the building from beneath the slab. Floor cracks or penetrations (e.g., expansion joints, plumbing penetrations) can be identified for testing based on results of a HAPSITE survey. Areas for testing can also be identified by noting rooms with anomalously high target VOC concentrations in which no indoor sources are found.

The overall process involves isolating a section of the floor under a cover and collecting air samples from the isolated space for quantitative analysis.

#### Construction

Materials used to isolate cracks in slabs, floor drains, and other features can be made of plastic (e.g., polyethylene) sheeting (Figure 20, left) or can be a device specifically designed for this testing (Figure 20, right). Use of plastic to isolate the crack is acceptable, but a metal isolation device is more reliable because VOCs can diffuse through plastic.

**Figure 20: Examples of Vapor Entry Point Isolation and Testing**



**Use: Step-by-Step**

If the area is a significant source of VOCs to indoor air, the vapor entry rate will be high enough to result in high ppb or low ppm VOC concentrations in the trapped air.

If possible, conduct the testing during the baseline (i.e., unmanipulated) or the depressurized building pressure conditions. Sufficient indoor air measurements should be available so that the indoor VOC concentration range is established prior to floor testing.

If plastic sheeting is used to isolate the area, testing can be done by simply sealing the area, waiting several minutes, inserting the HAPSITE probe through the plastic, and collecting the sample. Note that the appropriate quantitative method (e.g., low ppm method) should be selected commensurate with the anticipated level of target VOCs.

Depending on project goals and on-site findings, different variations of the sampling may be helpful (e.g., sampling when the covering is first placed and resampling after some time (e.g., 20 minutes) to determine if VOCs are building up in the isolated space).

If more quantitative evaluations are desired, the following steps can be taken:

1. Place the chamber on the floor, sealing it to the floor with modeling clay, plumber's putty, or similar. Attach a 1-L syringe and an empty Tedlar bag to each of the ports, and check that the connections are secure.
2. Record the time the floor area is isolated. Allow additional time (e.g., 5 minutes) for potential vapor flux into the chamber. At the end of this period, slowly pull air from beneath the chamber into the syringe, open the Tedlar bag, and then push the plunger of the syringe so that air fills the Tedlar bag. Collect at least 300 mL into the Tedlar bag to ensure that sufficient air is available for HAPSITE analysis.



3. Select an appropriate quantitative analytical method for low ppm concentrations of target VOCs. For the HAPSITE, use either the Chlorinated VOCs PPM Method or Petroleum VOCs PPM Method, as appropriate for the building target VOCs. Using the HAPSITE in quantitative mode, measure the concentration of the target VOCs from the air sample in the Tedlar bag.
4. Record the time the sample was collected (i.e., elapsed time), and concentrations of the target VOCs. If no target VOCs are detected, a more sensitive analytical method can be used. For example, use either the Chlorinated VOCs SIM Method or Petroleum VOCs SIM Method. If the VOC concentration is above the linear range of the instrument, the sample can be diluted to obtain a more accurate concentration measurement.

Compare the measured concentration of the target VOCs from the floor sample to concentrations in indoor air. Note that the former concentration will have significant uncertainty due to the semi-quantitative nature of the testing. However, if the result is more than 2-3 times the indoor air concentration, the tested area is likely to contribute to VOC concentrations in indoor air.

### **5.3.3 Estimated Costs**

Costs for conducting the on-site analysis protocol are marginally higher than implementing a conventional vapor intrusion investigation. Additional analysis can be found in the ER-201119 Final Report (GSI, 2013); costs are summarized in Table 8. However, in summary, additional effort and expense can be expected for project preparation (e.g., equipment rental, calibration/QA steps, etc.) and data management (e.g., differential pressure and HAPSITE data files, collecting detailed field notes to document sampling conditions/locations/times, etc). Because of the data volume collected, one can also expect additional effort during project reporting, to allow for reconciling all the different types of data.

**Table 8: Estimated Costs for Implementing the On-Site Analysis Protocol at Four Buildings**

<b>Cost Element</b>	<b>Category</b>				<b>Unit Cost</b>	<b>Unit</b>	<b>Cost</b>	<b>TOTALS</b>
1. Project planning and preparation	Labor	Senior Project Scientist/Engineer	16	hours	\$150	\$/hr	\$2,400	\$6,000
	Labor	Project Scientist / Engineer	36	hours	\$100	\$/hr	\$3,600	
2. On-site analysis field program	Labor	Senior Project Scientist/Engineer	24	hours	\$150	\$/hr	\$3,600	\$10,605
	Labor	Project Scientist / Engineer	24	hours	\$100	\$/hr	\$2,400	
	Equipment Rental	HAPSITE, Floor fan, differential pressure recorder	3	days	\$575	\$/day	\$1,725	
	Off-site Sample Analysis	VOCs (3 samples x 4 buildings)	12	samples	\$240	\$/spl	\$2,880	
	Off-site Sample Analysis	Radon (3 samples x 4 buildings)	0	samples	\$110	\$/spl	0	
3. Data evaluation and reporting	Labor	Senior Project Scientist/Engineer	15	hours	\$150	\$/hr	\$2,250	\$5,750
	Labor	Project Scientist / Engineer	35	hours	\$100	\$/hr	\$3,500	
<b>Project Total:</b>								<b>\$22,355</b>
<b>Cost Per Building</b>								<b>\$5,589</b>

Note: 1) Estimates assume application of the procedure at four buildings during a single field program, assuming 2 buildings per day. Project planning and preparation includes pre-mobilization and on-location tasks (equipment prep/QA). 2) Cost estimates do not include travel to the site or shipping.

## 6.0 REFERENCES

- Dawson, H.E., and T. McAlary, 2009, A compilation of statistics for VOCs from post-1990 indoor air concentration studies in North American residences unaffected by subsurface vapor intrusion. *Ground Water Monitoring and Remediation* 29, no. 1: 60-69.
- Doucette, W.J., Hall, A.J. and Gorder, K.A., 2010, Emissions of 1, 2-Dichloroethane from Holiday Decorations as a Source of Indoor Air Contamination. *Ground Water Monitoring & Remediation* 30 (1): 67-73.

- Gorder, K.A. and Dettenmaier, E., 2011, Portable GC/MS Methods to Evaluate Sources of cVOC Contamination in Indoor Air, *Ground Water Monitoring & Remediation*. V. 31 (4): 113-119.
- GSI Environmental, 2012, Results of Laboratory Validation Study, ESTCP Project ER-201119, Use of On-Site GC/MS Analysis to Distinguish between Vapor Intrusion and Indoor Sources of VOCs (McHugh, Molofsky, Gorder, Dettenmaier, Rivera-Duarte, Version 3, August 2012).
- GSI Environmental, 2013, Final Report, ESTCP Project ER-201119, Use of On-Site GC/MS Analysis to Distinguish between Vapor Intrusion and Indoor Sources of VOCs (Beckley, McHugh, Gorder, Dettenmaier, Rivera-Duarte, Version 1, June 2013).
- McHugh T.E., L. Beckley, D. Bailey, K. Gorder, E. Dettenmaier, I. Rivera-Duarte, S. Brock and I. MacGregor, 2012. Evaluation of Vapor Intrusion Using Controlled Building Pressure. *Environ. Sci. Technol.*, V. 46 (9): 4792–4799.
- ITRC, 2007, Vapor Intrusion Pathway: A Practical Guideline, Interstate Technology & Regulatory Council Vapor Intrusion Team, January 2007.
- Odabasi, M., 2008, Halogenated Volatile Organic Compounds from the Use of Chlorine-Bleach-Containing Household Products, *Environ. Sci. Technol.* V. 42 (5): 1445-1451.
- USEPA, 2013, Regional Screening Table. [http://www.epa.gov/reg3hwmd/risk/human/rb-concentration\\_table/](http://www.epa.gov/reg3hwmd/risk/human/rb-concentration_table/) (May 2013 update; accessed 21 June 2013).
- USEPA, 2011, Environmental Technology Verification Report Verification of Building Pressure Control as Conducted by GSI Environmental, Inc. for the Assessment of Vapor Intrusion, <http://www.epa.gov/nrmrl/std/etv/vt-ams.html#sctvi>.
- USEPA, 2002, OSWER Draft Guidance for Evaluating the Vapor Intrusion to Indoor Air Pathway from Groundwater and Soils (Subsurface Vapor Intrusion Guidance), EPA530-D-02-004. November 2002.