

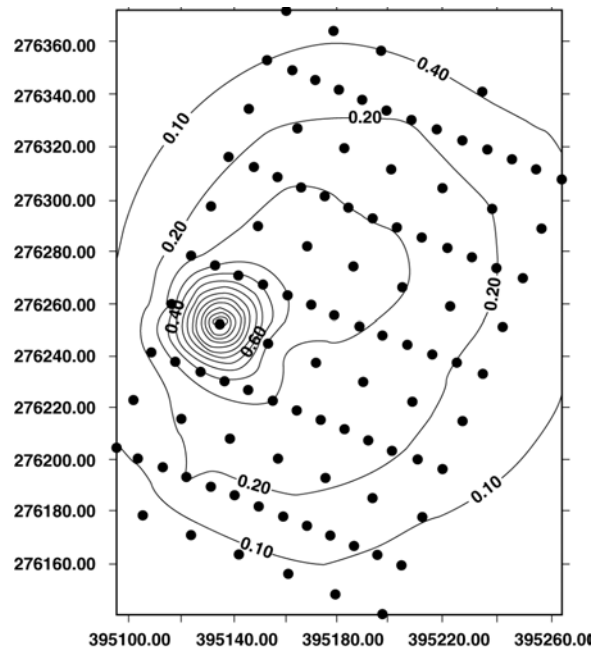

Survey of Technologies for Monitoring Containment Liners and Covers

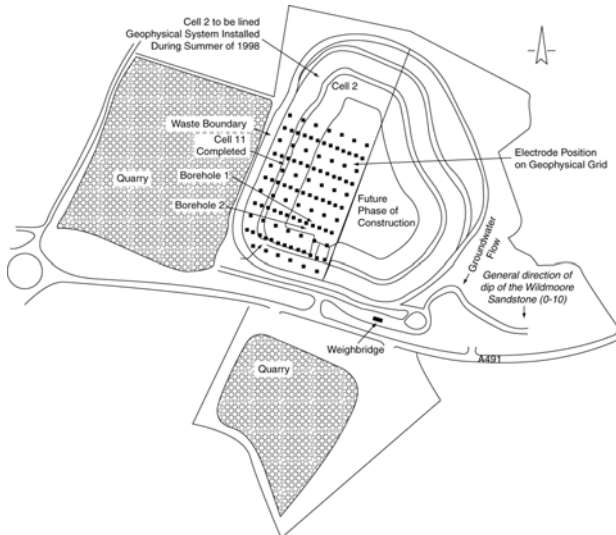
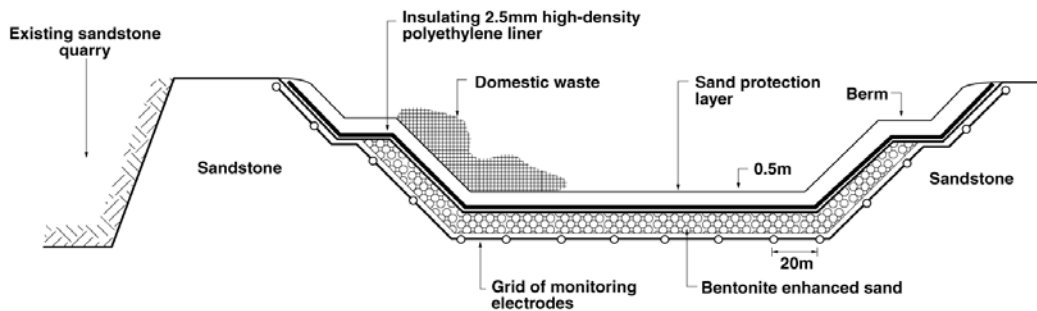

**Solid Waste and
Emergency Response
(5102G)**

**EPA 542-R-04-013
June 2004
<http://clu.in.org>
www.epa.gov/tio**

Survey of Technologies for Monitoring Containment Liners and Covers

**U.S. Environmental Protection Agency
Office of Solid Waste and Emergency Response
Office of Superfund Remediation and Technology Innovation
Washington, DC 20460**



Recycled/Recyclable
Printed with Soy/Canola Ink on paper that
contains at least 50% recycled fiber

NOTICE AND DISCLAIMER

This report has been funded wholly by the U.S. Environmental Protection Agency (EPA) under Contract Numbers 68-W-00-084 and 68-W-03-038. It is intended solely to provide general information about current technologies for monitoring containment liners and covers. The report is not intended, nor can it be relied upon to create any rights enforceable by any party in litigation with the United States. Mention of trade names or commercial products does not constitute endorsement or recommendation for use. Cover illustrations are reprinted from *Ground Water Monitoring & Remediation* with permission of the National Ground Water Association. Copyright 1997.

Copies of this report are available free of charge from the National Service Center for Environmental Publications (NSCEP), P.O. Box 42419, Cincinnati, OH 45242-0419; telephone (800) 490-9198 or (513) 490-8190; or facsimile (513) 489-8695. Refer to document EPA 542-R-04-013, *Survey of Technologies for Monitoring Containment Liners and Covers*. This document can also be obtained through EPA's Hazardous Waste Clean-Up Information (CLUIN) System on the Web at <http://clu.in.org>.

For more information about this report, please contact: Kelly Madalinski, U.S. Environmental Protection Agency, Technology Innovation Program (5102G), 1200 Pennsylvania Avenue, NW, Washington, DC 20460; telephone (703) 603-9901 or email madalinski.kelly@epa.gov.

ACKNOWLEDGMENT

Special acknowledgment is given to the federal and state staff and other remediation professionals for providing information for this document. Their cooperation and willingness to share their expertise about existing and potential technologies to provide innovative long-term monitoring on the integrity of containment liners and covers encourages their application at other sites.

EXECUTIVE SUMMARY

Regulations governing the design of engineered liners and covers for hazardous waste landfills and surface impoundments were issued in 1982 with the promulgation of Resource Conservation and Recovery Act (RCRA) Subtitle C rules. These regulations were performance based and required installation of a double liner system and a cover having a permeability equal to or less than that of the liner system. The goal of RCRA Subtitle C landfill regulations was to ensure that the primary liner and leachate collection system collect and treat any liquids that enter a containment unit. Because Subtitle C containment units receive hazardous wastes, a second composite liner with a leachate collection system beneath the primary liner was required. In effect, this second liner acts as a leak detection system for the primary liner and serves as a backup barrier to contain any leachate that manages to penetrate the primary liner. With the compacted soil base of the liner and the very low leachate head expected to exist on the overlying geomembrane, regulators anticipated that there would be minimal chance of a release of leachate to the environment.

In 1991, the Environmental Protection Agency (EPA) promulgated RCRA Subtitle D rules, regulating the design of engineered liners and covers for municipal solid waste landfills. These regulations were also performance based and specified a composite liner construction, or its equivalent, and a cover having a permeability of 10^{-5} cm/s or less, or equal to or less than the liner system. Since co-disposal with hazardous wastes was no longer allowed, regulators determined that the leachate generated at municipal solid waste landfills would be considerably less of an environmental problem than at hazardous landfills. Thus, only one composite liner was deemed necessary.

Regulations under Subtitles C and D identify several common methods for measuring the performance of liner and cover systems, including the visual inspection of covers, observation of leachate levels and rates, and installation of groundwater quality monitoring wells downgradient of the landfill. This report examines a variety of technologies that can further measure performance of covers and liners. Liner technologies monitor the vadose zone beneath containment system liners and/or provide an early warning of releases before they can have an impact on the groundwater. They may supplement or replace the groundwater monitoring system. A list of the methods presented and their attributes is provided in Table ES-1.

Systems designed to monitor releases through liners or provide an early warning of a potential liner failure can be divided into two major groups: those that can chemically speciate and quantitate the materials that escape (or provide a sample of them for analysis) and those that can only indicate that a release is occurring. Examples of the technologies capable of chemical speciation and quantitation are lysimeters, diffusion hoses, and soil gas detectors. Examples of the technologies that simply indicate a release is occurring are electrode grids and other electrical methods, electrochemical sensing wire cables, time domain reflectometry detection cables, capacitance sensors, and neutron probes. Of these, electrochemical sensing wire cables, time domain reflectometry detection cables, and intrinsic fiber optic sensors can be constructed so that they react to certain classes of chemicals.

Most of the monitoring systems listed in Table ES-1 have been deployed at landfills or surface impoundments to monitor the unsaturated zone. Each has strengths and weaknesses. Advanced tensiometers, lysimeters, electrochemical sensing wire cables, time domain reflectometry detection cables, capacitance sensors, and neutron probes mostly monitor the immediate vicinity of the devices. Hence, to better detect leaks, they either must be closely spaced, or the unsaturated zone beneath the containment unit must be engineered to bring the liquid to them. Closely spacing the detectors has the

advantage of providing a fairly accurate estimate of where a release is occurring, but can be expensive to deploy and operate. Engineering the unsaturated zone to divert a release to the detectors, can reduce the number of detectors needed and increase the probability of detecting a release. However, this approach increases construction costs and reduces the operator's ability to accurately locate the release. Some of the sites examined in this report have deployed more than one type of detector under a single containment unit. In these situations, instruments with limited spatial detection capabilities were used at locations beneath the containment unit considered to be most vulnerable to leaks. For example, suction lysimeters were placed beneath leachate collection sumps and neutron probe access pipes located at low points in the primary or secondary liner system.

Soil gas detectors (diffusion hoses and probes) are relatively easy to deploy, can be automated, and provide speciation capabilities. For soil gas detectors to be useful, however, the release must contain volatile constituents. Soil gas detectors have been widely used in the chemical and petroleum industries for tank and pipeline leak detection and have found some use in monitoring landfills. They can be deployed before or after construction of a landfill or impoundment. If deployed at a new landfill, it is possible to greatly reduce the time to detection by including a thin, coarse-grained layer of sand beneath the bottom of the composite liner to allow for faster diffusion of the escaping volatile organic chemicals.

Some electrical systems for leak detection can only be deployed when the containment unit is built and remain permanently under the liner or cover. Others can be deployed after construction is complete. The most widely used electrical system that is deployed under a liner during construction is the electrode grid. Provided the released material has an effect on the electrical properties of the unsaturated zone soils, these systems are capable of locating and tracking a release under the landfill with good accuracy. Electrode grid systems can be automated and, hence, provide frequent checks on the liner's integrity. However, they do not provide any information on the chemical makeup of the released material. Over 120 electrical grid systems are in use, the majority of which are in Europe.

Electrical systems that can be deployed at a landfill that has already been constructed apply an electrical potential across the non-conductive geomembrane liner to look for conductive leaks. Though generally used as a quality assurance method for leak detection in newly constructed landfill liners, these systems have been applied with some success to operating units. Systems of this type can easily be used to periodically monitor operating surface impoundments, and there is a well-established commercial vendor sector offering this service.

Table ES-1. Key Attributes of Vadose Zone Monitoring Systems.

Attribute	Advanced Tensiometers	Cable Network Sensors	Capacitance Sensors	Diffusion Hoses	Electrochemical Sensing Wire Cables	Electrode Grids	Intrinsic Fiber Optic Sensors	Lysimeters	Neutron Probes	Portable Electrical Systems	Soil Gas Systems	Time Domain Reflectometry Detection Cables	Wire Net Design
Automated	✓		✓	✓	✓	✓	✓			✓	✓	✓	
Continuous Operation	✓				✓	✓	✓					✓	
Unskilled Operators			✓	✓	✓		✓	✓	✓			✓	
Locates Discrete Area of Release	✓		✓	✓	✓	✓		✓	✓	✓		✓	✓
Locates General Area of Release		✓		✓	✓	✓	✓			✓	✓	✓	✓
Determines Volume of Release		✓				✓							✓
Identifies Contaminant				✓			✓	✓			✓		
Identifies Chemical Class of Contaminant				✓	✓		✓	✓			✓	✓	
Retrofitted	B			P	P/B		P/B		B	P/B	P/B	P/B	
Commercially Available	✓		✓	✓	✓	✓	✓	✓	✓	✓	✓	✓	
Full Scale Deployment for Liners			✓	✓		✓		✓	✓	✓	✓		✓
Demonstration Scale for Liners	✓	✓	✓	✓		✓		✓	✓	✓	✓		✓

P=Perimeter
B=Beneath liner

CONTENTS

NOTICE AND DISCLAIMER	i
ACKNOWLEDGMENT	i
EXECUTIVE SUMMARY	iii
FIGURES	ix
TABLES	ix
ACRONYMS	x
1.0 INTRODUCTION	1
1.1 Objectives	1
1.2 Approach	1
1.3 Report Organization	1
2.0 REGULATORY OVERVIEW OF LINER AND FINAL COVER SYSTEMS	2
3.0 LINERS	5
3.1 Design	5
3.2 Monitoring	6
3.3 Technologies	6
3.3.1 Diffusion Hoses	6
3.3.2 Intrinsic Fiber Optic Sensors	7
3.3.3 Soil Gas	8
3.3.4 Electrochemical Sensing Wire Cables	10
3.3.5 Time Domain Reflectometry Detection Cables	11
3.3.6 Electrode Grids	12
3.3.7 Portable Electrical Systems	15
3.3.8 Moisture Measuring Devices	16
Capacitance Sensors	17
Lysimeters	17
Neutron Probes	20
Advanced Tensiometers	21
3.3.9 Wire Net Designs	23
3.3.10 Cable Network Sensors	24
4.0 FINAL COVERS	26
4.1 Design	26
4.1.1 RCRA Subtitle C	26
4.1.2 RCRA Subtitle D	27
4.2 Monitoring	27
4.3 Leachate Inventory and Survey	28

4.4 Technologies	28
4.4.1 Moisture Measuring Devices	29
Tensiometers	29
Time Domain Reflectometry Probes	30
4.4.2 Electrode Grids	31
4.4.3 Portable Electrical Systems	31
4.4.4 Fiber Optic Stress Gauges	33
4.4.5 Fourier Transform Infrared Spectroscopy	33
5.0 SUMMARY AND DISCUSSION OF FINDINGS	35
REFERENCES	40
APPENDIX A	
Glossary	A-1
APPENDIX B	
List of Contacts, Vendors, and Products	B-1

FIGURES

1. Typical components of a closed double-lined landfill.	3
2. Minimum design for a hazardous waste landfill liner.	5
3. Minimum design for a MSW landfill liner.	6
4. Diffusion hose detection system.	7
5. Intrinsic fiber optic sensor system.	8
6. Soil gas sampling probe.	9
7. Conceptual model of electrochemical sensing wire cables.	10
8. Conductivity sensing wire	11
9. Hydrocarbon and solvent sensing wire.	11
10. Time domain reflectometry detection cable.	12
11. Sandy Hill Landfill geophysical electrode grid and borehole installation.	13
12. Cross-sectional view of Sandy Hill Landfill and geophysical electrode grid.	14
13. Sandy Hill Landfill electrical anomaly.	14
14. Portable electrical leak detection system	16
15. Capacitance sensor	17
16. Soilmoisture Model 1920 pressure/vacuum soil water sampler	18
17. In-plan layout of vadose zone sampling system in California landfill.	19
18. Detail of neutron probe access trench with lysimeter/soil gas conduit for monitoring California landfill.	20
19. CAMU vadose zone monitoring system at Sandia National Laboratories.	21
20. Configuration of an advanced tensiometer	22
21. Layout of wire net design.	23
22. Cable network sensor layout.	24
23. Typical Subtitle C cover	27
24. Typical minimum Subtitle D cover	27
25. Gage tensiometer	29
26. Time domain reflectometry probe.	29
27. Monitoring cover using a portable electrical system	32

TABLES

ES-1. Key Attributes of Vadose Zone Monitoring Systems	v
1. Key Attributes of Vadose Zone Monitoring Systems	39

ACRONYMS

ARAR	applicable or relevant and appropriate requirement
BGS	below ground surface
CAMU	corrective action management unit
CERCLA	Comprehensive Environmental Response, Compensation, and Liability Act of 1980
CCL	compacted clay liner
CFR	Code of Federal Regulations
DoD	Department of Defense
DOE	Department of Energy
ELDS	electronic leak detection system
FS	feasibility study
GC	gas chromatograph
GC/MS	gas chromatograph/mass spectrometer
GM	geomembrane
GPS	global positioning system
HDPE	high-density polyethylene
IFOS	intrinsic fiber optic sensors
IR	infrared
KRC	Karlsruhe Research Center
LCRS	leachate collection and removal system
LDPE	low-density polyethylene
LDS	leachate detection system
LED	light emitting diode
MSW	municipal solid waste
NAS	naval air station
NCP	National Oil and Hazardous Substances Pollution Contingency Plan
OP-FTIR	open-path Fourier transform infrared
PVC	polyvinyl chloride
QA/QC	quality assurance/quality control
RCRA	Resource Conservation and Recovery Act of 1976
SNL	Sandia National Laboratories
UST	underground storage tank

1.0 INTRODUCTION

The primary performance goal for waste containment systems is protection of groundwater quality. From about the mid-1970s, liners have been used to protect groundwater quality for some types of landfills in some parts of the country (EPA, 2002). The integrity of liners and covers for waste containment units is typically determined through indirect methods—sampling of downgradient groundwater monitoring wells for liners, and the measurement of changes in leachate levels occurring after closure for covers. This report documents technologies that can be used to detect releases through liners more directly as well as technologies that can detect changes in cover integrity before large amounts of water enter a closed landfill.

1.1 Objectives

The objectives of this report are:

- Identify and describe current technologies that could be used to detect releases to the vadose zone beneath the liner of a containment unit.
- Identify and describe technologies that could be used to identify potential problems with the integrity of final covers.
- Present examples of where these technologies have been deployed.
- Provide sufficient information on these technologies to provide some preliminary assessment on technology applicability.

1.2 Approach

The information on liner and cover monitoring technologies was gathered by conducting a comprehensive literature search and reviewing vendor websites that feature leak detection equipment. Both existing and potential leak detection technologies were evaluated for their applicability to vadose zone and final cover monitoring.

1.3 Report Organization

This report is divided into four sections.

- Section 1.0, Introduction, describes the content of the report.
- Section 2.0, Overview of Liner and Final Cover Systems, explains the regulations governing the standard design of liners and covers and summarizes design requirements.
- Section 3.0, Liners, discusses the design and monitoring requirements for liners and describes the current industry practice. This is followed by a summary of technologies that can be used to monitor the performance of liner systems.
- Section 4.0, Final Covers, discusses the design and monitoring requirements for covers and describes the current industry practice. This is followed by a summary of technologies that can be used to monitor the performance of cover systems.

A list of references relevant to this report follows, as do two appendices:

- Appendix A, a glossary of technical terms used in the report.
- Appendix B, a list of vendors organized by technology.

2.0 REGULATORY OVERVIEW OF LINER AND FINAL COVER SYSTEMS

The need for liner and cover systems at landfills is driven in large part by the need to contain contaminated liquids (leachate) and gases generated within a landfill. Containment prevents the migration of leachate and gases to soil, groundwater, surface water, and air outside the landfill. Leachate is generated when liquids are disposed of directly in the waste pile, when rainfall accumulates in the landfill before placement of a final cover, or when there is a flaw in the final cover that allows water to penetrate it. Landfill gases are generated as organic wastes biodegrade. Biodegradation primarily produces methane and carbon dioxide, but these gases can also contain small amounts of chlorinated and non-chlorinated volatile solvents. Volatile organic vapors also can be produced when they partition from the dissolved phase of a leachate.

The Resource Conservation and Recovery Act of 1976 (RCRA) and subsequent amendments gave the Environmental Protection Agency the authority to regulate the design of hazardous waste landfills and impoundments as well as municipal solid waste (MSW) landfills. RCRA Subtitle C regulations governing the design of engineered liners and covers for hazardous waste landfills and surface impoundments were issued in 1982. These regulations were performance based and required installation of a double liner system and a cover having a permeability equal to or less than that of the liner. The goal of RCRA Subtitle C was to ensure that the primary liner and leachate collection system (for landfills) collect and treat any liquids that enter a containment unit.

In 1991, RCRA Subtitle D regulations covering the design of engineered liners and covers for MSW landfills were issued. These regulations were also performance based and specified a single, composite liner construction (or its equivalent) and a cover having a permeability of 10^{-5} cm/s or less or less than or equal to the liner system. Composite liners are constructed using a geomembrane material overlying compacted soil. Final cover systems can vary widely but are typically composite systems similar in design to single liners. Figure 1 shows many of the components of an engineered containment system.

The performance standards for liners and covers are discussed in Sections 3 and 4 of this report, respectively. State requirements generally mirror the federal performance standards. Currently 49 of 50 states have delegated MSW landfill programs (EPA, 2002).

Remedial actions carried out under the Comprehensive Environmental Response, Compensation, and Liability Act of 1980 (CERCLA) and subsequent amendments can include capping of hazardous wastes in place, constructing a landfill to contain wastes from a cleanup, or constructing a treatment facility, such as an impoundment or leach pad. The National Oil and Hazardous Substances Pollution Contingency Plan (NCP) that implements CERCLA requires that remedial actions must at least attain applicable or relevant and appropriate requirements (ARARs). This means that before remedial or removal actions can occur at a CERCLA site, EPA must determine what other federal, state, and local regulations apply—either directly (applicable) or indirectly (relevant and appropriate)—to the action (EPA, 1989b). RCRA Subtitle C requirements for treatment, storage, and disposal facilities will frequently be ARARs for CERCLA actions because RCRA regulates the same or similar wastes as those found at CERCLA sites.

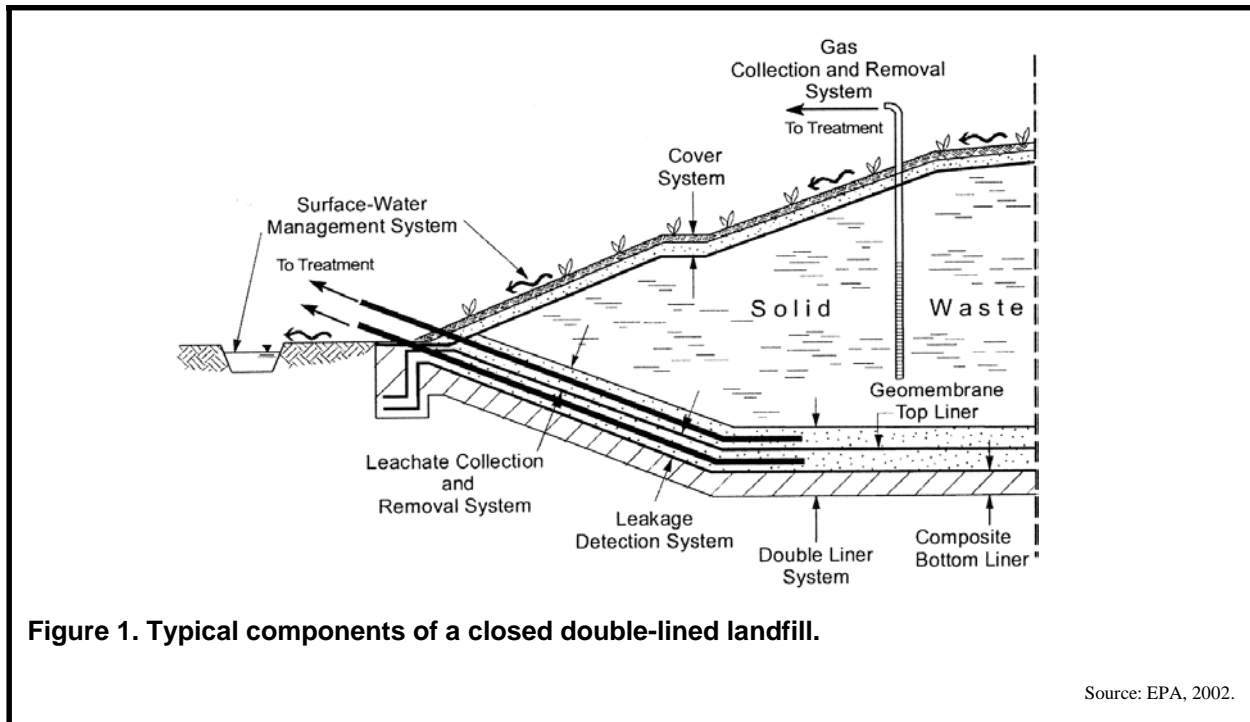

The current regulations, with some exceptions among state regulations, do not call for directly monitoring the integrity of all landfill components or impoundment containment systems. For example, the long-term performance of covers is determined by observing the level of leachate that is produced in a landfill cell. Leachate levels after closure generally fall to a negligible level within 10 years, or less, following capping (EPA, 2002). If leachate levels do not exhibit a downward trend with time, then it can be assumed that the integrity of the cover has been compromised.

In double-lined landfill cells, the second liner with attendant leachate collection system acts as a leak detection system for the first liner. However, with the exception of some state regulations, there is no requirement to monitor directly under the bottom-most liner of single- and double-lined designs. The accepted practice for monitoring the performance of liner systems is to install groundwater monitoring wells at the downgradient edge of a containment unit that are screened within the uppermost aquifer and look for changes in groundwater quality that might indicate a release is occurring.

The primary alternative to groundwater monitoring is to measure vapors and liquids in the unsaturated zone beneath a containment structure or vapors at its perimeter. There are many technologies available for monitoring the vadose zone beneath a containment unit. The choice of which one to use or which ones to use in conjunction with each other is site specific. Some considerations in making this choice are:

- Will the containment unit require retrofitting?
- Will the monitoring strategy cover the entire subsurface beneath the bottom liner, or will it monitor the most vulnerable areas, such as where it is difficult to obtain competent geomembrane seals (e.g., around high-flow leachate collection channels and sumps)?
- Does the system continue to produce good results after a leak is detected and repaired?

- Is it necessary to identify chemical species, or is it sufficient to simply know that a release is occurring?
- How accurate must the monitoring system be in locating the point of the release?
- What is the service life and reliability of the monitoring devices, and how easy are they to replace if they fail?
- Does the monitoring system need to operate continuously?

Several states (e.g., Arizona, New Mexico, Oregon, and Washington) allow alternatives to monitoring wells for measuring the performance of liner systems. Alternative methods are generally allowed when the methods can be shown to be more cost effective than monitoring wells which is generally the case when the depth to groundwater is large. The State of California requires that alternative methods be used in conjunction with monitoring wells.

3.0 LINERS

A liner system functions to intercept leachate or gas migrating within a landfill and route it to a collection point where it can be removed or treated. With impoundments it prevents the escape of the unit's contents. For optimum long-term performance, the liner must be physically resistant to the concentrations of chemicals expected in the leachate for as long as leachate is generated in the unit.

Landfill and impoundment liners typically include a composite liner component. Composite liners are constructed using a geomembrane (GM) overlying compacted soil to achieve a specified minimum hydraulic conductivity. Large sheets of geomembrane must be seamed together to completely cover the landfill bottom and sides. Commonly used geomembrane materials include:

- high-density polyethylene (HDPE);
- very flexible polyethylene;
- polyvinyl chloride (PVC);
- flexible polypropylene; and
- ethylene propylene diene monomer (EPA, 2002).

3.1 Design

A double-liner system with leachate collection and removal capabilities above each liner is required for Subtitle C landfill units. 40 CFR 264.301 suggests that the top (or primary) liner consist of a geomembrane and the bottom (or secondary) liner be a composite, with a geomembrane overlying at least 90 cm of compacted clay (CCL) or compacted soil (Figure 2). The soil must have a hydraulic conductivity of no more than 1×10^{-7} cm/s. In practice, a landfill owner/operator has a wide choice of construction techniques and materials to choose from to meet these performance criteria.

The primary leachate collection and removal system (LCRS), which is situated above the primary liner, is designed to maintain leachate levels at 30 cm (1 ft) or less and to convey the leachate to a sump where it is pumped to a holding tank or treatment system. The leachate detection system (LDS) below the primary liner, is a secondary leachate collection system that detects leaks through the primary liner. Impoundment design (40 CFR 264.221) is similar to landfills but lacks the LCRS section.

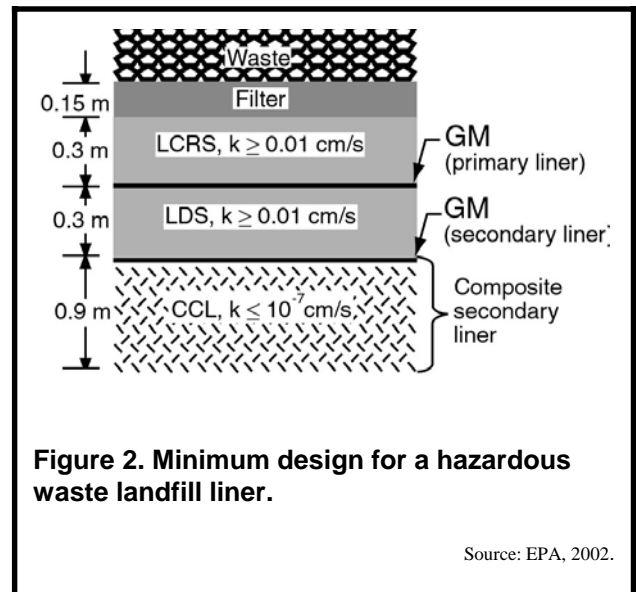

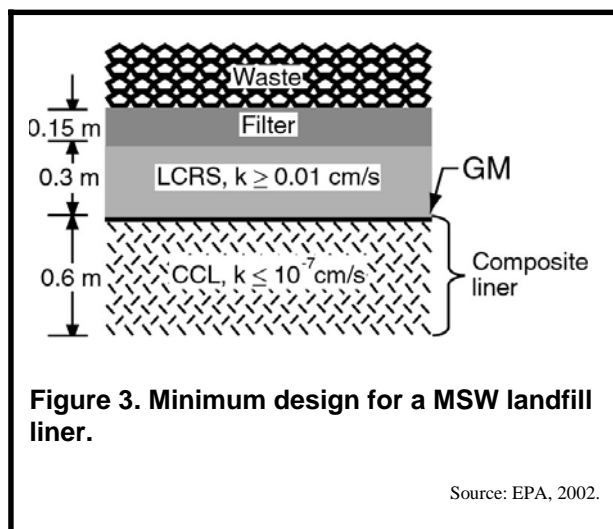

Subtitle D requirements for MSW landfills are somewhat less stringent than Subtitle C units. Subtitle D requires a composite liner with a leachate collection system capable of maintaining the leachate at a depth of 30 cm or less. The liner must consist of a minimum 30-mil flexible membrane liner (60 mil if the liner is HDPE) overlying not less than 60 cm of compacted soil with a hydraulic conductivity of no greater than 1×10^{-7} cm/s. A different design may be used if the liner is found to be protective by the state's program director. Figure 3 shows a typical Subtitle D liner system, which consists from top to bottom of filter material, LCRS, and a composite liner. Some states have adopted more stringent requirements for their MSW landfills.

3.2 Monitoring

The monitoring and inspection requirements of 40 CFR 264.303 (Subtitle C liners) include weekly inspections for the presence of leachate in the two leachate collection systems—the LCRS and the LDS. The amount of liquid removed from the LDS must be recorded weekly for both the active life and closure period of the landfill or impoundment. Depending upon the performance of the liner system, the weekly requirement can be relaxed to longer intervals (e.g., monthly, quarterly, or semi-annually). Subtitle D requires leachate removal and treatment when necessary to maintain head limitations, but does not require leachate monitoring. Both subtitles require a groundwater monitoring system to detect changes in water quality that may be related to a release.

3.3 Technologies

The literature research conducted for this report identified 13 technologies that either have been used to monitor the vadose zone beneath a liner or have the potential to do so. While three technologies were specifically intended for vadose zone containment monitoring, the remainder were designed for leak detection or moisture measurements in other industries (petroleum, chemical, agricultural, geological exploration). The technologies are not necessarily deployed in the same fashion, nor do they detect or measure the same aspects of a release.

3.3.1 Diffusion Hoses

Diffusion hose systems consist of a collection hose, pump, and detector. The collection hose is permeable to the chemical being monitored. When a release occurs, the chemical, which must have some volatility, diffuses into the air space in the hose. The pump pulls air through the hose and past the detector. Since the velocity of the carrier gas can be calculated, the location of the leak can be determined using the arrival time of the detected contaminant. Diffusion hose systems can be

constructed directly under a geomembrane liner. In double-liner systems, they can be placed both above and below the bottom liner, allowing leak locations to be determined in both liners.

Status. Diffusion hoses have been deployed at a number of petroleum and chemical facilities to detect releases from product pipelines and tanks as well as at several landfills in Europe.

General Attributes. Diffusion hose systems can be automated and set up to sound an alarm that a volatile substance is present in the collection hose or the hose can be connected to a gas chromatograph for contaminant identification. For best results, the system should be deployed beneath the liner during construction. Unless perimeter monitoring for soil gas monitoring is acceptable, the system would be difficult to construct under an existing unit. The equipment associated with diffusion hose systems is relatively rugged and can be easily replaced if needed.

Examples. An example of a diffusion hose system is the Siemens LEOS leak detection system, which has been deployed at several landfills in Germany (Siemens, 1998). The system consists of a permeable low-density polyethylene (LDPE) tube that fits around a perforated stiff core to provide strength (Figure 4). The LDPE tube is pressure tight at installation so air can only enter at the opening of the tube during purging. During a purge cycle, a pump pulls the contents of the tube through a detector that provides total concentrations and displays them in a format similar to a gas chromatogram. Before a purge cycle begins, an electrolytic cell injects a specific volume of test gas into the end of the tube. This gas acts as a marker and its appearance at the detector indicates that the entire tube has been purged. Based on the ratio of the travel time of the leak peak to the marker peak, the leak location can be calculated.

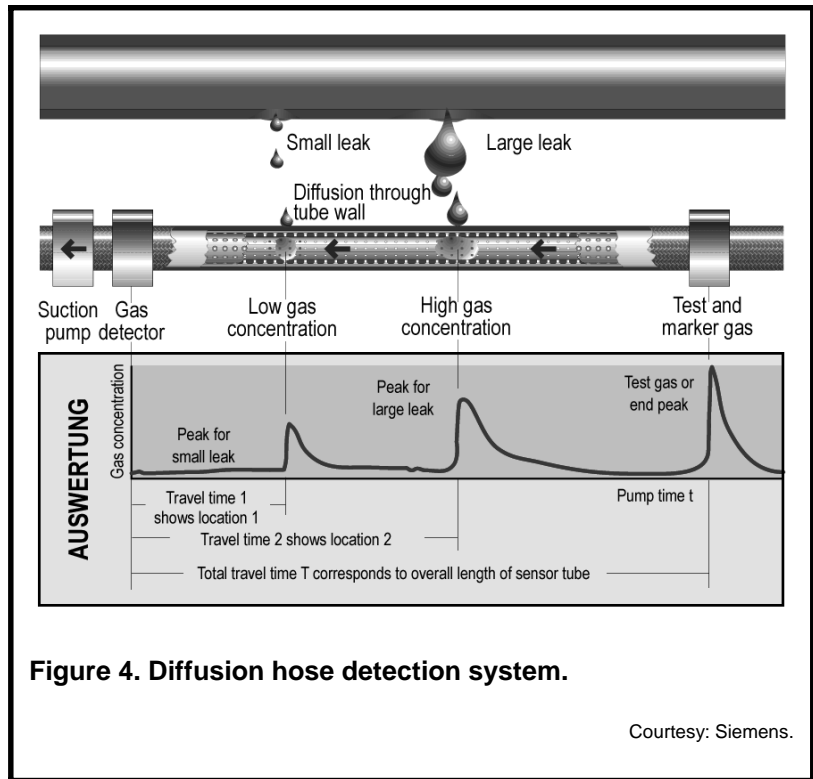

Figure 4. Diffusion hose detection system.

Courtesy: Siemens.

3.3.2 Intrinsic Fiber Optic Sensors (IFOS)

The IFOS are deployed in dry wells beneath or beside the containment unit. IFOS typically consist of a clad optical fiber that has had part of the cladding replaced with a chemically selective layer (Figure 5). The index of refraction of the chemically sensitive layer changes in direct proportion to the

concentration of chemicals in the air or water that comes in contact with it. As a chemical partitions into the layer, which selectively and reversibly adsorbs it, the change in the effective index of refraction is determined by measuring the amount of light transmitted through the optical fiber. The response is directly proportional to the concentration of the chemical(s) present. IFOS can detect chemicals (or classes of chemicals) of interest in the parts per million (ppm) range, which may be too high for some landfill vadose zone applications.

Status. The most prevalent use of intrinsic fiber optic sensors (IFOS) is in the petroleum and chemical manufacturing industries.

General Attributes. IFOS systems are generally automated and alarmed. In a hazardous waste impoundment where the contents are known, the chemically sensitive layer is chosen to match the chemical of concern. Deciding which chemicals or class of chemicals to monitor in a landfill with uncertain contents is more difficult. An operation and maintenance drawback of using IFOS at landfills is that the number of reversible reactions that include the adsorption and subsequent desorption of chemicals is limited; therefore, probes may have to be regenerated after extended use. The method of deployment makes retrieval and replacement of IFOS relatively easy.

Examples. No examples of IFOS deployment at landfill or impoundment units were identified.

3.3.3 Soil Gas

Soil gas detection systems rely on the movement of volatile chemicals through the vadose zone and into a collection system. These volatile chemicals can originate from vapors diffusing through the liner or as part of escaping leachate in which they are dissolved. The collection system can be active or passive.

Passive systems: There are two basic designs of passive soil gas systems. In the first design, a collector (typically an activated carbon ribbon or other sorbent material) is placed in a container that is closed at the top and open at the bottom. This container is then suspended in a dry well for a set period of time. After retrieving the container, the sorbent material is purged of the sorbed chemicals, which are analyzed using a gas chromatograph/mass spectrometer (GC/MS). In the second design, the collector is placed in a hydrophobic, gas-permeable material and suspended in the dry well. After a set period of time, it is collected and the sorbed chemicals are purged and measured with a GC/MS. A more recent modification of the passive system involves the use of fiber optic sensors that are placed in a probe or dry well where they periodically test the ambient gas for contaminants.

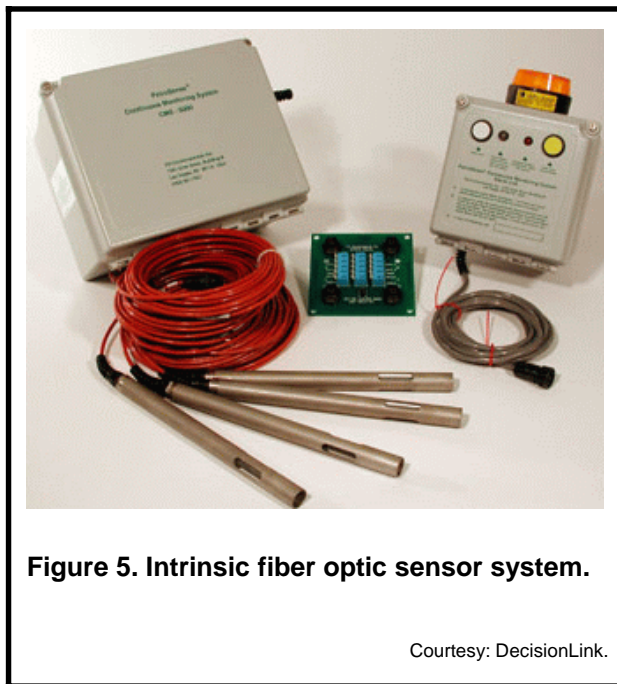

Figure 5. Intrinsic fiber optic sensor system.

Courtesy: DecisionLink.

Active systems: In an active soil gas system, a collection tube and/or probe are placed in a dry well and soil gas samples are removed under vacuum. Figure 6 shows a horizontally deployed, slotted conduit with varying lengths of probe-tipped tubing inside. The probes are placed at pre-determined distances in the conduit and sampled from a central sampling station. Deployment of soil gas systems in dry wells or horizontal screens should perform well, even in fine-grained soil, because the systems measure equilibration concentrations of well air with soil gas. However, the time from release to detection will be longer in fine-grained soils than in coarse-grained soils, and preferential channeling can defeat the system.

Status. Soil gas systems have been used primarily for characterizing hazardous waste sites and for detecting leaks in petroleum and chemical storage tanks. There are approximately 100 different soil gas sampling systems in existence (Looney and Falta, 2002).

General Attributes. Measurement of soil gas vapors is generally done by collecting samples from perforated piping placed under the landfill or from vertical dry wells placed at its perimeter. Generally, for large landfills, perimeter dry wells will not be able to detect leaks in a timely fashion. Lateral piping placed under the bottom liner should be designed similarly to the leachate collection piping in the landfill liner so that it can withstand landfill loading. The effectiveness of the soil gas monitoring system can be improved if the dry wells or perforated piping are emplaced with a layer of coarse-grained sand to facilitate vapor movement.

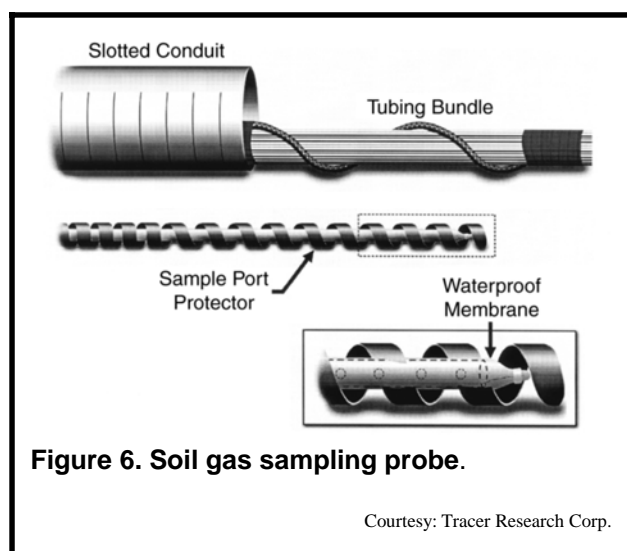

Figure 6. Soil gas sampling probe.

Courtesy: Tracer Research Corp.

Soil gas monitoring systems are generally easy to install and are accessible for repair and maintenance. Active systems can be automated and connected to total detectors, GC, or GC/MS units for speciation and quantitation. Operation of a total detection system requires minimal training, while GC/MS operation require a trained operator. The ability to detect and locate a release depends upon the spatial distribution of the dry wells and/or horizontally laid screens. The systems only detect volatile organic compounds, but generally have sufficiently low detection limits to detect the low levels found in MSW landfill leachates.

Examples. Soil gas monitoring systems in perimeter vertical dry wells have been used in California for containment units that were not constructed with vadose zone monitoring systems. They have also been used where groundwater is deep and monitoring wells are not likely to provide a good first warning system. For example, deep groundwater at the Kettleman Hills California hazardous waste facility necessitated the use of perimeter vertical dry wells. The dry wells are periodically sampled using a portable GC, that can identify the presence of volatile organics with parts per billion detection limits. If chemicals are found, the dry well can be immediately resampled for offsite analysis.

Several gold beneficiation facilities in California also use lateral, perforated, PVC pipe under containment units to monitor for cyanide releases. Soil vapors are pumped under vacuum out of the pipe and through a Draeger tube that tests for cyanide gas. The Draeger tube detection limit is in the 2 to 15 mg/m³ range. This deployment could conceivably be used in conjunction with GC or GC/MS equipment for monitoring multipurpose units.

3.3.4 Electrochemical Sensing Wire Cables

Electrochemical sensing wire cables all function on the same general principle. The cable contains at least two circuit loops—one of which carries an impressed current (continuity circuit), and the other is connected to an alarm. A leak is detected when the circuits are shorted (Figure 7), which can be caused by several mechanisms, depending on the cables used. For example, the short can occur when a leak of conductive fluid facilitates current flow between the cables (Figure 8). Shorting can also occur by direct wire contact. Direct wire contact results when the material separating the wires degrades allowing the wires to touch. Finally, the short can occur when an outer coating of the cables swells when brought into contact with the leak (Figure 9). The swelling forces the two wires together to complete the alarm circuit.

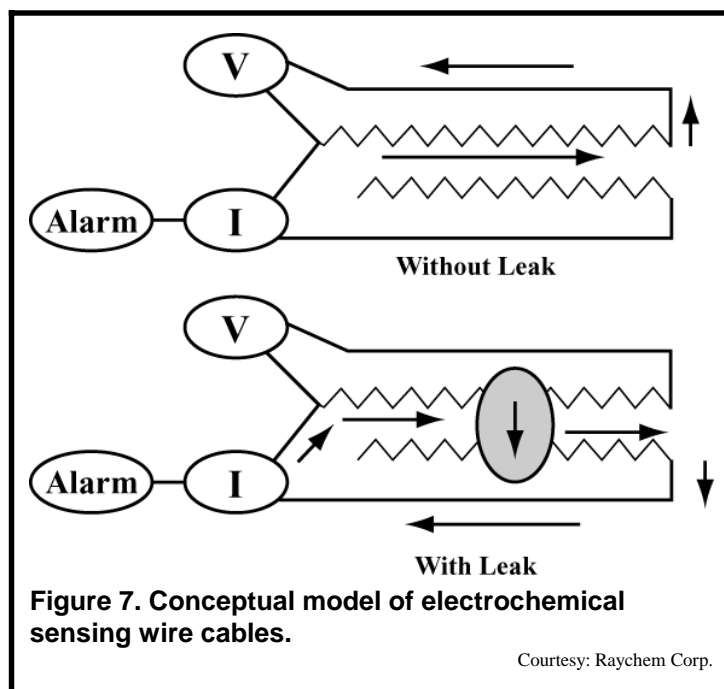

When small areas are being monitored, the system is usually set up to sound an alarm. When the monitored area is large, hardware is added that can also calculate the point of the voltage drop in the continuity line—thus, pinpointing the position of the leak. Conductive fluid cables generally can be dried and reused, while the swelling and degradation types must be replaced.

Status. Electrochemical sensing wire cables were originally designed to detect releases from product pipelines and storage tanks. Their primary market has been the petroleum and chemical industry, though the cables can generally be modified to detect water.

General Attributes. The various types of electrochemical sensing wire cables are all automated and require minimum maintenance and operator experience. When installed during the initial construction of a containment unit, the cables can be installed within a drainage layer. While this increases the cost of the monitoring system, it also improves its ability to locate a release. When the monitoring system is deployed as a retrofit, it can only monitor the area that drains to the cables. If the overlying soil is fine-grained, then wicking away from the cable's more permeable zone might delay the detection of a leak for some time. For access and operation and maintenance, the cables would have to be deployed in protective perforated piping.

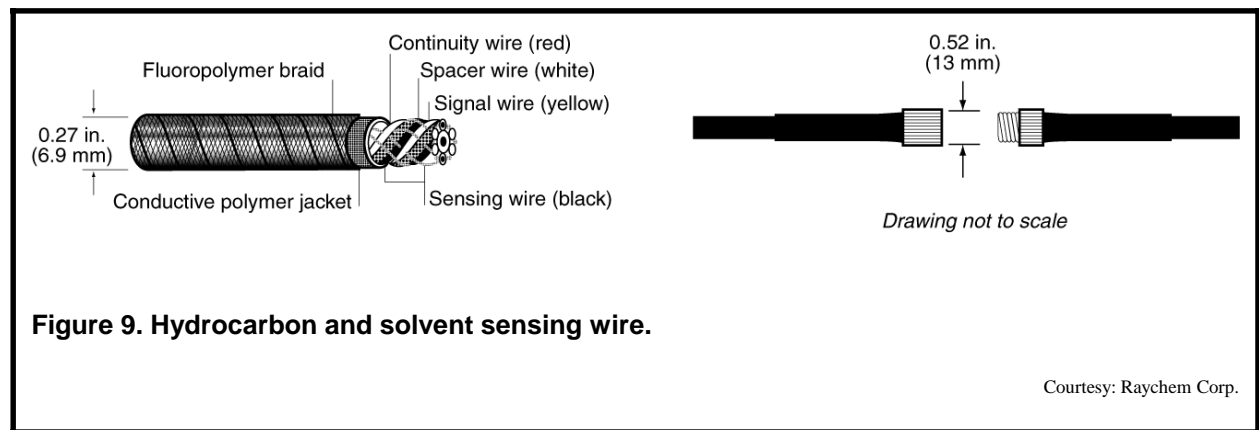
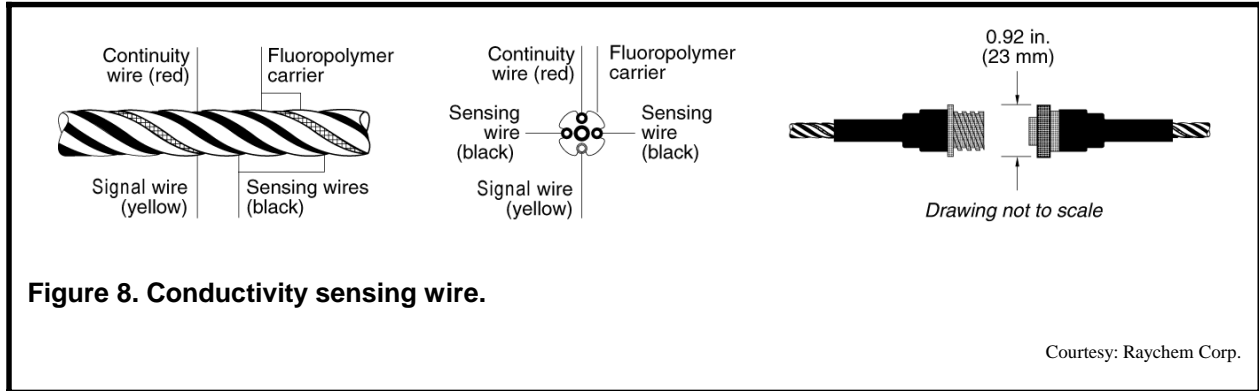

Examples. No examples of electrochemical sensing wire cable deployment at landfill or impoundment containment units were identified.

3.3.5 Time Domain Reflectometry Detection Cables

Time domain reflectometry measures an electromagnetic pulse sent down a coaxial cable to detect an impedance change or discontinuity. The electromagnetic pulse travels down the cable until a change in impedance is encountered. When this happens, part of the wave is reflected, and instrumentation at the input area measures the time it takes for the reflection (or echo) to reach a receiver. The measured time is used to compute the distance to the impedance change. Impedance changes can be caused by a number of physical changes in the cable. For chemical release detection cables, the change is generally caused when the impedance fluid (air) is replaced by a fluid having a different impedance, such as leachate, solvent, or contaminated air.

Status. Time domain reflectometry has been used extensively in the telecommunications industry for testing continuity in cable systems and for detecting unauthorized access to these systems. It is also used in the petroleum and chemical industries to detect releases of product.

General Attributes. Time domain reflectometry is an automated detection system that is easy to install and requires little operator training. When installed during the construction of a containment unit, it can be placed within a drainage layer. While this increases the cost of the system, it also improves its ability to locate the release. When the monitoring system is deployed as a retrofit, it can only monitor the area that drains to the cables, unless volatile organics are present. If volatile organics are present, the change in gas impedance might be sufficient to trigger a response from the system. If the source of the release is repaired, cables can be dried and reused. Because of loading from the landfill waste and maintenance concerns, the cables need to be placed in protective piping.

Examples. Although originally designed for use in the petroleum and chemical industries, Perma-Pipe, Inc., offers a product line called “PermAlert” that has been used for (1) monitoring miles of hazardous waste pipeline at the Department of Energy’s Hanford Reservation; (2) vadose zone leak detection under double-lined impoundments (e.g., acid ponds); and (3) for monitoring piping that carry leachate from landfills to a treatment system or holding impoundment. PermAlert has both wicking and non-wicking leak detection cables that are coated with polymers and are designed to detect water-based chemicals and/or hydrocarbon liquids. Time domain reflectometry sensing cables are constructed with an open architecture coaxial cable (Figure 10). A protective, permeable, nonconductive cover surrounds a wire mesh that is separated by an air pocket from a polymer coated copper wire. After installation, the cable has a characteristic impedance between the wire mesh and the copper wire. Any changes to this impedance brought about by breaks or intrusion into the cable, or as is the case of the PermAlert, by the replacement of the interstitial air by a fluid, can be detected using standard time domain reflectometry instrumentation.

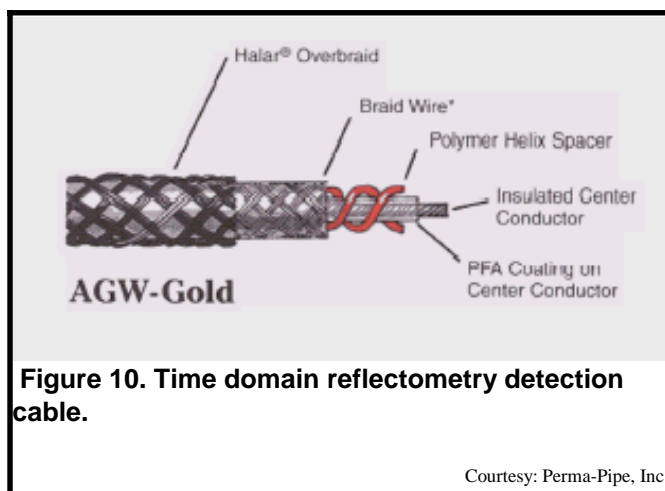

3.3.6 Electrode Grids

Electrode grids can be used to test for liner flaws immediately after construction and to conduct long-term performance monitoring at a containment unit. During construction of the containment unit, individual electrodes are placed in a conductive layer beneath the lower geomembrane liner and compacted soil layer. The electrodes are connected to one of a number of multicore cables that run to a central processor. A source electrode is placed in the protective sand overlying the geomembrane liner. Electrode grids can be configured to measure the electrical potential caused by electrical current flowing through leaks or to measure changes in the localized resistivity of the conductive layer caused by fluids flowing through the leaks.

Status. Electrode grids were designed specifically for landfill vadose zone monitoring. As of 1999, over 120 of the electrode grid-type systems had been installed, mostly in Europe (Peggs, 1999).

General Attributes. An electrode grid system can only be installed during the initial construction of the unit. It uses simple, durable parts. Electrodes made of high-grade, stainless steel alloy or non-corrosive, liner compatible conductive HDPE are less likely to fail before the design life of the facility. Electrode grid systems cover the entire area beneath a containment unit and can be used to both identify releases and track their migration in the subsurface. These systems can be continuous and require a trained operator.

Examples. An electrode grid system was deployed in 1995 at the Sandy Hill Landfill in the United Kingdom. A simple mathematical model and small-scale testing were used to determine the electrode spacing, which consists of parallel lines of electrodes spaced 20 m apart. Spacing between electrodes within a given line alternates between a line on 20-m centers and a line on 10-m centers (Figure 11). The 316 stainless steel electrodes were placed in the base of a 300-mm-thick, bentonite-enhanced sand

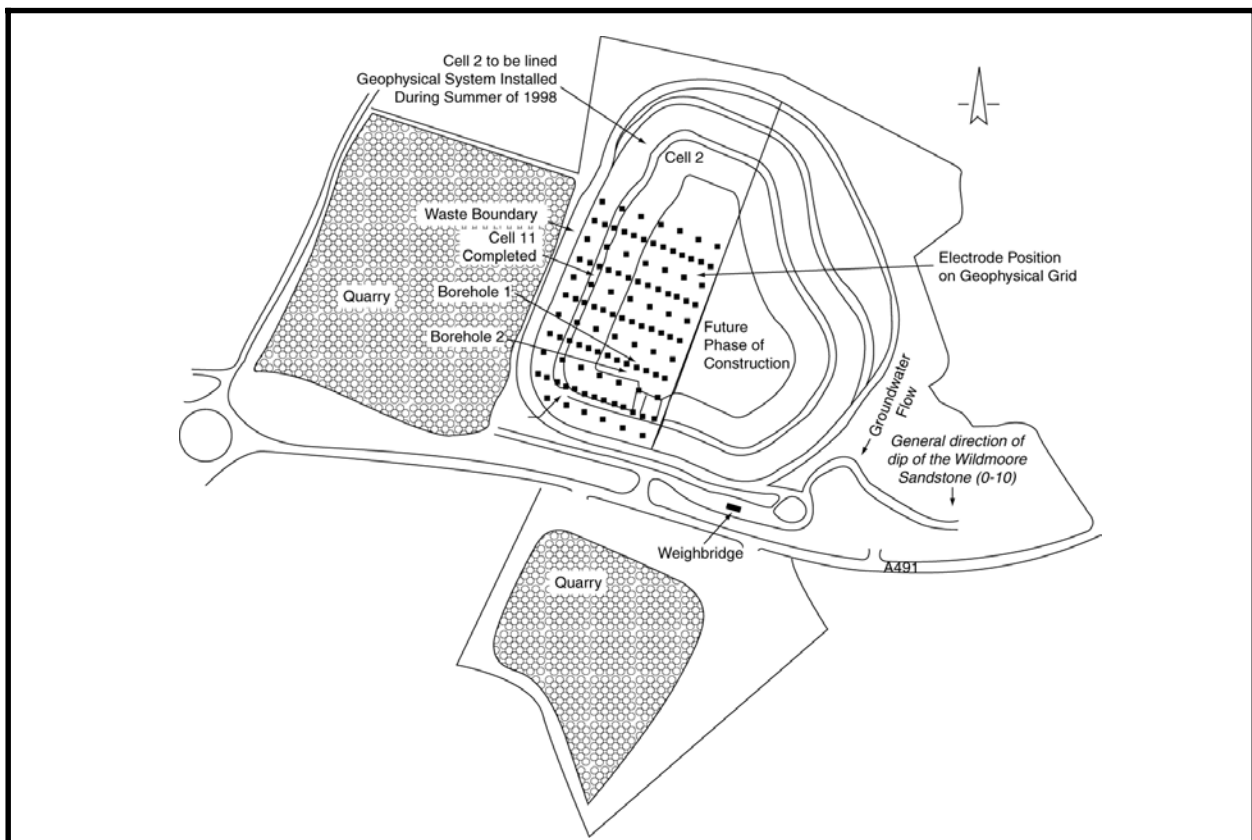

Figure 11. Sandy Hill Landfill geophysical electrode grid and borehole installation.

Reprinted from *Ground Water Monitoring & Remediation* with permission of the National Ground Water Association. Copyright 1997.

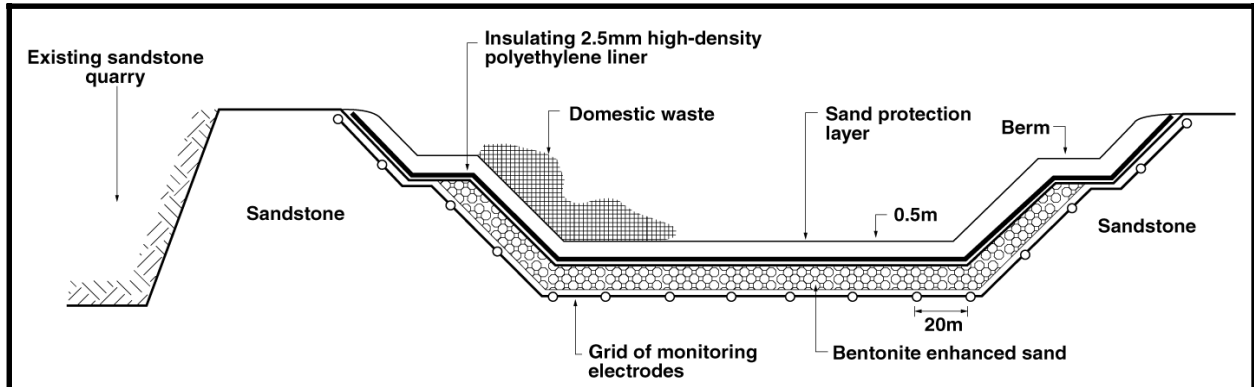

Figure 12. Cross-sectional view of Sandy Hill Landfill and geophysical electrode grid.

Reprinted from Ground Water Monitoring & Remediation with permission of the National Ground Water Association. Copyright 1997.

that makes up the bottom layer of the composite liner. A 2.5-mm thick HDPE liner overlies the bentonite-enhanced sand and is covered by a 500-mm layer of protective sand (Figure 12). The electrodes are connected by multicore cables that lead to a portable computer for processing data and a Campus Geopulse earth resistance meter. The liner was tested using the electrode system prior to accepting waste in the landfill. The test revealed an anomaly within one of the 20-m grid squares (Figure 13). Testing with a hand-held voltmeter located the anomaly within 2 cm, and the soil cover was removed to reveal two knife cuts. As the landfill accepted waste, the protective sand layer was applied higher and higher on the berm sides. The sand layer provided a conductive material that allowed the liner on the upper portions of the berm to be tested. Tests revealed two more holes. Testing of the 3-hectare cell takes approximately 1 to 2 hours. For more information, see White and Barker, 1997.

The system can detect a release from the overlying liner and track the progress of the leachate plume as it moves through the soil beneath the liner. Resistivity data were collected and archived before the landfill began operating. These data are compared to resistivity data measured during landfill operation to identify any substantial changes that would indicate a release.

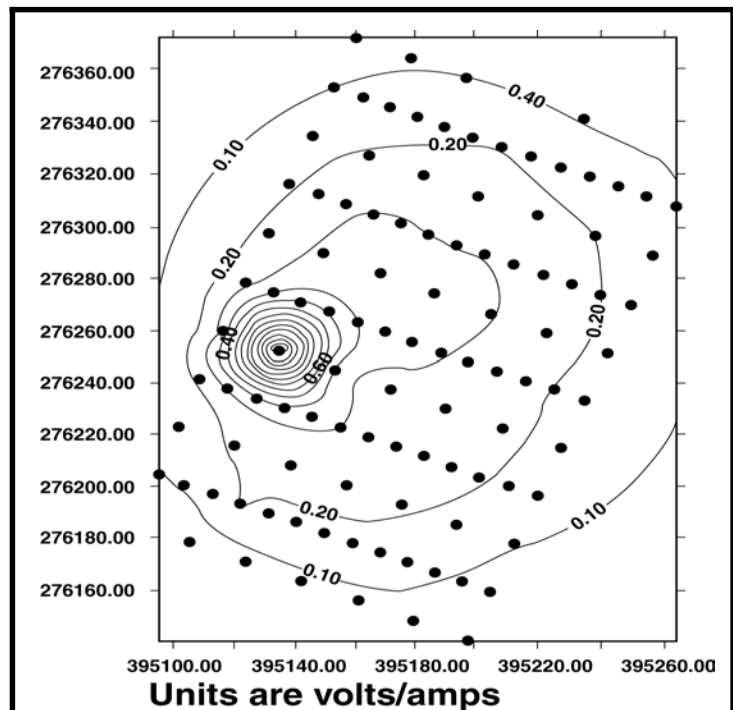

Figure 13. Sandy Hill Landfill electrical anomaly.

Reprinted from Ground Water Monitoring & Review with permission of the National Ground Water Association. Copyright 1997.

Welsh Engineering Science & Technology, Inc. (now SRK Consulting) developed and patented an electrode grid called the Electronic Leak Detection System (ELDS) for detecting leaks below heap leaching containment units used in the gold mining industry. The first deployment of ELDS occurred in 1987, and at least 12 have been deployed since. The company, G2 Imaging, installed ELDS under a leach pad liner in northern Nevada. The system consists of 147 stainless steel electrodes placed in a rectangular grid beneath the liner. Two PVC pipes also were installed to calibrate the system by injecting a salt solution. The system, which consisted of an array of 215 monitoring points, was able to detect a hole that was purposely placed in the liner as a test.

After ore was placed on the leach pad and the leaching process began, the system was monitored biweekly using an Iris Instruments Syscal Junior resistivity meter. ELDS software downloaded the data from the receiver and produced contour and three-dimensional surface plots of the data. The ELDS detected four separate leak locations. Each location was excavated and the holes were repaired; however, upon rewetting, the system again indicated leaks in the same areas as before. A more careful check of the excavated areas revealed additional holes. After these repairs, the response of the ELDS to the gradual drying of the soil beneath the liner indicated the liner was effectively repaired.

3.3.7 Portable Electrical Systems

The portable electrical system involves transmitting an electrical current from an electrode in a conductive medium above the geomembrane liner. A second electrode is placed in the material (which must be conductive) below the primary geomembrane liner in a double liner system, or in the case of a single liner, grounded at the containment unit perimeter. When a current is applied to the first electrode, current leaks through any breaks in the liner. The leakage is detected by gridding the surface and conducting a survey with a hand held probe and digital recorder. The probe can locate the release with excellent accuracy. Use of this system is generally limited to construction quality assurance in landfill operations because the probe is sensitive to the vertical distance from the release area. While there have been some investigators who report leak identification in fill up to 15-20 feet in depth (Peggs, 2001a), this system should not be thought of as a long-term landfill monitoring method. Surface impoundments, on the other hand, can be periodically drained to make them wadeable or the probe can be towed across the bottom by a boat.

Status. The portable electrical system (Figure 14) was commercialized in 1985 and has been used at hundreds of sites (Coluci et al., 1996, and Darilek and Lane, 1999). The system was developed as a quality assurance measure for testing newly installed liners at landfills and impoundments, but it can also be used for long-term monitoring at surface impoundments. More than 20 companies worldwide offer these systems.

General Attributes. Portable electrical systems are well understood among geophysicists. They are easy to install or retrofit.

Examples. The Electrical Leak Imaging and Monitoring System developed by Leak Location Services, Inc. was used to locate a leak at a hazardous waste landfill that accepted stabilized treatment residues and soils. Two 80-mm long cuts were found under 3 m of waste and were subsequently repaired by the owner/operator. The system used a generating electrode in the leak detection layer with a sink electrode located in the waste. In a variation of the normal survey technique, a reference electrode was also

placed in the waste and the gridded survey potentials were compared to it using a mathematical algorithm (Laine, Binley, and Darilek, 1997a and 1997b) .

No examples of this system being used for long-term performance monitoring were identified.

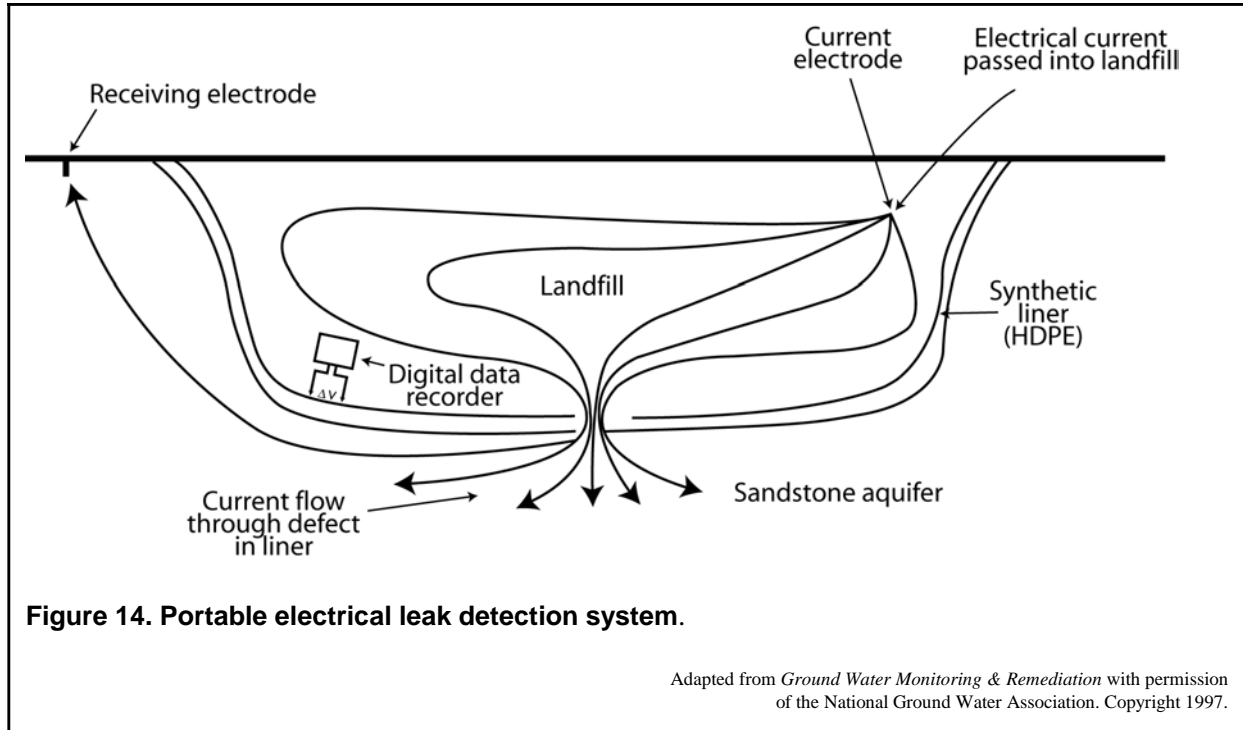

3.3.8 Moisture Measuring Devices

There are a number of moisture measuring devices that either directly or indirectly measure soil moisture content or soil water potential. Many of these devices have been thoroughly tested in other applications; some were developed for agricultural applications, while others are traditional borehole geophysical techniques used in geological exploration. The summary of devices below (capacitance sensors, lysimeters, neutron probes, and advanced tensiometers) is not meant to be comprehensive. It includes only those techniques that have actually been deployed (primarily in California) to measure vadose zone moisture beneath a landfill.

Moisture monitoring devices are widely available, generally easy to install, and most do not require highly skilled operators. Although some can be retrofitted after a containment unit is constructed, it is best to install them during construction. The devices typically only measure moisture content in a small area around them or require direct contact with percolating water.

Capacitance Sensors

Capacitance sensors use frequency domain induced polarization to measure the dielectric of the soil around them. The dielectric properties of soil are primarily related to its water content but also could be affected by the ionic content of the water. The dielectric of dry soil is approximately 5, and the dielectric of water is approximately 80. When soil becomes moistened by a leak, its dielectric increases. Measuring the dielectric over time will reveal whether the soil is becoming wetter or drier. The sensors are calibrated and implanted in the ground at the desired depth. They can be permanently or temporarily installed.

Status. The primary use for capacitance sensors is the measurement of field moisture in agricultural applications, although they also have been used in construction applications.

General Attributes. Capacitance sensors must make good contact with the surrounding soil. As a result, they may be difficult to install in some soils. Capacitance sensors can be operated continuously, need relatively unskilled operators, and provide accurate values for soil moisture. As the soil moisture increases however, their accuracy decreases. Their long-term reliability and ability to maintain calibration is uncertain, especially in water with varying ionic concentrations (U.S. EPA, 1993b).

Examples. Troxler Electronic Laboratories, Inc., produces the Sentry 200 series of capacitance sensors for use with environmental moisture monitoring systems. A Sentry 200 system was installed at the San Marcos Landfill in San Diego, California, in 1995. The system contains sixty probes and eight

monitoring units. Each probe measures the dielectric of approximately 1.5 liters of soil surrounding it. The probes are 261-mm long, 51-mm wide, and weigh 3.6 kg (Figure 15). They can operate in temperatures ranging from 0-70°C. The outside of the probe is constructed of stainless steel, HDPE, and fiberglass filament making it resistant to corrosion and breakage. The probes are connected to the monitoring units by coaxial cable. The personal computer, which has downloading capabilities, can be run on DC or AC power. The total cost of the project, including equipment, engineering, and installation, was \$219,000. The system automatically measures moisture levels four times per day, and the data are down-loaded biweekly. Performance has been good except compression pressures from the overlying fill have broken the wiring connections to several of the capacitors.

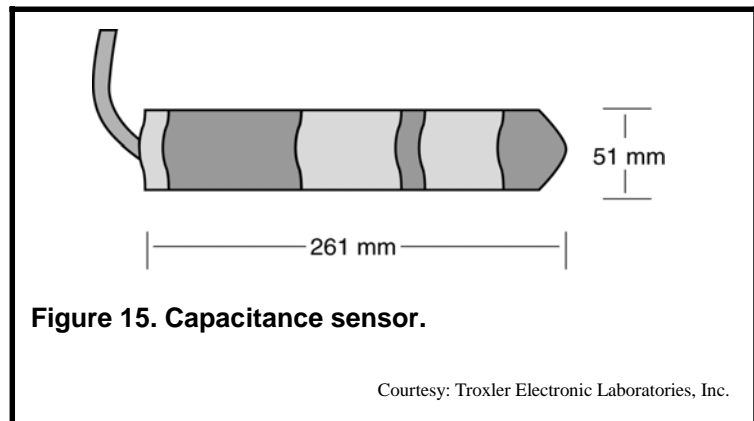

Lysimeters

Suction lysimeters are used to sample soil pore water, which is generally under negative pressure (non-flowing). In addition to being capable of obtaining water samples, suction lysimeters can be used to evaluate whether soil is gaining or losing moisture. Typically, suction lysimeters are constructed of a porous ceramic bulb and a cylindrical reservoir to store the water. For shallow applications, they are

usually equipped with a tube that extends to the surface. A vacuum is applied to this tube to draw water through the bulb, into the reservoir, and to the surface. For use at lengths or depths greater than 4.5-6 m, suction lysimeters can be equipped with two tubes. The two-tube arrangement allows for a vacuum to be applied to draw water into the reservoir, followed by air pressure to transport it to the surface. To function properly, a good hydraulic connection between the ceramic bulb and the surrounding soil must be established—usually by placing the bulb in a layer of silica flour during installation (Figure 16).

Plate/pan lysimeters are covered containers that collect water that percolates through the vadose zone and comes in contact with the permeable covers. The container is connected to a tube that leads to a sampling point on the surface. The water is generally withdrawn from the container by pumping.

Status. Lysimeters are primarily used in agricultural and forestry applications. There are two basic designs: those that sample soil moisture in unsaturated conditions (e.g., suction lysimeters) and those that sample in saturated flow conditions (e.g., plate lysimeters).

General Attributes. Lysimeters have a limited range of influence and should be placed in areas most likely to experience a release, such as under pump sumps. Because they are very difficult to retrofit, lysimeters ideally should be installed during landfill construction. While the required operator skill is minimal, lysimeters are generally not automated, so sample collection can be time consuming. Typically, the volume of the water sample collected is not large, which limits the number of chemical analyses that can be performed. In addition, the ceramic cup is subject to mineralization and clogging, and depending on the installation technique used, the suction lysimeter may not be retrievable.

Examples. A redundant vadose zone system that included pressure/vacuum suction lysimeters, gypsum blocks, neutron probe tubes, and soil gas sampling points was installed at a landfill in California (Cullen et al., 1994). The gypsum blocks were used to monitor potential problems at the seam joints along Module III (Figure 17), and were not intended for long-term monitoring. The design of the monitoring system also included a neutron probe access tube that extended under and down the center of each of the three new cells. The leachate collection system of each cell drained to the center of the cell and then to a sump. The trench in which the neutron probe access tube was installed also housed the soil gas and lysimeter sampling tubes (Figure 18). Horizontal soil gas wells were placed at equal alternating intervals, 38 m apart along the trench. The wells consisted of a 15.25-m long horizontal trench placed just under the compacted clay of the composite liner. Within each trench, five sections of alternating schedule 80 PVC casing blanks and screens (20-slot) were installed and surrounded with drainage gravel. The sampling tubes for the soil gas samplers in these dry wells were routed to the neutron probe trench and then routed to a sampling station outside the containment module wall. The soil gas was drawn from each sampling station and tested with a portable GC.

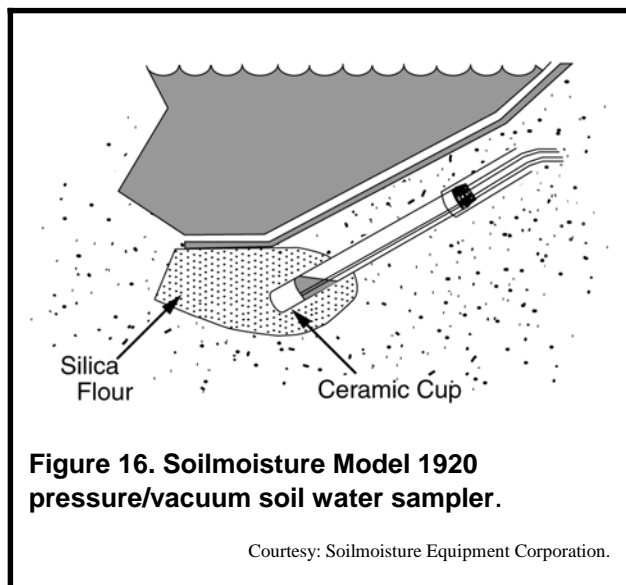

Lysimeter placement at the landfill was based on an evaluation of the subsurface soil beneath the modules. Cullen et al., recommended placing pressure vacuum lysimeters in areas most likely to receive preferential flow from a release. For example, if the subsurface soil consisted of interbedded clays and sands, the lysimeter would be placed in the first sand layer overlying a clay to maximize the potential to detect leaks. In addition, the distance and depth of the lysimeter influenced the type of lysimeter chosen. When the distance to the lysimeter was large, high-pressure vacuum lysimeters were used.

Lysimeters were placed 15 m from the two containment walls and beneath the neutron probe trench to detect potential movement of liquids along the top of a fine-grained soil interval. The lysimeter sampling tubes were routed through the piping containing the soil gas monitoring tubes, which were routed to the sampling stations.

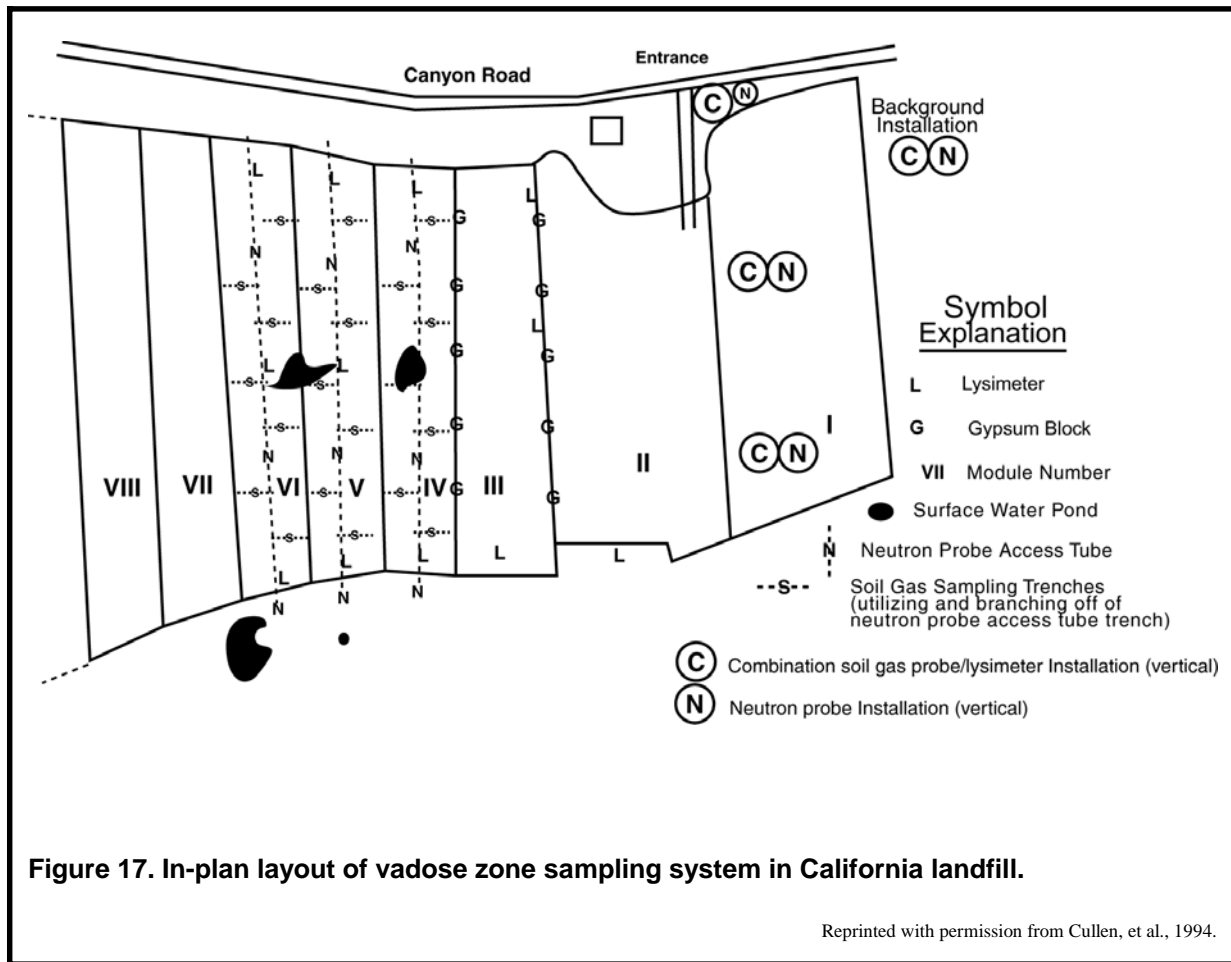

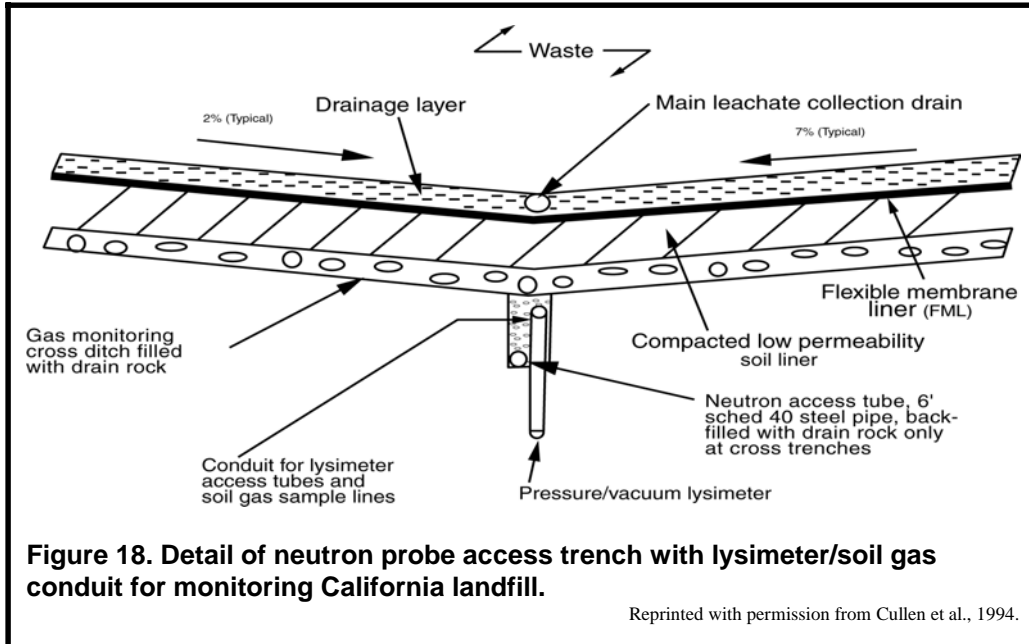

Neutron Probes

A neutron probe contains a neutron source (usually americium-241/beryllium) and detectors. The detectors measure the number of neutrons that are back-scattered from interactions with hydrogen atoms in the surrounding soil. Neutron collisions with hydrogen produce a characteristic slowing down or “thermalizing” of the neutron. These thermalized neutrons are counted by the detector. Since most naturally occurring hydrogen in the Earth’s crust is associated with water, the count can be directly related to the amount of water in the formation. To obtain moisture values, the probe is pulled through a casing, and a reading is taken at preset intervals. The time taken for each reading determines the precision of the reading—the longer the count time, the better the precision. When the count is completed, the probe is moved to the next measurement position (Parasnis, 1997).

Status. The neutron probe is a standard downhole geophysical instrument used for measuring moisture content in the immediate vicinity (6-12 inches) of a borehole wall. The borehole can be cased or open.

General Attributes. Casings for neutron probes can be installed before construction of the liner or retrofitted by drilling a horizontal or angle boring. Although operator skill requirements are low, neutron probes cannot be automated. The operator must pull the probe through each casing to obtain readings, which can be time consuming. Neutron probes provide information on changing moisture content in the immediate vicinity of the casing, not on chemical speciation or concentration.

Examples. A vadose zone monitoring system that uses neutron probes is operating at two RCRA hazardous waste management cells at the Safety-Kleen facility in Westmoreland, CA. One was installed at an existing cell. An approximately 50-ft long borehole was drilled at an angle under the cell on each side for installation of the casing. The second cell was constructed with three, approximately

730-ft long, access tubes equally spaced under the liner system. Neutron probe measurements are taken quarterly at 10-ft intervals in the 730-ft tubes and at 2.5-ft intervals for the inclined tubes using a Boart Longyear CPN® 503 DR Hydroprobe®. The Hydroprobe uses an americium-241:beryllium source with a helium-3 detector. The soil volume for each measurement is approximately spherical with a radius of 15 cm.

Sandia National Laboratories (SNL) in Albuquerque, NM, has constructed a 200-by-300-ft RCRA (Figure 19) corrective action management unit (CAMU). Because the depth to groundwater at the CAMU is 500 ft, SNL obtained a waiver from the State of New Mexico for installing a groundwater monitoring system. The approved vadose zone monitoring system consists of five lateral vitrified clay pipes placed directly under the unit's geomembrane composite liner. These pipes provide access for a neutron probe. In addition to the neutron probe, five vertical 15-ft deep boreholes were drilled on approximately 40-ft centers along the two outer access pipes. Similar to the access pipes, these holes are directly below the liner system. Two instrument arrays were placed in each borehole. The arrays consist of a time domain reflectometry probe, a thermistor temperature probe, and a soil gas sampling tube. One array was placed in the native soil at the base of the borehole, and the second array was set 5 ft below the base of the liner in borehole backfill. Monthly monitoring will occur for a year prior to placement of waste to establish a base line. Monthly monitoring will continue for as long as the unit is active; then the system will be monitored quarterly for the first three years after closure. The frequency after three years will be negotiated (Studer, 2000).

Advanced Tensiometers

Tensiometers consist of a porous cup or plate, a pressure sensor, and a reservoir of water connecting the two. The instrument is placed in a pre-drilled hole to ensure intimate contact between the cup and the soil. The soil, unless fully saturated, pulls water from the reservoir through the porous cup until a pressure equilibrium is attained. The partial vacuum caused by the loss of water in the tube is read by a vacuum gage or transducer. This reading can be related to soil moisture content. If the moisture content of the surrounding soil increases, the instrument draws in water and the vacuum pressure decreases. Traditional tensiometers are generally limited to several meters in depth. The advanced tensiometer (Figure 20) is designed to overcome this depth limitation and has been used to depths greater than 60 meters.

Status. While traditional tensiometers are well established for measuring soil water potential,

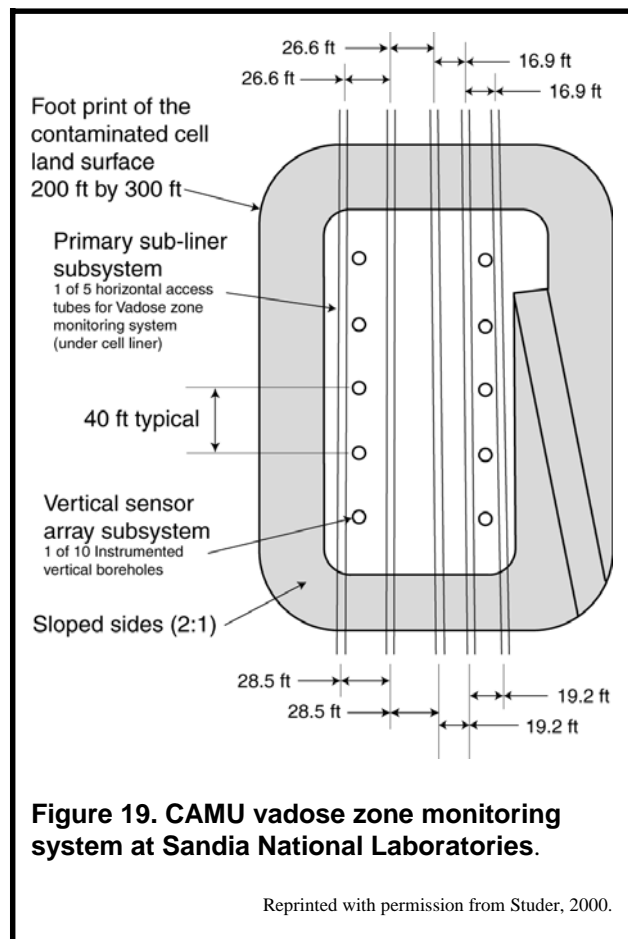

particularly for agricultural uses, advanced tensiometers are a more recent development. They are available commercially, but the number of vendors is more limited than for those designed for agricultural use.

General Attributes. Advanced tensiometers are placed in pre-drilled holes (generally 3.6 cm or greater). They also can be nested in a larger borehole so multiple depths can be measured. The measurement gauge is a downhole pressure transducer that can be queried automatically at preset intervals by a data logger located at the surface. Because of its depth of operation and the location of its instrumentation downhole, it is not subject to diurnal temperature and barometric pressure fluctuations. Access to the installation is required for periodic transducer maintenance and replenishment of the water reservoir. The instrument can be installed in directionally drilled holes or horizontal ones as well as vertical holes. Optimum interpretation requires calibration with site-specific soils, and tensiometers in general are not accurate in dry soils. More information is available at <http://tech.inel.gov/tech-detail.asp?id=50>.

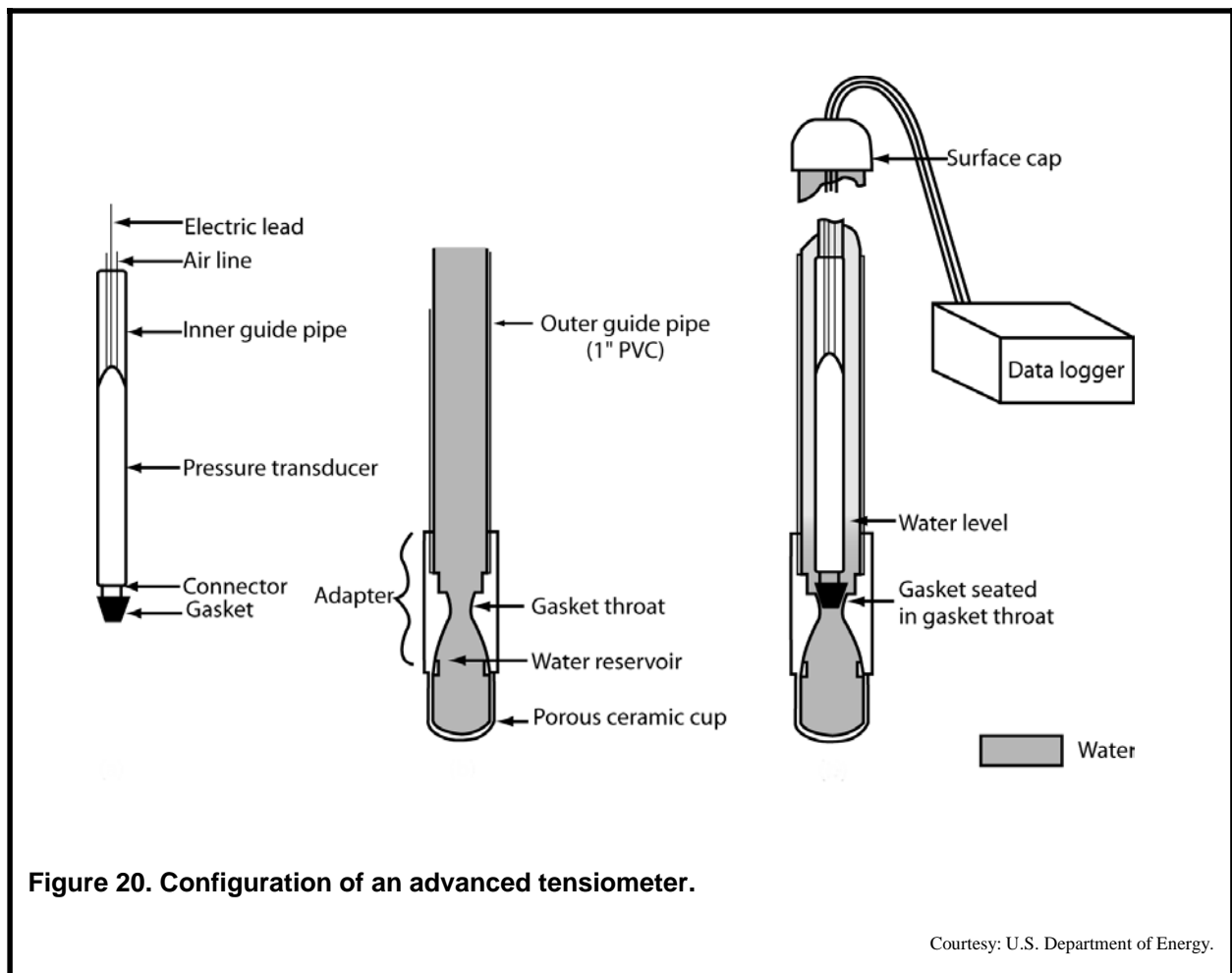

Examples. While the technology has been demonstrated at several sites, no long-term monitoring examples were found.

3.3.9 Wire Net Designs

The wire net design consists of two arrays of parallel stainless steel wires arranged orthogonally and separated by a thin layer of a permeable, but resistive material, such as sand. A multi-core cable connects each wire to measurement equipment (Figure 21). The released material must provide an electrical contrast to the sand. The system checks for all possible combinations of shorting in the grid and, in doing so, can accurately identify where a release has occurred. An alternative design positions the wires located immediately above and below the geomembrane liner. A leak causes the resistance between the nearest wires to decrease significantly.

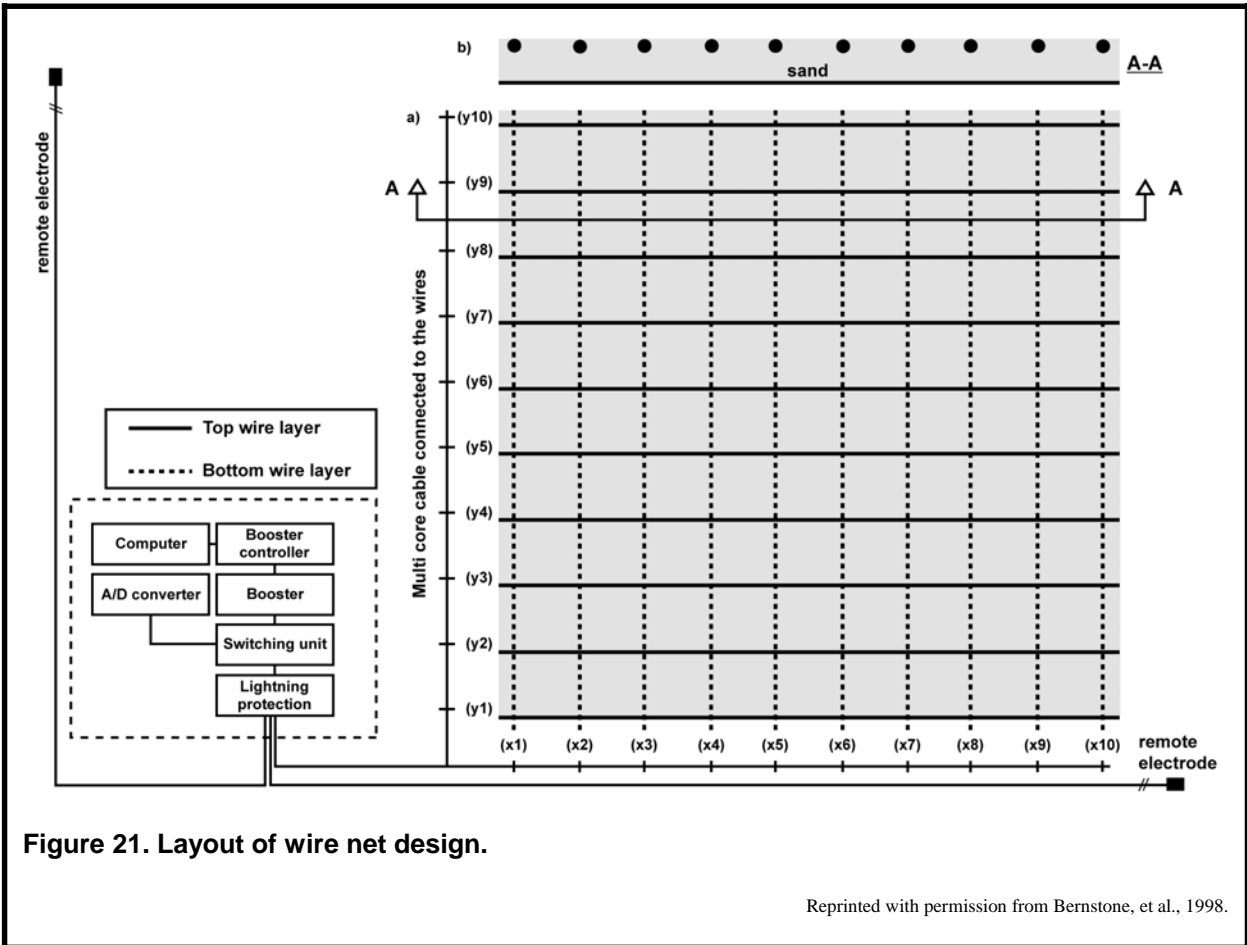

Figure 21. Layout of wire net design.

Reprinted with permission from Bernstone, et al., 1998.

Status. The wire net design was specifically developed for vadose zone monitoring at containment sites. It is estimated that fewer than five have been deployed (Peggs, 1999).

General Attributes. Wire net designs are easy to construct and made of relatively inexpensive materials. They must be installed when the containment unit is built. Generally, a trained operator queries the system daily.

Examples. A pilot wire net design system was deployed in 1997 beneath a brine pond liner at the Fibrona landfill in Southern Sweden (Bernstone et al., 1998). The system consists of two sets of parallel wires on 0.5-m centers placed orthogonal to each other and separated by an 11-cm thick compacted sand layer.

3.3.10 Cable Network Sensors

Cable network sensors consist of a network of moisture-sensitive, flat-band, radio frequency cables calibrated relative to water content. They can be installed above, in, and under a clay-mineral layer. Unshielded flat-band cables measure electric loss, signal velocity, phase shift, ability of signal transmission, and reflection, which are modified by the clay-mineral layer. These parameters can be used to calculate the complex dielectric coefficient of the material. By using several redundant measurements and cross-talk between cables, it is possible to design a cable sensor with a length of 10 m or more.

Status. Cable network sensors monitor the water content of clay-mineral liners. They are used as an indirect warning of possible leaching through the compacted clay. The technology is in the experimental stage and has not been commercially deployed.

General Attributes. While relatively simple to install, cable network sensors can only be deployed when the containment unit is being constructed. Interpretation of the data requires a trained operator. The system requires calibration using an independent standard, which may not reflect soil moisture content across the unit.

Examples. The Karlsruhe Research Center (KRC) in Karlsruhe, Germany, is testing a flat-band cable sensor that is suitable for installation in the bottom layer as well as the side and top layers. They expect to install a 20-m long cable network sensor to determine variations in the water content of approximately 3 percent by volume with a spatial accuracy of approximately 4 m in the clay-mineral layer (Figure 22). Because the cable sensor is a relative measuring device, it needs calibration from other absolute data. Therefore, investigators plan to combine the cable sensor technology with a cryo-moisture sensor (LUMBRICUS) developed at KRC. The moisture sensor calibrates itself in-situ without disturbing the measurement volume and without any laboratory preparation. This sensor also measures density and can detect expansion and contraction

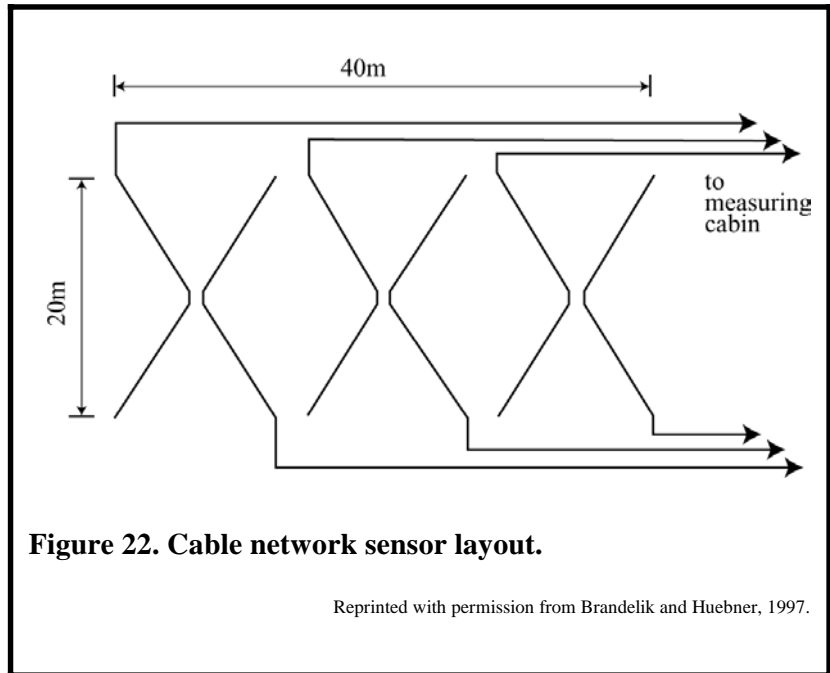

Figure 22. Cable network sensor layout.

Reprinted with permission from Brandelik and Huebner, 1997.

cycles of the clay barrier. KRC installed a prototype of their system in an approximately 2,000-m² clay surface barrier in Karlsruhe, Germany. The calculated costs for acquisition, installation, and operation during the first year were \$4 per square meter. For more information, see German patent 19,501,196 and Brandelik and Huebner, 1997.

4.0 FINAL COVERS

As discussed in Section 3, active landfills are open to the atmosphere, which allows precipitation to enter and interact with waste to form leachate. The liner system must contain the leachate until it can be removed and treated. Once a landfill cell is full, a final cover is placed over the waste to prevent additional water from entering and generating more leachate. By preventing the entrance of water into the landfill, eventually all the liquid in the landfill will be collected and treated, and the liner will no longer need to act as a barrier to leachate migration. Some landfill owners minimize the amount of leachate generated during the active life of a landfill with a “cover as you fill” strategy in which waste is covered as soon as a section of a cell is complete (EPA 2002).

4.1 Design

The design requirements for hazardous waste (RCRA Subtitle C) covers are performance based and are not prescribed by specific regulations. The covers are designed to:

- Minimize migration of liquids long-term.
- Function with minimum maintenance.
- Accommodate settling and subsidence.
- Have a hydraulic conductivity less than or equal to any bottom liner or natural subsoils present.

MSW (RCRA Subtitle D) covers function the same way, but have more specific design requirements (U.S. EPA, 1985a; 1985b; 1987; 1989a; 1991; and 1993a).

Because the design of a final cover must consider climate, waste characteristics, and other site-specific conditions, the minimum design recommendations may be altered provided that the alternative design meets the intent of the regulations. For example, freeze/thaw cycles will damage a cover’s compacted soil layer. Hence, in northern parts of the country where the soil can freeze to depths greater than 60 cm, a thicker vegetation/soil layer is needed to protect the compacted soil layer. Although other layer types may be called for on a site-specific basis, the most common optional layers are used to collect gases and create a biotic barrier to prevent the intrusion of plant roots or burrowing animals.

4.1.1 RCRA Subtitle C

Since they are used for hazardous waste containment, Subtitle C covers are the most protective and expensive to install. EPA issued minimum design guidance for covers under Subtitle C. The recommended design, as shown in Figure 23, consists of the following layers:

- Low Hydraulic Conductivity Geomembrane/Soil Layer: A 60-cm layer of compacted, natural, or amended soil with a hydraulic conductivity of 1×10^{-7} cm/s in intimate contact with a minimum 0.5-mm (20 mil) geomembrane liner (60 mil if the liner is HDPE).
- Drainage Layer: A minimum 30-cm layer of soil having a minimum hydraulic conductivity of 1×10^{-2} cm/s, or a layer of geosynthetic material having the same characteristics. The drainage layer should be covered by a sand filter or geosynthetic filter layer.

- Top, Vegetation/Soil Layer: A top layer with vegetation (or an armored top surface) and a minimum of 60 cm of soil graded at a slope between 3 and 5 percent.

4.1.2 RCRA Subtitle D

As specified in 40 CFR 258.60(a)(1-3), a Subtitle D cap must, at a minimum:

- Have a permeability less than or equal to the permeability of any bottom liner or natural subsoils present, or a permeability no greater than 1×10^{-5} cm/s, whichever is less.
- Minimize infiltration through the containment unit using an infiltration layer that includes a minimum of 45 cm of earthen material.
- Minimize erosion of the final cover using an erosion layer that contains a minimum of 15 cm of earthen material capable of sustaining native plant growth.

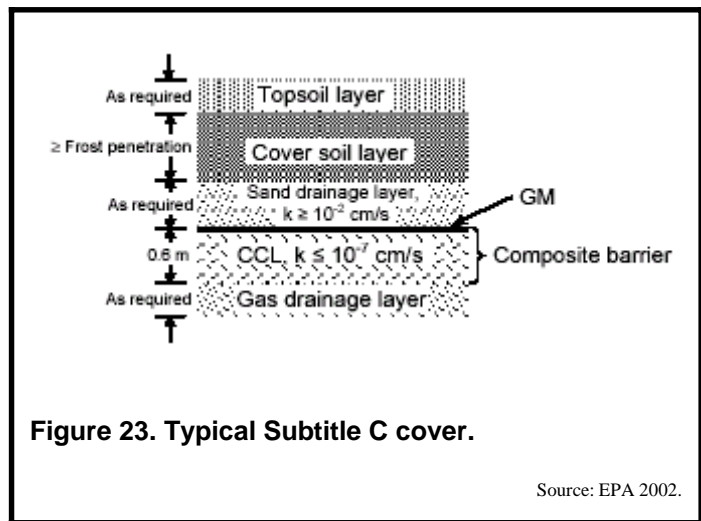

Hence the minimum profile for a Subtitle D cap is a 15-cm vegetative erosion layer over a 45-cm engineered soil infiltration layer (usually a composite barrier of a geomembrane [GM] and compacted soil) that blankets the waste (Figure 24). Typically cover designs include other components, such as a drainage layer and gas collection system.

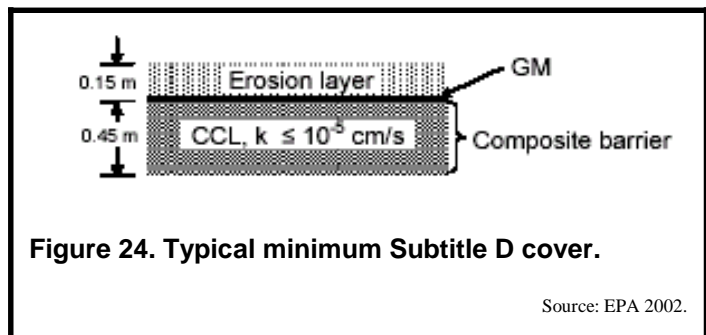

4.2 Monitoring

Subtitles C and D do not specify any direct monitoring requirements for covers. They do, however, require that the integrity and effectiveness of the final cover be maintained. Maintenance could include a monitoring or inspection system to detect the effects of settlement, subsidence, erosion, or other disturbances, and prevent run-on and run-off from eroding or otherwise damaging the final cover. Subtitle D requires a gas monitoring system to ensure that no dangerous buildup of methane gas occurs.

While the federal regulations do not require monitoring systems for covers, some states, like California, do require them. California Title 23, Division 3, Chapter 15, Article 9, Section 2597(b) has a performance requirement for cover monitoring that applies to landfill areas that will be redeveloped for purposes other than non-irrigated open land. The owner/operator must provide a water balance study (an evapotranspiration study that shows that irrigation water plus expected precipitation will not impact the liner integrity) at the site and detailed design plans and description(s) of the monitoring system(s) that will effectively detect penetration of the final cover by precipitation or applied irrigation waters.

4.3 Leachate Inventory and Survey

Long-term monitoring systems for covers are primarily performance based and do not generally require direct measurements. The most typical system used for cover leaks is to monitor the flow of leachate in the leachate collection system. Visual inspection of the cover (or survey marker comparison) is the industry standard for detecting settlement and subsidence.

A leachate inventory is a surrogate method for examining cover integrity and is required for hazardous waste liners, although it is not required for MSW liners. As a result, it is the most common method used to determine if the cover leaks. The inventory involves comparing the volumes of liquid being pumped or treated in the containment leachate collection system over time. For a closed cell with a final cover, the volume of liquid should decrease over time. If the cover leaks, the volume of liquid should increase. However, depending upon the type and volume of waste, even a large breach in the cover might go unnoticed for a long time, and clogging of the collection system could mask infiltration rates (EPA 2002).

Survey techniques are used to evaluate potential subsidence and settlement problems. Subsidence occurs when one part of a landfill loses mass faster than another, creating differential elevations that can cause the cover to rupture. Settling usually occurs at MSW landfills as the materials in them biodegrade over time. This type of mass loss has potential to damage the integrity of cover systems, but usually does not result in the high tensile stress caused by differential subsidence and the accompanying ponding of water.

There are two general techniques for monitoring the subsidence and settlement of landfill covers. The first method involves surveying the position of monuments placed on the landfill surface at closure. The monuments are surveyed initially for elevation and then periodically re-surveyed to determine if their elevation has changed. A significant change in the elevation of one monument relative to the others would indicate differential subsidence that can stress cover materials and cause failure. General loss of elevation compared with a survey marker located away from the landfill proper indicates settlement is occurring.

The second method for monitoring subsidence and settlement, which is usually combined with the first, involves creating topographic maps with relatively small contour intervals. Topographic maps can be highly accurate if they are created using aerial photographs as well as survey data. Topographic maps are created after the containment unit is closed. Subsequent aerial photographs can be compared with the baseline map to determine if there has been any subsidence or settlement. This method is more expensive, but also is much more accurate than using survey markers alone.

4.4 Technologies

Although direct measurements are not typically required for the performance monitoring of landfill covers, technologies are available for monitoring beneath covers. However, as a result of the landfill gases that accumulate under the cover, many of the devices used in liner monitoring cannot be used to monitor covers because they will detect the gases. Furthermore, monitoring beneath covers requires access to the monitoring devices through the cover, which can increase monitoring and maintenance costs; landfills that are subject to differential subsidence or settlement will present additional design and maintenance problems. Despite these potential obstacles, liner monitoring devices may be useful in

some cover designs. The portable electrical system design listed below requires a single access point to materials lying beneath the cover geomembrane, but the actual measurement and leak detection activities take place on top of the cover. Hence, it avoids most access, settlement, and subsidence issues.

Alternative cover designs for landfills in arid and semi-arid climates often rely on the field capacity of the cover soil, rather than a low permeability barrier, to prevent infiltration of the landfill wastes. In these instances, monitoring is done to ensure that moisture is not reaching a calculated depth into the soil layer where the monitoring devices would be placed. Liner technologies, such as lysimeters, and capacitance sensors are effective, as are any of the electric grid designs. Technologies specific to covers include fiber optic stress gauges and open-path Fourier transform infrared spectroscopy.

4.4.1 Moisture Measuring Devices

As discussed in Section 3.3.8, capacitance sensors, neutron probes, and lysimeters are moisture measuring devices that can be used to monitor landfill liners. These devices also can be used in monitoring alternative cover designs that rely on the grain size of the cover soil, vegetation, and field capacity to prevent water from infiltrating the waste. The devices are placed within the cover to monitor moisture content and show that saturated conditions are not reached. All of these instruments have been used for landfill cap monitoring.

Examples. A monolithic, evapotranspiration cover consisting of 1.5 m of gravelly sand with silt was installed at the Phelan Landfill in Phelan, CA. Performance is being monitored with four 0.9-m wide by 15.25-m long HDPE lysimeters consisting of a 40-mil HDPE geomembrane overlain with two layers of geo-grid and a geotextile to collect percolation. The percolation is measured with a tipping bucket gauge at a resolution of 0.025 cm. In addition, there are eight soil moisture capacitance probes located at each lysimeter to monitor soil moisture.

Neutron probes are used to monitor the performance of a capillary barrier style cap at the Gaffey Street Sanitary Landfill in Wilmington, CA. The cover was constructed with 1 foot of vegetated soil, 3 feet of silty sandy soil, an 8 oz/yd² geotextile filter and 0.5 foot of drainage gravel. Dry wells have been placed in the cap at two locations, and probes are periodically run down them to check for moisture content.

A seven acre monolithic evapotranspiration cover was used at the Coffey County Landfill in Burlington, KS. The cover consists of six inches of topsoil cover over 42 inches of compacted silty clay. Two approximately 15-m long by 9-m wide lysimeters were placed at the base of the silty clay to monitor cover performance.

Tensiometers

While the mechanism of operation is the same as was described for advanced tensiometers in Section 3.3.8, tensiometers used for cover monitoring do not have the depth or distance requirements that may be needed for monitoring liners.

Status. Shallow tensiometers were developed to measure soil moisture primarily for scheduling agricultural irrigation events. They have been employed in agricultural and forestry applications for many years and are an established technology with many vendors.

General Attributes. Tensiometers can be grouped into two broad designs—those that use vacuum dial gages (Figure 25) and those that use pressure transducers. The dial gauge design is less expensive but is not generally automated. Dial gauges also are usually located at the surface of the ground and are affected by barometric pressure and temperature changes, which must be accounted for in data interpretation. Pressure transducer tensiometers, while more expensive, can be automated and queried remotely, thereby saving on labor costs. Depending upon the design, they too can be subject to barometric pressure and temperature fluctuations. Both categories need their water supply manually replenished on a regular basis.

Examples. No examples of commercial deployment of tensiometers for monitoring covers were found. They have been used by various groups to investigate the viability of alternative landfill cover systems.

Time Domain Reflectometry Probes

Time domain reflectometry probes operate similarly to the cables described in the liner Section 3.3.5. A very fast step voltage increase is sent by a cable tester down a co-axial cable to a probe that contains two (Figure 26), three, or four prongs. The tester (generally with a fast oscilloscope) captures the reflected waveforms and can be set to capture all or any part of the wave including those from the probe alone. The reflected waveforms indicate changes in permittivity or impedance in the material between the conductors. The materials causing these changes would be the plastic separating the two wires, the plastic head holding the rods in place in the probe, and the soil between the rods. The permittivity of the soil is a function of soil type and moisture content. Hence, for accurate readings the probe should be calibrated to site-specific conditions.

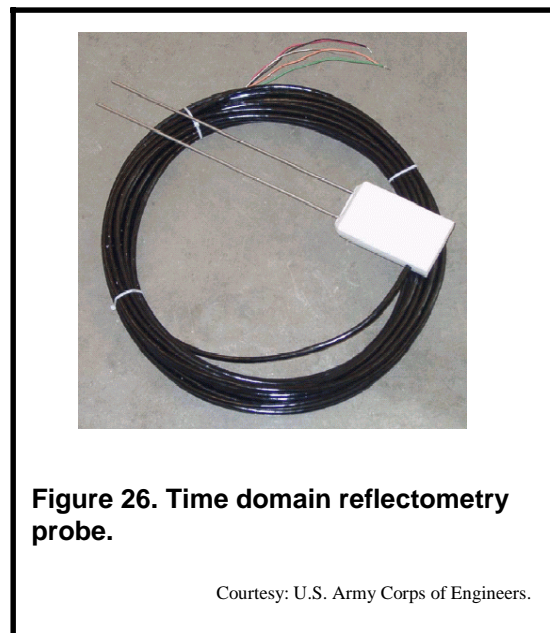
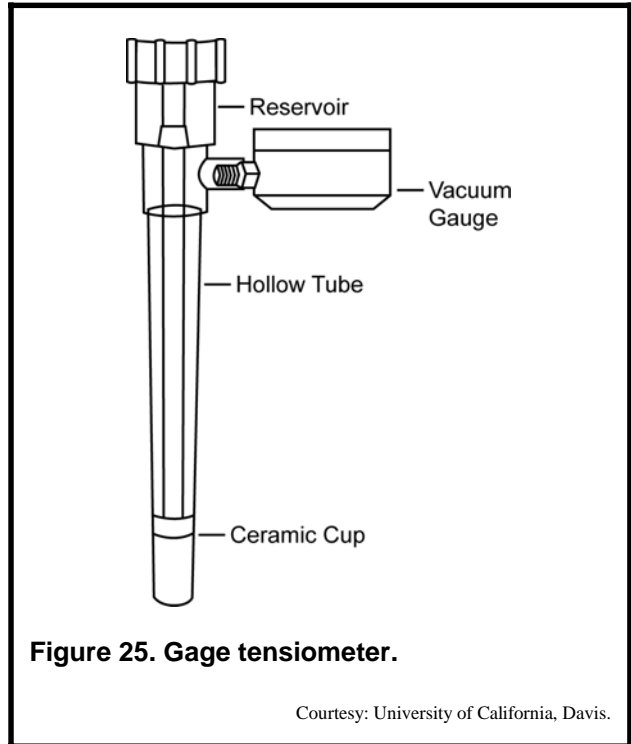

Status. TDR probes were originally developed to measure soil moisture for agricultural applications and are widely available through a number of vendors. More recently they have found application in monitoring soil moisture in alternative landfill cover designs.

General Attributes. TDR probes can be multiplexed and used for unattended automated data collection. They can be set at different depths to provide a soil moisture profile within a landfill cover. Calibration/interpretation problems may be experienced when the probes are placed in dry soils with low bulk density or when deployed in soils containing expansive (smectite) clays (Evet, 2000).

Examples. An evapotranspiration cover was placed over the 100-acre Coyote Canyon Landfill located in Somis, CA. The design of the landfill cover consists of a 30-inch fine sand barrier layer overlain by a 78-inch vegetative layer that was made with locally obtained borrow soils. The moisture content of the cover is measured by three stacks of TDRs. The TDRs were placed at depths of 6, 12, 24, 36, 51, 66, 84, 93, and 102 inches and initially monitored on an hourly basis. The TDRs have shown moisture intrusion into the cap to a maximum depth of 36 inches.

An evapotranspiration cover was placed over the 166-acre Lopez Canyon Sanitary Landfill located in Los Angeles, CA. The landfill cover consists of a 3-foot silty sand/clayey sand layer, which overlies a 2-foot foundation layer. Two of the four cell covers have monitoring systems that consist of two stacks of TDR probes, that measure soil moisture at 24-inch intervals to a maximum depth of 78 inches.

For more examples of covers and monitoring systems see:
http://clu.in.org/products/altcovers/usersearch/lf_search.cfm

4.4.2 Electrode Grids

While not common, electrode grid systems similar to those discussed in Section 3.3.6 for liners can be used for monitoring landfill covers. Differential settlement issues can make their design difficult and their long-term viability problematic.

An automated electrode grid was deployed at a former mining site as part of a cover monitoring system (U.S. DOE, 2003). The 62-acre rock dump (sulfidic waste rock and spent heap leach ore) was covered with a geotextile overlain by 15 feet of soil. Before placing the cover, 600 stainless steel electrodes, each connected to 18-gauge copper wire, were placed on a 25-foot center grid over the waste. The wires connect to a control station where the electrodes can be queried to generate a detailed resistivity map. The electrode grid provides information on moisture changes within the pile and detects whether any moisture is penetrating the cover. Design and maintenance issues were greatly reduced at the rock dump site because the dump is not expected to settle or subside (<http://subsurface.inel.gov/information/newsletter/Vol4Iss1/giltedge.asp>).

4.4.3 Portable Electrical Systems

The portable electrical system described in Section 3.3.7 of the Liner Chapter can also be used to locate leaks in cover systems containing geomembranes. The geomembrane cover leak location method transmits an electrical current from an electrode in a conductive medium above the liner (Figure 27). The current flows through any breaks in the liner and is received by a second electrode placed in a conductive medium below the geomembrane liner. Electrical potential measurements on the surface of

the conductive media using moving electrodes locates holes in the liner. The high current density caused by localized current flowing through the holes causes a localized characteristic leak signal that can be located with great accuracy.

Status. The system was designed for locating leaks in geomembranes and is commercially available. It has been widely applied in both the United States and abroad and is offered by over 20 vendors. ASTM Standard D 7007 includes standard practices for locating leaks in geomembranes covered with earthen materials.

General Attributes. Geomembrane leak location surveys can be applied at any time on any containment cover that has a geomembrane liner. The results are available in the field. It does not require sensors and associated cabling to be installed during construction of the cover. There is no up-front investment needed for installation so the method can be applied only if indicated by increased leachate levels.

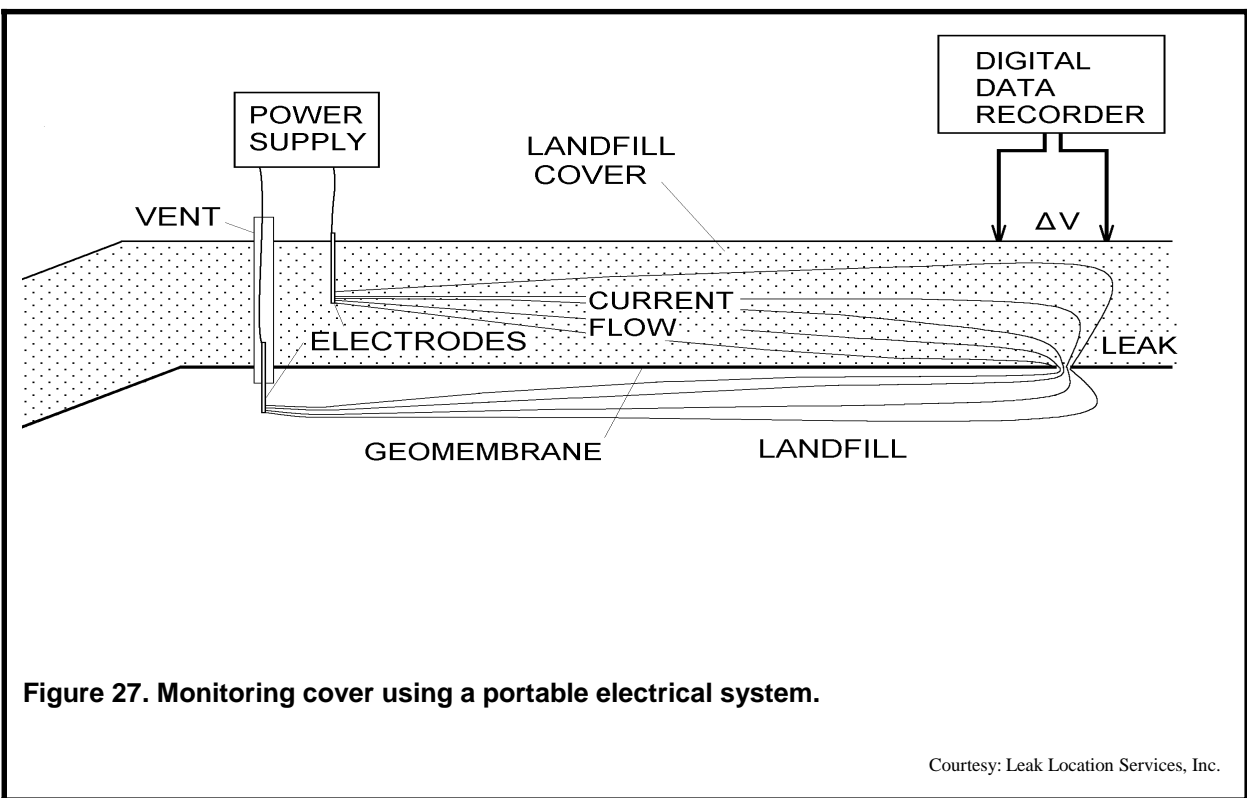

Examples. While portable electrical systems could be deployed for long-term monitoring, no examples were found. The system is most often used for spot checking when a problem is suspected or the integrity of the liner is an important safety concern. Examples of the former: a survey at a CERCLA landfill cover in New York after construction damage was noted in the geomembrane and a survey at a large landfill in Connecticut after leachate levels were observed to be increasing. The survey of a Kentucky landfill that contained hydrogen cyanide waste is an example of monitoring for safety reasons.

4.4.4 Fiber Optic Stress Gauges

Fiber optic stress gauges use changes in light reflectance to sense deformation. By attaching fiber optic cables to the underside of a geomembrane cover, changes in the membrane position due to subsidence and settlement can be detected and, depending upon the density of the attached cables, accurately located.

Status. Fiber optic stress gauges function in much the same fashion as metal stress gauges, which are used to measure deformation of a material from its original emplaced form. Metal gauges have been employed in the construction industry for a number of years and generally rely on a change in the resistance of the metal when it is deformed.

General Attributes. Fiber optic stress gauges for landfill cover monitoring have not been commercialized. If used, fiber optic stress gauges must be installed during initial construction of a cover. The cables are attached to a central control unit that tests them on a predetermined schedule. This type of system alerts the operator to a shift in the geomembrane cover due to lateral sloughing of the cover material or vertical displacement due to differential subsidence. Near continuous and automated monitoring provides for relatively inexpensive operation. However, the gauges may need to be replaced after detecting movement.

Examples. SNL has been conducting experiments to automate the detection of differential subsidence using geomembranes with embedded fiber optic stress gauges (Borns, 1997). By incorporating fiber optics into geomembranes, the SNL has produced a membrane that can be monitored for strain. This capability is especially useful for detecting stretching and tearing in geomembrane liners and covers. Strain detection is possible because the fiber optic lines are crimped into small folds called “microbends.” These microbends are either distributed evenly along the entire optical fiber, or the fiber has short sections of microbends a few meters apart. As the geomembrane tears or stretches, the microbends flatten out, changing the way optical signals are reflected through them.

Field-scale testing on the SNL Geosynthetic Membrane Monitoring System was completed in October 1997. During the test, a 43-by-4.5-m section of geomembrane was installed as a cover over a test facility that was designed to simulate both local and general subsidence. The strain in the geomembrane was measured for three months as water and air drained from fabric bladders and inner tubes in the test cell. The strain data indicated the location and magnitude of the subsidence.

4.4.5 Fourier Transform Infrared Spectroscopy

FTIR spectroscopy measures the chemical absorption of specific energy bands in the infrared (IR) spectrum. Not all chemicals absorb in the IR range of a given instrument, but those that do create a pattern unique to each. Detection by IR analysis is accomplished by measuring the absorption of energy by molecules in a target sample. The concentration of the chemical can be estimated from the amount of energy absorbed. FTIR instruments can be deployed either in an open path mode or through the use of a portable cell. A typical open path FTIR spectroscopy system includes an IR source, a Michelson interferometer, beam splitter, helium-neon laser for beam alignment, collimating telescope, and detector. The system can be set up in either a bistatic or monostatic configuration (U.S. EPA, 1999). In the bistatic configuration, an IR source transmits a beam of energy directly through the area where

chemical measurement is desired to a receiving detector on the other side. In the monostatic configuration, an IR source transmits a beam of energy through the area where chemical measurement is desired to a retroreflector that reflects it back through the area to a receiving detector. In both configurations, the concentration reported is an average over the area traversed. With portable cells air is drawn into the cell where it is queried by bouncing a light beam repeatedly between the ends of the cell. After a fixed number of bounces the light exits the cell where it is captured by a detection system that measures the amount of energy absorbed.

Status. Open-path Fourier transform infrared (OP-FTIR) spectroscopy is an established analytical technique that measures the concentrations of non-atmospheric gases that may escape from a landfill cover. If gases escape from a section of the cover, presumably liquids can infiltrate the containment unit via the same conduits. The primary use of OP-FTIR in hazardous chemical work has been for fence-line monitoring at industrial sites and remedial action sites. FTIR cell systems are also established and find their principal use in laboratory settings.

General Attributes. An OP-FTIR spectroscopy system can be deployed as a permanent system or as a temporary one to periodically check for releases. The technology is capable of identifying a broad range of chemicals in the low ppbv range. In general, a total travel distance of 100 meters or more is required to achieve good detection limits. While automated systems have been used in industrial fence-line applications, detection of cover leaks would likely require a radial configuration of multiple points, that cannot be automated. A skilled operator is needed for OP-FTIR spectroscopy.

Examples. EPA used OP-FTIR spectroscopy to determine if gases escaping from a closed Superfund landfill will present a health risk to people if the landfill is redeveloped into a soccer field. The landfill cover was gridded, and retroreflectors were placed in each grid cell. This configuration allowed average measurements to be taken over increasing distances and also provided for good areal coverage. The field work took three days and identified three separate methane gas releases. No other contaminants were detected. Detection limits generally ranged between 4 and 60 ppbv (U.S. EPA, 2004).

I-CORP International, Inc. has deployed a portable FTIR spectrometer that is mounted on a vehicle. The instrument can measure the distribution of methane, non-methane hydrocarbons, and carbon dioxide. When these measurements are combined with a global positioning system, exact locations of gas concentrations can be mapped. The spectrometer has an 8-foot long sample cell that is moved across the cover. As the cell moves, air flows through it and potential contaminants are measured. I-CORP reports a sensitivity of less than 0.1 ppm when analyses are conducted every second. However, with somewhat less sensitivity, the instrument is capable of producing 100 readings a second, and hence can provide near continuous data as it traverses the cover.

5.0 SUMMARY AND DISCUSSION OF FINDINGS

LINERS

The industry standard for monitoring beneath the liner of a containment unit is to place groundwater monitoring wells at the downgradient edge of the unit and periodically test the groundwater for changes in its quality. In the event that an alternative to groundwater monitoring is needed or required, this study identified 13 technologies that have been used to monitor the vadose zone beneath a containment liner, or have the potential to do so. Table 1 summarizes the key attributes of these technologies.

Advanced tensiometer. Advanced tensiometers are a variation on traditional tensiometers that allows them to be automated and deployed at depth (60 meters or greater) and at angles ranging from horizontal to vertical. They are used to measure the moisture content of the soil in their immediate vicinity. They can be deployed during or after the construction of the landfill liner but their location must allow access for maintenance.

Cable network sensor. Cable network sensors are an experimental technology developed in Europe. They measure the change in the dielectric of clay, which is used in the compacted soil layers of liners. The change in dielectric is brought about by a change in moisture content. The released liquid must be capable of changing the dielectric of the clay, but does not need to directly contact the cable. The sensors are placed in the soil when the containment unit is constructed and must be queried by a trained operator.

Capacitance sensors. Capacitance sensors were developed primarily for use in agriculture and construction. The sensors measure the moisture content of the soil in their immediate vicinity. Hence, for use at landfills they must be placed during construction at points deemed most vulnerable to leaking or in areas where infiltrating leachate might be expected if a failure occurs. Capacitance sensors can be automated and do not require highly skilled operators. One landfill in California was identified as having a capacitance system in place.

Diffusion hoses. While diffusion hoses have been deployed beneath landfills in Europe, they are used mostly in detecting releases from equipment, tanks, and pipelines at chemical and petroleum facilities. Diffusion systems detect chemical vapors that are released from chemical spills or leachate releases that are capable of diffusing through their permeable tubing walls. If there are no volatile compounds in the leachate, then diffusion hoses will not detect the release. Diffusion hoses can be placed during or after construction of a containment unit and are typically automated. They can provide chemical concentrations, speciation, and, depending on the design of the monitoring system, its specific or general location.

Electrochemical sensing wire cables. Electrochemical sensing wire cables have been installed to monitor a doubled-lined hazardous waste acid impoundment. However, in general, these cables are used primarily for detecting releases from equipment, tanks, and pipelines at chemical and petroleum facilities. Electrochemical sensing wire cables rely on a direct interaction of the cable with the liquid, which triggers a short between a continuity line and an alarm line. The cables are all continuous, fully automated systems that can determine the exact location of a release. Some cables must be replaced if a release occurs, and if the leak is not repaired, the system will emit a continuous alarm. The cables

require a protective, perforated piping to avoid being crushed. This piping allows for the maintenance and replacement of cables. The piping can be placed either during construction of the containment unit, or afterward using horizontal drilling.

Electrode grids. Electrode grids were developed specifically for monitoring beneath the liner of a landfill or impoundment. They measure points where electrical current flows through breaks in the liner or measure changes in the localized resistivity of the conductive layer caused by fluids flowing through the breaks. Over 120 electrode grids have been deployed. They consist of a series of electrodes individually connected by cables to a central processing unit. The grid is placed beneath the liner during construction of the containment unit.

Portable electrical systems. Portable electrical systems are used extensively as a quality assurance tool following liner construction, but no examples of their use in permanent monitoring systems were identified. The system detects holes in the liner by impressing a current between an electrode located within the liner system and an electrode grounded outside the liner system. A detection probe is then used to scan the liner to locate any leakage of current caused by breaches in the liner. The system can be used over the service life of a surface impoundment but is generally restricted to construction quality assurance for landfill liners.

Intrinsic fiber optic sensors. Intrinsic fiber optic sensors are primarily used for leak detection in the chemical and petroleum industries. The sensors are chemically sensitive to a target chemical or class of chemicals. As a chemical or class of chemicals is adsorbed by the sensor, it changes the effective index of refraction of the sensor, which is determined by measuring the amount of light transmitted through an optical fiber. The probes generally have to be regenerated over time. This regeneration requires that they be placed in accessible locations, such as dry, vertical, perimeter wells or in perforated piping laid under the liner. No examples of the deployment of intrinsic fiber optic sensors at a landfill were found.

Lysimeters. Lysimeters are used primarily in agriculture for irrigation programs and water balance studies. They are commonly deployed at landfills in California. There are two basic designs: (1) suction lysimeters, which sample pore water under negative pressure; and (2) plate/pan lysimeters, which collect free-flowing percolation. In general, they are placed during construction of the landfill and are sampled manually. Lysimeters measure a limited area around and/or above them and may collect insufficient sample volume if speciation of the chemicals is desired.

Neutron probes. Neutron probes are a standard geophysical instrument used to measure the moisture content of the soil in the immediate vicinity of an open borehole or well casing. It works by counting back-scattered neutrons that have been slowed down by their interaction with hydrogen atoms. The count is directly related to the amount of moisture in the formation. When used at landfills, neutron probes must be pulled through horizontal or angled piping, which can be placed during construction or retrofitted. Several landfills in the western U.S. employ neutron probes as part of their vadose zone monitoring system.

Soil gas. Soil gas systems are primarily used in site characterization studies and for leak detection monitoring at petroleum and chemical facilities. Soil gas systems measure volatile chemicals that have partitioned into the soil gas from escaping leachate. In passive soil gas systems, a sorbent device is placed in a dry well and the sorbed chemicals are measured after a pre-specified period of time. In active soil gas systems, the soil gas is pumped from the dry well and analyzed. Passive systems cannot

be automated, but active ones can. In silty and clayey soil, the time required for detecting a release can be quite long. Depending upon the number and placement of the dry wells, soil gas systems can identify the release location. Several landfills in the western U.S. use soil gas systems as part of their vadose zone monitoring program.

Time domain reflectometry detection cables. Although time domain reflectometry detection cables are primarily used to detect releases at petroleum and chemical facilities, they have been used for vadose zone leak detection under double-lined acid impoundments and for monitoring piping that transports leachate from a landfill to a holding or treatment center. Time domain reflectometry depends on a change in impedance in the cable caused by an infiltrating liquid or gas. The distance to the change in impedance is easily calculated to determine the general area of the release. The cables must be shielded in protective, perforated piping, which can be installed while the containment unit is being constructed or as a retrofit. The cables are fully automated, and if the leak is repaired the cables can be dried and reused.

Wire net. Wire nets were designed to monitor the vadose zone beneath containment unit liners and have been deployed at several units in Europe. A wire net consists of two arrays of orthogonally oriented wire electrodes that are separated by a thin layer of permeable, but resistive material, such as sand. The system detects leaks in the liner by measuring changes in the resistivity between the wire electrodes. In general, the system must be queried by a trained operator.

COVERS

The primary reason for performance monitoring of covers is to make sure water is not introduced to the landfill wastes. The industry standard for monitoring cover integrity is to visually inspect the cover and to measure leachate production over time to ensure that the volume is decreasing. Four of the technologies used to monitor liners—capacitance sensors, lysimeters, electrode grids, and portable electrical systems—have also been deployed for covers. Two more of the technologies that are found in the liner section—tensiometers and time domain reflectometry are also used to monitor covers but they use a different configuration and are discussed below. Two additional technologies—fiber optic stress gauges and Fourier transform infrared spectroscopy—were identified as having been designed for or deployed in final cover monitoring.

Fiber optic stress gauges. Fiber optic stress gauges are an experimental technology designed specifically for measuring deformation of geomembranes caused by lateral sloughing or vertical displacement, which can occur during settlement and subsidence. Fiber optic cables are attached directly to a geomembrane cover when it is installed. These cables measure changes in reflectance that are indicative of changes in their position on the geomembrane. A change in position is generally caused by a shift in the geomembrane due to general or differential settlement. The location of the reflectance change is easily determined. While the system does not indicate that a breach has occurred in the cover, it does alert the operator to a potential problem.

Fourier transform infrared spectroscopy. FTIR spectroscopy is primarily used in the environmental field to monitor volatile chemical releases from industrial facilities and remediation actions at the fence line. Open path-FTIR spectroscopy provides an average concentration of a variety of organic and inorganic chemicals at the ppbv level over preset distances. A radial survey approach is used when monitoring a final cover, to locate hotspots caused by escaping volatiles. If a hotspot allows a

significant release of gas, it might also allow water to enter the landfill. FTIR equipment can also be mounted on a vehicle, which can be driven across the top of the cover to look for hotspots. When the vehicle is equipped with a GPS, exact locations of hotspots can be mapped as they are encountered.

Tensiometers. Tensiometers measure soil moisture content in the immediate vicinity of their porous ceramic cups. They can be deployed singularly without automation or multiplexed with automation. They find their best use in measuring changes in moisture content over time within the overlying soil layers of a cover.

Time domain reflectometry probes. Time domain reflectometry probes relate changes in impedances in the soil between probe prongs to its moisture content. They are automated and typically arrayed in vertical stacks to track changes in moisture content with depth in cover soils.

Table 1. Key Attributes of Vadose Zone Monitoring Systems.

Attribute	Advanced Tensiometers	Cable Network Sensors	Capacitance Sensors	Diffusion Hoses	Electrochemical Sensing Wire Cables	Electrode Grids	Intrinsic Fiber Optic Sensors	Lysimeters	Neutron Probes	Portable Electrical Systems	Soil Gas Systems	Time Domain Reflectometry Detection Cables	Wire Net Design
Automated	✓		✓	✓	✓	✓	✓			✓	✓	✓	
Continuous Operation	✓				✓	✓	✓					✓	
Unskilled Operators			✓	✓	✓		✓	✓	✓			✓	
Locates Discrete Area of Release	✓		✓	✓	✓	✓		✓	✓	✓		✓	✓
Locates General Area of Release		✓		✓	✓	✓	✓			✓	✓	✓	✓
Determines Volume of Release		✓				✓							✓
Identifies Contaminant				✓			✓	✓			✓		
Identifies Chemical Class of Contaminant				✓	✓		✓	✓			✓	✓	
Retrofitted	B			P	P/ B		P/ B		B	P/ B	P/ B	P/ B	
Commercially Available	✓		✓	✓	✓	✓	✓	✓	✓	✓	✓	✓	✓
Full Scale Deployment for Liners			✓	✓		✓		✓	✓	✓	✓		✓
Demonstration Scale for Liners	✓	✓	✓	✓		✓		✓	✓	✓	✓		✓

P= Perimeter
 B= Beneath liner

REFERENCES

- Akgun, H. and R. Wallace, 1996. Leakage detection in lined systems. *Journal of Solid Waste Technology Management*, Vol 23 No 2, p 67-71, May 1996.
- Anderson, R., G. Young, and T. Crist, 1997. Subsurface landfill gas monitoring strategies in California. California Integrated Waste Management Board, Sacramento, CA. Proceedings of the 1997 13th International Conference on Solid Waste Technology and Management. Part 1 (of 2) 16-19 November 1997, Philadelphia, PA. Widener Univ., School of Engineering, Chester, PA. E.I. Conference No. 47586, Vol 1, 8 pp.
- Barrie, S., 1998. An eastern European perspective on leak detection. *Waste Management*, p 36-37, Apr 1998.
- Bernstone, C., T. Dahlin, P. Ulriksen, J. Claesson, 1998. A wire net design for electrical monitoring of environmental barriers. The Symposium on the Application of Geophysics to Environmental and Engineering Problems (SAGEEP), 22-26 March 1998, Chicago, Illinois, p 645-653.
- Bonaparte, R., 1995. Long-term performance of landfills. Proceedings of the ASCE Specialty Conference Geoenvironment 2000. ASCE Geotechnical Special Publication No. 46, Vol. 1, p 415-553.
- Borns, D., 1997. Geomembrane with incorporated optical fiber sensors for geotechnical and environmental applications. Proceedings of the International Containment Technology Conference, St. Petersburg, Florida, p 1067-1073.
- Brandelik, A. and C. Huebner, 1997. Large-area, long-term monitoring of mineral barrier materials. International Containment Technology Conference: Proceedings p 1060-1066.
- Coluci, P., F. Crozier, and D. Laine, 1996. Geomembrane liner testing using the GLLS: a high-voltage electrical leak location system. *Geosynthetics: Applications, Design and Construction*, 30 September - 2 October, 1996, Maastricht, Netherlands.
- Cullen, S., J. Kramer, and J. Luellen, 1994. A risk-based approach to the design of a vadose zone monitoring system for a solid waste landfill. 87th Annual Meeting and Exhibition Air & Waste Management Association, Cincinnati, OH, June 19-24, 1994.
- Darilek, G. and L. Miller, 1998. Comparison of dye testing and electrical leak location testing of a solid waste liner system. Proceedings of the Sixth International Conference on Geosynthetics, 25-29 March 1998, Atlanta, Georgia. Industrial Fabrics Association International, St. Paul, MN. ISBN: 0093583076.
- Darilek, G. and D. Laine, 1999. Performance-based specification of electrical leak location surveys for geomembrane liners. Conference Proceedings of Geosynthetics '99, 28-30 April 1999, Boston, MA. Industrial Fabrics Association International, St. Paul, MN. Vol 2, p 645-650.

Evelt, S., 2000. Some aspects of time domain reflectometry (TDR), neutron scattering, and capacitance methods of soil water content and measurement. In *Comparison of Soil Water Measurement Using the Neutron Scattering, Time Domain Reflectometry and Capacitance Methods*. International Atomic Energy Agency, Vienna, Austria, IAEA-TECDOC-1137, p 5-49.
<http://www.cpri.ars.usda.gov/programs/pdfs/IAEAEVET.PDF>

Frangos, W., 1997. Electrical detection of leaks in lined waste disposal ponds. *Geophysics*, Vol. 62, No. 6 (November-December 1997), p 1737-1744.

G2 Imaging, undated. *Heap Leach Pad Monitoring to Manage Risks in Gold and Copper Mining*. TerraPlus, Inc. Littleton, CO. <http://www.terraplus.com/papers/g2%20Imaging.com>.

Gray, W., L. Everett, and S. Cullen (eds.), 1995. *Handbook of Vadose Zone Characterization & Monitoring*, CRC Press, Boca Raton, FL.

Hassoun, S., T. McBride, and D. Russell, 2000. Development of perfluorocarbon tracer technology for underground leak location. *Journal of Environmental Monitoring*, Vol 2 No 5, p 432-435, Oct 2000.

Hubbell, J. and J. Sisson, 1998. Advanced tensiometer for shallow or deep soil water potential measurements. *Soil Science*, 163(4) p 271-276.

Laine, D., A. Binley, and G. Darilek, 1997a. Locating geomembrane liner leaks under waste in a landfill. Geosynthetics '97 Conference Proceedings, Long Beach California, U.S.A., March 11-13, 1997. Industrial Fabrics Association International, St. Paul, MN. p 407-411.

Laine, D., A. Binley, and G. Darilek, 1997b. How to locate liner leaks under waste. *Geotechnical Fabrics Report*, Aug 1997.

Laine, D. and G. Darilek, 1993. Locating leaks in geomembrane liners of landfills covered with a protective soil. Geosynthetics '93 Conference Proceedings, Vancouver, British Columbia, Canada, March 30 - April 1, 1993.

Looney, B. and R. Falta (eds.), 2002. *Vadose Zone Science and Technology Solutions*. Battelle Press, Columbus, OH.

Parasnis, D., 1997. *Principles of Applied Geophysics*. Chapman & Hall, London.

Peggs, I.D. and S. McLaren, 2002. Portable infrared spectroscopy for the rapid monitoring of leaks in landfill caps and bottom geomembrane liners. Proceedings 7ICG September 2002, Swets & Zeitlinger, Lisse, The Netherlands, p 775-778.

Peggs, I.D., 2001. Three challenging electrical integrity/leak surveys on uncovered and deep waste-covered liners. Proceedings of Geosynthetics Conference 2001, IFAI, Roseville, MN, p 245-262.

Phaneuf, R.J. and I. Peggs, 2001. Landfill construction quality— lessons learned from electrical resistivity testing of geomembrane liners. In *Geotechnical Fabrics Report* (GFR), IFAI, Roseville, MN, April 2001, p 28-35.

Peggs, I., 1999. *Geomembrane Liner Integrity Survey Technologies and Their Findings*. I-Corp International, Inc. 11 pp.

Rodel, A., 1996. GEOLOGGER: A new type of monitoring system for the total area monitoring of seals on landfill sites. *Geosynthetics: Applications, Design and Construction*. Proceedings of the First European Geosynthetics Conference, Maastricht, 1996. p 625-626.

Rouessac, F. and A. Rouessac, 2000. *Chemical Analysis: Modern Instrumental Methods and Techniques*. John Wiley & Sons, West Sussex, UK.

Siemens, A.G., 1998. *Leos® Leak Detection and Location System*. Erlangen, Germany, 7 pp. <http://www.de.framatome-anp.com/anp/e/foa/anp/products/a-z/leose.pdf>

Sisson, J. B., G.W. Gee, et al., 2002. Advances in tensiometry for long-term monitoring of soil water pressures. *Vadose Zone Journal* 1: p 310-315.

Staller, G. and R. Wemple, 1996. *Geomembrane Barriers Using Integral Fiber Optics to Monitor Barrier Integrity*. Sandia Corp., Albuquerque, NM. Patent No.: US 5567932 A. 10 pp, 22 Oct 1996.

Stormont, J., M. Ankeny, and J. Kelsey, 1998. Airflow as monitoring technique for landfill liners. *Journal of Environmental Engineering* (New York), Vol 124 No 6, p 539-544, 30 Jun 1998.

Studer, J., 2000. The vadose zone monitoring system for the CAMU project at Sandia National Laboratories. *Vadose Zone Science and Technology Solutions*. Battelle Press, Columbus, OH.

Swyka, M. and I. Peggs, 1999. Overview of landfill liner leak location technologies. WasteCon '99, February 1999, New Orleans, Louisiana.

U.S. DoD, 2000. *Cost and Performance Report: Electromagnetic Surveys for 3-d Imaging of Subsurface Contaminants*. Environmental Security Technology Certification Program, Department of Defense.

U.S. DOE, 2000. *Innovative Technology Summary Report: Subsurface Barrier Verification with the Seatrace™ Monitoring System*, DOE/EM-0549. Subsurface Contaminants Focus Area and Characterization, Monitoring, and Sensor Technology Crosscutting Program.

U.S. DOE, 2002. *Innovative Technology Summary Report: Advanced Tensiometer for Vadose Zone Monitoring*, DOE/EM-0639. Subsurface Contaminants Focus Area and Characterization, Monitoring, and Sensor Technology Crosscutting Program. <http://apps.em.doe.gov/OST/pubs/itsrs/itsr2122.pdf>

U.S. DOE, 2003. Geophysical monitoring system installed on EPA's Gilt Edge Superfund Site *INEEL Subsurface Science Initiatives Newsletter*, Vol 4 No 1, Mar 2003. <http://subsurface.inel.gov/information/newsletter/Vol4Iss1/giltedge.asp>

U.S. EPA, 1983. *Standardized Procedures for Planting Vegetation on Completed Sanitary Landfills*, EPA 600/2-83/055.

U.S. EPA, 1985a. *Covers for Uncontrolled Hazardous Waste Sites*, EPA 540/2-85/002.

U.S. EPA, 1985b. *Settlement and Cover Subsidence of Hazardous Waste Landfills*, EPA 600/2-85/035.

U.S. EPA, 1987a. *Engineering Guidance for the Design, Construction, and Maintenance of Cover Systems for Hazardous Waste*, EPA 600/2-87/039.

- U.S. EPA, 1987b. *Prediction/Mitigation of Subsidence Damage to Hazardous Waste Landfill Covers*, EPA 600/2-87/025.
- U.S. EPA, 1989a. *Final Covers on Hazardous Waste Landfills and Surface Impoundments*, EPA 530/SW-89/047.
- U.S. EPA, 1989b. *RCRA ARARs: Focus on Closure Requirements*, OSWER Directive 9234.2-04FS.
- U.S. EPA, 1991a. *Conducting Remedial Investigations/Feasibility Studies for CERCLA Municipal Landfill Sites*, EPA 540/P-91/001.
- U.S. EPA, 1991b. *Seminar Publication: Design and Construction of RCRA/CERCLA Final Covers*, EPA 625/4-91/025.
- U.S. EPA, 1993a. *Solid Waste Disposal Facility Criteria: Technical Manual*, EPA/530/R-93/017.
- U.S. EPA, 1993b. *Subsurface Characterization and Monitoring Techniques, A Desk Reference Guide. Volume II: The Vadose Zone, Field Screening and Analytical Methods Appendices C and D*. EPA/625/R-93/003b.
- U.S. EPA, 1993c. *Technical Guidance Document: Quality Assurance and Quality Control for Waste Containment Facilities*. EPA/600/R-93/182.
- U.S. EPA, 1994. *Seminar Publication: Design, Operation, and Closure of Solid Waste Landfills*, EPA/625/R-94/008.
- U.S. EPA, 1995. *Presumptive Remedies: CERCLA Landfill Caps RI/FS Data Collection Guide*, EPA 540/F-95/009.
- U.S. EPA, 1998a. *Evaluation of Subsurface Engineered Barriers at Waste Sites*. EPA/542/R-98/005.
- U.S. EPA, 1998b. *Evaluation of Subsurface Engineered Barriers at Waste Sites, Volume II, Appendix B*. EPA/542/R-98/005a.
- U.S. EPA, 1999. *Compendium of Methods for the Determination of Toxic Organic Compounds in Ambient Air, Compendium Method TO-16, Long-Path Open-Path Fourier Transform Infrared Monitoring of Atmospheric Gases*. EPA/625/R-96/10b.
- U.S. EPA, 2002. *Assessment and Recommendations for Improving the Performance of Waste Containment Systems*, EPA/600/R-02/099.
- U.S. EPA, 2004. *Research and Development: Measurement of Fugitive Emissions at Region I Landfill*, EPA/600/R-04/001.
- Versteeg, R., G. Heath, et al., 2003. Electrical resistance tomography to monitor mitigation of metal-toxic acid-leachates ruby gulch waste rock Repository Gilt Edge Mine Superfund site, South Dakota, USA. 2003 AGU meeting, San Francisco, EOS Trans. AGU, 84(46), Fall Meet. Suppl, Abstract H31B-0471, 2003.

Versteeg, R., G. Heath, et al., 2003. Design and installation of a remotely controllable autonomous resistivity monitoring system at the Gilt Edge Mine superfund site, South Dakota. SEG Annual Meeting, Dallas, TX. Society of Exploration Physicists.

White, C. and R. Barker, 1997. Electrical leak detection system for landfill liners: a case history. *Ground Water Monitoring and Remediation*, Vol. 17, No. 3 Summer 1997, p 153-159.

APPENDIX A

Glossary

Capacitance sensor: An instrument used to measure the difference in electric potential between two points in the soil. This data is then used to determine the amount of water in the soil.

Capillary zone: The area immediately above the saturated zone where water is drawn up into pores by capillary pressure.

Dielectric: The ability of a dielectric to store electrical potential energy under the influence of an electric field measured by the ratio of the capacitance of a condenser with the material as dielectric to its capacitance with vacuum as dielectric.

Field capacity: The quantity of water that can be held by soil against the pull of gravity.

Gypsum block: A cylindrical block of calcium sulfate (CaSO_4) into which two electrodes are inserted. The block is porous and allows water to move in and out as the soil wets and dries. In the presence of moisture the CaSO_4 goes into solution allowing ion movement between the two electrodes. The current can be measured and is directly related to soil moisture content.

Heap leaching: A method for extracting precious metals from low grade ores where the ore is placed in a pile and a leaching solution, usually cyanide, is poured over it and then recovered.

Hydraulic conductivity: A coefficient of proportionality describing the rate at which water can move through a permeable medium. Hydraulic conductivity is a function of both the intrinsic permeability of the porous medium and the kinematic viscosity of the water that flows through it. In older documents, hydraulic conductivity is referred to as the coefficient of permeability.

Impedance: A material's opposition to the flow of electrical current.

Permeability: The capacity of a soil to transmit a fluid.

Permeameter: An instrument used to measure the permeability of a soil.

Soil water potential: The amount of work needed, per unit quantity of pure water, to transport the pure water from the reference state to the state in question, reversibly and isothermally.

Suction lysimeter: A device for collecting pore water from soils. Usually consisting of a ceramic cup, reservoir, and collection tube.

Time domain reflectometry: The measurement of an electromagnetic pulse sent down a coaxial cable to detect an impedance change or discontinuity.

Vadose zone: The area in the subsurface that lies between the ground surface and the capillary zone.

Water balance: Evapotranspiration study that shows the fate of water that is applied to an area (e.g., how much is used by vegetation, evaporates, or infiltrates).

Wicking: The process of pulling a liquid into a material using differential potential pressures.

APPENDIX B¹

List of Contacts, Vendors, and Products

Advanced Tensiometer

In-Situ Inc.
P.O. Box I
210 S. Third Street
Laramie, WY 82073 USA
Phone: (307) 742-8213
Fax: (307) 721-7598
Website: <http://www.in-situ.com>

North Wind Environmental, Inc.
P.O. Box 51174
Idaho Falls, ID 83402
Phone: (208) 528-8718
Fax: (208) 528-8714
Website: <http://www.nwindenv.com>

Chemical Fiber Optic Leak Detection

DecisionLink, Inc.
1181 Grier Dr., Bldg B
Las Vegas, NV 89119
Phone: (702) 361-3027
Fax: (702) 361-9652

Diffusion Hose

Siemens AG
Bereich Power Generation
KWU NW-D
Freyeslebenstr. 1
P.O. Box 3220
D-91058 Erlangen
Phone: (09131) 18-3615 or 18-5043
Website: <http://www.siemens.com>

¹ *This list of vendors is not meant to be comprehensive and was developed from either their mention in the literature or websites that provided descriptions of devices that may be applicable to monitoring liners or covers. Mention of trade names or commercial products does not constitute endorsement or recommendation for use.*

Electrical Grid Systems

Forschungszentrum Karlsruhe
Postfach 3640
D-76021 Karlsruhe, Germany
Dr. Alexander Brandelik
Phone: 49 (0) 7247-823913

SENSOR International Environmental Protection
11 Avenue de la Liberté - L 1931 - Luxembourg
Phone: 352 489 921
Fax : (352) 2629 6328
Email: sensor@sensoriep.com

SRK Consulting
Suite 115
3275 West Ina Rd.
Tucson, AZ 85741
Phone: (520) 544-3688
Fax: (520) 544-9853
Website: <http://www.na.srk.com/>

Electrochemical Sensing Wire Cable

Tyco Thermal Controls LLC
300 Constitution Dr.
Menlo Park, CA 94025-1164
Tel (800) 545-6258 (within U.S. only)
Tel (650) 216-1526 (outside U.S.)
Fax (800) 527-5703
Website: <http://www.tycothermal.com/northamerica/english/leakdetection/default.asp>

Lysimeters

Soilmoisture Equipment, Corp.
P.O. Box 30025
Santa Barbara, CA 93105
Phone: (805) 964-3525
Fax: (805) 683-2189
Website: <http://soilmoisture.com>

Moisture Capacitance Instruments

Troxler Electronic Laboratories, Inc.
P.O. Box 12057
3008 Cornwallis Rd.
Research Triangle Park, NC 27709
Phone: (919) 549-8661
Fax: (919) 549-0761
Website: <http://www.troxlerlabs.com/PRODUCTS/fieldequip.html>

Neutron Probes

CPN International, Inc.
2830 Howe Road
Martinez, CA 94553
Phone: 925-228-9770
Fax: 925-228-3183
Toll Free: 800-468-4276
Website: <http://www.cpn-intl.com>

Portable Electric Systems

I-CORP International, Inc.
6072 N. Ocean Blvd.
Ocean Ridge, FL 33435
Phone: (561) 369-0795
Fax: (561) 369-0895
Website: <http://www.geosynthetic.com>

Leak Location Services, Inc.
16124 University Oak
San Antonio, TX 78249
Phone: (210) 408-1241
Fax: (210) 408-1242
Website: <http://www.llsi.com>

Soil Gas

Tracer Research Corporation
3755 North Business Center Drive
Tucson, AZ 85705-2944
Phone: (800) 394-9929
Fax: (520) 293-1306
Website: <http://www.tracertight.com>

Time Domain Reflectometry Probes

Dynamax, Inc.
10808 Fallstone Suite 350
Houston, TX 77099
Phone: (281) 564-5100
Fax: (281) 564-5200
Website: <http://www.dynamax.com>

Soilmoisture Equipment, Inc.
P.O. Box 30025
Santa Barbara, CA 93105
Phone: (805) 964-3525
Fax: (805) 683-2189
Website: <http://soilmoisture.com>

Campbell Scientific, Inc.
815 West 1800 North
Logan, Utah 84321-1784
Phone: (435) 753-2342
Fax: (435) 750-9540
Website: <http://www.campbellsci.com>

Time Domain Reflectometry Sensor Cable

Perma-Pipe, Inc.
7720 North Lehigh Ave.
Niles, IL 60714
Phone: (847) 966-2235
Fax: (847) 470-1204
Website: <http://www.permapipe.com>