

**THIRD FIVE-YEAR REVIEW REPORT FOR
BOOMSNUB/AIRCO SUPERFUND SITE
HAZEL DELL, WASHINGTON**



PREPARED BY

United States Army Corps of Engineers (USACE)
Seattle District
Seattle, Washington

Approved by:

Cami Grandinetti

Cami Grandinetti, Program Manager

Date:

9/13/13

[This page is intentionally left blank.]

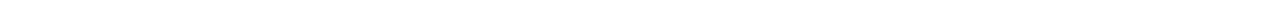

Executive Summary

The Boomsnub/Airco Superfund Site is located north of Vancouver in Hazel Dell, Washington. The Boomsnub property is a former chrome-plating facility. The Linde facility, formerly known as BOC Gases or Airco, is an 11-acre active gas production facility. Volatile organic compounds (VOCs) were discovered in 1991 at the Linde facility during response to releases of chromium at the Boomsnub facility. The Site also includes a plume of groundwater contamination that emanates from beneath the two facilities and originally extended 4,000 feet down-gradient in a west-northwest direction to approximately NE 30th Avenue. Currently, the toe-of-plume extends 2,500 feet and is located west of the fence line in the field north of NE 78th Street and east of the Church of God building.

The Site is divided into three operable units (OUs) to manage cleanup activities:

- Boomsnub Soil – OU 1
- BOC Soil – OU 2
- Site-Wide Groundwater – OU 3

Initial response at OU 1 included removal in 1994 of site buildings and plating tanks along with more than 6,000 tons of chromium-contaminated soil. An extraction system was installed at OU 3 in 1990 and has been modified, upgraded, and expanded several times to handle the VOCs and chromium, to increase pumping and treatment capacity, and to increase removal efficiency.

The United States Environmental Protection Agency (EPA) issued a Record of Decision (ROD) in 1997 selecting an interim action that would continue operation of the groundwater extraction and treatment system. In 2000, EPA issued the final ROD for OUs 1 and 3. The selected remedy for OU 1 was Institutional Controls (ICs) and removal of most contaminated soils that were accessible and a source for groundwater contamination. The selected remedy for OU 3 was continued groundwater extraction and treatment until groundwater cleanup levels are achieved throughout the groundwater plume. An Explanation of Significant Differences (ESD) was issued in 2006 to enhance ICs and to address changes to the extraction and treatment system.

The BOC Gases facility (OU 2) is being addressed under a September 2001 Action Memorandum to address VOC sources, treat contaminated groundwater on the property, and halt migration off-property. A Consent Decree between EPA and Linde was signed in 2007. The Consent Decree requires Linde to implement the remainder of response actions at the Site until VOCs meet cleanup levels and to pay certain past costs and future oversight costs.

In 2001, approximately 2,500 cubic yards of chromium-contaminated soil was excavated from OU 1 and disposed off-site. During the excavation, EPA discovered that chromium-contaminated soil with concentrations above ROD cleanup levels extended under the groundwater extraction and treatment system. The soil was not removed due to its location and was further characterized in 2003. Since it is a relatively small quantity of contaminated soil, any contaminants that may leach into the groundwater would have minimal impact. This layer of soil will be excavated upon completion of the remedial actions for groundwater and removal of the groundwater treatment system.

Five soil vapor extraction (SVE) well pairs and nine in-well stripping (IWS) wells were installed at OU 2 in 2004 to remove VOCs. The SVE system reached asymptotic conditions and was shut down in 2006. In August 2013, EPA approved the temporary cessation of pulse pumping of the IWS system. This will be accompanied by increased monitoring of wells in the IWS area in addition to those down gradient of the IWS area. Final termination of the IWS system will be considered once the additional data are collected. The granular activated carbon (GAC) treatment system for the remaining IWS wells was discontinued in 2009 when it was determined that off-gas concentrations were significantly lower than the regulatory limits for air releases and did not pose a risk to human health and the environment.

An extensive groundwater extraction network is used to capture the contaminated groundwater in OU 3. The extraction system consists of 26 extraction wells screened in the alluvial aquifer and approximately 10,000 feet of piping used to transport extracted groundwater to a central treatment system on the Boomsnub property. The maximum pumping rate capacity is 160 gallons per minute. The central treatment system removes chromium using an ion-exchange system and removes VOCs using air stripping with GAC treatment of the off-gas. Treated water is discharged via force main to the infiltration gallery on the Linde property.

In September 2006, the Toe-of-Plume Pilot Study (TOPPS) in-situ remediation was initiated to treat residual contamination located near extraction well MW-41. This area is believed to be located in the low-permeability silt layer at a depth of approximately 80 to 90 feet below ground surface (bgs). EHC-M™ was injected into the alluvial aquifer to treat recalcitrant trichloroethene (TCE) and chromium contamination. EHC-M™ is a combination of controlled-release carbon and zero-valent iron particles which stimulates reductive dechlorination of TCE and chemical reduction/precipitation of chromium. Post-remediation monitoring indicates EHC-M™ was effective at reducing TCE and chromium concentrations to levels below cleanup levels.

The Northern Plume was identified in 2007 when TCE concentrations at well AMW-18 increased significantly. Since that time, two investigations have been completed to determine the extent and potential source areas. The 2011 investigation concluded that the source of the Northern Plume was not the same as the OU 3 source as evidenced by the geographic location of the Northern Plume in relation to the Linde facility. Supporting evidence included the lack of detections for CFC-11, which has historically been an indicator of the OU 3 TCE plume from the Linde property. In 2011, AMW-17, the closest well down-gradient from AMW-18, experienced an increase in TCE concentrations. Since TCE concentrations at AMW-18 have been declining, it is assumed that the Northern Plume is detached from the source area and moving down-gradient as a slug of contaminated groundwater.

ICs were established to assure that the remedial action will continue to protect human health and the environment. EPA is responsible for implementing, monitoring, and enforcing ICs related to OU 1 and Linde is responsible for ICs related to OU 2 and OU 3. ICs exist in the form of public notice during operation of the groundwater extraction and treatment system, which is accomplished by providing affected property owners with a copy of biannual groundwater quality sampling data for their property for all contaminants exceeding cleanup standards. Long-term compliance monitoring for contaminated groundwater is required to assess the operational efficiency of the extraction and treatment system, to monitor groundwater contaminant migration, and determine when ICs can be

removed. There are site access restrictions to the Boomsnub property for the duration of the extraction and treatment system's operation. ICs also include deed restrictions and controlled site access for the Linde property.

The remedy is functioning as intended by the decision documents. All accessible chromium-contaminated soil at OU 1 has been removed. VOCs have been removed from the vadose zone at OU 2. EPA approved the temporary cessation of pulse pumping of the in-well stripping system and is monitoring the impacts of this action. In August 2013, all the IWS wells have stopped operation, in conjunction with increased monitoring of this area. Final termination of the IWS system will be considered once additional data are collected. The groundwater extraction system for OU 3 continues to remove contaminants and decrease the size of the plume. In-situ treatment with EHC-MTM has proven effective at removing contaminants in areas of recalcitrant residual contamination at the toe-of-plume. Investigations of the Northern Plume have determined that it is detached from the source and is attenuating as it moves down-gradient. The groundwater monitoring program has been optimized, although slight changes to the annual evaluation may be needed. Access agreements/restrictive covenants have been obtained for fourteen properties. Additional access agreements and a deed restriction for the Boomsnub property are still required as described in the ROD and ESD. Changes to toxicity factors have been made, but cleanup standards are still within an acceptable level of risk. Recent development of the sports fields does not impact exposure pathways previously identified.

Five-Year Review Summary Form

SITE IDENTIFICATION		
Site Name: Boomsnub/Airco Superfund Site		
EPA ID: WAD009624453		
Region: 10	State: WA	City/County: Hazel Dell, Clark County
SITE STATUS		
NPL Status: Final		
Multiple OUs? Yes	Has the Site achieved construction completion? No	
REVIEW STATUS		
Lead agency: EPA If "Other Federal Agency" was selected above, enter Agency name:		
Author name (Federal or State Project Manager): Claire Hong		
Author affiliation: EPA Remedial Project Manager		
Review period: 10/10/2012 - 8/20/2013		
Date of Site inspection: 10/18/2012		
Type of review: Statutory		
Review number: 3		
Triggering action date: 9/24/2008		
Due date (five years after triggering action date): 9/24/2013		

Five-Year Review Summary Form (continued)

Issues/Recommendations				
OU(s) without Issues/Recommendations Identified in the Five-Year Review:				
None				
Issues and Recommendations Identified in the Five-Year Review:				
OU(s): OU 1	Issue Category: Institutional Controls			
	Issue: Deed restrictions to limit future use of the Boomsnub property have not been formally recorded.			
	Recommendation: Record deed restrictions to maintain industrial use of the Boomsnub property and prevent soil disturbance below 15 feet.			
Affect Current Protectiveness	Affect Future Protectiveness	Implementing Party	Oversight Party	Milestone Date
No	Yes	EPA	EPA	1/1/2015
OU(s): OU 2	Issue Category: Remedy Performance			
	Issue: Spikes in TCE concentrations observed at AMW-2A and AMW-12A located down-gradient of the IWS wells.			
	Recommendation: Complete an evaluation/optimization on the operation of the remaining IWS wells and develop a groundwater exit strategy consistent with EPA guidance.			
Affect Current Protectiveness	Affect Future Protectiveness	Implementing Party	Oversight Party	Milestone Date
No	Yes	PRP	EPA	1/1/2014
OU(s): OU 3	Issue Category: Institutional Controls			
	Issue: Access agreements and restrictive covenants have not been obtained for all properties with groundwater extraction system infrastructure.			
	Recommendation: Obtain access agreements and restrictive covenants from remaining high priority properties.			
Affect Current Protectiveness	Affect Future Protectiveness	Implementing Party	Oversight Party	Milestone Date
No	Yes	PRP	EPA	1/1/2014

Protectiveness Statement(s)	
Operable Unit: OU 1	Protectiveness Determination: Will be Protective
Protectiveness Statement: The remedy at OU 1 is expected to be protective of human health and the environment upon completion. In the interim, exposure pathways that could result in unacceptable risk are being controlled. All accessible chromium-contaminated soil has been removed to a depth of 15 feet below ground surface and site access is restricted.	

Operable Unit:
OU 2

Protectiveness Determination:
Will be Protective

Protectiveness Statement:

The remedy at OU 2 currently protects human health and the environment. Active soil treatment has been temporarily stopped while data on groundwater impacts is being collected. Exposure pathways that could result in unacceptable risk for groundwater are being controlled using institutional controls to prevent consumption of groundwater. In order for the remedy to be protective in the long-term, continued extraction and treatment of groundwater to prevent migration is necessary.

Operable Unit:
OU 3

Protectiveness Determination:
Will be Protective

Protectiveness Statement:

The remedy at OU 3 currently protects human health and the environment. Exposure pathways that could result in unacceptable risk are being controlled through institutional controls. In order for the remedy to be protective in the long-term, continued extraction of groundwater to reduce the plume size and completion of access agreements and restrictive covenants are necessary.

Contents

Executive Summary	i
List of Tables	viii
List of Figures	ix
Appendices	ix
List of Abbreviations	x
1. Introduction	1
1.1. Purpose.....	1
1.2. Authority.....	1
2. Site Chronology	2
3. Background	3
3.1. Physical Characteristics	3
3.1.1. Site Geology	4
3.1.2. Hydrogeology	5
3.2. Land and Resource Use.....	5
3.3. History of Contamination	6
3.4. Initial Response.....	6
3.5. Basis for Taking Remedial Action.....	7
4. Remedial Actions	7
4.1. Remedial Action Objectives.....	7
4.2. Remedy Description	9
4.3. Remedy Implementation	10
4.4. Systems Operations/Operations & Maintenance	13
4.4.1. Systems Operations/O&M Requirements	14
4.4.2. Systems Operations/O&M Operational Summary.....	15
4.4.3. Summary of Costs of System Operations/O&M Effectiveness	17
5. Progress Since the Last Five-Year Review	17
5.1. Protectiveness Statements from Last Review.....	17
5.2. Status of Recommendations and Follow-up Actions from Last Review.....	18
6. Five-Year Review Process	19
6.1. Administrative Components.....	19
6.2. Community Involvement.....	19

6.3.	Document review	20
6.4.	Data Review	20
6.4.1.	Water Levels.....	20
6.4.2.	Monitoring Program	20
6.4.3.	Analytical Data.....	22
6.5.	Site Inspection	25
6.6.	Interviews	26
6.7.	Institutional Controls	27
7.	Technical Assessment	28
7.1.	Question A: Is the remedy functioning as intended by the decision documents?...28	
7.2.	Question B: Are the exposure assumptions, toxicity data, cleanup levels, and remedial action objectives (RAOs) used at the time of the remedy selection still valid?30	
7.3.	Question C: Has any other information come to light that could call into question the protectiveness of the remedy?.....36	
7.4.	Technical Assessment Summary.....36	
8.	Issues	37
9.	Recommendations and Follow-up Actions	37
10.	Protectiveness Statements.....	38
11.	Next Review	39

List of Tables

Table 1.	Chronology of Site Events.....	2
Table 2.	OU 1 COC Cleanup Levels for Soil	8
Table 3.	OU 3 Cleanup Levels for Groundwater.....	9
Table 4.	Areas of IC Interest: Boomsnub/Airco Superfund Site	12
Table 5.	Operating IWS Wells and Associated Compliance Monitoring Wells	16
Table 6.	Annual System Operations/O&M Costs.....	17
Table 7.	Subset of Monitoring Wells Used to Statistically Evaluate Long-Term Compliance with Cleanup Levels.....	21
Table 8.	Changes in Chemical-Specific Standards.....	33
Table 9.	Changes in Action-Specific Requirements.....	34
Table 10.	Changes in Location-Specific Requirements	36
Table 11.	Issues.....	37
Table 12.	Recommendations and Follow-up Actions.....	37

List of Figures

Figure 1. Site Location Map.....	43
Figure 2. OU 2 Treatment and Monitoring Wells.....	44
Figure 3. OU 3 Extraction and Monitoring Well Groupings.....	45
Figure 4. Groundwater Treatment Process.....	46
Figure 5. Groundwater Treatment Biweekly System Monitoring Checklist	47
Figure 6. Cumulative Mass Removal between 1999 and 2011	48
Figure 7. Alluvial Aquifer Groundwater Contours, Fall 2011.....	49
Figure 8. Troutdale Aquifer Groundwater Contours, Fall 2011	50
Figure 9. Chromium Plume Map, 1995 vs. 2011	51
Figure 10. TCE Plume Map, 1995 vs. 2011	52
Figure 11. Vertical Distribution of TCE in the Alluvial Aquifer, 2006.....	53
Figure 12. TCE Concentrations, 2011 Northern Plume Investigation	54
Figure 13. Easement Status as of September 2012	55

Appendices

Appendix A. Documents Reviewed
Appendix B. Site Inspection Checklist
Appendix C. Site Inspection Photographs
Appendix D. Interview Transcripts
Appendix E. Data Summary
Appendix F. Public Notice

List of Abbreviations

1,1,1-TCA	1,1,1-trichloroethane
AOC	Administrative Order on Consent
bgs	below ground surface
CERCLA	Comprehensive Environmental Response, Compensation and Liability Act
CFR	Code of Federal Regulations
COC	contaminant of concern
CPU	Clark Public Utilities
DCE	dichloroethene
Ecology	Washington State Department of Ecology
EPA	United States Environmental Protection Agency
ESD	Explanation of Significant Differences
Freon-11	trichlorofluoromethane
GAC	granular activated carbon
gpm	gallons per minute
IAG	Interagency Agreement
IC	institutional control
IWS	in-well stripping
µg/L	micrograms per liter
MAROS	Monitoring and Remediation Optimization System
MCL	maximum contaminant level
mg/kg	milligrams per kilogram
MTCA	Model Toxic Control Act
NCP	National Contingency Plan
O&M	operation and maintenance
OU	operable unit
PCE	tetrachloroethene
PDT	project delivery team
PID	photoionization detector
POTW	publicly owned treatment works
ppb	parts per billion
ppm	parts per million
RAO	remedial action objective
ROD	Record of Decision
RPM	Remedial Project Manager
SVE	soil vapor extraction
TBC	toxicity based criteria
TCA	tetrachloroethane
TCE	trichloroethene
TOPPS	Toe-of-Plume Pilot Study
UAO	Unilateral Administration Order
USACE	United States Army Corps of Engineers
VOC	volatile organic compound
WAC	Washington Administrative Code

This page intentionally left blank for double-sided printing.

1. Introduction

This is the third Five-Year Review report of remedial actions for the Boomsnub/Airco Superfund Site in Hazel Dell, Washington (EPA ID: WAD009624453). The triggering action for this statutory review is the previous Five-Year Review report completed in 2008. The Five-Year Review is required due to the fact that hazardous substances, pollutants, or contaminants remain at the Site above levels that allow for unlimited use and unrestricted exposure.

The Site consists of three operable units (OUs): Boomsnub Soil (OU 1), BOC Soil (OU 2), and Site-Wide Groundwater (OU 3). This Five-Year Review addresses all the OUs at the Boomsnub/Airco Site.

1.1. Purpose

The purpose of five-year reviews is to determine whether the remedy at a site is protective of human health and the environment. The methods, findings, and conclusions of reviews are documented in Five-Year Review reports. In addition, Five-Year Review reports identify issues found during the review, if any, and recommendations to address them.

1.2. Authority

The United States Environmental Protection Agency (EPA) is preparing this five-year review pursuant to Comprehensive Environmental Response, Compensation and Liability Act (CERCLA) §121 and the National Contingency Plan (NCP). CERCLA §121 states:

If the President selects a remedial action that results in any hazardous substances, pollutants, or contaminants remaining at the site, the President shall review such remedial action no less often than each five years after the initiation of such remedial action to assure that human health and the environment are being protected by the remedial action being implemented. In addition, if upon such review it is the judgment of the President that action is appropriate at such site in accordance with section [104] or [106], the President shall take or require such action. The President shall report to the Congress a list of facilities for which such review is required, the results of all such reviews, and any actions taken as a result of such reviews.

The EPA interpreted this requirement further in the NCP; 40 Code of Federal Regulations (CFR) §300.430(f)(4)(ii) states:

If a remedial action is selected that results in hazardous substances, pollutants, or contaminants remaining at the site above levels that allow for unlimited use and unrestricted exposure, the lead agency shall review such action no less often than every five years after the initiation of the selected remedial action.

The EPA Region 10 has conducted a five-year review of the remedial actions implemented at the Boomsnub/Airco Site in Vancouver, WA. This review was performed by the United States Army

Corps of Engineers (USACE), on behalf of EPA, from October 2012 through June 2013. This report documents the results of the review. The Seattle District USACE project delivery team (PDT) prepared this Five-Year Review through an Interagency Agreement (IAG) between EPA Headquarters and USACE.

2. Site Chronology

Table 1. Chronology of Site Events

Event	Date
Washington Department of Ecology (Ecology) identified chromium in the groundwater.	1986
Additional investigation was conducted by Ecology to determine the lateral extent of contamination.	1990-1994
Ecology issued enforcement order pursuant to the Model Toxics Control Act (MTCA) to Boomsnub requiring company to extract and treat chromium contaminated groundwater, monitor existing on-site wells, and conduct groundwater studies.	May 1990
Extraction and treatment system operated.	1990-present
Boomsnub installed pumping wells and began the extraction and treatment of groundwater under order from Ecology	May 1990
Ecology assumed financial responsibility for operating extraction and treatment system.	August 1990
Ecology determined volatile organic compounds (VOCs) were present in groundwater at concentrations presenting human health concerns.	1991
BOC Gases (Linde) conducted investigations.	1991-1994
Agreed Order between Ecology and BOC Gases (Linde) was signed.	1993
EPA issued Unilateral Administration Order to obtain property access from Boomsnub.	May 1994
EPA assumed responsibility for operation of the extraction and treatment system.	June 1994
EPA completed removal of 6,000 tons of chromium-contaminated soil.	1994
The Site was listed on the NPL (60 Fed. Reg. 20330).	April 25, 1995
EPA and BOC Gases (Linde) entered into Administrative Order on Consent (AOC) requiring BOC Gases to conduct a Site evaluation at its facility.	January 1997
Interim Action Record of Decision (ROD) selected groundwater extraction and treatment as interim remedy.	September 1997
EPA operated groundwater treatment system.	January 1998-April 2002
Remedial Investigation/Feasibility Study was completed.	July 1999
ROD selected extraction and treatment as the foundation for the final remedy.	February 2000
Consent Decree was issued to obtain past costs from Boomsnub.	March 2000

Event	Date
EPA and BOC Gases entered into AOC to construct a sewer pipeline and pump station.	January 2001
BOC Gases constructed gravity sewer.	January-September 2001
EPA removed an additional 2,500 cy of chromium-contaminated soil at Boomsnub facility.	March-April 2001
EPA issued an Action Memorandum identifying requirements for remediation activities at OU 2.	September 2001
Remedial System Evaluation was completed.	February 2002
EPA and BOC Gases entered into AOC, pursuant to which BOC Gases assumed responsibility for operation and maintenance of the groundwater extraction/treatment system.	April 2002
EPA and BOC Gases entered into AOC non time-critical removal action requiring installation of in-well stripping and soil vapor extraction system at OU 2.	September 2002
BOC Gases installs in-well stripping and soil vapor extraction at its facility.	September 2003 – February 2004
First Five-Year Review	September 2003
BOC Gases constructs infiltration gallery for disposal of treated groundwater.	November 2004-June 2005
EPA issues Explanation of Significant Differences (ESD), addressing modified pumping rate, upgrade of ion-exchange and air-stripping systems, use of infiltration gallery, and institutional controls.	August 2006
BOC Gases conducts Toe-of-Plume Pilot Study (TOPPS).	September 2006
EPA and Linde enter into Consent Decree requiring Linde to implement the remainder of the response actions until VOCs meet cleanup levels and to pay past costs and future oversight costs.	July 2007
Continuous operation of the SVE system was stopped. Pulse pumping of a subset of IWS wells was started.	February 2008
Second Five-Year Review	September 2008
Linde conducts initial Northern Plume investigation.	August 2008
Significant decrease in frequency of sentinel well monitoring.	2008
GAC treatment at IWS wells was discontinued.	October 2009
Linde conducts second Northern Plume investigation	December 2011

3. Background

3.1. Physical Characteristics

The Boomsnub/Airco Site is located north of Vancouver in Hazel Dell, Washington. The Site is approximately two miles east of Interstate 5 and one mile west of Interstate 205, near NE 78th Street and NE 47th Avenue (see Figure 1). The Boomsnub property is approximately 0.75 acres, located at

7608 NE 47th Avenue, and is bordered by a mixture of residential, commercial, and light industrial properties. The Linde facility, formerly known as BOC Gases or Airco, is an 11-acre, active gas production facility. It is located across NE 47th Avenue from the Boomsnub property at 4758 NE 78th Street (see Figure 1). The Site also includes a plume of groundwater contamination that emanates from beneath the two facilities and originally extended 4,000 feet down-gradient in a west-northwest direction to approximately NE 30th Avenue. Currently the plume extends 2,500 feet, and the new toe-of-plume is located west of the fence line in the field north of NE 78th Street and east of the Church of God building (see Figure 3). There are no known flood plains, endangered species, historical landmarks, or structures with historical significance identified at the Site. Designated wetlands have been identified along the south side of NE 78th Street just west of St. Johns Road, in the vicinity of extraction well MW-19D (well MW-19D is one of the intermediate wells shown on Figure 3).

Although there are several surface water features in this area of Clark County, none of them is close enough to be impacted by the current extent of contamination. Vancouver Lake is a large lake that lies 3.5 miles west of the Site. Salmon Creek, the largest nearby creek, drains portions of Clark County flowing generally west approximately 2.5 miles north of the Site. Tributary streams to Salmon Creek that drain the area near the Site include Cougar Creek, Tenny Creek, and an unnamed intermittent stream, all of whose headwaters are located 1 to 1.5 miles north or northwest of the Boomsnub property, generally flowing away from the Site to the northwest. The Burnt Bridge/Salmon Creek drainage divide runs northeast across the Site, approximately 0.5 miles west of the Linde property. Surface water to the north and west of the divide flows into Salmon Creek. Surface water to the south and east of the divide flows into Burnt Bridge Creek via Cold Canyon. Both the Linde and Boomsnub properties are located to the east of this surface water divide.

3.1.1. Site Geology

Four principal geologic units underlie the site. From top to bottom they are: recent flood alluvium, Pleistocene alluvial deposits (alluvial aquifer), the Upper Troutdale formation, and the Lower Troutdale formation. Following are descriptions of the two principal hydrogeologic units of concern in the general area of the Site:

- The alluvial deposits consists of highly permeable sands with varying amounts of silt that grade to fine sand, silts, and clays. This unit ranges from 60 to 140 feet thick. The silts and clays at the base of the unit act as an aquitard that ranges in thickness from 6 to 30 feet. A general thickening of the deposits occurs west of the Boomsnub property in a northeast-southwest trending band, which is generally referred to as the “trough” area.
- The Upper Troutdale formation consists of gravel and cobbles in a sandy matrix with limited silt. The upper portion of the formation contains a higher silt content than the rest of the underlying aquifer.

3.1.2. Hydrogeology

Depth to groundwater in the alluvial aquifer ranges from 10 to 40 feet below ground surface (bgs). Typical annual fluctuations in groundwater elevations are less than 2 feet. Groundwater flows toward the west-northwest at an estimated seepage velocity of about 100 to 200 feet per year. Vertical gradients result in downward flow in the alluvial aquifer. Groundwater in the Upper Troutdale aquifer flows toward the west-southwest and this aquifer has a higher permeability than the alluvial aquifer. Seepage velocities in the Upper Troutdale aquifer have been estimated at about 3,000 feet per year. Groundwater elevations in the Upper Troutdale formation are below the elevation of the aquitard, suggesting that in some locations the alluvial aquifer is perched. The Upper Troutdale aquifer is the source of drinking water for approximately 65,000 residents in Clark County.

3.2. *Land and Resource Use*

The Site includes two adjacent facilities, the former Boomsnub Corporation (Boomsnub) chrome-plating facility and the Linde facility. Linde (formerly BOC Gases or Airco) owns and operates an industrial gas production facility adjacent to the Boomsnub property. The Linde plant manufactures compressed and liquefied gas products including nitrogen, oxygen, and argon. The plant also stores and distributes other specialty gases such as hydrogen, acetylene, and helium. The facility was built by Air Liquide America Corporation in 1963 and has been in operation since 1964. The Boomsnub Corporation and its predecessor company, Pioneer Plating, conducted chrome-plating operations at this location from 1967 until 1994, when Boomsnub moved its business to 3611 NE 68th Street. The electroplating process used by Boomsnub involved the use of a chromic acid solution containing hexavalent chromium (chromium VI).

The Boomsnub property and parcels immediately adjacent are currently zoned for light industrial use. The Linde property is also zoned for light industrial use, but it is located nearer a residential development that borders the southwest corner of the property. Businesses in the immediate area include the former Permalume Plastics immediately east of the Linde property, GL&V Celleco (fiberglass tank manufacturer), Electroheavy (electrical motor shop), Clark County Maintenance Yard, and several gas stations. The area related to the down-gradient groundwater contamination is made up of land zoned for commercial, light industrial, and residential uses. Recent development includes sports fields on the Clark County Parks and Church of God properties.

There are several private wells in the alluvial and Upper Troutdale aquifers in the general area of the Site. None of the private wells within the area of groundwater contamination are currently being used for drinking water. Those residents whose wells have been affected by the groundwater contamination in the alluvial aquifer or are located within the path of the groundwater contaminant plume are connected to the municipal water system owned by the local water purveyor, Clark Public Utilities (CPU). CPU has water supply wells in the Upper Troutdale formation; the closest of these wells is approximately 1 mile west of the Boomsnub property. Site-related contamination has not been found in this well.

3.3. *History of Contamination*

EPA divided the Site into three OUs to manage cleanup activities:

- Boomsnub Soil – OU 1
- BOC Soil – OU 2
- Site-Wide Groundwater – OU 3

Chromium was identified in Boomsnub soils and groundwater by Washington Department of Ecology (Ecology) in 1986. In 1990, Boomsnub reported a significant increase in hexavalent chromium in one of the monitoring wells. The company also stated that a break in its drinking water main released approximately 300,000 gallons of water to the soil beneath the facility, which may have contributed to this increase. In May 1990, Ecology issued an enforcement order requiring monitoring, groundwater studies, and extraction and treatment of groundwater. Boomsnub installed the extraction system, but due to Boomsnub's limited financial resources, Ecology assumed responsibility for operating the extraction system in August 1990. In 1993, because of limits to its own financial resources, Ecology requested that EPA list the Site on the NPL. In June 1994, EPA assumed the role of lead agency. The Site was listed on the NPL on April 25, 1995.

In 1991, during the course of the cleanup at Boomsnub, Ecology discovered volatile organic compounds (VOCs) in the groundwater. Based on the concentrations and types of chemicals found in groundwater, Ecology suspected BOC Gases as the source of the contamination. Since the identification of the VOC plume in 1991, Linde has undertaken a number of steps to identify the extent of the VOC plume, to mitigate the plume, and to control plume migration. Trichloroethene (TCE) was identified as one of the main contaminants of concern due to its high mobility in water; tetrachloroethene (PCE), 1,1,1-trichloroethane (1,1,1-TCA), and trichlorofluoromethane (Freon-11) were also detected.

3.4. *Initial Response*

In 1994, EPA removed 400 drums of waste, demolished and removed site buildings and plating tanks, and removed more than 6,000 tons of chromium-contaminated soil from OU 1 and disposed the soil off-site. The soil excavation area was 70 feet in diameter by 28 feet deep, the depth where the water table was encountered. This action removed the majority of contaminated soils; however, post-removal sampling activities indicated that some chromium-contaminated soil remained above the water table.

A Site Evaluation was completed at OU 2, the BOC Gases property, to identify any sources of VOCs in soil warranting a removal action. There was no widespread contamination justifying a soil removal; there was evidence suggesting a source of residual VOCs near the water table.

Contaminated groundwater in OU 3 has been extracted and treated since 1990. The original system consisted of a single extraction well on the Boomsnub property. Since 1990, the system has been modified, upgraded, and expanded several times to address both VOCs and chromium, to increase pumping and treatment capacity, and to increase contaminant-removal efficiency.

3.5. *Basis for Taking Remedial Action*

The primary concern at the Site is chromium and TCE in groundwater, which has migrated from the soils. At its maximum historical extent, the groundwater plume in the alluvial aquifer extended three-quarters of a mile. Contamination also threatens the CPU public drinking water supply wells in the Upper Troutdale aquifer. Groundwater contamination in the alluvial aquifer increases in depth (i.e. migrates downward) with increasing distance from the source areas. TCE has been detected at low concentrations in the Upper Troutdale aquifer. A secondary concern is contaminants at the soil OUs.

The primary contaminants of concern (COCs) for groundwater are hexavalent and total chromium, TCE, bromodichloromethane, carbon tetrachloride, dibromochloromethane, 1, 1-dichloroethene (DCE) cis-1, 2-DCE, trans-1,2-DCE, and PCE. In addition, to address concerns that 1,4-dioxane might be present at the Site, a limited number of samples were collected from selected wells and the groundwater extraction and treatment system influent and effluent, and analyzed for 1,4-dioxane. The samples were collected in March 2003, and also during semiannual sampling events in spring 2003, fall 2003, and spring 2004. Low concentrations of 1,4-dioxane were detected in wells near the TCE source area; concentrations were further reduced downgradient of the source area. The results indicated there was no need to modify the extraction and treatment system. No further effluent sampling for 1,4-dioxane was required following the spring 2004 sampling event because the results remained consistent with previous sampling results (low 1,4-dioxane concentrations of 1.1 micrograms per liter ($\mu\text{g/L}$)).

4. Remedial Actions

EPA issued an interim action ROD in 1997 to allow continued operation of the groundwater extraction and treatment system. In 2000, EPA issued the final ROD. The selected remedy for OU 1 was institutional controls (ICs) and removal of most contaminated soils that were considered accessible and a source for groundwater contamination. The selected remedy for OU 3 was continued groundwater extraction and treatment until groundwater cleanup levels are achieved throughout the groundwater plume. As ESD was issued in 2006 to address changes to extraction and treatment system and enhanced ICs.

OU 2 is being addressed under an Action Memorandum issued in September 2001 to address VOC sources, treat contaminated groundwater on the property, and halt migration off-property. A Consent Decree was signed in 2007 with Linde in which Linde agreed to implement the remainder of response actions until VOCs meet cleanup levels and to pay for certain past costs and future oversight costs.

4.1. *Remedial Action Objectives*

The 2000 ROD established the following remedial action objectives (RAOs) for Boomsnub Soil (OU 1):

- Prevent hexavalent chromium in soil from serving as an uncontrolled, ongoing source of contamination to the down-gradient groundwater plume.

- Prevent future workers from being exposed to lead and chromium in soils at levels above industrial cleanup standards.
- Prevent future residential use of the Boomsnub property through deed restrictions precluding future residential uses of the property.

The contaminants of concern and the corresponding cleanup levels for OU 1 presented in the ROD are shown in Table 2.

Table 2. OU 1 COC Cleanup Levels for Soil

Contaminant of Concern	Cleanup Level (mg/kg)	Basis for Cleanup Level
Total Chromium	400	Site-specific remediation level ¹
Chromium VI (hexavalent)	8	MTCA 100x groundwater standard ²
	17,500	MTCA C Industrial
Chromium III	1,600	MTCA 100x groundwater standard ²
Lead	1,000	MTCA A Industrial ³

Notes:

¹ The Site-specific remediation level will be demonstrated to be effective achieving the Model Toxic Control Act (MTCA) groundwater cleanup standard (80 µg/L) for hexavalent chromium at nearby monitoring wells. Hexavalent chromium remaining in soil at levels between 400 ppm and 8 ppm will be allowed to infiltrate to groundwater for *ex-situ* groundwater treatment.

² The soil cleanup level represents 100 times the MTCA groundwater cleanup level reported in the Ecology Cleanup Levels and Risk Calculations II database dated 2/28/96.

³ The MTCA Method A Industrial value for lead is shown (no Method C Industrial value exists for lead).

The September 2001 Action Memorandum for OU 2 (Linde property) included the following objectives:

- Remove VOCs from the vadose zone that may be acting as the source to groundwater.
- Remove VOCs from the groundwater on the western portion of the Linde property.
- Halt off-property migration of VOCs in groundwater.

The 2000 ROD established the following RAOs for OU 3 groundwater remediation:

- Prevent further impacts to the alluvial aquifer.
- Restore impacted groundwater to drinking water standards (Maximum Contaminant Levels [MCLs] or Model Toxic Control Act [MTCA] B standards).
- Prevent ingestion of contaminated groundwater above federal and state drinking water standards.
- Prevent impacts to the Upper Troutdale aquifer and the public drinking water supply by reducing contamination in the alluvial aquifer.

The primary COCs for groundwater at OU 3 are chromium, TCE, and 1,1-DCE. Remediation goals have been established for the primary COCs, for other COCs that have been detected in monitoring wells at levels above MCLs or MTCA cleanup standards, and for degradation products of TCE.

Cleanup levels are shown in Table 3. The area of attainment where these goals apply is throughout the groundwater plume in the alluvial aquifer and at the existing monitoring wells in the Upper Troutdale aquifer.

Table 3. OU 3 Cleanup Levels for Groundwater

Contaminant of Concern	Cleanup Level (µg/L)	Basis for Cleanup Level ¹
chromium VI (hexavalent)	80	MTCA B
total chromium	100	MCL
bromodichloromethane	1	MTCA B
carbon tetrachloride	1	MTCA B
1,2-dibromo 3-chloropropane	0.2	MCL
dibromochloromethane	1	MTCA B
1,2-dichloromethane	5	MCL
1,1-DCE	1	MTCA B
PCE	5	MCL
1,1,1-trichloroethane	200	MCL
TCE	5	MCL

Notes:

¹MTCA – Model Toxic Control Act; MCL – maximum contaminant level

4.2. Remedy Description

Remedial actions identified in the 2000 ROD for OU 1 included:

- Excavate soils with total chromium concentrations above 400 parts per million (ppm) to a maximum depth of 15 feet.
- Treat hexavalent chromium in soils at a concentration greater than 8 ppm and less than 400 ppm by allowing infiltration of hexavalent chromium to groundwater for treatment by the selected groundwater remedy.
- Excavate soils with lead concentrations above 1,000 ppm.
- Place deed restrictions on the Boomsnub property to maintain industrial land use of the property and to prevent soil below 15 feet from being disturbed.
- Control access to the Boomsnub property.
- Conduct long-term groundwater monitoring to demonstrate that cleanup standards for hexavalent chromium have been achieved.

Remedial actions for source control at OU 2 included in-well stripping and soil vapor extraction. IWS is an *in-situ* treatment process in which air-lift pumping is used to move groundwater through a vertical circulation well. The VOCs dissolved in the water are stripped from the groundwater within the well casing by the injected air. SVE is an *in-situ* soil treatment process in which a vacuum is applied to a well screened above the groundwater table to remove air from the soil pore space. Along with the air, VOCs are extracted and treated using granular activated carbon (GAC).

Remedial actions for Site-wide groundwater (OU 3) are identified in the 1997 and 2000 RODs. The 1997 ROD included the interim actions for installing additional monitoring wells near the leading edge

of the plume, upgrading some extraction wells, and acquiring/constructing office and storage space for the extraction and treatment systems. The 2000 ROD identified the following actions:

- Increase capacity of the groundwater treatment system by upgrading the ion-exchange and air-stripper and by increasing capacity of the conveyance pipe and discharge pipe.
- Improve the treatment building and other facility structures.
- Continue extract from existing wells, and add new wells as needed to optimize removal and treatment.
- Conduct long-term groundwater monitoring.
- Provide institutional controls in the form of public notice during operation of the groundwater pump and treat system, accomplished by providing affected property owners a copy of groundwater sampling data for their property for all contaminants exceeding cleanup standards.
- Discharge treated water to the City of Vancouver publicly owned treatment works (POTW) in compliance with a permit.
- Dispose of waste from ion-exchange resin at an appropriate Resource Conservation and Recovery Act Subtitle D or C landfill. Spent GAC will be sent off-site for treatment/regeneration.
- Re-evaluate available literature on permeable reactive barrier technology every five years to see if it has proven to be a reliable long-term technology.
- Develop as part of remedial design an extended IWS treatability test for potential use throughout the plume.

The 2006 ESD identified the following changes to the final remedy:

- Revised required pumping capacity.
- Required upgrades for the ion-exchange system and air-stripping unit.
- Allowed for treated groundwater to be discharged to the newly constructed infiltration gallery on the BOC property or to the Vancouver POTW.
- Enhanced ICs to protect the remedy constructed at the Site by obtaining easements from property owners whose properties are affected by the remedy.
- Clarified the status of the IWS treatability study and that IWS will be discontinued for OU 3.

4.3. Remedy Implementation

In 2001, approximately 2,500 cubic yards of chromium contaminated soil was excavated from OU 1 and disposed off-site. During the excavation, EPA discovered that chromium-contaminated soil at concentrations above ROD cleanup levels extended under the groundwater extraction and treatment system. The soil was not removed due to its location and was further characterized in 2003. Since it is a relatively small quantity of contaminated soil, any contaminants that may leach into the groundwater would have minimal impact. This layer of soil will be excavated upon completion of the remedial actions for groundwater and removal of the groundwater treatment system.

The treatment system for OU 2 became operational in February 2004. It consists of nine IWS wells and five SVE well pairs with an upper, middle, and lower screen (Figure 2). The off-gas for both systems was collected for above-ground treatment by GAC.

An extensive groundwater extraction network is used to capture the contaminated groundwater in OU 3. The system was originally constructed and operated by Boomsnub in 1990 and has been expanded and upgraded several times by Ecology, EPA, and Linde. The groundwater extraction and treatment system for OU 3 is presented on Figure 3 and currently consists of the following components:

- An extraction system with 26 extraction wells screened in the alluvial aquifer and approximately 10,000 feet of piping used to transport extracted groundwater to a central treatment system on the Boomsnub property. The maximum pumping rate capacity is 160 gallons per minute (gpm), as described in the 2006 ESD.
- A central treatment system used to treat the extracted groundwater. Chromium is removed using an ion-exchange system; VOCs are removed using air stripping with GAC treatment of the off-gas.
- As of February 2006, treated water is discharged via force main to the infiltration gallery on the Linde property. Previously, some treated water was discharged to the Vancouver POTW.

In September 2006, the Toe-of-Plume Pilot Study (TOPPS) in-situ remediation was initiated to treat the residual contamination located near extraction well MW-41 (well MW-41 is west of the Church of God). This contamination area is believed to be located in the low-permeability silt layer at a depth of approximately 80 to 90 feet bgs. The remediation compound EHC-M™ was injected into the alluvial aquifer to treat recalcitrant TCE and chromium contamination. EHC-M™ is a combination of controlled-release carbon and zero-valent iron particles, which stimulate reductive dechlorination of TCE and chemical reduction/precipitation of chromium.

ICs were established to assure that the remedial action will continue to protect human health and the environment. A summary is presented in Table 4. EPA is responsible for implementing, monitoring, and enforcing ICs related to OU 1 and Linde is responsible for ICs related to OU 2 and OU 3. ICs for groundwater exist in the form of public notice during operation of the groundwater extraction and treatment system, accomplished by providing affected property owners a copy of biannual groundwater quality sampling data for their property for all contaminants exceeding cleanup standards. Long-term compliance monitoring for contaminated groundwater is required to assess the operational efficiency of the extraction and treatment system and the migration of contaminants. Access to the Boomsnub property is restricted for the duration of the extraction and treatment system's operation. ICs also include deed restrictions and controlled access for the Linde property. The Washington Administrative Code (WAC) states that water wells shall not be located within certain minimum distances of known or potential sources of contamination (WAC 173-160-171). The minimum setback distance for proposed water wells other than for public water supply is 100 feet from all potential sources of contamination, except for solid waste landfills.

The ESD identified enhanced institutional control requirements to protect the remedy constructed at the Site. As a result, easement agreements have been executed to grant a right of access over the properties for the purposes of implementing, facilitating, and monitoring the environmental cleanup and remediation activities. Restrictive covenants have been executed as an effort to prevent use of the properties in any manner that would interfere with or adversely affect the implementation, integrity, or protectiveness of the environmental cleanup and remediation activities for as long as these activities

are being performed. Additionally, property owners are prohibited from installing groundwater well(s) and using groundwater beneath their properties for potable purposes for as long as environmental cleanup and remediation activities are being performed. The general public has no right of access to the properties affected by the easements. Linde has already recorded a number of easements from property owners whose properties are affected by remedy implementation and is actively negotiating easements from those property owners with whom they have not yet reached agreement. Linde also provided a deed restriction for the Linde property (OU 2). Deed restrictions to limit future use of the Boomsnub property have not been formally recorded. Access restrictions to the Boomsnub property are in place to minimize the potential for exposure of the general public to Site conditions.

Table 4. Areas of IC Interest: Boomsnub/Airco Superfund Site

Operable Unit	ICs Needed	ICs Called for in the Decision Documents	Impacted Area/Parcels	IC Restriction/Objective	IC Instrument
OU1 – Boomsnub Soil	Yes	2000 ROD	Boomsnub property	Prevent future workers from being exposed to contaminated soils and prevent future residential use of property	Deed Restriction
OU2- BOC Soil	Yes	--	Linde property	Refrain from using the property in any manner that would interfere with the environmental cleanup and restrict use of groundwater	BOC Easement/Restrictive Covenant
OU3 – Site-Wide Groundwater	Yes	2000 ROD	Multiple, see Figure 13.	Prevent ingestion of contaminated groundwater	Public notice during operation of extraction and treatment system (i.e. provide copy of data to property owners)
				Prevent installation of new wells	WAC 173-160-171
				Protect remedy constructed at the Site	Easements

4.4. *Systems Operations/Operations & Maintenance*

IWS is an in-situ treatment process at OU 2 in which air-lift pumping is used to move groundwater through a vertical circulation well. The dissolved VOCs are stripped from the groundwater by the injected air. A vacuum applied at the wellhead recovers vapors for aboveground treatment using granular activated carbon (GAC). Because detectible concentrations of VOCs in vapors are negligible, treatment is no longer required. The well casing is screened in two intervals; water is drawn into the system through the lower screen and discharged through the upper screen or recharge zone. This re-infiltration of water creates circulation patterns within the aquifer. It is estimated that groundwater is treated approximately seven times as it passes through the radius of influence of one IWS well. Equipment for the IWS system includes the following: extraction wells, vacuum blower, air/water separator, air/water separator pump, pressure blower, vapor-phase GAC, and programmable logic controller.

The SVE process at OU 2 involves applying a vacuum to a well screened within the vadose zone to remove VOCs from the soil pore space. The extracted soil vapor is routed through an air/water separator and particulate filter prior to reaching the blower. Equipment for the SVE system includes the following: extraction wells, vacuum blower, air/water separator, air/water separator pump, heat exchanger, liquid-phase GAC, vapor-phase GAC, and programmable logic controller. The SVE system was shut down in 2008.

The groundwater extraction system at OU 3 includes an extraction well network located within the contaminant plume, extraction system force main, and containment vaults. Flow through the extraction network to the treatment system is controlled by the extraction well pumps and, when necessary, an additional booster pump in containment vault CV-9. Flow rates are measured in each well using a mechanical totalizing flow meter. Collected groundwater is ultimately routed to containment vault CV-1 located on the Boomsnub property.

The groundwater treatment process is presented in Figure 4. Extracted groundwater is first treated for chromium by the ion-exchange system. Groundwater discharges into a 1,200-gallon influent tank inside the treatment building and is pumped through the treatment system into the air-stripping influent tank. Treatment consists of three resin vessels, with two vessels (primary and polishing) in use at a time and one standby vessel. The system uses SIR-700, a weak-base anion resin with epoxy polyamine structure, to remove chromium from the groundwater. Particulate filters are placed prior to the resin vessels to remove suspended solids from the groundwater. Spent resin is disposed of as hazardous waste.

An air stripper is used to treat groundwater for VOCs. Water is pumped to the top of a 27-foot tall tower and flows by gravity down through the packing media against a counter-current of air produced by the blower. Treated groundwater collects in the sump and is discharged through the infiltration gallery on the Linde property. Off-gases containing extracted VOCs exit the top of the tower and pass through a moisture separator and in-line process heater for moisture control before flowing through two GAC canisters and discharging to the atmosphere in accordance with Southwest Air Pollution Control Authority requirements. Spent GAC is shipped off-site for regeneration. An infiltration

gallery located on the Boomsnub property is connected to the air stripper and is used to provide overflow protection in the event of a major spill.

The Linde infiltration gallery is the primary point of discharge for effluent from the groundwater treatment system. The gallery was designed to accept 160 gpm. It includes a distribution box, twelve 70-foot long perforated distribution laterals, four observation ports, and a 70- by 140-foot drain field. Prior to the construction of the Linde infiltration gallery, effluent from the treatment system was discharged to the City of Vancouver's sanitary sewer system through an 8-inch gravity pipeline. In the event that the BOC infiltration gallery is offline for an extended period, discharge can revert back to the original pipeline under the current City of Vancouver Industrial Wastewater Discharge Permit.

4.4.1. Systems Operations/O&M Requirements

Operation and Maintenance (O&M) inspections of the IWS systems are performed monthly. The SVE system is currently inactive. Operating parameters recorded include air flow rates to each well, the IWS systems, vacuum and pressure at the inlet and outlet of each blower, and operating temperature of each blower. As part of the O&M of the IWS, depth to water in the recharge zone of the IWS wells is monitored quarterly to determine if plugging of the upper screen or aquifer formation is occurring. Performance monitoring for the IWS system also includes semi-annual groundwater monitoring of selected wells within the source area.

The O&M for the groundwater extraction system includes bi-weekly maintenance checks (see Figure 5 for example checklist). The Consent Decree with Linde requires the treatment system to be operational at least 90 percent of the time. Additional monitoring for the O&M of the groundwater extraction system includes the following:

- Biweekly water sampling of effluent from primary and polishing vessels for total chromium and hexavalent chromium. When the concentration of the primary vessel effluent reaches 70 percent of the influent concentration, that vessel is taken off line.
- Biweekly vapor sampling of off-gases from primary GAC vessel. VOC concentrations measured using TCE draeger tubes to determine whether concentrations are less than 5 ppm.
- Monthly treatment system influent and effluent samples are analyzed for total chromium and TCE. The infiltration gallery discharge criteria were revised in February 2009 to reflect a new resin cycle. Criteria are currently 1.9 µg/L for TCE and 19.2 µg/L for chromium. Prior to 2009, discharge standards were 3 µg/L for TCE and 24 µg/L for chromium.
- Semi-annual monitoring of water elevation and biennial monitoring for water quality around the BOC infiltration gallery to assess impacts.
- Monthly measurement of extraction well flow rates.
- Plume monitoring – semi-annual groundwater monitoring.

Long-term monitoring was developed to monitor the progress of the groundwater remedy at OU 2 and OU 3. The 2007 Long-Term Monitoring Plan made revisions to previous interim plans and provided a basis for future long-term monitoring. The primary goals were to measure the performance of ongoing remedial actions, to assure that contaminated groundwater was not migrating further down-gradient, to monitor contaminant concentrations in the Troutdale aquifer, and to determine when Site groundwater

achieves cleanup levels. In 2009, a draft Closure Plan was developed to support Site closure. This plan has not been fully approved by EPA and is awaiting guidance from EPA Headquarters to finalize the exit strategy. As part of the draft Closure Plan, a quantitative and qualitative annual screening process was developed. Outcomes of the screening process are recommendations for well redundancy reductions, system operation modifications, sampling frequency modifications, termination of monitoring, and an attainment analysis to assess eligibility for closure. The Air Force Center for Environmental Excellence Monitoring and Remediation Optimization System (MAROS) is used as the quantitative tool to statistically analyze Site contaminant concentrations. MAROS is discussed further in Section 6.4.2. The qualitative portion of the annual screening is performed by a qualified professional and is used to evaluate the MAROS recommendations.

Reporting requirements for the Site include the following:

- Monthly flow reports sent to City of Vancouver to determine costs associated with the sewer discharge system. These are required only when treated groundwater is discharging to the City sewer system.
- Semiannual reports to the City of Vancouver required as part of the Wastewater Discharge Permit and EPA system operation and monitoring report. The EPA report includes bi-weekly maintenance checklists and a summary of system performance.
- Semiannual groundwater monitoring results.
- The annual status reports summarizing remediation activities and overall status of the remediation program, including the results of the annual screening.
- Annual dangerous waste report submitted to Ecology that identifies hazardous waste generated at the Site.

4.4.2. Systems Operations/O&M Operational Summary

The SVE system at OU 2 was operated until VOC removal rates reached asymptotic conditions in 2006. Rebound testing started in July 2006; successful passing of three rebound tests was required to turn off the SVE system. A single rebound test consists of up to one month system downtime, followed by three months of system operation. A vapor sample is collected at the end of this period and compared to the baseline TCE concentration of 65 micrograms per cubic meter. The system passed three rebound tests and was turned off in February 2008 with EPA approval.

Until 2008, the IWS at OU 2 ran 24 hours per day, with the exception of minimal periods of downtime for maintenance requirements, power outages at the Site, and system alarms. In 2008, pulse pumping of some in-well stripping wells began. In August 2013, pulse pumping of all of the in-well stripping wells was temporarily discontinued, and increased monitoring for rebound effects was started. Performance data indicate that the system has significantly decreased TCE concentrations across the source area. Vapor monitoring of IWS influent was discontinued in January 2008 when concentrations became too low to measure. Linde proposed and EPA agreed that concentrations of VOCs in the off-gas discharge did not pose a risk to human health and the environment and were significantly lower than the regulatory limits for air releases. Therefore, use of the GAC treatment system was discontinued in October 2009 with EPA approval. Quarterly groundwater monitoring

results also show an improvement in water quality. Results from quarterly groundwater sampling are discussed in detail in Section 6.4.3.

Due to low rates of recovery from the IWS system, operation of all IWS wells has been discontinued. Contaminant concentrations in compliance wells are being monitored with increased frequency in order to better assess rebound potential. Table 5 below shows the compliance monitoring wells for each of the IWS wells recently in operation.

Table 5. Operating IWS Wells and Associated Compliance Monitoring Wells

IWS Well	Associated Compliance Monitoring Wells
IWS-3	AMW-56A, AMW-56C
IWS-4	AMW-12A, AMW-56A, AMW-56C
IWS-5	AMW-19A, AMW-19B
IWS-6	AMW-1A, AMW-1B, AMW-1C , AMW-2A, AMW-2B, AMW-2C
IWS-8	AMW-1A, AMW-1B, AMW-1C

Notes:

Strikeout through a monitoring well identifier indicates it is no longer sampled because TCE concentrations in that well have consistently been below cleanup levels.

Although the 2000 ROD specified a minimum capacity of 200 gpm for the extraction and treatment system, the 2006 ESD revised the required pumping rate capacity to a maximum of 160 gpm because post-ROD monitoring data indicated a significant reduction in the plumes' contaminant concentrations and areal extent at the current capacity of 160 gpm. The new flow and transport model presented to EPA in 2004 concluded that at 160 gpm the Site could be remediated in a time frame considerably less than the 30 years predicted by the groundwater model used by the ROD. The groundwater model was also used to assess how changes in extraction rates in the toe-of-plume area wells would affect capture effectiveness. Pumping has been discontinued at toe-of-plume wells MW-31, MW-37, AMW-42, MW-46, and MW-48. Pulse-pumping was utilized at MW-35 and MW-41 to focus extraction on the areas with remaining contamination and was discontinued by 2006.

The new toe-of-plume area is considered to be located in the vicinity of the Church of God. In 2008, the groundwater model was used to assess the effectiveness of the existing extraction system at the new toe-of-plume area (EA 2008; see Appendix A). It was recommended that the current pumping rates near the Church of God be maintained. In-situ remediation was also recommended for the remaining hot spots near wells AMW-27 and MW-35 as TCE and chromium contamination is likely trapped in the silt layer near these wells.

Development activities at properties over the plume have required modifications to the extraction well and monitoring well networks. In 2011 and 2012, Clark County and the Church of God constructed sports fields on the north side of the 3700 block of 78th St. System modifications due to the construction included raising extraction well MW-21 by 15-20 feet, reconfiguring the pipeline between MW-21D and MW-22D, discontinuing pumping at MW-27D (currently used for monitoring only), decommissioning unused monitoring wells, and modifying monitoring well elevations on the sports field property. Unused monitoring wells on the Chapman/Holtgrieve and Bonneville Power Administration properties were also decommissioned.

The groundwater treatment system was operational 97 to 99 percent of the time each year between 2008 and 2011. The system was repaired or modified as necessary to maintain operation within the performance standards. Total flow rates over the past five years have ranged from 142 to 164 gpm. Flow rates at individual wells ranged from 1 to 18.7 gpm and are shown in Appendix E. All effluent discharge to the infiltration gallery has met criteria during the last five years. As of December 2011, cumulative mass removal for the treatment system since 1999 is 2,175 pounds of chromium and 22,264 pounds of TCE (see Figure 6).

4.4.3. Summary of Costs of System Operations/O&M Effectiveness

Operational costs for the last five years have averaged approximately \$576,000 per year as shown in Table 6. This is a decrease of about \$248,000 per year from the previous five-year review. About 75 percent of this decrease can be attributed to discharge of treated water to the infiltration gallery instead of discharge into the sanitary sewer system. Optimization of the groundwater monitoring program, shutdown of the SVE system, and partial shutdown of the IWS wells has also helped to decrease annual costs.

Table 6. Annual System Operations/O&M Costs

Activity	Average Cost/Year	
	2003-2007 (Previous Five-Year Review Period)	2008-2012 (Current Five-Year Review Period)
Project Management	\$20,000	-
Sampling/Reporting/Management & Oversight	\$234,000	\$228,000
System Operations & Maintenance	\$289,000	\$257,000
Data Management	\$39,000	\$26,000
Chemical Analysis (routine monitoring)	\$23,000	\$31,000
Electricity	\$28,000	\$29,000
Treated Water Disposal	\$187,000	-
Ion-Exchange Resin	\$4,400	\$5,000
Annual Operating Costs	\$824,400	\$576,000

Notes:

Project Management costs for 2008-2012 are included in the Sampling/Reporting/Management & Oversight Activity

5. Progress Since the Last Five-Year Review

5.1. *Protectiveness Statements from Last Review*

“The soil remedy (OU 1) is expected to be protective of human health and the environment upon completion, and in the interim, exposure pathways that could result in unacceptable risks are being controlled. Most known and accessible contaminated soils at the Site have been addressed through soil excavation, removal, and replacement with clean soil to a depth of at

least 15 feet below ground surface and the Site is fenced to prevent access. There remains a defined quantity of soil above lead and chrome cleanup levels directly below the treatment plant. The physical structure of the treatment plant limits exposure to these soils. The remedy anticipates removal of contaminated soils that are present through a depth of 15 ft below ground surface after the decommissioning of the Site-wide groundwater treatment plant.”

“The remedy for the BOC gases property (OU 2) is expected to be protective of human health and the environment upon completion, and in the interim, exposure pathways that could result in unacceptable risks are being controlled. Extraction and treatment systems are providing containment of the TCE plume and TCE concentrations in groundwater are decreasing across the Site. No one is drinking the contaminated water and Institutional Controls are being implemented to ensure no one drinks the water before cleanup goals are achieved.”

“The Site-wide groundwater remedy (OU 3) is expected to be protective of human health and the environment upon attainment of the groundwater cleanup goals. In the interim, exposure pathways that could result in unacceptable risks are being controlled. The extraction and treatment system is functioning as intended, no one is drinking the contaminated water and Institutional Controls are being implemented to ensure no one drinks the water before cleanup goals are achieved.”

5.2. Status of Recommendations and Follow-up Actions from Last Review

Recommendation: Record deed restrictions to maintain industrial land use of the property and prevent disturbing soil below 15 feet.

Status: Not Completed. A deed restriction to maintain industrial land use of the Boomsnub property and prevent soil disturbance below 15 feet has not been formally recorded.

Recommendation: Continue to work on obtaining easements, access agreements, and restrictive covenants for properties above the plume.

Status: Ongoing. Linde continues to work with EPA to obtain agreements for gaining access to properties to conduct activities related to the Consent Decree. Fourteen agreements have been completed and EPA has identified six other properties as high priority where wells, pipelines, or other infrastructure are located.

Recommendation: Start to investigate the source and extent of TCE contamination detected in well AMW-18.

Status: Completed. Investigations were performed in 2008 and 2011 to define the extent of the Northern Plume near well AMW-18. The investigations concluded that the source of the Northern Plume is likely not the same as the source of the OU 3 VOC plume because it is geographically distinct and does not contain CFC-11, which is commonly detected in OU 3 and used to identify VOCs from the Linde source. One new well was installed in 2012 to the north of well AMW-17 to help define the extent of the Northern Plume. Sampling frequency at wells defining the Northern

Plume has been increased to assess contaminant trends. The Northern Plume is described in more detail at the end of section 6.4.3.

Recommendation: Conduct Long Term Monitoring Optimization of groundwater monitoring prior to the next five-year review using tools and techniques outlined in EPA 542-R-05-003. Continue system optimization to restore groundwater to drinking water quality within a 30-year time frame.

Status: Completed. A Long-Term Monitoring Plan was developed in 2007 to provide a systematic approach for evaluating Site wells and to determine an appropriate sampling frequency. The process for monitoring optimization followed EPA guidance 542-R-05-003. Optimization of the extraction system and monitoring is evaluated annually.

6. Five-Year Review Process

6.1. *Administrative Components*

EPA Region 10 initiated the Five-Year Review in October 2012 and scheduled completion for June 2013. The Boomsnub/Airco review team was led by Claire Hong, EPA Remedial Project Manager (RPM) and included EPA personnel Judy Smith (community involvement coordinator) and USACE Seattle District personnel Sharon Gelinias (hydrogeologist), Aaron King (environmental engineer), and Kristen Kerns (physical scientist). In October 2012, EPA held a scoping call with the review team to discuss the Site and items of interest as they related to the protectiveness of the remedy currently in place. A review schedule was established that consisted of the following:

- Community notification;
- Document review;
- Data collection and review;
- Site inspection;
- Local interviews; and
- Five-Year Review Report development and review.

6.2. *Community Involvement*

On November 26, 2012, a public notice was published in The Columbian newspaper announcing the commencement of the Five-Year Review process for the Boomsnub/Airco Site, providing the contact information for EPA RPM, Claire Hong, and inviting community participation. In addition to the public notice, a postcard announcing the Five-Year Review was sent to recipients on the project mailing list. The public notice is presented in Appendix F.

The Five-Year Review report will be made available to the public once it has been finalized. Copies of this document will be placed on the EPA website for the Boomsnub/Airco Site and the local document repository at the Fort Vancouver Regional Library. Upon completion of the Five-Year Review, a public notice will be placed in the Columbian to announce the availability of the final Five-Year Review report in the document repositories.

6.3. Document review

This Five-Year Review included a review of relevant Site-related documents including decision documents and recent monitoring data. A complete list of the documents reviewed can be found in Appendix A.

6.4. Data Review

6.4.1. Water Levels

Groundwater level measurements are collected semi-annually from monitoring and extraction wells. Elevations measured in the fall are typically lower than those measured during the spring. The groundwater flow direction in the alluvial aquifer has consistently been to the west-northwest as shown on Figure 7. Groundwater flow patterns show the characteristic cone of depression around the operating extraction wells and a slight groundwater mound near the infiltration gallery on the Linde property. The groundwater flow direction in the Troutdale aquifer is consistently to the west-southwest as shown on Figure 8.

6.4.2. Monitoring Program

A draft Closure Plan has been developed and includes provisions for evaluating and optimizing the monitoring program using a combination of quantitative analysis with MAROS and qualitative analysis by a qualified professional. MAROS is used to determine when concentrations are statistically below cleanup levels, when to terminate treatment, and when groundwater has attained cleanup levels. The MAROS evaluation includes the following evaluations:

- Redundancy – Delaunay triangulation and Voronoi diagrams are used to determine if the well provides unique information and select the minimum number of sampling locations based on the spatial analysis and relative importance.
- System Operations – Mann-Kendall non-parametric trend analysis is used to evaluate increases or fluctuations and to determine if modification to the extraction system operation is necessary.
- Termination – Sequential t-test is used to determine if contaminants in groundwater are statistically below cleanup levels and aids in the decision to terminate treatment or discontinue monitoring.
- Sampling Frequency – Modified Cost Effective Sampling method based on the magnitude, direction, and uncertainty of concentration trends used to propose sampling frequencies.
- Attainment – Sequential t-test used to assess whether post-treatment concentrations remain statistically below cleanup levels.

The MAROS results are considered preliminary since they do not account for the monitoring objective of an individual well. The MAROS results are reviewed by a qualified professional who makes the final judgment on recommended sampling frequencies. This process is completed annually, optimizing the monitoring program using the most current conditions. A summary of the annual screening results and recommendations for 2012 is presented in Appendix E.

As part of the Five-Year review process, annual optimization recommendations were reviewed. In 2009, significant changes were implemented that reduced the sampling frequency and removed wells from the monitoring program. In general, concentrations at most of the monitoring wells are stable or steadily declining and a decrease in the sampling frequency or removal of wells that are statistically below the cleanup levels does not impact the monitoring of plume dynamics. The MAROS attainment assessment is performed on a subset of wells in geographic areas of the plume to determine when the area can be closed. It should be noted that the term “attainment” used by MAROS is inconsistent with the standard meaning of the term used by EPA’s Cleanup Programs. When applied to groundwater, EPA reserves the use of the term “attainment” for a Site when all of the wells have met the groundwater remediation goal, while the MAROS term “attainment” is applied to an individual well that statistically remains below cleanup levels. Due to this difference, the term “attainment” should be reserved for the EPA terminology. Table 7 below shows the subset of monitoring wells used to evaluate whether contaminant concentrations remain statistically below cleanup levels. The subset of Sentinel wells have remained statistically below cleanup levels as well as one of the other toe-of-plume wells.

Table 7. Subset of Monitoring Wells Used to Statistically Evaluate Long-Term Compliance with Cleanup Levels

Plume Area	Monitoring Well Subset	Well Remains Statistically Below Cleanup Goals
TCE Source Area	AMW-12A	No
	AMW-1A	No
Proximal Wells	MW-6B	No
	MW-10C	No
	PW-1B	No
Intermediate Wells	MW-14E	No
	MW-18D	No
	MW-19D	No
	MW-20D	No
Church of God Wells	MW-21D	No
	MW-26D	No
	MW-27D	No
Other Toe Wells	MW-31	No
	MW-41	Yes
Sentinel Toe Wells	AMW-45	Yes
	MW-47	Yes

The following recommendations for the annual screening should be considered to determine whether the necessary data are being collected to make informed Site decisions:

- Increase the sampling frequency at potentially impacted wells when changes are made to the operation of the treatment system (e.g., when extraction wells or IWS wells are shut down). Wells removed from the program may also need to be sampled to confirm that operational changes have not impacted aquifer conditions and that contaminant concentrations remain below cleanup levels.
- Complete a more comprehensive sampling event at a low frequency, such as every five years, to monitor trends in wells removed from the monitoring program and confirm the extent of the plume. For example, the least impacted wells in well clusters were removed from the monitoring

program, but these wells provide data pertaining to the vertical distribution of contaminants in the aquifer. Wells removed from the program because they have met cleanup levels may also need to be sampled to confirm the full extent of the TCE and chromium along plume boundaries. Wells near *in-situ* remediation areas may also need to be sampled to confirm that rebound has not occurred.

- The term “attainment” should be reserved for the standard EPA definition. The ROD states that the area of attainment for RAOs is throughout the groundwater plume in the alluvial aquifer; however, the assessment that contaminant concentrations remain statistically below cleanup levels (i.e. MAROS attainment evaluation) is only completed on a subset of monitoring wells to determine when an area can be closed. The appropriate use of this analysis on only a subset of the wells should be evaluated prior to the development of a final exit strategy.

6.4.3. Analytical Data

Cleanup progress is tracked using chromium and TCE as the primary indicator compounds. Groundwater samples are also analyzed for additional VOCs listed in the ROD. During the last five years, the following compounds have been found at levels that exceeded the MCL or MTCA cleanup levels: 1,1-DCE, bromodichloromethane, carbon tetrachloride, dibromochloromethane, tetrachloroethene (PCE), and vinyl chloride. With the exception of sporadic dibromochloromethane detections at TCE source wells, all of the additional compounds are detected at wells which also contain TCE. 1,1-DCE, and vinyl chloride, which are degradation products of TCE via reductive dechlorination, are most frequently detected in Intermediate wells and Church of God wells down-gradient of the Proximal wells area (see Figure 3). Concentrations of these degradation products are relatively low, indicating that there is limited biodegradation of TCE occurring as the plume migrates down-gradient.

To facilitate analysis of contaminant concentrations across the Site, sampling data are grouped by aquifer and geographic locations as shown on Figure 3. All wells except those identified as being screened in the Upper Troutdale aquifer are screened across the alluvial aquifer. Wells within the Alluvial Aquifer with a letter designation (e.g. A, B, C, D, or E) at the end of the well name provide a relative indicator of depth, with A being the shallowest interval and E being the deepest interval. A summary of data collected over the last five years and time-series graphs for each group of wells are presented in Appendix E. The chromium and TCE plumes as of December 2011 are shown on Figure 9 and Figure 10. To show how the plume migrates vertically, the distribution of TCE along the centerline of the plume is shown on Figure 11 (note that concentrations are from 2006).

Up-gradient Wells

Up-gradient wells are located east of the TCE source area on the Linde property. Infiltration gallery monitoring wells are also included in this area. Samples from wells within this group are analyzed for chromium and VOCs. All contaminant concentrations were below cleanup levels or not detected indicating that infiltration of treated water is operating as designed.

TCE Source Wells

TCE source wells are located on the western portion of the Linde property near the TCE-impacted soil. Monitoring in this area is used to evaluate the effectiveness of the IWS wells. Wells within this group are analyzed for VOCs. Samples from well MW-1A are also analyzed for chromium and the well is considered an up-gradient well for the Boomsnub chromium source. Chromium concentrations at MW-1A have all been below the cleanup level for hexavalent chromium.

TCE concentrations exceeded the cleanup level in 5 of the 27 TCE Source wells sampled during the last five years. All of these wells with exceedences were screened across the most shallow aquifer interval, which is indicative of the source area. Well AMW-2A, a compliance monitoring well for well IWS-6, showed an increase in TCE concentrations in 2009 with highly variable concentrations following that time period. Well AMW-1A, a compliance monitoring well for IWS-6 and IWS-8, showed spikes in 2011 and 2012. Well AMW-12A also appears to have had a slight increase in concentrations between 2009 and 2011 and is a compliance monitoring well for IWS-4. These variable concentrations may be due to continuous operation of the IWS wells being replaced by intermittent pulse-pumping. An evaluation/optimization of the pulse-pumping operation at the IWS should be completed and an exit strategy should be developed consistent with EPA guidance.

Proximal Wells

Proximal wells are located west of the maintenance building on the Boomsnub property and east of St. John's Road. These wells are proximal to the chromium source. Chromium was detected at concentrations above the cleanup level for hexavalent chromium at 7 of the 25 wells sampled during the last five years. The highest concentrations were seen near the source area at wells MW-3A, MW-4A/B, and MW-6A; the maximum concentration was 741 µg/L at well MW-4A in 2011. The chromium plume deepens as it moves down-gradient and has migrated to the deeper C zone wells by the time it reaches MW-10C (approximately 150 feet down-gradient of MW-6A). Overall, chromium concentrations in proximal wells appear to have a decreasing trend. Wells MW-4A and MW-3A had a slight increase in chromium concentrations in 2011, but have since declined.

TCE concentrations exceeded the cleanup level in 10 of the 25 proximal wells sampled during the last five years. The maximum TCE concentration was 28 µg/L at well MW-10B in 2009. TCE contamination also migrates vertically downward as it moves from the TCE source area to the proximal well area. TCE concentrations have decreased significantly since the SVE and IWS systems began operation, and most wells show a decreasing trend. Well MW-12C had a slight increase in TCE concentrations in October 2010, but the concentrations have since decreased to below cleanup levels.

Intermediate Wells

Intermediate wells are located west of St. John's Road and south of NE 78th Street. Chromium was detected at concentrations above the cleanup level for hexavalent chromium in 5 of the 18 Intermediate wells sampled during the last five years. The highest concentrations were seen at MW-19D, with the maximum concentration at 279 µg/L in 2008. All chromium concentrations show a decreasing trend. The chromium plume currently ends in the Intermediate well area.

TCE concentrations exceeded the cleanup level at 15 of 18 Intermediate wells sampled during the last five years. The highest concentrations were seen at well AMW-18, which may be part of the Northern Plume (discussed at the end of this section). With the exception of wells associated with the Northern Plume, all wells show a decreasing trend.

Church of God Wells

The Church of God wells are located between the west side of the gravel roadway in the field north of NE 78th St and the western Church of God property line. Chromium was detected in 2 of the 13 Church of God wells sampled in the last five years. The highest concentrations were seen at well AMW-27, with a maximum concentration of 230 µg/L in 2008. All wells in the Church of God area show either a stable or a decreasing trend. Chromium concentrations are currently below the cleanup level for hexavalent chromium.

TCE concentrations exceeded the cleanup level at 4 of the 13 Church of God wells sampled in the last five years. The highest concentrations were seen at well AMW-27, with a maximum of 29 µg/L in 2008. All wells show either a stable or a decreasing trend. The current TCE toe-of-plume is located within the Church of God area. As of the end of 2012, the furthest down-gradient extraction wells in operation are MW-25D and MW-26D. *In-situ* remediation using EHC-M™ is being considered to treat the residual contamination near AMW-27.

Toe-of-Plume Wells (includes Sentinel and Other Toe Wells)

The Toe-of-Plume wells are located west of the Church of God building. The Sentinel wells are located beyond the historical leading edge of the contaminant plume. Sentinel wells were determined to have attained cleanup levels and monitoring was terminated in this area in 2008. The Other Toe-of-Plume Wells are currently the most down-gradient wells sampled.

There were no exceedences of chromium in the Other Toe-of-Plume Wells in the last five years. TCE concentrations at well MW-35 continue to remain near the cleanup level of 5 µg/L; concentrations at all other wells in this area have been below the TCE cleanup level for the last five years. TOPPS post-remediation sampling near MW-41 was discontinued in 2010 after 4 years of monitoring with concentrations remaining below the cleanup level. *In-situ* remediation using EHC-M™ is also being considered to treat the residual contamination near well MW-35.

Troutdale Aquifer Wells

Chromium was not detected at concentrations above the cleanup level for hexavalent chromium in any Troutdale aquifer well during the last five years. TCE continues to be detected at concentrations above the cleanup level at well AMW-24, well MW-33, and the Bennett well. There do not appear to be any trends in the TCE concentrations at these wells. The Bennett property was connected to the city water system in April 2008.

Northern Plume

The Northern Plume was identified in 2007 when a significant increase in TCE concentrations was detected at monitoring well AMW-18. Concentrations at AMW-18 peaked at 460 µg/L in 2008 and have since been declining. Well AMW-17, the next down-gradient well, experienced an increase in TCE concentrations in 2011. The most recent sampling in October 2012 showed a peak concentration of 210 µg/L at AMW-17 and indicates the movement of this contaminated slug of groundwater down-gradient. Two direct-push (Geoprobe) investigations have been completed (2008 and 2011) to aid in plume delineation and to identify potential source areas. Results of the 2011 investigation are shown on Figure 12. Similar to the OU 3 plume characteristics, TCE concentrations are located in the shallow aquifer in the eastern-most samples and migrates into deeper intervals as it moves down-gradient toward the west. The highest concentrations found during the 2011 investigation were located to the north and east of AMW-17 at concentrations ranging from 150-170 µg/L.

The 2011 investigation did not identify the source but concluded that it is detached from the source of the OU 3 plume and is geographically different than the OU 3 plume. As supporting evidence to this conclusion, CFC-11 has historically been associated with the OU 3 TCE plume and has not been detected in association with the Northern Plume. The former Permalume property up-gradient of the Linde property was identified as a potential source area but has not been confirmed. TCE was discovered at the Permalume property and a voluntary cleanup action was completed in 2003. The site received a No Further Action determination from the State of Washington in 2006. Elevated TCE concentrations were detected in well AMW-8A (located in the northeast corner of the Linde property near the Permalume property boundary) in 1992 at a concentration of 1,700 µg/L. Concentrations have since decreased to below the cleanup level at AMW-8A. Injection of treated water, which started in 2006, may have altered the flow directions near AMW-8A, but the concentrations of TCE at this time had already decreased to 40 µg/L, indicating that source strength had already diminished.

Linde installed a new monitoring well, AMW-64, near Geoprobe location DPT-17, in February 2012 to continue monitoring the down-gradient movement of the Northern Plume. Concentrations of TCE at this well have ranged from 110-190 µg/L. Groundwater monitoring data indicate the plume attenuates, or decreases in concentration, as it moves down-gradient. Extraction wells installed as part of the OU 3 groundwater remedy may intercept portions of the Northern Plume; however, full capture of the plume is unlikely. A simplified analytic model or the existing groundwater flow model could be used to predict future concentrations and to determine the influence of extraction on the Northern Plume.

6.5. Site Inspection

A site inspection for the Boomsnub/Airco Site was conducted on 18 October 2012. Participants included Claire Hong and Bernie Zavala from EPA, Sharon Gelinis and Aaron King from USACE, and Richard Read, Catherine Bohlke, and Jil Frain from EA Engineering. The Site Inspection Checklist is presented in Appendix B and photos from the site inspection are presented in Appendix C.

The inspection started with a brief overview meeting of the Site and groundwater contamination status in the on-site trailer. Mr. Read, Site Operations Manager, led the site visit which included a tour of the

treatment system components and locations of interest within OU 3 plume area. The groundwater treatment system consists of an ion-exchange system for treatment of chromium and an air stripper for treatment of TCE. All treated water is transported via pipeline to the infiltration gallery located at the eastern edge of the Linde facility. All treatment system components appeared to be in good condition. Secondary containment in the event of a spill is present near the air-stripper. The collected water is then routed through the treatment system and ultimately discharged through the infiltration gallery. Vaults for several extraction wells, IWS wells, and SVE wells were opened for inspection. All components appeared to be in working order. It should be noted that the SVE system is no longer operating (it was shut down in 2008), and until August only a limited number of IWS wells are in operation. In August 2013, EPA approved the temporary cessation of pulse pumping of the IWS system. This will be accompanied by increased monitoring of wells in the IWS area in addition to those down gradient of the IWS area. Final termination of the IWS system will be considered once the additional data are collected.

Mr. Read stated that there have been no significant O&M issues with the system in the last five years. It was stated that there was one instance of a break-in at the Boomsnub facility, but nothing was stolen. There have been no other acts of vandalism during the last five years.

The group then visited the new sport fields to the east of the Church of God. This area will be the new toe-of-plume following completion of *in-situ* treatment at residual down-gradient contamination areas. It is expected that the most down-gradient extraction wells on the Church of God property will be shut off following the completion of the *in-situ* treatment. An informational sign describing the Superfund Site and the location of groundwater contamination was observed on the shed near NE 78th Street. The last stop on the tour was the old toe-of-plume area where the TOPPS was completed.

While EPA and USACE personnel were at the Vancouver Regional Library for community member interviews (see below), they verified the Site's local public repository.

6.6. Interviews

Interviews were conducted with local community members and regulatory agencies to document the perceived status of the Site and any perceived problems or successes with the remedy. Community members were interviewed in person at the Vancouver Regional Library following the site visit. Claire Hong, EPA RPM; Judy Smith, EPA Community Involvement Coordinator, and Aaron King, USACE Environmental Engineer conducted the community interviews. Stakeholders interviewed included Moshen Kourehdar, Site Manager for Ecology, and Steve Prather, Water Quality Resource Manager for Clark County Public Utilities. Interview transcripts are presented in Appendix D.

In general, community members were satisfied with the remedy progress and the level of information distributed by EPA to the community. The Church of God representative noted that EA Engineering has been willing to work with them to coordinate sampling activities with the school schedule. Several community members, who reside near the new Clark County Sports Complex, are upset with EPA's oversight of the Site and are disappointed with EPA's response to the discovery of the Northern Plume. EPA increased outreach efforts to assure the public that there are no risks to human health from the contaminated groundwater at depth beneath the sports complexes by posting informational

reports to the EPA website, updating the Hazel Dell Neighborhood Association, attending public meetings, and installing a sign near the new sports field describing the location of the contamination. The Washington State Department of Health has also concurred that there are no health risks present due to the depth of the groundwater contamination (50 to 90 feet below ground surface) and that it is not used as drinking water.

Stakeholders generally felt well informed about the Site through communication with EA Engineering. Mr. Kourehdar felt the remedy was making progress toward meeting cleanup levels. Mr. Prather had some concerns about residual contamination following remedy completion and whether it could impact the Troutdale aquifer, which is used as a drinking water source. He was also concerned about the potential for establishing a hexavalent chromium MCL and how it would impact the current remedy.

6.7. Institutional Controls

The 2000 ROD and 2006 ESD required the following institutional controls for the Site: a deed restriction for the Boomsnub property; controlled access to the Boomsnub property; public notice during operation of groundwater pumping to affected property owners; and easements (access agreements) on affected property (see Table 4).

The deed restriction to limit future use of the Boomsnub property has not been formally recorded. Access to the Boomsnub property is currently restricted by a gate and fencing. The gate is locked when Site personnel are not present.

Groundwater quality information is provided to affected property owners. Linde sends letters to property owners following groundwater sampling events that include the analytical results, an explanation of cleanup levels, and typical data qualifiers.

Linde continues to work with EPA to acquire the necessary access agreements/restrictive covenants. Currently, Linde has obtained fourteen agreements including the BOC easement/restrictive covenant. EPA has identified six additional properties that contain pipelines or other infrastructure where access agreements are necessary. The agreements allow access by EPA and its representatives for the purpose of conducting activities related to the environmental cleanup. The agreements also prohibit installation of new wells and the use of groundwater beneath the property. Figure 13 shows the status of the easements as of September 2012. Note that there is not an agreement in place on the property where well MW-35 is located and *in-situ* treatment is being considered, which may delay attainment of cleanup levels in this area. The Washington State Well Log Viewer website was also queried to determine if there have been any drinking water wells installed near the Site. Based on that data, there have been no drinking water wells installed within the last five years that would be in breach of the restrictive covenants or within the footprint of the plume.

7. Technical Assessment

7.1. Question A: *Is the remedy functioning as intended by the decision documents?*

Yes. All accessible chromium-contaminated soil at OU 1 has been removed and access to the Boomsnub property is controlled. A deed restriction to maintain the industrial land use and prevent soil below 15 feet from being disturbed still needs to be completed. The majority of VOCs has been removed from the vadose zone at OU 2 and the SVE system has been turned off. In August 2013, EPA approved the temporary cessation of pulse pumping of the IWS system. This will be accompanied by increased monitoring of wells in the IWS area in addition to those down gradient of the IWS area. Final termination of the IWS system will be considered once the additional data are collected. . The groundwater extraction system for OU 3 continues to remove contaminants and decrease the size of the plume. A Site closure process has been drafted but not approved. Cleanup levels have been met in the Sentinel wells, and that area is no longer monitored. In-situ treatment has proven effective at removing contaminants in recalcitrant areas of residual contamination at the toe-of-plume. Additional investigations have been completed to define the Northern Plume and it appears to be a detached plume moving down-gradient. The source for the Northern Plume has not been precisely defined; however, the source is likely not the same as the source of the OU 3 plume. This conclusion is based on the plume's geographic location and the lack of CFC-11 concentrations in the Northern Plume, which have been present in the OU 3 plume.

Remedial Action Performance

The chromium and TCE plumes continue to decrease in size with operation of the extraction and treatment system. Decreasing trends in concentrations are observed at most wells. The furthest down-gradient extraction wells in operation are currently MW-25D, MW-26D, and MW-49 located on the Church of God property. The Sentinel wells met attainment criteria, and monitoring in that area was terminated in 2008. The new toe-of-plume is currently located on the Church of God property. In-situ treatment has proven effective near well MW-41 and is being considered to treat remaining residual contamination near wells MW-35 and AMW-27.

The Northern Plume was identified in 2007 when TCE concentrations at well AMW-18 increased significantly. Since that time two investigations have been completed to determine the extent of the plume and potential sources. The 2011 investigation concluded that the source was not the same as for OU 3 due to the Northern Plume's geographic location. Supporting evidence included the lack of detections for CFC-11, which has historically been an indicator of the OU 3 TCE plume from the Linde property. In 2011, AMW-17, the closest well down-gradient from AMW-18, experienced an increase in TCE concentrations. Since TCE concentrations at AMW-18 have been declining, it is assumed that the Northern Plume is detached from the source area and moving down-gradient as a slug of contaminated groundwater.

System Operations/O&M

The SVE system VOC removal rate reached asymptotic conditions in 2006 and was turned off in 2008 after passing three rebound tests. The termination of the IWS system has also begun. In August 2013, EPA approved the temporary cessation of pulse pumping of the IWS system. This will be accompanied by increased monitoring of wells in the IWS area in addition to those down gradient of the IWS area. Final termination of the IWS system will be considered once the additional data are collected. TCE concentrations at IWS compliance wells AMW-1A, AMW-2A, and AMW-12A have shown some fluctuations since the IWS wells were put in pulse-pumping mode.

The groundwater extraction and treatment system has been successful at decreasing concentrations and extent of the TCE and chromium plumes. The current system capacity is 160 gpm. Extraction has been discontinued at the toe-of-plume wells and the wells in the Sentinel area have met cleanup levels. *In-situ* groundwater treatment is being considered for areas of residual contamination near MW-35 and AMW-27 so that additional extraction wells can be turned off.

Operational costs have decreased during this Five-Year Review period. The causes of this decrease are the discharge of treated groundwater to the infiltration gallery instead of to the sanitary sewer system, the optimization of the groundwater monitoring program, and the termination of the SVE system and some IWS wells.

Opportunities for Optimization

The groundwater monitoring program has been optimized annually using the screening process described in the draft Closure Plan (EA 2009). Since the process was implemented, the monitoring program has been reduced in the number and sampling frequency of wells. The following recommendations should be considered during the next annual screening/optimization evaluation to determine whether necessary data are being collected to make informed Site decisions:

- Increase sampling frequency at potentially impacted wells when system operations changes are made (e.g., when extraction wells or IWS wells are terminated). Analyze samples from wells previously removed from the program as necessary to confirm attainment.
- Complete a comprehensive sampling event at a low frequency, such as every five years, to monitor trends in wells removed from the program and to determine the horizontal and vertical extent of the plume.
- Evaluate the appropriate use of the MAROS attainment analysis prior to the development of a final exit strategy.

Implementation of Institutional Controls

Notice of groundwater quality is sent to affected property owners following each groundwater sampling event. Access agreements/restrictive covenants have been obtained at fourteen properties. Linde is continuing to work with EPA to complete the remaining high priority agreements. A deed restriction for the Boomsnub property is still needed to limit future use.

Early Indicators of Potential Issues

There are no early indicators of potential issues.

7.2. Question B: Are the exposure assumptions, toxicity data, cleanup levels, and remedial action objectives (RAOs) used at the time of the remedy selection still valid?

Changes in Standards and Toxicity Based Criteria

Applicable or relevant and appropriate requirements (ARARs) cited in the ROD were reviewed to evaluate any changes in the ARARs since the last five-year review. A summary of chemical-specific standards is provided in Table 8; summaries of action- and location-specific requirements are presented in Table 9 and Table 10. There have been no changes in regulatory standards since the second five-year review.

For purposes of this review, EPA considered whether there have been changes in promulgated standards identified as ARARs, the basis for cleanup levels, or new toxicity information calling into question the protectiveness of the remedy. For TCE, the groundwater cleanup level selected in the 2000 ROD is based on the MCL of 5.0 µg/L, which according to that ROD equated to an excess cancer risk of 1.26×10^{-6} . In addition to Federal drinking water standards, Washington State's MTCA groundwater cleanup standards were identified as ARARs. The MTCA Method B cleanup value for TCE calculated at that time to pose an excess cancer risk of 1×10^{-6} was 3.98 µg/L. Based on those calculations, the MCL was deemed to be sufficiently protective and was selected as the groundwater cleanup standard. However, since that time EPA and others have re-evaluated the TCE cancer risk due to concerns that TCE may pose greater risks than previously estimated. The value for TCE that was originally used in remedy selection for this Site was withdrawn by EPA and a new value was included in the Integrated Risk Information System (IRIS) database in 2011. The concentration that equates to an excess cancer risk of 1×10^{-6} is now 0.5 µg/L. Because 5 µg/L is now considered to equate to an excess cancer risk of 1×10^{-5} , the cleanup standard specified in the ROD still falls within the acceptable risk range under CERLCA.

In October 2004 the Washington State Department of Ecology updated its guidance for calculating risk levels for TCE under MTCA to include a more conservative cancer slope factor for ingestion and inhalation of TCE. Using the revised cancer potency factor, the MTCA method B groundwater cleanup level that equates to an estimated excess cancer risk of 1×10^{-6} is 0.11 µg/L (so 1.1 µg/L would equate to 1×10^{-5} and 11.0 would equate to 1×10^{-4}). Applying the more conservative cancer slope factors Ecology has been using, the risk at the MCL would be approximately 5×10^{-5} , which falls within the acceptable risk range.

Changes in Exposure Pathways

The ROD described current and future land uses and identified likely exposure pathways; the descriptions are accurate for the site conditions at the time of this review. The potential risk posed by intrusion of VOCs into indoor air was not explicitly recognized as a significant pathway at the time the

ROD was prepared. As stated in the ROD, the Phase 2 Site Evaluation did assess whether there are potential unacceptable risks associated with current and potential future human exposures to Site COCs intruding into the indoor air of the Site's control room. The results from the screening level risk evaluation using indoor air modeling showed that the incremental cancer risk was 2.3×10^{-5} . For the more site-specific tier 2 risk evaluation, the incremental cancer risk was 2.5×10^{-6} . Since the risks associated with exposure to TCE in indoor air were lower than 1×10^{-4} , which is the upper end of the established range of acceptable risks under CERCLA, it is unlikely that exposure will result in significant health risk. Risks at adjacent residential properties are considered to be at an extremely lower level because unimpacted groundwater overlies the TCE plume. The plume continues to migrate downward as it extends further from the source at Linde property, thus reducing the exposure pathway for TCE in groundwater. There are changes in the non-cancer toxicity information for TCE, but since unimpacted groundwater overlies the TCE plume in the residential area, the risks are unlikely.

Although cleanup levels are unchanged and are still considered to be protective, there was an Explanation of Significant Differences that allowed a change in the discharge, for which temporary conservative discharge standards were established. These temporary discharge standards did not call into question the validity of cleanup levels and RAOs.

Revisions to the toxicity values for 1,1-DCE indicate a lower risk from exposure than previously considered. The oral reference dose increased from 0.009 mg/kg-day to the current 0.05 mg/kg-day, indicating a lower risk from exposure. Furthermore, cancer slope factors were removed from the IRIS database because 1,1-DCE showed equivocal evidence of carcinogenicity by the oral route of exposure and the weight of evidence was not sufficient to justify deriving an inhalation risk. Under the 1999 draft revised guidelines for carcinogen risk assessment, EPA concludes 1,1-DCE exhibits suggestive evidence of carcinogenicity but not sufficient evidence to assess human carcinogenic potential. These changes do not affect the protectiveness of the groundwater remedy.

The recent development of nearby sports fields on the Clark County Parks and Church of God properties are the only land use or physical conditions of the Site that have changed since the previous five-year review. This development should not impact any exposure pathways previously identified.

There are no unanticipated byproducts of the remedy identified since the previous five-year review.

Changes in Toxicity and Other Contaminant Characteristics

As stated previously, there have been changes to the toxicity factors for TCE and 1,1-DCE. The cleanup standard for TCE still falls within an acceptable level of risk and is therefore still considered protective of human health and the environment. The toxicity value for 1,1-DCE was decreased, and therefore cleanup standards are still considered protective. Carcinogenic risk via oral exposure is also no longer considered a viable risk for 1,1-DCE.

The MTCA B cleanup level for carbon tetrachloride was changed from 0.34 $\mu\text{g/L}$ to 0.63 $\mu\text{g/L}$ in 2011 based on updated toxicity values. Because these values are still both under the practical quantitation limit, the cleanup standard at the Site remains 1 $\mu\text{g/L}$.

Changes in Risk Assessment Methods

There have been no changes in the standard risk assessment methods used to support the ROD. The ecological risk assessment documented in the 2000 ROD discussed the potential risk to the representative plant, invertebrate, avian, and mammalian species at the Boomsnub Soil and Groundwater OUs. The assessment for soil indicated that risks posed by the COCs are not significant. The ROD also identified no known potential exposure routes from the Site-Wide Groundwater OU to ecological receptors. It is believed that this risk assessment is still valid and no unacceptable ecological risks are expected at the Site.

Expected Progress Toward Meeting RAOs

The RAOs from the ROD are still valid for the Site. Most of the Site is on track to meet RAOs. The TCE and chromium plumes are decreasing in size. Extraction wells within the toe-of-plume area have been shut down and monitoring wells in the Sentinel area have attained cleanup levels. Once recalcitrant contaminant concentrations are treated near wells MW-35 and AMW-27, the new toe-of-plume area will be located near the Church of God.

Table 8. Changes in Chemical-Specific Standards

Contaminant	Media	Cleanup Level	Standard		Citation/Year
			previous	new	
total chromium	soil	400 mg/kg	previous	--	site-specific remediation level ¹
			new	--	--
chromium VI	soil	8 mg/kg	previous	8 mg/kg	MTCA 100x groundwater standard ²
			new	--	--
		17,500 mg/kg	previous	17,500 mg/kg	MTCA C Industrial
			new	--	--
chromium III	soil	1,600 mg/kg	previous	1,600 mg/kg	MTCA 100x groundwater standard ²
			new	--	--
lead	soil	1,000 mg/kg	previous	1,000 mg/kg	MTCA A Industrial ³
			new	--	--
chromium VI	ground water	80 µg/L	previous	80 µg/L	MTCA B
			new	--	--
total chromium	ground water	100 µg/L	previous	100 µg/L	MCL
			new	--	--
bromodichloro-methane	ground water	1 µg/L	previous	0.706 µg/L	MTCA B
			new	--	--
carbon tetrachloride	ground water	1 µg/L	previous	0.337 µg/L	MTCA B
			new	0.63 µg/L	MTCA B 2011
1,2-dibromo 3-chloropropane	ground water	0.2 µg/L	previous	0.0313 µg/L	MCL
			new	--	--
dibromochloro-methane	ground water	1 µg/L	previous	0.521 µg/L	MTCA B
			new	--	--
1,2-dichloro-methane	ground water	5 µg/L	previous	5 µg/L	MCL
			new	--	--
1,1-dichloro-ethene	ground water	1 µg/L	previous	0.0729 µg/L	MTCA B
			new	No data	MTCA B, 2008
hexachloro-butadiene	ground water	5 µg/L	previous	0.561 µg/L	MTCA B
			new	--	--
tetrachloro-ethene	ground water	5 µg/L	previous	5 µg/L	MCL
			new	--	--
1,1,1-trichloroethane	ground water	200 µg/L	previous	200 µg/L	MCL
			new	--	--
trichloroethene	ground water	5 µg/L	previous	5 µg/L	MCL
			new	--	--

Table 9. Changes in Action-Specific Requirements

Action		Requirement	Prerequisite	Citation/Year
air	previous	These establish emission standards for specific VOC source emissions.	An air permit with the local clean air agency incorporates these standards for the air-stripping system.	Clean Air Act, 42 USC §7401, et seq; Washington Emission Standards and Controls for Emitting Volatile Organic Compounds, WAC 173-490
	new	The requirement has not been updated or superseded. This is still applicable. The remedial actions using air stripping are still occurring.	--	--
air	previous	This prescribes treatment and control requirements for air emissions.	For controlling air emissions from the air-stripping system. An air permit with the local clean air agency incorporates these standards.	Washington General Regulations for Air Pollution Sources, WAC 173-400; Southwest Washington Air Pollution Control Agency Regulations 400 and 490
	new	The requirement has not been updated or superseded. This is still applicable. The remedial actions using air stripping are still occurring.	--	--
air	previous	This identifies suspended particulate standards	For excavation activities associated with soil removal at the Boomsnub Soil OU.	Washington Ambient Air Quality Standards for Particulate Matter, WAC 173-470;
	new	The requirement has not been updated or superseded. This is still applicable. Soil removal may occur in the future.	--	--
groundwater	previous	These regulations pertain to the off-site disposal of treated groundwater. 40 CFR 403.5 prohibits discharges of pollutants into a POTW that pass through the facility without treatment or that interfere with the treatment works.	Linde has a permit to discharge treated groundwater to the City of Vancouver's POTW. Site discharges meet the requirements of the permit.	Clean Water Act, 33 U.S.C. 1317; 40 CFR 403.5; Washington Water Pollution Control Act, RCW 90.48; Washington Water Resources Act, RCW 90.54; Washington Grant of Authority Sewerage Systems, WAC 173-208
	new	The requirement has not been updated or superseded. This is still potentially applicable. The Site now discharges treated groundwater into an infiltration gallery on the Linde property. EPA monitors the groundwater in the vicinity of the infiltration gallery to monitor whether this discharge may contribute to the overall plume.	--	--

Action		Requirement	Prerequisite	Citation/Year
groundwater	previous	This requires that wastes are to be provided with all known, available, and reasonable methods of treatment prior to their discharge or entry into waters of the state.	Contaminated groundwater will be treated using ion-exchange and air stripping, prior to discharge to the City of Vancouver's POTW .	Pollution Disclosure Act of 1971, RCW 90.52.040
	new	The requirement has not been updated or superseded. This is still applicable. The contaminated groundwater is treated, using ion-exchange and air stripping, prior to discharge to the infiltration gallery located on the Linde property.	--	--
contaminated resin/spent carbon/contaminated soil	previous	These establish regulations for transportation of hazardous materials.	Transportation of resin and contaminated soil (if hazardous) to an off-site disposal facility is anticipated. Linde will meet these requirements during cleanup activities.	U.S. Department of Transportation, 49 CFR Parts 171-180; Washington Transportation of Hazardous Waste Materials, WAC 446-50
	new	The requirement has not been updated or superseded. This is still applicable. Resin and potentially contaminated soil are wastes that require transportation and disposal.	--	--
groundwater	previous	These specify requirements for well construction and abandonment intended to protect groundwater from contamination.	The construction of additional monitoring and extraction wells and the abandonment of any wells will comply with these standards.	Washington Water Well Construction Act, RCW 18.104; Washington Minimum Standards for Construction and Maintenance of Wells, WAC 173-160
	new	The requirement has not been updated or superseded. This is still applicable. Portions of the extraction system have been shut down and may require abandonment. Also, additional extraction and monitoring wells may be constructed to optimize the existing extraction system.	--	--
non-hazardous waste	previous	These establish requirements for the disposal of nonhazardous waste, where all nonhazardous waste generated will be disposed of off-site.	The disposal of non-hazardous waste generated is off-site, thereby complying with these regulations.	Washington Solid Waste Management-Reduction & Recycling Act, RCW 70.95; Washington Minimum Functional Standards for Solid Waste Handling, WAC 173-304
	new	The requirement has not been updated or superseded. This is still applicable. All non-hazardous waste generated is disposed off-site.	--	--

Table 10. Changes in Location-Specific Requirements

Location	Requirement	Prerequisite	Citation/Year	
wetlands	previous	Requires Linde to avoid long- and short-term adverse impacts associated with the destruction or modification of wetlands and avoid direct or indirect support of new construction in wetlands whenever there is a practicable alternative.	Portions of the extraction system are either within or adjacent to a seasonal wetland located south of NE 78th Street.	Executive Order 11990, Executive Order of Protection of Wetlands
	new	The requirement has not been updated or superseded. This is still applicable. Continued O&M and/or upgrading of the extraction system is necessary to achieve cleanup of the groundwater contamination.	--	--
migratory birds	previous	This protects migratory birds and their feathers, nests, and eggs.	This Site may be in the pathway of migratory birds. Impacts on migratory birds may have been a bigger concern during the removal of soil and the construction of the Boomsnub Soil OU due to these actions' proximity to trees or other potential migratory bird habitat.	Migratory Bird Treaty Act of 1918, 16 USC 703- 712
	new	The requirement has not been updated or superseded. This is still applicable. The current treatment system is located on the Boomsnub Soil OU. Any future work to address this OU may potentially impact migratory birds.	--	--

7.3. Question C: Has any other information come to light that could call into question the protectiveness of the remedy?

No additional information has come to light that could call into question the protectiveness of the remedy.

7.4. Technical Assessment Summary

The remedy is functioning as intended by the decision documents. All accessible chromium-contaminated soil at OU 1 has been removed. VOCs have been removed from the vadose zone at OU 2, and the SVE system has been temporarily terminated. In August 2013, EPA approved the temporary cessation of pulse pumping of the IWS system. This will be accompanied by increased monitoring of wells in the IWS area in addition to those down gradient of the IWS area. Final termination of the IWS system will be considered once the additional data are collected. The groundwater extraction system for OU 3 continues to remove contaminants and decrease the size of the plume. *In-situ* treatment has proven effective at removing contaminants in areas of recalcitrant residual contamination at the toe-of-plume. Investigations of the Northern Plume have determined that it is detached from its source and is attenuating as it moves down-gradient. The groundwater monitoring program has been optimized; however, slight changes to the annual evaluation may be needed. Access agreements/restrictive covenants have been obtained for fourteen properties.

Additional access agreements and a deed restriction for the Boomsnub property are still required. Changes to toxicity factors have been made, but cleanup standards are still within an acceptable level of risk. Recent development of the sports fields does not impact exposure pathways previously identified.

8. Issues

Table 11 summarizes the current issues for the Boomsnub/Airco Superfund Site.

Table 11. Issues

Issues	Affects Current Protectiveness (Y/N)	Affects Future Protectiveness (Y/N)
1. Spikes in TCE concentrations observed at AMW-2A and AMW-12A located down-gradient of the IWS wells.	N	Y
2. Access agreements and restrictive covenants have not been obtained for all properties with groundwater extraction system infrastructure.	N	Y
3. Deed restrictions to limit future use of the Boomsnub property have not been formally recorded.	N	Y

9. Recommendations and Follow-up Actions

Table 12 provides recommendations to address the current issues at the Boomsnub/Airco Superfund Site, along with proposed milestone dates to achieve the followup actions.

Table 12. Recommendations and Follow-up Actions

Issue	Recommendations and Follow-up Actions	Party Responsible	Oversight Agency	Milestone Date	Affects Protectiveness (Y/N)	
					Current	Future
1.	Develop a groundwater exit strategy for IWS wells consistent with EPA guidance.	Linde	EPA	6/15/2014	N	Y
2.	Obtain access agreements and restrictive covenants from remaining high-priority properties.	Linde/EPA	EPA	1/1/2014	N	Y
3.	Record deed restrictions to maintain industrial use of the Boomsnub property and prevent soil disturbance below 15 feet.	EPA	EPA	1/2015	N	Y

Included below are additional recommendations that do not affect current or future protectiveness of the remedy:

- Continue monitoring the Northern Plume and install additional monitoring wells if needed. A simplified analytic model or the existing groundwater flow model could be used to predict future concentrations and determine the influence of extraction on the Northern Plume.
- Annual groundwater monitoring program:
 - Increase the sampling frequency at potentially impacted wells when changes are made to the operation of the treatment system (i.e., groundwater extraction system or IWS wells). Wells removed from the program may also need to be sampled to confirm that operational changes have not impacted aquifer conditions.
 - Complete a more comprehensive sampling event at a low frequency, such as every five years, to monitor trends in wells removed from the monitoring program and to confirm the extent of the plume. Wells removed from the program because they have met cleanup levels may also need to be sampled to confirm the full extent of the TCE and chromium plumes. Wells near *in-situ* remediation areas may also need to be sampled to confirm that rebound has not occurred.

10. Protectiveness Statements

Protectiveness statements for each operable unit are as follows:

OU 1, Boomsnub Soil

The remedy at OU 1 is expected to be protective of human health and the environment upon completion. In the interim, exposure pathways that could result in unacceptable risk are being controlled. All accessible chromium-contaminated soil has been removed to a depth of 15 feet below ground surface and access is restricted.

OU 2, BOC Soil

The remedy at OU 2 currently protects human health and the environment. Soil treatment has been completed and the SVE system has been turned off. Exposure pathways that could result in unacceptable risk for groundwater are being controlled using institutional controls to prevent consumption of groundwater. In order for the remedy to be protective in the long term, continued extraction and treatment of groundwater to prevent migration is necessary.

OU 3, Site-Wide Groundwater

The remedy at OU 3 currently protects human health and the environment. Exposure pathways that could result in unacceptable risk are being controlled through institutional controls. In order for the

remedy to be protective in the long term, continued extraction of groundwater to reduce the plume size and completion of access agreements and restrictive covenants are necessary.

11. Next Review

This is a Site that, according to the CERCLA statute as amended, requires ongoing five-year reviews as long as contaminants remain on site that do not allow for unlimited use and unrestricted exposure. The next five-year review will be due within five years of the signature date of this five-year review (September 2018).

[This page is intentionally left blank.]

FIGURES

[This page is intentionally blank]

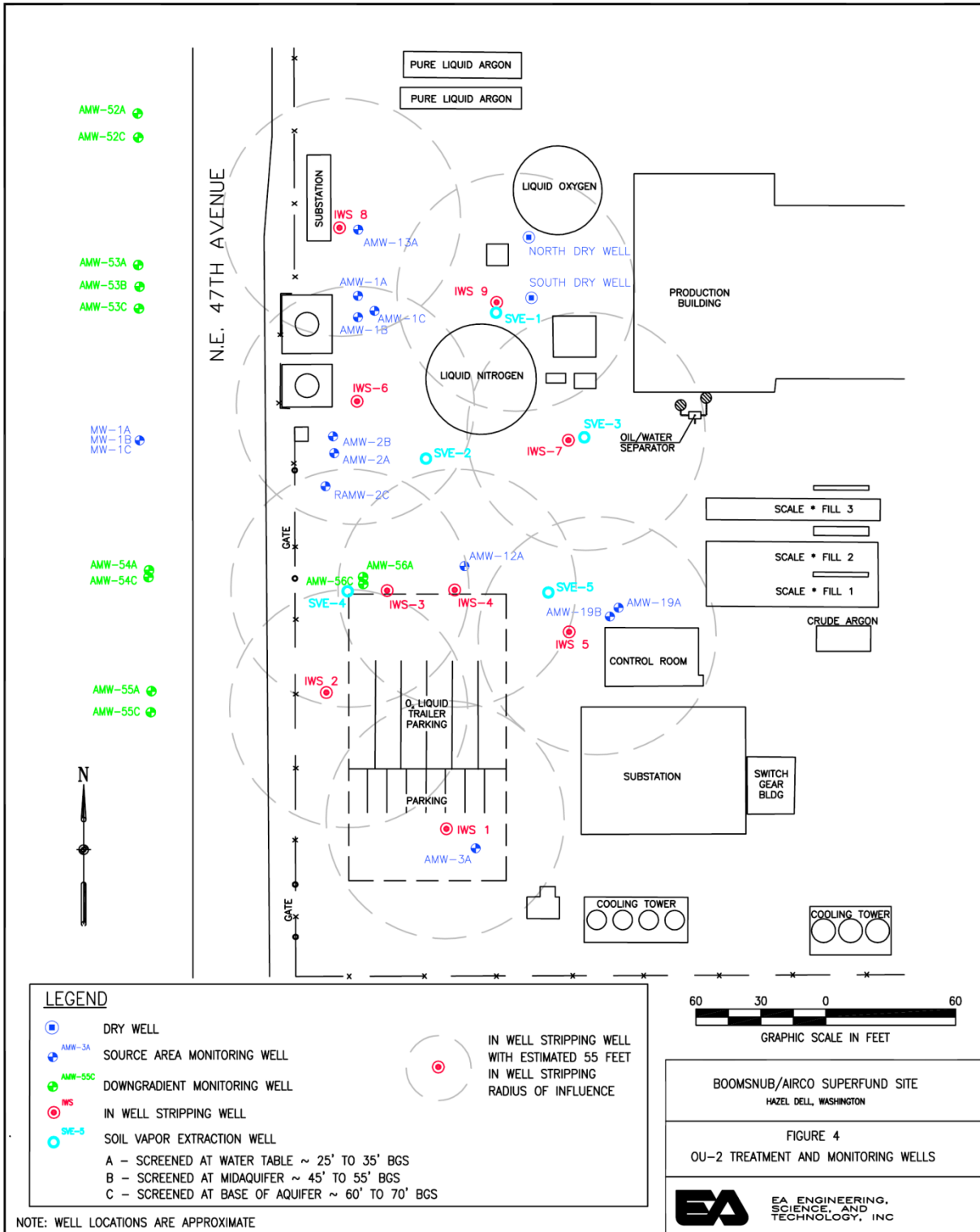

Figure 2. OU 2 Treatment and Monitoring Wells

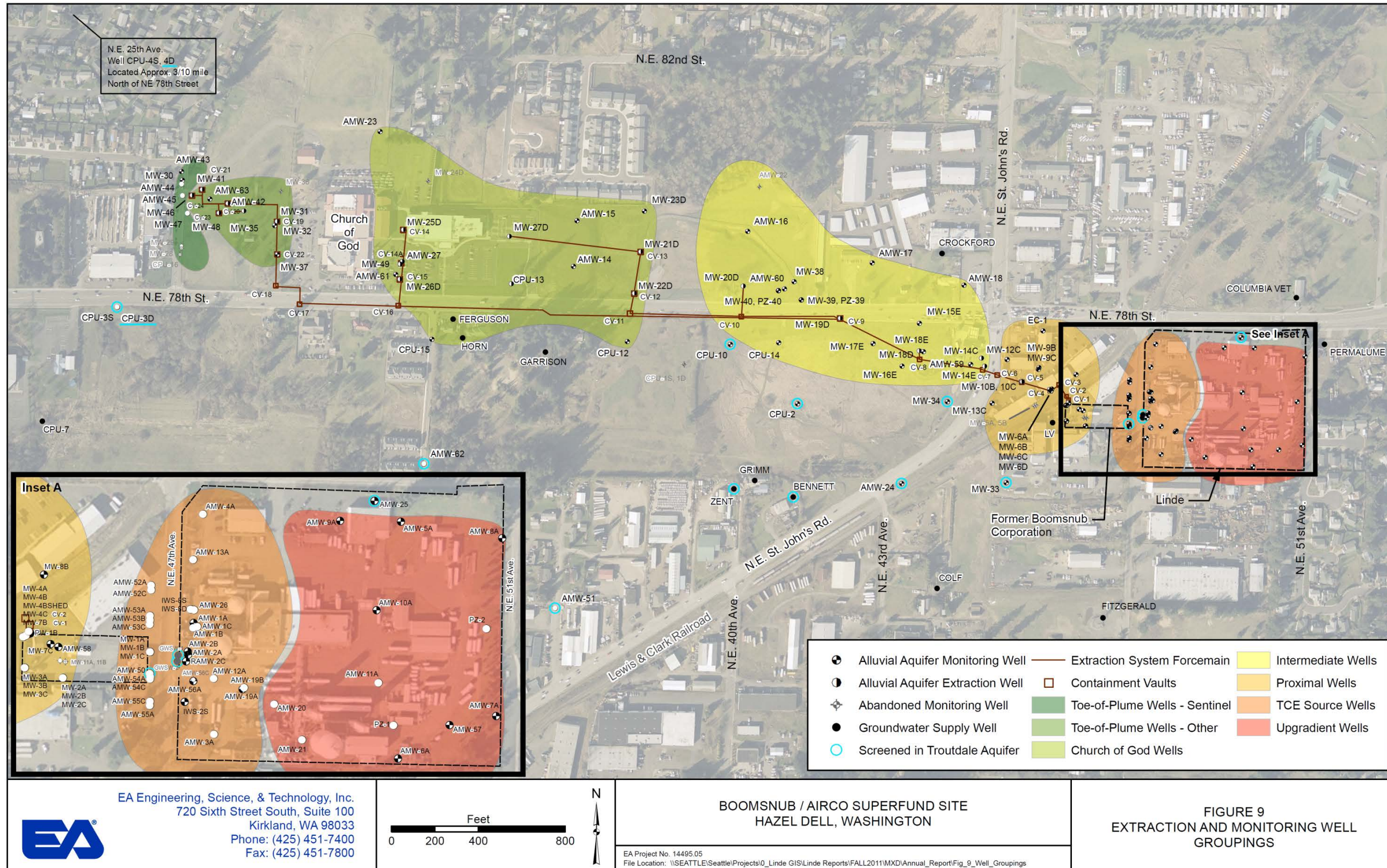

Figure 3. OU 3 Extraction and Monitoring Well Groupings

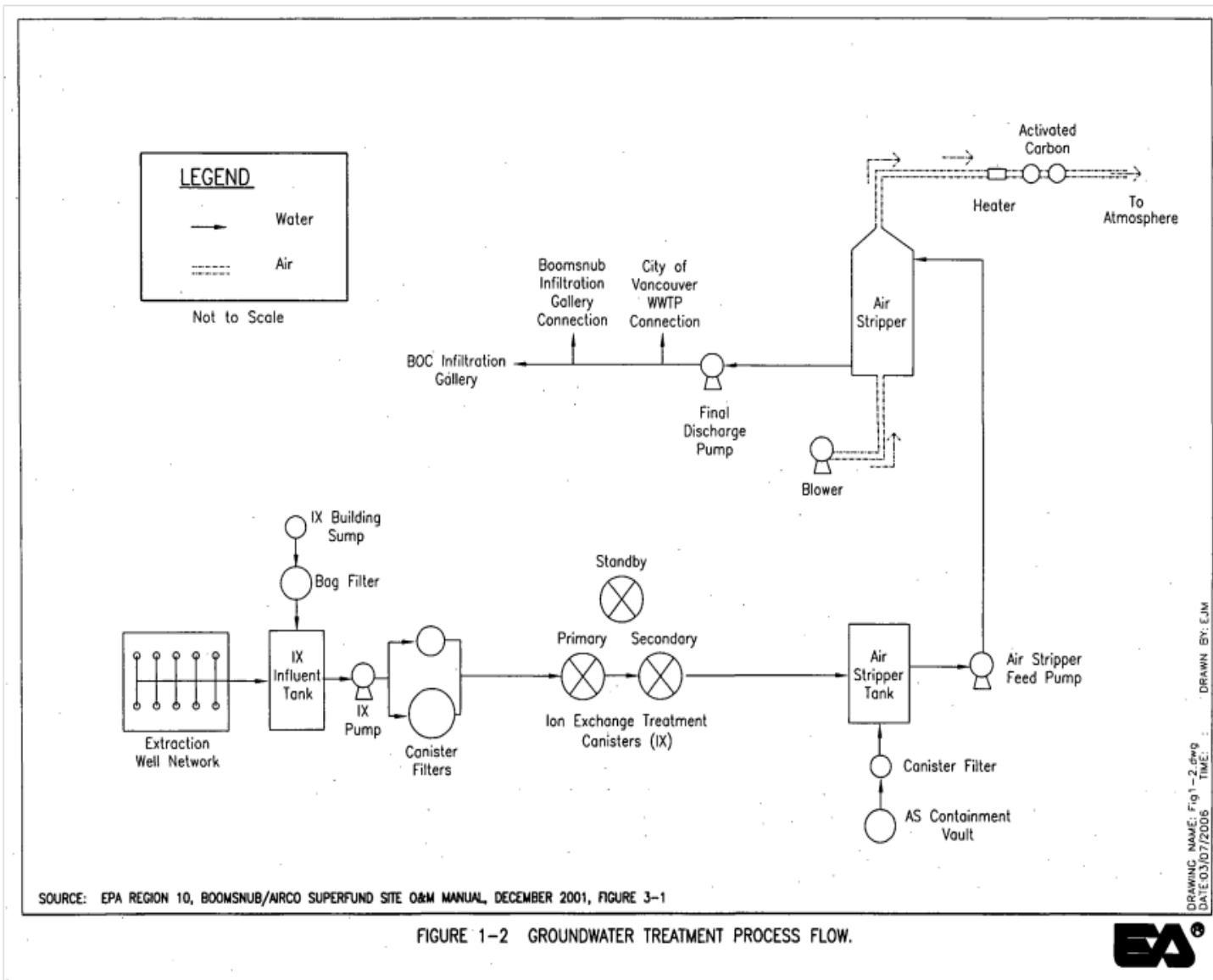

Figure 4. Groundwater Treatment Process

Boomsnub Biweekly System Monitoring Checklist

Name: _____

Date: _____

Groundwater Treatment:			
Ion Exchange System Chromium Testing:		System pH Measurements:	
Kit Used: DR 100 Colorimeter		Initial Calibration	Final Calibration
Test Location:	Chromium (ppm)	Location:	pH
Well Field Influent	_____	Well Field	_____
Canister 1	_____	Pre-IX	_____
Canister 2	_____	IX Effluent	_____
Canister 3	_____	Final Discharge	_____
Final Discharge	_____		
System Flow Rates:			
Location:	GPM	Totalizer	Time
Well Field Influent	_____	_____	_____
IX Influent Flow Meter	_____	_____	_____
AS Influent Flow Meter	_____	_____	_____
COV Sewer Flow Meter	_____	_____	_____
Boomsnub Inf. Gal. Flow Meter	_____	_____	_____
Calculated Flow to BOC Inf. Gal.	_____	_____	_____
Air Stripper Monitoring:			
Pressure Readings:		TCE Concentrations:	
Location:	(In. H ₂ O)	Location:	TCE (ppm)
Blower	_____	Air Stripper Effluent	_____
Air Stripper	_____	Post Primary	_____
		Final Discharge	_____
Capsulhellic Gauge (In. H ₂ O)	_____		
Pre-Heater Air Temperature (F°)	_____		
Pre-Carbon Air Temperature (F°)	_____		
Maintenance:			
Replace Bag Filter?	Yes <input type="checkbox"/>	No <input type="checkbox"/>	Leaks/Notes? _____ _____ _____
Drain Compressor?	Yes <input type="checkbox"/>	No <input type="checkbox"/>	
Replace Canister Filters?	Yes <input type="checkbox"/>	No <input type="checkbox"/>	
Lube Pump Motors?	Yes <input type="checkbox"/>	No <input type="checkbox"/>	
Inspect Infiltration Galleries?	Yes <input type="checkbox"/>	No <input type="checkbox"/>	
Inventory:		Sampling:	
	Quantity	Location	Lab Date Analytes
Gloves	_____	_____	_____
Drums Empty 55-gal	_____	_____	_____
Drums Spent Resin	_____	_____	_____
Bag Filters	_____	_____	_____
Canister Filters	_____	Comments: _____	
10 Micron 29.25 inch	_____		
10 Micron 30 inch	_____		
20 Micron 30 inch	_____		
75 Micron 30 inch	_____		

Figure 5. Groundwater Treatment Biweekly System Monitoring Checklist

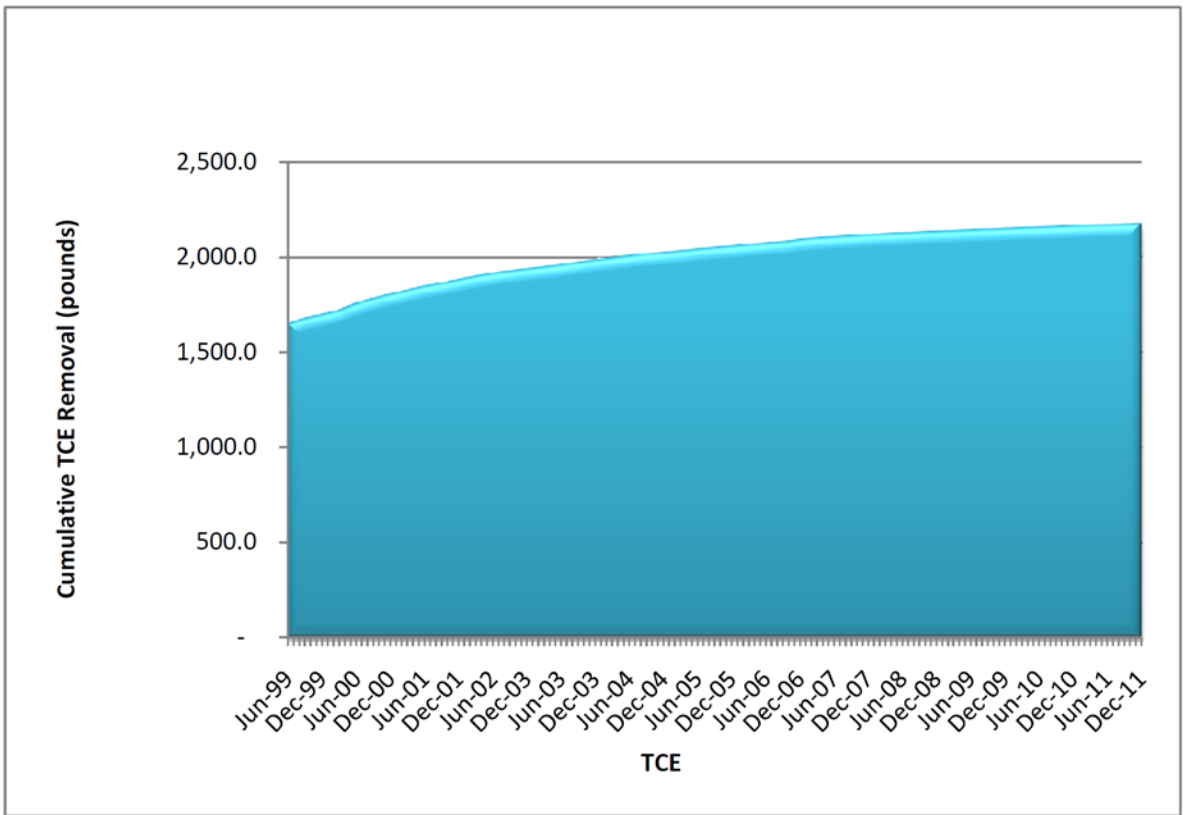
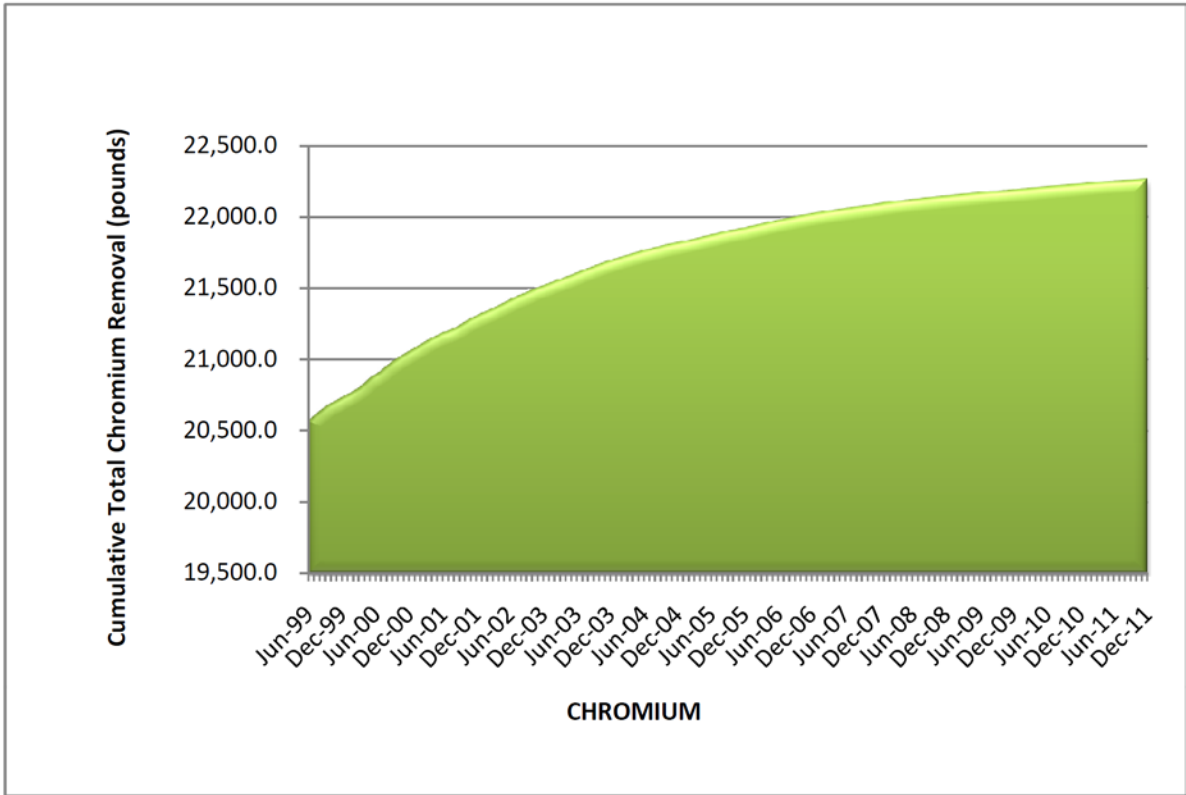

Figure 6. Cumulative Mass Removal between 1999 and 2011

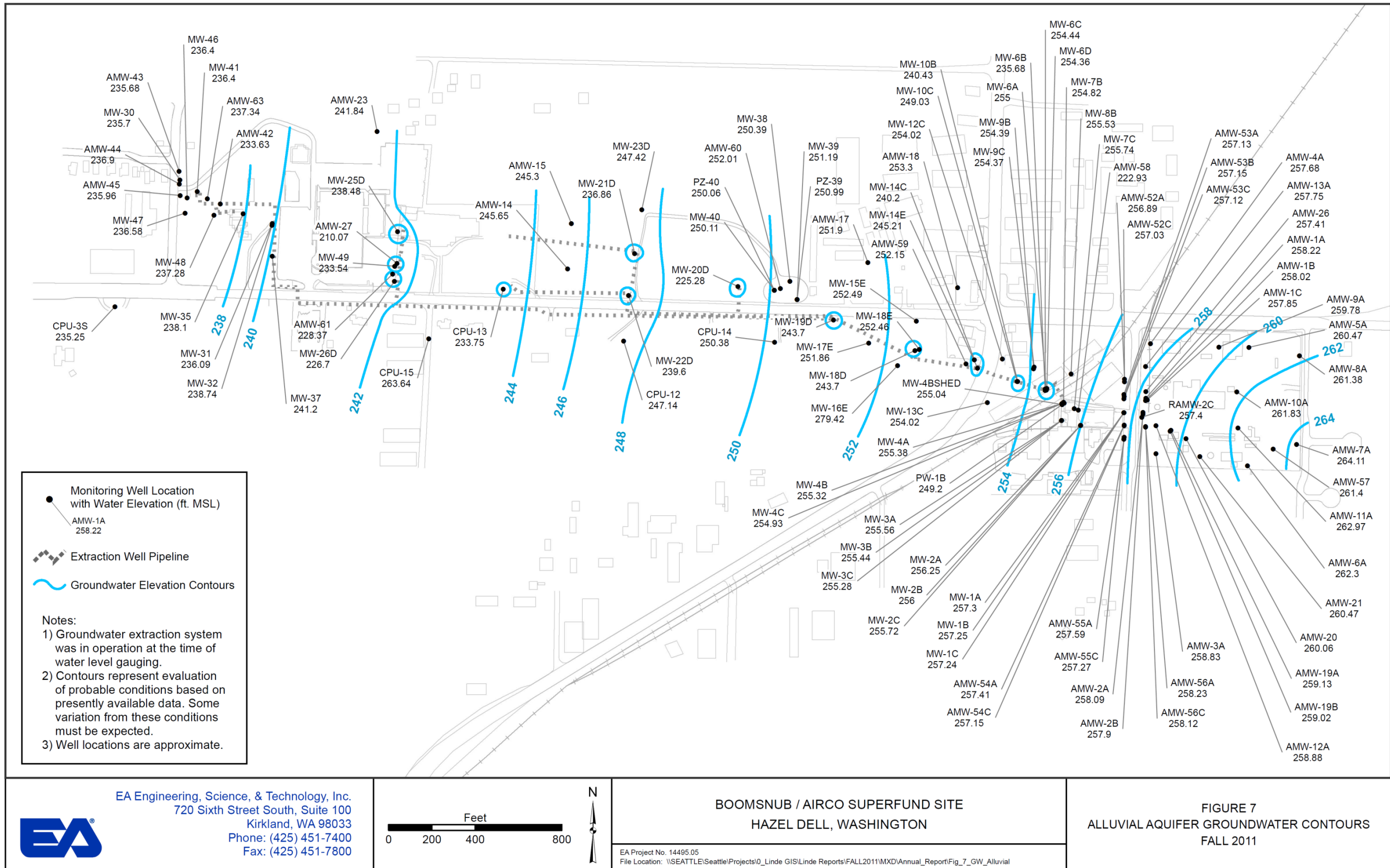

Figure 7. Alluvial Aquifer Groundwater Contours, Fall 2011

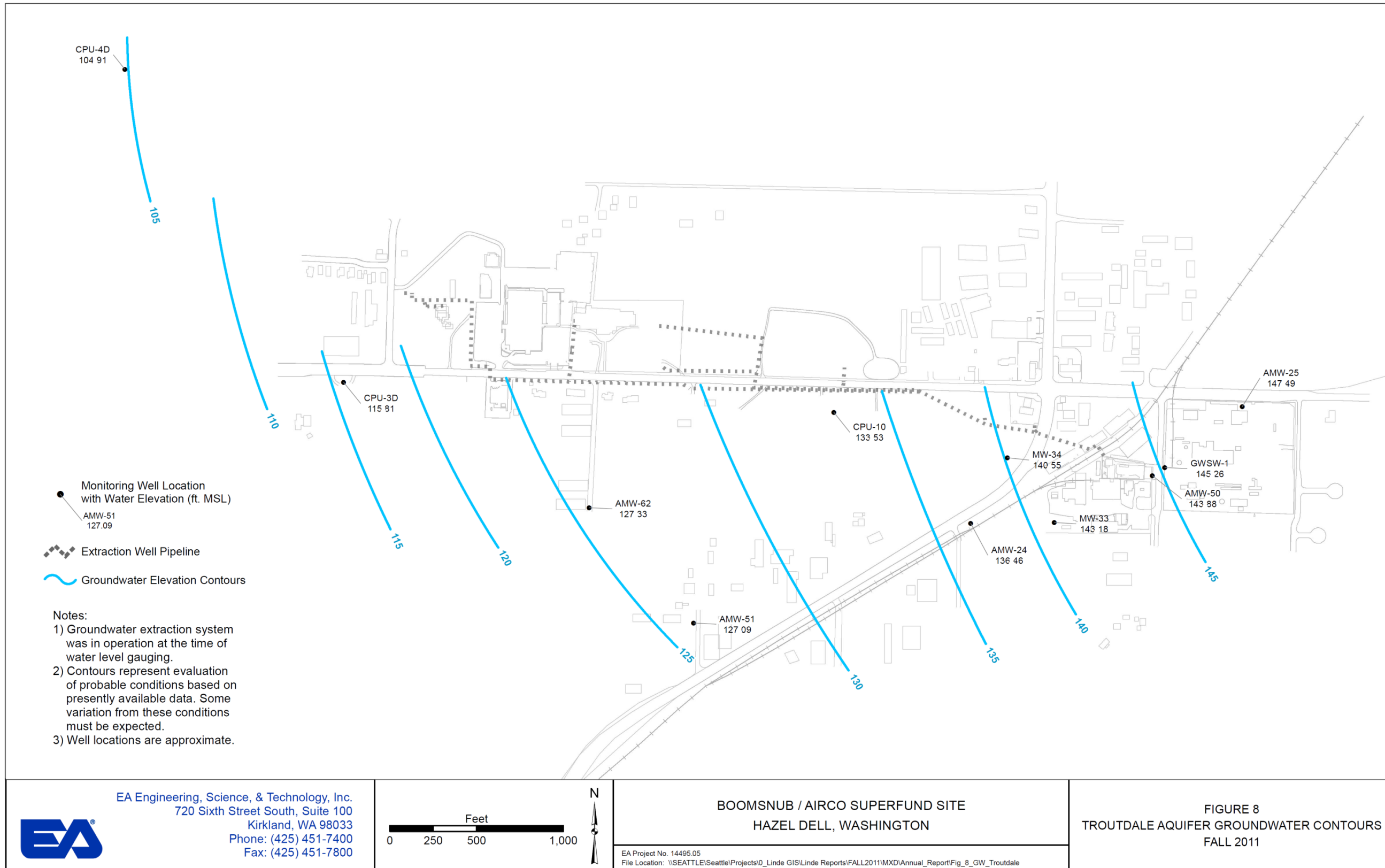

Figure 8. Troutdale Aquifer Groundwater Contours, Fall 2011



Figure 9. Chromium Plume Map, 1995 vs. 2011

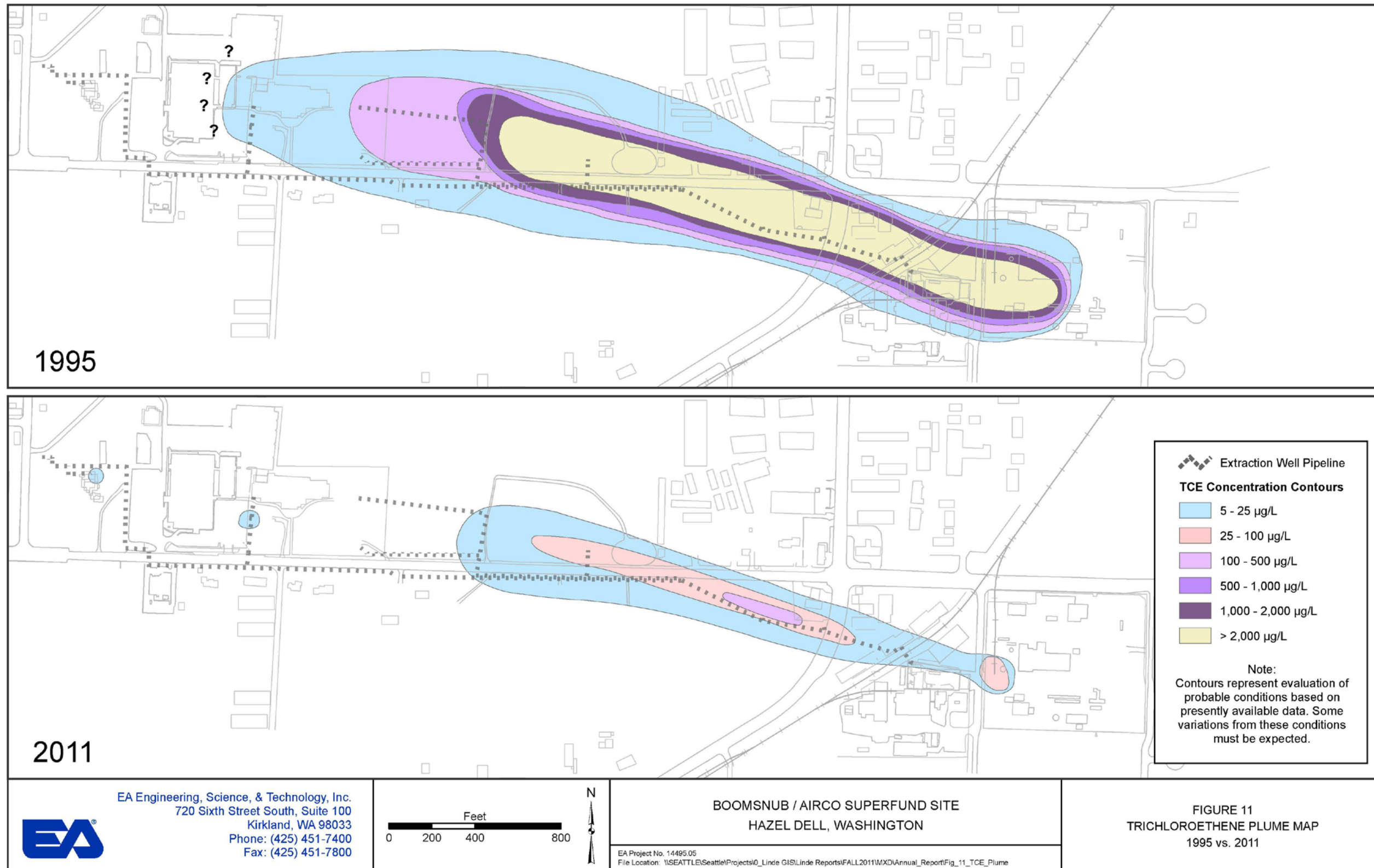

Figure 10. TCE Plume Map, 1995 vs. 2011

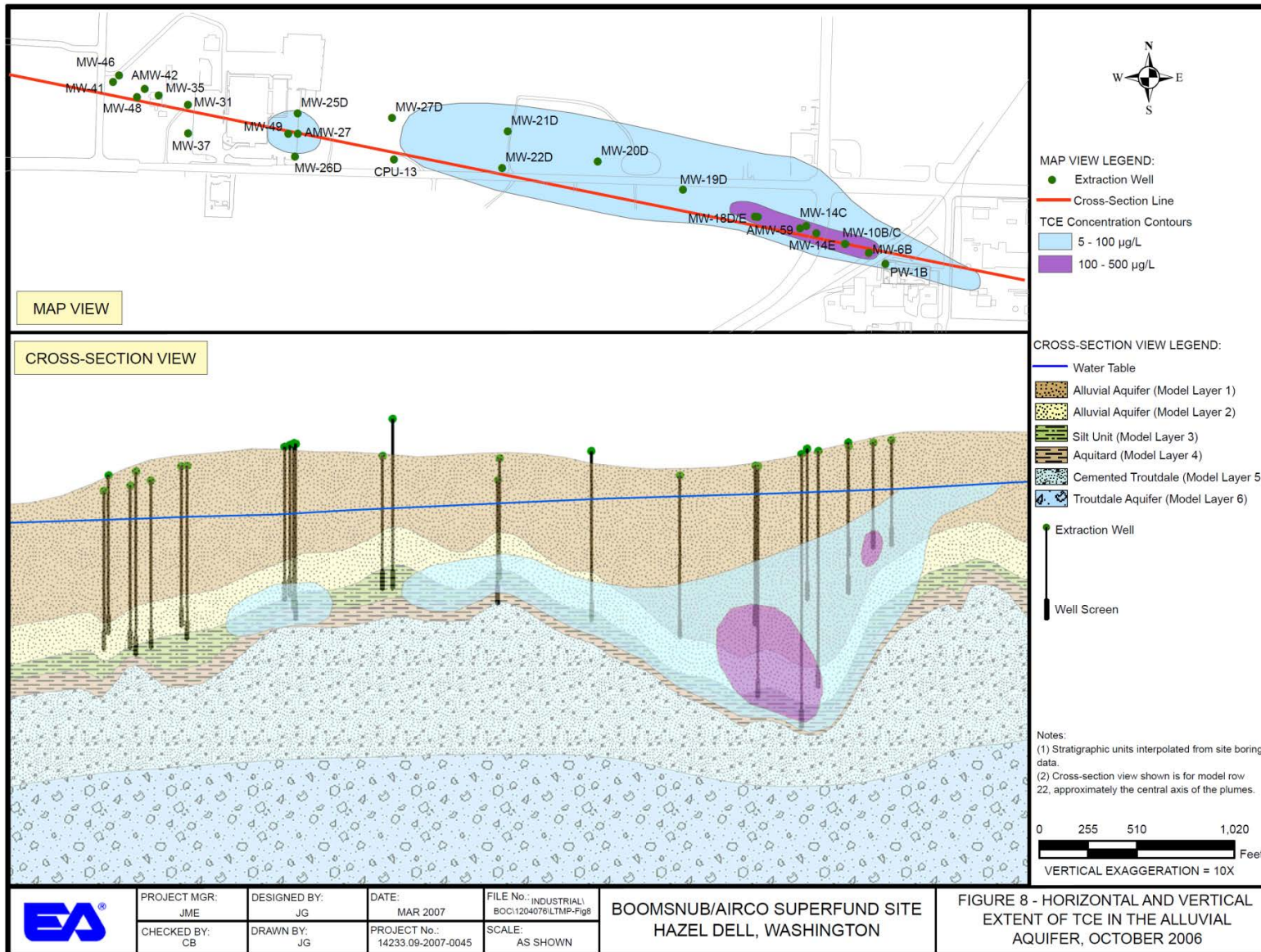

Figure 11. Vertical Distribution of TCE in the Alluvial Aquifer, 2006

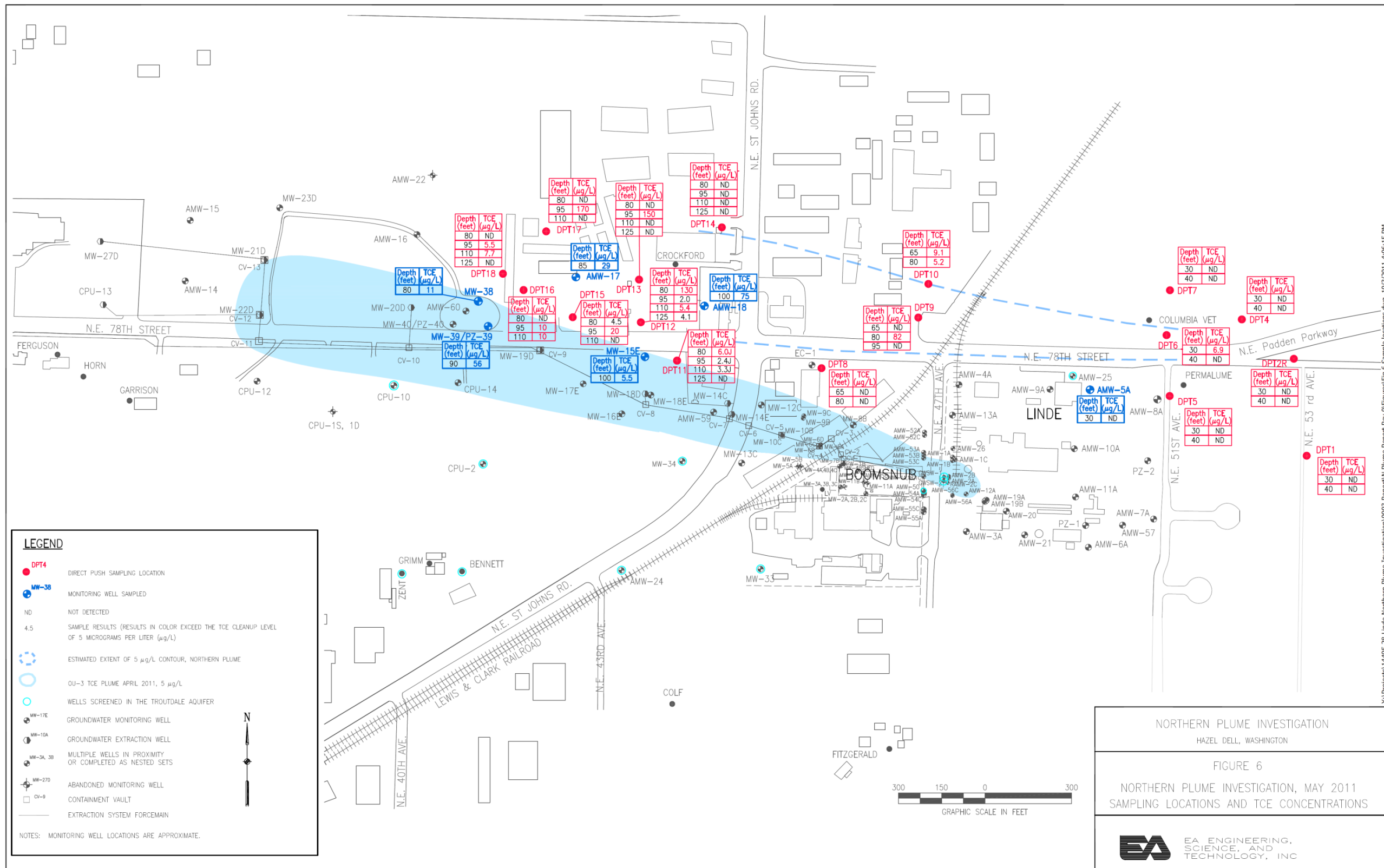

Figure 12. TCE Concentrations, 2011 Northern Plume Investigation

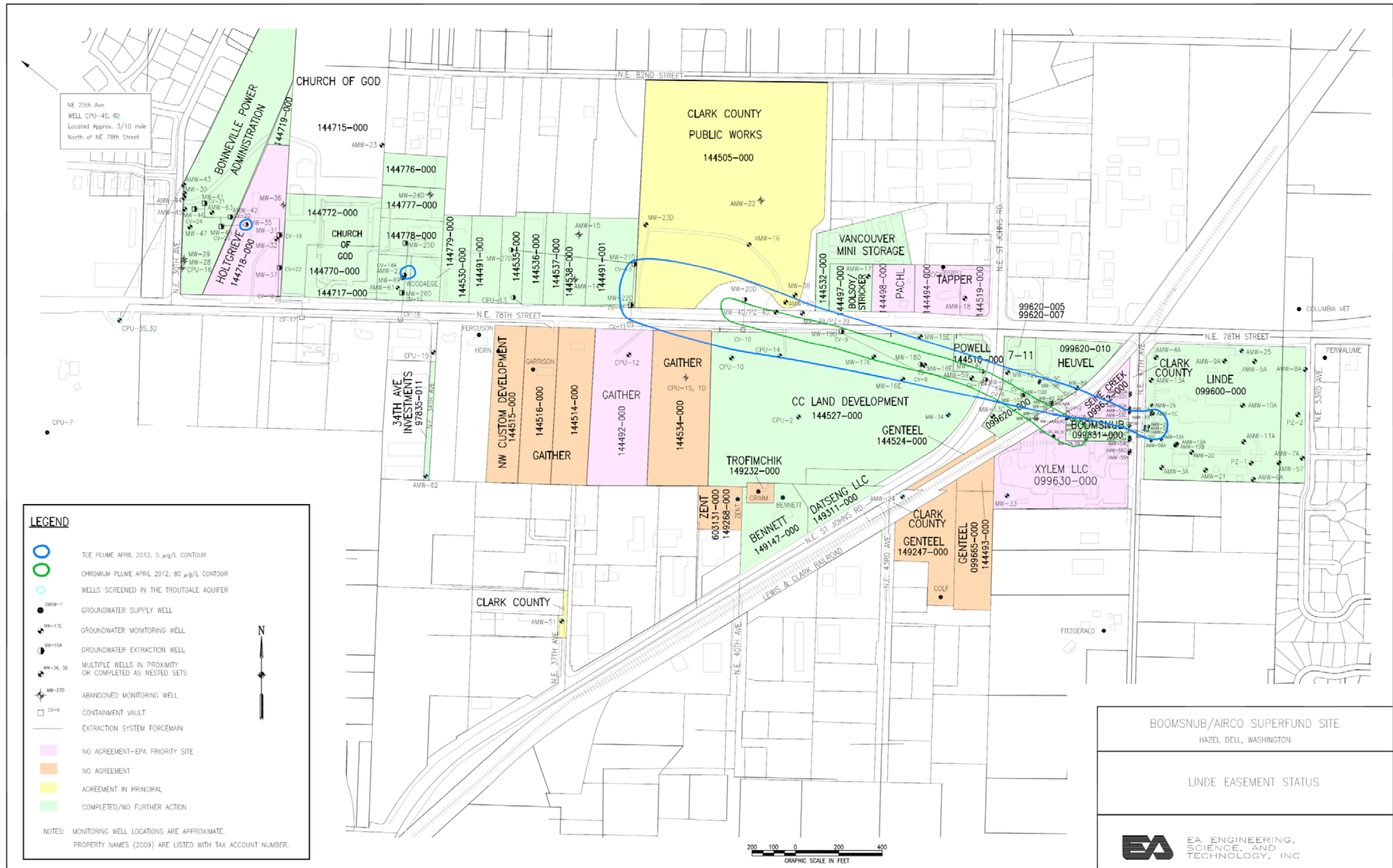

Figure 13. Easement Status as of September 2012

Appendix A: Documents Reviewed

[This page is intentionally blank]

Documents Reviewed

- EA Engineering, Science and Technology, Inc. (EA), 2007. Long-Term Monitoring Plan, Boomsnub/Airco Superfund Site, Hazel Dell, Washington. March 2007.
- EA, 2007. Technical Memorandum, Addendum to Groundwater Modeling Technical Memorandum No. 2 – Assessment of Extraction System Capture in the New (Church of God) Toe-of-Plume Area, Boomsnub Airco Superfund Site, Hazel Dell, Washington. 27 February 2008.
- EA, 2008. AMW-18 Area, Investigation Report, Boomsnub/Airco Superfund Site, Hazel Dell, Washington. August 2008.
- EA, 2009. Closure Plan, Operable Units 2 and 3, Boomsnub/Airco Superfund Site, Hazel Dell, Washington. February 2009.
- EA, 2009. 2008 Annual Status Report for the Boomsnub/Airco Superfund Site, Hazel Dell, Washington. April 2009.
- EA, 2009. Letter Report to USEPA, Re: Air Monitoring Performed during the October 2009 Sampling Event, Boomsnub/Airco Superfund Site, Hazel Dell, Washington. November 6, 2009.
- EA, 2010. 2009 Annual Status Report for the Boomsnub/Airco Superfund Site, Hazel Dell, Washington. April 2010.
- EA, 2011. 2010 Annual Status Report for the Boomsnub/Airco Superfund Site, Hazel Dell, Washington. April 2011.
- EA, 2011. Northern Plume Investigation Report, Hazel Dell, Washington. December 2011.
- U.S. Environmental Protection Agency (EPA), 1997. Record of Decision, Boomsnub/Airco, EPA ID: WAS00924453, OU 2, Vancouver, WA. September 29, 1997.
- EPA, 2000. Record of Decision, Boomsnub/Airco, EPA ID: WAS00924453, OU 1, Vancouver, WA. February 3, 2000.
- EPA, 2006. Explanation of Significant Differences for the Boomsnub/Airco Superfund Site, Hazel Dell, Washington. August 2006.
- United States of America. Consent Decree. United States of America v. The BOC Group Inc. Filed July 2, 2007.

[This page is intentionally blank]

Appendix B: Site Inspection Checklist

[This page is intentionally blank]

Site Inspection Checklist

Appendix B: Five-Year Review Site Inspection Checklist

I. SITE INFORMATION	
Site name: Boomsnub/Airco	Date of inspection: 10/18/12
Location: Hazel Dell, WA	EPA ID: WAD009624453
Agency, office, or company leading the five-year review: EPA/USACE	Weather/temperature: Sunny, warm
Remedy Includes: (Check all that apply) <input type="checkbox"/> Landfill cover/containment <input type="checkbox"/> Monitored natural attenuation <input checked="" type="checkbox"/> Access controls <input type="checkbox"/> Groundwater containment <input checked="" type="checkbox"/> Institutional controls <input type="checkbox"/> Vertical barrier walls <input checked="" type="checkbox"/> Groundwater extraction and treatment <input type="checkbox"/> Surface water collection and treatment <input checked="" type="checkbox"/> Other: <i>Groundwater monitoring</i> _____	
Attachments: <input type="checkbox"/> Inspection team roster attached <input type="checkbox"/> Site map attached	
II. INTERVIEWS (Check all that apply)	
1. O&M site manager <u>Richard Read</u> <u>Site Operations Manager</u> <u>10/18/12</u> <div style="display: flex; justify-content: space-around;"> Name Title Date </div> Interviewed <input checked="" type="checkbox"/> at Site <input type="checkbox"/> at office <input type="checkbox"/> by phone Phone no. _____ Problems, suggestions; <input type="checkbox"/> Report attached _____ _____	
2. O&M staff _____ <div style="display: flex; justify-content: space-around;"> Name Title Date </div> Interviewed <input type="checkbox"/> at Site <input type="checkbox"/> at office <input type="checkbox"/> by phone Phone no. _____ Problems, suggestions; <input type="checkbox"/> Report attached _____ _____	

3. **Local regulatory authorities and response agencies** (i.e., State and Tribal offices, emergency response office, police department, office of public health or environmental health, zoning office, recorder of deeds, or other city and county offices, etc.) Fill in all that apply.

Agency: _____

Contact: _____

Name Title Date Phone no.

Problems; suggestions; Report attached _____

Agency _____

Contact _____

Name Title Date Phone no.

Problems; suggestions; Report attached _____

Agency _____

Contact _____

Name Title Date Phone no.

Problems; suggestions; Report attached _____

Agency _____

Contact _____

Name Title Date Phone no.

Problems; suggestions; Report attached _____

4. Other interviews (optional) <input type="checkbox"/> Report attached.

III. ON-SITE DOCUMENTS & RECORDS VERIFIED (Check all that apply)

1. O&M Documents

- O&M manual Readily available Up to date N/A
- As-built drawings Readily available Up to date N/A
- Maintenance logs Readily available Up to date N/A

Remarks _____

2. Site-Specific Health and Safety Plan Readily available Up to date N/A

- Contingency plan/emergency response plan Readily available Up to date N/A

Remarks _____

3. O&M and OSHA Training Records Readily available Up to date N/A

Remarks _____

4. Permits and Service Agreements

- Air discharge permit Readily available Up to date N/A
- Effluent discharge Readily available Up to date N/A
- Waste disposal, POTW Readily available Up to date N/A
- Other permits _____ Readily available Up to date N/A

Remarks _____

5. Gas Generation Records Readily available Up to date N/A

Remarks _____

6. Settlement Monument Records Readily available Up to date N/A

Remarks _____

7.	Groundwater Monitoring Records	<input type="checkbox"/> Readily available	<input type="checkbox"/> Up to date	<input type="checkbox"/> N/A
Remarks _____ _____				
8.	Leachate Extraction Records	<input type="checkbox"/> Readily available	<input type="checkbox"/> Up to date	<input type="checkbox"/> N/A
Remarks _____ _____				
9.	Discharge Compliance Records			
<input type="checkbox"/> Air		<input type="checkbox"/> Readily available	<input type="checkbox"/> Up to date	<input type="checkbox"/> N/A
<input type="checkbox"/> Water (effluent)		<input type="checkbox"/> Readily available	<input type="checkbox"/> Up to date	<input type="checkbox"/> N/A
Remarks _____ _____				
10.	Daily Access/Security Logs	<input type="checkbox"/> Readily available	<input type="checkbox"/> Up to date	<input type="checkbox"/> N/A
Remarks _____ _____				

3. **Unanticipated or Unusually High O&M Costs During Review Period**

Describe costs and reasons: _____

V. ACCESS AND INSTITUTIONAL CONTROLS Applicable N/A

A. Fencing

1. **Fencing damaged** Location shown on Site map Gates secured N/A

Remarks None _____

B. Other Access Restrictions

1. **Signs and other security measures** Location shown on Site map N/A

Remarks Informational sign observed on shed to the north of NE 78th St at sport field _____

C. Institutional Controls (ICs)

1. Implementation and enforcement

Site conditions imply ICs not properly implemented Yes No N/A

Site conditions imply ICs not being fully enforced Yes No N/A

Type of monitoring (*e.g.*, self-reporting, drive by) _____

Frequency _____

Responsible party/agency _____

Contact _____

Name

Title

Date Phone no.

Reporting is up-to-date Yes No N/A

Reports are verified by the lead agency Yes No N/A

Specific requirements in deed or decision documents have been met Yes No N/A

Violations have been reported Yes No N/A

Other problems or suggestions: Report attached

2. Adequacy ICs are adequate ICs are inadequate N/A

Remarks _____

D. General	
1.	Vandalism/trespassing <input type="checkbox"/> Location shown on Site map <input checked="" type="checkbox"/> No vandalism evident Remarks _____ _____
2.	Land use changes on Site <input checked="" type="checkbox"/> N/A Remarks _____ _____
3.	Land use changes off-site <input type="checkbox"/> N/A Remarks <u>Sports fields constructed on County and Church of God property</u> _____
VI. GENERAL SITE CONDITIONS	
A. Roads <input checked="" type="checkbox"/> Applicable <input type="checkbox"/> N/A	
1.	Roads damaged <input type="checkbox"/> Location shown on Site map <input checked="" type="checkbox"/> Roads adequate <input type="checkbox"/> N/A Remarks _____ _____
B. Other Site Conditions	
Remarks _____ _____ _____ _____ _____	

VII. LANDFILL COVERS <input type="checkbox"/> Applicable <input checked="" type="checkbox"/> N/A			
A. Landfill Surface			
1.	Settlement (Low spots)	<input type="checkbox"/> Location shown on Site map	<input type="checkbox"/> Settlement not evident
Areal extent _____ Depth _____ Remarks _____ _____			
2.	Cracks	<input type="checkbox"/> Location shown on Site map	<input type="checkbox"/> Cracking not evident
Lengths _____ Widths _____ Depths _____ Remarks _____ _____			
3.	Erosion	<input type="checkbox"/> Location shown on Site map	<input type="checkbox"/> Erosion not evident
Areal extent _____ Depth _____ Remarks _____ _____			
4.	Holes	<input type="checkbox"/> Location shown on Site map	<input type="checkbox"/> Holes not evident
Areal extent _____ Depth _____ Remarks _____ _____			
5.	Vegetative Cover	<input type="checkbox"/> Grass	<input type="checkbox"/> Cover properly established <input type="checkbox"/> No signs of stress
<input type="checkbox"/> Trees/Shrubs (indicate size and locations on a diagram) Remarks _____ _____			
6.	Alternative Cover (armored rock, concrete, etc.)	<input type="checkbox"/> N/A	
Remarks _____ _____			

7.	Bulges	<input type="checkbox"/> Location shown on Site map	<input type="checkbox"/> Bulges not evident
Areal extent_____ Height_____			
Remarks_____			

8.	Wet Areas/Water Damage	<input type="checkbox"/> Wet areas/water damage not evident	
<input type="checkbox"/> Wet areas <input type="checkbox"/> Location shown on Site map Areal extent_____			
<input type="checkbox"/> Ponding <input type="checkbox"/> Location shown on Site map Areal extent_____			
<input type="checkbox"/> Seeps <input type="checkbox"/> Location shown on Site map Areal extent_____			
<input type="checkbox"/> Soft subgrade <input type="checkbox"/> Location shown on Site map Areal extent_____			
Remarks_____			

9.	Slope Instability	<input type="checkbox"/> Slides	<input type="checkbox"/> Location shown on Site map <input type="checkbox"/> No evidence of slope instability
Areal extent_____			
Remarks_____			

B. Benches <input type="checkbox"/> Applicable <input type="checkbox"/> N/A			
(Horizontally constructed mounds of earth placed across a steep landfill side slope to interrupt the slope in order to slow down the velocity of surface runoff and intercept and convey the runoff to a lined channel.)			
1.	Flows Bypass Bench	<input type="checkbox"/> Location shown on Site map	<input type="checkbox"/> N/A or okay
Remarks_____			

2.	Bench Breached	<input type="checkbox"/> Location shown on Site map	<input type="checkbox"/> N/A or okay
Remarks_____			

3.	Bench Overtopped	<input type="checkbox"/> Location shown on Site map	<input type="checkbox"/> N/A or okay
Remarks _____ _____			
C. Letdown Channels <input type="checkbox"/> Applicable <input type="checkbox"/> N/A			
(Channel lined with erosion control mats, riprap, grout bags, or gabions that descend down the steep side slope of the cover and will allow the runoff water collected by the benches to move off of the landfill cover without creating erosion gullies.)			
1.	Settlement	<input type="checkbox"/> Location shown on Site map	<input type="checkbox"/> No evidence of settlement
Areal extent _____ Depth _____			
Remarks _____ _____			
2.	Material Degradation	<input type="checkbox"/> Location shown on Site map	<input type="checkbox"/> No evidence of degradation
Material type _____ Areal extent _____			
Remarks _____ _____			
3.	Erosion	<input type="checkbox"/> Location shown on Site map	<input type="checkbox"/> No evidence of erosion
Areal extent _____ Depth _____			
Remarks _____ _____			

4. **Undercutting** Location shown on Site map No evidence of undercutting

Areal extent _____ Depth _____

Remarks _____

5. **Obstructions** Type _____ No obstructions

Location shown on Site map Areal extent _____

Size _____

Remarks _____

6. **Excessive Vegetative Growth** Type _____

No evidence of excessive growth

Vegetation in channels does not obstruct flow

Location shown on Site map Areal extent _____

Remarks _____

D. Cover Penetrations Applicable N/A

1. **Gas Vents** Active G Passive

Properly secured/locked Functioning Routinely sampled Good condition

Evidence of leakage at penetration Needs Maintenance

N/A

Remarks _____

2. **Gas Monitoring Probes**

Properly secured/locked Functioning Routinely sampled Good condition

Evidence of leakage at penetration Needs Maintenance N/A

Remarks _____

3. **Monitoring Wells** (within surface area of landfill)

Properly secured/locked Functioning Routinely sampled Good condition

Evidence of leakage at penetration Needs Maintenance N/A

Remarks _____

4. **Leachate Extraction Wells**

Properly secured/locked Functioning Routinely sampled Good condition

Evidence of leakage at penetration Needs Maintenance N/A

Remarks _____

5. **Settlement Monuments** Located Routinely surveyed N/A

Remarks _____

E. Gas Collection and Treatment		<input type="checkbox"/> Applicable	<input type="checkbox"/> N/A
1.	Gas Treatment Facilities	<input type="checkbox"/> Flaring <input type="checkbox"/> Thermal destruction <input type="checkbox"/> Collection for reuse <input type="checkbox"/> Good condition <input type="checkbox"/> Needs Maintenance Remarks _____ _____	
2.	Gas Collection Wells, Manifolds and Piping	<input type="checkbox"/> Good condition <input type="checkbox"/> Needs Maintenance Remarks _____ _____	
3.	Gas Monitoring Facilities (<i>e.g.</i> , gas monitoring of adjacent homes or buildings)	<input type="checkbox"/> Good condition <input type="checkbox"/> Needs Maintenance <input type="checkbox"/> N/A Remarks _____ _____	
F. Cover Drainage Layer		<input type="checkbox"/> Applicable	<input type="checkbox"/> N/A
1.	Outlet Pipes Inspected	<input type="checkbox"/> Functioning	<input type="checkbox"/> N/A
	Remarks _____ _____		
2.	Outlet Rock Inspected	<input type="checkbox"/> Functioning	<input type="checkbox"/> N/A
	Remarks _____ _____		
G. Detention/Sedimentation Ponds		<input type="checkbox"/> Applicable	<input type="checkbox"/> N/A
1.	Siltation	Areal extent _____	Depth _____
	<input type="checkbox"/> Siltation not evident		<input type="checkbox"/> N/A
	Remarks _____ _____		

2.	Erosion	Areal extent_____ Depth_____	
	<input type="checkbox"/> Erosion not evident		
	Remarks_____		
3.	Outlet Works	<input type="checkbox"/> Functioning <input type="checkbox"/> N/A	
	Remarks_____		
4.	Dam	<input type="checkbox"/> Functioning <input type="checkbox"/> N/A	
	Remarks_____		
H. Retaining Walls		<input type="checkbox"/> Applicable <input type="checkbox"/> N/A	
1.	Deformations	<input type="checkbox"/> Location shown on Site map <input type="checkbox"/> Deformation not evident	
	Horizontal displacement_____	Vertical displacement_____	
	Rotational displacement_____		
	Remarks_____		
2.	Degradation	<input type="checkbox"/> Location shown on Site map <input type="checkbox"/> Degradation not evident	
	Remarks_____		
I. Perimeter Ditches/Off-Site Discharge		<input type="checkbox"/> Applicable <input type="checkbox"/> N/A	
1.	Siltation	<input type="checkbox"/> Location shown on Site map <input type="checkbox"/> Siltation not evident	
	Areal extent_____	Depth_____	
	Remarks_____		

2.	Vegetative Growth	<input type="checkbox"/> Location shown on Site map	<input type="checkbox"/> N/A
	<input type="checkbox"/> Vegetation does not impede flow		
	Areal extent _____ Type _____		
	Remarks _____ _____		
3.	Erosion	<input type="checkbox"/> Location shown on Site map	<input type="checkbox"/> Erosion not evident
	Areal extent _____ Depth _____		
	Remarks _____ _____		
4.	Discharge Structure	<input type="checkbox"/> Functioning	<input type="checkbox"/> N/A
	Remarks _____ _____		
VIII. VERTICAL BARRIER WALLS <input type="checkbox"/> Applicable <input checked="" type="checkbox"/> N/A			
1.	Settlement	<input type="checkbox"/> Location shown on Site map	<input type="checkbox"/> Settlement not evident
	Areal extent _____ Depth _____		
	Remarks _____ _____		
2.	Performance Monitoring Type of monitoring _____		
	<input type="checkbox"/> Performance not monitored		
	Frequency _____	<input type="checkbox"/> Evidence of breaching	
	Head differential _____		
	Remarks _____ _____		

IX. GROUNDWATER/SURFACE WATER REMEDIES <input checked="" type="checkbox"/> Applicable <input type="checkbox"/> N/A	
A. Groundwater Extraction Wells, Pumps, and Pipelines <input type="checkbox"/> Applicable <input type="checkbox"/> N/A	
1.	Pumps, Wellhead Plumbing, and Electrical <input checked="" type="checkbox"/> Good condition <input type="checkbox"/> All required wells properly operating G Needs Maintenance G N/A Remarks _____ _____ _____
2.	Extraction System Pipelines, Valves, Valve Boxes, and Other Appurtenances <input checked="" type="checkbox"/> Good condition <input type="checkbox"/> Needs Maintenance Remarks _____ _____
3.	Spare Parts and Equipment <input type="checkbox"/> Readily available <input type="checkbox"/> Good condition <input type="checkbox"/> Requires upgrade <input type="checkbox"/> Needs to be provided Remarks _____ _____
B. Surface Water Collection Structures, Pumps, and Pipelines <input type="checkbox"/> Applicable <input checked="" type="checkbox"/> N/A	
1.	Collection Structures, Pumps, and Electrical <input type="checkbox"/> Good condition <input type="checkbox"/> Needs Maintenance Remarks _____ _____
2.	Surface Water Collection System Pipelines, Valves, Valve Boxes, and Other Appurtenances <input type="checkbox"/> Good condition <input type="checkbox"/> Needs Maintenance Remarks _____ _____
3.	Spare Parts and Equipment <input type="checkbox"/> Readily available <input type="checkbox"/> Good condition <input type="checkbox"/> Requires upgrade <input type="checkbox"/> Needs to be provided Remarks _____ _____

C. Treatment System	<input checked="" type="checkbox"/> Applicable	<input type="checkbox"/> N/A
1. Treatment Train (Check components that apply)		
<input checked="" type="checkbox"/> Metals removal	<input type="checkbox"/> Oil/water separation	<input type="checkbox"/> Bioremediation
<input checked="" type="checkbox"/> Air stripping	<input checked="" type="checkbox"/> Carbon adsorbers	
<input type="checkbox"/> Filters _____		
<input type="checkbox"/> Additive (<i>e.g.</i> , chelation agent, flocculent) _____		
<input type="checkbox"/> Others _____		
<input checked="" type="checkbox"/> Good condition	<input type="checkbox"/> Needs Maintenance	
<input checked="" type="checkbox"/> Sampling ports properly marked and functional		
<input type="checkbox"/> Sampling/maintenance log displayed and up to date		
<input checked="" type="checkbox"/> Equipment properly identified		
<input type="checkbox"/> Quantity of groundwater treated annually _____		
<input type="checkbox"/> Quantity of surface water treated annually _____		
Remarks _____		

2. Electrical Enclosures and Panels (properly rated and functional)		
<input type="checkbox"/> N/A	<input checked="" type="checkbox"/> Good condition	<input type="checkbox"/> Needs Maintenance
Remarks _____		

3. Tanks, Vaults, Storage Vessels		
<input type="checkbox"/> N/A	<input checked="" type="checkbox"/> Good condition	<input checked="" type="checkbox"/> Proper secondary containment
		<input type="checkbox"/> Needs Maintenance
Remarks _____		

4. Discharge Structure and Appurtenances		
<input type="checkbox"/> N/A	<input checked="" type="checkbox"/> Good condition	<input type="checkbox"/> Needs Maintenance
Remarks _____		

5.	Treatment Building(s)	<input type="checkbox"/> N/A <input checked="" type="checkbox"/> Good condition (esp. roof and doorways) <input type="checkbox"/> Needs repair <input type="checkbox"/> Chemicals and equipment properly stored Remarks _____ _____
6.	Monitoring Wells (extraction and treatment remedy)	<input checked="" type="checkbox"/> Properly secured/locked <input checked="" type="checkbox"/> Functioning <input type="checkbox"/> Routinely sampled <input type="checkbox"/> Good condition <input type="checkbox"/> All required wells located <input type="checkbox"/> Needs Maintenance <input type="checkbox"/> N/A Remarks _____ _____
D. Monitoring Data		
1.	Monitoring Data	<input checked="" type="checkbox"/> Is routinely submitted on time <input type="checkbox"/> Is of acceptable quality
2.	Monitoring data suggests:	<input checked="" type="checkbox"/> Groundwater plume is effectively contained <input checked="" type="checkbox"/> Contaminant concentrations are declining
D. Monitored Natural Attenuation		
1.	Monitoring Wells (natural attenuation remedy)	<input type="checkbox"/> Properly secured/locked <input type="checkbox"/> Functioning <input type="checkbox"/> Routinely sampled <input type="checkbox"/> Good condition <input type="checkbox"/> All required wells located <input type="checkbox"/> Needs Maintenance <input type="checkbox"/> N/A Remarks _____ _____
X. OTHER REMEDIES		
If there are remedies applied at the Site which are not covered above, attach an inspection sheet describing the physical nature and condition of any facility associated with the remedy. An example would be soil vapor extraction.		

XI. OVERALL OBSERVATIONS

A. Implementation of the Remedy

Describe issues and observations relating to whether the remedy is effective and functioning as designed. Begin with a brief statement of what the remedy is to accomplish (i.e., to contain contaminant plume, minimize infiltration and gas emission, etc.).

The purpose of the remedy is containment and reduction of the plume. The remedy appears to be effective as the plume is shrinking and down-gradient wells are being shutdown. ZVI/C injections appear to be successful in treating remaining residual contamination at the toe of plume.

B. Adequacy of O&M

Describe issues and observations related to the implementation and scope of O&M procedures. In particular, discuss their relationship to the current and long-term protectiveness of the remedy.

The pump and treat system appears to be in good condition. Down-gradient wells are being turned off as the plume shrinks. Extraction wells have been modified (e.g. casing raised) to accommodate development at the sports fields. The SVE system was turned off. IWS wells are undergoing rebound testing.

Appendix C: Site Inspection Photographs

[This page is intentionally blank]

Site Inspection Photographs



Photo 1. Chromium treatment tanks.



Photo 2. Air stripper.



Photo 3. Liquid carbon treatment drum and secondary containment (catch basin effluent routed through VOC treatment stream).



Photo 4. Extraction well PB-1B.



Photo 5. In-well stripping well IWS-6.



Photo 6. Blowers for IWS and SVE system.



Photo 7. Infiltration gallery vault.



Photo 8. New Church of God sport field (east of church/school).



Photo 9. Informational sign on shed near sports fields.



Photo 10. Toe of plume area.

[This page is intentionally blank]

Appendix D: Interview Transcripts

Interview Transcripts

Community

Five-Year Review Interview Record			
Site: Boomsnub/Airco Superfund Site	EPA ID No: WAD009624453		
Interview Type:	Telephone	Visit	X Other: Mail
Location of Visit:	Vancouver Community Library		
Date:	10/18/2012	Time:	1500
Interviewer: Claire Hong	Title: RPM	Organization: EPA	
Individual Contacted			
Name: Jack Davis Naomi Davis	Title: citizen	Organization:	
Telephone:	Address:		
Summary of Conversation			
<p>1) What is your overall impression of the project?</p> <p>Mr. and Mrs. Davis stated that they would have liked the questions before the interview to think about their responses. Mr. and Mrs. Davis indicated that they only learned about the Superfund Site in 2009 when the sports complex was being considered. They did not know about the Superfund Site before moving to their current residence, which is near the site; it was a total shock.</p>			
<p>2) What affects have site operations (cleanup) had on the surrounding community?</p> <p>Mr. and Mrs. Davis stated that EPA did not know enough about the northern plume to allow for the ballfields to be constructed, and that it was a disgrace that the ballfields were allowed to be built anyway. Mr. and Mrs. Davis described it as an experiment on children at ballfields, stating that this is the only active Superfund site where ballfields were constructed.</p>			
<p>3) Are you aware of any community concerns regarding the site or it's operation? If so, please summarize your concerns.</p> <p>Mr. Davis noted the amount of leukemia observed near Superfund Sites is terrible. He stated that some people in his neighborhood have gotten sick (not leukemia) and hinted that their illnesses might be related to the contamination. Finally, Mr. Davis worried that comingling of the northern plume with the plume attributed to the Boomsnub/Airco Superfund site could lead to a long court battle over the responsible party for the northern plume, which could delay cleanup activities.</p>			
<p>4) Do you feel well informed about the site's activities and progress?</p> <p>Mr. and Mrs. Davis did not feel well informed about the site's activities and progress, particularly regarding the Northern Plume. They stated that there had been no word from EPA since a May 2011 report describing the location of the Northern Plume, and that they want to know where it is in relation to the ballfields.</p>			
<p>5) Do you have any comments, suggestions, or recommendations regarding the site's management or operation?</p> <p>Mr. and Mrs. Davis felt that EPA was remiss for doing nothing to clean up the northern plume after contamination was discovered, and indicated that they felt cleanup should have been the appropriate response immediately after the plume was discovered. They also noted that, through Mr. Davis' insistence, EPA put up a sign indicating the presence of the Superfund Site. However, Mr. and Mrs. Davis felt that the sign was too small and out of the way, and suggested that a legitimate sign be posted near the ballfields where parents and kids can see it. They felt that parents and kids should be notified about playing on a Superfund Site. Mr. and Mrs. Davis also raised concerns about a tremendous amount of flooding that occurred on the fields to the east of the Church, stating that they don't know what effect that might have had on contamination below the fields.</p>			

Five-Year Review Interview Record	
Site: Boomsnub/Airco Superfund Site	EPA ID No: WAD009624453
Interview Type: Telephone Visit X Other: Mail	
Location of Visit: Vancouver Community Library	
Date: 10/18/2012	Time: 1600
Interviewer: Claire Hong	Title: RPM Organization: EPA
Individual Contacted	
Name: Steve Olson	Title: Facilities Manager Organization: First Church of God
Telephone: (360) 574-1611	Address: 3300 NE 78th St Vancouver, WA 98665
Summary of Conversation	
<p>1) What is your overall impression of the project? Mr. Olson feels that efforts related to the site cleanup have been done well, and described them as "heroic." He felt that it was a bad situation, but that the First Church of God has been treated well. He felt very fortunate that the contamination and site operations have not negatively impacted their development.</p>	
<p>2) What affects have site operations (cleanup) had on the surrounding community? Mr. Olson has spoken with Rick from EA regarding site activities, and EA has been more than willing to work with the Church of God regarding the timing of site operations and activities which could otherwise create an issue due to school letting out, periods of higher traffic volume, etc.</p>	
<p>3) Are you aware of any community concerns regarding the site or it's operation? If so, please summarize your concerns. The Church has had problems from some neighbors, but that was more related to the development of the ballfield. Mr. Olson has no sense that there is larger upset in the community other than Mr. Davis and Mr. Kinney. Generally, people are comfortable with the level of information received from EPA, and comfortable with information provided by the Church.</p>	
<p>4) Do you feel well informed about the site's activities and progress? Mr. Olson felt that he has been well informed since the first flag was raised in 1995. He noted that he has typically been told by EPA when something changes.</p>	
<p>5) Do you have any comments, suggestions, or recommendations regarding the site's management or operation? Mr. Olson noted that there was still a significant amount of time until cleanup is achieved, even though it is going faster than originally planned. He also noted that he wanted some feedback that their development has not affected the monitoring network. Additionally, he stated that sufficient notice for monitoring has been given, but that there is still occasionally a car over a monitoring well when sampling is taking place.</p>	

Five-Year Review Interview Record	
Site: Boomsnub/Airco Superfund Site	EPA ID No: WAD009624453
Interview Type: Telephone Visit X Other: Mail	
Location of Visit: Vancouver Community Library	
Date: 10/18/2012	Time: 1730
Interviewer: Claire Hong	Title: RPM Organization: EPA
Individual Contacted	
Name: Doug Ballou	Title: Vice President Organization: Northeast Hazel Dell Neighborhood Association
Telephone:	Address:
Summary of Conversation	
<p>1) What is your overall impression of the project? Mr. Ballou stated that EPA has done a great of containing the contamination and cleaning up the site. Mr. Ballou was pleased with the results.</p>	
<p>2) What affects have site operations (cleanup) had on the surrounding community? Mr. Ballou stated that impacts on the community have been contained and mitigated, noting that many people in the area are unaware of the site and site operations, but this is not an issue because there is no health or safety concern. He indicated that information from EPA and EA has been posted in newsletters, especially if there has been reason to be concerned.</p>	
<p>3) Are you aware of any community concerns regarding the site or its operation? If so, please summarize your concerns. Mr. Ballou was not aware of any community concerns regading the site or its operation, other than from Mr. Davis.</p>	
<p>4) Do you feel well informed about the site's activities and progress? Mr. Ballou felt well informed about the site's activities and progress, but noted that the Neighborhood Board has an awareness, but the average citizen may not. He also stated that he felt five years is an appropriate review period.</p>	
<p>5) Do you have any comments, suggestions, or recommendations regarding the site's management or operation? Mr. Ballou did not have any additional comments, suggestions, or recommendations.</p>	

Stakeholders

Five-Year Review Interview Record			
Site: Boomsnub/Airco Superfund Site	EPA ID No: WAD009624453		
Interview Type: Telephone <input checked="" type="checkbox"/> Visit <input type="checkbox"/> Other: Mail <input type="checkbox"/>			
Location of Visit:			
Date: 1/23/2013	Time: 1030		
Interviewer: Sharon Gelinis	Title: Hydrogeologist	Organization: USACE	
Individual Contacted			
Name: Mohsen Kourehdar	Title: Site Manager	Organization: WADOE	
Telephone: 360-407-6256	Address: 300 Desmond Drive SE Lacey, WA 98503		
Summary of Conversation			
<p>1) What is your overall impression of the project (general sentiment)? Mr. Kourehdar stated that it is a big site and that a lot of work has been completed. However, there is still some work that needs to be done to meet cleanup levels.</p>			
<p>2) What is your current role and your agency's role with respect to the site? Mr. Kourehdar stated that he is the Site Manager for the State.</p>			
<p>3) Have there been routine communications or activities (for example site visits, inspections, etc.) conducted by your office regarding the site? If so, please give purpose and results. Mr. Kourehdar stated that the State coordinates site visits with EPA.</p>			
<p>4) Have there been any complaints, violations, or other incidents related to the site requiring a response by your office? If so, please give details of the events and results of the responses. Mr. Kourehdar stated that Mr. Davis called him several times with concerns about toxics and the ballfield and pipes at the pump houses.</p>			
<p>5) What effects have site operations (cleanup) had on the surrounding community? None.</p>			
<p>6) Are you aware of any community concerns regarding the site or its operation? No.</p>			

Kourehdar Interview cont.

7) Do you feel well informed about the site's activities and progress?

Mr. Kourehdar stated that is feels well informed about the site. He recieves and reads all of the reports, although he does not have the time to provide comments.

8) Are you aware of any changes in State/County/Local laws and regulations that may impact the protectiveness of the site?

No.

9) Do you have any comments, suggestions, or recommendations regarding the site's management, operation, or any other aspects of the site?

No. Mr. Kourehdar stated that EPA and the consultant, EA, are doing a good job.

10) 10. What are the annual operating costs for your organization's involvement for the site?

Mr. Kourehdar stated that EPA no longer pays for Ecology's time.

Five-Year Review Interview Record	
Site: Boomsnub/Airco Superfund Site	EPA ID No: WAD009624453
Interview Type: Telephone <input checked="" type="checkbox"/> Visit <input type="checkbox"/> Other: Mail <input type="checkbox"/>	
Location of Visit:	
Date: 2/15/2013	Time: 1100
Interviewer: Sharon Gelinis	Title: Hydrogeologist Organization: USACE
Individual Contacted	
Name: Steve Prather	Title: Water Quality Resource Manager Organization: Clark County Public Utilities
Telephone: 360-992-8023	Address: 1200 Fort Vancouver Way Vancouver, WA 98663
Summary of Conversation	
<p>1) What is your overall impression of the project (general sentiment)? Mr. Prather stated that as a public water supplier he still has concerns that not all contaminants are being captured since they are relying solely on the clay aquitard preventing downward migration into the Troutdale aquifer, which is used for drinking water. He is also concerned about the levels of residual contamination and if it will find a pathway through the aquitard to the Troutdale aquifer.</p> <p>2) What is your current role and your agency's role with respect to the site? Mr. Prather stated that he is the Water Quality Resource Manager for the Clark County Public Utilities.</p> <p>3) Have there been routine communications or activities (for example site visits, inspections, etc.) conducted by your office regarding the site? If so, please give purpose and results. Mr. Prather has not had contact with EPA in several years. He keeps in communication with EA Engineering and reviews the monitoring reports. Mr. Prather also stated that the County and Clark Public Utilities have plume map on GIS. Any new construction in this area would be hooked up to public water. However, there is no County ordinance that would prevent a property owner from installing a well.</p> <p>4) Have there been any complaints, violations, or other incidents related to the site requiring a response by your office? If so, please give details of the events and results of the responses. No</p> <p>5) What effects have site operations (cleanup) had on the surrounding community? The annual Consumer Confidence Report typically generates several phone calls from citizens concerned about the contamination. Mr. Prather's response consists of informing them about the Superfund process and the site's progress.</p> <p>6) Are you aware of any community concerns regarding the site or its operation? Mr. Prather stated that there were some concerns over the completion of the sports field. There was also a property owner that wanted to place fill on his property that would impact some of the monitoring wells at the site.</p>	

Prather Interview cont.

7) Do you feel well informed about the site's activities and progress?

Mr. Prather stated that he is kept informed about the site through EA Engineering.

8) Are you aware of any changes in State/County/Local laws and regulations that may impact the protectiveness of the site?

Mr. Prather has some concern about the potential for a hexavalent chromium MCL. If water purveyors will be required to meet the lower concentrations of a hexavalent chromium standard, he would like to see lower detection limits for chromium and hexavalent chromium testing at the Boomsnub/Airco site. He was also concerned about how a new hexavalent chromium MCL would impact the current remedy.

9) Do you have any comments, suggestions, or recommendations regarding the site's management, operation, or any other aspects of the site?

No. Mr. Prather stated that his primary concern is regarding the potential for a lower hexavalent chromium and that VOCs continue to be monitored and treated.

Appendix E: Data Summary

[This page is intentionally blank]

Data Summary

Concentration Graphs

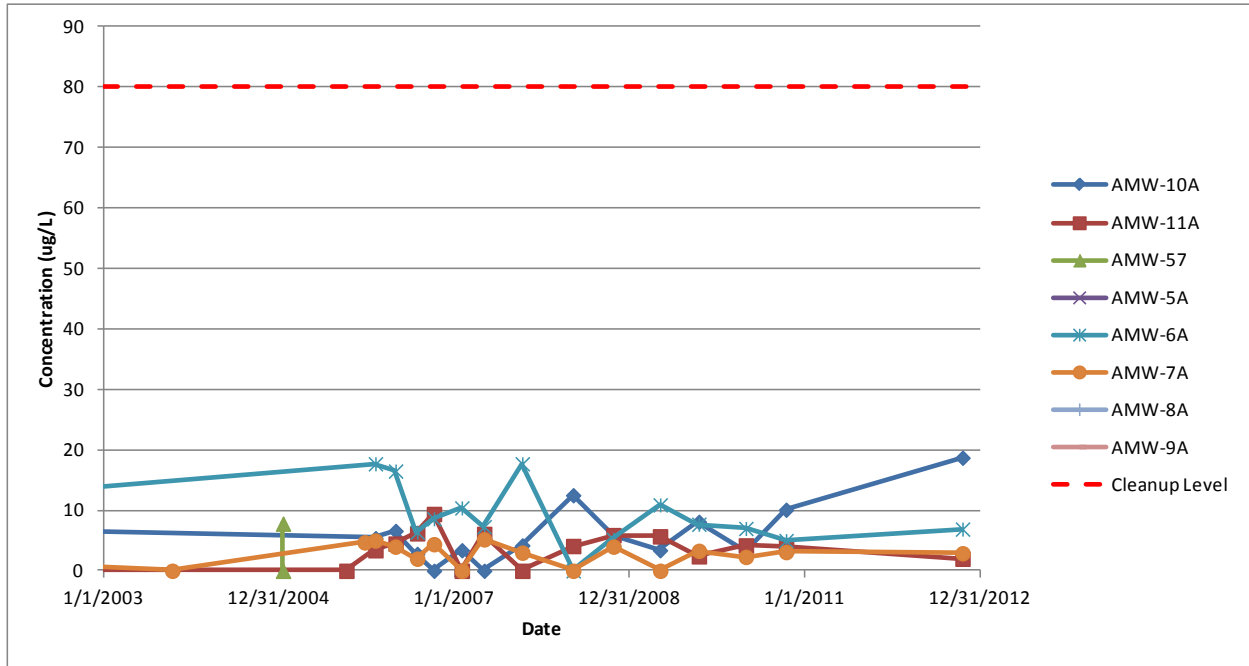

Figure E1. Chromium Concentrations in Upgradient Wells

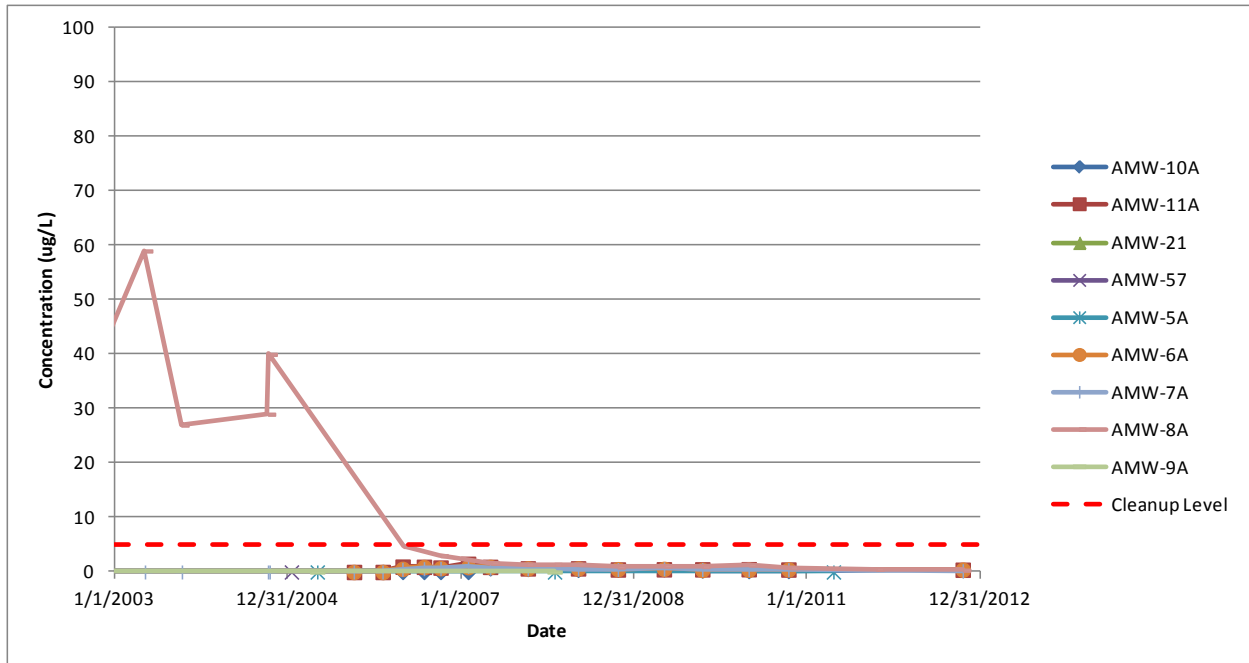

Figure E2. TCE Concentrations in Upgradient Wells

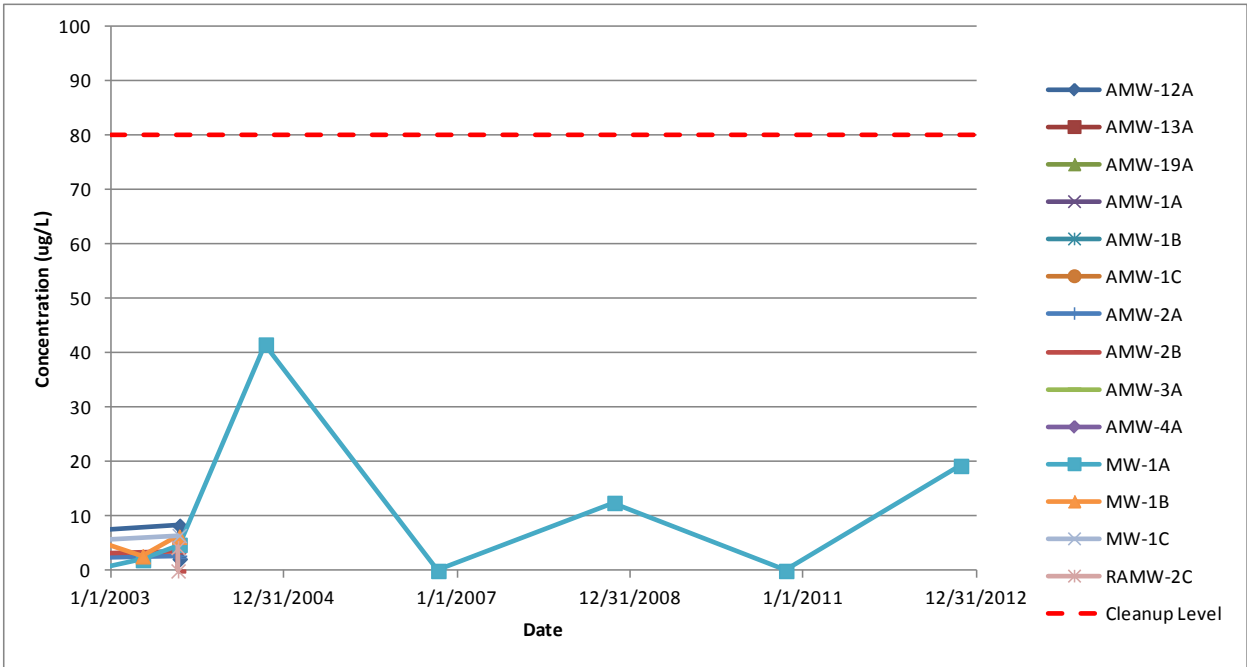

Figure E3. Chromium Concentrations in TCE Source Wells

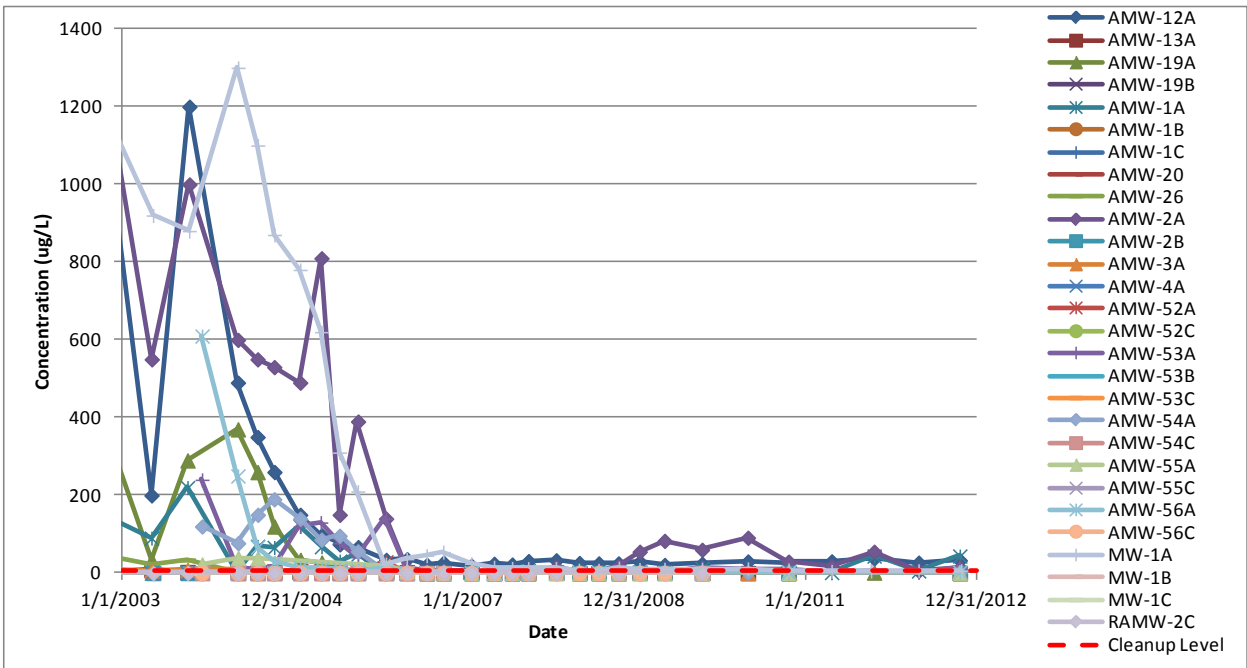

Figure E4. TCE Concentrations in TCE Source Wells

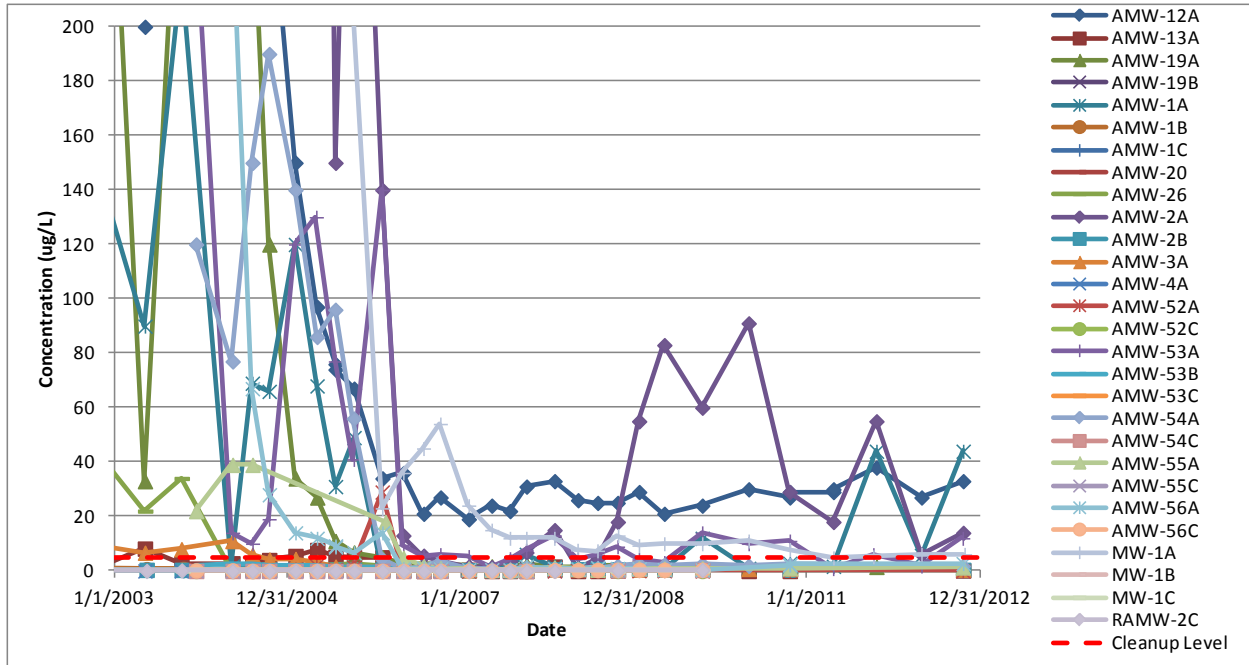

Figure E5. TCE Concentrations in TCE Source Wells (Vertical Axis Scale Modified)

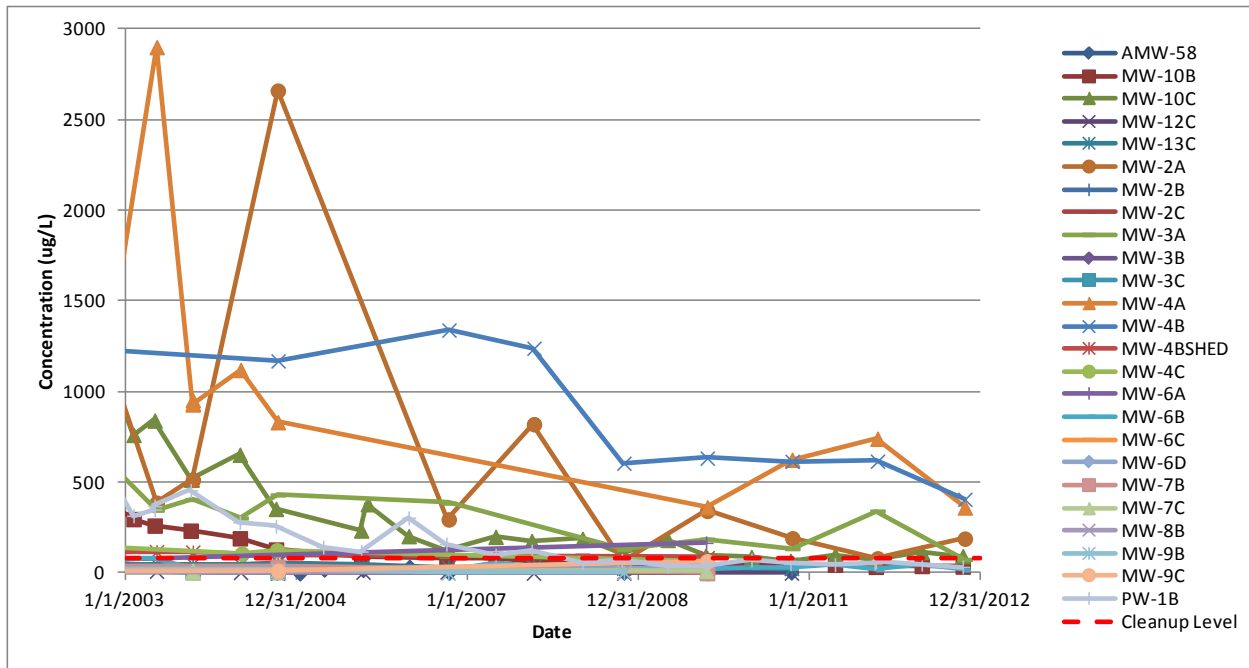

Figure E6. Chromium Concentrations in Proximal Wells

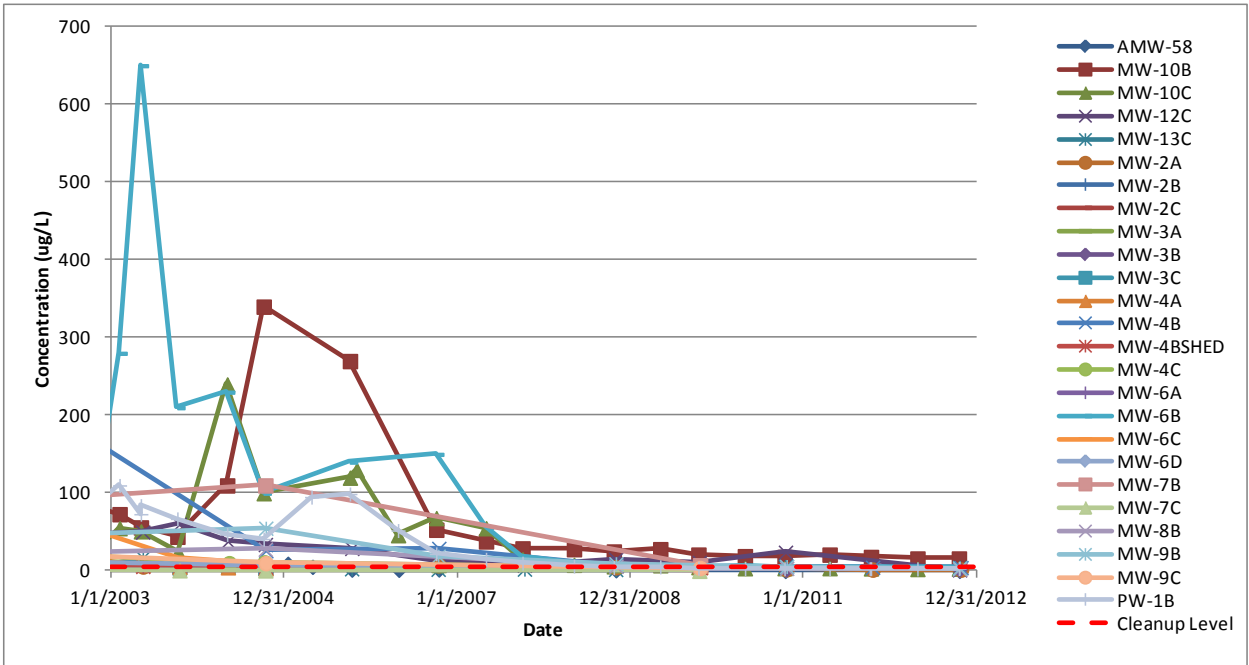

Figure E7. TCE Concentrations in Proximal Wells

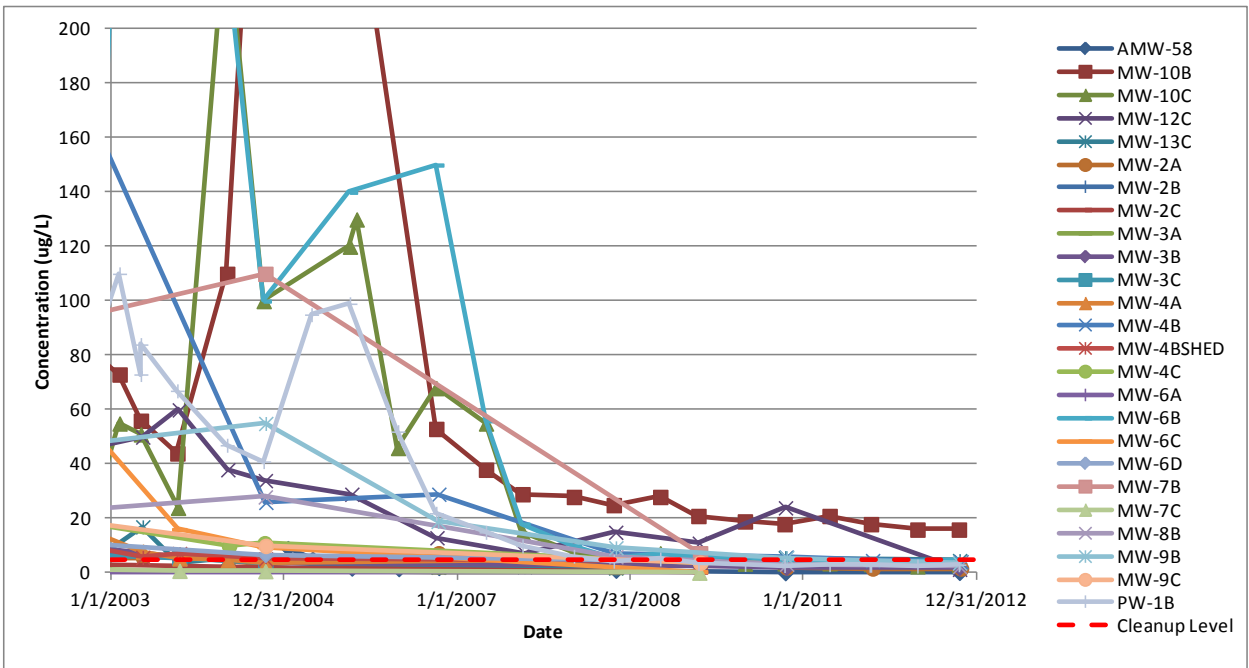

Figure E8. TCE Concentrations in Proximal Wells (Vertical Axis Scale Modified)

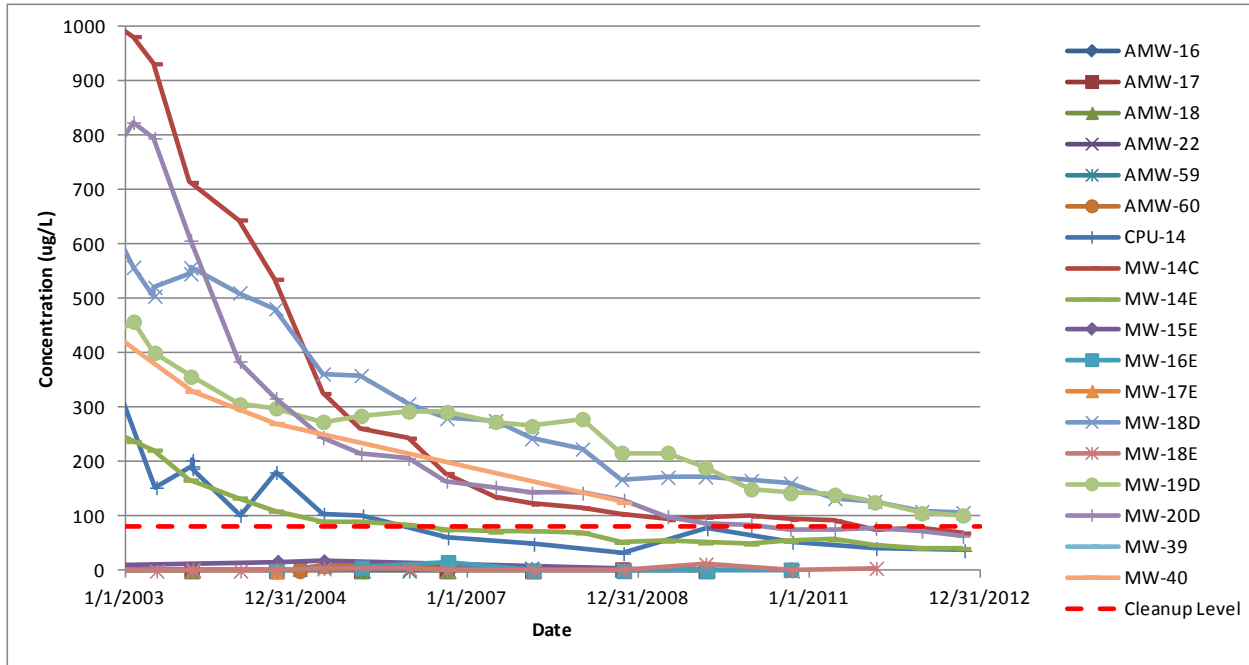

Figure E9. Chromium Concentrations in Intermediate Wells

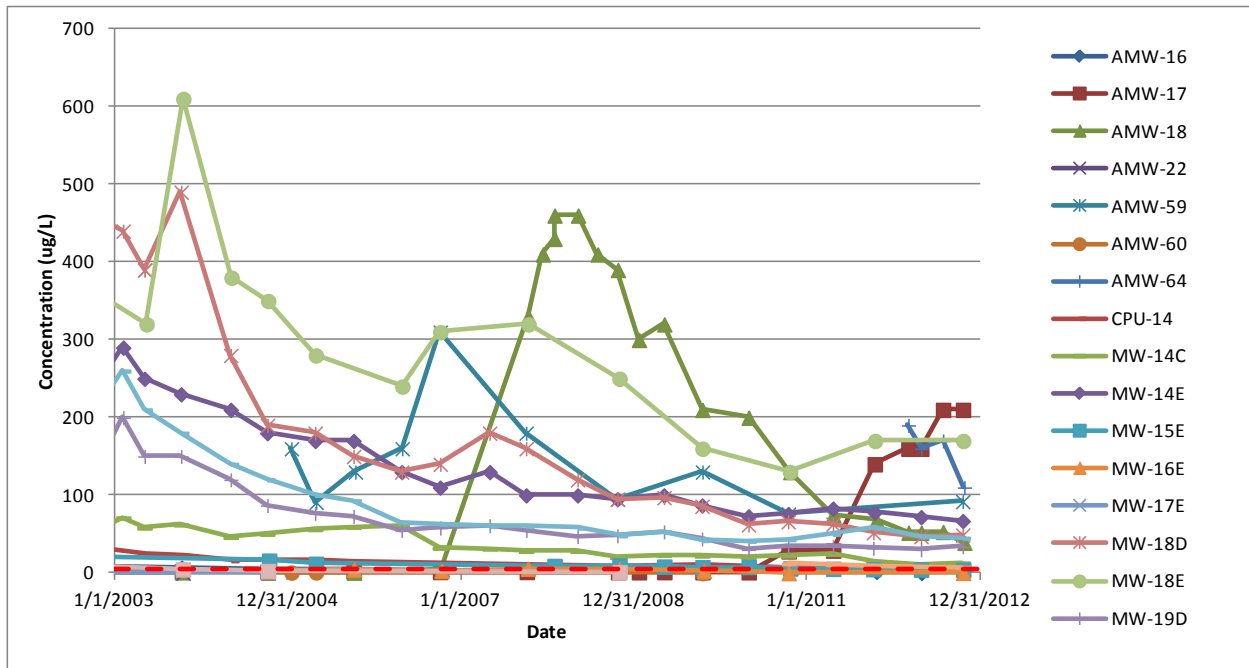

Figure E10. TCE Concentrations in Intermediate Wells

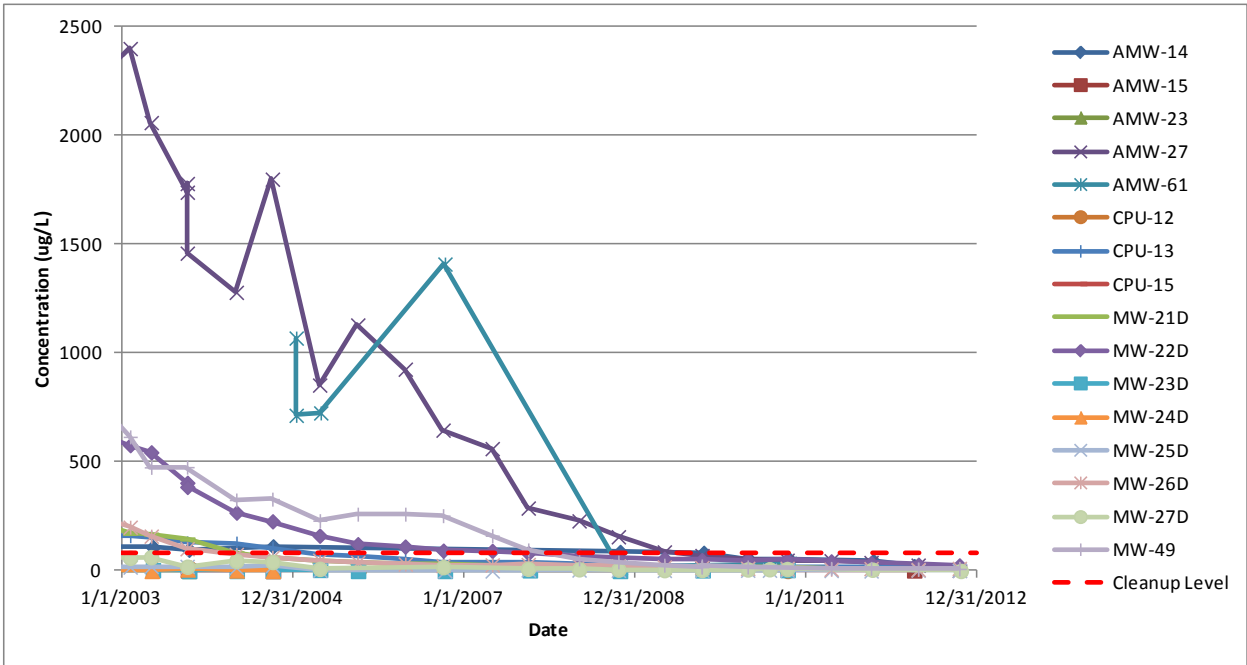

Figure E11. Chromium Concentrations in Church of God Wells

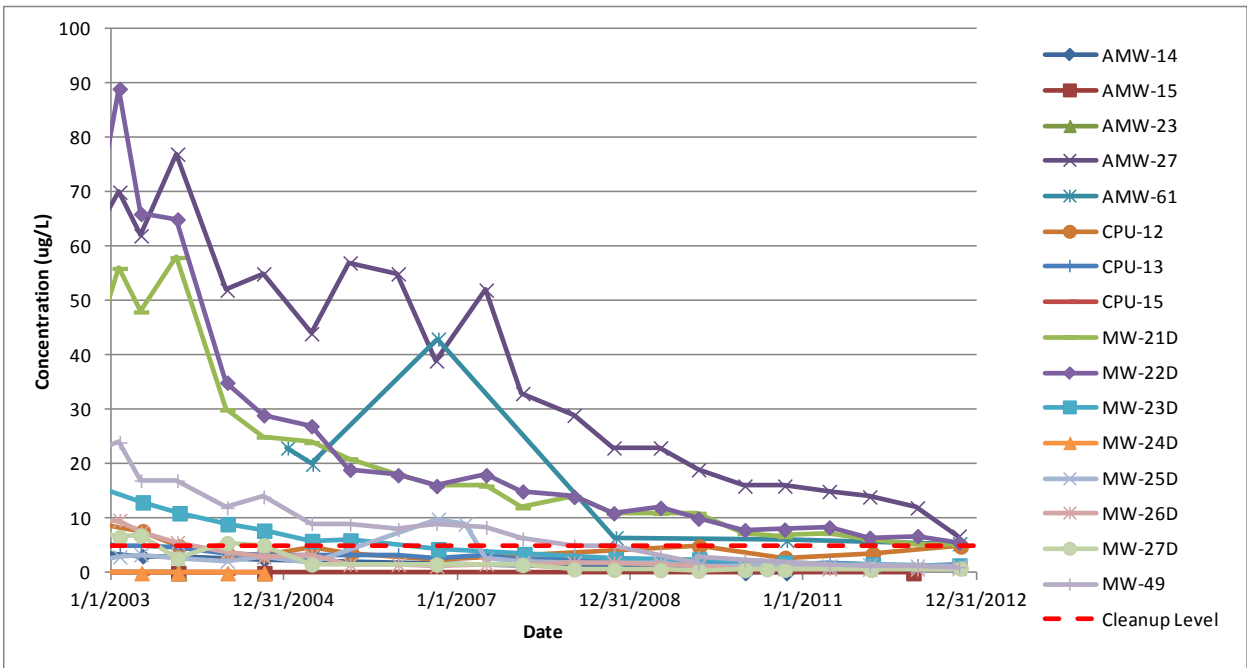

Figure E12. TCE Concentrations in Church of God Wells

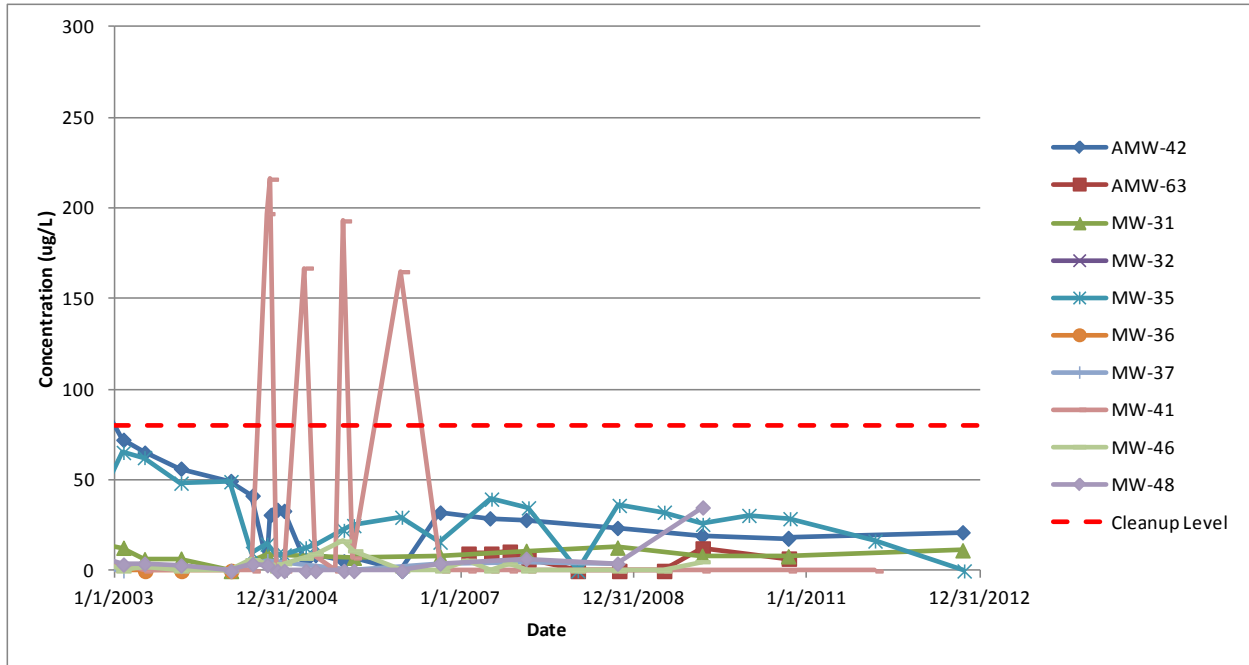

Figure E13. Chromium Concentrations in Other Toe Wells

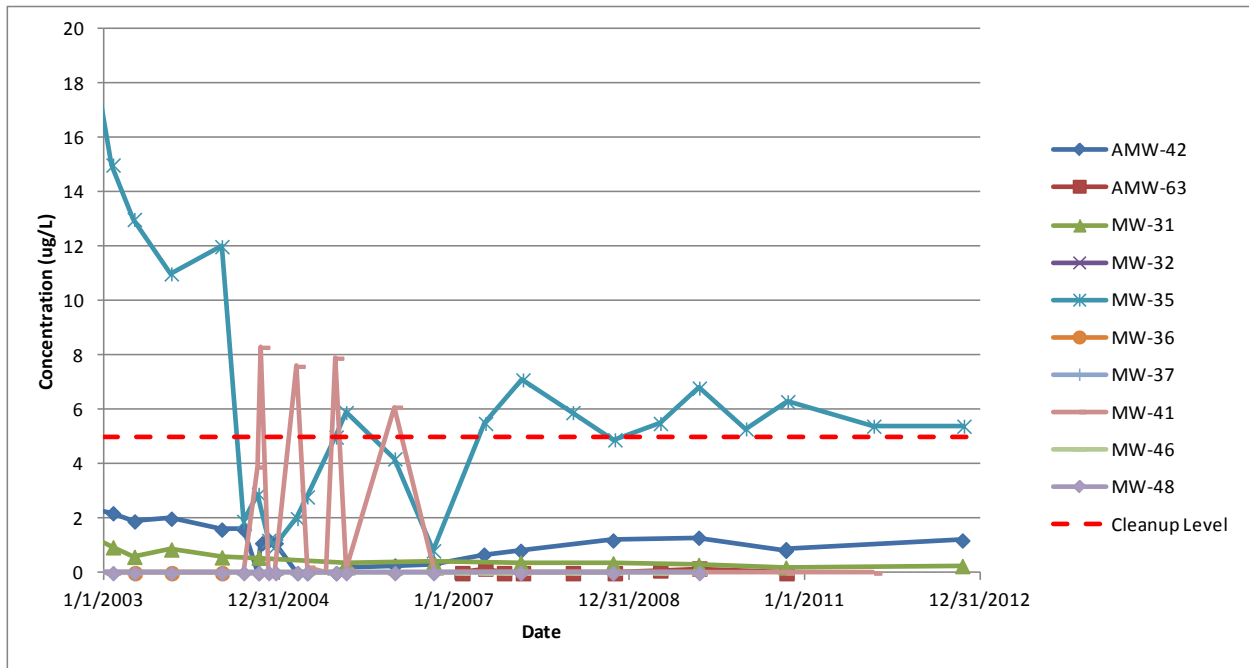

Figure E14. TCE Concentrations in Other Toe Wells

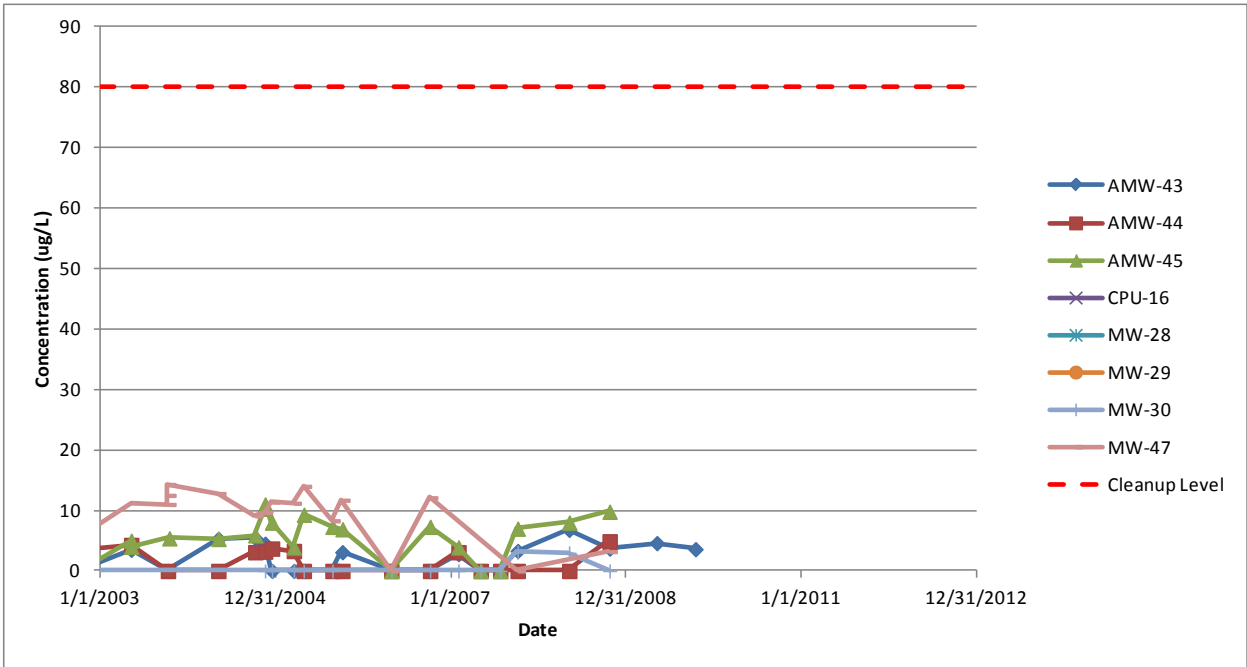

Figure E15. Chromium Concentrations in Sentinel Toe Wells

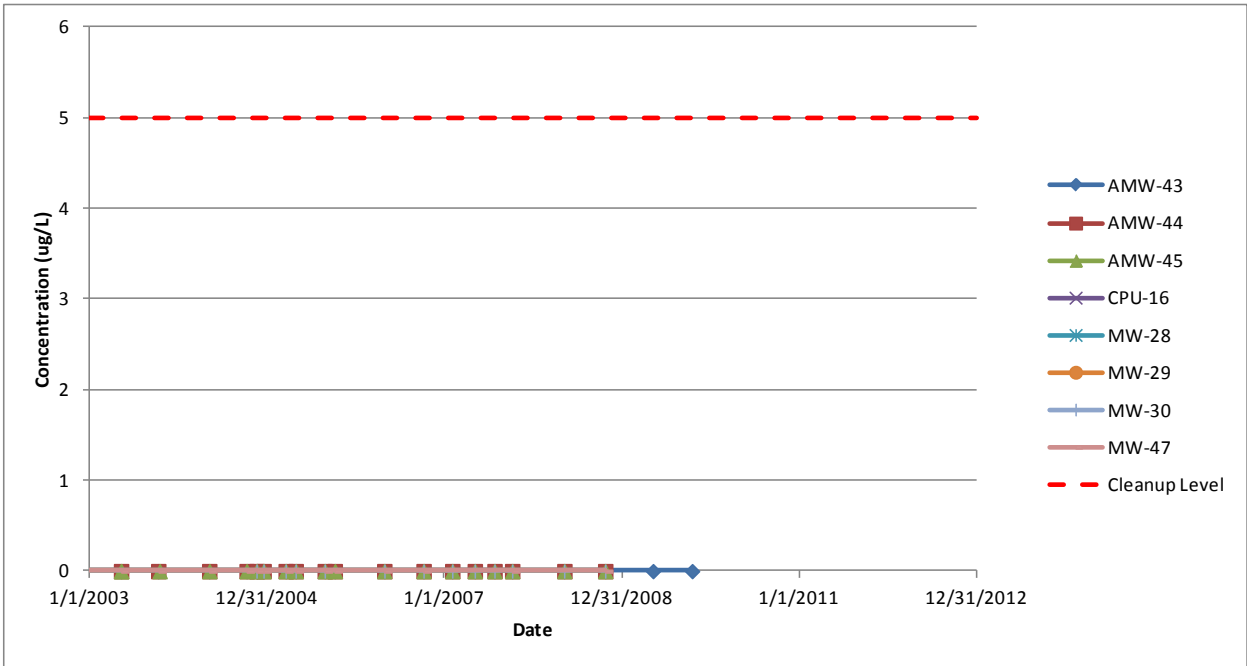

Figure E16. TCE Concentrations in Sentinel Toe Wells

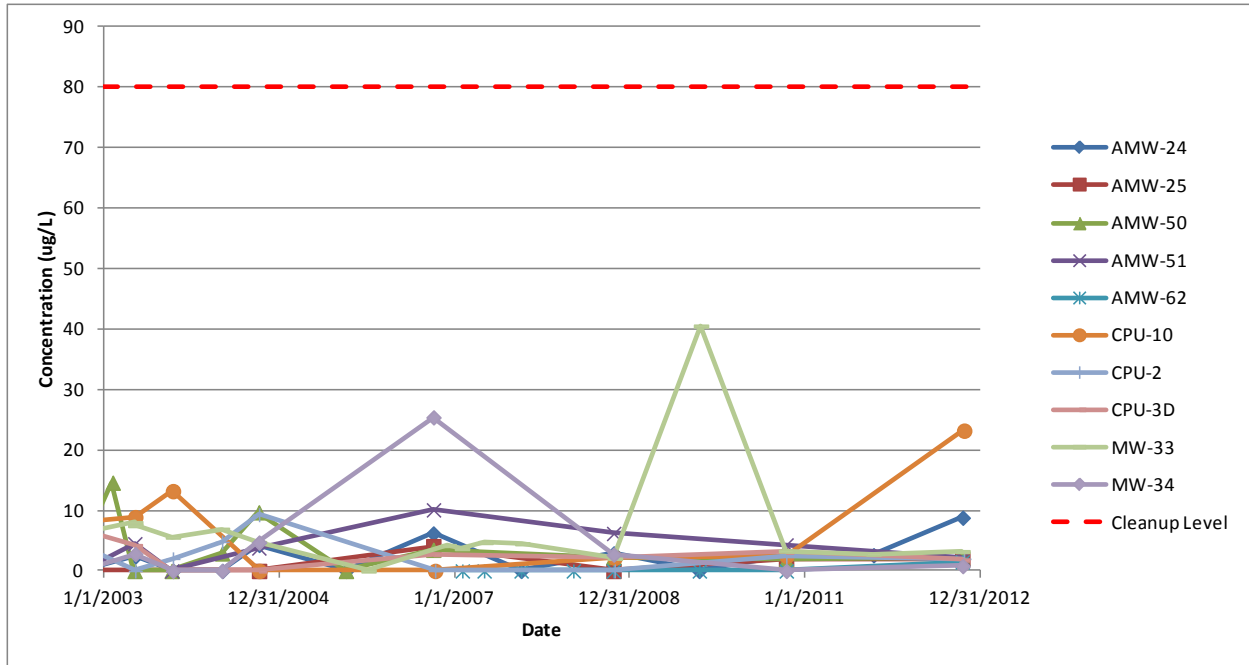

Figure E17. Chromium Concentrations in Troutdale Aquifer Wells

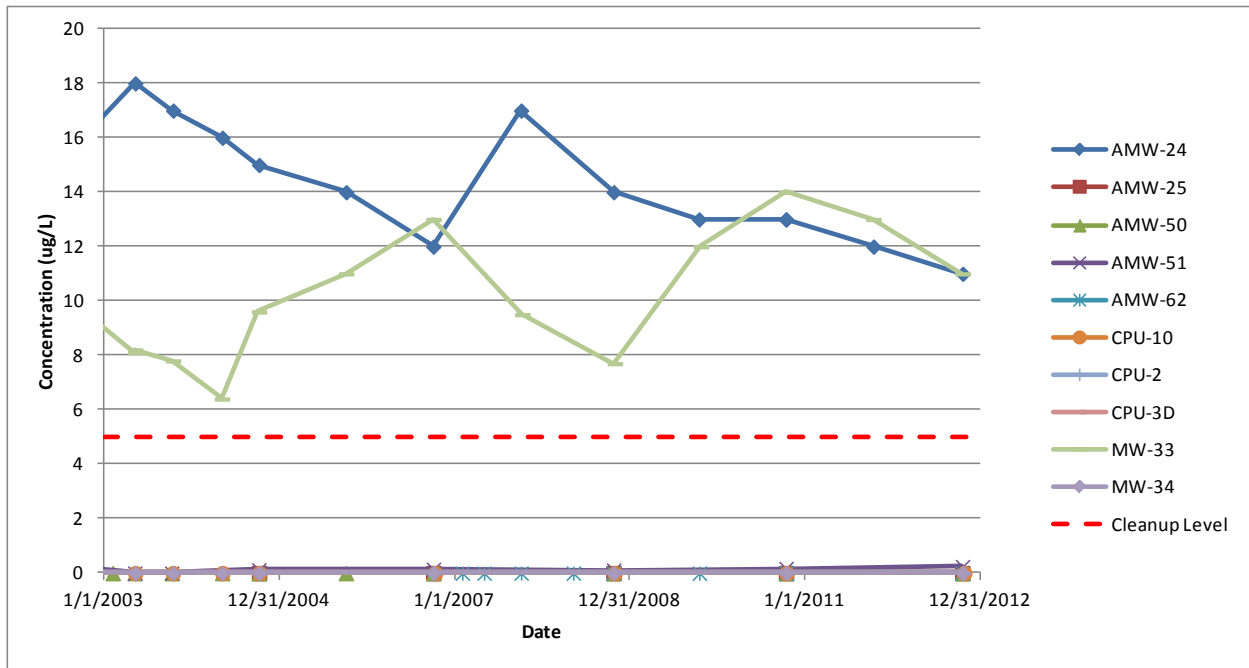

Figure E18. TCE Concentrations in Troutdale Aquifer Wells

Five-year Pumping Rates

Table E1. Summary of Extraction Well Pumping Rates, 2008-2012

Date	AMW-27	AMW-42	AMW-59	CPU-13	MW-10B	MW-10C	MW-14C	MW-14E	MW-18D	MW-18E	MW-19D	MW-20D	MW-21D	MW-22D	MW-25D	MW-26D	MW-27D	MW-31	MW-35	MW-37	MW-41	MW-46	MW-48	MW-49	MW-6B	PW-1B	Total
Jan-08	1	0	0	13.2	9.4	10	12	9	7.4	0	9	10.5	7.0	12	11	13	3.8	0	0		0	0	0	10.5	7.6	9.5	155.93
Feb-08	1	0	0	13.3	0	10.2	12.2	9	7.5	0	9	10.8	7.03	12.7	11.2	13.5	3.8	0	0		0	0	0	11.2	0	9.5	141.93
Mar-08	1	0	0	13.2	9.4	10	12	9	7.5	0	9	10.5	7.03	12	11	13	3.7	0	0		0	0	0	10.7	7.6	9.5	156.13
Apr-08	1	0	0	13.2	9.4	10	12	9	7.6	0	9	10.5	7.03	12.2	11	13	3.7	0	0		0	0	0	10.7	7.6	9.5	156.43
May-08	1	0	0	13.2	9.4	10	12	8.8	7.5	0	9	10.5	7	12.2	11	13	3.7	0	0		0	0	0	10.6	7.6	9.5	156
Jun-08	1	0	0	13.2	9.2	10	12	8.8	7.3	0	9	10.5	6.9	12.2	11	13	3.7	0	0		0	0	0	10.1	7.6	9.5	155
Jul-08	1	0	0	13.1	9.2	10	12.2	8.8	7.8	0	8.2	11.1	6.9	13.5	0	15	3.7	0	0		0	0	0	12.5	7.6	9.4	150
Aug-08	1	0	0	13.5	8.5	10	12.2	8	7.8	0	8.3	11.1	7	13.5	0	15	3.7	0	0		0	0	0	12.4	7.6	9.4	148.97
Sep-08	1	0	0	13.6	8	9	12.1	8.2	7.4	0	9.5	10.5	6.8	12.3	11.6	13	3.6	0	0		0	0	0	10.5	7.4	9.2	153.7
Oct-08	1	0	0	13.3	8	9	12.2	8.2	7.4	0	9.5	14.9	6.8	12	11.5	13	3.8	0	0		0	0	0	10.5	7.5	9.4	158
Nov-08	1	0	0	13.1	8	9	12	8	7.2	0	8	14.9	6.8	11.5	11.2	12.4	3.4	0	0		0	0	0	10	7.5	9.4	153.4
Dec-08	1	0	0	13.2	8	9	12	8	7.2	0	8	15	6.8	11.5	11.2	12.5	3.4	0	0		0	0	0	10	7.5	9.5	153.8
Jan-09	1	0	0	13.1	7.2	9	12	8	7.4	0	8	15	6.8	11.5	11	12.3	3.7	0	0		0	0	0	10	7.2	9.5	152.7
Feb-09	1	0	0	13.2	7.3	9	12	8	7.4	0	8	15	6.9	11.5	11	12.3	3.7	0	0		0	0	0	10	7.2	9.5	153
Mar-09	1	0	0	13.2	8.7	9	12	8	7.6	0	8	16.4	6.9	11.9	11.3	12.8	3.7	0	0		0	0	0	10	7.2	9.5	157.2
Apr-09	1	0	0	13.1	8.7	8.7	12	8	7.6	0	8	16.3	6.8	11.5	11	12.8	3.7	0	0		0	0	0	10	7.2	9.5	155.9
May-09	1	0	0	13	8.7	8.7	12	8	7.6	0	8	15.3	6.8	11.5	11	12.8	3.7	0	0		0	0	0	10	7.2	9.5	154.8
Jun-09	1	0	0	13	8	9	12	8	7.6	0	8	15.2	6.8	11.4	11	12.7	3.7	0	0		0	0	0	10	7.2	9.5	154.1
Jul-09	1	0	0	13.2	7.5	9	12	8	7.5	0	8	15.2	7.4	13.5	11.4	12.6	3.5	0	0		0	0	0	10	7.2	9.5	156.5
Aug-09	1	0	0	13.3	7.5	9	12	8	7.5	0	0	15.1	7.4	12.7	12	14	3.5	0	0		0	0	0	11	7.2	9.5	150.7
Sep-09	1	0	0	13.5	7.2	9	12	7	7.4	0	12.7	15.3	6.7	11.2	11.2	12.2	3.7	0	0		0	0	0	9.2	7.5	9.5	156.3
Oct-09	1	0	0	12	7.2	9	12	7	7.5	0	12.7	15.3	6.9	10.5	11.2	12.3	3.7	0	0		0	0	0	9	8	9.5	154.8
Nov-09	1	0	0	13.3	8	8.8	12	7	7.6	0	12.7	18.7	7.2	11	11.3	12.9	0	0	0		0	0	0	9	8	9.2	157.7
Dec-09	1	0	0	13.5	8	9	0	7	8	0	13.2	15.7	0	12.9	11.9	14.5	0	0	0		0	0	0	11.6	8	9.2	143.5
Jan-10	1	0	0	13.1	7.3	8.6	12	7	7.6	0	12.7	15.4	10.5	11.1	11	12.5	0	0	0		0	0	0	9.2	7.5	9	155.5
Feb-10	1	0	0	13.2	7.4	8.6	12	7	7.7	0	12.8	15.3	10.1	11	11.5	12.5	0	0	0		0	0	0	9.1	7.6	9	155.8
Mar-10	1	0	0	13.2	7.4	8.6	12	7	7.7	0	12.4	15.4	10.6	11	11.4	12	0	0	0		0	0	0	9.6	7.6	9	155.9
Apr-10	1	0	0	13.2	7.4	8.6	12	7	7.7	0	12.4	15.3	10.4	11.6	11.4	12.4	0	0	0		0	0	0	9	7.6	9.2	156.2
May-10	1	0	0	12.9	7.4	8.7	12	7	7.7	0	12	15.3	10.4	10.8	11.4	12.5	0	0	0		0	0	0	9	7.6	9.2	154.9
Jun-10	1	0	0	13.3	7.4	8.8	12	7	7.7	0	12	15	10.5	11.2	11.4	12.8	0	0	0		0	0	0	10	7.6	9.2	156.9
Jul-10	1	0	0	13.4	7.5	8.8	12	7	8	0	13	15.7	10.8	12.1	12	14	0	0	0		0	0	0	0	7.6	9.2	152.1
Aug-10	1	0	0	13.5	8	9	11.8	7	7.8	0	12	15.3	10.3	10.3	11.2	12.5	0	0	0		0	0	0	13.2	7.5	9.2	159.6
Sep-10	1	0	0	13	8.3	9.2	11.8	5.5	7.8	0	11.5	15.3	10.4	10.4	11.2	11.6	0	0	0		0	0	0	13.9	7.5	9.2	157.6
Oct-10	1	0	0	13	8.8	9	12	5.4	12.4	0	11.3	15.6	9.9	11.4	11	12.5	0	0	0		0	0	0	12.8	7.5	10	163.6
Nov-10	1	0	0	13.1	8.5	9	12	5.4	12.4	0	11.3	15	9.3	11.2	11	11	0	0	0		0	0	0	13	7.3	7	157.5
Dec-10	1	0	0	13	8.5	8.9	12	5.4	12.5	0	11.3	15.1	9.3	11.5	11	11	0	0	0		0	0	0	13	7	6.4	156.9
Jan-11	1	0	0	13.1	8.5	9.2	12.2	5.2	12.5	0	11.3	15.1	9.5	11.6	11	11	0	0	0		0	0	0	13.3	7.2	6.5	158.2
Feb-11	1	0	0	13.1	8.5	9.2	12.2	5.2	12.5	0	11.3	15.1	9.5	11.6	11	11	0	0	0		0	0	0	13.3	7.2	6.5	158.2
Mar-11	1	0	0	13.1	9	9.7	12	5	12.4	0	11.1	15.1	9.7	11.9	11	11.6	0	0	0		0	0	0	13.6	7.6	6.5	160.3
Apr-11	1	0	0	12.7	9.1	10	13	4.8	10.2	0	8.3	2.7	6	15	8	11.5	0	0	0		0	0	0	15	7.8	10	145.1
May-11	1	0	0	12.8	9	10	12.7	4	10.2	0	8.3	2.8	6	14.6	8	11	0	0	0		0	0	0	15	7.8	10	143.2

Table E1. Summary of Extraction Well Pumping Rates, 2008-2012

Jun-11	1	0	0	12.7	9.4	10	12.7	4.6	11.4	0	<i>8</i>	<i>2.9</i>	<i>6.2</i>	14.9	8	11	0	0	0	0	0	15	7.8	10	145.6	
Jul-11	1	0	0	12.7	9.4	10	12.7	4.6	10.4	0	<i>8</i>	<i>2.9</i>	<i>6.3</i>	14.9	8.1	11.6	0	0	0	0	0	15	7.6	10	145.2	
Aug-11	1	0	0	12.4	9.4	10	12.7	4.8	10.4	0	<i>8</i>	<i>2.7</i>	<i>6.2</i>	14.9	8	11.6	0	0	0	0	0	15	8	9.8	144.9	
Sep-11	1	0	0	11.9	9	10	12.4	5	11	0	10.5	15	9.4	13.2	6	8.5	0	0	0	0	0	13	7.5	9.8	153.2	
Oct-11	1	0	0	12.1	9	9.8	12.1	5	11.2	0	10.6	15	9.5	13.3	6.4	8.6	0	0	0	0	0	13	7.5	9.4	153.5	
Nov-11	1	0	0	12	9	9.8	12.1	5	11.3	0	10.4	15	11.2	12.9	6.4	8.7	0	0	0	0	0	13	7.7	9.5	155	
Dec-11	1	0		12	10	8.7	12	5	11		10.4	15	11.5	13	6.3	8.6	0	0	0	0	0	13	7.7	9.5	154.7	
Jan-12	1	0		12.3	8.8	9.8	12	5	11		10.4	15	10.5	13	6.4	8.8	0	0	0	0	0	13	7.7	9.5	154.2	
Feb-12	1	0		9.1	9	10	12	5	11.4		10.4	15	11.2	13.5	6.4	9	0	0	0	0	0	13	7.7	9.7	153.4	
Mar-12	1	0		12.3	9	10	0	5.2	13.4		10.4	15	11.5	13.8	9	9.3	0	0	0	0	0	13.3	7.8	9.9	150.9	
Apr-12	1			12.3	9	10	12	5.3	11.4		10	15	11.4	13.3	9	9						13	7.8	9.8	159.3	
May-12	1			12.2	8.6	10	12	5	11.2		10.1	15	10.5	13.5	9	9						13	7.8	10	157.9	
Jun-12	1			12.8	8.6	10	12	8.5	11.5		10	15	11.4	13.5	9	9						13	7.8	9.9	163	
Jul-12	1			12.3	8.9	10	12.6	8.3	11.2		10	15	10.6	14.2	6.3	8.6						12.5	7.7	9.8	159	
Aug-12	1			12.1	8.5	10	11.6	8.1	11.2		10	15	11.2	14.2	6.3	8.6						12.5	7.5	9.6	157.4	
Sep-12	1			12.4	8.5	10	13.2	8	11		10	15	11.3	14.4	6.2	9						12.4	7.5	9.6	159.5	
min	1	0	0	9.1	0	8.6	0	4	7.2	0	0	2.7	0	10.3	0	8.5	0	0	0	0	0	0	0	6.4	141.93	
max	1	0	0	13.6	10	10.2	13.2	9	13.4	0	13.2	18.7	11.5	15	12	15	3.8	0	0	0	0	0	15	8	10	163.6

Notes:

Pumping rates in gallons/minute

italic Pumping rate decreased during 2011 Northern Plume investigation

Five-year Data Summary

Table E3. Summary of VOCs and Chromium Concentrations, January 2008 - October 2012

Analyte (ug/L)			1,1,1-Trichloroethane		1,1,2,2-Tetrachloroethane		1,1-Dichloroethylene		1,2-Dibromo-3-Chloropropane (DBCP)		1,2-Dichloroethane		Bromodichloromethane		Carbon Tetrachloride		CFC-11		Dibromochloromethane	
ROD Cleanup Level (ug/L)			200		-		1		0.2		5 ^a		1		1		2400 ^b		1	
Well Group	Well ID	# VOC Samples	Min	Max	Min	Max	Min	Max	Min	Max	Min	Max	Min	Max	Min	Max	Min	Max	Min	Max
Church of God	AMW-14	6	0.5 U	0.5 U	0.5 U	0.5 U	0.5 U	0.5 U	2 U	2 U	0.41 J	0.5 U	0.5 U	0.5 U	0.5 U	0.5 U	0.5 U	0.5 U	0.5 U	0.5 U
Church of God	AMW-15	1	0.5 U	0.5 U	0.5 U	0.5 U	0.5 U	0.5 U	2 U	2 U	0.5 U	0.5 U	0.5 U	0.5 U	0.5 U	0.5 U	0.5 U	0.5 U	0.5 U	0.5 U
Church of God	AMW-27	10	0.11 J	0.25 J	0.5 U	0.5 U	0.28 J	1.5	2 U	2 U	0.08 J	0.5 U	0.5 U	0.5 U	0.5 U	0.5 U	0.09 J	0.5 U	0.5 U	0.5 U
Church of God	AMW-61	3	0.1 J	0.5 U	0.5 U	0.5 U	0.44 J	1.6	2 U	2 U	0.5 U	0.5 U	0.5 U	0.5 U	0.5 U	0.5 U	0.5 U	0.5 U	0.5 U	0.5 U
Church of God	CPU-12	5	0.13 J	0.5 U	0.5 U	0.5 U	0.5 U	0.5 U	2 U	2 U	0.5 U	0.5 U	0.5 U	0.5 U	0.5 U	0.5 U	0.29 J	1.1	0.5 U	0.5 U
Church of God	CPU-13	10	0.07 J	0.5 U	0.5 U	0.5 U	0.5 U	0.5 U	2 U	2 U	0.5 U	0.5 U	0.5 U	0.5 U	0.5 U	0.5 U	0.27 J	0.59	0.5 U	0.5 U
Church of God	MW-21D	11	0.16 J	1.4	0.5 U	0.5 U	0.92	2.2	2 U	2 U	0.5 U	0.5 U	0.5 U	0.5 U	0.5 U	0.5 U	0.32 J	3.3	0.5 U	0.5 U
Church of God	MW-22D	10	0.11 J	0.5 U	0.5 U	0.5 U	0.22 J	0.5	2 U	2 U	0.5 U	0.5 U	0.5 U	0.5 U	0.5 U	0.5 U	0.21 J	1	0.5 U	0.5 U
Church of God	MW-23D	5	0.13 J	0.43 J	0.5 U	0.5 U	0.49 J	1.4	2 U	2 U	0.5 U	0.5 U	0.5 U	0.5 U	0.5 U	0.5 U	0.13 J	0.5 U	0.5 U	0.5 U
Church of God	MW-25D	11	0.12 J	0.24 J	0.5 U	0.5 U	0.17 J	0.5 U	2 U	2 U	0.5 U	0.5 U	0.5 U	0.5 U	0.5 U	0.5 U	0.12 J	0.5 U	0.5 U	0.5 U
Church of God	MW-26D	10	0.5 U	0.5 U	0.5 U	0.5 U	0.5 U	0.5 U	2 U	2 U	0.5 U	0.5 U	0.5 U	0.5 U	0.5 U	0.5 U	0.14 J	0.5 U	0.5 U	0.5 U
Church of God	MW-27D	9	0.09 J	0.5 U	0.5 U	0.5 U	0.5 U	0.5 U	2 U	2 U	0.5 U	0.5 U	0.5 U	0.5 U	0.5 U	0.5 U	0.5 U	0.5 U	0.5 U	0.5 U
Church of God	MW-49	10	0.08 J	0.5 U	0.5 U	0.5 U	0.08 J	0.5 U	2 U	2 U	0.5 U	0.5 U	0.5 U	0.5 U	0.5 U	0.5 U	0.14 J	0.5 U	0.5 U	0.5 U
Intermediate Wells	AMW-16	6	0.09 J	2.2	0.5 U	0.5 U	0.14 J	0.66	2 U	2 U	0.5 U	0.5 U	0.5 U	0.5 U	0.5 U	0.5 U	0.12 J	0.5 U	0.5 U	0.5 U
Intermediate Wells	AMW-17	12	0.17 J	2.6	0.5 U	0.5 U	0.13 J	1.4	2 U	2 U	0.5 U	0.5 U	0.5 U	0.5 U	0.5 U	0.5 U	0.5 U	0.5 U	0.5 U	0.5 U
Intermediate Wells	AMW-18	16	0.16 J	6.9 D	0.5 U	1 U	0.09 J	2.7 D	2 U	4 U	0.5 U	1 U	0.5 U	1 U	0.5 U	1 U	0.22 J	1 U	0.5 U	1 U
Intermediate Wells	AMW-59	4	0.5 U	0.5 U	0.5 U	0.5 U	1.1	3.4	2 U	2 U	0.12 J	0.5 U	0.5 U	0.5 U	0.5 U	0.5 U	0.5 U	0.5 U	0.5 U	0.5 U
Intermediate Wells	AMW-60	1	0.5 U	0.5 U	0.5 U	0.5 U	0.33 J	0.33 J	2 U	2 U	0.11 J	0.11 J	0.5 U	0.5 U	0.5 U	0.5 U	0.16 J	0.16 J	0.5 U	0.5 U
Intermediate Wells	AMW-64	4	1.2	3.5	0.5 U	0.5 U	1.5	2.7	2 U	2 U	0.5 U	0.5 U	0.5 U	0.5 U	0.5 U	0.5 U	0.5 U	0.5 U	0.5 U	0.5 U
Intermediate Wells	CPU-14	5	0.13 J	0.26 J	0.5 U	0.5 U	0.11 J	0.26 J	2 U	2 U	0.5 U	0.5 U	0.5 U	0.5 U	0.5 U	0.5 U	0.37 J	2.2	0.5 U	0.5 U
Intermediate Wells	MW-14C	10	0.08 J	0.5 U	0.5 U	0.5 U	0.12 J	0.5 U	2 U	2 U	0.5 U	0.5 U	0.1 J	0.5 U	0.5 U	0.5 U	0.15 J	2.7	0.5 U	0.5 U
Intermediate Wells	MW-14E	10	0.24 J	0.67	0.5 U	0.5 U	3.5	5.3	2 U	2 U	0.5 U	0.5 U	0.5 U	0.5 U	0.5 U	0.5 U	0.43 J	8.6	0.5 U	0.5 U
Intermediate Wells	MW-15E	10	0.08 J	0.5 U	0.5 U	0.5 U	0.08 J	0.5 U	2 U	2 U	0.5 U	0.5 U	0.5 U	0.5 U	0.5 U	0.5 U	0.13 J	0.5 U	0.5 U	0.5 U
Intermediate Wells	MW-16E	4	0.5 U	0.5 U	0.5 U	0.5 U	0.08 J	0.5 U	2 U	2 U	0.5 U	0.5 U	0.5 U	0.5 U	0.5 U	0.5 U	0.5 U	0.5 U	0.5 U	0.5 U
Intermediate Wells	MW-18D	10	0.24 J	0.73	0.5 U	0.5 U	0.73	1.6	2 U	2 U	0.5 U	0.5 U	0.5 U	0.5 U	0.5 U	0.5 U	1.1	1.4	0.5 U	0.5 U
Intermediate Wells	MW-18E	5	0.5 U	0.5 U	0.5 U	0.5 U	1.4	3.1	2 U	2 U	0.08 J	0.5 U	0.5 U	0.5 U	0.5 U	0.5 U	0.5 U	0.5 U	0.5 U	0.5 U
Intermediate Wells	MW-19D	10	0.09 J	0.5 U	0.5 U	0.5 U	1.4	2.5	2 U	2 U	0.5 U	0.5 U	0.05 J	0.5 U	0.5 U	0.5 U	0.46 J	4.8	0.5 U	0.5 U
Intermediate Wells	MW-20D	10	0.12 J	0.54	0.5 U	0.5 U	3	4.9	2 U	2 U	0.5 U	0.5 U	0.5 U	0.5 U	0.5 U	0.5 U	0.43 J	2	0.5 U	0.5 U
Intermediate Wells	MW-38	4	0.21 J	0.69	0.5 U	0.5 U	0.2 J	0.68	2 U	2 U	0.5 U	0.5 U	0.5 U	0.5 U	0.5 U	0.5 U	0.19 J	0.47 J	0.5 U	0.5 U
Intermediate Wells	MW-40	1	0.27 J	0.27 J	0.5 U	0.5 U	0.5 U	0.5 U	2 U	2 U	0.5 U	0.5 U	0.14 J	0.14 J	0.5 U	0.5 U	0.56	0.56	0.5 U	0.5 U
Intermediate Wells	PZ-39	6	0.97	4.3	0.5 U	0.5 U	3.6	15	2 U	2 U	0.5 U	0.5 U	0.5 U	0.5 U	0.5 U	0.5 U	6.1	29	0.5 U	0.5 U
Other Toe Wells	AMW-42	5	0.08 J	0.5 U	0.5 U	0.5 U	0.5 U	0.5 U	2 U	2 U	0.5 U	0.5 U	0.5 U	0.5 U	0.5 U	0.5 U	0.5 U	0.5 U	0.5 U	0.5 U
Other Toe Wells	AMW-63	5	0.5 U	0.5 U	0.5 U	0.5 U	0.5 U	0.5 U	2 U	2 U	0.5 U	0.5 U	0.5 U	0.5 U	0.5 U	0.5 U	0.5 U	0.5 U	0.5 U	0.5 U
Other Toe Wells	MW-31	4	0.16 J	0.5 U	0.5 U	0.5 U	0.5 U	0.5 U	2 U	2 U	0.5 U	0.5 U	0.5 U	0.5 U	0.5 U	0.5 U	0.5 U	0.5 U	0.5 U	0.5 U
Other Toe Wells	MW-35	8	0.08 J	0.5 U	0.5 U	0.5 U	0.1 J	0.5 U	2 U	2 U	0.5 U	0.5 U	0.5 U	0.5 U	0.5 U	0.5 U	0.5 U	0.5 U	0.5 U	0.5 U
Other Toe Wells	MW-37	1	0.5 U	0.5 U	0.5 U	0.5 U	0.5 U	0.5 U	2 U	2 U	0.5 U	0.5 U	0.5 U	0.5 U	0.5 U	0.5 U	0.5 U	0.5 U	0.5 U	0.5 U
Other Toe Wells	MW-41	6	0.5 U	0.5 U	0.5 U	0.5 U	0.5 U	0.5 U	2 U	2 U	0.5 U	0.5 U	0.5 U	0.5 U	0.5 U	0.5 U	0.5 U	0.5 U	0.5 U	0.5 U
Other Toe Wells	MW-46	4	0.5 U	0.5 U	0.5 U	0.5 U	0.5 U	0.5 U	2 U	2 U	0.5 U	0.5 U	0.5 U	0.5 U	0.5 U	0.5 U	0.5 U	0.5 U	0.5 U	0.5 U
Other Toe Wells	MW-48	2	0.5 U	0.5 U	0.5 U	0.5 U	0.5 U	0.5 U	2 U	2 U	0.5 U	0.5 U	0.5 U	0.5 U	0.5 U	0.5 U	0.5 U	0.5 U	0.5 U	0.5 U
Other Wells	BENNETT	9	0.16 J	0.73	0.5 U	0.5 U	0.63	2	2 U	2 U	0.5 U	0.5 U	0.5 U	0.5 U	0.5 U	0.5 U	0.09 J	0.5 U	0.5 U	0.5 U
Proximal	AMW-58	3	0.5 U	0.5 U	0.5 U	0.5 U	0.5 U	0.5 U	2 U	2 U	0.5 U	0.5 U	0.5 U	0.5 U	0.5 U	0.5 U	0.5 U	0.5 U	0.5 U	0.5 U
Proximal	EC-1	1	0.5 U	0.5 U	0.5 U	0.5 U	0.5 U	0.5 U	2 U	2 U	0.5 U	0.5 U	0.5 U	0.5 U	0.5 U	0.5 U	0.5 U	0.5 U	0.5 U	0.5 U
Proximal	MW-10B	10	0.09 J	0.5 U	0.5 U	0.5 U	0.15 J	0.39 J	2 U	2 U	0.5 U	0.5 U	0.5 U	0.5 U	0.5 U	0.5 U	0.18 J	1.9	0.5 U	0.5 U
Proximal	MW-10C	10	0.08 J	0.5 U	0.5 U	0.5 U	0.5 U	0.5 U	2 U	2 U	0.5 U	0.5 U	0.5 U	0.5 U	0.5 U	0.5 U	0.5 U	0.5 U	0.5 U	1
Proximal	MW-12C	4	0.09 J	0.5 U	0.5 U	0.5 U	0.5 U	0.5 U	2 U	2 U	0.5 U	0.5 U	0.5 U	0.5 U	0.5 U	0.5 U	0.09 J	0.5 U	0.5 U	0.5 U
Proximal	MW-13C	5	0.13 J	0.37 J	0.5 U	0.5 U	0.5 U	0.5 U	2 U	2 U	0.5 U	0.5 U	0.5 U	0.5 U	0.5 U	0.5 U	0.5 U	0.5 U	0.5 U	0.5 U

Table E3. Summary of VOCs and Chromium Concentrations, January 2008 - October 2012

Analyte (ug/L)			1,1,1-Trichloroethane		1,1,2,2-Tetrachloroethane		1,1-Dichloroethylene		1,2-Dibromo-3-Chloropropane (DBCP)		1,2-Dichloroethane		Bromodichloromethane		Carbon Tetrachloride		CFC-11		Dibromochloromethane	
ROD Cleanup Level (ug/L)			200		--		1		0.2		5 ^a		1		1		2400 ^a		1	
Well Group	Well ID	# VOC Samples	Min	Max	Min	Max	Min	Max	Min	Max	Min	Max	Min	Max	Min	Max	Min	Max	Min	Max
Proximal	MW-2A	4	0.5 U	0.5 U	0.5 U	0.5 U	0.5 U	0.5 U	2 U	2 U	0.5 U	0.5 U	0.5 U	0.5 U	0.5 U	0.5 U	0.12 J	0.25 J	0.5 U	0.5 U
Proximal	MW-2B	1	0.5 U	0.5 U	0.5 U	0.5 U	0.5 U	0.5 U	2 U	2 U	0.5 U	0.5 U	0.5 U	0.5 U	0.5 U	0.5 U	0.5 U	0.5 U	0.5 U	0.5 U
Proximal	MW-2C	1	0.5 U	0.5 U	0.5 U	0.5 U	0.5 U	0.5 U	2 U	2 U	0.5 U	0.5 U	0.5 U	0.5 U	0.5 U	0.5 U	0.5 U	0.5 U	0.5 U	0.5 U
Proximal	MW-3A	1	0.5 U	0.5 U	0.5 U	0.5 U	0.5 U	0.5 U	2 U	2 U	0.5 U	0.5 U	0.5 U	0.5 U	0.5 U	0.5 U	0.5 U	0.5 U	0.5 U	0.5 U
Proximal	MW-3B	3	0.5 U	0.5 U	0.5 U	0.5 U	0.5 U	0.5 U	2 U	2 U	0.5 U	0.5 U	0.5 U	0.5 U	0.5 U	0.5 U	0.5 U	0.5 U	0.5 U	0.5 U
Proximal	MW-4A	1	0.08 J	0.08 J	0.5 U	0.5 U	0.5 U	0.5 U	2 U	2 U	0.5 U	0.5 U	0.5 U	0.5 U	0.5 U	0.5 U	0.5 U	0.5 U	0.5 U	0.5 U
Proximal	MW-4B	4	0.07 J	0.5 U	0.5 U	0.5 U	0.5 U	0.5 U	2 U	2 U	0.5 U	0.5 U	0.5 U	0.5 U	0.5 U	0.5 U	0.13 J	0.5 U	0.5 U	0.5 U
Proximal	MW-4BSHED	1	0.5 U	0.5 U	0.5 U	0.5 U	0.5 U	0.5 U	2 U	2 U	0.5 U	0.5 U	0.5 U	0.5 U	0.5 U	0.5 U	0.15 J	0.15 J	0.5 U	0.5 U
Proximal	MW-4C	1	0.5 U	0.5 U	0.5 U	0.5 U	0.5 U	0.5 U	2 U	2 U	0.5 U	0.5 U	0.5 U	0.5 U	0.5 U	0.5 U	0.5 U	0.5 U	0.5 U	0.5 U
Proximal	MW-6A	1	0.5 U	0.5 U	0.5 U	0.5 U	0.5 U	0.5 U	2 U	2 U	0.5 U	0.5 U	0.5 U	0.5 U	0.5 U	0.5 U	0.5 U	0.5 U	0.5 U	0.5 U
Proximal	MW-6B	11	0.1 J	0.5 U	0.5 U	0.5 U	0.08 J	0.5 U	2 U	2 U	0.5 U	0.5 U	0.5 U	0.5 U	0.5 U	0.5 U	0.18 J	0.61	0.5 U	0.5 U
Proximal	MW-6C	1	0.5 U	0.5 U	0.5 U	0.5 U	0.5 U	0.5 U	2 U	2 U	0.5 U	0.5 U	0.13 J	0.13 J	0.5 U	0.5 U	0.5 U	0.5 U	0.5 U	0.5 U
Proximal	MW-6D	1	0.5 U	0.5 U	0.5 U	0.5 U	0.75	0.75	2 U	2 U	0.5 U	0.5 U	0.5 U	0.5 U	0.5 U	0.5 U	0.5 U	0.5 U	0.5 U	0.5 U
Proximal	MW-7B	1	0.5 U	0.5 U	0.5 U	0.5 U	0.5 U	0.5 U	2 U	2 U	0.5 U	0.5 U	0.5 U	0.5 U	0.5 U	0.5 U	0.22 J	0.22 J	0.5 U	0.5 U
Proximal	MW-7C	1	0.5 U	0.5 U	0.5 U	0.5 U	0.5 U	0.5 U	2 U	2 U	0.5 U	0.5 U	0.5 U	0.5 U	0.5 U	0.5 U	0.5 U	0.5 U	0.5 U	0.5 U
Proximal	MW-8B	3	0.14 J	0.5 U	0.5 U	0.5 U	0.5 U	0.5 U	2 U	2 U	0.5 U	0.5 U	0.5 U	0.5 U	0.5 U	0.5 U	0.21 J	0.66	0.5 U	0.5 U
Proximal	MW-9B	3	0.13 J	0.37 J	0.5 U	0.5 U	0.11 J	0.5 U	2 U	2 U	0.5 U	0.5 U	0.5 U	0.5 U	0.5 U	0.5 U	0.67	1.8	0.5 U	0.5 U
Proximal	MW-9C	1	0.5 U	0.5 U	0.5 U	0.5 U	0.5 U	0.5 U	2 U	2 U	0.5 U	0.5 U	0.5 U	0.5 U	0.5 U	0.5 U	0.34 J	0.34 J	0.5 U	0.5 U
Proximal	PW-1B	11	0.07 J	0.5 U	0.5 U	0.5 U	0.5 U	0.5 U	2 U	2 U	0.5 U	0.5 U	0.5 U	0.5 U	0.5 U	0.5 U	0.09 J	0.5 U	0.5 U	0.5 U
TCE Source	AMW-12A	15	0.07 J	0.19 J	0.5 U	0.5 U	0.37 J	0.61	2 U	2 U	0.5 U	0.5 U	0.5 U	0.5 U	0.5 U	0.5 U	0.13 J	0.66	0.5 U	0.5 U
TCE Source	AMW-13A	10	0.08 J	0.5 U	0.5 U	0.5 U	0.5 U	0.5 U	2 U	2 U	0.5 U	0.5 U	0.24 J	3.2	0.5 U	0.5 U	0.5 U	0.5 U	0.09 J	0.5 U
TCE Source	AMW-19A	11	0.5 U	0.5 U	0.5 U	0.5 U	0.5 U	0.5 U	2 U	2 U	0.5 U	0.5 U	0.5 U	0.5 U	0.5 U	0.5 U	0.5 U	0.5 U	0.5 U	0.5 U
TCE Source	AMW-19B	2	0.5 U	0.5 U	0.5 U	0.5 U	0.5 U	0.5 U	2 U	2 U	0.5 U	0.5 U	0.5 U	0.5 U	0.5 U	0.5 U	0.5 U	0.5 U	0.5 U	0.5 U
TCE Source	AMW-1A	13	0.26 J	6.8	0.5 U	0.5 U	0.11 J	0.93	2 U	2 U	0.5 U	0.5 U	0.5 U	3.3	0.5 U	1.4	0.09 J	11	0.12 J	1.2
TCE Source	AMW-1B	8	0.5 U	0.5 U	0.5 U	0.5 U	0.5 U	0.5 U	2 U	2 U	0.5 U	0.5 U	0.5 U	0.5 U	0.5 U	0.5 U	0.5 U	0.5 U	0.5 U	0.5 U
TCE Source	AMW-1C	3	0.5 U	0.5 U	0.5 U	0.5 U	0.5 U	0.5 U	2 U	2 U	0.5 U	0.5 U	0.13 J	0.5 U	0.5 U	0.5 U	0.5 U	0.5 U	0.5 U	0.5 U
TCE Source	AMW-26	9	0.1 J	0.5 U	0.5 U	0.5 U	0.5 U	0.5 U	2 U	2 U	0.5 U	0.5 U	0.13 J	0.5 U	0.5 U	0.5 U	0.11 J	3.4 J	0.5 U	0.5 U
TCE Source	AMW-2A	13	0.19 J	3.1	0.5 U	0.5 U	0.1 J	0.56	2 U	2 U	0.5 U	0.5 U	0.2 J	0.77	0.5 U	0.5 U	0.5 U	21	0.14 J	0.5 U
TCE Source	AMW-2B	9	0.5 U	0.5 U	0.5 U	0.5 U	0.5 U	0.5 U	2 U	2 U	0.5 U	0.5 U	0.5 U	0.5 U	0.5 U	0.5 U	0.5 U	0.5 U	0.5 U	0.5 U
TCE Source	AMW-3A	10	0.5 U	0.5 U	0.5 U	0.5 U	0.5 U	0.5 U	2 U	2 U	0.5 U	0.5 U	0.15 J	0.5 U	0.5 U	0.5 U	0.5 U	0.5 U	0.5 U	0.5 U
TCE Source	AMW-4A	2	0.5 U	0.5 U	0.5 U	0.5 U	0.5 U	0.5 U	2 U	2 U	0.5 U	0.5 U	1.1	1.6	0.5 U	0.5 U	0.5 U	0.5 U	0.16 J	0.16 J
TCE Source	AMW-52A	9	0.5 U	0.5 U	0.5 U	0.5 U	0.5 U	0.5 U	2 U	2 U	0.5 U	0.5 U	0.06 J	0.5 U	0.5 U	0.5 U	0.11 J	0.85	0.5 U	0.5 U
TCE Source	AMW-52C	2	0.5 U	0.5 U	0.5 U	0.5 U	0.5 U	0.5 U	2 U	2 U	0.5 U	0.5 U	0.5 U	0.5 U	0.5 U	0.5 U	0.5 U	0.5 U	0.5 U	0.5 U
TCE Source	AMW-53A	13	0.12 J	1.9	0.5 U	0.5 U	0.16 J	0.5 U	2 U	2 U	0.5 U	0.5 U	0.16 J	1.7	0.5 U	0.5 U	0.33 J	5.1 J	0.06 J	0.5 U
TCE Source	AMW-53B	2	0.5 U	0.5 U	0.5 U	0.5 U	0.5 U	0.5 U	2 U	2 U	0.5 U	0.5 U	0.5 U	0.5 U	0.5 U	0.5 U	0.5 U	0.5 U	0.5 U	0.5 U
TCE Source	AMW-53C	2	0.5 U	0.5 U	0.5 U	0.5 U	0.5 U	0.5 U	2 U	2 U	0.5 U	0.5 U	0.5 U	0.5 U	0.5 U	0.5 U	0.5 U	0.5 U	0.5 U	0.5 U
TCE Source	AMW-54A	10	0.06 J	0.5 U	0.5 U	0.5 U	0.5 U	0.5 U	2 U	2 U	0.5 U	0.5 U	0.5 U	0.5 U	0.5 U	0.5 U	0.5 U	0.5 U	0.5 U	0.5 U
TCE Source	AMW-54C	2	0.5 U	0.5 U	0.5 U	0.5 U	0.5 U	0.5 U	2 U	2 U	0.5 U	0.5 U	0.5 U	0.5 U	0.5 U	0.5 U	0.5 U	0.5 U	0.5 U	0.5 U
TCE Source	AMW-55A	9	0.5 U	0.5 U	0.5 U	0.5 U	0.5 U	0.5 U	2 U	2 U	0.5 U	0.5 U	0.5 U	0.5 U	0.5 U	0.5 U	0.5 U	0.5 U	0.5 U	0.5 U
TCE Source	AMW-55C	2	0.5 U	0.5 U	0.5 U	0.5 U	0.5 U	0.5 U	2 U	2 U	0.5 U	0.5 U	0.5 U	0.5 U	0.5 U	0.5 U	0.5 U	0.5 U	0.5 U	0.5 U
TCE Source	AMW-56A	10	0.08 J	0.5 U	0.5 U	0.5 U	0.5 U	0.5 U	2 U	2 U	0.5 U	0.5 U	0.5 U	0.5 U	0.5 U	0.5 U	0.19 J	0.5 U	0.5 U	0.5 U
TCE Source	AMW-56C	7	0.5 U	0.5 U	0.5 U	0.5 U	0.5 U	0.5 U	2 U	2 U	0.5 U	0.5 U	0.5 U	0.5 U	0.5 U	0.5 U	0.5 U	0.5 U	0.5 U	0.5 U
TCE Source	MW-1A	13	0.08 J	0.5 U	0.5 U	0.5 U	0.1 J	0.5 U	2 U	2 U	0.5 U	0.5 U	0.5 U	0.5 U	0.5 U	0.5 U	0.09 J	2.6	0.5 U	0.5 U
TCE Source	MW-1B	2	0.5 U	0.5 U	0.5 U	0.5 U	0.5 U	0.5 U	2 U	2 U	0.5 U	0.5 U	0.5 U	0.5 U	0.5 U	0.5 U	0.5 U	0.5 U	0.5 U	0.5 U
TCE Source	MW-1C	2	0.5 U	0.5 U	0.5 U	0.5 U	0.5 U	0.5 U	2 U	2 U	0.5 U	0.5 U	0.5 U	0.5 U	0.5 U	0.5 U	0.5 U	0.5 U	0.5 U	0.5 U
TCE Source	RAMW-2C	3	0.5 U	0.5 U	0.5 U	0.5 U	0.5 U	0.5 U	2 U	2 U	0.5 U	0.5 U	0.5 U	0.5 U	0.5 U	0.5 U	0.5 U	0.5 U	0.5 U	0.5 U

Table E3. Summary of VOCs and Chromium Concentrations, January 2008 - October 2012

Analyte (ug/L) ROD Cleanup Level (ug/L)			1,1,1-Trichloroethane 200		1,1,2,2-Tetrachloroethane --		1,1-Dichloroethylene 1		1,2-Dibromo-3-Chloropropane (DBCP) 0.2		1,2-Dichloroethane 5*		Bromodichloro-methane 1		Carbon Tetrachloride 1		CFC-11 2400 ^a		Dibromochloro-methane 1	
Well Group	Well ID	# VOC Samples	Min	Max	Min	Max	Min	Max	Min	Max	Min	Max	Min	Max	Min	Max	Min	Max	Min	Max
Toe Sentinel Wells	AMW-43	4	0.5 U	0.5 U	0.5 U	0.5 U	0.5 U	0.5 U	2 U	2 U	0.5 U	0.5 U	0.5 U	0.5 U	0.5 U	0.5 U	0.5 U	0.5 U	0.5 U	0.5 U
Toe Sentinel Wells	AMW-44	2	0.5 U	0.5 U	0.5 U	0.5 U	0.5 U	0.5 U	2 U	2 U	0.5 U	0.5 U	0.5 U	0.5 U	0.5 U	0.5 U	0.5 U	0.5 U	0.5 U	0.5 U
Toe Sentinel Wells	AMW-45	2	0.5 U	0.5 U	0.5 U	0.5 U	0.5 U	0.5 U	2 U	2 U	0.5 U	0.5 U	0.5 U	0.5 U	0.5 U	0.5 U	0.5 U	0.5 U	0.5 U	0.5 U
Toe Sentinel Wells	MW-30	2	0.5 U	0.5 U	0.5 U	0.5 U	0.5 U	0.5 U	2 U	2 U	0.5 U	0.5 U	0.5 U	0.5 U	0.5 U	0.5 U	0.5 U	0.5 U	0.5 U	0.5 U
Toe Sentinel Wells	MW-47	1	0.5 U	0.5 U	0.5 U	0.5 U	0.5 U	0.5 U	2 U	2 U	0.5 U	0.5 U	0.5 U	0.5 U	0.5 U	0.5 U	0.5 U	0.5 U	0.5 U	0.5 U
Troutdale	AMW-24	6	0.37 J	0.79	0.5 U	0.5 U	1.6	2.1	2 U	2 UJ	0.5 U	0.5 U	0.5 U	0.5 U	0.5 U	0.5 U	0.14 J	0.17 J	0.5 U	0.5 U
Troutdale	AMW-25	3	0.5 U	0.5 U	0.5 U	0.5 U	0.5 U	0.5 U	2 U	2 U	0.5 U	0.5 U	0.5 U	0.5 U	0.5 U	0.5 U	0.5 U	0.5 U	0.5 U	0.5 U
Troutdale	AMW-50	3	0.05 J	0.5 U	0.5 U	0.5 U	0.5 U	0.5 U	2 U	2 U	0.5 U	0.5 U	0.5 U	0.5 U	0.5 U	0.5 U	0.09 J	0.5 U	0.5 U	0.5 U
Troutdale	AMW-51	3	0.5 U	0.5 U	0.5 U	0.5 U	0.5 U	0.5 U	2 U	2 U	0.5 U	0.5 U	0.5 U	0.5 U	0.5 U	0.5 U	0.5 U	0.5 U	0.5 U	0.5 U
Troutdale	AMW-62	5	0.5 U	0.5 U	0.5 U	0.5 U	0.5 U	0.5 U	2 U	2 U	0.5 U	0.5 U	0.5 U	0.5 U	0.5 U	0.5 U	0.5 U	0.5 U	0.5 U	0.5 U
Troutdale	CPU-10	3	0.5 U	0.5 U	0.5 U	0.5 U	0.5 U	0.5 U	2 U	2 U	0.5 U	0.5 U	0.5 U	0.5 U	0.5 U	0.5 U	0.5 U	0.5 U	0.5 U	0.5 U
Troutdale	CPU-2	3	0.5 U	0.5 U	0.5 U	0.5 U	0.5 U	0.5 U	2 U	2 U	0.5 U	0.5 U	0.5 U	0.5 U	0.5 U	0.5 U	0.5 U	0.5 U	0.5 U	0.5 U
Troutdale	CPU-3D	3	0.08 J	0.5 U	0.5 U	0.5 U	0.5 U	0.5 U	2 U	2 U	0.5 U	0.5 U	0.5 U	0.5 U	0.5 U	0.5 U	0.5 U	0.5 U	0.5 U	0.5 U
Troutdale	MW-33	5	0.2 J	0.51	0.5 U	0.5 U	1.2	2	2 U	2 UJ	0.5 U	0.5 U	0.5 U	0.5 U	0.5 U	0.5 U	0.13 J	0.16 J	0.5 U	0.5 U
Troutdale	MW-34	3	0.5 U	0.5 U	0.5 U	0.5 U	0.5 U	0.5 U	2 U	2 U	0.5 U	0.5 U	0.5 U	0.5 U	0.5 U	0.5 U	0.5 U	0.5 U	0.5 U	0.5 U
Upgradient	AMW-10A	7	0.5 U	0.5 UJ	0.5 U	0.5 U	0.5 U	0.5 UJ	2 U	2 UJ	0.5 U	0.5 U	0.5 U	0.5 U	0.5 U	0.5 UJ	0.5 U	0.5 UJ	0.5 U	0.5 UJ
Upgradient	AMW-11A	7	0.5 U	0.5 UJ	0.5 U	0.5 U	0.5 U	0.5 UJ	2 U	2 UJ	0.5 U	0.5 U	0.5 U	0.5 U	0.5 U	0.5 UJ	0.5 U	0.5 UJ	0.5 U	0.5 UJ
Upgradient	AMW-5A	2	0.5 U	0.5 U	0.5 U	0.5 U	0.5 U	0.5 U	2 U	2 U	0.5 U	0.5 U	0.5 U	0.5 U	0.5 U	0.5 U	0.5 U	0.5 U	0.5 U	0.5 U
Upgradient	AMW-6A	7	0.5 U	0.5 UJ	0.5 U	0.5 U	0.5 U	0.5 UJ	2 U	2 UJ	0.5 U	0.5 U	0.5 U	0.5 U	0.5 U	0.5 UJ	0.5 U	0.5 UJ	0.5 U	0.5 UJ
Upgradient	AMW-7A	7	0.5 U	0.5 UJ	0.5 U	0.5 U	0.5 U	0.5 UJ	2 U	2 UJ	0.5 U	0.5 U	0.5 U	0.5 U	0.5 U	0.5 UJ	0.5 U	0.5 UJ	0.5 U	0.5 UJ
Upgradient	AMW-8A	9	0.5 U	0.5 U	0.5 U	0.5 U	0.5 U	0.5 U	2 U	2 U	0.5 U	0.5 U	0.5 U	0.5 U	0.5 U	0.5 U	0.5 U	0.5 U	0.5 U	0.5 U
Upgradient	AMW-9A	1	0.5 U	0.5 U	0.5 U	0.5 U	0.5 U	0.5 U	2 U	2 U	0.5 U	0.5 U	0.5 U	0.5 U	0.5 U	0.5 U	0.5 U	0.5 U	0.5 U	0.5 U

Table E3. Summary of VOCs and Chromium Concentrations, January 2008 - October 2012

Analyte (ug/L)		cis-1,2-Dichloroethene		Dichloromethane		Hexachloro-1,3-Butadiene		Tetrachloroethene		trans-1,2-Dichloroethene		Trichloroethene		Vinyl Chloride		Total Chromium		
ROD Cleanup Level (ug/L)		70 ^a		5 ^a		5 ^a		5		100 ^a		5		2 ^a		80		
Well Group	Well ID	Min	Max	Min	Max	Min	Max	Min	Max	Min	Max	Min	Max	Min	Max	# Chromium Samples	Min	Max
Church of God	AMW-14	0.5 U	0.5 U	2 U	2 U	2 U	2 U	0.14 J	0.56	0.5 U	0.5 U	0.48 J	1	0.5 U	0.5 U	9	22.2	87.4
Church of God	AMW-15	0.5 U	0.5 U	2 U	2 U	2 U	2 U	0.5 U	0.5 U	0.5 U	0.5 U	0.5 U	0.5 U	0.5 U	0.5 U	2	2.6 J	5 U
Church of God	AMW-27	0.06 J	0.5 U	2 U	2 U	2 U	2 U	2.2	6.2	0.5 U	0.5 U	6.8	29	0.5 U	0.5 U	10	2.9 J	230
Church of God	AMW-61	0.5 U	0.5 U	2 U	2 U	2 U	2 U	0.9	2.5	0.5 U	0.5 U	5.4	6.5	0.5 U	0.5 U	2	17.3	35.2
Church of God	CPU-12	0.5 U	0.5 U	2 U	2 U	2 U	2 U	0.5 U	0.5 U	0.5 U	0.5 U	2.8	4.9	0.5 U	0.5 U	3	5 U	8
Church of God	CPU-13	0.5 U	0.5 U	2 U	2 U	2 U	2 U	0.54	0.99	0.5 U	0.5 U	1.4	2.6	0.5 U	0.5 U	10	16.4	34.7
Church of God	MW-21D	0.39 J	0.69	2 U	2 U	2 U	2 U	0.13 J	0.22 J	0.5 U	0.5 U	5.2	14	0.5 U	0.5 U	11	6.7	19.2
Church of God	MW-22D	0.09 J	0.5 U	2 U	2 U	2 U	2 U	1.7	3.3	0.5 U	0.5 U	5.6	14	0.5 U	0.5 U	10	25.4	68.2
Church of God	MW-23D	0.18 J	0.46 J	2 U	2 U	2 U	2 U	0.5 U	0.5 U	0.5 U	0.5 U	1.4	2.6	0.5 U	0.5 U	3	1.6 UJ	4.1 J
Church of God	MW-25D	0.22 J	0.57	2 U	2 U	0.11 UJ	2 U	0.5 U	0.5 U	0.5 U	0.5 U	1.2	1.9	0.5 U	0.5 U	11	2.1 J	5 U
Church of God	MW-26D	0.5 U	0.5 U	2 U	2 U	2 U	2 U	0.27 J	0.6	0.5 U	0.5 U	0.72	1.9	0.5 U	0.5 U	10	6.6	24.6
Church of God	MW-27D	0.5 U	0.5 U	2 U	2 U	2 U	2 U	0.5 U	0.5 U	0.5 U	0.5 U	0.46 J	0.84	0.5 U	0.5 U	9	3.8 B	12.9 UJ
Church of God	MW-49	0.05 J	0.5 U	2 U	2 U	2 U	2 U	0.27 J	1.2	0.5 U	0.5 U	1.1	5	0.5 U	0.5 U	10	9.3	55.6
Intermediate Wells	AMW-16	0.12 J	0.5 U	2 U	2 U	2 U	2 U	0.5 U	0.5 U	0.5 U	0.5 U	0.17 J	2.7	0.5 U	0.5 U	3	2.8 J	5 U
Intermediate Wells	AMW-17	0.5 U	0.5 U	0.95 J	2 U	2 U	2 U	0.07 J	1	0.5 U	0.5 U	1.1	210 D	0.5 U	0.5 U	2	2.6 B	5 U
Intermediate Wells	AMW-18	0.5 U	1 U	2 J	4 U	2 U	4 U	0.15 J	2.3	0.5 U	1 U	39	460 D	0.5 U	1 U	--	--	--
Intermediate Wells	AMW-59	7.3	32	2 U	2 U	2 U	2 U	0.5 U	0.5 U	0.63	3.3	76 D	130 D	0.27 J	7.7	2	2.6 B	5 U
Intermediate Wells	AMW-60	0.5 U	0.5 U	2 U	2 U	2 U	2 U	0.09 J	0.09 J	0.5 U	0.5 U	0.5 U	0.5 U	3.6	3.6	1	2.1 J	2.1 J
Intermediate Wells	AMW-64	0.11 J	1	0.1 UJ	2 U	2 U	2 U	0.27 J	0.33 J	0.16 J	0.5 U	110 D	190 D	0.5 U	0.5 U	--	--	--
Intermediate Wells	CPU-14	0.5 U	0.5 U	2 U	2 U	2 U	2 U	0.08 J	0.5 U	0.5 U	0.5 U	5.2	10	0.5 U	0.5 U	5	31.9	77.4
Intermediate Wells	MW-14C	0.1 J	0.5 U	2 U	2 U	2 U	2 U	0.9	2.2	0.5 U	0.5 U	11	28	0.5 U	0.5 U	10	69.6	116
Intermediate Wells	MW-14E	3.3	4.1	2 U	2 U	2 U	2 U	3.9	5	0.07 J	0.5 U	67 D	100 D	0.5 U	0.5 U	10	41.1	69.9
Intermediate Wells	MW-15E	0.06 J	0.5 U	2 U	2 U	2 U	2 U	0.22 J	0.35 J	0.5 U	0.5 U	4.2	9.9	0.5 U	0.5 U	1	3.3 J	3.3 J
Intermediate Wells	MW-16E	0.11 J	0.5 U	2 U	2 U	2 U	2 U	0.5 U	0.5 U	0.5 U	0.5 U	0.42 J	5.1	0.08 J	0.5 U	3	2.2 J	5 U
Intermediate Wells	MW-18D	0.45 J	1.2	2 U	2 U	2 U	2 U	2.3	5	0.15 J	0.5 U	47	120	0.5 U	0.5 U	10	107	224
Intermediate Wells	MW-18E	3.7	59	2 U	2 U	2 U	2 U	0.17 J	0.5 U	0.3 J	0.46 J	130	250	0.21 J	2.9	5	2.4 J	12.5
Intermediate Wells	MW-19D	0.32 J	0.67	2 U	2 U	2 U	2 U	1.8	3.3	0.5 U	0.5 U	30	53	0.5 U	0.5 U	10	102	279
Intermediate Wells	MW-20D	0.61	0.92	2 U	2 U	2 U	2 U	1.2	2	0.5 U	0.5 U	41	58	0.5 U	0.5 U	10	63.5	143
Intermediate Wells	MW-38	0.14 J	0.24 J	2 U	2 U	2 U	2 U	0.77	1.7	0.5 U	0.5 U	7.4	12	0.5 U	0.5 U	--	--	--
Intermediate Wells	MW-40	0.5 U	0.5 U	2 U	2 U	2 U	2 U	0.5 U	0.5 U	0.5 U	0.5 U	1.2	1.2	0.5 U	0.5 U	1	126	126
Intermediate Wells	PZ-39	1.1	3.2	2 U	2 U	2 U	2 U	1.5	1.7	0.5 U	0.5 U	54	99 D	0.5 U	0.5 U	2	4.8 J	6.7 UJ
Other Toe Wells	AMW-42	0.5 U	0.5 U	2 U	2 U	2 U	2 U	0.5 U	0.5 U	0.5 U	0.5 U	0.82	1.3	0.5 U	0.5 U	5	17.8	23.7
Other Toe Wells	AMW-63	0.5 U	0.5 U	2 U	2 U	2 U	2 U	0.5 U	0.5 U	0.5 U	0.5 U	0.08 UJ	0.5 U	0.5 U	0.5 U	5	6.8	19.5 UJ
Other Toe Wells	MW-31	0.5 U	0.5 U	2 U	2 U	2 U	2 U	0.12 J	0.5 U	0.5 U	0.5 U	0.2 J	0.36 J	0.5 U	0.5 U	4	8.1	12.9
Other Toe Wells	MW-35	0.5 U	0.5 U	2 U	2 U	2 U	2 U	0.41 J	0.62	0.5 U	0.5 U	4.9	6.8	0.5 U	0.5 U	8	16.5	39.6 UJ
Other Toe Wells	MW-37	0.5 U	0.5 U	2 U	2 U	2 U	2 U	0.5 U	0.5 U	0.5 U	0.5 U	0.5 U	0.5 U	0.5 U	0.5 U	1	4.1 B	4.1 B
Other Toe Wells	MW-41	0.5 U	0.5 U	2 U	2 U	2 U	2 U	0.5 U	0.5 U	0.5 U	0.5 U	0.5 U	0.5 U	0.5 U	0.5 U	6	4.4 UJ	5 U
Other Toe Wells	MW-46	0.5 U	0.5 U	2 U	2 U	2 U	2 U	0.5 U	0.5 U	0.5 U	0.5 U	0.5 U	0.5 U	0.5 U	0.5 U	4	3.5 UJ	5.6 UJ
Other Toe Wells	MW-48	0.5 U	0.5 U	2 U	2 U	2 U	2 U	0.5 U	0.5 U	0.5 U	0.5 U	0.5 U	0.5 U	0.5 U	0.5 U	2	4 B	35
Other Wells	BENNETT	1.2	3.3	2 U	2 U	2 U	2 U	0.5 U	0.5 U	0.5 U	0.5 U	3.8	10	0.5 U	0.5 U	9	5 U	5 U
Proximal	AMW-58	0.15 J	0.5 U	2 U	2 U	2 U	2 U	0.5 U	0.5 U	0.5 U	0.5 U	0.1 J	0.89	0.5 U	0.5 U	2	3.3 J	3.6 J
Proximal	EC-1	0.5 U	0.5 U	2 U	2 U	2 U	2 U	0.23 J	0.23 J	0.5 U	0.5 U	0.21 J	0.21 J	0.5 U	0.5 U	2	5 U	32.9 UJ
Proximal	MW-10B	0.07 J	0.5 U	2 U	2 U	2 U	2 U	1.2	3.5	0.5 U	0.5 U	16	28	0.5 U	0.5 U	10	34.7	67.6
Proximal	MW-10C	0.07 J	0.5 U	2 U	2 U	2 U	2 U	0.8	1.9	0.5 U	0.5 U	2.5	7.9	0.5 U	0.5 U	10	67.2	189
Proximal	MW-12C	0.08 J	0.5 U	2 U	2 U	2 U	2 U	0.55	0.7	0.5 U	0.5 U	1.4	24	0.5 U	0.5 U	3	3.7 UJ	5 U
Proximal	MW-13C	0.08 J	0.5 U	2 U	2 U	2 U	2 U	0.26 J	0.58	0.5 U	0.5 U	1.9	5.7	0.5 U	0.5 U	4	25.6	32.7

Table E3. Summary of VOCs and Chromium Concentrations, January 2008 - October 2012

Analyte (ug/L)		cis-1,2-Dichloroethene		Dichloromethane		Hexachloro-1,3-Butadiene		Tetrachloroethene		trans-1,2-Dichloroethene		Trichloroethene		Vinyl Chloride		Total Chromium		
ROD Cleanup Level (ug/L)		70 ^a		5 ^a		5 ^b		5		100 ^a		5		2 ^a		80		
Well Group	Well ID	Min	Max	Min	Max	Min	Max	Min	Max	Min	Max	Min	Max	Min	Max	# Chromium Samples	Min	Max
Proximal	MW-2A	0.5 U	0.5 U	2 U	2 U	2 U	2 U	0.75	1.5	0.5 U	0.5 U	1.7	4.7	0.5 U	0.5 U	5	66	343
Proximal	MW-2B	0.07 J	0.07 J	2 U	2 U	2 U	2 U	0.77	0.77	0.5 U	0.5 U	2.4	2.4	0.5 U	0.5 U	1	9.6	9.6
Proximal	MW-2C	0.5 U	0.5 U	2 U	2 U	2 U	2 U	0.29 J	0.29 J	0.5 U	0.5 U	0.36 J	0.36 J	0.5 U	0.5 U	1	21.4 UJ	21.4 UJ
Proximal	MW-3A	0.5 U	0.5 U	2 U	2 U	2 U	2 U	0.21 J	0.21 J	0.5 U	0.5 U	0.23 J	0.23 J	0.5 U	0.5 U	5	75.4	342
Proximal	MW-3B	0.08 J	0.5 U	2 U	2 U	2 U	2 U	0.65	0.89	0.5 U	0.5 U	2	2.3	0.5 U	0.5 U	1	15.3 UJ	15.3 UJ
Proximal	MW-4A	0.5 U	0.5 U	2 U	2 U	2 U	2 U	0.72	0.72	0.5 U	0.5 U	5.5	5.5	0.5 U	0.5 U	4	362	741
Proximal	MW-4B	0.5 U	0.5 U	2 U	2 U	2 U	2 U	0.64	1.1	0.5 U	0.5 U	4.2	7.2	0.5 U	0.5 U	5	407	634
Proximal	MW-4BSHED	0.5 U	0.5 U	2 U	2 U	2 U	2 U	1.4	1.4	0.5 U	0.5 U	4.1	4.1	0.5 U	0.5 U	1	85.9	85.9
Proximal	MW-4C	0.5 U	0.5 U	2 U	2 U	2 U	2 U	0.84	0.84	0.5 U	0.5 U	3.8	3.8	0.5 U	0.5 U	1	61	61
Proximal	MW-6A	0.5 U	0.5 U	2 U	2 U	2 U	2 U	0.5 U	0.5 U	0.5 U	0.5 U	0.5 U	0.5 U	0.5 U	0.5 U	1	167	167
Proximal	MW-6B	0.09 J	0.5 U	2 U	2 U	2 U	2 U	0.69	1.7	0.5 U	0.5 U	4.2	10	0.5 U	0.5 UJ	11	17.2	50.9
Proximal	MW-6C	0.5 U	0.5 U	2 U	2 U	2 U	2 U	0.19 J	0.19 J	0.5 U	0.5 U	0.54	0.54	0.5 U	0.5 U	1	12.3 UJ	12.3 UJ
Proximal	MW-6D	0.5 U	0.5 U	2 U	2 U	2 U	2 U	0.11 J	0.11 J	0.5 U	0.5 U	4.3	4.3	0.5 U	0.5 U	1	29.8	29.8
Proximal	MW-7B	0.5 U	0.5 U	2 U	2 U	2 U	2 U	1.3	1.3	0.5 U	0.5 U	7.3	7.3	0.5 U	0.5 U	1	9.8 UJ	9.8 UJ
Proximal	MW-7C	0.5 U	0.5 U	2 U	2 U	2 U	2 U	0.12 J	0.12 J	0.5 U	0.5 U	0.18 J	0.18 J	0.5 U	0.5 U	1	12.3	12.3
Proximal	MW-8B	0.12 J	0.5 U	2 U	2 U	2 U	2 U	1.3	2.9	0.5 U	0.5 U	2.4	6	0.5 U	0.5 U	1	7.3	7.3
Proximal	MW-9B	0.13 J	0.23 J	2 U	2 U	2 U	2 U	2	3.1	0.5 U	0.5 U	3.7	9.3	0.5 U	0.5 U	1	3.6 J	3.6 J
Proximal	MW-9C	0.5 U	0.5 U	2 U	2 U	2 U	2 U	0.35 J	0.35 J	0.5 U	0.5 U	3.8	3.8	0.5 U	0.5 U	1	65.4	65.4
Proximal	PW-1B	0.5 U	0.5 U	2 U	2 U	2 U	2 U	0.62	1.4	0.5 U	0.5 U	2.6	6.2	0.5 U	0.5 UJ	11	34.1	72.8
TCE Source	AMW-12A	0.16 J	0.29 J	2 U	2 U	2 U	2 U	0.38 J	0.68	0.5 U	0.5 U	21	38	0.5 U	0.5 UJ	--	--	--
TCE Source	AMW-13A	0.5 U	0.5 U	2 U	2 U	2 U	2 U	0.08 J	0.5 U	0.5 U	0.5 U	0.17 J	1.6	0.5 U	0.5 UJ	--	--	--
TCE Source	AMW-19A	0.5 U	0.5 U	2 U	2 U	2 U	2 U	0.3 J	0.51	0.5 U	0.5 U	1.2	1.9	0.5 U	0.5 U	--	--	--
TCE Source	AMW-19B	0.5 U	0.5 U	2 U	2 U	2 U	2 U	0.5 U	0.5 U	0.5 U	0.5 U	0.54	0.72	0.5 U	0.5 U	--	--	--
TCE Source	AMW-1A	0.07 J	0.5 U	2 U	2 U	2 U	2 U	0.12 J	1.4	0.5 U	0.5 U	0.26 J	44	0.5 U	0.5 UJ	--	--	--
TCE Source	AMW-1B	0.5 U	0.5 U	2 U	2 U	2 U	2 U	0.5 U	0.5 U	0.5 U	0.5 U	0.37 J	0.51	0.5 U	0.5 UJ	--	--	--
TCE Source	AMW-1C	0.5 U	0.5 U	2 U	2 U	2 U	2 U	0.5 U	0.5 U	0.5 U	0.5 U	0.5 U	0.5 U	0.5 U	0.5 UJ	--	--	--
TCE Source	AMW-26	0.09 J	0.5 U	2 U	2 U	2 U	2 U	0.13 J	1.5	0.5 U	0.5 U	0.2 J	2.3	0.5 U	0.5 UJ	--	--	--
TCE Source	AMW-2A	0.07 J	0.5 U	2 U	2 U	2 U	2 U	0.12 J	0.97	0.5 U	0.5 U	1.1	91 D	0.5 U	0.5 UJ	--	--	--
TCE Source	AMW-2B	0.5 U	0.5 U	2 U	2 U	2 U	2 U	0.5 U	0.5 U	0.5 U	0.5 U	0.4 J	0.69	0.5 U	0.5 UJ	--	--	--
TCE Source	AMW-3A	0.5 U	0.5 U	2 U	2 U	2 U	2 U	0.31 J	0.52	0.5 U	0.5 U	0.48 J	0.85	0.5 U	0.5 U	--	--	--
TCE Source	AMW-4A	0.5 U	0.5 U	2 U	2 U	2 U	2 U	0.5 U	0.5 U	0.5 U	0.5 U	0.16 J	0.23 J	0.5 U	0.5 UJ	--	--	--
TCE Source	AMW-52A	0.5 U	0.5 U	2 U	2 U	2 U	2 U	0.16 J	0.5 U	0.5 U	0.5 U	0.07 J	0.5 U	0.5 U	0.5 UJ	--	--	--
TCE Source	AMW-52C	0.5 U	0.5 U	2 U	2 U	2 U	2 U	0.5 U	0.5 U	0.5 U	0.5 U	0.5 U	0.5 U	0.5 U	0.5 UJ	--	--	--
TCE Source	AMW-53A	0.05 J	0.5 U	2 U	2 U	2 U	2 U	0.13 J	1.3	0.5 U	0.5 U	0.86	14	0.5 U	0.5 UJ	--	--	--
TCE Source	AMW-53B	0.5 U	0.5 U	2 U	2 U	2 U	2 U	0.5 U	0.5 U	0.5 U	0.5 U	0.53	0.56	0.5 U	0.5 UJ	--	--	--
TCE Source	AMW-53C	0.5 U	0.5 U	2 U	2 U	2 U	2 U	0.5 U	0.5 U	0.5 U	0.5 U	0.21 J	0.5 U	0.5 U	0.5 UJ	--	--	--
TCE Source	AMW-54A	0.5 U	0.5 U	2 U	2 U	2 U	2 U	0.09 J	0.44 J	0.5 U	0.5 U	0.84	2.5	0.5 U	0.5 UJ	--	--	--
TCE Source	AMW-54C	0.5 U	0.5 U	2 U	2 U	2 U	2 U	0.5 U	0.5 U	0.5 U	0.5 U	0.26 J	0.36 J	0.5 U	0.5 UJ	--	--	--
TCE Source	AMW-55A	0.5 U	0.5 U	2 U	2 U	2 U	2 U	0.16 J	0.5 U	0.5 U	0.5 U	0.48 J	1.3	0.5 U	0.5 UJ	--	--	--
TCE Source	AMW-55C	0.5 U	0.5 U	2 U	2 U	2 U	2 U	0.5 U	0.5 U	0.5 U	0.5 U	0.23 J	0.39 J	0.5 U	0.5 UJ	--	--	--
TCE Source	AMW-56A	0.5 U	0.5 U	2 U	2 U	2 U	2 U	0.09 J	0.57	0.5 U	0.5 U	0.4 J	2.7	0.5 U	0.5 UJ	--	--	--
TCE Source	AMW-56C	0.5 U	0.5 U	2 U	2 U	2 U	2 U	0.5 U	0.5 U	0.5 U	0.5 U	0.29 J	0.44 J	0.5 U	0.5 UJ	--	--	--
TCE Source	MW-1A	0.06 J	0.5 U	2 U	2 U	2 U	2 U	0.42 J	1.4	0.5 U	0.5 U	4.8	13	0.5 U	0.5 UJ	3	6.8 UJ	19.3
TCE Source	MW-1B	0.5 U	0.5 U	2 U	2 U	2 U	2 U	0.5 U	0.5 U	0.5 U	0.5 U	0.28 J	0.5 U	0.5 U	0.5 UJ	--	--	--
TCE Source	MW-1C	0.5 U	0.5 U	2 U	2 U	2 U	2 U	0.5 U	0.5 U	0.5 U	0.5 U	0.5 U	0.5 U	0.5 U	0.5 UJ	--	--	--
TCE Source	RAMW-2C	0.5 U	0.5 U	2 U	2 U	2 U	2 U	0.5 U	0.5 U	0.5 U	0.5 U	0.27 J	0.5 U	0.5 U	0.5 UJ	--	--	--

Table E3. Summary of VOCs and Chromium Concentrations, January 2008 - October 2012

Analyte (ug/L)		cis-1,2-Dichloroethene		Dichloromethane		Hexachloro-1,3-Butadiene		Tetrachloroethene		trans-1,2-Dichloroethene		Trichloroethene		Vinyl Chloride		Total Chromium		
ROD Cleanup Level (ug/L)		70 ^a		5 ^a		5 ^b		5		100 ^a		5		2 ^a		80		
Well Group	Well ID	Min	Max	Min	Max	Min	Max	Min	Max	Min	Max	Min	Max	Min	Max	# Chromium Samples	Min	Max
Toe Sentinel Wells	AMW-43	0.5 U	0.5 U	2 U	2 U	2 U	2 U	0.5 U	0.5 U	0.5 U	0.5 U	0.5 U	0.5 U	0.5 U	0.5 U	4	3.6 J	6.8
Toe Sentinel Wells	AMW-44	0.5 U	0.5 U	2 U	2 U	2 U	2 U	0.5 U	0.5 U	0.5 U	0.5 U	0.5 U	0.5 U	0.5 U	0.5 U	2	4.9 B	5 U
Toe Sentinel Wells	AMW-45	0.5 U	0.5 U	2 U	2 U	2 U	2 U	0.5 U	0.5 U	0.5 U	0.5 U	0.5 U	0.5 U	0.5 U	0.5 U	2	8	9.8
Toe Sentinel Wells	MW-30	0.5 U	0.5 U	2 U	2 U	2 U	2 U	0.5 U	0.5 U	0.5 U	0.5 U	0.5 U	0.5 U	0.5 U	0.5 U	2	3 J	5 U
Toe Sentinel Wells	MW-47	0.5 U	0.5 U	2 U	2 U	2 U	2 U	0.5 U	0.5 U	0.5 U	0.5 U	0.5 U	0.5 U	0.5 U	0.5 U	1	3.2 B	3.2 B
Troutdale	AMW-24	3.3	4.5	2 U	2 U	2 U	2 U	0.1 J	0.5 U	0.5 U	0.5 U	11	14	0.5 U	0.5 U	6	2.4 J	8.8
Troutdale	AMW-25	0.5 U	0.5 U	2 U	2 U	2 U	2 U	0.1 J	0.5 U	0.5 U	0.5 U	0.5 U	0.5 U	0.5 U	0.5 U	3	1.9 J	5 U
Troutdale	AMW-50	0.5 U	0.5 U	2 U	2 U	2 U	2 U	0.13 J	0.15 J	0.5 U	0.5 U	0.5 U	0.5 U	0.5 U	0.5 U	3	1.8 J	2.3 B
Troutdale	AMW-51	0.09 J	0.5 U	2 U	2 U	2 U	2 U	0.5 U	0.5 U	0.5 U	0.5 U	0.11 J	0.24 J	0.5 U	0.5 U	3	2.1 J	6.2
Troutdale	AMW-62	0.5 U	0.5 U	2 U	2 U	2 U	2 U	0.5 U	0.5 U	0.5 U	0.5 U	0.5 U	0.5 U	0.5 U	0.5 U	5	1.5 J	5 U
Troutdale	CPU-10	0.5 U	0.5 U	2 U	2 U	2 U	2 U	0.5 U	0.5 U	0.5 U	0.5 U	0.5 U	0.5 U	0.5 U	0.5 U	5	1 UJ	23.2
Troutdale	CPU-2	0.5 U	0.5 U	2 U	2 U	2 U	2 U	0.5 U	0.5 U	0.5 U	0.5 U	0.5 U	0.5 U	0.5 U	0.5 U	3	2 J	5 U
Troutdale	CPU-3D	0.5 U	0.5 U	2 U	2 U	2 U	2 U	0.5 U	0.5 U	0.5 U	0.5 U	0.5 U	0.5 U	0.5 U	0.5 U	3	1.8 J	3.1 J
Troutdale	MW-33	2.4	3.8	2 U	2 U	2 U	2 U	0.07 J	0.15 J	0.5 U	0.5 U	7.7	14	0.5 U	0.5 U	6	2.1 B	40.5
Troutdale	MW-34	0.5 U	0.5 U	2 U	2 U	2 U	2 U	0.5 U	0.5 U	0.5 U	0.5 U	0.5 U	0.5 U	0.5 U	0.5 U	3	0.8 J	5 U
Upgradient	AMW-10A	0.5 U	0.5 U	2 U	2 U	2 U	2 U	0.17 J	0.5 U	0.5 U	0.5 U	0.17 J	0.51	0.5 U	0.5 UJ	7	3.2 J	18.7
Upgradient	AMW-11A	0.5 U	0.5 U	2 U	2 U	2 U	2 U	0.5 U	0.5 U	0.5 U	0.5 U	0.41 J	0.66	0.5 U	0.5 UJ	7	2 J	5.9
Upgradient	AMW-5A	0.5 U	0.5 U	2 U	2 U	2 U	2 U	0.5 U	0.5 U	0.5 U	0.5 U	0.5 U	0.5 U	0.5 U	0.5 U	--	--	--
Upgradient	AMW-6A	0.5 U	0.5 U	2 U	2 U	2 U	2 U	0.5 U	0.5 U	0.5 U	0.5 U	0.38 J	0.65	0.5 U	0.5 UJ	7	5	10.9
Upgradient	AMW-7A	0.5 U	0.5 U	2 U	2 U	2 U	2 U	0.5 U	0.5 U	0.5 U	0.5 U	0.24 J	0.58	0.5 U	0.5 UJ	7	2.3 J	5 U
Upgradient	AMW-8A	0.5 U	0.5 U	2 U	2 U	2 U	2 U	0.5 U	0.5 U	0.5 U	0.5 U	0.33 J	1.4	0.5 U	0.5 U	--	--	--
Upgradient	AMW-9A	0.5 U	0.5 U	2 U	2 U	2 U	2 U	0.5 U	0.5 U	0.5 U	0.5 U	0.5 U	0.5 U	0.5 U	0.5 U	--	--	--

NOTES:

- ^a - Cleanup level not listed in ROD, MCL used for comparison
- ^b - Cleanup level not listed in ROD, MTCA B used for comparison
- Highlight indicates detected value exceeded the cleanup level
- - not analyzed
- D - Analysis at a secondary dilution factor
- J - Estimated concentration less than the Method Reporting Limit but greater than the Method Detection Limit
- U - Non-detected above the specified reporting limit
- B - Analyte found in blank as well as sample

Annual Screening Summary

Table E2. Annual Monitoring Program Screening Summary

Well Group	Well ID	Well Purpose	Conc. Statistically Below Cleanup Levels		2011 MAROS Recommended Sampling Frequency		2012 Recommended Sampling Frequency		Notes	Mann Kendall Concentration Trend (2011)	
			TCE	Chromium	TCE	Chromium	TCE	Chromium		TCE	Chromium
Church of God	AMW-14	Plume Boundary	No	No	Annual	Annual	Annual	Annual		D	D
Church of God	AMW-27	Active Extraction	No	No	Annual	Annual	Semi-Annual	Semi-Annual		D	D
Church of God	AMW-61	Plume Area	No	BCL	Annual	--	Biennial	NFS (2010)	Plume area - silt well (Cr below cleanup level)	S	--
Church of God	CFU-12	Plume Boundary	No	BCL	Annual	--	Annual	NFS (2010)	TCE Plume boundary (Cr below cleanup level)	S	--
Church of God	CPU-13	Active Extraction	No	No	Annual	Annual	Semi-Annual	Semi-Annual		D	D
Church of God	MW-21D	Active Extraction	No	No	Annual	Annual	Semi-Annual	Semi-Annual		D	D
Church of God	MW-22D	Active Extraction	No	No	Annual	Annual	Semi-Annual	Semi-Annual		D	D
Church of God	MW-23D	Plume Boundary	No	Yes (2010)	Annual	--	Annual	NFS (2010)	TCE Plume boundary; Cr statistically below cleanup level	D	
Church of God	MW-25D	Active Extraction	No	No	Annual	Annual	Semi-Annual	Semi-Annual		D	D
Church of God	MW-26D	Active Extraction	No	No	Annual	Annual	Semi-Annual	Semi-Annual		D	D
Church of God	MW-27D	Inactive Extraction	No	No	Annual	Annual	Annual	Annual		D	D
Church of God	MW-49	Active Extraction	No	No	Annual	Annual	Semi-Annual	Semi-Annual		D	D
Intermediate Wells	AMW-16	Northern Plume	No	Yes (2010)	Annual	--	Semi-Annual	NFS (2010)	Northern Plume area; Cr statistically below the cleanup level	D	--
Intermediate Wells	AMW-17	Northern Plume	No	Yes (2008)	Annual	--	Quarterly	NFS (2008)	Northern Plume monitoring well; Cr statistically below the cleanup level	D	--
Intermediate Wells	AMW-18	Northern Plume	No	Yes (2008)	Quarterly	--	Quarterly	NFS (2008)	Northern Plume monitoring well; Cr statistically below the cleanup level	I	--
Intermediate Wells	AMW-59	Inactive Extraction	No	Yes (2009)	Annual	--	Biennial	NFS (2009)	Plume area - silt well; Cr statistically below the cleanup level	S	--
<i>Intermediate Wells</i>	<i>AMW-60</i>	<i>Plume Area</i>	<i>BCL</i>	<i>BCL</i>	<i>--</i>	<i>--</i>	<i>NFS (2009)</i>	<i>NFS (2009)</i>	<i>TCE and Cr results all below cleanup level and MRL (silt well)</i>	<i>--</i>	<i>--</i>
Intermediate Wells	AMW-64	Northern Plume	NA	--	--	--	Quarterly	--	New well installed to monitor Northern Plume	--	--
Intermediate Wells	CPU-14	Plume Boundary	No	No	Annual	Annual	Annual	Annual		D	D
Intermediate Wells	MW-14C	Active Extraction	No	No	Annual	Annual	Semi-Annual	Semi-Annual	Extraction well - active (also well cluster)	D	D
Intermediate Wells	MW-14E	Active Extraction	No	No	Annual	Annual	Semi-Annual	Semi-Annual	Extraction well - active (also well cluster)	D	D
Intermediate Wells	MW-15E	Northern Plume	No	Yes (2008)	Annual	--	Semi-Annual	NFS (2008)	Northern Plume investigation area; Cr statistically below the cleanup level	D	--
Intermediate Wells	MW-18E	Plume Boundary	Yes (2011)	Yes (2010)	NFS	--	Biennial	NFS (2010)	TCE Plume boundary; Cr statistically below cleanup level	PI	--
Intermediate Wells	MW-18D	Active Extraction	No	No	Annual	Annual	Semi-Annual	Semi-Annual	Extraction well - active (also well cluster)	D	D
Intermediate Wells	MW-18E	Inactive Extraction	No	BCL	Annual	--	Annual	NFS (2010)	Plume area - TCE hotspot, Cr below cleanup level with 3 exceptions	D	--
Intermediate Wells	MW-19D	Active Extraction	No	No	Annual	Annual	Semi-Annual	Semi-Annual		D	D
Intermediate Wells	MW-20D	Active Extraction	No	No	Annual	Annual	Semi-Annual	Semi-Annual		D	D
Intermediate Wells	MW-38	Northern Plume	NA	--	NA	--	Annual	--	Northern Plume investigation area	--	--
<i>Intermediate Wells</i>	<i>MW-40</i>	<i>Plume Area</i>	<i>--</i>	<i>--</i>	<i>--</i>	<i>--</i>	<i>--</i>	<i>--</i>	<i>replaced with PZ-39</i>	<i>--</i>	<i>--</i>
Intermediate Wells	PZ-39	Northern Plume	NA	BCL	NA	--	Annual	NFS (2009)	Northern Plume investigation area, Cr never exceeded cleanup level	--	--
Other Toe Wells	AMW-42	Inactive Extraction	No	No	Annual	Annual	Biennial	Biennial	Sentinel well downgradient of MW-35 - TCE and Cr are below the cleanup level	D	D
<i>Other Toe Wells</i>	<i>AMW-63</i>		<i>Yes (2010)</i>	<i>Yes (2010)</i>	<i>--</i>	<i>--</i>	<i>NFS (2010)</i>	<i>NFS (2010)</i>		<i>--</i>	<i>--</i>
Other Toe Wells	MW-31	Inactive Extraction	No	No	Annual	Annual	Biennial	Biennial		D	D

Table E2. Annual Monitoring Program Screening Summary

Well Group	Well ID	Well Purpose	Conc. Statistically Below Cleanup Levels		2011 MAROS Recommended Sampling Frequency		2012 Recommended Sampling Frequency		Notes	Mann Kendall Concentration Trend (2011)	
			TCE	Chromium	TCE	Chromium	TCE	Chromium		TCE	Chromium
Other Toe Wells	MW-35	Inactive Extraction	No	No	Annual	Annual	Annual	Annual	Former extraction well - inactive - local TCE hot spot	D	D
Other Toe Wells	MW-37	Inactive Extraction	Yes (2008)	Yes (2008)	--	--	NFS (2008)	NFS (2008)		--	--
Other Toe Wells	MW-41	Inactive Extraction	Yes (2011)	Yes (2011)	NFS	NFS	NFS (2011)	NFS (2011)		S	S
Other Toe Wells	MW-46	Inactive Extraction	Yes (2009)	BCL	--	--	NFS (2009)	NFS (2009)	Cr never exceeded cleanup level	--	--
Other Toe Wells	MW-48	Inactive Extraction	Yes (2009)	BCL	--	--	NFS (2009)	NFS (2009)	Cr never exceeded cleanup level	--	--
Other Wells	BENNETT	Troutdale	NA	NA	NA	NA	Semi-Annual	Semi-Annual	Troutdale well - TCE impacted - CPU request for semiannual sampling	--	--
Proximal	AMW-58	Plume Area	No	Yes (2010)	Annual	--	Biennial	NFS (2010)	Plume area - silt well; Cr statistically below the cleanup level	D	--
Proximal	MW-10B	Active Extraction	No	No	Annual	Annual	Semi-Annual	Semi-Annual	Extraction well - active (also well cluster)	D	D
Proximal	MW-10C	Active Extraction	No	No	Annual	Annual	Semi-Annual	Semi-Annual	Extraction well - active (also well cluster)	D	D
Proximal	MW-12C	Plume Boundary	No	Yes (2010)	Annual	--	Biennial	NFS (2010)	TCE Plume boundary; Cr statistically below cleanup level, TCE above cleanup level	D	--
Proximal	MW-13C	Plume Boundary	No	Yes (2010)	Annual	--	Biennial	NFS (2010)	TCE Plume boundary; Cr statistically below cleanup level, TCE fluctuates above and below cleanup level	D	--
Proximal	MW-2A	Well Cluster	No	No	Annual	Annual	Biennial	Annual	Well cluster - most impacted and Cr hotspot	D	NT
Proximal	MW-2B	Well Cluster	WC	Yes (2009)	--	--	NFS (2010)	NFS (2009)		--	--
Proximal	MW-2C	Well Cluster	WC	Yes (2009)	--	--	NFS (2009)	NFS (2009)		--	--
Proximal	MW-3A	Well Cluster	Yes (2009)	No	--	Annual	NFS (2009)	Annual	Well cluster - most Cr impacted; TCE statistically below cleanup level	--	D
Proximal	MW-3B	Well Cluster	No	Yes (2009)	Annual	--	Biennial	NFS (2009)	Well cluster - most TCE impacted; Cr statistically below cleanup level	D	
Proximal	MW-3C	Well Cluster	R (2008)	Yes (2008)	--	--	NFS (2008)	NFS (2008)			
Proximal	MW-4A	Well Cluster	WC	No	--	Annual	NFS (2010)	Annual	Well cluster - not optimal depth for TCE (EPA request for annual Cr sampling)		PD
Proximal	MW-4B	Well Cluster	No	No	Annual	Annual	Biennial	Annual	Well cluster - most impacted and Cr hotspot (EPA request for annual Cr sampling)	NT	D
Proximal	MW-4B SHED	Well Cluster	WC	WC	--	--	NFS (2010)	NFS (2010)			D
Proximal	MW-4C	Well Cluster	WC	WC	--	--	NFS (2009)	NFS (2009)			
Proximal	MW-5A	Well Cluster	WC	No	--	Quarterly	NFS (2009)	Every 5 Years	Well cluster - TCE below cleanup level since 1995.		NA
Proximal	MW-6B	Active Extraction	No	No	Annual	Annual	Semi-Annual	Semi-Annual	Extraction well - active (also well cluster)	D	D
Proximal	MW-6C	Well Cluster	WC	WC	--	--	NFS (2010)	NFS (2009)			
Proximal	MW-6D	Well Cluster	WC	Yes (2009)	--	--	NFS (2010)	NFS (2009)			
Proximal	MW-7B	Well Cluster	No	BCL	Annual	--	Every 5 Years	NFS (2009)	Well cluster - adjacent to MW-4 cluster, less frequent sampling; Cr below cleanup level since 1998	D	
Proximal	MW-7C	Well Cluster	WC	WC	--	--	NFS (2009)	NFS (2009)			
Proximal	MW-8B	Plume Area	No	Yes (2009)	Annual	--	Biennial	NFS (2009)	Plume area - not included in any other category; Cr statistically below cleanup level	D	
Proximal	MW-9B	Well Cluster	No	BCL	Annual	--	Biennial	NFS (2009)	Well cluster - most TCE impacted; Cr below cleanup level since 1997	D	
Proximal	MW-9C	Well Cluster	WC	WC	--	--	NFS (2010)	NFS (2010)	Cr never exceeded cleanup level		
Proximal	PW-1B	Active Extraction	No	No	Annual	Annual	Semi-Annual	Semi-Annual		D	D

Table E2. Annual Monitoring Program Screening Summary

Well Group	Well ID	Well Purpose	Conc. Statistically Below Cleanup Levels		2011 MAROS Recommended Sampling Frequency		2012 Recommended Sampling Frequency		Notes	Mann Kendall Concentration Trend (2011)	
			TCE	Chromium	TCE	Chromium	TCE	Chromium		TCE	Chromium
TCE Source	AMW-12A	OU2 Monitoring	No	--	Annual	--	Semi-Annual	--	TCE below cleanup level	D	
TCE Source	AMW-13A	OU2 Monitoring	No	--	Annual	--	Biennial	--	TCE below cleanup level	NT	
TCE Source	AMW-19A	OU2 Monitoring	No	--	Annual	--	Biennial	--	TCE below cleanup level	D	
TCE Source	AMW-19B	OU2 Monitoring	Yes (2009)	--	NA	--	NFS (2009)	--			
TCE Source	AMW-1A	OU2 Monitoring	No	--	Annual	--	Semi-Annual	--	TCE fluctuating above and below cleanup level	D	NT
TCE Source	AMW-1B	OU2 Monitoring	BCL	--	NA	--	NFS (2010)	--	TCE below cleanup level since 1999		
TCE Source	AMW-1C	OU2 Monitoring	BCL	--	NA	--	NFS (2009)	--	TCE below cleanup level and MRL since 1997		
TCE Source	AMW-2S	OU2 Monitoring	No	--	Annual	--	Biennial	--	TCE below cleanup level	D	
TCE Source	AMW-2A	OU2 Monitoring	No	--	Annual	--	Semi-Annual	--	well cluster - most impacted (TCE above cleanup level)	D	
TCE Source	AMW-2B	OU2 Monitoring	No	--	Annual	--	Biennial	--	well cluster - less frequent sampling	PD	
TCE Source	AMW-3A	OU2 Monitoring		--	NA	--	Biennial	--	TCE below cleanup level	D	
TCE Source	AMW-4A	OU2 Monitoring	Yes (2009)	--	NA	--	NFS (2009)	--			
TCE Source	AMW-52A	OU2 Monitoring	No	--	Annual	--	Biennial	--	TCE below cleanup level	D	
TCE Source	AMW-52C	OU2 Monitoring	Yes (2009)	--	NA	--	NFS (2009)	--			
TCE Source	AMW-53A	OU2 Monitoring	No	--	Annual	--	Semi-Annual	--	TCE fluctuating above and below cleanup level	D	
TCE Source	AMW-53B	OU2 Monitoring	Yes (2009)	--	NA	--	NFS (2009)	--			
TCE Source	AMW-53C	OU2 Monitoring	Yes (2009)	--	NA	--	NFS (2009)	--			
TCE Source	AMW-54A	OU2 Monitoring	No	--	Annual	--	Biennial	--	TCE below cleanup level	PD	
TCE Source	AMW-54C	OU2 Monitoring	Yes (2009)	--	NA	--	NFS (2009)	--			
TCE Source	AMW-55A	OU2 Monitoring	No	--	Annual	--	Biennial	--	TCE below cleanup level	NT	
TCE Source	AMW-55C	OU2 Monitoring	Yes (2009)	--	NA	--	NFS (2009)	--			
TCE Source	AMW-56A	OU2 Monitoring	No	--	Annual	--	Biennial	--	TCE below cleanup level	D	
TCE Source	AMW-56C	OU2 Monitoring	Yes (2009)	--	NA	--	NFS (2009)	--			
TCE Source	MW-1A	OU2 Monitoring/ Upgradient (Cr)	No	--	Annual	--	Semi-Annual	Biennial	TCE fluctuating above and below cleanup level, also Cr background well	D	
TCE Source	MW-1B		BCL	--	NA	--	NFS (2009)	--	TCE below cleanup level and MRL since 2000		
TCE Source	MW-1C		Yes (2009)	Yes (2009)	NA	--	NFS (2009)	--			
TCE Source	RAMW-2C		Yes (2009)	--	NA	--	NFS (2009)	--			
Toe Sentinel Wells	AMW-43		Yes (2009)	Yes (2009)	--	--	NFS (2009)	NFS (2009)			
Toe Sentinel Wells	AMW-44		Yes (2008)	Yes (2008)	--	--	NFS (2008)	NFS (2008)			
Toe Sentinel Wells	AMW-45		Yes (2008)	Yes (2008)	--	--	NFS (2008)	NFS (2008)			
Toe Sentinel Wells	MW-30		Yes (2008)	Yes (2008)	--	--	NFS (2008)	NFS (2008)			
Toe Sentinel Wells	MW-47		Yes (2008)	Yes (2008)	--	--	NFS (2008)	NFS (2008)			
Troutdale	AMW-24	Troutdale-impacted	NA	NA	NA	NA	Annual	Annual			
Troutdale	AMW-25	Troutdale-unimpacted	NA	NA	NA	NA	Biennial	Biennial			
Troutdale	AMW-50	Troutdale-unimpacted	NA	NA	NA	NA	Biennial	Biennial			
Troutdale	AMW-51	Troutdale-unimpacted	NA	NA	NA	NA	Biennial	Biennial			
Troutdale	AMW-62	Troutdale-unimpacted	NA	NA	NA	NA	Biennial	Biennial			
Troutdale	CPU-10	Troutdale-unimpacted	NA	NA	NA	NA	Biennial	Biennial			
Troutdale	CPU-2	Troutdale-unimpacted	NA	NA	NA	NA	Biennial	Biennial			
Troutdale	CPU-3D	Troutdale-unimpacted	NA	NA	NA	NA	Biennial	Biennial			
Troutdale	MW-33	Troutdale-impacted	NA	NA	NA	NA	Annual	Annual			

Table E2. Annual Monitoring Program Screening Summary

Well Group	Well ID	Well Purpose	Conc. Statistically Below Cleanup Levels		2011 MAROS Recommended Sampling Frequency		2012 Recommended Sampling Frequency		Notes	Mann Kendall Concentration Trend (2011)	
			TCE	Chromium	TCE	Chromium	TCE	Chromium		TCE	Chromium
Troutdale	MW-34	Troutdale-unimpacted	NA	NA	NA	NA	Biennial	Biennial			
Upgradient	AMW-10A	Infiltration Gallery	Yes (2011)	Yes (2011)	NFS	NFS	Biennial	Biennial		PD	NT
Upgradient	AMW-11A	Infiltration Gallery					Biennial	Biennial		NT	S
Upgradient	AMW-6A	Infiltration Gallery	Yes (2011)	Yes (2011)	NFS	NFS	Biennial	Biennial		S	S
Upgradient	AMW-7A	Infiltration Gallery					Biennial	Biennial		NT	D
Upgradient	AMW-8A	Upgradient (TCE)	No	--			Annual	--	Upgradient well - check for possible offsite TCE impacts		D

NOTES:

Bold Subset of wells per area used to evaluate if concentrations remain statistically below cleanup levels. (Incorrectly referred to as an attainment well)

Italic Well no longer sampled

BCL - below cleanup level

D - decreasing

I - increasing

NFS (year) - no further sampling determination made in 'year'

NT - no trend

PD - probably decreasing

PI - probably increasing

R (year) - Redundant according to MAROS, determination in 'year'

S - stable

WC - part of well cluster, but not at optimal depth

[This page intentionally blank.]

Appendix F: Public Notice

[This page is intentionally blank]



We Want Your Input on the Boomsnub-AIRCO Superfund Site Cleanup in Vancouver, WA

The U.S. Environmental Protection Agency is preparing a Five-Year Review of the Boomsnub-AIRCO Superfund Site at 7608 NE 47th Street in Vancouver, Washington. A Five-Year Review is a comprehensive assessment of conditions at the Superfund Site. This is the third Five-Year Review of the Boomsnub AIRCO Superfund site.

The site is approximately two miles east of Interstate 5 and one mile west of Interstate 205. It includes a former chrome-plating facility and the currently operating Linde plant. Boomsnub-AIRCO became a Superfund site in 1995.

This review assesses whether the soil and groundwater cleanup at this site continues to protect people and the environment. During the initial cleanup, we removed contaminated soil from the site and constructed a groundwater treatment system to remove pollutants from groundwater under the site. Linde continues to operate the groundwater treatment system under EPA oversight.

You Can Get Involved!

EPA welcomes your participation during our review that will take place until May 1, 2013. If you have information that may help us, contact Claire Hong, EPA Project Manager, at hong.claire@epa.gov or 206-553-1813.

TDD/TDY users may call the Federal Relay Service at 1-800-877-8339 and give the operator Claire Hong's phone number.

[This page is intentionally blank]