

# Guidance Report

Diagnostic Tools For Performance Evaluation of Innovative  
In-Situ Remediation Technologies at Chlorinated  
Solvent-Contaminated Sites

ESTCP Project ER-200318

November 2011

Michael Kavanaugh  
Rula Deeb  
**Malcolm Pirnie, Inc.**

*This document has been cleared for public release*



**REPORT DOCUMENTATION PAGE***Form Approved  
OMB No. 0704-0188*

The public reporting burden for this collection of information is estimated to average 1 hour per response, including the time for reviewing instructions, searching existing data sources, gathering and maintaining the data needed, and completing and reviewing the collection of information. Send comments regarding this burden estimate or any other aspect of this collection of information, including suggestions for reducing the burden, to the Department of Defense, Executive Services and Communications Directorate (0704-0188). Respondents should be aware that notwithstanding any other provision of law, no person shall be subject to any penalty for failing to comply with a collection of information if it does not display a currently valid OMB control number.

**PLEASE DO NOT RETURN YOUR FORM TO THE ABOVE ORGANIZATION.**

<b>1. REPORT DATE (DD-MM-YYYY)</b>		<b>2. REPORT TYPE</b>		<b>3. DATES COVERED (From - To)</b>	
<b>4. TITLE AND SUBTITLE</b>				<b>5a. CONTRACT NUMBER</b>	
				<b>5b. GRANT NUMBER</b>	
				<b>5c. PROGRAM ELEMENT NUMBER</b>	
<b>6. AUTHOR(S)</b>				<b>5d. PROJECT NUMBER</b>	
				<b>5e. TASK NUMBER</b>	
				<b>5f. WORK UNIT NUMBER</b>	
<b>7. PERFORMING ORGANIZATION NAME(S) AND ADDRESS(ES)</b>				<b>8. PERFORMING ORGANIZATION REPORT NUMBER</b>	
<b>9. SPONSORING/MONITORING AGENCY NAME(S) AND ADDRESS(ES)</b>				<b>10. SPONSOR/MONITOR'S ACRONYM(S)</b>	
				<b>11. SPONSOR/MONITOR'S REPORT NUMBER(S)</b>	
<b>12. DISTRIBUTION/AVAILABILITY STATEMENT</b>					
<b>13. SUPPLEMENTARY NOTES</b>					
<b>14. ABSTRACT</b>					
<b>15. SUBJECT TERMS</b>					
<b>16. SECURITY CLASSIFICATION OF:</b>			<b>17. LIMITATION OF ABSTRACT</b>	<b>18. NUMBER OF PAGES</b>	<b>19a. NAME OF RESPONSIBLE PERSON</b>
<b>a. REPORT</b>	<b>b. ABSTRACT</b>	<b>c. THIS PAGE</b>			<b>19b. TELEPHONE NUMBER (Include area code)</b>

# TABLE OF CONTENTS

<b>Tables</b> .....	<b>v</b>
<b>Figures</b> .....	<b>v</b>
<b>Appendices</b> .....	<b>vi</b>
<b>Acronyms</b> .....	<b>vii</b>
<b>Acknowledgements</b> .....	<b>x</b>
<b>Executive Summary</b> .....	<b>xii</b>
<b>1.0 Introduction</b> .....	<b>1</b>
1.1. ESTCP Project ER-0318 Description .....	1
1.1.1. <i>Watervliet Arsenal</i> .....	1
1.1.2. <i>Vandenberg Air Force Base</i> .....	2
1.1.3. <i>Fort Lewis Logistics Center</i> .....	2
1.2. Report Organization .....	3
<b>2.0 Background on Diagnostic Tools</b> .....	<b>4</b>
2.1. Conventional Investigation and Remediation Approaches .....	5
2.1.1. <i>Site Remediation – The Typical Process</i> .....	5
2.1.2. <i>Geologic Settings</i> .....	8
2.1.3. <i>Regulatory Requirements</i> .....	9
2.1.4. <i>Remedial Technologies</i> .....	10
2.2. Diagnostic Tools .....	11
2.2.1. <i>Key Drivers for the Development of Diagnostic Tools</i> .....	11
2.2.2. <i>Process versus Performance Monitoring</i> .....	12
2.2.3. <i>Innovative Diagnostic Tools for Site Characterization and Process and Performance Monitoring</i> .....	13
2.2.4. <i>Diagnostic Tools Evaluated in This Study</i> .....	15
2.2.5. <i>Utility of Diagnostic Tools for Optimization of Remedial Strategies for Chlorinated Solvent Sites</i> .....	18
<b>3.0 Multi-Level Monitoring Systems</b> .....	<b>20</b>
3.1. Description of Multi-Level Monitoring Systems .....	20
3.1.1. <i>Water FLUTe™ system</i> .....	21
3.1.2. <i>CMT® System</i> .....	23
3.1.3. <i>Waterloo System</i> .....	25
3.1.4. <i>Westbay System</i> .....	26
3.1.5. <i>ZIST™ system</i> .....	28
3.2. Status of Multi-Level Monitoring Systems .....	30
3.2.1. <i>Cost</i> .....	30
3.2.2. <i>Regulatory Acceptance</i> .....	32
3.3. Applicable Site Settings and Remedial Technologies.....	32
3.4. Advantages and Disadvantages Compared with Other Available Approaches .....	33
3.5. Summary .....	34
<b>4.0 Rock Matrix Characterization</b> .....	<b>35</b>
4.1. Description of Rock Matrix Characterization .....	35
4.2. Status of Rock Matrix Characterization .....	37
4.2.1. <i>Applications to Date</i> .....	37

4.2.2.	<i>Commercial Status</i> .....	38
4.2.3.	<i>Cost</i> .....	38
4.3.	Applicable Site Settings and Remedial Technologies.....	38
4.4.	Advantages and Disadvantages Compared with Other Available Approaches .....	38
4.5.	Summary .....	39
<b>5.0</b>	<b>Mass Flux Measurement Tools .....</b>	<b>41</b>
5.1.	Description of Mass Flux Measurement Techniques.....	41
5.1.1.	<i>Strategy for Improving Mass Discharge/Mass Flux Estimates and Reducing Costs</i> ..	44
5.1.2.	<i>Synoptic Sampling</i> .....	45
5.1.3.	<i>Passive Flux Meters</i> .....	46
5.1.4.	<i>Steady-State Pumping</i> .....	48
5.1.5.	<i>Recirculation Flux Measurement</i> .....	51
5.1.6.	<i>Integral Pumping Tests</i> .....	52
5.1.7.	<i>Modified Integral Pumping Tests</i> .....	53
5.2.	Status of Mass Flux/Mass Discharge Measurement Techniques .....	53
5.2.1.	<i>Technology Development</i> .....	53
5.2.2.	<i>Applications to Date</i> .....	55
5.2.3.	<i>Commercial Status</i> .....	55
5.2.4.	<i>Cost</i> .....	59
5.2.5.	<i>Regulatory Acceptance</i> .....	64
5.3.	Applicable Site Settings .....	65
5.3.1.	<i>Type and Distribution of Target Solute</i> .....	65
5.3.2.	<i>Geology</i> .....	66
5.3.3.	<i>Hydrologic Conditions</i> .....	67
5.3.4.	<i>Existing Site Infrastructure</i> .....	68
5.3.5.	<i>Time Constraints</i> .....	68
5.3.6.	<i>Waste Generation and Disposal Considerations</i> .....	68
5.4.	Advantages and Disadvantages Compared with Other Available Approaches to Plume Monitoring .....	68
5.5.	Summary .....	80
<b>6.0</b>	<b>Compound Specific Isotope Analysis .....</b>	<b>82</b>
6.1.	Description of Compound Specific Isotope Analysis .....	82
6.1.1.	<i>Introduction to Stable Isotopes</i> .....	82
6.1.2.	<i>Stable Isotope Fractionation</i> .....	83
6.1.3.	<i>Compound Specific Isotope Analysis Applications at Chlorinated Solvent Sites</i> .....	84
6.2.	Status of Compound Specific Isotope Analysis .....	89
6.2.1.	<i>Applications to Date</i> .....	89
6.2.2.	<i>Commercial Status and Cost</i> .....	89
6.2.3.	<i>Regulatory Acceptance</i> .....	90
6.3.	Applicable Site Settings and Remedial Technologies.....	90
6.4.	Advantages and Disadvantages Compared with Other Available Approaches .....	90
6.5.	Summary .....	91
<b>7.0</b>	<b>Molecular Biological Tools.....</b>	<b>92</b>
7.1.	Background on Molecular Biological Tools .....	92
7.2.	Principles of Molecular Biological Tools .....	93
7.2.1.	<i>Gene-Based Analyses</i> .....	94

7.2.2.	<i>Phospholipid Fatty Acid Analysis</i> .....	96
7.2.3.	<i>Protein-Based Analyses</i> .....	97
7.3.	Context for Use of Molecular Biological Tools for Bioremediation .....	97
7.4.	Status of Molecular Biological Tools.....	98
7.4.1.	<i>Aerobic Oxidation</i> .....	98
7.4.2.	<i>Aerobic Cometabolism</i> .....	98
7.4.3.	<i>Halo-respiration/Anaerobic Cometabolism</i> .....	99
7.4.4.	<i>Methanogenesis</i> .....	100
7.4.5.	<i>Summary of Advantages</i> .....	101
7.4.6.	<i>Summary of Disadvantages</i> .....	101
7.5.	Advantages and Disadvantages Compared with Other Available Approaches .....	102
7.5.1.	<i>Commercial Status</i> .....	108
7.5.2.	<i>Cost</i> .....	109
7.5.3.	<i>Regulatory Acceptance</i> .....	109
7.6.	Summary .....	109
<b>8.0</b>	<b>Value Added Through the Application of Innovative Diagnostic Tools at Chlorinated Solvent Sites</b> .....	<b>111</b>
8.1.	Introduction .....	111
8.2.	Bases for Selection of Innovative Diagnostic Tools .....	113
8.3.	Multi-Level Monitoring Systems .....	115
8.3.1.	<i>Field Results</i> .....	116
8.3.2.	<i>Attributes for Selection</i> .....	119
8.3.3.	<i>Recommendations</i> .....	120
8.4.	Rock Matrix Characterization .....	121
8.4.1.	<i>Field Results</i> .....	122
8.4.2.	<i>Attributes for Selection</i> .....	122
8.4.3.	<i>Recommendations</i> .....	123
8.5.	Mass Flux Measurement .....	124
8.5.1.	<i>Field Results – Mass Flux Measurement</i> .....	124
8.5.2.	<i>Attributes for Selection</i> .....	126
8.5.3.	<i>Recommendations</i> .....	127
8.6.	Compound Specific Isotope Analysis .....	130
8.6.1.	<i>Field Results</i> .....	131
8.6.2.	<i>Attributes for Selection</i> .....	134
8.6.3.	<i>Recommendations</i> .....	135
8.7.	Molecular Biological Tools.....	136
8.7.1.	<i>Field Results</i> .....	137
8.7.2.	<i>Attributes for Selection</i> .....	138
8.7.3.	<i>Recommendations</i> .....	139
8.8.	Summary .....	140
	<b>References</b> .....	<b>144</b>

## TABLES

Table 2-1. Field Sites for Evaluation of Diagnostic Tools .....	5
Table 2-2. Five General Hydrogeologic Settings as Proposed by the National Research Council	9
Table 2-3. Life-Cycle of a Contaminated Site: Key Issues for Diagnostic Tools .....	11
Table 2-4. Recent Documents Addressing Chlorinated Solvent Site Characterization.....	14
Table 2-5. Potential Applicability of Diagnostic Tools to Stages of the Remedial Process.....	16
Table 2-6. Applicability of Diagnostic Tools to General Hydrogeologic Settings.....	16
Table 2-7. Applicability of Diagnostic Tools to Selected Generic Remedial Technologies .....	17
Table 2-8. Process Mechanisms and Diagnostic Tools .....	19
Table 3-1. Initial Capital Cost Comparisons for ZIST™ and Multi-Level Monitoring Systems.	32
Table 5-1. Mass Flux/Mass Discharge Measurement Methods.....	44
Table 5-2. Summary of Mass Flux Applications.....	56
Table 5-3. Cost Components of Mass Discharge Measurement Methods* .....	60
Table 5-4. Comparison of Mass Discharge Measurement Methods.....	71
Table 6-1. Compound Specific Isotope Analysis Applications at Chlorinated Solvent Sites .....	84
Table 7-1. Cometabolic Systems and Associated Functional Genes with References to Developed MBT .....	99
Table 7-2. Summary of Current Molecular Biological Tools for Monitoring/Diagnosing Remediation of Chlorinated Solvents .....	104
Table 7-3. Commercial Status of Molecular Biological Tools for Monitoring/Diagnosing Bioremediation.....	108
Table 7-4. Estimated Costs for Molecular Biological Tool Assays.....	109
Table 8-1. Performance Evaluation of Multiple Multi-Level Monitoring Systems at Watervliet Arsenal .....	118
Table 8-2. Applicability of Mass Flux Measurement Methods in Various Hydrogeologic Settings .....	130
Table 8-3. Example Compound Specific Isotope Analysis Data from Watervliet Arsenal Pilot Study .....	133
Table 8-4. Summary of Evaluation of Value of Information Attributes.....	141
Table 8-5. Recommendations for Application of Innovative Diagnostic Tools at Chlorinated Solvent-Contaminated Sites.....	142
Table 8-6. Applicability of Innovative Diagnostic Tools at Chlorinated Solvent Sites .....	143

## FIGURES

Figure 2-1. Conceptual Overview of Typical Remedial Process for Contaminated Sites.....	7
Figure 2-2. Six-Step Process for Source Remediation.....	10
Figure 3-1. Water FLUTE™ Schematic.....	22
Figure 3-2. Water FLUTE™ Installation at the Watervliet Arsenal .....	23
Figure 3-3. CMT® System Monitoring Port .....	24
Figure 3-4. Waterloo System .....	25
Figure 3-5. Westbay System with Monitoring Ports .....	27
Figure 3-6. ZIST™ System Schematic of Pump and/or Sensor Docked.....	29
Figure 5-1. Synoptic Sampling of Wells along a Transect .....	46

Figure 5-2. Passive Flux Meter Method .....	47
Figure 5-3. Steady-State Pumping of a Well or Wells along a Transect .....	49
Figure 5-4. Recirculation Flux Measurement Method.....	52
Figure 5-5. Impact of Source Heterogeneity on Contaminant Flow Paths .....	66
Figure 5-6. Plan View Illustration of the Effect of Geologic Heterogeneity on Contaminant Flow Paths.....	67
Figure 6-1. Compound Specific Isotope Analysis and Degradation.....	86
Figure 7-1. Hierarchy of Relationship between Molecular Biological Tools and the Activity of Interest, Biological Degradation .....	93
Figure 8-1. Results of Compound Specific Isotope Analysis at Fort Lewis.....	132

## **APPENDICES**

<b>Appendix A</b>	Points of Contact
<b>Appendix B</b>	Product Vendors
<b>Appendix C</b>	Overview of Important Biological Remediation Processes
<b>Appendix D</b>	Case Studies: Use of Molecular Biological Tools

## ACRONYMS

3-D	Three-dimensional
AFB	Air Force Base
AFCEE	United States Air Force Center for Engineering and the Environment
ARAR	Applicable or relevant and appropriate requirements
ASTM	Formerly the American Society for Testing and Materials, now known as ASTM International
bgs	Below ground surface
bp	Base pair
BTEX	Benzene, toluene, ethylbenzene, xylenes
bvcA	Putative vinyl chloride reductase
CFB	Canadian Forces Base
CMT <sup>®</sup>	Continuous Multichannel Tubing (Solinst Canada Ltd.)
COD	Chemical oxygen demand
COREDFN <sup>™</sup>	Characterization of Rock Environments – Discrete Fracture Network Approach (Stone Environmental, Inc.)
CPT	Cone penetrometer testing
CSIA	Compound specific isotope analysis
CSM	Conceptual site model
CVOC	Chlorinated volatile organic compound
DCA	Dichloroethane
DCE	Dichloroethene
DGGE	Denaturing gradient gel electrophoresis
DHC	Dehalococcoides
DNA	Deoxyribonucleic acid
DNAPL	Dense non-aqueous phase liquid
DoD	United States Department of Defense
DP	Direct push
EAP	Enzyme activity probe
EC	Electrical conductivity
EMD	Environmental molecular diagnostics
EMD Team	Environmental Molecular Diagnostics team
ERD	Enhanced reductive dechlorination
ESTCP	Environmental Security Technology Certification Program
Fe	Iron
FISH	Fluorescence in-situ hybridization
FLUTE	Flexible Liner Underground Technologies, LLC
INCORE	Integrated Concept for Groundwater Remediation
IPT	Integral pumping test
ISCO	In-situ chemical oxidation
ITRC	Interstate Technology and Regulatory Council
LTM	Long-term monitoring
MBT	Molecular biological tool
MCL	Maximum contaminant level
mcrA	Methyl coenzyme M reductase A



MIPT	Modified integral pumping test
MLM system	(General Purpose) Multi-level monitoring systems
Mn	Manganese
MNA	Monitored natural attenuation
mRNA	Messenger ribonucleic acid
MTBE	Methyl tertiary butyl ether
MW	Monitoring well
NAPL	Non-aqueous phase liquid
NFA	No Further Action
NGWA	National Ground Water Association
NRC	National Research Council
PAHs	Polyaromatic hydrocarbons
PCBs	Polychlorinated biphenyls
PCE	Tetrachloroethene
PCR	Polymerase chain reaction
PFM	Passive flux meter
PLFA	Phospholipid fatty acid
PRB	Permeable reactive barrier
PVC	Polyvinyl chloride
qPCR	Quantitative polymerase chain reaction
RAO	Remedial action objective
RCRA	Resource Conservation and Recovery Act
RFM	Recirculation flux measurement
RNA	Ribonucleic acid
rRNA	Ribosomal ribonucleic acid
ROD	Record of Decision
SB	Soil boring
SERDP	Strategic Environmental Research and Development Program
sMMO	Soluble methane monooxygenase
SSP	Steady-state pumping
TAN	Test Area North (at Idaho National Laboratory)
TCA	Trichloroethane
TCE	Trichloroethene
tceA	Trichloroethene reductive dehalogenase
TI	Technical impracticability
T-RF	Terminal restriction fragment
T-RFLP	Terminal restriction fragment length polymorphism
TSF	Technical Support Facility (at the Idaho National Laboratory)
USEPA	United States Environmental Protection Agency
USGS	United States Geological Survey
UST	Underground storage tank
VC	Vinyl chloride
vcrA	Vinyl chloride reductase
VFA	Volatile fatty acid
VOC	Volatile organic compounds
VOI	Value-of-information

ZIST™      Zone Isolation Sampling Technology (BESST, Inc.)

## ACKNOWLEDGEMENTS

This research was funded primarily by the Environmental Security Technology Certification Program (ESTCP). Seed funding for early characterization and other initial work at Vandenberg Air Force Base (AFB) was provided by the American Petroleum Institute. In addition, Geomatrix Consultants (Costa Mesa and Oakland, California) provided monetary support and field assistance at Vandenberg AFB.

This research was the result of efforts of many people from the following institutions:

- Air Force Institute of Technology: Dr. Mark Goltz, Dr. Junqi Huang
- California Regional Water Quality Control Board, San Luis Obispo, staff: Carol Kolb, Bill Meece, Kristina Seley, and Linda Stone
- ESTCP: Dr. Andrea Leeson, Dr. Hans Stroo
- Fort Lewis Public Works: James Gillie, Richard Wilson (now with the United States (U.S.) Army Corps of Engineers, Seattle District)
- Malcolm Pirnie, Inc. (now ARCADIS): Ken Goldstein (now with The Louis Berger Group, Inc.), Elisabeth L. Hawley, Daria Navon, Dr. Jennifer Nyman, Robert O'Laskey, and Andrew Vitolins
- Murray Einarson, PG, CEG, CHG, AMEC Geomatrix (formerly of Einarson & Associates)
- North Wind, Inc.: Dr. Tamzen Macbeth, Dr. Kent Sorenson (both now with CDM)
- New York State Department of Environmental Conservation: Larry Rosenmann
- U.S. Army Corps of Engineers: Grant Anderson, Kira Lynch (now with U.S. Environmental Protection Agency Region 10), Travis Shaw, Richard Smith, and Steven Wood
- U.S. Army Environmental Command: Laurie Haines, Ira May, and Mike Truex (Pacific Northwest National Laboratory)
- U.S. Environmental Protection Agency (USEPA): Dr. Michael Brooks, Dr. Lynn Wood
- U.S. Geological Survey: Frederick Paillet, John Williams
- University of California at Davis (UC Davis) and UC Davis field site employees: Irina Chakraborty, Dr. Sham Goyal, Sunitha Gurushinge, Larry Justice, Max Justice, Dr. Phil Kaiser, Chloe Lucado, Dr. Doug Mackay, Veronica Morales, Dr. Mamie Nozawa-Inoue, Anthony Parker, Dr. Kate Scow, and Madalena Velasco
- University of Florida: Dr. Michael Annable, Dr. Kirk Hatfield
- University of New Brunswick: Dr. Tom Al
- University of Waterloo: Dr. Ramon Aravena, Steven Chapman\*, Dr. John Cherry\*, Maria Gorecka\*, and Dr. Beth Parker\* (\*now with University of Guelph)

- Vandenberg AFB: Andy Edwards, Kathy Gerber, Ron MacLelland, Pablo Martinez, Mike McElligott, and Craig Nathe
- Watervliet Arsenal: JoAnn Kellogg

The authors sincerely extend their thanks to each contributor for their time and effort. Their thoughtful prior work at the sites, reviews of project documents, support, contributions to this guidance document, and coordination contributed to the overall success of the project. In particular, those who contributed written sections to this report are recognized:

- Malcolm Pirnie, Inc. (now ARCADIS): Elisabeth L. Hawley, Daria Navon, Dr. Jennifer Nyman, and Andrew Vitolins
- Murray Einarson, PG, CEG, CHG, AMEC Geomatrix (formerly of Einarson & Associates)
- North Wind, Inc.: Dr. Tamzen Macbeth (now with CDM)
- UC Davis: Dr. Doug Mackay

This project represented an independent, scientific evaluation of five types of diagnostic tools for chlorinated solvent sites. The authors of this report were not biased by business or vendor interests in their evaluation of the tools.

## EXECUTIVE SUMMARY

This report discusses a wide range of innovative diagnostic tools for characterization and remedial performance assessment at chlorinated solvent-contaminated sites. The uncertainty faced by practitioners while making decisions regarding remediation at such sites is a significant challenge, as is the decision of whether to expend additional resources to use one or more new diagnostic tools to decrease that uncertainty. This project was an effort to test certain tools and then develop qualitative guidelines regarding the value of information provided by those tools.

### Introduction

Despite more than 40 years of experience, groundwater industry professionals still face many technical, economic, and regulatory challenges for cleanup of contaminated soil and groundwater in the U.S. and worldwide. Over the past decade, however, considerable investment in innovative diagnostic tools has raised expectations that contaminated soil and groundwater at many sites can now be characterized and remediated or restored to concentrations that allow for unrestricted beneficial use of the damaged resource. This summary report captures the lessons learned from the testing of five diagnostic tools at three field demonstrations as part of this project funded by Environmental Security Technology Certification Program (ESTCP). These lessons learned are intended to provide the Department of Defense (DoD) with technical guidance on the use of these and other diagnostic tools at chlorinated solvent-contaminated sites for site characterization and process and performance assessment of in-situ technologies.

Three demonstration sites were chosen for this study including (1) Watervliet Arsenal, New York, (2) Vandenberg Air Force Base (VAFB), California and (3) Fort Lewis Logistics Center, Washington. The sites illustrate some of the types of remedial challenges faced at a number of DoD sites nationwide, and are located in distinctly different hydrogeologic environments. In-situ chemical and biological remediation technologies were implemented at two of these sites to address soil and groundwater impacted by chlorinated solvents and other volatile organic compounds (VOCs), providing the opportunity to evaluate a variety of conventional and innovative diagnostic tools for a range of data objectives. A range of innovative diagnostic tools for quantifying the success of in-situ remedial technologies was tested and assessed at these three sites (Table ES-1).

The five diagnostic tools evaluated by this study are capable of evaluating the following site characterization and remedial performance assessment issues, which are each partly geology-, contaminant-, or technology-specific:

- Vertical distribution of contaminants in the dissolved and adsorbed phase through the use of multi-level monitoring systems.
- Assessment of distribution of chlorinated solvents in consolidated media and performance assessment of in-situ technologies with rock matrix characterization.
- Confirmation of in-situ chemical or biological transformations of chemicals of concern via compound specific isotope analysis (CSIA).
- Comparison of mass flux/mass discharge measurement technologies for both process and performance assessment.

- Optimizing process performance of in-situ bioremediation through the use of molecular biological tools (MBTs).

**Table ES-1. Field Sites for Evaluation of Diagnostic Tools**

Diagnostic Tool	Field Site		
	<i>Watervliet Arsenal</i>	<i>Vandenberg AFB</i>	<i>Fort Lewis</i>
<b>Multi-Level Monitoring Systems</b>	✓		✓
<b>Rock Matrix Characterization</b>	✓		
<b>Mass Flux Measurement</b>			
<i>Passive flux meter</i>		✓	✓
<i>Transect method</i>	✓	✓	✓
<i>Steady-state pumping</i>		✓	
<i>Recirculation flux measurement</i>		✓	
<i>Integral pumping test</i>	✓		
<b>Compound Specific Isotope Analysis</b>	✓		✓
<b>Molecular Biological Tools</b>			✓

### Background on the Field Sites

Watervliet Arsenal, located in Watervliet, New York, is a 140-acre government-owned installation that was used to manufacture small arms ammunition, cannons, and guns since the mid-1800s. The primary contaminants are tetrachloroethene (PCE), trichloroethene (TCE), and their degradation products. The concentrations of these VOCs indicated the presence of dense non-aqueous phase liquids (DNAPLs). The remedial technology used at Watervliet Arsenal was in-situ chemical oxidation (ISCO) using permanganate.

VAFB is located along the Pacific Coast in Santa Barbara County, California. VAFB's Site 60 is located in a small canyon at the southern edge of the east-west-oriented Santa Ynez Valley. A well-characterized area with existing infrastructure within Site 60 was chosen for controlled injection of bromide, which is commonly used as a conservative tracer compound because its fate and transport are not affected by microbial degradation or geochemistry. This setting provided a suitable geologic setting for the comparison of four different diagnostic tools capable of measuring mass flux.

At the East Gate Disposal Yard at the Fort Lewis Logistics Center in Pierce County, Washington, chlorinated solvent source areas caused by landfill trenching and disposal at this site are underlain by glacial deposits ranging from sandy gravels with frequent cobbles to glacial till (gravel in a matrix of sand, silt, and clay) interspersed locally with lenses of sand, silty sand, and clay. Groundwater is located approximately 10 ft bgs, and residual TCE DNAPL is believed to be present to depths of about 40 ft bgs. At this particular source area within the Disposal Yard, an in-situ bioremediation technology was employed to reduce the extent of chlorinated solvent contamination. Cheese whey was chosen as the electron donor compound to enhance the anaerobic degradation of the target compounds.

## **Background on Diagnostic Tools**

Diagnostic tools satisfy a critical need in the cleanup of contaminated sites. These tools provide data needed to optimize the cleanup process, with the goals of meeting all remedial action objectives (RAOs) while reducing life-cycle costs.

At contaminated sites, a wide range of technologies has been developed to address the cleanup of contaminated groundwater. Aside from the widely used “pump-and-treat” technology, in-situ technologies have become the primary option for source and plume cleanup (USEPA, 2003; National Research Council [NRC], 2004; ITRC, 2004; Kavanaugh and Kresic, 2008). These include chemical oxidation and reduction technologies, microbially-mediated oxidation or reduction technologies, and thermal technologies. Diagnostic tools are needed to optimize the operations of each of these, and to ensure that they achieve the desired RAOs. In contrast to ex-situ technologies which have well-defined influent and effluent streams allowing for convenient process monitoring and control (e.g., granular activated carbon systems), in-situ technologies are installed in complex and highly heterogeneous subsurface environments. This complicates monitoring strategies because of the potential for inaccurate results if the monitoring systems are placed in locations that do not reflect the controlling processes in the subsurface. It has been established that in both unconsolidated and consolidated media, preferential flow paths are the norm and not the exception (see, for example, Payne et al., 2008; Sale et al., 2008).

In addition to hydrogeologic complexities in the subsurface, monitoring of in-situ remedies is further complicated by the diversity of microbial populations in the subsurface, the spatial variability of geochemical properties (e.g., pH, oxidation-reduction potential, temperature, chemical speciation), and the complex distribution and orientation of any NAPLs (i.e., the so-called “architecture” in the subsurface, for example NAPL pools or vertically distributed ganglia). This complexity results in the need to develop diagnostic tools that address site-specific features. These features can be technology-, geology-, or chemical-specific. Examples include MBTs for in-situ bioremediation, rock coring tools for consolidated media and tools for characterizing the nature and extent of NAPLs. Other useful diagnostic tools include technologies to demonstrate that chemical or biological transformations are occurring in the subsurface at rates that can result in accelerated cleanup. CSIA is the best example of such an innovative diagnostic tool.

The applicability of the diagnostic tools of this study to various steps in the remedial process, hydrogeologic settings, and remedial technologies are indicated in Table ES-2, Table ES-3, and Table ES-4, respectively.

**Table ES-2. Potential Applicability of Diagnostic Tools to Stages of the Remedial Process**

Diagnostic Tool	Remedial Process				
	Site Characterization	Remedy Selection	Remedy Design	Troubleshooting/Optimization	Final Site Management
<b>Multi-Level Monitoring Systems</b>	✓		✓	✓	✓
<b>Rock Matrix Characterization</b>	✓	✓	✓	✓	✓
<b>Mass Flux Measurement</b>					
<i>Synoptic sampling (transect method)</i>	✓	✓	✓	✓	✓
<i>Steady-state pumping (SSP)</i>	✓	✓	✓		✓
<i>Passive flux meter (PFM)</i>	✓	✓	✓		
<i>Recirculation flux measurement (RFM)</i>	✓	✓	✓		✓
<b>Compound Specific Isotope Analysis</b>	✓			✓	
<b>Molecular Biological Tools</b>				✓	✓

**Table ES-3. Applicability of Diagnostic Tools to General Hydrogeologic Settings**

Diagnostic Tool	Hydrogeologic Setting				
	I	II	III	IV	V
	Granular Media with Mild Heterogeneity and Moderate to High Permeability	Granular Media with Mild Heterogeneity and Low Permeability	Granular Media with Moderate to High Heterogeneity	Fracture Media with Low Matrix Porosity	Fracture Media with High Matrix Porosity
<b>Multi-Level Monitoring Systems</b>	✓	✓	✓	✓	✓
<b>Rock Matrix Characterization</b>				✓	✓
<b>Mass Flux Measurement</b>					
<i>Synoptic sampling (transect method)</i>	✓	✓	✓	✓	✓
<i>SSP</i>	✓	✓		✓	✓
<i>PFM</i>	✓	✓	✓		
<i>RFM</i>	✓	✓			
<b>Compound Specific Isotope Analysis</b>	✓	✓	✓	✓	✓
<b>Molecular Biological Tools</b>	✓	✓	✓	✓	✓

Note: See NRC, 2005 for detailed descriptions of generic geologic settings



**Table ES-4. Applicability of Diagnostic Tools to Selected Generic Remedial Technologies**

Diagnostic Tool	Applicable Generic Remedial Technology			
	Groundwater Extraction and Treatment	In-Situ Chemical Oxidation	In-Situ Bioremediation	Thermal Treatment
<b>Multi-Level Monitoring Systems</b>	✓	✓	✓	✓
<b>Rock Matrix Characterization</b>		✓	✓	✓
<b>Mass Flux Measurement (all types)</b>	✓	✓	✓	✓
<b>Compound Specific Isotope Analysis</b>		✓	✓	
<b>Molecular Biological Tools</b>			✓	

**Advantages of Diagnostic Tools**

Collectively, important potential advantages of these diagnostic tools include the following:

- A more accurate and detailed conceptual site model (CSM), which can result in optimum selection and design of in-situ remedies
- More accurate performance assessment in real time, resulting in more efficient operation of the remedy or optimization of the remedy after remedy installation
- Assessment of the feasibility of achieving certain endpoints, such as background concentrations or maximum contaminant levels (MCLs) in groundwater that is defined as a potential source of drinking water
- Confirmation of in-situ processes that result in transformation of the chemicals of concern to non-toxic byproducts (e.g., by using CSIA or MBTs) and estimates of the rate of transformation
- Alternative and often more meaningful metrics for performance assessment (e.g., mass flux-mass discharge)

**Value of Information (VOI) Analysis**

Application of these diagnostic tools generally requires additional investment beyond that necessary for conventional characterization and performance assessment tools. Thus, a significant challenge is determining the value proposition for the use of these tools.

One of the most significant challenges in the cleanup of chlorinated solvent-contaminated sites is determining whether the degree of uncertainty in the values of relevant physical, chemical, and/or biological parameters is sufficiently small such that decision-makers are reasonably confident of making remediation and/or site closure decisions based on site data. Determining whether additional information is needed to enhance the quality of site decisions is a primary function of site stakeholders. In simple terms, one must decide whether the expense of using alternative diagnostic tools provides sufficient value to warrant their use. This is a classic “Value of Information” (VOI) problem within the context of decision-making under uncertainty. Conceptually, VOI analysis is described in economic terms, requiring an analysis of the impact of additional information on the expected value of the decision. The decision-maker(s) must

compare the expected value of a decision made with the imperfect (uncertain) information at hand to the expected value of the decision with the new information to be gathered.

A qualitative VOI analysis was applied to selection of innovative diagnostic tools relying on various specific or relative attributes of the tools themselves and their applicability to a site-specific issue. Some of these attributes include the following:

- **Maturity of the Tool:** A diagnostic tool is similar to any new technology that must pass through a maturation process, including proof of concept, field testing, and finally, commercialization. The innovative tools tested in this project are generally commercially available, have had varying degrees of field testing and evaluation, but are not yet widely or routinely used.
- **Applicability to Site Characteristics:** Some diagnostic tools are only suitable for certain site geologic conditions.
- **Applicability to Specific In-Situ Technology:** Certain diagnostic tools are only applicable to a specific technology.
- **Implementation at the Site of Interest:** The ease of implementation of a diagnostic tool at a particular site is also a relevant criterion for selection. Physical constraints at a site (e.g., above-ground structures) may limit the applicability of a given tool. Complex operating requirements and associated components of a tool may also limit its usefulness.
- **Detection Limits, Accuracy, and Precision of the Tool:** Sufficient field data should be available to determine if the diagnostic tool provides detection limits relevant to the chemicals of concern, and that the reported values of the data produced through use of the tool are of sufficient accuracy and precision to improve decision-making. This issue is susceptible to statistical analysis, but ultimately, professional judgment is required because of site complexities, diverse hydrogeochemical environments, and the likely limited amount of field data available.
- **Uniqueness of Data Gathered by the Tool:** If a diagnostic tool provides unique data that cannot be obtained using other methods, that tool has essentially a “competitive” advantage compared to other techniques. In this case, the value of the information must be considered in the context of the remedial process decision.
- **Cost Relative to Similar Methods:** A final criterion for selection of these tools is the relative cost of application of the diagnostic tool compared to alternative or conventional techniques or other tools that can provide equivalent information. This criterion is only applicable if there are competing methods for obtaining the same data.

The attributes relevant to the determination of value of information are qualitatively evaluated in this report for each tool. A summary of the evaluation of attributes of the tools relevant to a value of information analysis is provided in Table ES-5. Because of the extent of uncertainty related to the multiple attributes, the evaluation in Table ES-5 is based on professional judgment, in addition to the results of the field testing of this project and results from other field sites with which the authors are familiar.

**Table ES-5. Summary of Evaluation of Value of Information Attributes**

<b>Attribute</b>	<b>Multi-level monitoring systems</b>	<b>Rock matrix characterization</b>	<b>MF/MD</b>	<b>CSIA</b>	<b>MBTs</b>
<b>Maturity of the tool</b>	Mature; commercially available	Mature; commercially available	Maturing; some tools commercially available	Mature; commercially available	Variable among tools; some tools commercially available
<b>Applicability to site characteristics</b>	Applicable	Applicable to consolidated media	Consider site characteristics carefully	Applicable	Applicable
<b>Applicability to specific in-situ technology</b>	May be incompatible with certain oxidants or high temperatures	Applicable	Applicable	Applicable to bioremediation, abiotic in-situ treatment (e.g., chemical oxidation), MNA	Applicable to processes involving biological transformations
<b>Ease of implementation</b>	Generally implementable	Involves significant time and effort	Depends on site and level of prior characterization	Implementable	Some tools limited by logistical issues (e.g., lack of standardized methods)
<b>Detection limits, accuracy, and precision</b>	More precise than conventional monitoring; several variables impact accuracy	Sufficient for chlorinated solvents in fractured rock	Depends on accuracy of prior characterization; mixed results regarding PFMs	Some variability; important to follow guidelines to achieve acceptable data quality	Sufficient for some tools (e.g., PCR); other tools are qualitative
<b>Uniqueness of data</b>	Unique	Unique	Unique	Unique	Unique
<b>Cost</b>	Short-term costs likely to result in long-term savings	NA; provides unique data	Site-specific	NA; provides unique data	NA; provides unique data

NA = not applicable

## Summary of Results

A summary of recommendations for each of the tools is provided in Table ES-6. When implemented according to these recommendations, the tools evaluated in this project can provide sufficient value of information for decision-making to justify the additional investment beyond conventional characterization and performance assessment.

**Table ES-6. Recommendations for Application of Innovative Diagnostic Tools at Chlorinated Solvent-Contaminated Sites**

Diagnostic Tool	Recommendations
Multi-Level Monitoring Systems	<p>Use MLM systems for vertical delineation of hydrogeologic properties and contaminant concentrations, particularly at sites with subsurface heterogeneity.</p> <p>Balance relevant criteria for the selection of the most appropriate MLM system for a given site.</p>
Rock Matrix Characterization	<p>Consider rock matrix characterization as a characterization tool at consolidated sites, but carefully weigh the potential value of information collected from the technique against its cost.</p>
Mass Flux Measurement	<p>Mass flux/discharge should be calculated at all contaminated sites, if possible, because it can be used to improve remedial decisions made at various stages of the cleanup process.</p> <p>Consider the site hydrogeologic setting when selecting the mass flux/mass discharge measurement method.</p> <p>Follow best practices during field implementation to increase the accuracy, usefulness, and cost-effectiveness of mass flux/mass discharge measurement methods.</p>
Compound Specific Isotope Analysis (CSIA)	<p>Use CSIA for multiple purposes throughout site characterization and remediation.</p> <p>Conduct baseline CSIA measurements and analyses to confirm the required detection limits are achievable.</p> <p>Overall, use CSIA data to complement conventionally generated analytical data and vice versa.</p>
Molecular Biological Tools	<p>Use qPCR at chlorinated solvent sites to: (1) decide whether to bioaugment, (2) troubleshoot engineered bioremediation or monitored natural attenuation, or (3) provide a supporting line of evidence for biodegradation.</p> <p>Evaluate standard geochemical parameters in groundwater before using MBTs for information for characterization and for troubleshooting many operational issues related to biodegradation of chlorinated solvents.</p> <p>Do not conduct routine molecular evaluation of methanogenic populations unless site-specific conditions require detailed evaluation of these populations.</p>

Table 8-6 summarizes the applicability of innovative diagnostic tools for various stages of the remedial decision-making process, based on the value of information provided by the tool for each decision-making point.

**Table ES-7. Applicability of Innovative Diagnostic Tools at Chlorinated Solvent Sites**

<b>Remedial Decision</b>	<b>Multi-level monitoring</b>	<b>Rock matrix</b>	<b>MF/MD</b>	<b>CSIA</b>	<b>MBTs</b>
Pre-remedy characterization and CSM development	5	5	5	4	2
Selection of remedial technologies	4	4	3	1	3
Performance assessment	4	3	4	4	3
Process modification/ optimization	4	1	3	3	3
Confirming degradation processes	2	1	1	5	4
Estimating risks to receptors	4	1	4	1	1
Transition to LTM or NFA	4	1	4	3	3

Note: 1 = Not applicable, 5 = Extremely useful and/or applicable

While Table ES-7 provides guidance regarding the applicability of diagnostic tools for various stages of the decision-making process for remediation at chlorinated solvent sites, there are many factors to consider in the selection of the most appropriate and informative tools. These factors are discussed throughout this report. In each case, therefore, the selection and use of diagnostic tools will be site-specific. However, this report provides relevant criteria to consider during the selection decision, as well as evaluation of the criteria for each tool.

## 1.0 INTRODUCTION

The work presented in this report was funded by ESTCP in response to the “Call for FY2003 New Start Proposals” on the topic of “In-Situ Remediation of Groundwater.” As described in more detail below, ESTCP Project ER-0318 involved demonstrations of various diagnostic tools for site characterization and performance assessment at three U.S. Department of Defense (DoD) sites: Watervliet Arsenal (New York), Vandenberg Air Force Base (California), and Fort Lewis Logistics Center (Washington). Project results culminated in four reports, three site reports, and this overall summary report.

The primary objective of this summary report is to capture the lessons learned from the testing of five diagnostic tools at the three field demonstrations. These lessons learned are intended to provide DoD with technical guidance on the use of these and other diagnostic tools at chlorinated solvent-contaminated sites for site characterization and remedial selection, design, and performance assessment of in-situ technologies.

### 1.1. ESTCP Project ER-0318 Description

Three demonstration sites were chosen for this study including (1) Watervliet Arsenal, New York, (2) Vandenberg Air Force Base (VAFB), California and (3) Fort Lewis Logistics Center, Washington. The sites illustrate the types of remedial challenges faced at a number of DoD sites nationwide, and are located in distinctly different hydrogeologic environments. In-situ chemical and biological remediation technologies were conducted at two of these sites to address soil and groundwater impacted by chlorinated solvents and other volatile organic compounds (VOCs), providing the opportunity to evaluate a variety of conventional and innovative diagnostic tools for a range of data objectives. A range of innovative diagnostic tools for site characterization quantifying the success of in-situ remedial technologies was tested and assessed at these three sites. Some of these tools were technology- or geology-specific, while others were independent of either the technology or geology of the site. Brief overviews of site characteristics as well as the diagnostic tools tested at each site are provided below.

#### 1.1.1. *Watervliet Arsenal*

Watervliet Arsenal, located in Watervliet, New York, is a 140-acre government-owned installation that was used to manufacture small arms ammunition, cannons, and guns since the mid-1800s. The study area, a subarea of the installation, is located approximately 200 feet west of the Hudson River along the Watervliet Arsenal boundary. The primary contaminants are tetrachloroethene (PCE), trichloroethene (TCE), and their degradation products. The concentrations of these VOCs indicated the presence of dense non-aqueous phase liquids (DNAPLs). DNAPL was detected at one monitoring well at 70 ft below ground surface (bgs).

The geology at the study area consists of 1 to 5 ft of surficial fill followed by 5 to 10 ft of overburden that grades with depth from a fine-grained material to a coarse-grained alluvium. Beneath the overburden is black medium-hard laminated shale (fractured bedrock). According to a downhole and hydrogeophysical study conducted by the U.S. Geological Survey (USGS), three high-permeability flow zones are laterally continuous in the study area. Total VOC concentrations are as high as 51,900 micrograms per liter ( $\mu\text{g/L}$ ) in the intermediate bedrock (70-

120 ft bgs), above the one percent effective solubility limit indicative of a DNAPL release. Due to diffusion processes, most or all of the contaminant mass appears to now reside in the dissolved and sorbed phases of the low-permeability matrix, not in the fractures (Parker et al., 1994; Parker et al., 1997; Parker, 2007).

The remedial technology used at Watervliet Arsenal was in-situ chemical oxidation (ISCO) using permanganate. This ISCO technology was selected because permanganate in solution was thought to be stable enough to diffuse into the rock matrix where most of the contaminant mass resides, and to react with contaminants, resulting in contaminant diffusion out of the matrix towards the permanganate front. Major challenges in applying ISCO technology in fractured rock settings include: (1) permanganate distribution in fractures throughout the contaminated zone, and (2) sufficient persistence of permanganate to allow reaction with contaminants before advective transport of the permanganate or consumption of permanganate due to reaction with the shale materials. Diagnostic tools applied at Watervliet Arsenal included several types of depth-discrete multi-level monitoring (MLM) systems, compound specific isotope analysis (CSIA) (to verify VOC mass destruction by permanganate and the extent of injection displacement), detailed rock matrix characterization via rock core subsampling (to characterize VOCs present in the rock matrix), and mass discharge measurements using an integral pumping test and at the downgradient treatment boundary using a transect mass flux methodology.

### ***1.1.2. Vandenberg Air Force Base***

VAFB is located along the Pacific Coast in Santa Barbara County, California. VAFB's Site 60 is located in a small canyon at the southern edge of the east-west-oriented Santa Ynez Valley. This was the location of a base fuel service station; tanks and piping were excavated, but benzene, toluene, ethylbenzene, and xylene (BTEX) and methyl tertiary butyl ether (MTBE) were detected in groundwater (up to 1800 feet downgradient of the source area in the case of MTBE). Sand, silt, and clay alluvium extend to a depth of approximately 12 meters (m) in the area. Previous investigation had determined that the S3 sand, a thin, shallow aquifer, is the primary pathway for transporting historic contamination in groundwater. Both BTEX and MTBE contamination are being addressed via an in-situ aerobic permeable biobarrier, and the MTBE plume is decreasing in concentration. A well-characterized area with existing infrastructure within Site 60 was chosen for controlled injection of bromide, which is commonly used as a conservative tracer compound because its fate and transport are not affected by microbial degradation or geochemistry. This setting provided a suitable geologic setting for the comparison of four different diagnostic tools capable of measuring mass flux. Thus, the primary objective of this activity was to assess the relative advantages and disadvantages of the four tools tested and to assess, based on this comparison the applicability of each tool for measuring mass flux/mass discharge at other sites.

### ***1.1.3. Fort Lewis Logistics Center***

The third site was the East Gate Disposal Yard at the Fort Lewis Logistics Center in Pierce County, Washington. Chlorinated solvent source areas caused by landfill trenching and disposal at this site are underlain by glacial deposits ranging from sandy gravels with frequent cobbles to glacial till (gravel in a matrix of sand, silt, and clay) interspersed locally with lenses of sand, silty sand, and clay. Groundwater is located approximately 10 ft bgs, and residual TCE DNAPL is believed to be present to depths of about 30 ft bgs. Overall, the aquifer in the source area is fairly

transmissive, although locally less transmissive zones exist in the saturated zone. At this particular source area within the Disposal Yard, an in-situ bioremediation technology was employed to remove chlorinated solvent contamination. Cheese whey was chosen as the electron donor compound to enhance the anaerobic degradation of the chlorinated compounds. Diagnostic tools employed at the site addressed the effect of bioremediation in enhancing mass transfer from the DNAPL phase to the dissolved phase where biodegradation can occur. In addition to conventional analytical parameters (chlorinated ethene concentrations, redox parameters, biological activity indicators, and electron donor concentrations), diagnostic tools used included CSIA, depth-discrete MLM, a suite of molecular biological tools (MBTs), and mass flux measurement technologies.

## **1.2. Report Organization**

This report is organized into eight sections. Section 2.0 provides background information on chlorinated solvent contamination, including technical challenges associated with the presence of these compounds in groundwater, an overview of the various types of geologic settings where chlorinated compounds are found, regulatory requirements that must be followed to achieve site closure, and a brief summary of available remedial technologies. Section 2.0 also includes an overview of diagnostic tools, including key drivers for their use at chlorinated solvent sites; their application for site characterization, process monitoring, and performance monitoring; and the utility of diagnostic tools for optimizing remedial strategies.

Sections 3.0 through 7.0 provide details on the five types of innovative diagnostic tools evaluated by this project: (i) multi-level monitoring, (ii) rock matrix characterization, (iii) mass flux measurement, (iv) CSIA, and (v) molecular biological tools. Each of the sections provides a detailed description of the tool, its technology status, its applicability in specific geologic settings, its applicability for performance assessment of remedial technologies, and its advantages and disadvantages compared with other available and more conventional approaches. Key information about each of the tools is also presented in these sections, such as commercial status, cost, and regulatory acceptance.

Section 8.0 presents a qualitative assessment of the potential value of information added by the tools that can be used for selecting specific diagnostic tools to enhance remedial efforts. Furthermore, Section 8.0 provides key recommendations on the applicability of these tools to specific decision points during all phases of site cleanup.



## 2.0 BACKGROUND ON DIAGNOSTIC TOOLS

Despite more than 40 years of experience, groundwater industry professionals still face many technical, economic, and regulatory challenges for cleanup of contaminated soil and groundwater in the U.S. and worldwide. Over the past decade, however, considerable investment in innovative diagnostic tools has raised expectations that contaminated soil and groundwater at many sites can now be characterized and remediated or restored to concentrations that allow for unrestricted beneficial use of the damaged resource. In this section, we provide a brief overview of some of the technical challenges being addressed by recently developed diagnostic tools. This discussion provides needed context for this guidance document on the use of selected innovative diagnostic tools at DoD facilities, in conformance with the scope of the ESTCP project. The information presented in this guidance document was developed based on detailed analyses of several of these tools used in three field demonstrations at separate DoD sites over the past few years as noted in the Introduction.

Historically, the site characterization and performance assessment of remediation systems at chlorinated solvent-contaminated sites has been evaluated using two-dimensional measurements of dissolved contaminant concentrations obtained from monitoring wells in aquifers (e.g., changes in maximum concentrations and plume extent over time). Such an approach may have limitations that impact the evaluation of technology effectiveness and influence remedial decision-making at these sites. Two-dimensional measurements of dissolved contaminant concentrations in aquifers are typically based on groundwater samples collected by standard methods from monitoring wells with well screen lengths mostly ranging from 10 to 20 feet, i.e., from a single depth interval. The limitations of these types of measurements are documented (e.g., Einarson, 2006), and have been the impetus to develop alternative methods for characterizing the extent of contaminants in the saturated zone, particularly with respect to the vertical distribution of contaminants, monitoring the performance of in-situ remediation technologies, and conducting performance assessments for the objective of achieving site closure or transitioning to long-term management with a variety of institutional controls (e.g., deed or use restrictions).

In addition to improvements in depth-discrete sampling for characterizing the vertical distribution of chemicals in groundwater, new diagnostic tools have been developed to improve all phases of site remediation, from site characterization and selection of a remedial technology through operation and optimization of the remedial system. These innovative tools show promise for improving technology selection/decision-making during the feasibility or corrective measure study phase, process monitoring and optimization following remedy implementation, and performance assessment for compliance or verification of meeting site closure objectives (e.g., Maximum Contaminant Levels (MCLs)). Many of these tools were developed to evaluate the effectiveness of specific technologies (e.g., MBTs for in-situ bioremediation) or to investigate the distribution of chemicals in certain geologic formations (e.g., rock crushing and extraction tools). Other tools address specific types of contaminants, (e.g., DNAPL-specific diagnostic tools). A summary of the diagnostic tools evaluated in this study and the field sites at which they were evaluated is provided in Table 2-1.

**Table 2-1. Field Sites for Evaluation of Diagnostic Tools**

Diagnostic Tool	Field Site		
	<i>Watervliet Arsenal</i>	<i>Vandenberg AFB</i>	<i>Fort Lewis</i>
<b>Multi-Level Monitoring Systems</b>	✓		✓
<b>Rock Matrix Characterization</b>	✓		
<b>Mass Flux Measurement</b>			
<i>Passive flux meter</i>		✓	✓
<i>Transect method</i>	✓	✓	✓
<i>Steady-state pumping</i>		✓	
<i>Recirculation flux measurement</i>		✓	
<i>Integral pumping test</i>	✓		
<b>Compound Specific Isotope Analysis</b>	✓		✓
<b>Molecular Biological Tools</b>			✓

One key issue in evaluating these diagnostic tools is the assessment of the benefits obtained by using a tool compared to the potential increase in investigation and monitoring costs. Alternatively, some diagnostic tools provide information that cannot be obtained using conventional techniques (e.g., CSIA). The value of such unique knowledge must then be evaluated in the context of benefits from potentially accelerating site closure, reducing the overall life-cycle costs of cleanup, or reducing the risks associated with failure of any remedial action to achieve desired goals (see Section 8.0 in this report).

Prior to describing these diagnostic tools, we provide a contextual overview of the site remediation process as currently followed in the US. In addition, we provide background information on various factors that must be considered when selecting diagnostic tools to address the full range of issues that arise during subsurface remediation at chlorinated solvent sites. These factors include contaminant-specific attributes influencing the application of diagnostic tools, the importance of the geologic setting, the types of remedial technologies, and the impact of varying remedial objectives for groundwater cleanup on the use of diagnostic tools.

## **2.1. Conventional Investigation and Remediation Approaches**

### ***2.1.1. Site Remediation – The Typical Process***

Based on recent USEPA data (USEPA, 2004a), approximately 300,000 contaminated sites in the U.S. were expected to require cleanup between 2004 and 2033. Over this thirty-year period, estimated cleanup costs (2003 dollars) were reported to range up to \$250 billion. The number of DoD sites identified in this summary document was reported to be over 6,000, with a total estimated cleanup cost of \$31 billion. In the context of this substantial present and future liability, the development of diagnostic tools that could reduce the final cost of cleanup and/or shorten the time to achieve either site closure or transition to long-term monitoring and management is a high priority for the DoD.

A contaminated site, like other environmental challenges, exhibits a reasonably well-defined life-cycle. Following discovery, sites come under regulatory control at the federal, state, or local

level. This designation establishes a framework and a process for site characterization, development of a conceptual site model (CSM), development of remedial action objectives (RAOs), and selection and implementation of an appropriate remediation system (i.e., one or more remediation technologies that address the specific contaminants and specific media impacted) if active remediation is warranted. One example is the process defined by the National Contingency Plan developed under CERCLA (40 CFR Part 300, 2003). The process is often site-specific, depending on the controlling statute, federal and local regulations, the ownership of the site, the ultimate expected use of the site, and the attitudes of other stakeholders (e.g., local communities, tribal nations). Figure 2-1 provides a conceptual overview of the remedial process at a contaminated site. The ultimate goal is either to achieve site closure such that the property/groundwater can be restored to its highest beneficial use as defined by the impacted community or the regulatory bodies, or transition of the site to long-term monitoring and management. It is now recognized that this apparently linear life-cycle process for site cleanup is highly non-linear due to the reality that each site exhibits significant uncertainty, both technically and institutionally, leading to lengthy delays in decision-making as to the ultimate remedy to address the contamination. Each phase of site investigation, and the implementation of interim remedies, results in greater knowledge of site conditions, and a reassessment of the optimum strategy for site management. In addition, at many sites, disputes over liability due to multiple current, past, or no-longer-existing potentially responsible parties can result in major delays in the cleanup process, particularly if litigation is likely or ongoing. In the past, some major decisions regarding selection of remedial actions have been premature, and have been inappropriate responses to the cleanup issues. Again, disputes have led to significant delays, and almost always substantial increases in life-cycle costs.

Another significant challenge facing the cleanup of contaminated groundwater results from technical limitations that make achievement of some RAOs difficult or unlikely within an acceptable timeframe as has been documented in numerous publications over the past 15 years (National Research Council (NRC), 1994; USEPA, 2003; NRC, 2005; USEPA, 2009b). The development of improved diagnostic tools to establish reasonable RAOs and to assess the likelihood of achieving selected RAOs, such as drinking water standards, in some settings is also a significant driver for innovation. The expenditure of large sums for cleanup without commensurate benefits will continue to be a barrier to achieving closure at complex sites.

**Figure 2-1. Conceptual Overview of Typical Remedial Process for Contaminated Sites**

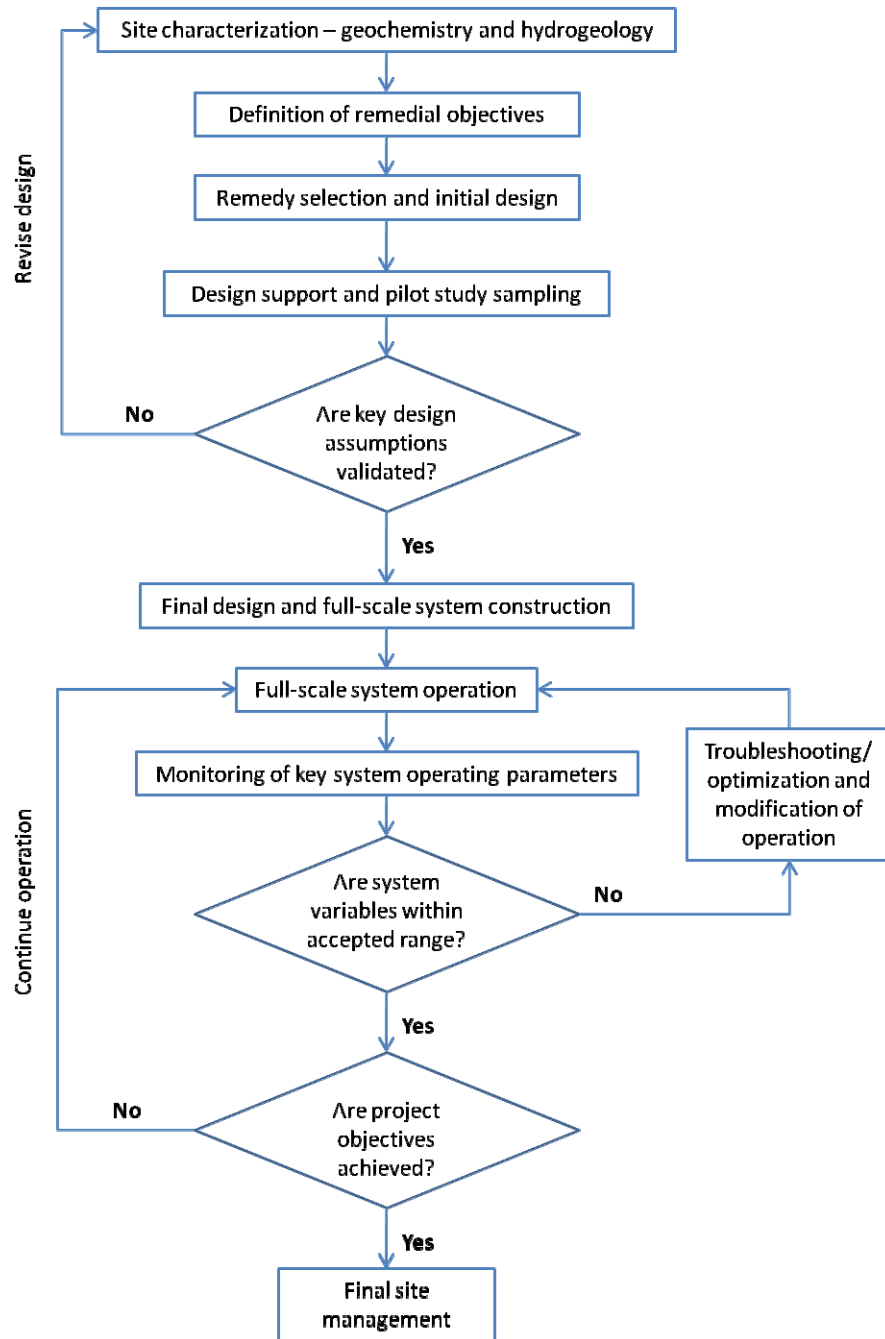

Source: Modified from Figure 2-5 of Interstate Technology and Regulatory Council (ITRC), 2008.

### ***2.1.2. Geologic Settings***

The geologic environment is a significant factor influencing the distribution of chlorinated solvents in the subsurface. Thus, the geologic and hydrogeologic characteristics at a site often are significant drivers in the selection, implementation, operation, and monitoring of remedial technologies. Subsurface characteristics arise from a variety of specific geologic and geochemical processes and can vary over orders of magnitude spatially (both horizontally and vertically).

The wide diversity in subsurface geologic settings greatly affects the characteristics of chlorinated solvent source zones, the efficiency of remedial technologies, and what endpoints are likely attainable by specific technologies used for groundwater remediation. In addition, the nature of the subsurface geologic environment will influence the choice of some diagnostic tools. For example, some depth-discrete sampling tools are limited to unconsolidated media. In a recent report (NRC, 2005), a committee of national experts on DNAPL source zones proposed a simplified taxonomy of geologic environments consisting of five general hydrogeologic settings that are broadly representative of common subsurface conditions relevant to remediation (Table 2.2). They differ in spatial variations in permeability and porosity, two key parameters that control the mechanism by which contaminants move through the subsurface. While it is understood that these general settings significantly oversimplify actual geologic environments in the subsurface, they provide useful descriptors for discussing the applicability of different diagnostic tools. These settings will be referenced throughout this report.

**Table 2-2. Five General Hydrogeologic Settings as Proposed by the National Research Council**

Type		Porosities	Permeability	Hydraulic Conductivity	Examples
I	Granular Media with Mild Heterogeneity and Moderate to High Permeability	5% to 40%	$k > 10^{-14} \text{ m}^2$	$K > 10^{-7} \text{ m/s}$	Eolian Sands
II	Granular Media with Mild Heterogeneity and Low Permeability	5% to 40%	$k < 10^{-14} \text{ m}^2$	$K < 10^{-7} \text{ m/s}$	Lacustrine clay
III	Granular Media with Moderate to High Heterogeneity	5% to 40%	$k > 10^{-14} \text{ m}^2$	$K > 10^{-7} \text{ m/s}$	Deltaic Deposition
IV	Fractured Media with Low Matrix Porosity	Fractures $\ll 1\%$ ; Unfractured matrix $< 1\%$	$k < 10^{-17} \text{ m}^2$ for unfractured matrix	$K < 10^{-10} \text{ m/s}$ for unfractured matrix	Crystalline Rock
V	Fractured Media with High Matrix Porosity	Fractures $\ll 1\%$ ; Unfractured matrix 1-40%	$k < 10^{-17} \text{ m}^2$ for unfractured matrix	$K < 10^{-10} \text{ m/s}$ for unfractured matrix	Limestone, Sandstone or Fractured Clays

Source: NRC, 2005

### 2.1.3. Regulatory Requirements

Groundwater cleanup requirements generally vary among sites and are another factor that may affect the feasibility of different technologies and thus, the choice of diagnostic tools and appropriate remedial technologies. Remedial objectives can range from partial mass removal, to source containment (or flux reduction), to a goal of meeting specific numeric standards such as MCLs. At most larger sites, the remediation process will be iterative or adaptive, with multiple technologies employed in an attempt to meet RAOs. A recent summary of this iterative process is illustrated in Figure 2 2, adapted from a recent NRC report on DNAPL source remediation (NRC, 2005). Two key steps as shown on Figure 2 2 are the identification of “absolute” and “functional” objectives for a site. As defined by the NRC report, absolute objectives are important in themselves (e.g., ensuring that risks to human health have been reduced to an acceptable level), while functional objectives are a means to an end (e.g., reducing contaminant concentrations in groundwater to a specified level to meet human health risk reduction) (NRC, 2005). Each objective should have an associated metric, a quantity that can be measured at a particular site to evaluate progress towards achieving the objective (NRC, 2005) and a corresponding set of diagnostic tools that provide the data to support the selected metric. This iterative process must be consistent with regulatory requirements imposed on the site, depending upon the lead agency and the particular regulatory program in which the site contamination is addressed.

**Figure 2-2. Six-Step Process for Source Remediation**

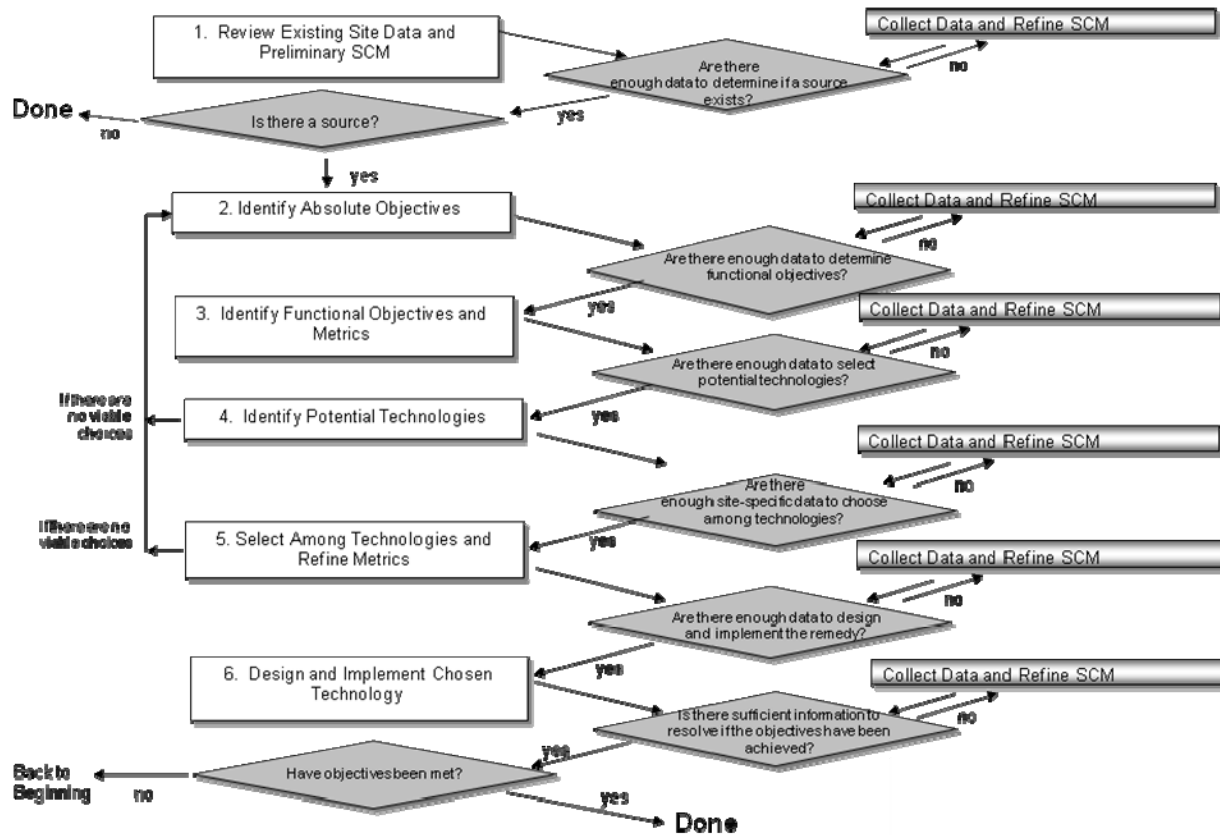

Source: NRC, 2005

### 2.1.4. Remedial Technologies

Remedial technologies used to clean up chlorinated solvents in groundwater have evolved over the past few decades (see, for example, Stroo and Ward, 2010). Groundwater extraction using traditional groundwater supply technologies was the primary technology initially used to remove chlorinated solvents from aquifers and capture plumes generally with the goal of rapid (less than 30 years) achievement of cleanup objectives. This so-called “pump-and-treat” technology, while successful at containment of contaminated plumes, has been shown to be a limited option for rapid removal of contaminant mass from groundwater, particularly in the presence of DNAPLs (e.g., NRC, 1994). A more recent NRC committee (2005) concluded that several alternative technical options would be more effective at restoring groundwater to maximum beneficial uses than conventional pump-and-treat in an “average geology.” These options can be broadly characterized as chemical oxidation/reduction, biological oxidation/reduction, and thermal technologies with vapor recovery (see, for example, USEPA, 2010a).

Diagnostic tools appropriate for site characterization and performance assessment of these in-situ technologies vary depending on the specific mechanism of the technology. For example, biological and chemical remedial technologies degrade chlorinated solvents, and tools designed

to detect and measure such degradation (e.g., CSIA) could be appropriate for performance assessment of these technologies. Other tools (e.g., mass flux measurement) are potentially applicable to performance assessment of all in-situ remedial technologies. The applicability of diagnostic tools to in-situ remedial technologies is evaluated in detail in Section 8.0.

## 2.2. Diagnostic Tools

### 2.2.1. Key Drivers for the Development of Diagnostic Tools

Diagnostic tools satisfy a critical need in the cleanup of contaminated sites. These tools provide data needed to optimize the cleanup process, with the goals of meeting all RAOs while reducing life-cycle costs. Some of the key issues faced during the life-cycle of site cleanup are summarized in Table 2-3. During site characterization, the development of an accurate CSM depends on identifying the major controlling features of the site such as preferential flow paths, the presence and extent of NAPLs, major continuing sources of contaminant release to the groundwater, and likely receptors that could be impacted. Selection of the appropriate suite of remedial technologies also depends upon the adequacy of the site characterization process. Typical questions asked at this point in the process include the following: “Can the selected technologies achieve the RAOs in a “reasonable” timeframe?” and “can the timeframe for achieving RAOs be predicted with a degree of accuracy allowing for life-cycle costing, and allowing for an estimate of overall environmental impacts including consideration of sustainability metrics such as relative emissions of greenhouse gases?”

**Table 2-3. Life-Cycle of a Contaminated Site: Key Issues for Diagnostic Tools**

Phase	Key Issues
Site characterization	<ul style="list-style-type: none"> <li>• Develop accurate CSM</li> <li>• Reduce uncertainty in key parameters</li> <li>• Provide adequate data for remedy selection</li> </ul>
Remedy selection / design	<ul style="list-style-type: none"> <li>• Establishment of RAOs acceptable to stakeholders</li> <li>• Ability of technologies to meet RAOs</li> <li>• Life-cycle cost estimates</li> <li>• Ability to meet absolute versus functional objectives</li> </ul>
Implementation / operations	<ul style="list-style-type: none"> <li>• Optimizing performance</li> <li>• Developing closure strategy</li> </ul>
Alternative endpoints	<ul style="list-style-type: none"> <li>• Technical basis for alternative points of compliance or cleanup level (e.g., technical impracticability (TI) waiver)</li> </ul>
Closure	<ul style="list-style-type: none"> <li>• Meeting regulatory requirements for closure, “No Further Action” status</li> </ul>

Once a remedy has been implemented, particularly for active remedies requiring injection of fluids or heat into the subsurface, system optimization depends heavily on the collection of appropriate data to assess the efficacy of the remedial system. If it can be demonstrated that the remedial system has achieved optimum results “to the extent practicable,” and that the current and future risks can be defined, transition to long-term monitoring or site closure can be



accelerated. Finally, site closure can only be achieved when the site stakeholders (owners, regulators, community representatives) agree that any residual contamination does not pose unacceptable risks to human health and the environment, and that reliance on natural attenuation is considered protective. Meeting this goal depends on the use of proven diagnostic tools that provide reliable, accurate, and transparent data to support final management decisions for the site. Thus, the development of such tools is essential for reducing the time and cost of achieving either site closure or long-term management.

### ***2.2.2. Process versus Performance Monitoring***

At contaminated sites, a wide range of technologies has been developed to address the cleanup of contaminated groundwater. Aside from the widely used “pump-and-treat” technology as discussed earlier in this section, in-situ technologies have become the primary option for source and plume cleanup (USEPA, 2003; NRC, 2005; ITRC, 2004; Kavanaugh and Kresic, 2008). These include chemical oxidation and reduction technologies, microbially mediated oxidation or reduction technologies, and thermal technologies. Diagnostic tools are needed to optimize the operations of each of these, and to ensure that they achieve the desired RAOs. In contrast to ex-situ technologies which have well-defined influent and effluent streams allowing for convenient process monitoring and control (e.g., granular activated carbon systems), in-situ technologies are installed in complex and highly heterogeneous subsurface environments. This complicates monitoring strategies because of the potential for inaccurate results if the monitoring systems are placed in locations that do not reflect the controlling processes in the subsurface. It has been established that in both unconsolidated and consolidated media, preferential flow paths are the norm and not the exception (see, for example, Payne et al., 2008; Sale et al., 2008).

In addition to hydrogeologic complexities in the subsurface, monitoring of in-situ remedies is further complicated by the diversity of microbial populations in the subsurface, the spatial variability of geochemical properties (e.g., pH, oxidation-reduction potential, temperature, chemical speciation), and the complex distribution and orientation of any NAPLs (i.e., the so-called “architecture” in the subsurface, for example NAPL pools or vertically distributed ganglia). This complexity results in the need to develop diagnostic tools that address site-specific features. These features can be technology-, geology-, or chemical-specific. Examples include MBTs for in-situ bioremediation, rock coring tools for consolidated media and tools for characterizing the nature and extent of NAPLs. Other useful diagnostic tools include technologies to demonstrate that chemical or biological transformations are occurring in the subsurface at rates that can result in accelerated cleanup. CSIA is the best example of such an innovative diagnostic tool.

Diagnostic tools can thus be used to conduct both process and performance monitoring thereby leading to more accurate assessments of the overall effectiveness of any in-situ technology. Process monitoring provides an identification of the controlling processes determining the efficacy of the technology (e.g., biotic versus abiotic transformations), and a basis for quantifying the rate of transformations (e.g., rate of chemical oxidation, and need for additional chemical injections). This information can then be used to optimize the operations of the in-situ technology. For example, if the technology has been installed in the correct hydrogeologic setting, then process monitoring diagnostic tools can provide data needed to optimize the

location, amount, and frequency of injected fluids for oxidation/reduction abiotic reactions or enhanced microbial oxidations/reductions.

Performance monitoring, on the other hand, provides data needed to evaluate the effectiveness of the technology in relation to the RAOs. These RAOs may be considered absolute objectives (e.g., MCLs) or functional objectives (e.g., remove mass to the extent practicable), as discussed above. The diagnostic tool must be capable of providing reliable and accurate data that meet regulatory requirements for performance assessment.

### ***2.2.3. Innovative Diagnostic Tools for Site Characterization and Process and Performance Monitoring***

Characterization of the subsurface has remained a significant challenge for groundwater cleanup at chlorinated solvent-contaminated sites. Over the past decade, numerous guidance documents, reports, and peer-reviewed publications have provided summaries of conventional and innovative diagnostic tools used for site characterization and process and performance monitoring and assessment at these sites. Table 2-4 provides a list of recent (within the last ten years) published documents summarizing the latest developments in site characterization technologies. In general, the goal of many of these guidance documents has been to accelerate site characterization, reduce costs, and increase the value of data collected. Alternative methodologies and technologies are summarized in the documents, compared to the more conventional methodologies (for the purposes of this report, those used prior to 1990) for site characterization.

**Table 2-4. Recent Documents Addressing Chlorinated Solvent Site Characterization**

Title	Source	Characterization Topics Addressed
Dense Non-Aqueous Phase Liquids (DNAPLs): Review of Emerging Characterization and Remediation Technologies	ITRC DNAPLs/Chemical Oxidation Work Team, June 2000	DNAPL characterization technologies, including geophysical technologies, direct-push (DP) technologies, and in-situ tracers
DNAPL Characterization Methods and Approaches, Part 1: Performance Comparisons, and Part 2: Cost Comparisons	Kram et al., 2001; Kram et al., 2002	Methods to detect and delineate DNAPL contaminant source zones and comparison of their performance capabilities and cost
An Introduction to Characterizing Sites Contaminated with DNAPLs	ITRC Dense Nonaqueous Phase Liquids Team, September 2003	Characterization approach, data collection techniques, and regulatory issues
Site Characterization Technologies for DNAPL Investigations	USEPA, 2004b	Geophysical and non-geophysical techniques for DNAPL characterization
Groundwater Sampling and Monitoring with Direct Push Technologies	USEPA, 2005	Recommended methods and data quality objectives for application of DP technologies
Mass Flux Toolkit User's Manual	Farhat, Newell, and Nichols, 2005	Mass flux calculation and assessment of impact
Assessment and Delineation of DNAPL Source Zones at Hazardous Waste Sites	Kueper and Davies, 2009	Source zone investigation methods, assessing DNAPL presence, delineation of the source zone
DNAPL Site Characterization Issues at Chlorinated Solvent Sites	Mercer et al., 2010	DNAPL characterization approach, methods, and data interpretation

In addition, regulatory agencies and some of the regulated entities (e.g., DoD), have invested significant resources in developing more effective methodologies for site characterization. The U.S. Department of Energy and USEPA promote the use of the TRIAD approach (see, e.g., Crumbling, 2001). This methodology considers site characterization as a dynamic process, with each phase of the investigations leading, in theory, to a more accurate CSM that will facilitate and improve remedial decision-making, and accelerate site cleanup. The process is thoroughly described in various USEPA publications and other sources (see e.g., Crumbling et al., 2003).

Thus, the literature on site characterization is vast, and a wide range of diagnostic tools are now available for remediation professionals. According to the USEPA's Contaminated Site Clean-up Information website ([www.clu-in.org](http://www.clu-in.org)), there are over 650 characterization technologies provided by numerous vendors and listed in USEPA databases (USEPA, 2010b). Many of these tools are

currently in use and have provided more comprehensive data on site characteristics than traditional approaches. Some of these tools, however, are still in a developmental stage, and additional testing is required to determine the reliability of the technologies, the accuracy of the results, and the value-added proposition of these tools. For example, groundwater cleanup professionals must still question on a case-by-case basis whether the additional expense is commensurate with the value of the data provided.

In this report, we present details on five innovative diagnostic tools that provide unique site characterization data. Most of these tools can be used for both process monitoring and performance assessment for in-situ technologies designed to clean up contaminated groundwater at chlorinated solvent sites in both consolidated and unconsolidated media.

#### ***2.2.4. Diagnostic Tools Evaluated in This Study***

The five diagnostic tools evaluated by this study are capable of evaluating the following site characterization issues, which are each partly geology-, contaminant-, or technology-specific:

- Vertical distribution of contaminants in the dissolved and adsorbed phase through multi-level monitoring systems.
- Assessment of distribution of chlorinated solvents in consolidated media and performance assessment of in-situ technologies.
- Confirmation of in-situ chemical or biological transformations of chemicals of concern.
- Comparison of mass flux/mass discharge measurement technologies for both process and performance assessment.
- Optimizing process performance of in-situ bioremediation through the use of MBTs.

Contact information for vendors for the diagnostic tools evaluated in this study is provided in Appendix B. The applicability of the diagnostic tools of this study to various steps in the remedial process, hydrogeologic settings, and remedial technologies are indicated in Table 2-5, Table 2-6, and Table 2-7, respectively. These diagnostic tools are described briefly below. A summary of the field sites at which the tools were evaluated is provided in Table 2-1.

**Table 2-5. Potential Applicability of Diagnostic Tools to Stages of the Remedial Process**

Diagnostic Tool	Remedial Process				
	Site Characterization	Remedy Selection	Remedy Design	Troubleshooting/Optimization	Final Site Management
<b>Multi-Level Monitoring Systems</b>	✓		✓	✓	✓
<b>Rock Matrix Characterization</b>	✓	✓	✓	✓	✓
<b>Mass Flux Measurement</b>					
<i>Synoptic sampling (transect method)</i>	✓	✓	✓	✓	✓
<i>Steady-state pumping (SSP)</i>	✓	✓	✓		✓
<i>Passive flux meter (PFM)</i>	✓	✓	✓		
<i>Recirculation flux measurement (RFM)</i>	✓	✓	✓		✓
<b>Compound Specific Isotope Analysis</b>	✓			✓	
<b>Molecular Biological Tools</b>	✓	✓	✓	✓	✓

**Table 2-6. Applicability of Diagnostic Tools to General Hydrogeologic Settings**

Diagnostic Tool	Hydrogeologic Setting				
	I	II	III	IV	V
	Granular Media with Mild Heterogeneity and Moderate to High Permeability	Granular Media with Mild Heterogeneity and Low Permeability	Granular Media with Moderate to High Heterogeneity	Fracture Media with Low Matrix Porosity	Fracture Media with High Matrix Porosity
<b>Multi-Level Monitoring Systems</b>	✓	✓	✓	✓	✓
<b>Rock Matrix Characterization</b>				✓	✓
<b>Mass Flux Measurement</b>					
Synoptic sampling	✓	✓	✓	✓	✓
SSP	✓	✓		✓	✓
PFM	✓	✓	✓		
RFM	✓	✓			
<b>Compound Specific Isotope Analysis</b>	✓	✓	✓	✓	✓
<b>Molecular Biological Tools</b>	✓	✓	✓	✓	✓

Note: See NRC, 2005 for detailed descriptions of generic geologic settings

**Table 2-7. Applicability of Diagnostic Tools to Selected Generic Remedial Technologies**

Diagnostic Tool	Applicable Generic Remedial Technology			
	Groundwater Extraction and Treatment	In-Situ Chemical Oxidation	In-Situ Bioremediation	Thermal Treatment
<b>Multi-Level Monitoring Systems</b>	✓	✓	✓	✓
<b>Rock Matrix Characterization</b>	✓	✓	✓	✓
<b>Mass Flux Measurement (all types)</b>	✓	✓	✓	✓
<b>Compound Specific Isotope Analysis</b>		✓	✓	
<b>Molecular Biological Tools</b>			✓	

The multi-level monitoring systems discussed in this report used to monitor the vertical distribution of contaminants include the following:

- Groundwater FLUTe (a trademark name for Flexible Liner Underground Technologies)
- Solinst CMT<sup>®</sup> (Continuous Multichannel Tubing) System
- Solinst Waterloo System
- Westbay System
- ZIST<sup>™</sup> (Zone Isolation Sampling Technology by BESST, Inc., a nested well system)

These multi-level monitoring systems were compared to conventional nested sampling systems in both unconsolidated saturated zones (Fort Lewis) and consolidated saturated zones (Watervliet Arsenal).

To determine the distribution of contaminants within a consolidated formation, a unique rock core collection, sampling, and extraction method for determining VOC concentrations in the rock matrix was used at the Watervliet Arsenal (Parker, 2007).

Of particular interest in this study was a careful comparison of four technologies capable of estimating the mass flux and mass discharge emanating from source zones contributing chlorinated chemicals to groundwater plumes. The four technologies evaluated at Vandenberg AFB included (i) transect method using synoptic sampling from monitoring wells, (ii) passive flux meter (PFM) technology, (iii) steady-state pumping (SSP) of wells in a transect, and (iv) recirculation flux measurement (RFM). The transect method was also evaluated at both Fort Lewis and Watervliet Arsenal, the integral pumping test was used at Watervliet Arsenal, and the PFM technology was assessed at Fort Lewis.

At both the Fort Lewis and Watervliet Arsenal sites, CSIA was used to evaluate whether abiotic (Watervliet Arsenal) and biotic (Fort Lewis) transformations could explain the reduction in concentrations of the chlorinated chemicals found at these sites. The CSIA technology, based on the change in the carbon isotope ratios before and after remediation, is capable of distinguishing physical transformations from biotic or abiotic transformations (USEPA, 2008).

Finally, at Fort Lewis, a suite of MBTs was used to assess the performance of an in-situ bioremediation technology using whey as the electron donor to achieve reductive dehalogenation of chlorinated solvents in the saturated zone.

### ***2.2.5. Utility of Diagnostic Tools for Optimization of Remedial Strategies for Chlorinated Solvent Sites***

As a general rule, the use of innovative diagnostic tools, such as those discussed in this report, may lead to increased costs of site investigation or monitoring activities. Cost analyses of each of the tools evaluated in this study are summarized in later sections. Also, more details are provided in each of the site reports (Malcolm Pirnie et al., 2010; Malcolm Pirnie and University of Waterloo, 2010; North Wind, 2010). For example, at first glance, the use of the transect method to estimate mass discharge from a source may require the installation of numerous multi-level monitoring wells to obtain an accurate estimate of the mass discharge of a chemical emanating from a source zone, and would therefore seem to be a costly proposition. However, an accurate estimate of the mass discharge can provide the basis for improved decision-making at the site, and possibly result in the net life-cycle site costs being lower due to the implementation of the transect method. Understanding the spatial and temporal distribution of mass discharge results in a more efficient design of any in-situ remedy because the remedy will target the zones of highest mass discharge. This can result in a more cost-effective and potentially more accelerated cleanup.

Table 2-8 lists a few of the critical site strategic decisions that must be made at chlorinated solvent-contaminated sites and the corresponding diagnostic tools. At most sites, monitored natural attenuation (MNA) or natural attenuation (NA) without monitoring will likely be a component of the final remedial strategy given the technical and economic barriers to complete site restoration (i.e., removal of all contaminants to background levels, usually defined as “non-detect” values). Acceptance of MNA by site stakeholders often depends on the use of several lines of evidence to confirm that risks of further migration and receptor impacts are acceptably low (USEPA, 1999). Demonstrating that the chemicals of concern are being depleted by biotic or abiotic processes is essential for remedy acceptance. This issue can be resolved through the use of CSIA technologies as well as specific MBTs that demonstrate the presence of microbes capable of biological transformations. These tools, combined with measurements of critical chemical parameters (e.g., pH, dissolved organic carbon, chemical species distribution), can provide the data needed to assess the applicability of MNA.

**Table 2-8. Process Mechanisms and Diagnostic Tools**

Issue to be Resolved	Examples of Diagnostic Tool Options
Chemical transformation vs. physical changes	Compound Specific Isotope Analysis Molecular Biological Tools
Applicability of MNA via degradation	Compound Specific Isotope Analysis Molecular Biological Tools
Abiotic vs. biotic degradation	Compound Specific Isotope Analysis Molecular Biological Tools
Distribution of contaminants in the subsurface in fractured consolidated media	Rock coring and extraction
DNAPL distribution	FLUTe™, a multi-level monitoring system
Preferential flow paths	Multi-level monitoring systems
Source strength	Mass flux/discharge measurement tools

The location and distribution of DNAPLs found at chlorinated solvent sites represent a difficult remediation challenge, as has been well-documented by USEPA, NRC, and ITRC. This is particularly the case in consolidated media as demonstrated in the study at the Watervliet Arsenal discussed herein. Many other case studies are available in the literature. Recent summaries of diagnostic tools for DNAPL characterization (Kueper and Davies, 2009; Mercer et al., 2010) document the continued challenges to locating and remediating DNAPLs in the subsurface. However, if multi-level monitoring systems combined with geophysical measurements can identify the preferential flow paths in the saturated zone, targeted remedial strategies are more likely to achieve mass removal to the “extent practicable” at these difficult sites.



### **3.0 MULTI-LEVEL MONITORING SYSTEMS**

Historically, the performance of remediation systems at chlorinated solvent-contaminated sites has been evaluated using two-dimensional measurements of dissolved contaminant concentrations in aquifers. Due to heterogeneities in the subsurface and other factors, however, the spatial distribution of contaminants and hydraulic properties in the subsurface are highly variable, particularly in the vertical direction. It is difficult for typical groundwater monitoring efforts, especially those relying on sparse networks of long-screened wells, to determine where the majority of the contaminant mass is migrating and thus whether or not remediation systems are effective in reducing that migration and/or removing the mass from the subsurface.

At sites with complex geologies, such as fractured rock sites, the evaluation of in-situ technology performance is complicated further by contaminant migration through discrete fractures. In order to improve subsurface characterization and remedial performance assessment, this ESTCP project evaluated several tools to improve resolution of the subsurface distribution of contaminants and hydraulic properties, including multi-level monitoring systems, a nested well system, and rock matrix characterization. Multi-level monitoring systems and the nested well system discussed in this section can be used in both consolidated and unconsolidated geologies to measure contaminants and hydraulic properties with depth, and correspond to the first of the five types of innovative diagnostic tools addressed in this report as discussed in Section 2.0. Rock matrix characterization, which is only applicable to consolidated media, is discussed in Section 4.0.

#### **3.1. Description of Multi-Level Monitoring Systems**

Conventional groundwater monitoring is conducted using dedicated equipment to collect hydraulic head data and groundwater samples that represent an average measure from each well (i.e., blended values over open or screened interval). In contrast, multi-level monitoring systems are designed to collect hydraulic head data and depth-discrete samples over a multiple, relatively short vertical intervals of the subsurface within a single borehole (ITRC, 2004; Einarson, 2006). Multi-level monitoring systems therefore provide a better understanding of the location of contaminants as well as the changes in concentration with depth within the contaminant plume.

For clarity of discussion, a general nomenclature for these devices is presented here, followed by a description of their uses in general. The term “general-purpose multi-level monitoring system” (MLM system) refers to an engineered assembly of various components installed in a single borehole to achieve the following:

- Obtain depth-discrete measurements of water pressure (or hydraulic head)
- Acquire groundwater samples at specific depths for analysis
- Conduct tests to measure the hydraulic characteristics of the monitored interval

For the purposes of this evaluation, an MLM system is defined as a single-cased (or “single-tube”) entity capable of monitoring at least two discrete intervals within a borehole. Several MLM systems fitting this definition are described in the literature; however, only four systems are available commercially.

These four systems are manufactured by three companies as follows:

- Flexible Liner Underground Technologies, LLC (the Groundwater FLUTE™)
- Solinst Canada (the CMT® system and the Waterloo system)
- Schlumberger Water Services (Westbay system)

In addition to these MLM systems, a nested well technology is also available. Nested wells are considered to be two or more wells installed in a single borehole, stacked one above the other with seals placed in between. The commercially available nested well system considered here is the ZIST™ System (BESST Inc.). A summary of key attributes of each system is provided below.

### ***3.1.1. Water FLUTE™ system***

#### **Description**

A schematic of the FLUTE™ system is shown on Figure 3-1. The system is described in detail by Cherry et al. (2007). The FLUTE™ system consists of a pressurized flexible polyurethane-coated nylon liner emplaced in a borehole by interior water pressure exceeding the formation pressure, sealing the borehole completely. Sampling intervals are set using exterior spacers that are placed between the borehole wall and the liner. This system therefore must be pre-designed and custom-built for each borehole; however, its installation does not require use of a drill rig once the hole is drilled. Each sampling interval is sealed from the remainder of the borehole by the water pressure inside the liner. A sample tube equipped with a check-valve system brings water from the formation up to the ground surface to be collected and monitored. The FLUTE™ system, which can accommodate from 1 to 20 ports, is typically used for deeper applications in stable holes (e.g., core holes in fractured bedrock).

**Figure 3-1. Water FLUTE™ Schematic**

Water FLUTE pump system  
(Single port system shown for clarity)

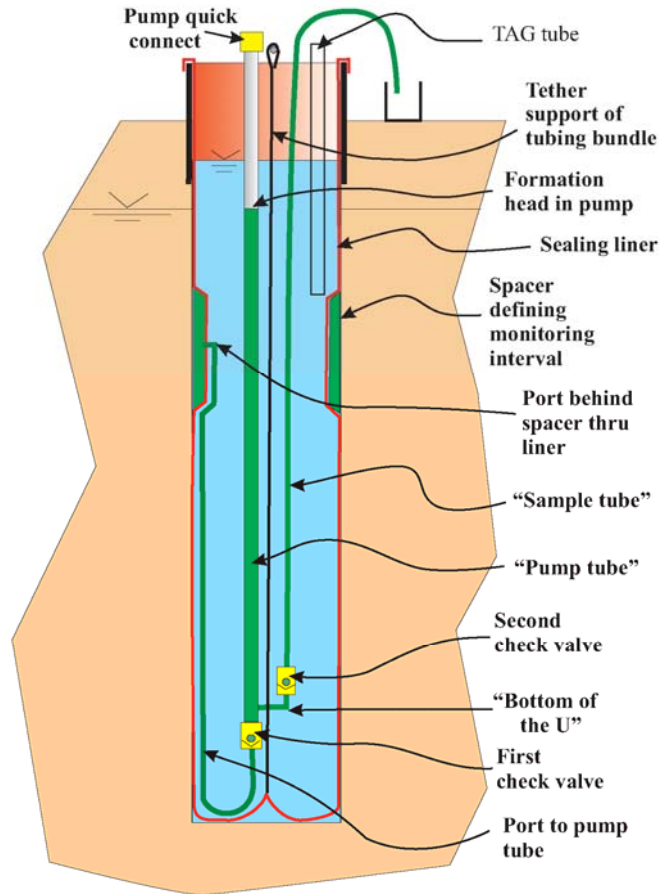

### Installation Methods

The installation of a FLUTE™ system is completed by a trained technician from Flexible Liner Underground Technologies, Inc. The liner is rolled off of a shipping reel and is emplaced into the borehole (Figure 3-2) via an eversion process. Water is added to the interior of the liner, driving the liner deeper into the borehole, pulling the inside-out liner from the reel. It is this interior water pressure that is the driving force for the installation. More details on the installation procedure are provided by Cherry et al. (2007).

**Figure 3-2. Water FLUTE™ Installation at the Watervliet Arsenal**



The installation of a FLUTE™ system is affected by many factors, including depth and diameter of the borehole, the relative transmissivity of the borehole, the depth to the water table, and the rate at which water can be supplied to fill the liner. A FLUTE™ system can be installed in most types of boreholes of varying diameters. Typically, a system can be installed in less than one day. FLUTE™ systems can be removed by pumping out the water inside the liner and pulling the liner out of the well from the bottom up.

### **Operation**

The FLUTE™ system uses compressed nitrogen gas to purge and sample each of the ports installed within the system. The water flows directly from the formation through the spacer and into the sampling tube with the check-valve system, which prevents the water in the tube from contacting the nitrogen drive gas. The compressed nitrogen gas pushes the formation water to the surface. Since the water in the sample tube flows directly from the formation under natural hydrostatic pressure, it is only necessary to purge the small volume of water in the sampling tube before sampling. Because each sampling port/tube is self-contained, several sampling zones can be purged and sampled simultaneously using a sampling manifold.

#### **3.1.2. CMT® System**

##### **Description**

The CMT® system uses a continuous length of polyethylene multichannel tubing. Einarson and Cherry (2002) describe the system in more detail. The number and location of ports may be determined prior to or following drilling the borehole. A port is created in up to seven channels per system to monitor specified depths determined from boring logs or geophysical tests conducted prior to assembly of the system. Three-channel tubing is also available to construct systems with up to three ports. As shown on Figure 3-3, a plug is positioned and sealed in the channel just below the port opening and a stainless steel screen is placed over the port to prevent fines from entering. A vent hole is created just below the seal to allow air to escape as the system is lowered into the borehole. Each channel is sealed at the bottom of the tubing to prevent cross-communication between zones. The CMT® system can be sealed in place using standard sand

and bentonite layers placed via a tremie pipe. Alternatively, bentonite and sand cartridges can be preinstalled at surface prior to installation of the system (van Dijk, 2005).

**Figure 3-3. CMT® System Monitoring Port**

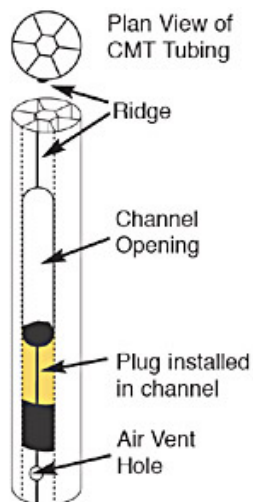

Source: [www.solinst.com/Prod/403/403d7.html](http://www.solinst.com/Prod/403/403d7.html)

### **Installation Methods**

There are two CMT® systems available to accommodate various borehole sizes. The 1.1-inch outer diameter polyethylene tubing is segmented into three channels, providing three depth-discrete sampling zones. This three-channel system was developed for smaller diameter installations, such as when DP methods are used, creating a narrow annulus for seal placement. The 1.7-inch outer diameter polyethylene tubing is segmented into seven channels and allows for up to seven depth-discrete zones of groundwater monitoring.

A CMT® system is built completely above ground and then inserted into the borehole. The tubing is laid out near the borehole and zones are marked on the tubing to show where the channel opening will be created. If packers and/or sand packs are used to seal the zones, they are installed or attached to the tubing in place outside of the borehole prior to installation. However, if the zones are sealed using traditional sand and bentonite layers, a mesh screen is placed over the port inlet holes. The CMT® system is installed as one continuous piece of tubing. The tubing comes in lengths of 100-, 200-, and 300-foot coils. Low-profile borehole centralizers are used to help center the system in the middle of the borehole so that a good seal can be created between the monitoring zones and prevent cross-communication. Once the system is installed into the borehole, alternating layers of sand and bentonite are poured via a tremie-pipe into the annulus. The sand is poured around the monitoring zone, while the bentonite is used to seal the zones.

### **Operation**

CMT® systems can be used for measuring water levels as well as for collecting groundwater samples from up to seven monitoring zones in one borehole (for the larger of the two available sizes). A peristaltic or double-valve pump is used for both purging and sampling groundwater in

these systems. Purging of the monitoring interval is required prior to collecting a groundwater sample. Equipment used for collecting groundwater samples from CMT<sup>®</sup> is dedicated to each channel (e.g., 0.25-inch outer diameter Teflon tubing extending from surface to each monitoring interval) or is disposable, reducing the risk of cross-contamination between monitoring zones at one location.

### 3.1.3. Waterloo System

#### Description

The Waterloo system uses modular components that form a sealed casing string of various casing lengths, packers, ports, a base plug, and a surface manifold (Figure 3-4). Monitoring tubes attached to the stem of each port individually connect that monitoring zone to the surface. Thus, formation water enters the port, passes into the stem, up into the monitoring tube attached to the stem, to its static level. A sampling pump or pressure transducer may be dedicated to each monitoring zone by attachment to the port stem. Dual-stem ports are available to allow both sampling and hydraulic head measurements from the same port. Alternatively, the monitoring tubes may be left open to allow sampling and hydraulic head measurements with portable equipment. A manifold completes the system at the surface. The manifold organizes, identifies, and coordinates the tubes and/or cables from each monitoring zone. The manifold allows connection to each transducer in turn, and provides a one-step connection for operation of pumps. When dedicated pumps are selected, it allows individual zones to be purged separately, or purging of many zones simultaneously to reduce field times.

**Figure 3-4. Waterloo System**

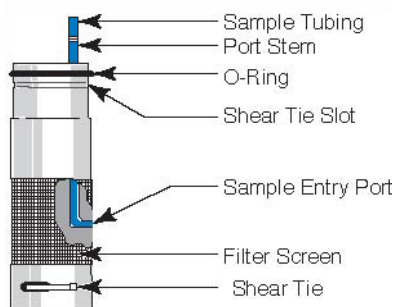

#### Installation Methods

The Waterloo system can be used to monitor multiple zones within unconsolidated formations, as well as in bedrock. There are three methods of system installation:

- Within hollow-stem augers or temporary casing using natural formation collapse
- Within hollow-stem augers, temporary casing, rotasonic (or similar dual-casing methods), or open-bedrock boreholes using standard tremie methods to place sand around the ports and bentonite seals in the annular space between the monitoring zones

- Within open-bedrock boreholes or cased and screened wells, using packers to seal zones

## **Operation**

The maximum number of monitoring zones for a system is determined by the number of tubes and/or cables that will fit inside the casing string. This number is dependent on the monitoring options chosen. Systems can be designed to monitor from two to as many as 24 zones. The most basic version uses open tubes attached to each port. This option allows monitoring with a portable sampler and a narrow-diameter water level meter. A mix of open tubes and dedicated equipment in different zones is also possible. This method combines the advantages of less expensive portable equipment for shallower zones (e.g., <100 ft) and the more time-efficient dedicated equipment for deeper zones.

### ***3.1.4. Westbay System***

#### **Description**

The Westbay system is a modular casing system composed of a single, closed access tube made up of varying lengths of piping. The system is connected by regular couplings as well as two types of valved port couplings (measurement port and pumping port) to seal and provide access to a large number of monitoring zones in a single borehole. Hydraulically filled packers or select backfill are used to seal the annulus between each of the monitoring zones. The access tube is hydraulically sealed during installation by using an end cap at the bottom of the access tube and incorporating O-rings whenever a coupling is used. As shown on Figure 3-5, a typical monitoring zone consists of a measurement port coupling, a magnetic collar that is used to locate each monitoring zone, and a pumping port coupling. The monitoring zone sequence is approximately five feet in length with the magnetic collar placed midway between the two ports, although the actual monitored zone extent may be larger depending on packer placement. As illustrated in Figure 3-5, a single well installation may include dozens of these vertically discrete monitoring zones. Meyer et al. (2008) describe a 36-port system installed to a depth of 430 feet.

**Figure 3-5. Westbay System with Monitoring Ports**

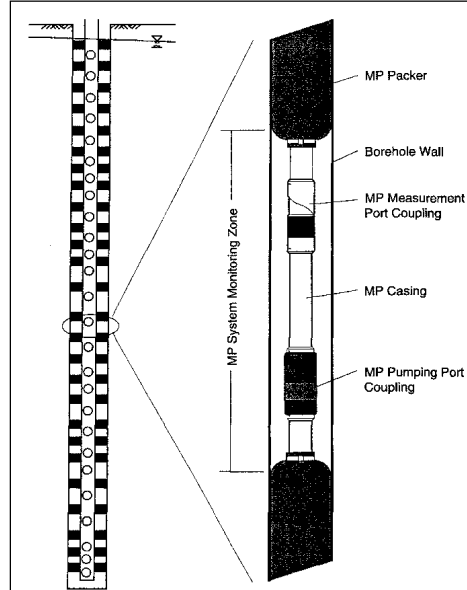

Source: Westbay Instruments Inc. 1992-94, Multi-Level Groundwater Monitoring with the MP System.

The Westbay system utilizes portable, wireline-operated tools to carry out various functions, including water level/pressure measurements, sample collection, and hydraulic tests.

### **Installation Methods**

Casing used for the Westbay systems is available in two sizes to accommodate various borehole sizes. The MP38 System has an inside diameter of 38 millimeters (1.5 inches) and is generally used in boreholes or casings whose inside diameter ranges from three to five inches. The MP55 System has an inside diameter of 55 millimeters (2.25 inches) and is generally used in boreholes or casings whose inside diameter ranges from 3.9 to 6.25 inches. The casing used for the MP38 System consists of plastic, which is typically polyvinyl chloride (PVC), and some stainless steel components. The casing used for MP55 Systems are composed of either plastic or stainless steel.

Westbay systems can be installed in an open borehole, through a temporary guide tube, or in a cased well. There is no limit to the number of monitoring zones that can be installed in a single borehole, except for constraints on borehole depth, monitoring zone length, and packer lengths required to seal between zones. The minimum monitoring zone is about 2 feet using only one type of port, and minimum packer lengths are about 3 feet. An on-site technician from Westbay typically helps the site consultant install the Westbay system and will train the consultant in how to set up and use the system.

### **Operation**

Westbay tools and probes can be controlled by the user at the ground surface by using a MAGI interface, which displays the pressure, temperature, and status of the tool and/or probe. A manual



or motorized winch with a cable connects to the tool and lowers and raises it in the borehole. The winch has a counter to guide the user on the depth of the tool and/or probe in the borehole.

Prior to groundwater sampling or collecting pressure measurements, each monitoring zone must be purged using the pumping port. Monitoring zones in a system can be pumped individually or several at a time. Prior to purging a monitoring zone, the water from inside the casing is removed and all other ports are closed, while the one port is left open. The water that remains in the casing is from the monitoring zone and once this water is removed from inside the casing, the monitoring zone is considered developed and can be sampled. Hydrogeologic tests for assessing hydraulic conductivity (e.g., slug tests) and sampling can be conducted following development. Unlike a conventional long-screen monitoring well, purging is not required prior to sampling a Westbay monitoring zone each time. It is only necessary to develop the monitoring zone once.

A pressure probe/sampling tool is used to measure fluid pressure and to collect groundwater samples from a monitoring zone. The fluid pressure is measured by the MOSDAX® pressure probe, which incorporates a location arm, a backing shoe, a face seal, and a fluid pressure transducer. A groundwater sample is collected by attaching a sample container, which has a sampling valve that can be closed or open, to the pressure probe, which collectively is called a sampling tool. Groundwater samples are collected through the measurement port. A vacuum is created inside the sampling tool before lowering into the borehole. The pressure probe is lowered into the borehole and connects into the measurement port in the same way as that used for measuring fluid pressure of the formation. A sample from the formation is collected once the sampling valve is opened, allowing water from the formation to flow through the probe and enter the sample container. When the sampling valve is initially opened, the fluid pressure decreases; it then recovers as the water in the container builds to the formation pressure. Once the fluid pressure is equal to or slightly less than the formation pressure, the sample container is considered full and the sampling valve is closed and the sample container can be brought to the ground surface.

### **3.1.5. ZIST™ system**

#### **Description**

The ZIST™ system was specifically developed so that a well screen could be isolated, drawdown eliminated, and purge volume could be reduced. The ZIST™ system is essentially a pumping system used to isolate the screened interval of a well. It can be used in conjunction with nested wells installed in a single borehole; however, the number of monitoring zones is very limited. Thus the ZIST™ system may not be considered to be a MLM system in the same category as the other systems. The system consists of a standard PVC well construction in which a pump (0.75-inch or 1.75-inch outer diameter) and sensor/data logger dock into the well screen receptacle located between the well screen and riser pipe (Figure 3-6). When the pump and sensor/data logger are docked, the screened interval is sealed off for monitoring and sampling. A simultaneous control unit is used by the operator to control the pressure of the nitrogen gas being used as the driver to push water up to the surface as well as the rate at which the water is pumped out. This control unit allows for the purging and sampling of multiple zones at the same time.

Various sensors can be placed in-line with the pump to measure pressure and the chemistry of the formation groundwater while operating. When the pump is not operating, the sensor can

detect the same parameters under static conditions in the well screen and groundwater formation only. Electronic down-hole sensors with data loggers, or fiber optic sensors, can also provide information on the pore pressure, temperature, conductivity, and other useful chemical data within the well screen and formation groundwater. Due to the design of the well screen receptacle, the riser pipe water does not come into contact with the water in the monitoring zone, allowing for continuous monitoring of groundwater conditions within the zone between sampling events, and greatly reduced purge volumes during sampling.

**Figure 3-6. ZIST™ System Schematic of Pump and/or Sensor Docked**

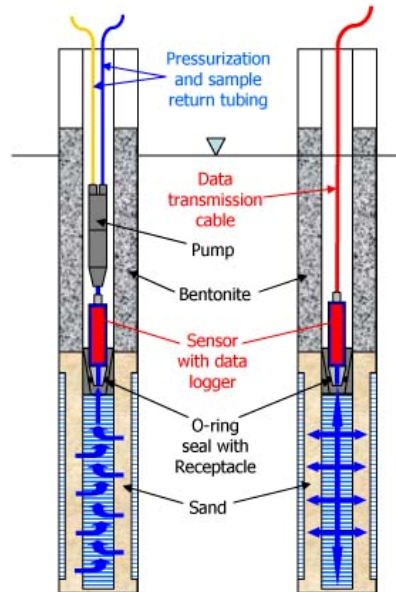

### Installation Methods

The installation of a ZIST™ system is typically completed by the site consultant along with assistance and training from a knowledgeable technician from BESST, Inc. A ZIST™ system can be easily integrated into boreholes or monitoring wells from 0.75 inches to greater than four inches in diameter. The monitoring zones are constructed by pouring sand around the riser screen and pouring bentonite above the sand to create a seal between two monitoring zones and reducing the possibility of cross-contamination.

### Operation

Water in the sample tube is pushed to the surface using compressed air or nitrogen. Because the water in the sample tube flows directly from the formation around the screened interval under natural hydrostatic pressure, it is only necessary to purge the small volume of water in the sample tube before sampling. Because each zone is self-contained with its own pump and tubing, all sampling zones can be purged simultaneously. The tubing, pump, and sensor/data logger can be removed from each well with relative ease in order to download data and maintain system components.

## 3.2. Status of Multi-Level Monitoring Systems

MLM systems are available commercially and have been used at many sites. There is substantial published literature concerning MLM systems and other approaches to depth-discrete groundwater monitoring. Einarson (2006) provides an overview encompassing all types of MLM systems and well nests and clusters used in North America. The manufacturers provide detailed information about their MLM systems on their web sites. The Westbay system, which is described by Black et al. (1986) and a more recent application by Meyer et al. (2008), was the first MLM system to enter the marketplace (in the late 1970s). This was followed by the Waterloo system in the late 1990s. Cherry and Johnson (1982) described an early pre-production version of the Waterloo system and Parker et al. (2006) described a recent version of the Waterloo system installed in rotasonic holes. The CMT<sup>®</sup> system described by Einarson and Cherry (2002) and the FLUTE system described by Cherry et al. (2007) entered the marketplace in the late 1990s. The ZIST<sup>™</sup> nested well system also entered the marketplace in the late 1990s. Each of these systems has been used in numerous investigations of sites distributed across North America, and some of the systems have been used on other continents. There is substantial reporting on the uses of MLM systems in site characterization reports and conference proceedings.

### 3.2.1. Cost

Comparison of costs between MLM/nested well systems are complex and require specifications to narrow the monitoring purpose and scope in the context of the factors listed above, and also inclusion of the labor time required to conduct the monitoring and sampling. The costs for multi-level monitoring systems include the following:

- MLM system purchase and shipment to the site
- MLM system installation labor, including MLM system manufacturer and site personnel
- MLM system installation equipment and materials, including backfill materials
- Labor costs associated with MLM system sampling
- Analytical costs for MLM system sample analysis
- MLM system operations and maintenance costs (where applicable), including maintenance of down-hole equipment (Westbay)
- Purchase or rental of required sampling equipment (particularly for Westbay systems)

After installation, the life-cycle cost of an MLM system will be mostly dependent on the frequency of sampling, the number of samples to be collected, and the labor and equipment necessary to conduct the sampling. For example, the FLUTE system utilized at Watervliet Arsenal required relatively little labor and equipment for sampling and no operations and maintenance costs. Conversely, the Westbay system required a two-person team to efficiently operate and decontaminate the down-hole equipment necessary for sampling, and maintenance of the down-hole equipment (wireline repairs) was required to keep it in proper working condition. Sampling costs for the CMT and nested well systems at Watervliet Arsenal varied, but were generally greater than those of the FLUTE and less than those of the Westbay.

For a comparison of initial system capital costs, vendor quotes were obtained for the ZIST™ system and various MLM systems with the following hypothetical configuration, to enable direct comparisons among the vendors:

- Depth to groundwater: 10' bgs
- Total depth for monitoring: 150' bgs
- Number of monitoring zones: 3
- Geology: bedrock
- Borehole size: 6"
- Capabilities: groundwater sampling and water level measurement
- Channels for CMT: 7
- Installation method: sand and bentonite (i.e., no packers for Westbay or Waterloo systems)

The estimated costs are summarized in Table 3-1 below and are presented in 2008 US dollars. These costs do not include charges for drilling or sampling, or for any other operational costs (e.g., electricity, purged water disposal, decommissioning). Note, however, that each system has inherent capabilities and limitations so that selection based only on cost considerations is not practical, with much more consideration required on the intended monitoring purpose and scope in the context of many of the factors listed above.

**Table 3-1. Initial Capital Cost Comparisons for ZIST™ and Multi-Level Monitoring Systems**

<b>System</b>	<b>Major Components</b>	<b>Estimated Costs</b>
ZIST™ (BESST, Inc.)	Blatymini pumps; teflon tubing; riser pipe; well screens; bentonite pellets	\$7,500 (not including transducers)
	ZIST™ transducer housings; Troll 500 transducers; Troll cables; programming cable	\$17,400 (including transducers)
	ZIST™ training for installation and operation (2 days)	\$3,500 (includes travel and expenses)
CMT (Solinst, Inc.)	CMT-7-Channel tubing; centralizers; wellhead; installation tool kit	\$1,800
	Solinst training for installation and operation (2 days)	\$3,600 (includes travel and expenses)
Westbay (Schlumberger)	Plastic MP38 casing	\$6,400 (casing components)
		\$1,600 (2-day rental of sampling equipment)
		\$33,000 (purchase of sampling equipment)
	Westbay technical services – for training in equipment operation	\$4,000 (includes travel and expenses)
FLUTE	150 ft Water FLUTE with 3 ports	\$10,400 (FLUTE only)
	Ancillary equipment for installation – pump tube; wellhead roller rental; winch plate rental; pump plate rental; shipping reels	\$2,900 (for ancillary installation equipment)
	FLUTE labor to install system	\$6,000 (including travel and expenses)

### **3.2.2. Regulatory Acceptance**

The use of MLM systems (as defined herein) has been accepted by state and federal regulatory agencies in the U.S. as a useful and sometimes required tool to evaluate the vertical distribution of contaminants in groundwater. The use of nested well designs has been generally accepted on both the state and federal levels in many areas of the country. However, some states have placed limits on nested wells due to uncertainty over the integrity of the seals between monitoring zones. Regulatory acceptance of MLM systems for compliance monitoring wells is generally a site-specific decision. In many cases, the use of conventional monitoring wells for compliance monitoring may be required.

### **3.3. Applicable Site Settings and Remedial Technologies**

MLM systems can be used in any geologic setting but are most useful when applied in settings with a high degree of heterogeneity where contaminant distribution cannot be predicted using non-invasive methods (i.e., modeling). Data provided by MLM systems can also be critical in the

design of remedial actions, as well as the evaluation of remedial efficacy. However, it should be noted that, due to the materials used in their construction, some MLM systems may not be compatible with certain remedial technologies (i.e., chemical oxidants or high temperatures). Valuable uses of MLM systems include the following:

- Evaluation of subsurface heterogeneity, including both hydrogeologic properties (i.e., vertical hydraulic gradients and hydraulic conductivity) and contaminant distribution
- Understanding of the distribution of materials used for in-situ remediation, such as chemical oxidants or bioremediation amendments
- Evaluation of the geochemical characteristics of groundwater with depth
- Mass flux discharge evaluation

### **3.4. Advantages and Disadvantages Compared with Other Available Approaches**

A major drawback to the use of traditional groundwater monitoring with two-dimensional measurements includes the method's proven inability to determine where a majority of the contaminant mass is located and migrating due to the often spatially complex distribution of dissolved contaminants; variability of hydraulic conductivity, groundwater flow rate, and direction; and variation in water level (Einarson and Cherry, 2002; Reinhard et al., 1984; Robertson et al., 1991; van der Kamp et al., 1994). Conventional, two-dimensional monitoring also cannot evaluate vertical variability in contaminants and degradation daughter products. Thus, during monitoring of sites where in-situ remediation materials are being injected, two-dimensional monitoring cannot provide data to support evaluation of vertical zones that are not being addressed by the injection strategy and hence not treated or treated less efficiently. This can significantly impact the treatment timeframe.

Moreover, several studies performed in the last two decades show that groundwater samples collected from conventional monitoring wells with relatively long well screens (i.e., 10 to 20 feet) are often significantly biased. In-well blending during sampling can impart a significant negative bias to the samples, resulting in measured concentrations that can be much less than the actual concentrations in the aquifer (Robbins, 1989; Gibs et al., 1993). In addition, ambient vertical flow of groundwater in unpumped long-screened monitoring wells often occurs due to natural vertical pressure gradients in aquifers. Ambient vertical flow can impart a significant negative bias that is not removed by purging prior to sampling (Reilly et al., 1989; Church and Granato, 1996; Hutchins and Acree, 2000; Elci et al., 2001; Elci et al., 2003; Metcalf and Robbins, 2007). Multi-level monitoring wells typically have short intake intervals (<1 m) and are constructed so that vertical flow cannot occur in the wellbores. Thus, samples collected from properly designed and constructed MLM systems are less biased than samples from conventional monitoring wells with long well screens and facilitate more accurate definition of the actual vertical distribution of dissolved contaminants in the subsurface.

Depth-discrete, multi-level monitoring has the ability to evaluate vertical variability in concentrations of parent compounds and daughter products and can identify discrete vertical zones that may or may not have more efficient degradation occurring. It also can assist in evaluating the architecture of DNAPL source zones and allow for the targeting of high-mass

areas during remedial design. Depth-discrete sampling may be more expensive up-front than two-dimensional sampling, due to increased sampling costs and the added costs of MLM system installation, but its use can result in cost savings during in-situ treatment due to optimization of injection strategies to target vertical intervals not being fully treated and to target areas within the source zone with the greatest mass. The optimization can result in greater mass removal rates, shorter remedial timeframes, and lower life-cycle remediation costs.

The advantages of the use of MLM systems and nested wells include the following:

- The ability to assess vertical hydrogeologic characteristics, including hydraulic gradients
- Identification of high-permeability zones and areas of predominant contaminant flux
- Improved CSMs
- Better definition of exposure risks based on the improved understanding of contaminant distribution

Disadvantages include the following:

- Requires the collection of more samples as well as additional costs for system procurement and installation, increasing both analytical and investigation costs. However, each zone may not require sampling during long-term monitoring; this should be evaluated based on initial data from all zones in the system collected during the characterization phase

### **3.5. Summary**

The use of MLM systems and nested wells allows for the evaluation of vertical variability in contaminant concentrations as well as hydrogeologic conditions. Although the use of MLM systems may result in additional costs due to increased sample collection, their use is typically justified by the resulting savings obtained from optimization of subsequent remedial actions and/or additional investigations that may be required to address previously unknown anomalies in vertical contaminant distribution.

## 4.0 ROCK MATRIX CHARACTERIZATION

This section discusses the second of the five types of innovative diagnostic tools introduced in Section 2.0. Until the mid-1990s, NAPL releases in fractured rock environments were thought to pool in rock fractures. As water flowed through NAPL-inhabited rock fractures, the more soluble constituents would partition into the water to generate a plume of dissolved contamination. This plume would expand to downgradient areas from the NAPL-affected area, and the NAPL would continue to reside in the fractures until sufficient dissolution occurred for all of the NAPL to partition to the aqueous phase.

Recent advances in diagnostic tools have modified this conceptualization of fractured rock sites (especially sedimentary rock sites) contaminated with NAPL. Although fractures provide the only pathway for advective transport of groundwater and chlorinated solvents, often the ratio of the void space due to the presence of fractures to the bulk rock volume (“fracture porosity”) is several orders of magnitude less than the matrix porosity of the rock itself. This means that the capacity of the rock matrix to store chlorinated solvent mass is orders of magnitude greater than the storage capacity in the fractures. This matrix storage capacity creates a diffusive gradient by which chlorinated volatile organic compounds (CVOCs) present at high concentrations in the fractures can diffuse into the bedrock pore spaces. Thus, although DNAPL may still exist in some fractures, over time, the majority of the DNAPL that was initially present in the fractures will dissipate due to dissolution and diffusive mass transfer (Parker et al., 1994; Parker et al., 1997). This will cause most of the CVOC mass to reside in dissolved and sorbed phases in the rock matrix and not in the bedrock fractures. In this case, the “rock matrix” is defined as the intergranular porosity of the rock *and* micro-fractures that generally do not contribute to advective groundwater flow, but which behave in a similar manner as the intergranular porosity in terms of the potential for VOC mass storage. This site conceptualization has been verified at several sites throughout the U.S. using a diagnostic tool allowing for the measurement of CVOC mass in rock matrix pore water. This technique involves the collection of small rock core samples over many depths of rock core, followed by crushing and methanol extraction.

### 4.1. Description of Rock Matrix Characterization

Sedimentary bedrock, specifically siltstone, shale, and sandstone, is often referred to as fractured porous media because its primary porosity can range from zero to ten percent (Freeze and Cherry, 1979; Potter et al., 2005). It is the presence of fractures in the rock that provides the main pathways for flow through the rock because the rock pores are generally small and not interconnected. The ratio of the void space due to the presence of fractures to the bulk rock volume (fracture porosity) is expected to be at least a few orders of magnitude lower than the matrix porosity. This large difference between fracture and matrix porosities greatly influences the distribution of chlorinated solvent mass in these deposits. Diffusion halos form along the fractures where DNAPL flow or solute transport has occurred. The halos, and therefore the transport pathways, can be determined from analysis of subsamples of rock core. This approach for pathway identification offers the potential for identifying smaller and/or lower transmissivity fractures than the conventional approaches of well sampling as it allows for the detailed analysis of actual contaminant migration pathways rather than just contaminant presence in relatively large groundwater monitoring zones. The rate of expansion of plumes in fractured rock settings



can be greatly retarded by the diffusion-driven chemical mass transfer from fractures where active flow occurs to the matrix blocks where the pore water is relatively immobile (Freeze and Cherry, 1979). Site-specific proof of this retardation of plume expansion lies in determination of the chemical mass distribution in the rock matrix and fracture network and matrix characteristics.

Dr. Beth Parker and colleagues at the University of Waterloo and University of Guelph (both of Ontario, Canada) have developed a technique to assess chlorinated solvent mass that has diffused into the rock matrix from hydraulically active fractures. This technique is part of a more comprehensive approach for investigating contaminated sites with fractured rock, referred to as the Discrete Fracture Network (DFN) approach, described by Parker (2007).

The rock core sampling and analysis protocol entails the collection of three types of rock core subsamples:

- Rock core samples for analysis of target chlorinated solvent compounds, collected adjacent to fractures and from the rock matrix between fractures, which are crushed and preserved in the field by placing in vials with methanol for extraction and, later, laboratory analysis
- Physical property samples, consisting of intact sections of core that are analyzed for moisture content, matrix porosity, bulk density, specific gravity, hydraulic conductivity, and organic carbon content
- Matrix diffusion samples, consisting of intact sections of core designated for laboratory diffusion tests, oxidant demand batch tests, or other types of tests (e.g., microbial assessment)

The protocol for the collection of chlorinated solvent samples includes collection of samples at fractures (i.e., one of the fracture faces) and bedding planes, at lithologic changes, and from matrix blocks between fractures. Sample lengths typically range from 0.1 to 0.4 feet of core. Chlorinated solvent samples are immediately wrapped in aluminum foil to minimize volatile losses and taken to an on-site field lab for crushing and processing. Prior to crushing, the outer rind of the core samples is chipped off to eliminate potential error from contact with the drilling fluids. Samples are then immediately crushed with a hydraulic rock crusher and placed into sample vials containing a known amount of high-purity methanol to extract and preserve the chlorinated solvent mass. Between samples, the cells are decontaminated using a four-part wash-and-rinse sequence. Field quality assurance and quality control procedures and decontamination procedures are designed to prevent cross-contamination.

Laboratory chlorinated solvent analyses on the preserved crushed rock samples are conducted after allowing sufficient time for the VOCs to completely extract into the methanol. More recently, a microwave-assisted extraction technique has been developed to speed up the extraction. Following the extraction process, an aliquot of methanol is injected directly into a gas chromatograph for separation and quantification using a micro-electron capture detector. The list of target analytes quantified includes TCE, PCE, and the dichloroethene (DCE) isomers, but may be varied depending on the expected contaminants at the site. The direct, on-column injection of methanol onto the gas chromatograph was tailored by the University of Waterloo for analysis of

PCE, TCE, and relevant breakdown products so that the resulting detection limits are very low (0.1 µg/L in methanol for TCE and PCE, and <5 µg/L in methanol for the DCE isomers).

The laboratory analysis provides the total mass of each chlorinated solvent per unit mass of wet crushed rock sample ( $c_t$ ) (e.g., µg VOC per g wet rock) and includes chlorinated solvent mass present in the aqueous, sorbed, and DNAPL (if present) phases. These concentrations are converted to equivalent pore water concentrations using partitioning calculations (see Feenstra et al., 1991) with measured or estimated rock matrix parameters (bulk density, porosity, and sorption). In this case, equivalent pore water concentrations ( $c_w$ ) were estimated using:

$$c_w = c_t \frac{\rho_{bwet}}{R\phi} \quad \text{(Equation 4-1)}$$

where  $\rho_{bwet}$  is the rock wet bulk density (g/cm<sup>3</sup>),  $\phi$  is the porosity and R is the retardation factor, accounting for VOC mass sorbed to organic carbon present in the rock. Retardation factors (R) were estimated using the relation:

$$R = 1 + \left[ \frac{\rho_b}{\phi} \right] K_d \quad \text{(Equation 4-2)}$$

where  $K_d$  is the distribution coefficient (mL/g) and  $\rho_b$  is the dry rock bulk density (g/cm<sup>3</sup>). It is assumed that sorption is rapid, linear, and reversible.

## 4.2. Status of Rock Matrix Characterization

Since its introduction in the late 1990s/early 2000s, rock matrix characterization has steadily gained acceptance from both state and federal regulatory agencies, as well as public and private responsible parties, as an integral component of the characterization of sites where Type IV and Type V geologic settings exist, such as bedrock aquifers that have been contaminated with chlorinated solvents.

### 4.2.1. Applications to Date

To date, rock matrix characterization has been used at more than 15 sites in the U.S. and Canada, including both state-regulated inactive hazardous waste sites and sites regulated by the USEPA under the Comprehensive Environmental Response, Compensation, and Liability Act (“Superfund”). Most applications have focused on chlorinated solvents; however, at least one application has also included the evaluation of polychlorinated biphenyls (PCBs). Rock matrix characterization results have been used for the following applications:

- Optimization of placement of multi-level groundwater monitoring systems
- Chlorinated solvent mass “tracking” to identify potential advective plume migration pathways
- Contaminant mass discharge assessments

- Remedial action planning
- Evaluation of remedy effectiveness
- Documentation of TI evaluations and support for determination of TI zones

#### **4.2.2. Commercial Status**

The rock matrix characterization technique has recently been trademarked under the trade name of COREDFN™ (Characterization of Rock Environments – Discrete Fracture Network Approach) and is commercially licensed to Stone Environmental, Inc. of Montpelier, Vermont.

#### **4.2.3. Cost**

The cost of rock matrix characterization is dependent on several factors, including the number of sampling locations, depth of coring, vertical sample spacing, number of sample analytes, and whether an on-site laboratory is used. Trained field staff should be present during the drilling program to collect and effectively process the samples. Based on project costs for investigations conducted in the last five years, the typical cost is in the range of \$150 to \$170 per linear foot of core analyzed (assuming that one sample is collected on average per foot of core). If an on-site laboratory is used, the cost is in the range of \$180 to \$200 per linear foot of core analyzed. These costs do not include drilling costs, which vary greatly by location, type of rock, size of core, and total drilling depth.

### **4.3. Applicable Site Settings and Remedial Technologies**

The rock matrix characterization technology can be used at any site where bedrock groundwater has become contaminated with organic compounds, particularly chlorinated solvents. However, it has been shown to be most valuable in geologic settings consisting of fine-grained sedimentary rock such as shales and siltstones. The technology is integral in remedial action decision-making for fractured rock sites and can also be used to evaluate the efficacy of in-situ remedial technologies such as chemical oxidation, bioremediation, and thermal treatment.

### **4.4. Advantages and Disadvantages Compared with Other Available Approaches**

Rock matrix characterization has an advantage over conventional fractured rock field investigation methods for the following reasons:

- The technology is capable of detecting contaminant migration pathways on a much smaller scale than conventional geophysical or multi-level groundwater sampling techniques
- Matrix contaminant analyses provide a direct, and much more accurate, measure of contaminant mass distribution because the rock matrix frequently constitutes nearly the entire contaminant mass storage capacity
- The extent of diffusive contaminant halos in the matrix adjacent to fractures can be used as an indicator of the time since contaminant arrival on a fracture-by-fracture basis

- Borehole cross-contamination is avoided because the low-permeability matrix is not easily cross-contaminated during drilling and core retrieval prior to sample collection

Although many conventional techniques for borehole logging and hydraulic testing exist (e.g., Sara, 2003), general agreement in the literature indicates these techniques are severely limited in their prospects for providing quantitative information about the length and interconnectivity of the fractures in fracture networks (NRC, 1996; Berkowitz, 2002). Chlorinated solvents have been in the subsurface beneath many industrial properties for several decades, allowing plumes to migrate downgradient several hundreds to thousands of feet or more. These contaminants can now serve as tracers to study contaminant migration over the large space and time scales most relevant in contaminant hydrogeology. The physical and chemical properties of the common chlorinated solvents make them good indicators of the physical hydrogeologic system characteristics, including the fracture network connectivity and distribution of groundwater flow.

Essentially all conventional fractured- rock borehole test methods relevant to the hydraulic conditions and properties, except for depth-discrete multi-level monitoring (Sara, 2003), are done in open holes into which data acquisition equipment is inserted down-hole. Flow metering, fluid resistivity, and conventional down-hole temperature logging and full-hole borehole dilution tests pertain to imposed (forced advection) hydraulic conditions, by applied fluid pressure as in the case of packer tests, or vertical flow in the open hole caused by the hole itself (borehole cross-connection between fractures). Price and Williams (1993), Sterling et al. (2005), and others have demonstrated that open holes in fractured rock commonly have borehole cross-connections that disturb the hydrochemical conditions.

The main disadvantage of the rock matrix characterization technology is the added cost required to implement the technology due to the detailed sampling that is required. However, this cost has been justified at sites where the results of the characterization have been used to demonstrate the futility of costly long-term remediation strategies that may have otherwise been implemented.

#### **4.5. Summary**

The distribution of contaminants within chlorinated solvent plumes in fractured sedimentary rock has strong spatial variability due to heterogeneity in source zone contaminant mass distributions, fracture network, and matrix characteristics, accompanied by temporal variability in groundwater flow. One major reason why so little is known about contaminant migration and fate in fractured sedimentary rock is that traditional research approaches involve only sampling water from the fractures. However, field studies using the rock core VOC analysis method show contaminant mass storage is dominated by the rock matrix rather than the fractures, and the contaminant concentrations in the fractures and the matrix are not in equilibrium (Hurley and Parker, 2002; Sterling et al., 2005). Therefore, sampling only the groundwater from the fractures cannot provide the overall mass distribution. Furthermore, when conventional boreholes are drilled, the water from a fracture in one section of the borehole migrates to another section of the borehole due to differences in head between the two sections. This creates an un-natural flow and contaminant transport condition within the system known as borehole cross-connection. This condition will also persist across the screened interval of a conventional monitoring well, and as a consequence, results from sampling the well do not reflect the natural system (Price and Williams, 1993; Sterling et al., 2005).

Based on this information, for fractured-rock subsurface environments, rock matrix characterization provides contaminant mass and phase distributions more relevant to contaminant behavior than those obtained from monitoring wells or other types of borehole water sampling alone.

## 5.0 MASS FLUX MEASUREMENT TOOLS

Mass flux measurement is the third innovative diagnostic tool addressed in this ESTCP study. The sections below describe mass flux measurement techniques and their respective capabilities and constraints, and provide an evaluation of the use of mass flux as a diagnostic tool.

### 5.1. Description of Mass Flux Measurement Techniques

The terms “mass flux” and “mass discharge” are often used interchangeably, but refer to different measurements, as indicated by their units. Contaminant mass discharge,  $M_d$ , with units of mass per time, is defined as the total mass of contaminant conveyed by a plume per unit time across a vertical control plane or “transect” perpendicular to the groundwater flow direction (Equation 5-1). This measurement is useful for defining the amount of contaminant mass within a plume flowing past a measurement plane in the aquifer (e.g., grams per day) and can be used as a metric for assessing the mass transport throughout an entire plume. Contaminant mass flux,  $J$ , with units of mass per time per unit cross-sectional area, describes the local rate of contaminant migration within the aquifer, and is more useful for assessing variation in contaminant concentrations and flow within a dissolved plume (Equation 5-2). Mass flux,  $J$ , can exhibit significant variation within a dissolved plume given the strong variations in contaminant concentrations, hydrogeologic parameters, and groundwater flow typical of most dissolved plumes (Guilbeault et al., 2005). Some refer to “mass discharge” as “total mass flux” (i.e., local fluxes integrated across the entire plume cross-section). Others refer to mass discharge as “mass flow.” In Europe, some refer to mass discharge as “mass emission.”

$$M_d = \int_A J dA \quad (\text{Equation 5-1})$$

Where

- $M_d$  = Contaminant mass discharge (M/T)
- $A$  = Area of the transect ( $L^2$ )
- $J$  = Spatially variable contaminant mass flux, as defined in Equation 5-2

$$J = q_0 C = -KiC \quad (\text{Equation 5-2})$$

Where

- $J$  = Contaminant mass flux ( $M/L^2T$ )
- $q_0$  = Darcy groundwater flux ( $L^3/L^2T$ )
- $K$  = Saturated hydraulic conductivity (L/T)
- $i$  = Hydraulic gradient (dimensionless)
- $C$  = Contaminant concentration ( $M/L^3$ )

Use of mass flux and mass discharge estimates in the field of contaminant hydrogeology is not new. Numerical simulations of groundwater contamination incorporate water and solute mass fluxes into and out of model cells (Anderson and Woessner, 1994). In the context of numerical simulations, mass flux and mass discharge are typically referred to as the local and integrated “mass loading” from source zones or recharge into the model domain. In numerical simulations, rates of contaminant mass loading are often assumed or estimated based on water balances and

solute concentration measured in samples collected from monitoring wells located near the contaminant source zones.

However, in the last decade there has been increased recognition that mass discharge is a key indicator of the severity or “strength” of a contaminant release, particularly as it relates to potential risks to downgradient receptors (Feenstra et al., 1996; Einarson and Mackay, 2001; Rao et al., 2001). Consequently, there has been considerable interest in developing and validating field methods for measuring this important variable at contaminated sites. So, while the concept is not a new one, the desire to directly measure mass flux/mass discharge at field sites is relatively new. Contaminant mass discharge is typically measured downgradient of the source zone but can also be used to assess contaminants migrating towards the source zone from upgradient, or to monitor processes occurring within large source zones.

Mass discharge may be used in evaluations of potential or existing impacts to downgradient water supply wells and surface water bodies. Given the importance of this variable in evaluations of potential risks to downgradient receptors, many scientific and regulatory groups have recommended that designers of in-situ remediation programs focus their efforts on reducing contaminant mass discharge rather than attempting to reduce contaminant concentrations to numerical standards. In heterogeneous geologic media, focusing remediation efforts on the high-flux zones can often result in significant reductions in contaminant mass discharge and more efficient (in terms of mass removed per dollars spent or gallons treated) remediation.

In practice, a significant advantage of measuring mass discharge is that contamination trends and their implications may be more easily identified. For example, concentrations may decline at different times and rates in spatially distributed monitoring wells in response to upgradient treatment, making it difficult to quantify the overall effectiveness of treatment. Mass discharge provides a meaningful way to express average concentration reductions across the plume and support conclusions regarding treatment efficiency. Mass discharge measurements can provide a different perspective on the magnitude and average impact of site contamination. For example, high concentrations in one well may be recognized to be of relatively minor significance if contaminant mass discharge from the site is low overall, i.e., only a small total mass of contaminant per unit time actually migrates with the groundwater. Mass discharge is therefore an integrated measurement of dissolved contaminants flowing in the subsurface and is becoming an important element in evaluations of engineered remediation programs and MNA evaluations.

While contaminant mass discharge values are very useful metrics of the overall strength of contaminant plumes, definition of local mass fluxes can also be important. For example, if active remediation of the dissolved plume is necessary (e.g., with a permeable reactive barrier (PRB)), one must know where the high-flux zones are in order to ensure treatment in those zones. Similarly, if source zone treatment is needed, “back-tracking” from the high-strength plume cores identified in a sampling transect is a useful way to identify the approximate position of residual NAPL or highly-contaminated soil in the upgradient source zones (e.g., Kram et al., 2001).

While all the methods described in this section are intended to measure mass discharge, some methods are better than others for defining the local mass fluxes. Dense point measurements of mass flux using discrete samples or PFMs are better than pumping methods that average

concentrations. So, if designing targeted in-situ remediation is a goal, point measurements may be better because they define local mass fluxes as well as integrated mass discharge.

In summary, mass flux and mass discharge measurements offer a variety of benefits for risk evaluations and plume remediation programs, as described further in Section 4.3, including the following:

- Better assessments of potential impacts to downgradient receptors resulting from subsurface releases of dissolved solutes. The risk to downgradient supply wells and surface water bodies is directly related to the rate of contaminant migration in dissolved plumes, not necessarily contaminant concentrations. Thus, cleanups can be prioritized based on mass discharge values; sites with the highest mass discharge values (i.e., sites that pose the greatest risk to downgradient receptors) can be cleaned up first
- Easier gauging of the impact of remedial efforts on risk reduction to downgradient receptors
- A more holistic, integrated evaluation of site groundwater contamination. Mass flux/mass discharge measurements may improve identification of contaminant trends and their implications. This typically results in a better diagnosis of the problem and more accurate and definitive performance monitoring of in-situ remediation programs
- A possible re-focus of remedial efforts at complex, heterogeneous sites where it may be technically impracticable to meet target concentrations
- Possibly more focused remediation, shorter duration of treatment, and/or more focused monitoring programs, resulting in cost savings and accelerated site closure

There are a variety of published measurement techniques for mass flux and mass discharge, as listed in Table 5-1.



**Table 5-1. Mass Flux/Mass Discharge Measurement Methods**

Measurement Technique	Typical Pumping Required	Key References
Synoptic sampling	Minutes	Einarson and Mackay, 2001; Farhat et al., 2005; Kubert and Finkel, 2006
PFM	None	Annable et al., 2005; Campbell et al., 2006; de Jonge and Rothenberg, 2006; Hatfield et al., 2004; Hatfield et al., 2001
SSP	Days to weeks	Einarson and Mackay, 2001; Buscheck, 2002
RFM	Days to weeks	Goltz et al., 2009; Huang et al., 2004
Integral pumping tests (IPTs)	Days to weeks	Bauer et al., 2004; Bayer-Raich et al., 2004; Bockelmann et al., 2003; Bockelmann et al., 2001
Modified integral pumping tests (MIPTs)	Days to weeks	Brooks et al., 2008

**5.1.1. Strategy for Improving Mass Discharge/Mass Flux Estimates and Reducing Costs**

Several studies performed in the last decade show that plumes of VOCs emanating from NAPL source zones have high-strength plume cores that convey most of the dissolved contaminant mass. Guilbeault et al. (2005), in a detailed study of four VOC-contaminated sites, concluded that 80 to 90% of the dissolved contaminant mass is flowing in 10 to 20% of the cross-sectional area of the dissolved plumes. Consequently, it is vital that any measurements of contaminant mass flux and mass discharge incorporate the high-strength plume cores. This can be accomplished in one of two ways. First, dense grids of sampling points, PFMs, or pumping wells can be installed without a priori knowledge of the locations of the plume cores. Dense grids are necessary in order to minimize the chance of missing one or more of the VOC plume cores, which would result in significant errors in the mass discharge and mass flux measurements. There have been studies of sampling point densities needed to minimize these types of errors, some of which state that as much as 7% of the cross-sectional area of the plume transect may need to be sampled in order to reduce the uncertainty to an acceptable level (Li et al., 2007).<sup>1</sup> Indeed, criticisms of mass flux field measurement methods often focus on the high density of sampling points necessary to reduce sampling errors (Kubert and Finkel, 2006).

Another approach, which is strongly recommended by the authors, is to pre-characterize the stratigraphy and solute distribution along the transects, if possible, using rapid, low-cost methods such as DP lithology sensors (e.g., cone penetrometer testing (CPT), electrical conductivity (EC) probes, or hydraulic profiling tools) and in-situ chemical sensors (e.g., membrane interface

<sup>1</sup> The density of sampling points can be reduced by following a staged sampling program as described in a recent publication by the same authors (Li and Abriola 2009).

probes).<sup>2</sup> That way, zones of high permeability and high solute concentrations can be identified prior to instrumenting the site to make the mass discharge/mass flux measurements. Pre-characterizing stratigraphy and solute distribution allows site investigators to focus their mass flux measurements on the high-flux plume cores. This greatly increases the accuracy and reduces the costs of the mass flux/mass discharge measurements. Information on DP lithology and chemical sensors has been summarized by McCall et al. (2006).

Precision and accuracy of different mass discharge techniques is described further in Section 5.3. Accuracy of mass discharge measurements is clearly important for risk evaluations, for example, if one is interested in estimating the highest concentration of a contaminant that could occur in water pumped from a downgradient supply well. Precision, on the other hand, may be more important for performance monitoring, where the goal is to collect “before and after” measurements to document the performance of an in-situ treatment program.

A brief description of six mass discharge measurement methods, listed below, is presented in this section:

1. Synoptic sampling
2. PFMs
3. SSP
4. RFM
5. IPTs
6. MIPTs

Information on cost and the relative advantages/disadvantages of the first four methods, as evaluated in Malcolm Pirnie et al. (2010), is presented in Sections 5.2.4 and 5.4, respectively.

### ***5.1.2. Synoptic Sampling***

Synoptic sampling, also known as “snapshot sampling” or the “transect method” is illustrated in Figure 5-1. To implement this method, a transect of monitoring wells or DP sampling points, either single-level or multi-level, is sampled using standard procedures. Contaminant concentrations are then used in conjunction with other site information (e.g., hydraulic gradient, distribution of hydraulic conductivity, Darcy flux, plume cross-sectional area, and groundwater flow direction) to estimate the total mass per unit time of contamination flowing through the vertical plane. If plume concentrations or groundwater fluxes vary vertically (which is typical), multi-level monitoring can be used to more accurately define the local mass fluxes and estimate the overall mass discharge. Clusters of short-screened monitoring wells or multi-level monitoring systems also reduce or eliminate many of the errors that bias samples collected from conventional single-interval monitoring wells (see Chapter 3 herein and Einarson (2006) for further discussion). And, as discussed above, information about the spatial distribution of solute

---

<sup>2</sup> Plumes of inorganic solutes may also be “pre-characterized” this way. For example, if an inorganic plume exhibits higher EC than surrounding groundwater, tools like CPT or hydraulic profiling may be used to define the stratigraphy, with EC measurements used to identify anomalously conductive pore fluids corresponding to the location of the inorganic contaminant plume.

mass fluxes in the aquifer may be needed for designing effective in-situ remediation programs that target the high mass flux zones.

**Figure 5-1. Synoptic Sampling of Wells along a Transect**

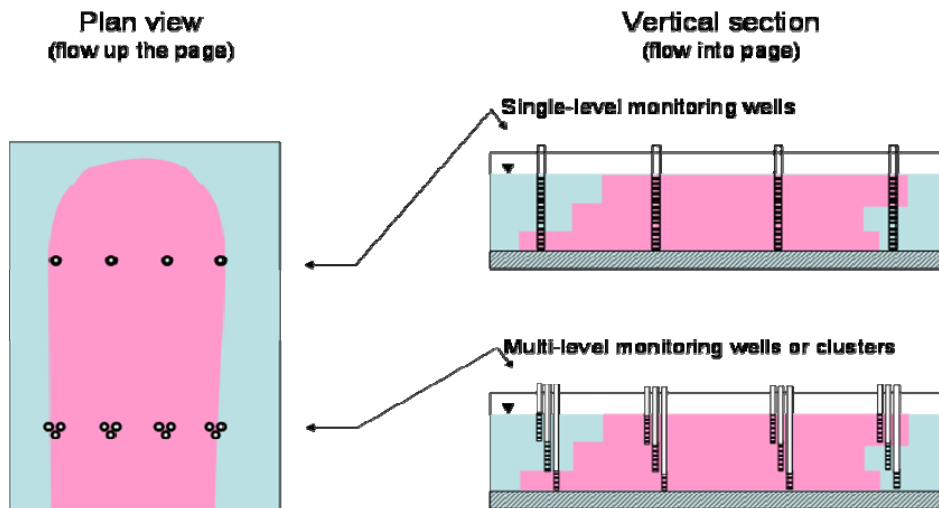

Each sampling event yields a separate estimate of mass flux/mass discharge. The frequency of mass flux/mass discharge monitoring varies with the objectives; monitoring may occur only once or twice or it may be conducted routinely (e.g., quarterly or annually). The spacing between monitoring wells along the transect is site-specific; studies at Vandenberg AFB by UC Davis demonstrated that mass flux measurements are more accurate (error less than  $\pm 25\%$ ) when well spacing was less than the width of high-concentration subplumes within the target plume (Malcolm Pirnie et al., 2010). The authors noted that estimates of hydraulic conductivity and other terms needed to calculate mass discharge are typically less well-defined; measurements of hydraulic conductivity often vary by a factor of ten or more and would therefore lead to significant uncertainty in the mass discharge estimates. For monitoring the performance of in-situ treatment systems, however, precision may be more important than accuracy; the difference between two measurements (e.g., before and after remediation), may be the most critical data needed to judge the effectiveness of the treatment.

### **5.1.3. Passive Flux Meters**

The second method involves passive sampling of a transect of borings or monitoring wells using PFMs. A PFM is a self-contained permeable unit that is inserted into a well or boring so that it allows groundwater flow through the device (Figure 5-2). The interior composition of the PFM is a matrix of a permeable sorbent that retains dissolved contaminants present in the groundwater intercepted by the unit. The PFM can be used for a broad range of contaminants (e.g., hydrophobic organic compounds, organic or inorganic ions) by selecting appropriate sorbent matrixes. The sorbent matrix is preloaded with specified amounts of one or more resident tracers that have a known range of affinity for the sorbent. These tracers are displaced from the sorbent at rates proportional to groundwater flux and the tracer retardation on the sorbent. After a specified period of exposure to groundwater flow (typically one to two weeks), the PFM is removed from the well or boring. The sorbent is then carefully extracted to quantify the mass of

all contaminants intercepted by the PFM and the residual masses of all resident tracers. The contaminant masses are used to calculate time-averaged contaminant fluxes, while residual resident tracer masses are used to calculate cumulative groundwater flux.

Depth variations of both water and contaminant mass fluxes can be measured in an aquifer from a single PFM by vertically segmenting the exposed sorbent packing and analyzing for resident tracers and contaminants. Thus, at any specific well depth, an extraction from the locally exposed sorbent yields the mass of resident tracer remaining and the mass of contaminant intercepted. Using this mass estimate (along with the average rate of contaminant migration through each well, termed “local flux,” and the estimated hydraulic performance of the well screen and sand pack), the mass per unit time migrating past the transect is estimated. The development and testing of PFMs is described in detail by Annable et al. 2005 and Hatfield et al. 2001, 2004. PFMs are commercially available from EnviroFlux, LLC. Their contact information is provided in Appendix B.

EnviroFlux, LLC provides guidance on the design of flux assessments and monitoring programs, furnishes the PFMs, analyzes the PFMs at their laboratory, and calculates mass flux values based on the results of their chemical analyses and site-specific information about the sites and deployments provided to them by their customers.

**Figure 5-2. Passive Flux Meter Method**

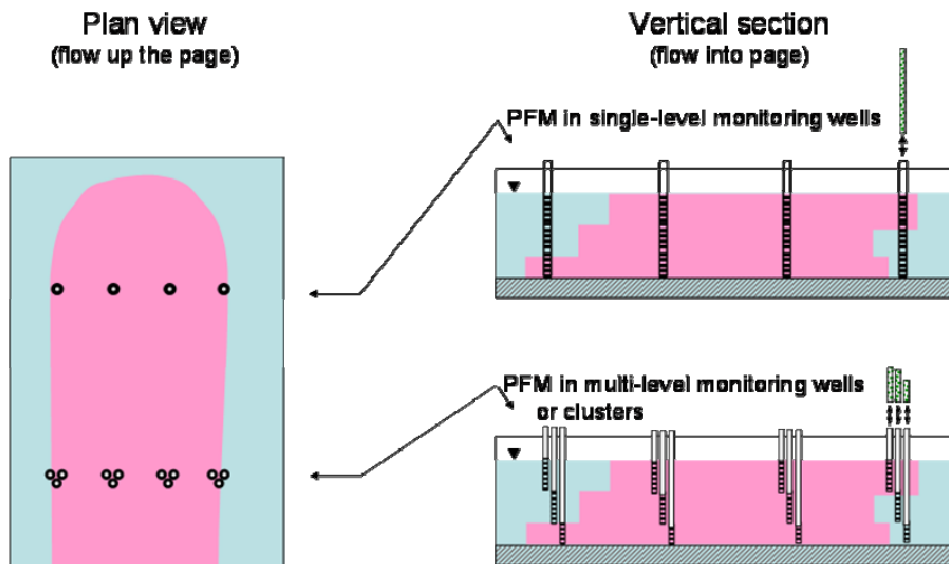

Note that this method integrates mass discharge temporally but not spatially; that is, the data are still point measurements. Mass discharge values are calculated using mathematical integrations (e.g., Thiessen polygon method) similar to those performed using the transect method described above. The PFM method has the advantage of collecting data to represent average flow characteristics without the need for pumping or calculating Darcy flux using assumed or measured values of hydraulic conductivity, which can vary considerably over depth or hydraulic gradient. By incorporating a tracer into the PFM as well as contaminant sorption, the amount of

flow through each section of the transect can be estimated as well as the average concentration of contaminant passing through that area. Separate testing to estimate hydraulic conductivity throughout the transect is therefore not needed. Each deployment of flux meters thus results in one estimate of the average contaminant mass discharge during the period of time that the PFMs are deployed in the wells.

Limitations of the technology include a limited (but growing) list of analytes that can be measured with the devices. Interested readers should contact EnviroFlux for the latest list of analytes that can be measured with PFMs. In addition, results of the PFMs are provided by the vendor with some concerns over the transparency of the calculations. Also, calculation of mass and groundwater flux relies on information of the well geometry and construction in order to estimate the portion of the aquifer that flows through the PFM. Errors or uncertainty in the well construction are carried over to the mass flux estimates. As discussed above, PFMs can be installed in conventional single-interval monitoring wells, then segmented and analyzed in order to obtain information about vertical variations in mass and groundwater flux. Viton washers have been designed and deployed at many sites to minimize vertical flow down the wellbore that could bias the results.<sup>3</sup> However, while the washers may prevent ambient vertical flow within the well casing, the washers do not prevent vertical flow in the sand pack surrounding the well screens.

Field tests of PFMs at a highly-controlled field site in Canada noted some concerns with ambient vertical flow through sand packs surrounding monitoring well casing, potentially changing the average groundwater flow velocity and calculated mass flux (Annable et al., 2005). It is recommended that monitoring wells be constructed without the use of a sand pack allowing formation collapse for depth-discrete flux measurement using PFMs. If a sand pack is required, thin layers of low-permeability material (e.g., fine sand or bentonite) placed in the annular space every few feet can prevent significant ambient vertical flow within the sand packs.

Finally, the design of PFMs results in a small amount of chemical tracer being released into the aquifer. These tracers are commonly alcohols that readily degrade in the subsurface. Local environmental regulations may prevent or control releases of chemical tracers, even in very small quantities, to the subsurface. Relevant regulatory agencies should therefore be consulted prior to using PFMs to measure mass flux.

#### ***5.1.4. Steady-State Pumping***

The third mass flux measurement method, steady-state pumping (SSP), makes use of one or more extraction wells located along a transect to capture the plume. The extraction wells are pumped until steady-state plume capture is reached, at which time the total extraction rate is measured, as well as the contaminant concentration in a single composite sample collected from the extraction system (Figure 5-3). An important advantage of pumping methods for measuring mass discharge over point measurements (either synoptic point measurements or PFMs) is that pumping physically integrates the contaminant mass, as opposed to mathematical integrations

---

<sup>3</sup> Vertical flow in monitoring wells occurs in response to vertical hydraulic gradients within the geologic strata screened by the well. This can create a significant bias in samples collected from the wells. Studies by Elci et al (2001) and others suggest that this bias is common.

that must be performed with the point measurements. That results in fewer wells being necessary to measure mass discharge than with the point measurement methods.

Contaminant mass discharge is the product of the flow rate and concentration (Equation 5-3). This method has the advantage of calculating contaminant mass discharge directly, without having to estimate or measure the groundwater discharge (Darcy fluxes), a source of considerable error in the synoptic sampling method. Note that if multiple pumping wells are installed along the transect, they can be sampled independently in order to gain knowledge of the local mass fluxes along the transect, e.g., for designing focused in-situ remediation systems.

$$M_d = C_{\text{comp}} \cdot Q_{\text{total}} \quad (\text{Equation 5-3})$$

Where

- $M_d$  = Contaminant mass discharge in the captured plume (M/T)
- $C_{\text{comp}}$  = Concentration of the target contaminant in a composite sample from the extraction system (M/L<sup>3</sup>)
- $Q_{\text{total}}$  = Total rate of groundwater extraction (L<sup>3</sup>/T)

**Figure 5-3. Steady-State Pumping of a Well or Wells along a Transect**

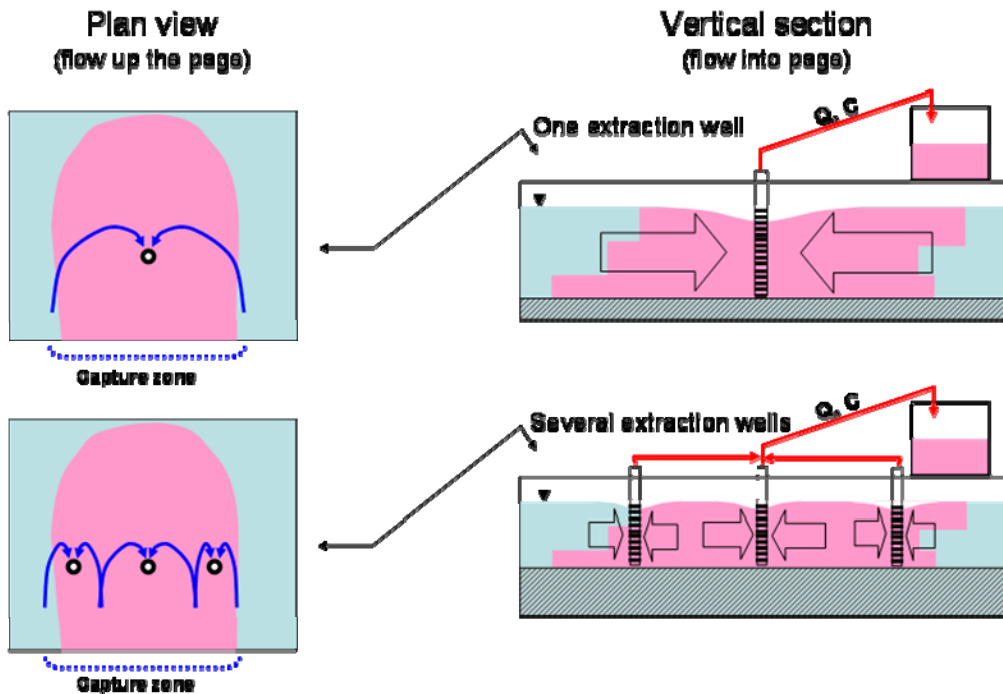

SSP tests are analogous to using data from pump-and-treat remediation systems to calculate mass discharge. With a pump-and-treat remediation system that fully captures the contaminant plume,

mass discharge can be calculated using Equation 5-3 (see Buscheck et al. (2003) for further discussion of using data from pump-and-treat systems to estimate contaminant mass discharge).<sup>4</sup>

Typically, each test results in one estimate of mass discharge. If SSP is conducted continuously (i.e., as part of a groundwater extraction and treatment system for remediation and/or containment), multiple estimates of mass discharge can be calculated over time.

The number and locations of pumping wells is based on the knowledge of the subsurface geology, flow system, and contaminant distribution. Methods used to design the SSP well network are the same as those used to design pump-and-treat well networks. However, the time to reach steady-state plume capture can be reduced by using multiple wells to reduce well spacing, similar to approaches used in construction dewatering projects (Einarson and Mackay, 2001). Additional capital costs may be significant, however, especially where plumes are relatively deep.

Incomplete capture of the plume(s) may occur, causing a negative bias in the calculation, if the extraction wells are not pumped long enough to fully capture the dissolved contaminants within the capture zones of the wells. For example, in the case of a dissolved plume located at the edge of a well's capture zone, pumping must continue long enough for the dissolved plume to be drawn into the well. For monitoring transects designed to have the fewest number of extraction wells possible (i.e., with the widest capture zones possible given the hydraulic properties of the aquifer, available drawdown, and other constraints), hydraulic capture of particles at the margins of the capture zone may take a considerable period of time (days, weeks, or months). Mass discharge values calculated prior to capture of the contaminants flowing at the edge of the capture zone would therefore be erroneously low.

“Over-capture” of the plume(s), on the other hand, can lead to overestimates of contaminant mass discharge if calculations are made prior to the well(s) reaching steady-state conditions. For example, for a scenario in which the steady-state capture zone of a well extends a significant distance laterally beyond the edges of the dissolved plume(s), initial pumping of the well will draw contaminants into the well from all sides at relatively high rates. Mass discharge values calculated using Equation 5-3 at this time would be relatively high. Over time, clean water bounding the dissolved plume(s) would be drawn into the well, reducing the average concentrations of the target analyte in the effluent. Accurate values of contaminant mass discharge could only be made once the clean water flowing along the lateral edges of the well's capture zone had reached the well. As in the example above, this could take weeks or months for wells having large capture zones. Calculations made prior to this would be positively biased, that is, overestimating the steady-state contaminant mass removal over the long term.

Pumping at rates higher than the optimal rate is undesirable because groundwater is then drawn into the pumping wells from downgradient and cross-gradient directions, which increases the

---

<sup>4</sup>A well-designed existing pump-and-treat systems therefore constitutes an ideal mass discharge monitoring system. Flow rates and effluent concentrations in the pump-and-treat system can be monitored before, during, and after source zone remediation. If the monitoring data show that the source zone treatment has achieved the desired reduction in mass discharge, the pump-and-treat system may be turned off. It could be reactivated periodically, if desired, however, to confirm that the reductions in mass discharge are being sustained.

time for the contaminant flowlines to reach steady-state conditions. Consequently, the best practical approach may be to perform SSP tests in a stepped fashion, starting with a combined extraction rate that is suspected to be somewhat less than the natural flow of groundwater through the transect (e.g., ~70% of the estimated natural flow of groundwater). This approach is described by Yoon (2006) and Goltz et al. (2007). The wells would be pumped at that combined extraction rate and composite samples of the pumped water would be collected over time and analyzed for the target contaminant. Once the calculated mass discharge value reaches a steady value, the extraction rates of the wells would then be increased. Again, composite samples of the pumped water would be collected and analyzed, and the calculated mass discharge values plotted over time. Additional increases in pumping rates could be added until the calculated mass discharge using Equation 5-3 no longer increased as greater volumes of water are extracted. At that point, the wells should be capturing the entire dissolved plume(s) of the target contaminants. Additional discussion about the SSP method is presented in Einarson and Mackay (2001) and Buscheck (2002).

The act of pumping may influence contaminant distribution, thereby changing mass discharge/mass flux measurements. For example, in a fractured rock environment, the SSP method can draw water from less transmissive zones or “dead-end” fractures that do not contribute to mass flux/mass discharge under ambient conditions. This water may have high concentrations of contaminants present in low transmissive zones, resulting in an overestimate of mass flux/mass discharge.

#### ***5.1.5. Recirculation Flux Measurement***

The fourth method for measuring mass discharge is called recirculation flux measurement (RFM). As illustrated in Figure 5-4, the RFM technique uses pairs of extraction and injection wells located along a transect to induce recirculation of groundwater between each well pair. Recirculation can also occur below ground, with wells screened at two different depths, promoting horizontal recirculation in both the shallow and deeper aquifer. With this method, a large volume of groundwater can be evaluated without the need to extract and treat large volumes of contaminated water.

In the RFM method, mass flux is calculated using values of hydraulic conductivity, hydraulic gradient, and solute concentration determined during the testing. Hydraulic gradient is typically measured under static (i.e., non-pumping) conditions. Volume-averaged contaminant concentrations are measured in samples collected from the water flowing through the recirculation wells. Concentration measurements are made over time and averaged, and are assumed to represent the volume-averaged concentration of the entire plume upgradient of the recirculation wells. Definition of the volume of the aquifer investigated is needed to calculate water and solute mass flux, and can be determined from numerical modeling. One of two methods can be used to determine the hydraulic conductivity value. The first, referred to as the multi-dipole technique, is appropriate for recirculation wells employing injection and extraction intervals in each well. This method uses an analytical solution to define hydraulic conductivity based on observations of drawdown in or near the wells. The other method requires the release of a conservative tracer into the recirculating flow system. Inverse numerical modeling is then performed to calculate hydraulic conductivity, head, and flow field. The theoretical underpinnings of the RFM method of calculating mass flux are described by Goltz et al. (2007)



and Wheeldon (2008). A meso-scale validation of this method, along with the MIPT method (discussed further below) is presented by Goltz et al. (2009). The technique is adapted from a method referred to as the horizontal flow treatment well approach, which has been evaluated and field-tested for stimulating in-situ bioremediation (Christ et al., 1999; McCarty et al., 1998).

**Figure 5-4. Recirculation Flux Measurement Method**

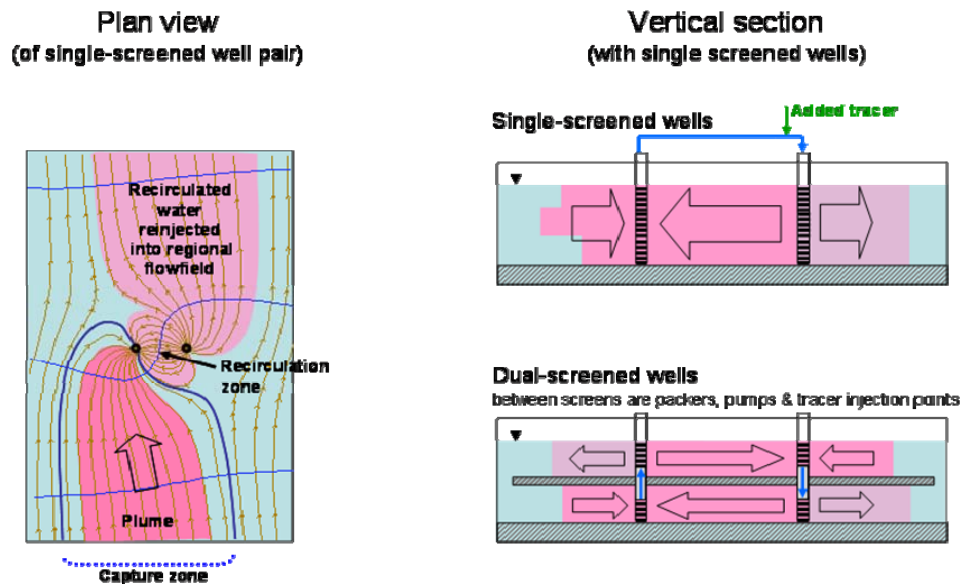

The RFM method is reportedly easy to design when the plume can be completely captured using only one well pair. When two or more well pairs are needed, the technique becomes more complex. The dual-screened well approach works in aquifers with distinct layers (e.g., a low-permeability layer between two aquifers, as illustrated). This approach may not necessarily be termed “re injection,” since no water is pumped above ground and therefore may have certain regulatory advantages over the single-screened RFM configuration. However, more equipment is required to fit inside each well, including packers, well pumps, a tracer injection system, and a water sampling system. In addition, a recirculation zone will result in some mixing of contaminated groundwater. The benefits and potential drawbacks of this system will need to be considered from the perspective of the conceptual site model.

Each RFM application would typically yield one estimate of contaminant mass discharge for a given date and time. Wells could be pumped for longer to yield time-series values of mass discharge estimates. As described in Table 4.2, the RFM approach is relatively new and has not been commonly used in the field.

### 5.1.6. Integral Pumping Tests

Unlike SSP, IPTs refer to a method used to estimate depth-averaged contaminant distribution and fluxes in the aquifer during transient pumping, i.e., prior to the development of steady-state flowlines in the aquifer. This approach is described in Bockelmann et al. (2001), in which the authors use an inversion algorithm to estimate the distribution of dissolved contaminants within

the portion of an aquifer surrounding a pumping well. The distribution of contaminants is used to estimate the average concentration value, which is then multiplied by the estimated groundwater discharge (integrated Darcy flux) to get mass discharge. The IPT method of estimating mass discharge is a key component of the Integrated Concept for Groundwater Remediation (INCORE) program of “emission-based” cleanup of industrial “megsites” that is currently being undertaken in Europe (UW GmbH, 2010). As with SSP and MIPT methods, IPT can overestimate mass flux/mass discharge estimates in fractured rock environments. Pumping can induce high mass flux out of low-transmissivity zones or “dead-end” fractures, thereby overestimating mass flux relative to ambient flow conditions (Malcolm Pirnie and University of Waterloo, 2010).

#### **5.1.7. Modified Integral Pumping Tests**

While the IPT method described above uses an inversion algorithm to calculate the average solute concentration which is then multiplied by Darcy flux values determined using other, conventional methods, the MIPT does just the opposite. A hydraulic pumping test is performed in a single well or in several wells along a control plane, the data from which are analyzed using an analytical solution that isolates Darcy flux. The Darcy flux is then multiplied by the average concentration of the target solute measured in samples collected from the pumped water. The MIPT approach is described in detail by Brooks et al. (2008). A meso-scale validation of this method is presented by Goltz et al. (2009).

## **5.2. Status of Mass Flux/Mass Discharge Measurement Techniques**

### **5.2.1. Technology Development**

The use of mass discharge for evaluating groundwater contamination has been recognized by researchers and practitioners for more than 10 years (e.g., Semprini et al., 1995; Feenstra et al., 1996; Einarson and Mackay, 2001; and Rao et al., 2001). Authors of these papers were early advocates of the relevance of using mass discharge to assess the significance of subsurface contamination and the effectiveness of source zone and plume remediation. Key references describing each mass discharge measurement technique are listed in Table 5-1.

Federal organizations have also recognized the value of mass discharge measurements. In August 2001, an expert panel convened by Strategic Environmental Research and Development Program (SERDP) and ESTCP called for the development of better contaminant mass discharge measurement methods as one of the highest priority research and development needs for evaluating DNAPL source zone remediation (Stroo et al., 2003). Reduced contaminant flux was one benefit of targeted source zone remediation described in a 2003 USEPA publication titled “*The DNAPL Remediation Challenge: Is There a Case for Source Depletion?*” (USEPA, 2003). ESTCP supported the production of a computer program to assist in calculation of contaminant mass discharge, known as the “*Mass Flux Toolkit*” (Farhat et al., 2005). The program is cited by the USEPA’s CLU-IN website (USEPA, 2010a) and by the U.S. Air Force Center for Engineering and the Environment’s (AFCEE) Technology Transfer website (AFCEE, 2010). There have been over 700 downloads of the GSI Environmental, Inc. Mass Flux Toolkit, indicating the level of interest and use of mass flux analysis (personal communication, Newell, 2008). Also in 2008, ESTCP published a demonstration report evaluating several techniques for measuring mass flux at Vandenberg AFB (Malcolm Pirnie et al., 2010). Recently, Wheeldon

(2008) evaluated alternative methods for estimating contaminant mass discharge and provided a guide for implementation and cost comparison. This document is yet another example of the continued interest and critical evaluation of the mass discharge framework.

Mass discharge was featured as a key metric for judging the success of DNAPL source zone remediation in recent ITRC guidance, titled “*Strategies for Monitoring the Performance of DNAPL Source Zone Remedies*” (ITRC DNAPL Team, 2004). A more comprehensive guide, titled “*Use and Measurement of Mass Flux and Mass Discharge*,” was published by the same group in late 2010 (ITRC, 2010b). Indeed, many federally-funded research and demonstration projects have focused on examining the effects of source zone remediation on plume strength, as measured by reductions in mass flux and mass discharge. Some of the key recent publications on this topic include the following: Basu et al., 2008; Brooks et al., 2008; Brusseau et al., 2008; DiFilippo and Brusseau, 2008; Falta et al., 2005a; Falta et al., 2005b; Fure et al., 2006; Jawitz et al., 2005; Kaye et al., 2008; Page et al., 2007; and Suchomel and Pennell, 2006.

Industry is also seeing the importance of assessing and remediating contaminated sites on the basis of mass flux and mass discharge. In late 2003, the American Petroleum Institute published a guidance document centered on the concept of mass discharge and mass flux for assessing and remediating fuel release sites (Newell et al., 2003). Industrial companies that have large portfolios of contaminated properties see the wisdom of quantifying their environmental liabilities based on their potential to impact downgradient receptors. Sites that pose a significant risk to downgradient receptors based on field evaluations of mass discharge are prioritized for remediation. Note that these types of assessments are often being done outside of the regulatory framework simply to provide the companies with more accurate information to run their businesses.

The concept of mass discharge as an indicator of “plume strength” is also being incorporated into assessments of water supply well vulnerability, impacts, and protection. Frind et al. (2006) recently published a numerical approach for evaluating well vulnerability that incorporates the mass discharge of plumes in addition to hydraulic capture. Piersol et al. (2005) applied a mass discharge framework in an evaluation of potential future impacts to a well field in Panama. A mass discharge framework was also used in evaluations of impacts to water supply wells at three regulatory-driven site investigations in California (Beckett and Stanley, 2005; Einarson et al., 2005; Gray et al., 2005).

The mass discharge-based framework is also being applied to sites where contaminants dissolved in groundwater discharge to surface water bodies. As discussed in Einarson and Mackay (2001) and Buscheck (2002), impacts to streams and rivers are directly a function of the rate of contaminant mass loading from groundwater to those water bodies. Evaluation of impacts to surface water based on assessments of groundwater mass discharge have been described by several authors, including Buscheck et al., 2003; Chapman et al., 2007; Conant, 2004; Ford, 2005; and Hyun et al., 2007.

Mass discharge-based frameworks for site assessment and cleanup are also developing outside of the U.S. A group of municipalities in Europe is performing “emission-based” assessments and remediation of industrial “mega-sites.” These assessments use IPTs to identify plumes with the highest rates of mass discharge, which then receive top priority for cleanup (UW GmbH, 2010).

The province of British Columbia, Canada, recently published a guidance document on MNA that recommends monitoring mass discharge along multiple transects placed along plume axes (King, 2006). Finally, environmental regulators in Australia recently published a guidance document for site assessment that recommends flux-based site assessments and remediation (Clements et al., 2008).

### ***5.2.2. Applications to Date***

Different mass discharge measurement methods have been tested and applied at different locations and in different ways. Multiple case studies have been described in summary documents (e.g., ITRC, 2010b). Many applications have been in support of field research projects, while others have been deployed on consultant-led site investigation and remediation programs. There are no readily available, comprehensive compilations of mass discharge applications; however, a summary of known field projects (based on the authors' experience and readily available publications and conference proceedings) is shown in Table 5-2.

### ***5.2.3. Commercial Status***

Mass flux and mass discharge measurement methods generally employ technologies that are already widely used during conventional site assessments (e.g., DP sampling equipment, monitoring wells, pumps). An exception to this is the PFM technology, which is a patented technology offered exclusively through EnviroFlux, LLC.

Table 5-2. Summary of Mass Flux Applications

Project/Site	Contaminant	Type		Purpose			Scale		Measurement		Method						Reference	
		Research	Non-Research	Risk Eval.		Remediation Design or Metric	Technology Eval.	Demo	Full	Flux (J)	Discharge (M <sub>d</sub> )	Synoptic Sampling	PFM	SSP	RFM	IPT		MIPT
				GW	SW													
10 fuel release sites in California	MTBE		X	X	X				X		X	X						Buscheck et al., 2003
Bedrock site, Massachusetts	VOCs		X	X					X		X	X						Eby et al., 2004
CFB Borden, Ontario, Canada	VOCs	X					X	X		X	X		X					Annable et al., 2005
Coal tar creosote controlled release CFB Borden, Ontario, Canada	PAHs	X				X		X		X	X	X		X				Thomson et al., 2008
Coal tar site, Germany	PAHs	X				X		X			X	X						D'Affonseca et al., 2008
Controlled release experiment, CFB Borden	VOCs	X				X		X		X	X	X						Devlin et al., 2001
Creosote plume controlled release experiment, CFB Borden	PAHs	X				X		X			X	X						King and Barker, 1999
Dover AFB, DE	Total CVOCs	X				X		X			X	X						RTDF, 1998
Dover AFB, Delaware	VOCs	X				X			X		X	X						Barbaro and Neupane, 2006
Dry cleaner release Angus, Ontario, Canada	PCE	X			X					X	X	X						Guilbeault et al., 2005
Elizabeth City, NC	MTBE	X				X			X		X	X						Wilson et al., 2000
Former manufacturing plant, Midwestern U.S.	TCE	X				X			X	X	X	X	X					Basu et al., 2006
Former MGP, Germany	PAHs	X		X					X		X					X		Bockelmann et al., 2003
Fuel release site, Morro Bay, CA	MTBE		X	X					X		X	X						Beckett and Stanley, 2005
Fuel terminal, San Diego, CA	MTBE		X	X					X		X	X						Roth et al., 2004
Fuel terminal, San Jose, CA	Petroleum hydrocarbons		X			X			X	X		X						Buscheck et al., 2003
Gas station, Tahoe City, CA	MTBE		X		X				X		X	X						Buscheck et al., 2003
Gas station, Strathroy, Ontario	BTEX	X				X		X			X	X						Chapman et al., 1997
Hill AFB, UT and Fort Lewis, WA	VOCs	X				X		X		X	X	X	X				X	Brooks et al., 2008

Project/Site	Contaminant	Type		Purpose			Scale		Measurement		Method						Reference	
		Research	Non-Research	Risk Eval.		Remediation Design or Metric	Technology Eval.	Demo	Full	Flux (J)	Discharge (M <sub>d</sub> )	Synoptic Sampling	PFM	SSP	RFM	IPT		MIPT
				GW	SW													
Industrial site Milford, New Hampshire	PCE	X			X				X		X							Guilbeault et al., 2005
Industrial site, Cocoa, Florida	TCE	X			X				X		X							Guilbeault et al., 2005
Industrial site, Connecticut	TCE	X				X		X			X							Chapman and Parker, 2005
Industrial site, Connecticut	TCE	X			X			X			X							Chapman et al., 2007
Industrial site, Germany	VOCs	X		X					X		X					X		Bauer et al., 2004
Industrial site, Germany	VOCs	X		X					X		X					X		Jarsjo et al., 2005
ISCO Demonstration CFB Borden, Ontario, Canada	VOCs	X				X		X		X	X		X					Thomson et al., 2007
Landfill site, Heidelberg, Germany	TCE	X		X					X							X		Ptak et al., 1998
MGP site	PAHs		X		X				X		X							Hyun et al., 2007
MTBE biodegradation assessment	MTBE	X				X		X			X							Landmeyer et al., 2001
MTBE fate and transport evaluation, Long Island, NY	MTBE		X	X	X	X			X		X							Thuma et al., 2001
MTBE release site, Calistoga, CA	MTBE		X	X					X		X							Einarson et al., 2005
MTBE release site, Santa Monica, CA	MTBE		X	X					X		X							Gray et al., 2005
Neckar Valley, Germany	PCE	X		X					X							X		Holder et al., 1998
Pine River, Ontario, Canada	PCE	X			X			X		X	X							Conant, 2004
PRB evaluation, UK	BTEX	X				X		X		X	X							Wilson et al., 2008
Sampson County, NC	MTBE	X				X			X		X							Borden et al., 1997
Several sites, North America	Various	X				X		X		X	X							DeFlippo and Brusseau, 2008
Site 1, Alameda Naval Air Station, CA	cis-1,2-DCE	X				X		X			X							Einarson and Mackay, 2001
St. Joseph, MI	Total ethenes	X				X			X		X							Semprini et al., 1995

Project/Site	Contaminant	Type		Purpose			Scale		Measurement		Method						Reference	
		Research	Non-Research	Risk Eval.		Remediation Design or Metric	Technology Eval.	Demo	Full	Flux (J)	Discharge (M <sub>d</sub> )	Synoptic Sampling	PFM	SSP	RFM	IPT		MIPT
				GW	SW													
Superfund site, Massachusetts	Arsenic	X			X			X		X		X						Ford, 2005
Supply wellfield evaluation Aguadulce, Panama	Various	X		X					X		X							Piersol et al., 2005
Test site, New Zealand	Bromide & nitrate	X					X	X			X				X		X	Goltz et al., 2009
Testfeld Sud, Germany	BTEX, PAHs	X		X					X		X					X		Bockelmann et al., 2001
Unnamed site	MTBE		X			X			X	X		X						Buscheck et al., 2003
UST MNA evaluation	Petroleum hydrocarbons		X			X			X		X							Kao and Wang, 2001
Vandenberg AFB, California	MTBE	X					X		X		X		X					Einarson et al., 2006
Vandenberg AFB, California	Bromide	X					X	X		X	X	X	X	X	X			Malcolm Pirnie et al., 2010
Watervliet Arsenal, New York	PCE, TCE		X	X			X		X		X					X		Malcolm Pirnie, Inc. and University of Waterloo, 2010

GW = groundwater, SW = surface water, J = mass flux, M<sub>d</sub> = mass discharge, PAHs = polyaromatic hydrocarbons, UST = underground storage tank, CFB = Canadian Forces Base, MGP = manufactured gas plant

#### 5.2.4. Cost

There are a number of different cost components for each mass flux/mass discharge measurement technique. A list of components (e.g., well installation, sampling, laboratory analysis) is shown in Table 5-3. The relative cost is indicated as different shades of green, with darker green indicating higher cost. Unshaded cells denote cost items that are not applicable to the method.

Compared with the cost of traditional groundwater monitoring, mass discharge measurements may be the same or more expensive. Sites with fairly narrow plumes will require fewer wells and are therefore good candidates for mass flux analysis. However, a higher density of wells is typically required for mass flux measurement relative to groundwater monitoring. Well spacing is ideally on the order of the width of high concentration subplumes to improve the accuracy of mass flux estimates. More heterogeneous sites require tighter well spacing to achieve the same level of accuracy. Costs of data analysis and reporting are likely more expensive than traditional groundwater monitoring (but also provide insights not possible with traditional approaches). Actual reporting costs depend on the size of the project, stakeholder familiarity, and acceptance of mass discharge measurement techniques. Finally, some mass discharge measurement techniques (e.g., synoptic sampling) require a more detailed knowledge of hydraulic conductivity values in the vicinity of the sampling transects. This one-time cost can be substantial.

Summaries of actual costs for mass flux analysis are rarely reported in publications. The cost of conducting PFM mass flux analysis at Fort Lewis, Washington was estimated to be \$150 per linear vertical foot measured, including travel, PFM deployment and retrieval, analysis and reporting (ESTCP, 2008b).

As discussed in Section 5.1, the cost of measuring mass flux/mass discharge can be reduced at many sites by pre-characterizing the locations of high-strength plume cores with DP probes equipped with lithologic and VOC sensors. Subsequent sample collection and mass flux measurements can then be focused on the high-strength plume cores.

Note that although mass flux/mass discharge measurements may be more expensive to implement compared with traditional monitoring, they may reduce overall project costs by better focusing remedial efforts, refining remedial design, or reducing the duration of treatment. See Section 4.4 for a discussion of the various ways in which mass flux/mass discharge measurements can benefit a project.



**Table 5-3. Cost Components of Mass Discharge Measurement Methods\***

<b>Cost Category</b>	<b>Synoptic Sampling</b>	<b>PFMs</b>	<b>SSP/MIPT</b>	<b>RFM</b>	<b>IPT</b>
<b>Design</b>					
Modeling (remedial design)	Not applicable	Not applicable	May be necessary, especially if few wells are installed. Installing more wells may reduce the uncertainty in model predictions	Numerical modeling may be needed for design	Not applicable
Site characterization (hydraulic testing, gradient measurements)	Data necessary to calculate Darcy flux (slug tests, pumping tests, single- or multi-well tracer tests, gradient measurements)	Less detailed characterization of hydraulic conductivity needed compared with synoptic sampling	Less detailed plume characterization needed compared with synoptic sampling	More extensive than SSP to estimate numerical modeling inputs; more design needed for recirculation system	Data necessary to calculate Darcy flux
Permitting	Well installation permits may be needed	Same as synoptic sampling. Some regulatory agencies may require a permit for tracer addition.	Same as synoptic sampling. Also, treatment and discharge permits may be needed.	Same as synoptic sampling. Also, treatment and reinjection permits may be needed.	Same as synoptic sampling. Also, treatment and discharge permits may be needed.
<b>Capital</b>					
Equipment mobilization and set-up	Not applicable	Not applicable	Tanks, flow monitoring, treatment system, and/or discharge equipment	Tanks, flow monitoring, recirculation system, tracer injection system	Tanks, flow monitoring, treatment system, and/or discharge equipment

<b>Cost Category</b>	<b>Synoptic Sampling</b>	<b>PFMs</b>	<b>SSP/MIPT</b>	<b>RFM</b>	<b>IPT</b>
Capital equipment	Not applicable	Flux meters	Extraction well pumps, holding tank, treatment or storage equipment. Costs may be incurred anyway as part of remediation	Similar to SSP	Similar to SSP and MIPT
Monitoring well installation	Number and density are site-specific. Multi-level wells may be needed.	Similar to synoptic sampling. Larger-diameter casings may be needed to house PFMs.	Not applicable	Piezometers or monitoring wells may be needed to provide data for numerical simulations	Not applicable
Extraction well installation	Not applicable	Not applicable	Transects of extraction wells needed. Spacing is site-specific.	Same as SSP and MIPT	Same as SSP and MIPT
Injection well installation	Not applicable	Not applicable	Not applicable	Number and spacing of injection wells is site-specific	Not applicable
Modeling (performance verification)	Not typically needed	Not typically needed	Modeling may be needed to demonstrate hydraulic capture, particularly if well network is sparse	More extensive modeling needed compared to SSP	Modeling may be needed to demonstrate hydraulic capture, particularly if well network is sparse
<b>O&amp;M</b>					
Training	Not applicable	Some training to understand field methods	Not applicable	Necessary to understand concepts and interpret results	Necessary to understand concepts and interpret results

<b>Cost Category</b>	<b>Synoptic Sampling</b>	<b>PFM</b> s	<b>SSP/MIPT</b>	<b>RFM</b>	<b>IPT</b>
Field sampling (labor, equipment rental, materials)	Standard monitoring costs. Number of samples is site-specific.	Comparable to synoptic sampling (two trips to place and retrieve PFM's, but less field time)	Fewer sampling locations. Time-series data may be useful.	Same as SSP	Same as SSP
Analytical costs	Standard analytical costs	Analysis of PFM's is not available at commercial laboratory – must be conducted by vendor	Same as synoptic sampling, but likely with fewer samples	Same as SSP	Same as SSP
Data analysis and reporting	Cost of data analysis and reporting may be more than traditional monitoring since a discussion of groundwater flow rate must be included and more experienced staff are typically on the project team	Level of effort/cost is likely between that of synoptic sampling and SSP. Calculation of mass fluxes can be performed by technology vendor.	Significant costs may be required for data analysis and possibly modeling to determine whether or not capture is complete and refine system operation if necessary	Same as SSP	Same as SSP
Electricity	Not applicable	Not applicable	Extraction wells and treatment system energy requirements	Same as SSP	Same as SSP
Treatment, discharge, and/or off-site disposal	Not applicable	Not applicable	Site-specific treatment and discharge or off-site disposal costs. Costs may be incurred anyway as part of remediation.	Similar to SSP except treated water would be re-injected	Same as SSP
Maintenance	Standard maintenance costs for monitoring wells	Same as synoptic sampling	Same as synoptic sampling. In addition, extraction wells and treatment system maintenance.	Same as SSP; also, maintenance of reinjection wells	Same as SSP
<b>Demobilization/Decommissioning</b>					

<b>Cost Category</b>	<b>Synoptic Sampling</b>	<b>PFMs</b>	<b>SSP/MIPT</b>	<b>RFM</b>	<b>IPT</b>
Equipment demobilization	Not applicable	Not applicable	Demobilization of treatment system, holding tanks	Same as SSP	Same as SSP
Well decommissioning	Standard monitoring well decommissioning costs	Same as synoptic sampling	Fewer wells than synoptic sampling or PFMs, higher unit cost	Similar to SSP	Same as SSP

\*Shading denotes relative magnitude of costs, with darker shading indicating a higher level of cost/effort.

### 5.2.5. Regulatory Acceptance

Mass flux/mass discharge measurements have been used at several sites and the concepts of mass discharge have been published in several regulatory reports. For example, DoD has used mass discharge measurements in support of regulatory requirements for site remediation. At Volunteer Army Ammunition Plant, Chattanooga, Tennessee, mass discharge measurements were used as one set of data to support the natural attenuation of contamination downgradient of secondary source zone(s) (Malcolm Pirnie, 2006). At other DoD sites, mass discharge measurements have been used as a metric to evaluate the benefit of partial DNAPL source zone remediation (e.g., Hill AFB, Utah) (Jackson et al., 2005). Mass discharge numbers and analyses are not Applicable or Relevant and Appropriate Requirements (ARARs). However, mass discharge may be written into a Record of Decision (ROD) or other decision document as a metric used to determine success. Mass discharge reduction was one performance metric used at the U.S. Army Watervliet Arsenal, New York, as documented in the regulator-approved *Corrective Measures Work Plan for Building 40 Bedrock Groundwater* (Malcolm Pirnie, 2004). Mass discharge measurements were also used to evaluate a transition to MNA. More generally, mass discharge measurements are increasingly being required by regulatory bodies overseeing partial DNAPL source zone or plume remediation to determine if remedial goals are being met and allow for remediation optimization (USEPA, 2003; Interstate Technology Regulatory Council (ITRC), 2004).

Evaluation of MNA performance based on reductions in mass discharge along a site flow path is becoming increasingly common amongst regulatory agencies. USEPA introduced this concept in a series of MNA training courses offered around the U.S. in 1998 (USEPA, 1998). In 2004, USEPA updated their VOC MNA guidance to include a section describing the advantages of flux-based monitoring along transects oriented perpendicular to plume axes (Pope et al., 2004).

State regulatory groups are also beginning to provide guidance on performing flux-based site assessments. In 2004, an article discussing contaminant mass discharge applications was published in *LUSTline*, a trade journal oriented to state and local regulators overseeing cleanups of fuel release sites (Nichols and Roth, 2004). The State of Washington recently issued a guidance document advocating flux-based assessments of MNA sites (King, 2006).

Finally, ITRC recently published a new document on mass flux and mass discharge (ITRC, 2010b). Many of the members of this committee are state regulators.

Concerns of regulators and other stakeholders regarding mass flux/discharge may include the following:

- Selection and proper implementation of a measurement method
- The ability to produce accurate and reproducible estimates of mass discharge using existing monitoring well networks
- Current lack of guidelines for mass discharge estimation
- Current lack of regulatory standards, allowable limits, and cleanup goals expressed in terms of contaminant mass discharge
- Cost, relative to traditional metrics

- Difficulty/ease of stakeholder understanding (i.e., familiarity)
- For RFM, inadvertent mixing or spreading of contaminated groundwater beyond the recirculation zone

The assessment and guidance provided in this report as well as the guidance documents described above, particularly the recently published ITRC document, are intended to help address these concerns.

### **5.3. Applicable Site Settings**

The suitability and choice of mass flux measurement techniques is site-specific. Site conditions that can affect the suitability of each tool and therefore the choice of tool at a site include the following:

- Type and distribution of target solute (depth and type of contamination, contaminant distribution)
- Geology (type of aquifer materials, degree of heterogeneity)
- Hydrologic conditions (groundwater velocity, temporal stability of the flow field)
- Existing site infrastructure (e.g., extraction system)
- Time constraints (duration of measurements)
- Waste generation and disposal considerations

These conditions are discussed below.

#### **5.3.1. Type and Distribution of Target Solute**

Mass flux/mass discharge measurement tools are generally not contaminant-specific.<sup>5</sup> They can be applied to measure the flux of any type of dissolved solute past a given transect. Mass flux/mass discharge may be used to evaluate soluble, relatively non-biodegradable compounds such as 1,4-dioxane, chromium(VI), and explosive compounds. Mass flux/mass discharge is a powerful metric for demonstrating attenuation (via, e.g., degradation, sorption, diffusive sequestration).

The depth of contamination does not inherently limit the application of mass flux measurement tools. However, as depth increases, so does cost. Deep mass flux/mass discharge assessments will become more expensive, and will likely have fewer data points, than relatively shallow applications, making them less reliable. Factors such as bias associated with different types of sampling pumps needed to collect samples from depth and pressure changes when a subsurface groundwater sample is brought to the surface can affect the accuracy of the mass discharge measurements.

The distribution of contamination is also an important variable that affects both cost and performance of mass flux measurement, as illustrated in a simplified way in Figure 5-5. Measurements downgradient of a DNAPL source zone may require a very dense grid of monitoring points even in a relatively homogeneous geologic setting. For an example site, Guilbeault et al. (2005) concluded that 75% of contaminant mass discharge occurred within 5 to 10% of the total

---

<sup>5</sup> An exception to this is the PFM technology; see Section 4.1.3.

cross-sectional plume area, even in a sandy aquifer. This was due to the complex distribution of the residual NAPL in the subsurface and limited transverse mixing within the aquifer close to the source zone. This example illustrates the advantage of pumping-based methods that extract groundwater from a wide capture zone (Figure 5-5).

**Figure 5-5. Impact of Source Heterogeneity on Contaminant Flow Paths**

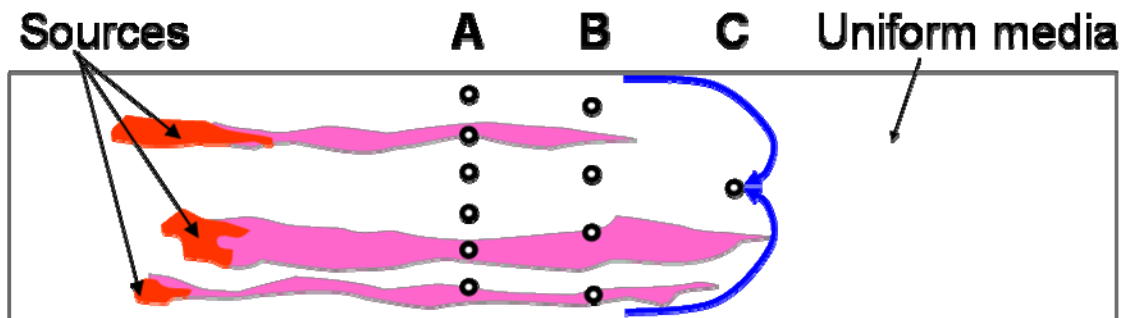

Figure 5-5 illustrates the effect of source heterogeneity on contaminant flow paths, even in relatively homogeneous media. In this example, discrete sources create discrete plumes moving to the right with groundwater flow. Thus, the contaminant mass discharge occurs within narrow regions. If using the synoptic sampling method, a very closely spaced transect of wells (A) would have a better chance of detecting the individual plumes and quantifying the contaminant mass discharge than a less closely spaced transect (B). The advantage of pumping-based methods (C) is apparent, since it may be possible to capture all the mass discharge within otherwise elusive plumes.

### 5.3.2. Geology

The type of geologic setting influences the cost and type of mass flux measurement technique. Of the case studies identified, the majority of the assessments have been in shallow, unconsolidated aquifers. Very few sites were identified with mass flux measurement application in fractured rock environments. Preferential flowpaths created by fractures in the rock make proper well placement difficult, reducing the accuracy of mass flux estimates and requiring more detailed subsurface characterization.

The degree of geologic heterogeneity exerts a strong control on the movement of groundwater and, therefore, dissolved contaminants in the subsurface. The required density of monitoring points in a multi-level well transect can be influenced by geologic heterogeneity. The density of the monitoring network need not always be higher in more strongly heterogeneous deposits, however. This is shown in Figure 5-6, at a site where nearly all groundwater flux travels along interconnected buried stream channels. Nearly all of the contaminant flux may occur within the coarse-grained channel deposits and require relatively few wells (B). This conceptual diagram illustrates the importance of defining the preferential groundwater flowpaths prior to designing the mass flux/mass discharge testing program.

**Figure 5-6. Plan View Illustration of the Effect of Geologic Heterogeneity on Contaminant Flow Paths**

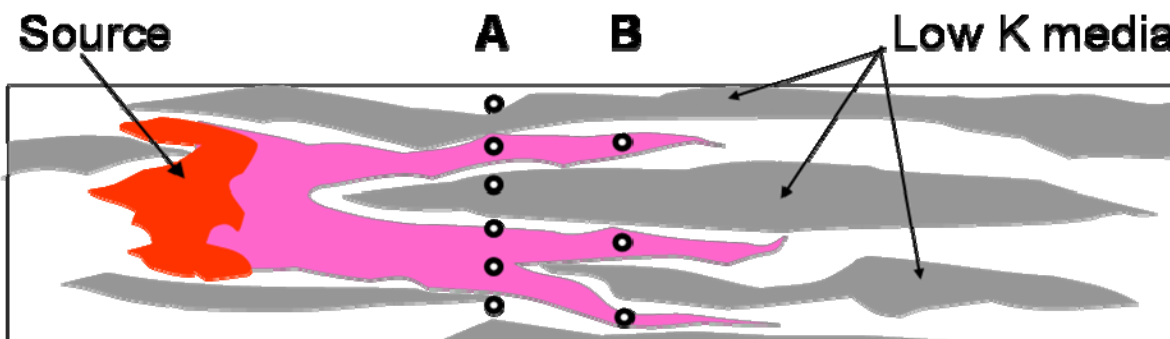

Permeable media are shown in white; relatively impermeable media are shown in gray

Pumping methods for estimating mass discharge are also affected by geologic heterogeneity, and numerical or analytical models may be needed to define capture zones. Model accuracy is dependent on the prior characterization of geologic heterogeneities and model representation of capture. Model predictions of capture zones are dependent on prior geologic characterization; therefore, geologic uncertainties will translate into error in mass flux predictions.

### **5.3.3. Hydrologic Conditions**

Groundwater flux affects mass discharge measurements. Sites with higher groundwater velocities require more extraction wells or a higher extraction rate to fully sample the contaminant plume. The extraction rate from a well is limited by the aquifer transmissivity and well efficiency; pumping at a higher flow rate has the disadvantage of increasing the time to reach steady-state. If groundwater velocity is not constant in magnitude or direction over time, further complexities arise. Extraction wells may fully sample the plume some of the time and only a portion of it at other times, resulting in apparent fluctuations in aquifer contaminant mass discharge. Extraction system design for measuring mass discharge must be based on a thorough hydrologic CSM. Methods that involve monitoring well samples (snapshot sampling) or PFM deployment may measure distinctly different portions of a plume if groundwater flow direction changes over time (Rein et al., 2009). As discussed previously, pumping methods of measuring mass flux may alter groundwater flow conditions and induce mass flux out of low transmissivity zones, particularly in fractured environments.

Incomplete plume capture, which leads to an underestimate of contaminant mass flux, may occur if the plume location (lateral and vertical) is not sufficiently defined, wells are not ideally located, or if wells are not pumped long enough to fully capture dissolved contaminants residing within their capture zone. This can also occur due to uncertainty in estimates of aquifer properties (e.g., if Darcy flux in the aquifer is higher than estimated due to more permeable sediments and/or greater hydraulic gradients). Mass discharge values calculated under these scenarios may be erroneously low. “Over-capture” of plume(s), can lead to an overestimate of contaminant mass discharge if calculations are made prior to steady-state conditions. Initial pumping of a well will draw contaminants in from all sides at relatively high rates. Over time, clean water bounding the



dissolved plume(s) will also be drawn into the well, reducing average concentrations and calculated mass discharge.

#### **5.3.4. Existing Site Infrastructure**

The choice of mass flux measurement technique will often depend on existing site infrastructure, (typically monitoring wells and extraction wells) and the planned or chosen final remedy. A site with an existing pump-and-treat system designed to capture contamination flowing from a source zone (a boundary containment system) is a prime candidate for mass discharge measurement using the SSP method or RFM. Sites with an existing transect of monitoring wells would be better candidates for synoptic sampling or PFMs.

#### **5.3.5. Time Constraints**

The duration of measurement may also be a site constraint affecting the choice of mass discharge measurement. If sparse extraction wells are not continuously pumped, reaching steady-state conditions can take weeks or months. Permitting, pilot-testing, and other steps in the design process are likely longer for the RFM method compared with synoptic sampling and/or PFM measurement.

#### **5.3.6. Waste Generation and Disposal Considerations**

At some sites, waste generation is a key concern; at others, it is of growing importance and priority to improve the sustainability of environmental remediation and reduce costs. Mass discharge measurements involving groundwater extraction (SSP) may therefore be undesirable. With the RFM method, pumped groundwater is reinjected, avoiding wastewater handling and disposal; however, treatment may still be required before reinjection. The process is still energy-intensive. PFMs and synoptic sampling methods generate only a minimal amount of material requiring disposal.

### **5.4. Advantages and Disadvantages Compared with Other Available Approaches to Plume Monitoring**

Because the mass flux/mass discharge measurement techniques evaluated in this report are unique, they cannot be directly compared with conventional technologies. The closest technique for comparison is traditional groundwater monitoring. Typically, groundwater monitoring would still be conducted; in addition, mass flux/mass discharge would be measured.

There are several advantages for estimating mass discharge, including the following:

**Improved CSM.** Mass discharge measurements can provide a different perspective on the magnitude, location, and average impact of contaminant transport. For example, high concentrations in one area may be recognized to be of relatively minor significance if there is low contaminant mass discharge from these areas. Flux measurements in different portions of the aquifer can be compared to better understand contaminant fate and transport.

**Better understanding of risks to potential receptors.** Risk to downgradient receptors is more closely related to the rate of contaminant mass migration than to concentration measured at specific subsurface locations. Therefore, mass discharge calculations make it easier to assess risk to downgradient receptors and assess risk reduction. It can also be used as a way to compare and prioritize remedial actions at different sites, from the perspective of risk to downgradient receptors,

in the absence of remedial or other mitigation measures. In this case, mass flux/mass discharge measurements are not replacing cleanup standards or serving as an alternative compliance metric; rather they are helping to quantify potential exposure and perhaps prioritize remedial actions.

***Improved remedial design.*** Definition of local mass fluxes is necessary for effective, targeted in-situ remediation. As an indicator of the “strength” of contaminants being released to areas downgradient of the source area, a mass-flux based metric for dissolved contaminants can be used to identify remedial priorities, resulting in more focused, more effective, and less expensive in-situ remediation.

***Improved performance assessment.*** Sites could benefit from evaluating remedial progress from the perspective of reducing mass discharge. For example, concentrations may decline at different rates in spatially distributed monitoring wells in response to upgradient treatment, making it difficult to quantify the overall effectiveness of treatment. An analysis of one or more subsets of wells indicating a decrease in contaminant mass discharge conveyed by a plume through a transect provides a meaningful way to average concentration reductions across space and support conclusions regarding treatment efficiency, indicating the effectiveness of partial mass removal.

***More realistic expectations.*** Using mass flux/mass discharge reduction as a metric may refocus remedial attempts at complex sites where it may be technically impracticable to reduce contaminant concentrations to target levels within a reasonable timeframe. Mass flux/mass discharge has been used as an alternative performance metric/RAO for complex source areas (see, for example, Watervliet Arsenal (Malcolm Pirnie and University of Waterloo, 2010)).

***Better monitoring plan/site stewardship.*** Site owners may find that a mass flux/mass discharge-based metric for dissolved contaminants leaving their sites will result in a more focused monitoring program.

***More rapid site closure.*** Site owners may find that a mass-flux based metric for dissolved contaminants leaving their sites will result in reduced overall treatment duration and cost.

Disadvantages of mass flux measurements include the lack of familiarity of stakeholders with mass discharge concepts and measurement techniques and extra cost to conduct these analyses. Including mass discharge estimates in reports and discussions may be met with resistance or disinterest until more guidelines and tools become available, more experience has accumulated, and more successful applications have been documented. Mass flux measurements will likely be an added cost to monitoring programs required by regulatory agencies, as regulatory requirements (e.g., meeting ARARs) are currently expressed in terms of concentrations in vertically homogenized groundwater samples from relatively long-screened wells (e.g., 10- to 20-foot screens).

Advantages and limitations of each of the mass discharge measurement methods (compared with each other) are summarized in Table 5-4 and briefly discussed below. Note that the accuracy of all of the methods can be improved (and costs reduced) by first identifying the locations of high-strength plume cores along the transect using DP methods and then designing the mass flux/mass discharge measurements to ensure that the high-strength portions of the plume are sampled or captured.

Synoptic sampling is familiar to many consultants and regulators and helps identify concentration distribution across the plume. However, this method may require the collection of numerous samples, reliable estimates of groundwater discharge distribution, and assumptions about contaminant distribution between sample locations.

SSP is conceptually simple but may be difficult to implement or interpret in practice, depending on the site setting. The method requires knowing enough about the plume and hydrogeology to ensure capture. The method may require disposal of relatively large volumes of contaminated water. In addition, the process of pumping may alter or mix the contaminant distribution under evaluation, potentially across distinct geochemical zones, affecting or enabling in-situ reactions. Results may be influenced by sorption/desorption and changes in biochemical reactions. Finally, it may be difficult to interpret results without prior knowledge of the concentration distribution across the plume (such as that gained from monitoring single- or multi-level wells, or pre-characterizing the transects as described above). Closely-spaced extraction wells will reduce the time needed to reach steady-state plume capture. SSPs may be performed in a step fashion to identify the optimal pumping rate for the measurement method.

PFMs are a relatively new technology that has only recently been available commercially. Therefore, project stakeholders may be unfamiliar with it. PFM measurements can be confounded by sorption/desorption, by vertical flow that may occur in the wells that house the PFMs or in the filter pack surrounding the well screen. Results may also be variable at sites where groundwater flow velocity changes over time. Mass discharge estimates based on PFMs require extrapolation of contaminant distributions between wells and are subject to estimation of the effective capture zones (a process that is sensitive to well bore diameter, the presence and type of sand pack, and other factors). The primary advantage of PFMs is integrating time-varying mass discharge.

RFM, currently the least tested of the four methods at field-scale, may be conceptually difficult to set up, operate, and communicate results to stakeholders. Like SSP, this method integrates contaminant flux from the zone of groundwater extraction, reducing the need to make assumptions about contaminant distribution between well locations. Since the pumped water is reinjected, no disposal is required. This is a potentially significant advantage, assuming approval for reinjection can be obtained. Like SSP, a key difficulty is in knowing enough about the plume and hydrogeology to ensure capture. Mass discharge measurement may be affected by sorption/desorption. In addition, the process of pumping may alter or mix the contaminant distribution that is under evaluation, potentially across distinct geochemical zones, affecting or enabling in-situ reactions.

These factors and others are summarized in Table 5-4.

**Table 5-4. Comparison of Mass Discharge Measurement Methods**

<b>Parameter</b>	<b>Synoptic Sampling</b>	<b>PFMs</b>	<b>SSP</b>	<b>RFM</b>	<b>IPT</b>	<b>MIPT</b>
<b>Method description</b>	Synoptic point measurements along a sampling transect.	Time-integrated point measurements along a transect using compound-specific sorbents.	SSP and sampling of a transect of extraction wells.	Monitoring of extraction and reinjection well pairs installed across plume.	Transient pumping and use of inversion algorithm to estimate depth-weighted average concentration.	Analytical method of estimating Darcy flux from transient pumping; multiply by average concentration to estimate mass flux.
<b>Applicability to site contaminants</b>	Applicable to all contaminants.	Compatible with a select list of dissolved contaminants. Research and development is underway to expand the list of analytes that can be measured with these devices.	Applicable to all contaminants.	Applicable to all contaminants.	Applicable to all contaminants.	Applicable to all contaminants.

<b>Parameter</b>	<b>Synoptic Sampling</b>	<b>PFMs</b>	<b>SSP</b>	<b>RFM</b>	<b>IPT</b>	<b>MIPT</b>
<b>Applicability to hydrogeologic setting</b>	More accurate at sites with well-characterized hydrogeology.	More effort needed to maintain accuracy at sites with variable groundwater velocity or significant vertical fluxes.	Applicable in hydrogeologic settings where extraction is an effective means of capture.	Limited to aquifers that have sufficient hydraulic conductivity to permit recirculation between wells.	Not accurate at highly heterogeneous geologic formations.	Not accurate at highly heterogeneous geologic formations.

Parameter	Synoptic Sampling	PFMs	SSP	RFM	IPT	MIPT
<b>Prerequisite site characterization</b>	<p>Focused on a two-dimensional plane across the plume. Site characterization can therefore focus on a relatively small slice of the aquifer where the measurements are being made. Standard site characterization parameters (hydraulic conductivity, hydraulic gradient) needed.</p> <p>Prior characterization of the locations of plume core(s) and high K zones necessary to ensure high-flux portions of the dissolved plume(s) are measured.</p>	<p>Focused on a two-dimensional plane across the plume. Site characterization can therefore focus on a relatively small slice of the aquifer where the measurements are being made. Detailed hydraulic conductivity and gradient information not needed.</p> <p>Prior characterization of the locations of plume core(s) and high K zones necessary to ensure high-flux parts of the dissolved plume(s) are measured.</p>	<p>Definition/verification of zone of measurement may rely on calibrated groundwater flow models. This requires that the portion of the aquifer where the measurements are made be characterized in three dimensions.</p> <p>Prior characterization of the general locations of plume core(s) necessary to ensure high-flux parts of the dissolved plume(s) are measured. However, unlike synoptic sampling and PFMs, detailed characterization of the dissolved plumes may not be as critical since the plume cores are hydraulically captured by pumping.</p>	<p>More characterization needed than SSP in order to estimate input values and calibrate flow model.</p>	<p>Same as SSP. In addition, standard site characterization parameters (hydraulic conductivity, hydraulic gradient) are needed.</p>	<p>Same as SSP.</p>

<b>Parameter</b>	<b>Synoptic Sampling</b>	<b>PFMs</b>	<b>SSP</b>	<b>RFM</b>	<b>IPT</b>	<b>MIPT</b>
<b>Ease of system installation/ retrofit of existing wells</b>	Relatively easy to install wells along transects using commercially available monitoring and drilling equipment; relatively easy to install new wells in conjunction with existing ones to create a transect.	Relatively easy to install the devices in wells. Flux meters may be deployed in existing wells.	Must set up and maintain system for measuring extraction rates from one or more wells, compositing flows from multiple wells, storing and disposing and/or treating extracted water. Can adapt existing extraction systems for SSP.	Pumped water is reinjected, so no disposal is required. May require regular re-development of wells to maintain injection rate during the test. Requires addition of a tracer to recirculated water, which may entail regulatory approval. Regulatory approval to re-inject pumped water may be necessary.	Same as SSP. However, pump test does not need to operate for as long, reducing the size of water treatment/ storage facilities.	Same as IPT.

Parameter	Synoptic Sampling	PFMs	SSP	RFM	IPT	MIPT
<b>Required well network</b>	Very dense networks of multi-level monitoring wells may be necessary within a sampling transect to sample all of the high flux zones, especially immediately downgradient from contaminant source zones where concentration gradients transverse to the plume axes may be very large.	Dense networks of these devices may be necessary in a sampling transect to sample all of the high flux zones (as discussed above). Note: well is not useable during PFM deployment.	Number of wells required to fully capture dissolved plume(s) a function of the aquifer properties. Aquifers with low transmissivity require fewer wells to capture a plume than more transmissive aquifers since capture zone width is inversely proportional to transmissivity. Note that for any aquifer type, the time to attain steady-state flowlines (and hence to reduce the volume of groundwater extracted) can be reduced by installing many extraction wells along a transect, each pumped at a low rate. Pumping may draw contaminants from less transmissive layers that would not otherwise contribute to mass flux under ambient conditions.	Good lateral coverage for few wells if recirculation between well pairs can be achieved and sustained. Continuous monitoring of mass discharge may be feasible, if the system operates continuously. Pumping may draw contaminants from less transmissive layers that would not otherwise contribute to mass flux under ambient conditions.	Limited to the number of wells needed to fully capture the plume. Pumping may draw contaminants from less transmissive layers that would not otherwise contribute to mass flux under ambient conditions.	Same as SSP and IPT. Pumping may draw contaminants from less transmissive layers that would not otherwise contribute to mass flux under ambient conditions.



<b>Parameter</b>	<b>Synoptic Sampling</b>	<b>PFMs</b>	<b>SSP</b>	<b>RFM</b>	<b>IPT</b>	<b>MIPT</b>
<b>Sampling and analysis</b>	Sampling and sample analysis follow established protocol.	Quantification of the mass collected in the devices is performed by the technology vendor.	Analytical costs may be reduced because fewer groundwater samples are collected, compared with synoptic sampling or PFMs.	Requires additional sampling and analysis to determine tracer recirculation history, compared with other three methods.	Same as SSP.	Same as SSP and IPT.

<b>Parameter</b>	<b>Synoptic Sampling</b>	<b>PFMs</b>	<b>SSP</b>	<b>RFM</b>	<b>IPT</b>	<b>MIPT</b>
<b>Ease of conceptual understanding</b>	Generates two-dimensional distribution of contaminants at a given time. This method is conceptually simple and easy to communicate to stakeholders.	Devices record the mass of the target analyte sorbed onto the device during the time that the device is deployed, simplifying mass discharge calculations. Calculation of mass flux and mass discharge requires more complicated analytical solutions than those for synoptic sampling method, e.g., to consider various borehole and well geometries.	Measures contaminant concentration extracted at steady-state. Requires good knowledge of system hydraulics and may require use of numerical flow models to design and verify that entire mass discharge is being measured.	Conceptually difficult to set up, operate, and communicate to stakeholders.	Conceptually simple but mathematically complicated.	Requires understanding and ability to calculate integrated Darcy flux. Conceptually difficult to communicate to stakeholders.

Parameter	Synoptic Sampling	PFMs	SSP	RFM	IPT	MIPT
<b>Reproducibility and accuracy</b>	<p>This method is easy to repeat. There may be relatively large errors in calculated mass discharge values due of low resolution of field data (e.g., hydraulic conductivity values estimated from slug tests). These can be minimized by thorough site characterization and tight well spacing.</p>	<p>Ambient vertical groundwater flow within the wells in which the instruments are installed can bias the results. This bias can be minimized or eliminated through the use of baffles that prevent in-well flow. Flow through the wells and convergence into the well must be properly understood.</p>	<p>Transient methods may alter the location of the plume, changing attenuation mechanisms (either inhibiting or enhancing) so that “natural” mass discharge cannot be measured. It is difficult to determine if the system is capturing the entire plume; incomplete plume capture is possible. If the entire plume is captured by the pumping wells, the measurement of mass discharge will be more accurate, as pumping integrates contaminant mass. Relatively insensitive to actual short-duration changes in mass discharge in the plume.</p>	<p>Least tested of these methods. Limited documentation of field applications of this method.</p>	<p>Method is relatively easy to repeat. Method is reported to be accurate although comparison of results to known mass discharge has not been performed. Method yields an estimate of average contaminant concentrations in test zone; calculation of Darcy flux using conventional methods still required.</p>	<p>Method is relatively easy to repeat and is reported to be accurate. Method produces estimates of Darcy flux; estimation of average solute concentration in test area via other methods required.</p>

<b>Parameter</b>	<b>Synoptic Sampling</b>	<b>PFMs</b>	<b>SSP</b>	<b>RFM</b>	<b>IPT</b>	<b>MIPT</b>
<b>Waste generation</b>	Minimal waste from sampling procedures.	Least amount of waste generated, compared with other mass flux measurement methods. Less energy required compared with SSP, RFM.	Generates purge water that will require treatment and/or disposal.	Generates wastewater that may require aboveground treatment prior to reinjection.	Generates less wastewater than SSP due to shorter time needed for pumping.	Same as IPT.
<b>Implementation Costs</b>	Costs associated with collecting and analyzing samples from dense monitoring transects can be high. Estimation of groundwater flow through the sampling transects may require significant time, effort, and money, especially in heterogeneous formations.	Less detailed plume characterization and field work is needed compared with synoptic sampling; higher capital cost to purchase flux meters, ship and analyze samples compared with other three methods.	Can generate a lot of water that may require treatment and/or disposal, which may be expensive. Fewer wells required than for synoptic sampling, but type of well may be different (e.g., extraction well may require different sand pack compared to a monitoring well).	Similar to SSP plus the additional costs of permitting, setting up, and maintaining the recirculation system.	Less cost and energy is needed to conduct pump test, compared with SSP. However, field labor is needed to collect hydraulic conductivity data and calculate mass flux compared with SSP.	Similar to IPT and SSP. Hydraulic conductivity data are not needed to estimate mass flux. More labor is required to estimate mass flux; however, less staff time is needed in the field compared with SSP.

## 5.5. Summary

Contaminant mass flux is a measure of the amount of dissolved contaminant mass flowing in a dissolved plume through a hypothetical transect oriented perpendicular to the plume axis per unit time and per unit cross sectional area of the transect. Integrations of local mass fluxes can be performed mathematically or physically (e.g., by pumping), yielding estimates of contaminant mass discharge. Mass discharge can be thought of as the overall “strength” of the source area or the dissolved plume and is a very useful parameter for evaluating the risk of the plume to downgradient water supply wells and surface water bodies from the migrating plume. Given the importance of this parameter in evaluations of potential risks to downgradient receptors, many scientific and regulatory groups have recommended that designers of in-situ remediation programs focus their efforts on reducing contaminant mass discharge rather than attempting to reduce contaminant concentrations everywhere in the subsurface to low numerical standards. In heterogeneous geologic media, focusing remediation efforts on the high flux zones can often result in significant reductions in contaminant mass discharge. A significant amount of theoretical, laboratory, and field research is now being undertaken to better understand and predict the relationship between source zone remediation and plume response.

There are several field methods for measuring contaminant mass flux and mass discharge. They can generally be grouped into (1) point measurements (e.g., synoptic point measurements and PFMs) and (2) pumping methods (SSPs, RFMs, IPTs and MIPTs). Point methods are conceptually easy to understand and generally simpler to implement than pumping methods. An advantage of point measurements is that they typically provide more information on the spatial distribution of local mass fluxes than pumping methods, especially if depth-discrete samples are collected. Knowledge of the spatial distribution of high-flux zones is crucial if those zones are to be targeted for treatment during subsequent phases of work. PFMs have an advantage over synoptic point measurements in that independent estimates of Darcy flux are not needed; this avoids the typical inaccuracies associated with estimating hydraulic conductivity.

Pumping methods are typically more difficult to design and implement, and have not been performed as widely as the point measurement methods. However, they have the advantage over point measurements in that they physically integrate contaminants extracted from the dissolved plume, reducing the number of sampling points needed to make an accurate measurement. Methods for measuring mass flux and mass discharge are actively evolving. This is particularly true for pumping methods. IPTs were developed by researchers in Germany and provide information about the approximate depth-averaged concentration of the target contaminant in the aquifer surrounding an extraction well. The average concentration is multiplied by the Darcy flux in order to calculate mass flux and mass discharge. Values of Darcy flux are estimated using conventional methods (e.g., multiplying hydraulic conductivity by hydraulic gradient), which is a limitation of this method.

MIPTs, on the other hand, use a more sophisticated analytical solution to calculate Darcy flux from hydraulic pumping tests, but rely on simplifying assumptions about the average solute concentration in the aquifer in the test zone based on water quality samples collected during the pumping test. SSPs are analogous to pumping systems used for pump-and-treat remediation. They are conceptually simple and may be the most accurate of the measurement methods since mass discharge is simply the product of the bulk extraction rate and solute concentration in the

combined effluent. It is unclear whether SSPs are practical at many sites, however, since the time it takes to reach steady-state conditions may be substantial. This could create a large volume of contaminated water requiring treatment and/or disposal. The spacing of extraction wells can be reduced to minimize the time necessary to reach steady-state conditions, and a phased program of “stepping up” the extraction rate incrementally may optimize this method. Existing pump-and-treat systems that fully capture dissolved plumes are, in effect, SSP monitoring systems. Monitoring those systems while in-situ treatment of source zones is undertaken can yield important flux-based performance monitoring data.

RFMs are the newest pumping method to be developed, and have the advantage that there is no net extraction of groundwater, thus eliminating the need for expensive treatment and/or disposal; however, recirculation is still energy-intensive and the benefits/drawbacks of contaminant mixing in groundwater from RFM system operation will need to be evaluated.

With all of the mass discharge methods, it is important to have the plume boundaries well-defined, both laterally and vertically, to ensure that the mass discharge in the entire plume is measured. In addition, there is a significant advantage to “pre-characterizing” the subsurface geology and solute distribution along the transects prior to designing the mass flux/mass discharge monitoring program. This can be done quickly and economically at many sites using DP probing equipment (e.g., CPT and membrane interface probes). The primary goal of this pre-characterization program is to identify the locations of the high mass flux zones to ensure that those zones are targeted for the subsequent quantitative mass flux measurements.

Mass flux and mass discharge measurements are rapidly becoming incorporated into various protocols being developed by regulatory agencies and industry groups. Mass flux/mass discharge frameworks for risk evaluations and remediation performance monitoring have been published by USEPA, ITRC, and regulatory agencies in the state of Washington; the province of British Columbia, Canada; and Australia. There is also a program of “emission-based” site assessments and remediation of industrial “mega-sites” being undertaken in Europe. While there has been a remarkable amount of activity in the last decade developing and testing various methods of measuring mass flux and mass discharge, it is safe to say that further refinements to existing methods – and perhaps development of new innovative methods to measuring these important parameters – lie ahead.

## 6.0 COMPOUND SPECIFIC ISOTOPE ANALYSIS

CSIA is the fourth innovative diagnostic tool addressed in this study, as introduced in Section 2.0. CSIA is an analytical technique used to generate an isotopic signature or ratio for different compounds. CSIA applications are gaining acceptance for use at chlorinated solvent sites, complementing traditional site investigation and remediation performance monitoring techniques. To date, CSIA has been applied most frequently to carbon isotopes, and CSIA for carbon isotopes can be considered a mature technology. CSIA for other compounds of interest at chlorinated solvent sites (e.g., hydrogen, oxygen, chlorine) has not been performed to the same extent as for carbon; however, this is a topic of active research and shows promise for future use at chlorinated solvent sites (USEPA, 2008; Abe et al., 2009). This section provides an overview of CSIA as a diagnostic tool at chlorinated solvent sites during site characterization, performance assessment during active remediation, process optimization, and long-term monitoring efforts. We focus on CSIA for carbon because it is the most common element analyzed for isotope ratios at chlorinated solvent sites. In this project, CSIA was applied at Fort Lewis and the Watervliet Arsenal to analyze the extent of chlorinated solvent degradation by reductive dehalogenation and in-situ chemical oxidation, respectively.

### 6.1. Description of Compound Specific Isotope Analysis

#### 6.1.1. Introduction to Stable Isotopes

Isotopes are atoms of the same element that have the same number of protons (i.e., identical atomic number) but different numbers of neutrons (i.e., different atomic masses). The sum of the number of protons and neutrons in an atom defines the atomic mass and is denoted by a superscripted number to the left of the chemical symbol. For instance, all carbon atoms contain six protons, but may contain six, seven, or eight neutrons ( $^{12}\text{C}$  (carbon-12),  $^{13}\text{C}$  (carbon-13), and  $^{14}\text{C}$  (carbon-14), respectively). Stable isotopes remain unchanged under most conditions, while radioactive isotopes undergo radioactive decay.

The relative amounts of the individual isotope species in each element, expressed in percent, are called isotopic abundances. For instance, approximately 98.9% of carbon on Earth is  $^{12}\text{C}$ , 1.11% is  $^{13}\text{C}$ , and  $^{14}\text{C}$ , which is a radioactive isotope of carbon, occurs in trace amounts. In most stable isotope applications, investigators are interested in the ratio of isotopes of an element in a sample. Typically, abundances are expressed as the ratio of the less abundant or “rare” isotope to the more abundant isotope. For carbon, it is the ratio of  $^{13}\text{C}$  to  $^{12}\text{C}$  (i.e.,  $^{13}\text{C}/^{12}\text{C}$ ), which results in a ratio of approximately 0.0112.

Measuring absolute isotopic ratio or abundance is difficult and could lead to problems in comparing data sets from different laboratories (Clark and Fritz, 1997). Therefore, stable isotopes are typically reported as the ratio of two isotopes of an element in a sample relative to the ratio of two isotopes of an established reference standard. This is expressed using the delta ( $\delta$ ) notation as follows:

$$\delta^{13}\text{C}_{\text{sample}} = \frac{(^{13}\text{C}/^{12}\text{C})_{\text{sample}} - (^{13}\text{C}/^{12}\text{C})_{\text{reference}}}{(^{13}\text{C}/^{12}\text{C})_{\text{reference}}} \times 1000 \text{ (‰ or per mil)} \quad (\text{Equation 6-1})$$

This can be simplified as follows:

$$\delta^{13}\text{C}_{\text{sample}} = \left( \frac{(\text{R})_{\text{sample}}}{(\text{R})_{\text{reference}}} - 1 \right) \times 1000 \text{ (‰ or per mil)} \quad (\text{Equation 6-2})$$

where

$$\text{R} = \left[ \frac{^{13}\text{C}}{^{12}\text{C}} \right] \quad (\text{Equation 6-3})$$

For carbon, the  $^{13}\text{C}/^{12}\text{C}$  reference is the Vienna – PeeDee Belemnite reference standard (V-PDB). Since variations in isotopic abundances are typically very small, the relative ratios are expressed in parts per thousand, or per mil (‰). Negative  $\delta$  values indicate that the sample has less of the rare isotope relative to the standard, so the sample is depleted relative to or “lighter” than the standard. Positive  $\delta$  values indicate that the sample has more of the rare isotope relative to the standard, so the sample is enriched relative to, or is “heavier” than the standard.

### 6.1.2. Stable Isotope Fractionation

The ratio of stable carbon isotopes in a compound may change due to physical or chemical processes. This change in the ratio of stable isotopes is known as fractionation, and it occurs due to differences in the rates of reaction for different molecular species. Heavier isotopes react more slowly because the reaction rate and/or dissociation energy for heavy and light isotopes of a molecule differ (Sueker, 2001). The result is that as the reaction proceeds, the reactant that remains has a progressively higher content of the heavy isotope since the molecules containing the light isotope have reacted more quickly to form the product, compared to those containing the heavier isotope. This phenomenon may be expressed by the fractionation factor, alpha ( $\alpha$ ), which is the ratio of the isotope ratios for the reactant and product (Clark & Fritz, 1997):

$$\alpha = \frac{R_{\text{reactant}}}{R_{\text{product}}} \quad (\text{Equation 6-4})$$

The value of alpha is typically close to one. Isotope fractionation may also be expressed in terms of an enrichment factor,  $\epsilon$ , which is defined as follows (Sueker, 2001):

$$\epsilon = 1000 * (\alpha - 1) \text{ (‰)} \quad (\text{Equation 6-5})$$

The larger the fractionation during the reaction, the more negative the corresponding value of epsilon, the enrichment factor.

Stable isotope fractionation may be modeled using the Rayleigh equation. The Rayleigh equation establishes the relationship between the isotopic composition of reactant and product based on the fractionation factor ( $\alpha$ ) and the change in concentration of the substrate. The general form of the Rayleigh equation states that the isotope ratio at time  $t$ ,  $R$ , in a diminishing reservoir of the reactant, is a function of its initial isotopic ratio,  $R_0$ , the remaining fraction of that reservoir,  $f$ , and the equilibrium fractionation factor for the reaction as follows:

$$\text{R} = \text{R}_0 * f^{(\alpha - 1)} \text{ or } \text{R} / \text{R}_0 = f^{(\alpha - 1)} \quad (\text{Equation 6-6})$$



Experimentally, the fractionation factor ( $\alpha$ ) is determined by plotting  $\ln(f)$  versus  $\ln(R/R_0)$  and determining the slope of the linear regression, which is  $(\alpha - 1)$ . The Rayleigh model is not directly applicable to compounds which are simultaneously being formed and degraded, such as cis-DCE or vinyl chloride (VC) in the sequential biodegradation of TCE (although it would be applicable to the parent TCE compound).

For chlorinated hydrocarbons, nondegradative processes (e.g., volatilization, dissolution, sorption) have been found to be non-fractionating under equilibrium conditions (i.e., the isotope ratio has been found to remain unchanged via CSIA) (USEPA, 2008). Therefore, isotope fractionation makes CSIA a useful technique to distinguish between concentration decreases due to degradative versus nondegradative processes.

### 6.1.3. Compound Specific Isotope Analysis Applications at Chlorinated Solvent Sites

The understanding that certain processes that change contaminant concentrations also produce changes in isotopic signatures, while other processes do not, has made CSIA useful as a diagnostic tool during site characterization and remediation of chlorinated solvent sites. Table 6-1 lists potential uses of CSIA during site characterization, active remediation, and long-term monitoring for chlorinated solvent sites. Each is discussed in further detail following the table.

**Table 6-1. Compound Specific Isotope Analysis Applications at Chlorinated Solvent Sites**

	<b>Site Characterization</b>	<b>Active Remediation</b>	<b>Long-Term Monitoring</b>
<b>Goal</b>	Improve CSM	Improve remedy design and application	Improve performance assessment and accelerate site closure
<b>CSIA Applications</b>	<ul style="list-style-type: none"> <li>• Baseline CSIA measurements prior to active remediation and/or long-term monitoring</li> <li>• Forensics application – source differentiation</li> <li>• Qualitative and/or quantitative evidence for biodegradation, including MNA, to guide decisions on selection of remediation strategy</li> <li>• Contaminant fate and transport numerical modeling</li> </ul>	<ul style="list-style-type: none"> <li>• Qualitative and/or quantitative evidence for biodegradation during remedy application, including evidence for MNA</li> <li>• Qualitative and/or quantitative evidence for abiotic degradation during remedy application (e.g., degradation versus dilution)</li> <li>• Mechanism of biological degradation of chlorinated solvents</li> </ul>	<ul style="list-style-type: none"> <li>• Monitoring progress of biological or abiotic degradation</li> <li>• Measurement of potential rebound effects after completion of an active remedy</li> </ul>

## Site Characterization

The primary goal of using CSIA at a chlorinated solvent site during the site characterization phase is to improve the CSM. Although CSIA cannot replace rigorous hydrogeological and geochemical characterization, it can provide data that are not attainable using other techniques. CSIA can provide insight into both source identification and degradation processes (USEPA, 2008).

### Baseline CSIA Measurement

The determination of whether CSIA would be a useful tool at a chlorinated solvent site requires collection of baseline samples to obtain a preliminary understanding of fractionation behavior in contaminants at the site. Prior to performing CSIA, the contaminant concentrations should be analyzed using conventional methods to ensure that the CSIA analytical techniques will provide adequate sensitivity. Section 2 in USEPA (2008) provides a detailed discussion of laboratory procedures for CSIA.

A minimum of two baseline sampling events are recommended for sites with heterogeneous geology or variable plumes to ensure reproducibility of the CSIA data. Spatial variability of contaminant distributions may necessitate a larger number of baseline sampling events, however. The baseline CSIA data serve as a benchmark against which to compare future data (i.e., during active remediation and/or longer-term monitoring), and the baseline CSIA data may be used to improve the site CSM as discussed below.

### Forensics – Source Discrimination

CSIA may be used as a forensic tool to discriminate between various potential sources of chlorinated solvents. Chlorinated ethenes often migrate over extended distances in aquifers and may originate from different sources. CSIA of chlorinated solvents may be used to distinguish between different DNAPL sources and to associate plumes with their particular sources. This method relies on the observation that  $d^{13}C$ , as well as other stable isotopes, vary for solvents produced by different manufacturers and, to a lesser degree, different production batches by the same manufacturer (Hunkeler et al., 2004). Therefore, this technique works best when there are multiple sources of the same groundwater contaminants and also at sites with little fractionation (i.e., slow degradation). To avoid confounding effects from isotope fractionation due to biodegradation, it is best to collect samples from the original NAPL sources, or groundwater samples from as close as possible to the source of each spill. Chapter 6 of USEPA (2008) provides a detailed sampling strategy for the use of CSIA to evaluate sources of groundwater contamination. Data on the variation in the isotope ratios of carbon and chlorine in chlorinated solvents and chlorinated production chemicals are also summarized in USEPA (2008).

### Qualitative and Quantitative Evidence for Degradation

For parent molecules (i.e., the material that was initially released – typically PCE or TCE), the observation of carbon isotope fractionation provides qualitative evidence for degradation. For the daughter products (i.e., the compounds that are produced through degradation of the parent molecules), fractionation alone does not prove degradation because the daughter products become enriched in carbon as the parent becomes enriched. If the daughter product does not

degrade, its  $d^{13}C$  cannot exceed the parent's primary isotope signature, which is the carbon isotopic ratio of the source material prior to fractionation by biodegradation or abiotic transformations (i.e.,  $d^{13}C_{source}$ ). If the daughter product also degrades, then the lighter carbon isotope will be reacting at the same time as the daughter product is being produced, allowing the  $d^{13}C$  of the daughter to exceed that of the parent. Therefore, for chlorinated solvent daughter products, a carbon isotope ratio heavier than the primary isotope signature of the parent product is evidence that the daughter product is also degrading (see Figure 6-1).

**Figure 6-1. Compound Specific Isotope Analysis and Degradation**

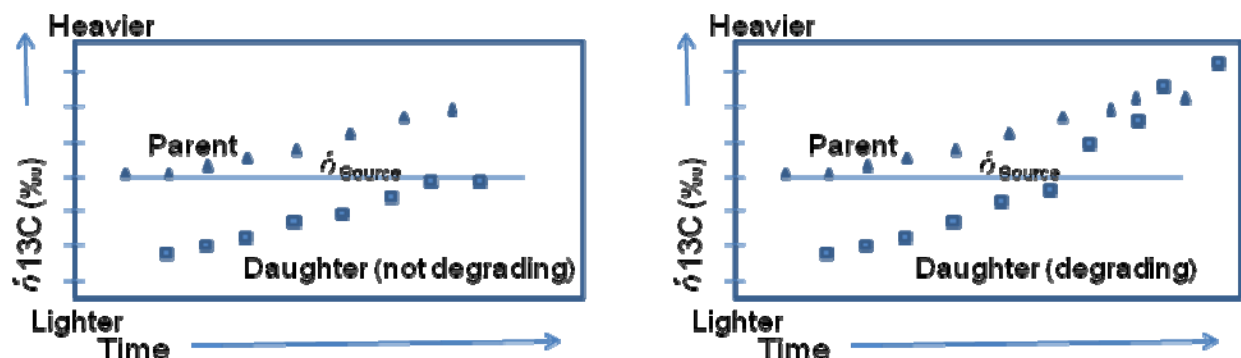

Based on Microseeps, Inc. 2009

Another application for collecting samples for CSIA during site characterization is to quantify the extent of degradation that has already occurred in different parts of a solvent plume using the Rayleigh model presented above (Equation 6-6). This first requires determination of the primary isotope signature (i.e.,  $d^{13}C_{source}$ ). The primary isotope value may then be used in conjunction with an appropriate enrichment factor to estimate the extent of degradation. As noted in USEPA (2008), there are three general approaches to estimating  $d^{13}C_{source}$ :

1. Where samples of the actual spilled material are not available, make an assumption for  $d^{13}C_{source}$  based on published literature values for undegraded pure product.
2. Because degradation induces a positive  $d^{13}C$  shift of the residual compound, use the most negative value measured in groundwater at the site for the solvent of interest as an estimate of the original value of  $d^{13}C_{source}$ .
3. Estimate  $d^{13}C_{source}$  based on point-to-point or time-to-time comparisons of the relative amount of degradation between wells, or in a given well over time. This approach requires a solid hydrogeological and geochemical understanding of the site.

Selection of an appropriate enrichment factor depends upon understanding the site-specific geochemical parameters influencing degradation pathways. Table 8.1 in USEPA (2008) provides a comprehensive listing of biodegradation enrichment values published in the literature, organized by compound of interest, redox condition, and microbial consortium. Because there is variation in published enrichment factors, a conservative approach is to select the largest enrichment factor (i.e., most negative value) in the literature. Alternatively, there are statistical methods that may be used to calculate the mean and the standard deviation of the enrichment

factors (and associated errors) and to place upper and lower bounds on the extent of biodegradation. The reader is directed to USEPA (2008) for a detailed discussion regarding selection and estimation of appropriate enrichment factors.

### Numerical Modeling

At many chlorinated solvent sites, mathematical models are used to simulate contaminant transport in three dimensions to enhance the CSM. These models incorporate not only the physical characteristics of groundwater flow, but also the reactive processes of biodegradation or abiotic transformation. These reactive processes result in fractionation of carbon isotopes, and thus CSIA measurements may be used as a check on the model calibration and predicted outcomes because the extent of degradation calculated with CSIA is independent of the concentration of the contaminant. Several initial models have been developed by researchers to investigate fundamental characteristics of CSIA, such as variability of enrichment factors and prediction of enrichment factors for sequential dechlorination reactions (van Breukelen et al., 2005; Morrill et al., 2006). These models have been applied in one-dimensional batch or column experiments. As the relationship between laboratory-derived and field-observed enrichment factors becomes better understood, it is feasible that isotope constraints could be incorporated into three-dimensional reactive transport models.

### **Active Remediation**

CSIA data may be used during active remediation to confirm that the desired performance outcomes for the remedy are being achieved. CSIA is applicable for process and performance assessment of remedial technologies that are designed to transform the contaminants of interest, including enhanced in-situ bioremediation and abiotic in-situ technologies, as well as MNA. CSIA is also useful in providing information regarding the mechanisms and rate of degradation, which can be used to ascertain whether a remedy is performing as desired.

### Demonstration of MNA

Demonstration that a chlorinated solvent is actually being degraded, and the rate at which it is being degraded, is important for performance monitoring during MNA. Degradation rate constants at field scale may be estimated using the calculated extent of degradation (Equation 6-6) together with assumptions about groundwater flow rates and flow paths. Equations that may be used to derive a first-order degradation rate constant between two monitoring points along a flow path are derived in Section 7.4 of USEPA (2008). The CSIA data may be used to test the hypothesis that contaminant concentration decreases are due to biodegradation or abiotic transformation, and the data may also be used to extrapolate the degradation that would be expected further along a flow path (USEPA, 2008). Calculated first-order rate constants may be incorporated into three-dimensional numerical models.

### Contaminant Degradation versus Dilution

Many in-situ remedies at chlorinated solvent sites involve injection of a substrate into the subsurface to reduce contaminant concentrations. The application of the substrate results in displacement of groundwater around the application point, and often raises concerns about whether observed effects are due to displacement of contaminants rather than degradation. This

is especially a concern for fractured bedrock systems that have limited porosity and thus essentially no storage, and where the introduction of an artificial hydraulic gradient through substrate injection will cause a large change in the natural flow regime, and also for areas where sensitive receptors are nearby. CSIA may be used to determine whether contaminant degradation is occurring, as opposed to displacement or dilution. Contaminant degradation is confirmed when enrichment in  $d^{13}C$  is measured, as discussed above.

van Breukelen (2007) modified the Rayleigh equation to account for dilution under open-system field conditions. van Breukelen (2007) concluded that isotopic enrichment factors derived from field observations underestimate the true values as a consequence of dilution. The derived equations provide a check on the upper (i.e., least negative) limit of the selected enrichment factor, thereby resulting in a more conservative and reliable prediction on the extent of degradation.

#### Evaluation of Mechanisms for Biodegradation

During reductive dechlorination of chlorinated solvents, mass balance between parent compounds (e.g., PCE and TCE) and reductive daughter products (e.g., ethene) is often not observed in groundwater samples, which leads to concerns regarding the actual fate of the contaminants. Also, at sites with mixtures of chlorinated ethenes and chlorinated ethanes, similar degradation products may originate from different primary compounds. CSIA may be used as a tool to specifically evaluate the mechanisms for contaminant concentration reductions (Song et al., 2002; Hunkeler et al., 2005).

Song et al. (2002) used CSIA to investigate the potential of using lactate to enhance in-situ microbial degradation of TCE. The CSIA data were used to distinguish between the effects of groundwater transport, dissolution of DNAPL, and the effects of enhanced bioremediation. The CSIA data demonstrated complete transformation of dissolved TCE to ethene, validating the selected remedy. Over time, the  $d^{13}C$  of ethene in the well where organic acids were detected reached the  $d^{13}C$  of the original TCE, confirming that complete reductive dechlorination was occurring. This study also demonstrated the t-DCE that was present at the source area did not degrade; concentration and  $d^{13}C$  values of t-DCE did not decrease.

Hunkeler et al. (2005) used CSIA to evaluate degradation mechanisms at a former waste disposal site where 14 different chlorinated ethenes, ethanes, and methanes were detected. The CSIA data indicated that TCE initially thought to be present as a source product and/or a PCE dechlorination daughter product was actually attributable to dehydrochlorination of 1,1,2,2-PCA. The CSIA data also indicated that VC and ethane resulted from elimination of two chlorine atoms from 1,1,2-TCA and 1,2-dichloroethane (DCA), respectively, rather than from reductive dechlorination of the chlorinated ethenes PCE and TCE. The CSIA data showed that chlorinated ethanes and methanes were undergoing significant intrinsic degradation, while the degradation of the chlorinated ethenes was limited. The degradation mechanisms observed in this study would have been difficult to discern without the use of CSIA.

## **Long-Term Monitoring**

CSIA data may be collected after active remedy application, during long-term monitoring, to track the progress of contaminant degradation via biological or abiotic processes. The Rayleigh equation and its modifications, as outlined above, may be used to estimate the degree of contaminant degradation. Degradation rate coefficients calculated using CSIA data may be used to estimate the duration that long-term monitoring will be required. CSIA data may also be used to provide information about contaminant rebound effects. Contaminant rebound may be identified if the carbon isotope composition of the chlorinated compound of interest trends toward the original carbon isotopic signature prior to treatment. Time-series CSIA measurements, coupled with groundwater flow data, may also aid in determining the location of the contaminant reservoir contributing to the rebound.

## **6.2. Status of Compound Specific Isotope Analysis**

### **6.2.1. Applications to Date**

CSIA for chlorinated solvents is a topic of active research. Most of the applications to date involve laboratory studies. However, the number of field applications is increasing, since the laboratory results for use of CSIA as a diagnostic tool are promising. Isodetect (2009) lists six chlorinated solvent sites where CSIA was performed successfully to demonstrate natural attenuation. Two of the sites are in Europe and four are in North America. Based on a literature review, data from at least five additional chlorinated solvent field studies have been published.

CSIA was implemented as a diagnostic tool at two of the test sites evaluated under this project (ESTCP Project ER-0318): Fort Lewis and Watervliet Arsenal. The results of the CSIA applications at these sites are discussed in Section 8.6.1 of this report.

### **6.2.2. Commercial Status and Cost**

Research laboratories at the University of Waterloo and at the University of Toronto specialize in compound specific isotope analyses. Microseeps is the only commercial laboratory in North America to offer CSIA. They currently offer analyses for various compounds including chlorinated solvents. The cost ranges from approximately \$300 to \$500 per sample, depending on the number of compounds to be analyzed.

### **6.2.3. Regulatory Acceptance**

There are currently no standard analytical methods for CSIA. Therefore, methods and results can be highly variable among laboratories conducting this work. It is important to use the same methods and laboratories on a given project so that results are comparable. Guidelines to achieve acceptable data quality are provided in Chapter 2 of USEPA (2008).

Regulatory community awareness and/or acceptance is expected to increase along with the increased use of CSIA in field applications as noted above.

### **6.3. Applicable Site Settings and Remedial Technologies**

The most important site condition that influences the use of CSIA is the type of contaminants that are present. CSIA has been applied most widely for chlorinated solvents and BTEX and MTBE. A few applications of CSIA for PAHs, and PCBs, have also been reported (Sueker, 2001; USEPA, 2008). With current technology, the heaviest compounds that can be analyzed for shifts in carbon isotope ratios contain twelve to thirteen carbon atoms (USEPA, 2008). Application of CSIA is generally not influenced by site geology or hydrologic conditions.

CSIA may be applied for a wide variety of treatment technologies that result in biological and/or abiotic contamination degradation. To date, the majority of applications have involved biodegradation. However, several ISCO applications have been reported, including ISCO with Fenton's reagent and persulfate (Ahad and Slater, 2008; Marchesi et al., 2009), as well as ISCO with permanganate, which was demonstrated at the Watervliet Arsenal (Malcolm Pirnie and University of Waterloo, 2010) and also at other sites (Poulson and Naraoka, 2002; Hunkeler et al., 2003). Theoretically, CSIA could be applied at any sites where reactive processes in groundwater produce a change in the ratio of stable isotopes.

### **6.4. Advantages and Disadvantages Compared with Other Available Approaches**

CSIA can provide unique data to assist in site characterization, remediation design, and long-term monitoring. The advantages of performing CSIA are as follows:

- CSIA provides information about contaminant degradation independently of concentration data
- CSIA may be used to provide a conservative estimate of the extent of degradation (using the Rayleigh model and modifications to the model, as appropriate)
- It may be used as a forensic tool to help identify the source of contamination
- Fractionation factors calculated using CSIA data may be used in numerical fate and transport models to improve the CSM
- CSIA data may be used to elucidate mechanisms of biological degradation

Some of the drawbacks to using CSIA include the following:

- CSIA adds analytical costs to monitoring programs at chlorinated solvent sites

- The technique is generally limited to smaller molecules (fewer than 12 carbon atoms)
- Currently, there is limited commercial access to CSIA
- CSIA does not indicate if degradation is occurring currently. Unless it is used during an active remedy (e.g., ISCO), the results may be indicating historical degradation
- Correct interpretation of CSIA results requires knowledge of site geology and geochemistry
- Currently, CSIA is a relatively unknown among the regulatory community, due to its relatively low use to date in full-scale field or project applications

## **6.5. Summary**

CSIA provides unique insights for interpreting and supplementing contaminant fate and transport data obtained using traditional, or other innovative, diagnostic tools. CSIA, in particular for carbon isotopes, may be applied during the site characterization, active remediation, and long-term monitoring stages of addressing a chlorinated solvent-contaminated site. This tool is applicable in a wide variety of geological settings and is appropriate for assessing the performance of many types of engineered remediation systems that result in contaminant degradation and subsequent changes in the ratios of stable isotopes. It is likely that as CSIA becomes a more widely accepted diagnostic tool and as analytical instruments and methods are improved, new applications of CSIA will be developed to allow practitioners to gain a better understanding of the source, distribution, and behavior of chlorinated solvents.



## **7.0 MOLECULAR BIOLOGICAL TOOLS**

As introduced in Section 2.0, MBTs are the fifth set of innovative diagnostic tools addressed in this study. MBTs include a suite of innovative assays targeting biomolecules such as nucleic acids (deoxyribonucleic acid (DNA) and ribonucleic acid (RNA)), lipids, and proteins, as well as isotopes to provide evidence regarding the composition and/or activity of microbial communities. These assays can have significant utility in remediation applications that rely on biological degradation mechanisms to attenuate contaminants. MBTs provide a way to understand growth and activity of contaminant-degrading microbes to determine if environmental conditions are suitable to achieve desired biodegradation processes (i.e., MNA), or whether manipulation of the aquifer environment (i.e., biostimulation) and/or addition of desired microorganisms (i.e., bioaugmentation) is required to optimize conditions that facilitate contaminant biodegradation. In addition, MBTs can be used to understand biological processes that contribute to secondary water quality issues, such as the production of methane or reduction and dissolution of metals.

### **7.1. Background on Molecular Biological Tools**

Use of MBTs has increased substantially due to recognition of their value to improve design, implementation, performance evaluation, and optimization of remediation technologies, especially when biological degradation mechanisms are the focus of the treatment, as discussed in the SERDP/ESTCP workshop on MBTs (Leeson et al., 2005; Stroo et al., 2006). One particular application where enough MBT-based data have been generated to evaluate their utility is in-situ bioremediation for chlorinated solvents, and chlorinated ethenes in particular. Chlorinated solvents represent a particular challenge for cost-effective remediation due to their complex physical and chemical properties and their persistence once they have been released into the environment. Enhanced in-situ bioremediation is a low-cost alternative that has been extensively evaluated for dissolved-phase chlorinated solvent groundwater contamination (AFCEE, 2004), and has recently been considered a feasible technology for sites containing DNAPLs (ITRC, 2007; ITRC, 2005).

In addition, a survey of DNAPL remediation technologies suggested that enhanced bioremediation may be a more cost-effective remedy compared to other aggressive treatments such as chemical oxidation, surfactant/cosolvent flushing, and thermal remediation (McDade et al., 2005; McGuire et al., 2006). The implementation of bioremediation, however, can be difficult due to the complex and specific requirements necessary to achieve chlorinated solvent biodegradation (ITRC, 2007). In addition, byproducts of bioremediation, such as methane formation, increases in concentrations of dissolved metals, and generation of secondary water quality impacts, must also be considered (AFCEE, 2004). Therefore, tools that evaluate the presence and activity of important microbial populations and/or processes can potentially be very useful. MBTs, however, also have significant limitations, and care must be taken not to over-interpret results and to understand the caveats for the data that are generated. In addition, it may be unnecessary to generate MBT data in some instances. The goal of this document is to provide an overview of the state of the practice of MBTs for chlorinated solvent applications and to discuss the utility and value of integrating MBTs into bioremediation remediation design and

implementation. An overview of important biological remediation processes is provided in Appendix C.

## 7.2. Principles of Molecular Biological Tools

Generally, MBTs using gene-based approaches target DNA, which is the genetic template from which all biological molecules are derived. DNA is transcribed into RNA when the microorganisms are metabolically active. RNA is then translated during synthesis of proteins (e.g., enzymes), which carry out metabolic processes for the microorganisms, such as production of lipids. MBTs can be used for qualitative descriptions, and, in some cases, quantitative estimates of DNA, RNA, proteins, or lipids. These targets dictate whether the assays are focused on identification of the presence of a capability, or on assessment of activity within a system.

The closer the MBT is to assessing the functions of interest, the more can be said about whether the desired function is actually occurring in the environment. Figure 7-1 illustrates the relationship between MBTs and activity.

**Figure 7-1. Hierarchy of Relationship between Molecular Biological Tools and the Activity of Interest, Biological Degradation**

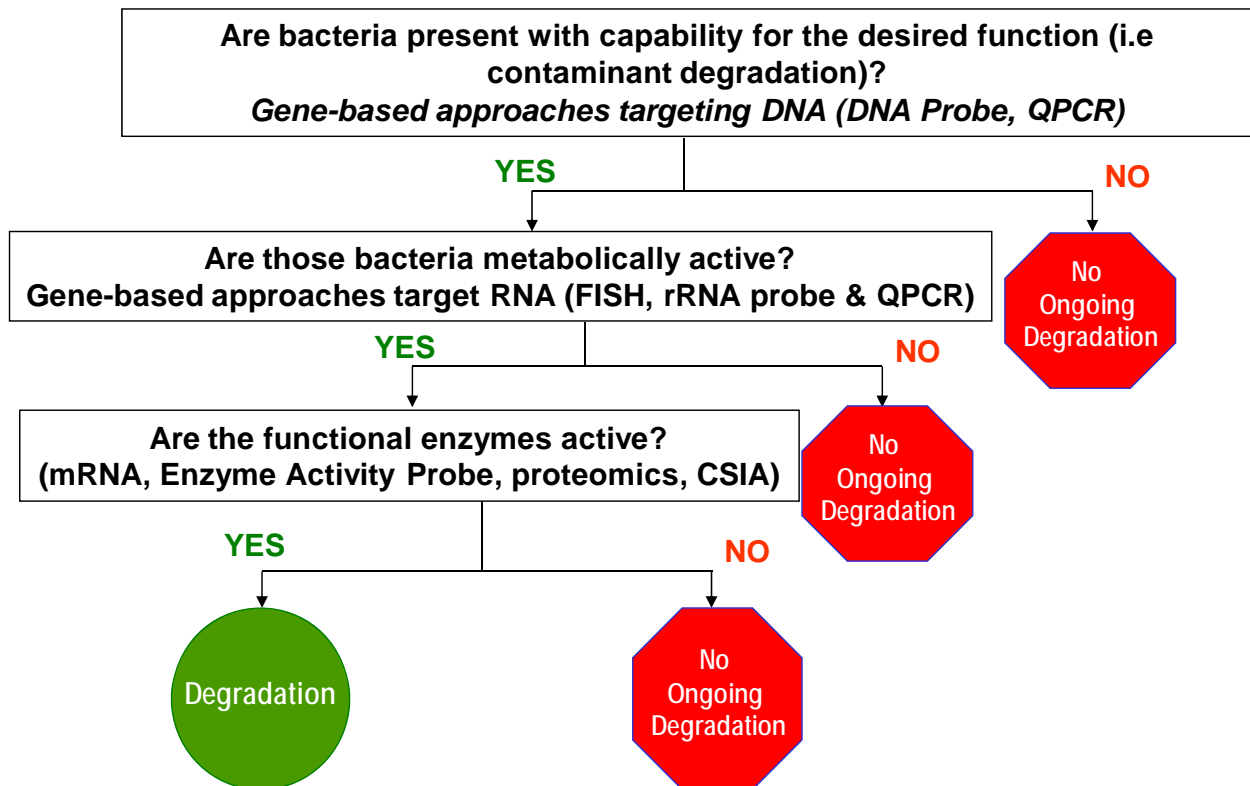

(modified from M.E. Watwood)

### 7.2.1. Gene-Based Analyses

Gene-based MBTs target either DNA or RNA that provide specific signatures that identify either a population (e.g., 16S ribosomal RNA (rRNA) gene specific to *Dehalococcoides* spp.) of interest or a biological function of interest (e.g., targeting functional genes that encode for the specific enzymes involved in halorespiration). In general, DNA-based methods are used to detect the presence of an organism or capability as an indication of the potential for a specific process of interest. DNA-based approaches can be qualitative (e.g., polymerase chain reaction (PCR)) or quantitative/semi-quantitative (e.g., quantitative PCR (qPCR)). If quantitative, the assays can provide information regarding the relative abundance of different populations or fate of the gene target over time. However, individual DNA-based MBTs employed at a specific point in time do not reveal whether specific microbial populations are active. To determine activity, a similar suite of MBTs can be employed, but they target expression of specific genes (RNA) or enzymes known to contribute to biodegradation. Because RNA and enzymes are short-lived in a cell, their expression indicates that the microbes are actively performing a given function.

### Polymerase Chain Reaction

PCR is the basis for most gene-based MBTs. PCR entails the selective targeting of a region of DNA and amplifying that region exponentially. This allows for generation of sufficient quantities of the desired target such that it can be observed using various techniques. PCR relies on a series of steps that mimic a microorganism's own mechanisms for replicating DNA. The specificity of the PCR reaction is dependent on DNA primers that are used to identify which region of DNA to amplify. Primers can be designed to target regions of DNA that are more conserved between microorganisms, thus amplifying large numbers of organisms. The 16S rRNA gene is frequently targeted for comparative analysis of evolutionary distance among bacteria, because it is present in bacteria, has the same function in all bacteria, can easily be aligned for comparison, and undergoes changes at a timescale comparable to that of evolution. Alternatively, primers can be designed to target specific regions of DNA that are highly variable, which results in greater selectivity and specificity of the reaction (e.g., targeting a functional gene such as the vinyl chloride reductase gene (*vcrA*) from *Dehalococcoides* spp.). Generally, the PCR products are observed on gels used to separate different DNA fragments from the sample to determine if the target was present or absent. Nearly all PCR-based methods targeting DNA can be used for RNA by first extracting RNA from the sample and then using reverse transcription PCR to convert the RNA to DNA, and then running the same assays.

### quantitative Polymerase Chain Reaction

qPCR is a semi-quantitative method for estimating the concentration of the target template (e.g., *Dehalococcoides* DNA) within a sample with high specificity, sensitivity, and reproducibility. qPCR is similar to PCR in that DNA is exponentially amplified; however, during qPCR, fluorescent markers are used to detect and quantify products after each round of replication. The fluorescent signal increases in direct proportion to the amount of PCR product in a reaction. By recording the amount of fluorescence emission following each replication cycle, it is possible to correlate the first significant increase in the amount of PCR product with the initial amount of target template. The higher the concentrations of the DNA target in the sample, the sooner a significant increase in fluorescence is observed. Standard curves are generated using known concentrations of target DNA in order to quantify the amount of the target in unknown samples.

qPCR is by far the most popular MBT for evaluation of chlorinated solvent sites, specifically because it can be used to assess multiple *Dehalococcoides* species, as well as specific functional reductase genes from those species relatively cost-effectively and easily.

### **Terminal restriction fragment length polymorphism and denaturing gradient gel electrophoresis**

Terminal restriction fragment length polymorphism (T-RFLP) and denaturing gradient gel electrophoresis (DGGE) are fingerprinting techniques that are used to provide information about the microbial community and/or specific populations, including numbers of different DNA sequences observed after PCR amplification of community genomic DNA. In general, these techniques provide an indication of the relative diversity of species among samples, and in some cases can suggest differences in relative abundance of species, though this must be approached with caution. T-RFLP uses a fluorescent probe to label amplified DNA during PCR and then separates different DNA sequences by using restriction enzymes that target specific sequences (i.e., every time it sees a “ccgg” in the sequence it cuts the DNA), leaving fragments of different sizes labeled with the fluorescent probe. The size of the cleaved fragment or terminal restriction fragment (T-RF), measured in base pairs (bp), varies among the microbial populations, or ribotypes. The output of T-RFLP analysis is a chromatogram that represents the number of T-RF ribotypes (used to represent each different population) on the x-axis and the fluorescent intensity of each T-RF on the y axis (used loosely to represent the relative abundance of each population within the community). Therefore, both the number of T-RFs present in a community profile and the relative height of the individual T-RFs provide information about the diversity of microbial populations within the microbial community. These relationships are used not to represent the actual diversity within the microbial community, but to determine the relative difference in diversity among different samples and among samples collected from the same location over time.

DGGE is a fingerprinting technique in which microbial DNA sequences are separated into discrete bands on a high-resolution gel, generating banding patterns on the gels. The sequences are separated based on differences in composition of the sequences. Because of the relatively low cost and ease of application, this technique has become widely used for assessing microbial abundance within environmental samples. In addition, this technique allows the dominant members of a community to be identified, and if coupled to DNA sequencing, to be qualitatively tracked over space and/or time (Macbeth et al., 2004; Dunbar et al., 1999; Dunbar et al., 2000; Dunbar et al., 2001).

### **Clone Library**

Clone libraries are assemblages of DNA sequences that are separated following PCR amplification by cloning them into plasmids, which are inserted into *Escherichia Coli* (*E. coli*) cells that are allowed to grow to form colonies, each colony having a different DNA sequence obtained from the original sample. Once grown, the plasmids are extracted from the *E. coli* and are then of sufficient quantity to be sequenced. The sequences are compared to databases containing all known microorganisms for phylogenetic (DNA sequence-based) identification. These techniques can provide relatively comprehensive evaluations of microbial community diversity and are also used to generate libraries of closely related gene sequences (i.e., 16S rRNA

gene sequences from different *Dehalococcoides* spp.). Generally, however, these methods are time-consuming and expensive relative to other MBTs, although costs have come down substantially with efficiencies in gene-sequencing technology.

## **Microarray**

Microarray technology is used to detect and quantify the presence of targeted genes (DNA) and/or their expression (RNA). DNA microarrays are essentially chips onto which the sequences from thousands of different genes are attached at fixed locations, called spots. Cellular DNA or RNA from samples is then fluorescently labeled and laid over the top of the array. DNA or RNA in the overlaid sample will “stick” (through a process called hybridization) if a complementary (i.e., having the appropriate matching sequence) spot on the array exists, and will be identifiable as a glowing spot on the array, while the spots that have nothing hybridized to them will not be visible. Microarrays are significant because they allow for the evaluation of presence and expression of a very large number of genes within a single assay. DNA microarrays are an emerging technology, and research is underway to develop remediation-specific microarrays. Currently, only limited availability of global microorganism arrays exists at universities and research labs.

## **Fluorescence in-situ hybridization**

Fluorescence in-situ hybridization (FISH) is one of the few gene-based MBTs that does not rely on PCR. FISH is considered a whole-cell assay and uses molecular fluorescent probes that bind, or hybridize, to either the DNA chromosome or to RNA present within microbial cells. If the cells contain the target of interest, the probe binds, fluoresces, and is evaluated under an electron microscope. In addition, different fluorescent probes can be used at the same time, in order to detect several different types of targets (e.g., *Bacteria*, *Archaea*, *Dehalococcoides*) within a given sample. FISH not only provides evidence of presence and abundance of specific targets of interest, but provides spatial information about how cells are co-located within a groundwater sample or within a biofilm. FISH probes have been developed that target chlorinated solvent-degrading populations, such as *Dehalococcoides* (Yang and Zeyer, 2003; Yang et al., 2005; Aulenta et al., 2004).

### **7.2.2. Phospholipid Fatty Acid Analysis**

Lipid-based tools like phospholipid fatty acid (PLFA) analysis can gauge three key aspects of the microbial community, including viable biomass, community composition, and metabolic status. PLFA is a substance found in the cytoplasmic membrane of the microbial cell. PLFA analysis is based on the extraction and separation of lipid classes followed by quantitative analysis using gas chromatography and mass spectrometry. The individual fatty acids differ in their chemical composition depending on the organisms present and the environmental conditions. Therefore, PLFA analysis can help to determine how much biomass is in a given sample and what general types of microorganisms are present. While PLFA can provide indications regarding general biomass and community structure, it is generally non-specific and does not provide information on key populations of interest (i.e., contaminant-degrading populations). With the increasing number of activity-based tests currently available and gene-based tests providing information on specific communities and microbes of interest, PLFA is gradually being replaced by more specific gene-based or protein-based tools.

### **7.2.3. Protein-Based Analyses**

#### **Enzyme Activity Probes**

Enzyme activity probes (EAPs) are substrates that can bind to specific enzymes of interest, and are subsequently transformed by those enzymes into fluorescent products. If the appropriate enzyme is not present, or it is present but not active in a given sample, then the probes will not be transformed and no fluorescence will be detected. Therefore, the technology directly measures both the presence and activity of the enzyme. EAPs have been developed to assess the presence and activity of specific microorganisms in contaminated subsurface environments, primarily those associated with aerobic cometabolic oxidation of chlorinated solvents (Lee et al., 2008a; Wymore et al., 2007). EAPs have been developed for a suite of enzymes that cometabolically degrade chlorinated ethenes, including those associated with aromatic compounds (toluene, phenol, benzene), and methane.

#### **Proteomics**

Proteomics involves the identification of proteins expressed by a microbial cell and the determination of their role in the physiology of that cell. While still relatively novel, these analyses can provide direct evidence of any one targeted protein, or all proteins, such as biodegrading enzymes, being expressed by microbial populations (Morris et al., 2007). Studies have proposed functional gene products (messenger RNAs (mRNAs) and enzymes) that could serve as molecular bioindicators for specific dehalorespiration processes (e.g., specific reductive dehalogenases) (Morris et al., 2007; Fung et al., 2007; Simeonova et al., 2009; Werner et al., 2009), and aerobic oxidation of VC (Chuang and Mattes, 2007). While these methods have significant potential for understanding specific functional activity occurring within a sample, logistical challenges, such as absolute quantification of proteins in environmental samples, hinders their availability for widespread use (Werner et al., 2009), and they currently remain in the research stage.

### **7.3. Context for Use of Molecular Biological Tools for Bioremediation**

As discussed in Appendix C, biological processes that either directly or indirectly impact contaminant degradation are complex. As discussed in the SERDP/ESTCP workshop on MBTs (Leeson et al., 2005), MBTs can be used to provide evidence that desired (or undesired) biological processes are occurring. Ultimately, the remedial decisions that are supported by data generated from MBTs include the following:

1. Is biodegradation occurring at the site, and is the rate of attenuation sufficient to meet RAOs?
2. Are native contaminant-degrading populations present at the site, or is bioaugmentation necessary?
3. Are contaminant-degrading populations active at the site, or do they need to be stimulated?
4. Are processes or conditions limiting biodegradation rates that could be optimized to facilitate achieving RAOs?

5. What other biological processes may be contributing to undesirable secondary water quality impacts, and can they be mitigated?

These questions provide a useful framework for summarizing the current field experience with MBTs and for discussing potential future developments and their impact on remedial action decisions.

#### **7.4. Status of Molecular Biological Tools**

MBTs have been widely used to demonstrate the presence of, and in some cases the activity of, biological degradation mechanisms for sites undergoing either intrinsic or enhanced bioremediation. In the case of intrinsic bioremediation (i.e., natural attenuation), it is often important to demonstrate that biological attenuation is occurring at sufficient rates to stabilize and/or shrink the contaminant plumes. Often, contaminant degradation mechanisms (e.g., aerobic oxidation or aerobic cometabolism) produce end products that are difficult to track in the environment, such as chloride ion (e.g., low values compared to background chloride levels), carbon dioxide, and water. Therefore, direct microbial evidence of intrinsic biodegradation can provide important information that these mechanisms are occurring at a site. MBTs used for this application are described in Sections 7.4.1 and 7.4.2. The halo-respiration mechanism (and other anaerobic mechanisms) is of great interest for both intrinsic and enhanced bioremediation. MBTs for these applications are described in Section 7.4.3. Section 7.4.4 describes MBTs used to understand methanogenic activity, which can be important especially for optimization of the anaerobic biodegradation pathways. Finally, case studies documenting MBT usage for a variety of these applications are presented in Section 7.4.5.

##### **7.4.1. Aerobic Oxidation**

MBTs have been used to detect organisms capable of aerobic oxidation of chlorinated solvents, although these techniques have only been demonstrated in the laboratory and generally have not been applied to the field. PCR techniques have been developed to identify genes in *Mycobacterium* and/or *Norcardioides* strains capable of degrading VC and ethene (Coleman and Spain, 2003; Coleman et al., 2002; Mattes et al., 2007; Mattes et al., 2005). In addition, proteomics was recently used to identify the significant enzymes expressed in response to VC, ethene, and epoxyethane biodegradation by *Norcardioides* sp. strain JS614 using a peptide mass fingerprinting during VC biodegradation (Chuang and Mattes, 2007).

##### **7.4.2. Aerobic Cometabolism**

Cometabolism of chlorinated solvents has been widely demonstrated by organisms expressing oxygenase enzymes, including those that utilize primary substrates (Alvarez-Cohen and Speital, 2001; Chang and Alvarez-Cohen, 1995), methane (Anderson and McCarty, 1997), butane, toluene (Azizian et al., 2007; Malachowsky et al., 1994; Wackett and Householder, 1989; Hopkins and McCarty, 1995), benzene (Malachowsky et al., 1994), phenol (Hopkins and McCarty, 1995), propane (Malachowsky et al., 1994; Wackett et al., 1989), propylene (Ensign et al., 1992), isoprene (Ewers et al., 1990), 3-chloropropanol (McGuire et al., 2006), and ammonia (Vannelli et al., 1990) for TCE, DCE, and VC in addition to ethene and ethane (Freedman and Herz, 1996) for VC. MBTs discussed here largely focus on targeting genes that encode for the oxygenase enzymes responsible for the cometabolic transformations due to the relatively large

diversity of organisms that contain these functions. Table 7-1 presents a summary of substrates, functional genes, and references for MBT PCR assays that have been developed, many of which are commercially available, for methane oxygenases (McDonald et al., 2008), aromatic oxygenase genes (Baldwin et al., 2003; Hendrickx et al., 2005; Hendrickx et al., 2006), propane- (Kotani et al., 2003), ammonia- (Rotthauwe et al., 1997), and butane- (Sluis et al., 2002) monooxygenases.

**Table 7-1. Cometabolic Systems and Associated Functional Genes with References to Developed MBT**

Substrate	Functional Gene (s)	Reference
Methane	<i>16srRNA for Type I Methanotrophs</i>	Review provided by McDonald et al., 1998
	<i>16srRNA for Type II Methanotrophs</i>	
	<i>Soluble methane monooxygenase mmoX genes</i>	
	<i>Particulate methane monooxygenase pmoX gene</i>	
Propane	<i>Propane monooxygenase</i>	Kotani et al., 2003
Toluene	<i>Toluene dioxygenase, toluene monooxygenase</i>	Hendrickx et al., 2006
Multiple Aromatics	<i>Naphthalene dioxygenase, toluene dioxygenase, xylene monooxygenase, biphenyl dioxygenase, toluene monooxygenase, phenol monooxygenase</i>	Baldwin et al., 2003
Ammonia	<i>Ammonia monooxygenase</i>	Rotthauwe et al., 1997
Butane	<i>Butane monooxygenase</i>	Sluis et al., 2002

PLFA analysis, which is commercially available, is useful for identifying and distinguishing lipids specific to Type I and Type II methanotrophs, which can carry out cometabolism of TCE (Nichols et al., 1985; Bull et al., 2000). However, to the authors' knowledge, this assay has not been applied in the field in the context of bioremediation.

EAPs have been developed to evaluate a variety of cometabolic oxygenases (Miller et al., 2002; Clingenpeel et al., 2005; Kauffman et al., 2003; Keener et al., 1998; Keener et al., 2001). These probes have been applied in the field specifically to aid in evaluation of aerobic cometabolism of TCE (Lee et al., 2008a; Wymore et al., 2007).

#### 7.4.3. Halorespiration/Anaerobic Cometabolism

PCR has been widely used to investigate aspects of communities performing reductive dechlorination during bioremediation (Rahm et al., 2006a; Macbeth et al., 2004; Löffler et al., 2000; Richardson et al., 2002, van der Zaan et al., 2010). For analysis of known dechlorinators at the genus or species level, most notably those related to *Dehalococcoides*, specific primers can be used. Recent approaches include the use of *Dehalococcoides*-specific primers with *qPCR* in order to quantify concentrations of these organisms in environmental samples and correlate with observed dehalogenation activity (Holmes et al., 2006; Lee et al., 2006; Lee et al., 2008b; Lu et al., 2006; Ritalahti et al., 2006). Using *qPCR* methods, techniques have been developed to identify four genes associated with *Dehalococcoides* spp. The first *qPCR* target was the 16S rRNA gene, which is used as the general marker for evaluating all strains of *Dehalococcoides* present in a sample. In addition to the general marker, three functional reductase genes—TCE reductive dehalogenase gene (*tceA*), *vcrA*, and the putative vinyl chloride reductase gene



(*bvcA*)—associated with differing reductive dechlorinating capacities have been described and associated primers developed. Reductase gene *tceA* was isolated from *Dehalococcoides ethenogenes* strain 195, which reduces TCE to cis-DCE and VC in energy-yielding reactions, but only reduces VC to ethene in a cometabolic reaction (Magnuson et al., 1998). Reductase gene *vcrA* was isolated from *Dehalococcoides* Strain VS, which degrades cis-DCE energetically to ethene (Muller et al., 2004). Reductase gene *bvcA* was isolated from *Dehalococcoides* Strain BAV1, which degrades TCE only cometabolically and energetically degrades cis-DCE and VC to ethene (Krajmalnik-Brown et al., 2004). Details of the methods, results, and evaluation of the qPCR methods can be found elsewhere (Lee et al., 2008b). Besides being demonstrated in a variety of laboratory studies, all of these qPCR methods have been widely used in the field.

In addition to PCR-based techniques, whole-cell assays using FISH molecular probes have also been developed to target *Dehalococcoides* spp. FISH can be used to evaluate the distribution of active *Dehalococcoides*, and to evaluate active gene expression of microbes *in-situ* based on RNA (Aulenta et al., 2004; Fazi et al., 2008; Rossetti et al., 2008). Single cells are fluorescently labeled with oligonucleotides that hybridize to rRNA. rRNA has largely been the targeted molecule because of its prevalence in all cells, which leads to a high signal intensity. In addition, different fluorescent dyes can be used at the same time, in order to evaluate the spatial variability of different target populations of microbes (e.g., Bacteria, Archaea, Methanogens) in addition to *Dehalococcoides* at any given time.

Proteomics has been used to identify proteins expressed by *Dehalococcoides* cultures including reductive dehalogenase proteins that corresponded to *pceA*, *tceA*, and *vcrA* (Morris et al., 2007); and DET1559 and DET1545 (Rahm et al., 2006b; Rahm and Richardson, 2008). In addition, other functional proteins including a formate dehydrogenase-like protein (Fdh) had high coverage in all strains and under all growth conditions. To date, however, limited application of these methods has occurred in field samples.

#### 7.4.4. Methanogenesis

The 16S rRNA gene is the most widely used target for PCR-gene primers and probes evaluating methanogens (Yu et al., 2005). In addition, primers have been developed for the functional gene sequence of the methyl coenzyme M reductase A (*mcrA*) (Luton et al., 2002; Hales et al., 1996; Steinberg and Regan, 2008), which catalyzes the last step of methanogenesis and is conserved among all methanogens. In addition, *mcrA* analysis shows mostly congruent phylogeny to the 16S rRNA gene and can thus be used in conjunction with, or independently of, that of the 16S rRNA gene. qPCR methods have also been developed for determining the copy number of the 16S rRNA gene (Castro et al., 2004), and targeting the *mcrA* gene (Steinberg and Regan, 2009), which is available commercially.

Previous studies described methanogen communities by quantitation of different populations through the use of rRNA-targeted FISH probes (Raskin et al., 1994a; b). FISH probes have been developed to evaluate the orders *Methanococcales*, *Methanomicrobiaceae*, and *Methanosarcinaceae* (Raskin et al., 1994a; b). These probes provide direct evidence that these populations are present and metabolically active, in addition to evaluating the spatial relationships between the populations.

A collection of three case studies is presented in Appendix D to illustrate representative field applications of a variety of MBTs, and to show how the data can be used to optimize or supplement bioremediation.

#### **7.4.5. *Summary of Advantages***

MBTs can provide information relevant to successful implementation of bioremediation, including:

- To determine if a site is biologically limited and requires bioaugmentation
- To determine if a biological mechanism for contaminant degradation is occurring, which is particularly useful if degradation by-products are difficult to measure in the field using standard sampling and analytical techniques

In addition, MBTs can provide useful information that can help explain processes that are occurring at a site, and thus potentially allow for optimization of the in-situ process. This includes information to:

- Evaluate microbial community responses to treatment
- Evaluate response in growth and activity of key microbial populations, including dehalogenating and methanogenic populations, during remediation
- Determine key operational parameters (e.g., low pH, substrate concentration, or reaction byproduct concentration) that might be limiting biodegradation efficiency by correlating growth and activity to those parameters

#### **7.4.6. *Summary of Disadvantages***

Several disadvantages to implementing MBTs exist that currently limit their widespread use, including the following:

- The methods are relatively specialized and require detailed knowledge of microbiology
- MBTs increase monitoring costs
- MBTs do not correlate with reaction rates. To date, data suggest that qPCR data cannot be correlated to dehalogenation rates (Lee et al., 2006; 2008b)
- No standardized analytical methods exist for MBTs. Therefore, methods and results can be highly variable between laboratories conducting this work. For instance, SERDP Project ER-1561 illustrated that MBT results for qPCR can vary depending on isolate, growth stage, primers, and nucleic acid extraction method chosen, highlighting a need to understand the precision and accuracy of methods being used and to recognize limitations of data interpretation, particularly when applied to field studies (Kong and Nakatsu, 2009). For a given project, it is important at least to use the same methods and laboratories so that results are comparable
- Very few laboratories perform MBT analyses commercially

## 7.5. Advantages and Disadvantages Compared with Other Available Approaches

Table 7-2 was modified from the SERDP expert panel workshop (Leeson et al., 2005; Stroo et al., 2006) and lists MBTs used in the field to varying degrees to date, and provides a qualitative assessment of the relative frequency of use, the perceived advantages and disadvantages, and current and possible future uses. MBTs can provide valuable information that can aid in the implementation of bioremediation-based strategies at sites. As discussed in Section 7.3, several key questions can be answered by MBT data. These questions are provided below along with a summary of MBT methods and alternative methods (i.e., conventional methods) for obtaining the information for comparison.

1. Is biodegradation occurring at the site and is the rate of attenuation sufficient to meet RAOs?
  - Best available MBT method: As noted for Question 3 below, several MBTs can indicate biodegradation activity; however, MBTs cannot directly measure biological attenuation rate.
  - Other MBT methods: Measurement of contaminant and degradation product concentrations over time with supporting qPCR data showing growth of target populations over time might largely answer this question for many sites.
  - Conventional/alternative method: Contaminant fate and transport modeling coupled to methods for assessing biodegradation rate, such as the tracer-corrected method (Sorenson et al., 2000). The presence of a residual source of contamination (e.g., DNAPL) greatly complicates estimates of overall remediation timeframe.
2. Are native contaminant-degrading populations present at the site or do I need to bioaugment?
  - Best available MBT method: qPCR provides direct evidence quickly and relatively cheaply regarding the presence of contaminant-degrading populations, including *Dehalococcoides* species, and can evaluate their changes in concentrations over time and space (e.g., demonstrating growth during biostimulation). qPCR can be used to determine the need for bioaugmentation during an initial design of bioremediation. When necessary, bioaugmentation can save significant time and money by accelerating the time required to achieve complete degradation to innocuous end products and reducing the cost of monitoring while waiting to see if indigenous populations grow.
  - Other MBT Methods: For aerobic cometabolic degradation, EAPs can be used to answer this question. As proteomics evolves, the potential exists that it will be possible to measure desired enzymes or other proteins directly in order to answer this question, but additional research and development is required.
  - Conventional/alternative method: For other degradation pathways, evaluation of groundwater chemistry, including contaminants and degradation products can be used. If significant degradation is not observed for an extended period of time, the need for bioaugmentation could be inferred.

3. Are contaminant-degrading populations active at the site or do they need to be stimulated?
  - Best available MBT method: EAP provides the most direct measure of activity, but limited methods are available (only aerobic cometabolic degradation pathways have been demonstrated). RNA-based qPCR provides direct evidence regarding the activity of *Dehalococcoides* populations.
  - Other MBT methods: DNA-based qPCR methods can also indirectly evaluate activity by documenting growth over time indicated by increasing concentrations. In the ER-0318 project, generally  $>10^7$  gene copies/L was required to see efficient degradation to ethene. Similar relationships were elucidated in Lu et. al. (2006) and the ESTCP project ER-0518 report. Proteomics has high potential but needs significant development for field-application.
  - Conventional/alternative method: Evaluation of groundwater chemistry, including contaminants and degradation products. Where possible, the tracer-corrected method can be applied to estimate intrinsic biodegradation rates of target contaminants based on the ratio of contaminant concentrations to a conservative plume tracer (Wymore et al., 2007; Sorenson et al., 2000). If significant degradation is observed in groundwater chemistry and reactions can be elucidated, MBT data are unnecessary.
4. Are processes or conditions limiting biodegradation rates that could be optimized to facilitate achieving RAOs?
  - Best available MBT method: The ability to evaluate *Dehalococcoides* populations with qPCR in response to bioremediation operations provides data to troubleshoot any conditions that may be adversely impacting *Dehalococcoides* growth and activity (e.g., pH, redox conditions).
  - Conventional/alternative method: Evaluation of groundwater chemistry, including contaminants and degradation products. If sufficient reaction rates are observed in groundwater chemistry and reactions can be elucidated, MBT data are unnecessary. However, MBT data can be valuable for troubleshooting reaction rates that are not sufficient to achieve objectives.
5. What other biological processes may be contributing to undesirable secondary water quality impacts and can they be mitigated?
  - Best available MBT method: The ability to evaluate methanogenic populations with FISH is the most sensitive; however, qPCR is more cost-effective and easier. qPCR (and probably other MBT) methods are also available for other populations that might cause secondary water quality impacts, such as metal reducers; however, their application to this issue has been limited at best.
  - Conventional/alternative method: Evaluation of groundwater chemistry, including concentrations of methane. Generally, MBT data are unnecessary to evaluate generation of methane, but may be useful to develop a strategy to mitigate production rates by favoring specific pathways.

**Table 7-2. Summary of Current Molecular Biological Tools for Monitoring/Diagnosing Remediation of Chlorinated Solvents**

<b>Tools</b>	<b>Frequency of Use</b>	<b>Advantages</b>	<b>Disadvantages</b>	<b>Current Applications</b>	<b>Comments</b>
<i>Gene-based approaches</i>					
qPCR (16S rRNA gene)	High	Provides information on presence/absence/abundance of organisms of interest; commercially available for a few key organisms (e.g., <i>Dehalococcoides</i> spp., methanogens); estimates of total bacterial numbers	Does not provide confirmation of activity; sampling, handling, and analysis not standardized	Screening tool for presence/absence of desired or indicator organisms; monitoring of growth and distribution of individual organisms	Expansion to wider range of organisms; standardized procedures needed
qPCR mRNA	Low	Provides information on gene expression (i.e., activity); quantitative approaches under development	Relative instability of RNA presents sampling and preservation challenges; sampling, handling, and analysis not standardized, more expensive than DNA-based approaches	A few experimental applications for confirming expression of functional genes	Needs wider range of genes of interest; standardization of approach; clarification of how mRNA abundance relates to activity
qPCR (functional gene)	High	Provides information on presence/absence/abundance of functional genes of interest; commercially available for a few key genes (e.g., reductive dehalogenase genes, sulfate reductase)	For DNA, does not provide confirmation of activity; sampling, handling, and analysis not standardized	Screening tool for presence/absence of target functional genes; monitoring of distribution and proliferation of specific genes	Needs wider range of functional genes; extension to mRNA; standardized procedures needed

<b>Tools</b>	<b>Frequency of Use</b>	<b>Advantages</b>	<b>Disadvantages</b>	<b>Current Applications</b>	<b>Comments</b>
DGGE	Low	Provides information regarding presence/absence of 16S rRNA and/or functional genes of interest; can provide an indication of target gene diversity; increased resolution with specific primers	Inconclusive results with non-specific primers; short amplicon length with insufficient information; not quantitative; no standardized procedures; cumbersome	Screening tool for presence/absence of indicator genes; sequencing of amplicons for positive identification	Use is quite specialized; will likely be replaced by qPCR methods; standardized procedures lacking
T-RFLP	Low	Provides relatively inexpensive basic information on community diversity and changes in community structure over time; can provide means to track individual organisms over time or space within a community when combined with other methods	Limited resolution; does not provide sequence information; not quantitative; biased towards dominant community members	Screening tool for community diversity; analysis of community structure; tracking of microbial groups within a community over time during and after active remediation	Standardized sample preparation procedures lacking; guidance document for data interpretation lacking
Clone Libraries (16S rRNA genes and functional genes)	Low	Indication of gene diversity; individual clones can be sequenced	Labor-intensive and expensive; not widely available commercially	Community structure analysis; identification of new genes	Will remain a research tool; limited applications for bioremediation monitoring
Microarray	Low	Provides the most comprehensive amount of information on presence and activity of microbial communities.	Limited number of arrays available and none developed focused on remediation; not	The PhyloChip is a microarray for rapid profiling of microbial populations. It has the ability to identify	Specific arrays need to be developed that focus remediation populations of

<b>Tools</b>	<b>Frequency of Use</b>	<b>Advantages</b>	<b>Disadvantages</b>	<b>Current Applications</b>	<b>Comments</b>
			available commercially.	multiple bacterial and archaeal organisms from complex microbial samples.	interest, more commercial availability and standardized procedures lacking
FISH	Low	Provides measurement of activity of organisms of interest; can be quantitative; visual information on spatial distribution	Not widely available; probes not available for a wide range of organisms; method development for each target organism required	A few experimental applications	Needs wider range of target organisms; more commercial availability; standardized protocols needed
<i>Lipid-based approaches</i>					
PLFA	Low	Community screening tool; monitoring individual groups of organisms; total biomass determination; commercially available; can be quantitative	Other methods provide more specific information for similar cost and effort	Biomass measurements; screening of high-level community structure and microbial ecosystem health	May be useful for identifying specific organisms; may have potential for measuring respiratory activity
<i>Protein- based approaches</i>					
Enzyme Probes	Low	Provides most direct measurement of the activity of interest (i.e., measures presence/absence of the actual enzyme)	Very few enzyme probes have been developed; not widely available	Direct measurement of various oxygenases (including methane and aromatic)	Needs wider range of enzymes; experimental and practical validation

<b>Tools</b>	<b>Frequency of Use</b>	<b>Advantages</b>	<b>Disadvantages</b>	<b>Current Applications</b>	<b>Comments</b>
Proteomics	Low	Provides direct evidence of the presence of desired enzyme, in addition to information about activity and physiological state of organisms	Difficulty detecting low-abundance proteins, still in research phase and method development required	Peptide bioindicator assays have been developed for certain populations (e.g., <i>Dehalococcoides</i> ) to identify strain and substrate-specific reductive dehalogenases	Needs wider range of proteins; experimental and practical validation



### 7.5.1. Commercial Status

Table 7-3 provides an overview of the commercial status of MBTs for bioremediation of chlorinated solvents.

**Table 7-3. Commercial Status of Molecular Biological Tools for Monitoring/Diagnosing Bioremediation**

<b>MBT</b>	<b>Biodegradation Mechanism Addressed</b>	<b>Secondary Biological Processes</b>	<b>Commercial Status</b>
PCR/qPCR-DNA	Aerobic cometabolism, aerobic oxidation, halorespiration	Methane production, sulfate/iron reduction, denitrification, acetogenesis, total bacterial growth	Commercially available
PCR/qPCR-RNA	Aerobic cometabolism, aerobic oxidation, halorespiration	Methane production, sulfate/iron reduction, denitrification, acetogens, total bacterial growth	Commercially available
DGGE/T-RFLP	All, if contaminant degrading bacterium is a predominant member of the community and analysis is coupled to DNA sequencing/identification.	Detects predominant members of the target group	Commercially available
Clone Libraries	All, if contaminant degrading bacteria are predominant members of the community	All, depending on how comprehensive evaluation is	Academic and national research laboratories
Microarray	All	All	Academic and national research laboratories
FISH	All	All	Academic and national research laboratories
PLFA	Aerobic cometabolism	Sulfate/iron reduction, fermentation	Commercially available
Proteomics	Halorespiration	NA	Academic and national research laboratories
EAPs	Aerobic cometabolism	NA	Commercial, academic, and national research laboratories

NA: Not evaluated.

### 7.5.2. Cost

Table 7-4 provides estimated costs for MBT assays. For PCR-based methods, variability in cost is due to the number of DNA extractions and targets that are run. In general, cost efficiencies exist with multiple targets (e.g., *vcrA*, *bvcA*, and *tceA*) for a given sample with a single DNA extraction.

**Table 7-4. Estimated Costs for Molecular Biological Tool Assays**

<b>MBT</b>	<b>Analytical Cost</b>
PCR/qPCR-DNA	\$225 (includes DNA extraction) + 75/target/sample*
PCR/qPCR-RNA	\$225 (includes DNA extraction) + 75/target/sample*
DGGE/TRFLP	\$300-400/target/sample
Clone Libraries	NA
Microarray	NA
FISH	\$200-300/target/sample
PLFA	\$300-500/sample
Proteomics	NA
EAPs	\$300-\$400/EAP/Sample

\*Note that these costs generally represent common targets for anaerobic chlorinated solvent remediation (i.e. total bacteria, Dhc, *vcrA*, *bvcA*, and *tceA*). PCR and qPCR can be done at much less expense if automated processes (i.e., robots) are used to do large scale DNA extractions and PCR.

NA- not commercially available

### 7.5.3. Regulatory Acceptance

As the use of MBTs becomes more prevalent, the regulatory community has become aware of their significance, and MBT-based data have been used to gain regulatory acceptance of remedies. However, a generally limited understanding of use and interpretation of MBT data still exists within the regulatory community. In order to address this need, the ITRC started the technical Environmental Molecular Diagnostics team (EMD team) in 2010. The mission of the team is to advance the use of molecular biological and chemical diagnostic techniques (or tools) for use in environmental restoration of contaminated soil and groundwater (ITRC, 2010a). The most important of these “environmental molecular diagnostics” (EMDs) identified by ITRC are various MBTs that can identify and quantify key microorganisms (taxonomy) and their genes (function). These techniques can be used to assess when natural attenuation as a stand-alone remedy is sufficient, or whether enhancements such as chemical amendments or bioaugmentation are necessary. It is the goal of the EMD team to summarize the fundamental background and current status of available EMDs and provide objective guidance on the best practices for using EMDs and evaluating, applying, and interpreting the results of EMDs. Technical and regulatory guidance should lead to greater use and confidence in these diagnostics, and help site managers faced with major decisions about site design, management, and resolution.

## 7.6. Summary

MBTs provide important information that facilitates the successful implementation and optimization of bioremediation of chlorinated solvents. These methods can provide unique

information that provides an understanding of the microbial communities and processes that are essential for biological treatment of chlorinated solvents, including biological degradation mechanisms and secondary factors such as methanogenesis. MBTs that target specific, key processes or populations of interest (e.g., cometabolic oxidation and *Dehalococcoides*) are particularly useful. Generally, the widespread use of MBTs other than qPCR for *Dehalococcoides* is currently limited by logistical issues such as the lack of standardized methods and the limited number of commercially available labs. In addition, MBT methods currently only have a limited ability to quantify contaminant attenuation rates relative to standard approaches, which limits their decision-making impact at this time. MBT use and data interpretation are still somewhat specialized, and are not generally well-understood among industry, practitioners, and the regulatory community. As a greater technical understanding of biological processes that affect contaminant fate and transport is developed, corresponding MBTs will continue to be developed and will have increasing utility within the bioremediation field.

## **8.0 VALUE ADDED THROUGH THE APPLICATION OF INNOVATIVE DIAGNOSTIC TOOLS AT CHLORINATED SOLVENT SITES**

### **8.1. Introduction**

The diagnostic tools evaluated in this ESTCP project provide decision-makers addressing cleanup of chlorinated solvent sites with information that may improve the timeliness and accuracy of decision-making within the context of site cleanup. The primary objective of the use of these tools is to improve remedial design, selection, and performance assessment of in-situ technologies applied at chlorinated solvent sites. Five groups of diagnostic tools have been evaluated in this project, including the following:

- Multi-level monitoring systems
- Rock matrix characterization
- Mass flux-mass discharge measurement methods
- CSIA
- MBTs

These tools are considered “innovative” in that they are not routinely used for site characterization or performance assessment in the remediation industry, although their use has increased substantially since the initiation of this ESTCP project. No ASTM (formerly the American Society for Testing and Materials, now known as ASTM International) standards have yet been developed for the application of these diagnostic tools.

These tools were tested in three different geologic environments: (1) fractured shale at Watervliet Arsenal (a Type IV hydrogeologic setting), (2) highly heterogeneous alluvial geology at Fort Lewis (a Type III hydrogeologic setting), and (3) moderate heterogeneous geology at Vandenberg AFB (a Type II hydrogeologic setting). They were applied to the performance assessment of two in-situ technologies: ISCO with permanganate at Watervliet Arsenal, and in-situ bioremediation at Fort Lewis. Not all of the tools were tested at each site given that some of the tools are geology-specific (e.g., rock matrix characterization for consolidated media), or technology-specific (e.g., MBTs at Fort Lewis). As a consequence, providing guidance on the use of these technologies to the wide diversity of sites in the DoD portfolio of chlorinated sites is not straightforward, and not appropriate based on the experiences at these three sites alone. In this final section of this Guidance Document, however, we provide both qualitative and some quantitative analysis of the application of these innovative diagnostic tools to demonstrate the advantages of these innovative tools to complement the use of conventional techniques widely used in the remediation industry.

As discussed in Section 2.0, the life-cycle of contaminated sites follows a well-established but still highly non-linear sequence of events from initial discovery to final closure. Comparatively, all of the regulatory-driven processes during this life-cycle contain all or some of the following key decision points:

- Discovery and initial site characterization

- Development of a CSM including identification of sources, pathways, and receptors for the chemical(s) of concern
- Risk assessment for the “no-action” alternative
- Screening and selection of remedial actions when warranted
- Final selection of remedy for site to meet cleanup objectives at specified points of compliance
- Implementation of remedy including monitoring programs
- Performance assessment and optimization of remedy
- Comparison of performance to cleanup objectives
- If necessary, modification of the remedy and continued performance assessment
- If necessary, selection of alternative endpoints, alternative points of compliance, or transition to passive remedies (e.g., monitored natural attenuation) and a risk analysis of this option
- Closure of the site (e.g., no further action necessary) or transition to long-term management and control, with appropriate institutional controls in both outcomes

These and other decision points are site-specific, and are affected by many factors that result in complex interactions among all parties at the site. In particular, during the life-cycle of site remediation, many key decisions must be made within the context of considerable uncertainty, given the highly variable nature of the subsurface, the range of short- and long-term land uses, and the uncertainties of stakeholder opinions regarding the ultimate disposition of the property. However, some of the innovative diagnostic tools evaluated in this project are potentially applicable to all chlorinated solvent-contaminated sites in diverse geological, geochemical, and institutional settings.

The advantages of each of the diagnostic tools tested here have been summarized in the previous sections for each tool individually. These tools are designed to provide information on performance of in-situ technologies that would otherwise not be available from “conventional” techniques. Collectively, important potential advantages of these diagnostic tools include the following:

- A more accurate and detailed CSM, which can result in optimum selection and design of in-situ remedies
- More accurate performance assessment in real time, resulting in more efficient operation of the remedy or optimization of the remedy after remedy installation
- Assessment of the feasibility of achieving certain endpoints, such as background concentrations or maximum contaminant levels (MCLs) in groundwater that is defined as a potential source of drinking water
- Confirmation of in-situ processes that result in transformation of the chemicals of concern to non-toxic byproducts (e.g., by using CSIA or MBTs) and estimates of the rate of transformation

- Alternative and often more meaningful metrics for performance assessment (e.g., mass flux-mass discharge)

Application of these diagnostic tools generally requires additional investment beyond that necessary for conventional characterization and performance assessment tools. Thus, a significant challenge is determining the value proposition for the use of these tools. A brief review of the value-of-information problem will provide some insight applicable to determining when the innovative tools evaluated in this project should be implemented at chlorinated solvent-contaminated sites.

## 8.2. Bases for Selection of Innovative Diagnostic Tools

One of the most significant challenges in the cleanup of chlorinated solvent-contaminated sites is determining whether the degree of uncertainty in the values of relevant physical, chemical, and/or biological parameters is sufficiently small such that decision-makers are reasonably confident of making remediation and/or site closure decisions based on site data. During most phases of the remedial process, including the decision points mentioned above, decision-making under uncertainty is a dominant theme. There is a rich and detailed body of literature on this topic, a review of which is beyond the scope of this report. Nonetheless, determining whether additional information is needed to enhance the quality of site decisions is a primary function of site stakeholders. In simple terms, one must decide whether the expense of using alternative diagnostic tools provides sufficient value to warrant their use. This is a classic “Value of Information” (VOI) problem within the context of decision-making under uncertainty.

A VOI analysis is relevant to many societal issues other than subsurface hydrogeology and remediation. A recent review of the VOI literature (Yokota and Thompson, 2004) indicates that this perspective has been applied to a wide variety of sectors including general medical care, clinical trials, general environmental health, toxicology, and risk assessment – as well as water contamination. According to these authors, “*Value-of-information analysis extends decision analysis to evaluate the benefits of collecting additional information to reduce or eliminate uncertainty in a specific decision-making context*” (Yokota and Thompson, 2004, p. 287).

Conceptually, VOI analysis is described in economic terms, requiring an analysis of the impact of additional information on the expected value of the decision. The decision-maker(s) must compare the expected value of a decision made with the imperfect (uncertain) information at hand to the expected value of the decision with the new information to be gathered. Over the past few decades, numerous publications have attempted to develop algorithms that would provide a basis to conduct a quantitative VOI analysis regarding hydrogeologic data as it applies to risk-based remedial action decisions (see e.g., Massman and Freeze, 1987; Reichard and Evans, 1989; Freeze et al., 1992; James and Freeze, 1993; Back, Rosen, and Norberg, 2007; James and Gorelick, 1994; Russell and Rabideau, 2000; Cardiff et al., 2010). These algorithms are data-intensive, and usually require estimates of the probability distribution function for all parameters in the algorithm.

Freeze et al. (1992) provide a conceptually clear example of assessing the VOI or worth of additional data. These authors introduce an objective function of the form

$$\Phi = \sum_{t=1}^T \frac{1}{(1+i)^t} [B(t) - C(t) - R(t)]$$

Where

- B(t) = Benefits obtained from a given remedial decision over time (e.g., restoration of groundwater, reclamation of contaminated land, avoidance of punitive fines)
- C(t) = Costs over time (capital and operation costs, or costs of additional site characterization)
- R(t) = Monetized costs due to risks of an incorrect decision
- i = Discount rate

This objective function must then be estimated for the scenarios of interest. These scenarios would incorporate various levels of uncertainty in key parameters or variables of interest (e.g., hydraulic conductivity or mass flux), with the uncertainty in the estimated value potentially decreased by additional site data at additional cost.

These types of analyses, while conceptually appealing, are severely limited in the context of site remediation because of the extent of uncertainty in multiple attributes of the problem. As thought experiments, they provide value in defining which uncertainties are most critical to the decision process. However, for practical purposes, the decision to obtain additional site information to reduce uncertainties is usually based on professional judgment.

A qualitative VOI analysis can be applied to selection of innovative diagnostic tools relying on various specific or relative attributes of the tools themselves and their applicability to a site-specific issue. Some of these attributes include the following:

- **Maturity of the Tool:** A diagnostic tool is similar to any new technology that must pass through a maturation process, including proof of concept, field testing, and finally, commercialization. The innovative tools tested in this project are generally commercially available, have had varying degrees of field testing and evaluation, but are not yet widely or routinely used.
- **Applicability to Site Characteristics:** Some diagnostic tools are only suitable for certain site geologic conditions. For example, rock coring is only appropriate for consolidated media.
- **Applicability to Specific In-Situ Technology:** Certain diagnostic tools are only applicable to a specific technology. For example, molecular biological tools are only appropriate for in-situ processes relying on microbial transformations, such as enhanced reductive dechlorination (ERD).
- **Implementation at the Site of Interest:** The ease of implementation of a diagnostic tool at a particular site is also a relevant criterion for selection. Physical constraints at a site (e.g., above-ground structures) may limit the applicability of a given tool. Complex operating requirements and associated components of a tool may also limit its usefulness.

- **Detection Limits, Accuracy, and Precision of the Tool:** Sufficient field data should be available to determine if the diagnostic tool provides detection limits relevant to the chemicals of concern, and that the reported values of the data produced through use of the tool are of sufficient accuracy and precision to improve decision-making. This issue is susceptible to statistical analysis, but ultimately, professional judgment is required because of site complexities, diverse hydrogeochemical environments, and the likely limited amount of field data available.
- **Uniqueness of Data Gathered by the Tool:** If a diagnostic tool provides unique data that cannot be obtained using other methods, that tool has essentially a “competitive” advantage compared to other techniques. In this case, the value of the information must be considered in the context of the remedial process decision. For example, CSIA analyses can demonstrate that chemicals of concern are being transformed by in-situ processes as opposed to being diluted or displaced. Thus, these are unique analyses, and may be essential to support of the use of a particular technology, or a decision to transition to passive remediation, e.g., natural attenuation. CSIA, rock matrix characterization, and MBT diagnostic tools all provide unique data that cannot be obtained by other methods. The use of multi-level monitoring devices also provides unique data providing a vertical profile of concentrations of the chemicals of concern (e.g., see Einarson, 2006).
- **Cost Relative to Similar Methods:** A final criterion for selection of these tools is the relative cost of application of the diagnostic tool compared to alternative or conventional techniques or other tools that can provide equivalent information. This criterion is only applicable if there are competing methods for obtaining the same data. Three of the five diagnostic tools evaluated in this project provide unique data that cannot be provided by other techniques, as noted above. Two of the tools, mass flux/mass discharge measurement methods and multi-level monitoring systems, can be compared on a cost basis. In this project, four methods for determining mass flux and mass discharge emanating from a source zone were compared. In addition, five different groundwater sampling methods were compared, at one of the sites. In these cases, a comparative cost analysis provides an indication of relative costs, assuming that the other attributes of the methods are comparable.

The utility of diagnostic tools for satisfying regulatory requirements depends upon regulatory acceptance of the tool. Regulatory acceptance was addressed in previous sections for the five diagnostic tools of this study. The degree of regulatory acceptance varies but will likely increase as tools are demonstrated to provide value and as entities such as ITRC provide education on diagnostic tools directly to the community of regulators and practitioners.

In the remainder of this section, the applicability of each of the five diagnostic tools to characterize and assess performance of in-situ technologies at chlorinated solvent sites will be evaluated qualitatively using the above criteria to assess the VOI obtained by their use.

### 8.3. Multi-Level Monitoring Systems

Multi-level monitoring systems (MLM systems) are designed to collect depth-discrete samples or measurements over a single vertical profile of the subsurface, in contrast to conventional



groundwater monitoring, which generates data that represents a vertically averaged measurement from each well. MLM systems provide a better understanding of the vertical distribution of contaminants as well as the changes in concentration with depth within the contaminant plume compared to conventional monitoring.

The multi-level and nested well monitoring systems used to monitor the vertical distribution of contaminants discussed in this report include: (a) Solinst CMT<sup>®</sup> (Continuous Multichannel Tubing), (b) Solinst Waterloo system, (c) Westbay system, (d) the Groundwater FLUTE (a trademark name for Flexible Liner Underground Technologies), and (e) ZIST<sup>™</sup> (Zone Isolation Sampling Technology by BESST, Inc., a nested well system). These systems were described in detail in Section 5.1. In addition, Einarson (2006) provides an overview encompassing all types of MLM systems and well nests and clusters used in North America.

### **8.3.1. Field Results**

During this study, the MLM systems discussed above were compared to conventional groundwater well clusters in both unconsolidated saturated zones during bioremediation (at Fort Lewis) and consolidated saturated zones during in-situ chemical oxidation with permanganate (at Watervliet Arsenal).

#### **Fort Lewis**

At Fort Lewis, a relatively shallow contaminant treatment zone (approximately 10-30 ft bgs) allowed the use of CMT<sup>®</sup> monitoring wells, which are generally a less expensive option than installing separate vertically discrete monitoring wells at varying depths. This MLM system provided critical information in understanding heterogeneity in the hydraulic system including the presence of vertical gradients and preferential flow paths. In addition, the data provided by the system were helpful for optimizing the injection design to effectively encompass target horizontal and vertical contaminant treatment areas. This resulted in degradation of TCE in the areas receiving whey, which was the injected bioremediation substrate at this particular site. MLM also allowed for the evaluation of variability in contaminant mass vertically within the treatment areas, and to assess response to treatment to determine mass transfer effects. Below is an evaluation of the effectiveness of the CMT system for various targeted uses at Fort Lewis.

- **Subsurface heterogeneity:** At Fort Lewis, MLM was required to characterize specific parameters in three-dimensional space, such as hydraulic conductivity, influence of vertical gradients, and designation of preferential flow paths. Successful design of an effective injection strategy would have been much more difficult, and costly, without this information.
- **Distribution of whey:** MLM demonstrated effective horizontal and vertical distribution of whey throughout the target area.
- **Evaluation of geochemical impacts:** MLM was unnecessary for evaluating geochemical impacts at Fort Lewis. There was little difference in geochemical parameters, such as pH and methane concentrations, measured in groundwater within the different depth intervals. Therefore, two-dimensional sampling within the treatment area would have been sufficient to evaluate significant changes in geochemistry at this site. This may not be the case, however, for other field sites,

especially sites that may have more significant variability in geochemistry with depth (i.e., sites with a much larger vertical heterogeneity and potentially multiple contaminant zones).

- **Contaminant distribution and fate:** MLM was useful for evaluating variability of contaminant and degradation by-product concentrations spatially within the treatment cells. MLM was very useful for assessing enhanced mass transfer due to bioremediation, which was assessed using a molar mass balance in contaminant and reductive by-product concentrations in groundwater over the various operational phases.
- **Contaminant mass flux:** MLM was used to evaluate contaminant mass flux within the treatment cells. However, because a constant groundwater velocity over time was assumed and the groundwater velocity at Fort Lewis was highly variable, the accuracy of the mass flux measurements was uncertain.

### **Watervliet Arsenal**

At Watervliet Arsenal, all four MLM systems and the nest well systems were used for vertical profiling. The spatial arrangement of the various boreholes and the sequence of uses of the different MLM systems were not selected to accommodate rigorous comparisons of advantages/disadvantages or performance between the systems. However, the field evaluation at Watervliet did result in findings regarding system performance for key performance criteria, selected results of which are summarized in Table 8-1.

**Table 8-1. Performance Evaluation of Multiple Multi-Level Monitoring Systems at Watervliet Arsenal**

<b>Criterion</b>	<b>Performance of MLM Systems and Nested Wells</b>
Multiple uses	All of the systems were used for hydraulic head measurements and groundwater sampling, but only the Westbay was utilized for hydraulic testing. The ZIST system also has the capability to be used for hydraulic testing. The Westbay system was also utilized for injection of permanganate.
Ease of installation	Installation difficulties can arise because of borehole irregularities, MLM system construction requirements or bridging of well backfill materials. The Westbay system is least prone to installation difficulties because it can be installed inside a temporary casing, if necessary, and does not require backfill of the borehole annulus. Difficulties were encountered during the installation of the CMT system at Watervliet due to bridging of the well backfill materials in the boreholes. However, this problem was overcome in the subsequent installation of nested wells by changing the backfill materials and the rate/method by which they were emplaced in the boreholes.
Ease of operation	Each of the MLM systems and nested well systems included in this demonstration increased the efficiency of collecting groundwater samples by having multiple monitoring zones in one borehole, reducing the time to set up and take down sampling equipment, as compared to monitoring well clusters. At the Watervliet Arsenal, 45 groundwater samples were collected from five FLUTE systems in one day by a team of two people.
Suitability for permanganate injections	The rock core chlorinated solvent analysis showed that much of the contaminant mass was located in lower permeability zones at Watervliet. The Westbay systems were used at the Watervliet Arsenal to target these lower permeability zones for treatment; they were the only MLM system capable of injecting treatment solutions at useful rates into multiple low-conductivity intervals in the same borehole. Permanganate was injected through two of the six Westbay systems installed at the site.
Durability when exposed to permanganate	<p>This project was the first where several types of groundwater monitoring devices were exposed to permanganate. The FLUTE systems were removed after permanganate was detected in the boreholes. One of the FLUTES disintegrated in the borehole during removal due to damage caused by the permanganate. The project team was aware before the installation of the FLUTES that they were not compatible with permanganate, and, therefore, they were installed with temporary monitoring as the objective. Following this field observation, new materials for FLUTE systems were investigated to better withstand exposure to permanganate.</p> <p>The Westbay systems were expected to withstand the permanganate effects, as the materials used to construct the system are compatible with permanganate. However, over time, all of the ports in the Westbay wells used for permanganate injections became inoperative, likely due to the formation of precipitates that clogged the ports and prevented either the attachment/sealing of the sampling tool and/or the movement of the pumping port cover. The Westbay systems not utilized for injection of permanganate remained operative throughout the project.</p> <p>Neither the CMT nor nested well systems showed signs of deterioration in the presence of permanganate.</p>
Installation cost	As configured for the Watervliet Arsenal, the MLM system with the lowest purchase and installation cost was the CMT system.

### 8.3.2. *Attributes for Selection*

MLM systems are **mature** tools that are **commercially available** and have been used widely. Each MLM system evaluated during this ESTCP project has been used in numerous investigations of sites distributed across North America, and some of the systems have been used on other continents. There is substantial reporting on the uses of MLM systems in site characterization reports and conference proceedings.

MLM systems are **applicable** to both consolidated and unconsolidated geologies. Due to the materials used in their construction, some MLM systems may be **incompatible** with certain remedial technologies (e.g., chemical oxidants or high temperatures).

MLM systems are generally **implementable** (and have been implemented at many sites), but do often require specialized knowledge during installation and initial rounds of sampling. For example, the use of a trained, on-site technician is recommended for installation of the Westbay, FLUTE, and ZIST systems. At Watervliet Arsenal, the Westbay system required a two-person team to efficiently operate and decontaminate the down-hole equipment necessary for sampling, and maintenance of the down-hole equipment (wireline repairs) was required to keep it in proper working condition. As noted above, installation difficulties can arise because of borehole irregularities, MLM system construction requirements, or bridging of well backfill materials. Non-ideal borehole conditions may prevent the MLM system from reaching the bottom of the borehole. The Westbay system is least prone to installation difficulties of the MLM systems used at Watervliet Arsenal because it can be installed inside a temporary casing, if necessary, and does not require backfill of the borehole annulus. Nested well systems can also be installed using a temporary well casing.

MLM systems provide more **precise** data in three-dimensional space than conventional two-dimensional groundwater monitoring. System storage volume and the potential for sample bias are important factors influencing the **accuracy** of contaminant concentrations obtained using MLM systems or nested wells. Purging the system storage volume and sampling can cause differences between what is measured and the actual formation concentration. The Westbay system has essentially no internal storage volume, such that it is a "no-purge" system. After the Westbay pumping port is used to purge the monitoring zones after installation, no further purging is required. The FLUTE system has minimal annulus storage volume, which means that as soon as the internal system volume is purged, the sample can be collected with no substantial additional purging. The Waterloo, CMT, and nested well systems have volume in the tubing between the port and the surface, and, therefore, more extensive purging is generally required.

Sample bias refers to the influences on the contaminant concentrations during sampling and analysis that cause the measured concentrations to be different than the true concentrations in the formation immediately beyond the sampling interval. Many factors can cause sample bias, such as reaction with the MLM system materials (e.g., sorption or leaching), volatilization losses, and formation mixing. Of the four MLM systems evaluated as part of this ESTCP project, the Westbay system has the least propensity for biases of chlorinated solvent results because the groundwater sample is collected down-hole in a canister made of glass or steel without headspace, although subsequent transfer from the canister to sampling bottles at surface may create similar bias as the other systems..

The use of MLM systems provides **unique** data regarding hydrogeologic properties and contaminant distribution that cannot be obtained by other methods.

Comparison of **costs** among MLM systems/nested well systems is complex given each system has distinct advantages in different settings and can serve different purposes. The costs for each system for an example site setting were provided in Section 3.2 for the sake of comparison. The use of MLM systems will increase cost compared to conventional groundwater monitoring systems, but they provide unique data that cannot be obtained conventionally. Also, their use can result in cost savings during in-situ treatment due to optimization of injection strategies to target vertical intervals not being fully treated and to target areas within the source zone with the greatest mass. The optimization can result in greater mass removal rates, shorter remedial timeframes, and lower overall life-cycle costs than would be achieved without the use of MLM systems.

### **8.3.3. Recommendations**

The use of MLM systems can provide information relevant to multiple steps in the remedial process, including site investigation, remedial system design and performance assessment, system optimization, and long-term monitoring, as shown in Table 8-6. Recommendations for the appropriate and valuable application of MLM system measurements include the following:

**Recommendation #1: Use MLM systems for vertical delineation of hydrogeologic properties and contaminant concentrations at all sites, due to the inherent heterogeneity present in the subsurface, even in Type I hydrogeologic settings.**

The utility of the MLM system results at the two field sites evaluated as part of this project support their implementation and long-term use at most sites impacted with chlorinated solvents. At both Watervliet Arsenal and Fort Lewis, the use of MLM systems improved the CSM, specifically by identifying “hot spots” of contamination. The systems enable the determination of the vertical distribution in hydrogeologic properties and contaminant concentrations, and these data are needed at nearly all chlorinated solvents sites for multiple purposes, including the following:

- Assessment of spatial variability of plume concentrations
- Determination of vertical characteristics of treatment areas, including hydraulic, contaminant, and geochemical parameters
- Monitoring of vertical distribution of subsurface amendments relative to contaminants
- Identification of areas of predominant contaminant transport, and improvement in mass flux/mass discharge estimates
- Concentration of remedial efforts on the high-contaminant-mass areas of sites, as defined both horizontally and vertically

The use of MLM systems requires the collection of numerous samples at any single well location and analysis of samples at additional cost. However, the information provided by MLM systems cannot be easily obtained using conventional monitoring wells unless well clusters are used.

Without vertical profiles of contaminant concentrations, serious errors in design of remediation systems may occur, with the result of increased annual costs, and ultimately, higher life-cycle costs. Qualitatively, the value of the data from these devices exceeds the added cost in most geologic settings, and is likely essential for optimum decision-making at the majority of sites.

**Recommendation #2: Balance relevant criteria for the selection of the most appropriate MLM system for a given site.**

Given that there are so many ways in which the MLM system and nested well systems differ from one another, and that individual sites will have different monitoring objectives, geology/hydrogeology, and regulatory requirements, the task of selecting the MLM system or nested well system most appropriate for the particular sites needs is site-specific. There are many criteria that can be used for selection of a MLM system. At most sites, there are multiple uses of the MLM system, and selection of the most appropriate MLM system involves a balance between the various criteria. Relevant criteria include the following, some of which are discussed above and others of which are discussed further in Malcolm Pirnie and University of Waterloo, 2010:

- Borehole diameter
- Maximum depth
- Multiple uses
- Removability
- Ease of installation
- Nature of seal between monitoring intervals
- System storage volume
- Maximum purge/pumping rate
- Potential for sample bias
- Ease of operation
- Durability when exposed to subsurface amendments (e.g., oxidants)
- Durability during normal use
- Suitability for fluids injections
- Cost

#### **8.4. Rock Matrix Characterization**

Section 4.0 of this report addressed rock matrix characterization, which measures chlorinated solvent mass in rock samples, including rock matrix pore water. Rock matrix characterization is a diagnostic tool for use in consolidated geologic environments (i.e., Type IV and V hydrogeologic settings), with an emphasis on elucidating the internal structure of contaminant plumes including contaminant distribution in the rock matrix where groundwater is nearly

immobile due to low permeability. The method protocol therefore includes collection of samples at high density (approximately one sample per foot of core), including at fractures (i.e., one of the fracture faces) and bedding planes, at lithologic changes, and from matrix blocks between fractures. The technique involves collecting small rock core samples with depth, crushing the rock, and then extracting chlorinated solvents from the rock matrix with methanol for subsequent laboratory measurement. For rock matrix samples, the analysis yields equivalent pore water contaminant concentration.

#### **8.4.1. Field Results**

At the Watervliet Arsenal, the geologic environment consists of shale bedrock (Type IV geology). Continuous bedrock cores were collected in five-foot intervals from the competent bedrock surface to the final depth of the well from five monitoring well boreholes (Goldstein et al., 2004). Samples from these cores were collected and analyzed using the characterization approach described above and in Section 4.0.

In one example borehole, although the flow zones identified by the borehole geophysical testing correlated to elevated rock matrix chlorinated solvent concentrations at two depths, they did not account for a large vertical span of elevated rock matrix chlorinated solvent contamination from approximately 50 to 110 feet bgs, where, in many cases, PCE concentrations approached solubility. These data support the conclusion that numerous fracture pathways existed that were not detectable using conventional geophysical techniques. In the same borehole, although the zone between approximately 50 to 110 feet bgs contained rock matrix chlorinated solvent concentrations approaching solubility, groundwater chlorinated solvent concentrations in this zone were only approximately 10 percent of the rock matrix pore water concentrations, indicating that the rock matrix and fracture groundwater were not in equilibrium.

The results from Watervliet Arsenal provided unique insights regarding the distribution of chlorinated solvent mass and support the value of rock coring and analyses for improving the characterization of chlorinated solvent distribution in fractured rock environments.

#### **8.4.2. Attributes for Selection**

The rock matrix characterization technique is a **mature, commercial** tool, and has recently been trademarked under the trade name of COREDFN™ (Characterization of Rock Environments – Discrete Fracture Network Approach). It is commercially licensed to Stone Environmental, Inc. of Montpelier, Vermont.

The rock matrix characterization technology is **applicable** to any site where **bedrock** groundwater has become contaminated with organic compounds, particularly CVOCs. However, it has been shown to be most valuable in geologic settings consisting of sedimentary rock, such as sandstone, shale, and siltstone, where matrix porosity is appreciable (generally 1-20% range).

Rock matrix characterization is not specific to a particular remedial technology. The technology is **applicable** for evaluation of the efficacy of in-situ remedial technologies such as chemical oxidation, bioremediation, and thermal treatment.

This technique is **implementable**, but involves significant time and effort because it requires drilling rock cores and detailed sampling and analyses of the core samples.

The **detection limits, accuracy, and precision** of rock matrix characterization have been found sufficient for analysis of chlorinated solvents in fractured rock. The method of direct, on-column measurement of chlorinated solvents in methanol (used to extract the chlorinated solvents from the rock) has been tailored by the University of Waterloo to achieve low detection limits (e.g., 0.1 µg/L for TCE and PCE).

Rock matrix characterization provides **unique** data that cannot be obtained by other methods.

The criterion of **comparative cost** is not applicable because there are no competing methods for obtaining the same data. Based on project costs for investigations conducted in the last five years, the typical cost is in the range of \$150 to \$170 per linear foot of core analyzed (assuming that one sample is collected per foot of core), not including drilling costs, which vary greatly.

### **8.4.3. Recommendations**

**Recommendation: Use of rock matrix characterization should be evaluated at all chlorinated solvent sites in consolidated media using appropriate value of information factors.**

Rock core analyses provide contaminant mass and phase distributions more relevant to the characterization of contaminant behavior than those obtained from monitoring wells or other types of borehole water sampling alone. Conventional hydraulic characterization methods for chlorinated solvents in fractured bedrock environments involves open boreholes, which allows for cross-connection between fractures in different sections of the hole and yields results that are not representative of the natural system. Conventional groundwater characterization in fractured bedrock environments involves only sampling water from fractures. Field studies using the rock matrix characterization method show contaminant mass storage is dominated by the rock matrix rather than the fractures and contaminant concentrations in the fractures and the matrix are not in equilibrium. Therefore, the rock matrix must be sampled to provide the overall mass distribution and to effectively characterize contaminant transport. Rock matrix characterization can be used to determine contaminant mass and distribution in the rock matrix and to identify hydraulically active fractures carrying contaminants.

Rock matrix characterization results have been used for the following applications:

- Optimization of placement of multi-level groundwater monitoring systems
- Chlorinated solvent mass “tracking” to identify potential advective plume migration pathways
- Contaminant mass discharge assessments
- Remedial action planning
- Evaluation of remedy effectiveness (including elucidating the extent of mass destruction during remediation)



- Documentation of TI evaluations and designation of TI zones

Data from field testing of this diagnostic tool at the Watervliet Arsenal confirmed that rock crushing and analysis is an invaluable tool in characterizing contaminated fractured bedrock sites. As noted above, this tool entails the drilling, sample collection and processing, and sample laboratory analyses, which add expense to conventional investigation and monitoring programs but provide unique information that cannot be obtained with other methods. Because of the potentially high costs of this diagnostic tool, a careful value of information analysis is needed to determine the suitability of this tool at a specific site. In the past, such testing has been essential in formulating CSMs that clearly demonstrated the limitations to efficient mass removal from fractured rock subsurface environments. However, with increased knowledge regarding the distribution of contaminants in such settings, the difficulty of mass removal is better understood. This fact may limit the need for the use of this technology at some sites.

## **8.5. Mass Flux Measurement**

Mass flux/mass discharge is a measurement of the mass of contaminants passing through a defined cross-sectional area over time. It can be used to assess the potential risks of site contaminants to downgradient receptors such as water supply wells or surface water bodies, and perhaps even prioritize sites for remediation. As an integrated measurement of source zone or plume strength, mass discharge can be a key performance metric for evaluating MNA or in-situ treatment. Local mass flux measurements can also guide remedial progress, ensuring that sufficient amendments are delivered to high-flux zones. There are several different methods for measuring mass flux/mass discharge, including synoptic sampling (transect method), steady-state pumping, passive flux meters (PFMs), recirculation flux measurement (RFM), integrated pumping tests (IPTs) and modified integrated pumping tests (MIPTs). Each was described in more detail in Section 5.1.

### **8.5.1. Field Results – Mass Flux Measurement**

A recent ITRC report (ITRC, 2010b) documented mass flux/mass discharge measurements from 65 sites, illustrating that it is being used more frequently. For this ESTCP project, as noted in this report, the field study at Vandenberg AFB, California compared different methods for measuring mass flux/mass discharge (Malcolm Pirnie et al., 2010). At Fort Lewis, Washington, mass flux was used as a diagnostic tool for assessing in-situ bioremediation (North Wind, 2010). At Watervliet Arsenal, mass flux was used as a performance metric for assessing in-situ chemical oxidation (Malcolm Pirnie and University of Waterloo, 2010). Key findings from these field studies are summarized below.

#### **Vandenberg AFB**

Four different mass flux/mass discharge measurement tools were tested at Site 60, Vandenberg AFB. Synoptic sampling of monitoring well transects (Method 1) was found to be accurate and relatively precise, particularly during the period of time when mass discharge was high (Malcolm Pirnie et al., 2010). The deployment of PFMs in a transect of wells (Method 3) was also found to be relatively accurate, though positively biased high (i.e., overestimating mass flux) in both of the successful applications compared with synoptic sampling. However, more than two applications would be needed to properly assess this method. Steady-state pumping (Method 2)

significantly underestimated mass flux in this demonstration due to an incorrect early assumption about the hydraulic properties of the aquifer. However, the method would have been quite accurate and precise if site knowledge had been better initially or if the test had been conducted in a step-wise fashion to identify the ideal extraction rate.

Results from Site 60 are site-specific. However, the site provided an ideal research environment, with relatively homogeneous soils, high permeability, and well-defined aquifer thickness and hydraulic properties. The advanced level of prior site characterization made it fairly easy to measure mass flux/mass discharge. Dense arrays of monitoring wells (2.5 feet apart or less) were installed along several transects positioned along the groundwater flow path. An artificially-produced bromide plume provided prior knowledge of the actual subsurface “contaminant” mass. These factors improved the accuracy of the calculated mass flux/mass discharge values and decreased the costs.

Results under more typical conditions were evaluated using sensitivity analyses. These illustrated that the accuracy and precision of synoptic sampling and PFMs depended on the well spacing and transect location with respect to the plume(s). Precision was good when the inter-well spacing was less than the widths of the high-concentration portions of the target plume; precision became poor when the interwell spacing was greater than the sub-plume width (Malcolm Pirnie et al., 2010).

### **Fort Lewis**

Mass flux measurements were also conducted at Fort Lewis, Washington, where in-situ biodegradation was being used to increase the mass transfer rate of contaminants from DNAPL into the dissolved phase. Mass flux was used to assess the increase in mass transfer due to implementation of in-situ bioremediation using cheese whey as the electron donor (North Wind, 2010).

Mass flux was measured using synoptic sampling and PFMs. Both methods demonstrated that contaminant flux increased during biostimulation compared with pre-injection baseline values. However, groundwater flow velocities were highly variable at the site, leading to high uncertainty in mass flux calculations, which assumed a constant horizontal groundwater velocity (North Wind, 2010). PFMs were expected to provide more accurate data in this case, as they measure flow-weighted contaminant mass. However, PFMs recorded increases in mass flux that corresponded to increases in groundwater velocity, making it difficult to separate the effects of flow variation from increased mass transfer due to biostimulation.

### **Watervliet Arsenal**

In-situ chemical oxidation using permanganate was conducted at a DNAPL source area in a fractured rock environment at Watervliet Arsenal. Changes in mass flux at the property boundary over a five-year treatment period were used to assess the benefits of active source treatment. Two mass flux measurement methods were used: synoptic sampling along a well transect and the IPT method. Both methods indicated that mass discharge did not significantly decrease as a result of permanganate application. In fact, mass flux estimates increased as a result of permanganate injections, perhaps due to a decrease in aquifer’s hydraulic conductivity as a result of testing.

Mass flux measurements helped the Army document the limitations of ISCO at the site and inform the selection of a final remedial approach.

When comparing the two methods of mass flux measurement, IPT method may have overestimated mass flux, raising questions as to this method's applicability in a fractured rock environment (Malcolm Pirnie and University of Waterloo, 2010). The baseline mass flux was estimated to be 100 lbs/year using the IPT method, an order of magnitude greater than the estimate of ~10 lbs/year using the synoptic sampling method. IPT results were not credible based on site history and the scale of operations conducted at the site. Researchers surmised that the IPT method overestimated mass flux in the fractured environment because highly-contaminated water was drawn out from lower transmissivity zones and dead-end fractures during active pumping. IPT is not commonly used at fractured rock sites; results may vary depending on the interconnectedness of fractures, pumping rate, and proximity of the well to source areas (Malcolm Pirnie and University of Waterloo, 2010).

### **8.5.2. Attributes for Selection**

Mass flux/mass discharge measurement is **maturing** as a diagnostic tool. Formal attention from state regulators and other ITRC members as well as implementation at a number of sites (65 case studies cited in ITRC, 2010b) indicates that these methods are gaining more widespread acceptance. The most common methods being used include synoptic point sampling (9 sites), PFM's (5 sites), and IPT tests (2 sites). In addition, mass flux has been designated as a performance metric in a ROD for at least one site (USEPA, 2009a). Confidence and acceptance in mass flux/mass discharge measurement methods will likely grow among the environmental remediation community as other studies are conducted.

When considering the value of mass flux/mass discharge measurement at a site, one must take into account **site characteristics**, including the geologic setting, depth to groundwater, stability of groundwater flow, and previous site characterization. The efficacy of pumping techniques for mass flux/mass discharge measurement is likely limited in aquifers with low transmissivities and fractured rock environments. Sites with a shallow depth to groundwater are easier to characterize. Dewatering may be a concern if pumping techniques are used for mass flux measurement at sites with narrow, low-yield aquifers. Groundwater flow should be fairly stable in magnitude and direction, so that flowlines are perpendicular to mass flux transects. Previous site characterization (e.g., knowledge of the plume extent, flow pathways, detailed understanding of site geology, geochemistry) facilitates the use of mass flux measurement methods and decreases the cost of implementation.

Mass flux/mass discharge measurements are **not technology-specific**. They can be used in conjunction with all types of in-situ technologies as well as pump-and-treat systems. There is also value in measuring mass flux/mass discharge prior to selecting a remedial technology. Finally, mass flux/mass discharge measurements can be conducted at sites regardless of whether NAPL is present (i.e., downgradient of a NAPL source zone) or not.

The **ease of implementation** of mass flux/mass discharge measurement methods depends on site characteristics and the level of prior site characterization. Implementation may be impeded by incomplete understanding of horizontal and vertical flow gradients, variability in groundwater flowrate and direction, or incomplete definition of stratigraphy. Shifts in groundwater flow

direction can cause significant errors in mass flux/mass discharge measurements using any of the methods described in this report. Sites with shifting flow fields will need relatively dense monitoring networks for accurate data collection. In addition, variations in the magnitude of mass flux/mass discharge may result from sorption/desorption and changes in biodegradation due to enhanced mixing.

One question is whether the available mass flux/mass discharge measurement methods produce data of **sufficient accuracy and precision** to improve site decision-making (ESTCP, 2010). Factors that **improve the accuracy** of the calculated mass flux/mass discharge values include having a robust CSM of the subsurface geology and hydrogeology, well-defined aquifer thickness and hydraulic properties, and focused measurements along several transects positioned along the flow path. Use of multiple measurement methods enables regulators and project managers to validate or bound the uncertainty of a mass flux/mass discharge result (ESTCP, 2010). Field tests have indicated significant uncertainties in mass flux/mass discharge calculations using PFMs due to variations in the device's sampling zone, which is strongly affected by monitoring well construction.

Mass flux/mass discharge can be measured using data that are typically collected at a site (e.g., contaminant concentrations, hydraulic conductivity values, gradient measurements, pumping rates). Measurements of mass flux/mass discharge can provide another set of data or evaluation technique for assessing remedial performance. In this sense, they are **unique** tools.

Absolute and relative **costs** of mass flux/mass discharge measurements are site-specific, and depend on factors such as the degree of heterogeneity in geologic characteristics and nature and extent of the groundwater contamination. Depth of the plume has a direct impact on cost. Cost considerations for different mass flux/mass discharge measurement methods were previously described in Section 5.2.4 of this report. Despite the potential increase in site characterization costs, the information provided with this technology can provide significant cost savings in the future if the length of time that a remedy operates can be reduced, thus reducing monitoring costs and therefore life-cycle costs.

### **8.5.3. Recommendations**

Mass flux/mass discharge measurements improve site remedial decision-making by providing a way to quantitatively evaluate the strength of a source or plume at a given time and location. As shown in Table 8-6, this tool can be used at different stages of the cleanup process, from site characterization and CSM development to achieving long-term monitoring (LTM) or No Further Action (NFA) status. Recommendations for the appropriate application of mass flux/mass discharge measurements include the following:

**Recommendation #1: Mass flux/discharge should be calculated at all contaminated sites because it can be used to improve remedial decisions made at all decision points during the cleanup process.**

In aquifers with consolidated media, pre-characterizing plumes along transects can be accomplished using low-cost DP tools such as membrane interface probes, Waterloo Profiler, or others. Mass discharge quantifies the strength of sources causing dissolved plumes and this variable should be calculated at all contaminated sites. Although it is typically thought of as a

tool for evaluating source treatment technologies, mass flux/mass discharge can be useful for a variety of different cleanup decisions, including the following (ITRC, 2010b):

- *Site characterization/CSM development:* Mass flux/mass discharge measurements can provide a clearer perspective on the strength and average impact of site contamination or contamination from different source zones, unlike traditional two-dimensional measurements using groundwater samples from monitoring wells. Mass flux/mass discharge measurements collected from different locations or at different times can be used to gauge source age and the impact of natural attenuation processes.
- *Evaluation of the site as a threat to downgradient receptors or exposure assessment:* Mass discharge is a measurement of the rate that dissolved contaminants are flowing in an aquifer. Consequently, it can be measured downgradient from a NAPL source zone and used in risk assessments as an average mass of contaminants over time to which downgradient receptors could be exposed.
- *Establishment of remedial action objectives and performance expectations:* Mass flux/mass discharge measurements have been used as a metric for remedy performance (USEPA, 2009a). A decrease in mass flux/mass discharge below a threshold value can be used as an indicator of technology performance, i.e., achievement of a short-term remedial objective.
- *Remedial technology selection and design:* Mass flux/mass discharge measurements are not technology-specific and therefore can be used to assess a variety of different remedies. Mass flux/mass discharge measurements can be used to guide remedy design, e.g., identifying areas of the site where in-situ remediation will provide the most benefit.
- *Performance monitoring and optimization:* Mass flux/mass discharge measurements can provide a meaningful way to identify contaminant trends and their implications, express average concentration reductions across a plume, calculate attenuation rates and, in some cases, support conclusions regarding treatment efficacy.
- *Long-term monitoring and compliance:* At sites where mass flux/mass discharge is established as a remedial objective, mass flux/mass discharge measurements can be used to gauge compliance, progress toward meeting remedial objectives, and transition to site closure.
- *Prioritization of sites based on source/plume strength:* As a measure of source strength, mass flux/mass discharge measurements can be used to prioritize sites for remedial action within a cleanup program or facility.

Because mass flux/mass discharge measurements can be used at multiple stages of the site remediation process, sites that adopt mass flux/mass discharge as a metric early in the cleanup process will benefit from the comparative analysis of this metric throughout the remediation process.

**Recommendation #2: Consider the site hydrogeologic setting when selecting the mass flux/mass discharge measurement method.**

Site hydrogeology is an important factor determining the value of mass flux/mass discharge measurements. Table 8-2 summarizes the applicability of each method in different hydrogeologic settings (described as Types I through V in a study of source zone remediation technologies (NRC, 2005)). All five types of mass flux/mass discharge measurement methods described in this report work best in relatively homogeneous, permeable, granular aquifers (Type I). In fine-grained granular materials (Type II), pumping methods are not as efficient in measuring mass flux/mass discharge because the aquifer material is resistant to flow; therefore, a high density of pumping wells is needed for plume capture.

In highly heterogeneous granular materials (Type III), synoptic point sampling and PFMs are acceptable but may require many sampling points to adequately sample the high mass flux/mass discharge zones. Pre-characterization of the high mass flux/mass discharge zones using DP sensors (as discussed above) allows site investigators to optimize their sampling efforts in highly heterogeneous formations. IPTs (both the original German method and the USEPA MIPT method) are not very accurate in highly heterogeneous formations because method assumptions of geologic homogeneity are not satisfied. SSP methods may be acceptable as long as pumping reaches steady-state and the plume is completely captured.

Synoptic point methods and PFMs may be used in highly and sparsely fractured rock aquifers (Types IV and V). IPTs can perform poorly in sparsely-fractured rock aquifers because the nature of fracture flow violates the method's assumptions. Rock that is highly fractured can be considered an "equivalent porous medium" and IPT methods may be acceptable. RFMs are still in the field testing stage of development and so it is premature to list the applicability of that method in different field geologies.

**Table 8-2. Applicability of Mass Flux Measurement Methods in Various Hydrogeologic Settings**

<b>Hydrogeologic Setting</b>	<b>Synoptic Point Method</b>	<b>PFM</b>	<b>SSP</b>	<b>RPM</b>	<b>IPT/MIPT</b>
Granular, High K (Type I)	Best	Best	Best	Good	Best
Granular, Low K (Type II)	Good	Good	Poor	Not sufficiently tested	Poor
Granular, Highly heterogeneous (Type III)	Good	Good	Good	Not sufficiently tested	Poor
Fractured, Low matrix porosity (Type IV)	Good	Good	Good to poor	Not sufficiently tested	Good to poor
Fractured, High matrix porosity (Type V)	Good	Good	Good to poor	Not sufficiently tested	Good to poor

**Recommendation #3: Follow best practices during field implementation to increase the accuracy, usefulness, and cost-effectiveness of mass flux/mass discharge measurement methods.**

Best practices have been developed based on experience at multiple case studies, including Vandenberg AFB and Fort Lewis, Washington (Section 8.5.1). Regardless of the measurement method, it is necessary to first define the lateral and vertical boundaries of plumes to ensure that the entire mass discharge is being measured. Multiple transects of high-resolution data collection have proven to be very effective methods to quickly define dissolved plumes in three dimensions and create transects for mass flux/mass discharge measurements. Multiple sampling transects oriented perpendicular to the plume axis have been used to provide a much clearer understanding of spatial and temporal trends in concentrations of dissolved solutes than conventional networks of spatially-distributed, single-interval monitoring wells.

**8.6. Compound Specific Isotope Analysis**

Section 6.0 of this report addressed the use of compound specific isotope analysis (CSIA). CSIA is an analytical technique used to generate an isotopic signature or ratio for different compounds. Isotope fractionation makes CSIA a useful technique to distinguish between concentration decreases due to degradative versus nondegradative processes, which is unique information in the assessment of performance of in-situ remedies.

### **8.6.1. Field Results**

CSIA was applied at Fort Lewis and the Watervliet Arsenal to analyze the extent of chlorinated solvent degradation by reductive dehalogenation and by in-situ chemical oxidation, respectively.

#### **Fort Lewis**

During bioremediation at Fort Lewis, CSIA was performed on groundwater samples from selected monitoring wells and demonstrated continued dechlorination of cis-DCE to VC as the isotope ratios of the residual cis-DCE continued to show an increasing trend (Figure 8 1; North Wind, Inc. 2010). Simultaneous with the conversion to VC, dechlorination to ethene was also likely occurring. While no isotope ratio was measured for ethene, an increase in the isotope ratio of VC was observed in three monitoring wells, although the increase was not statistically significant. Enrichment in the VC isotope ratio suggests either that its light isotope carbons were being dechlorinated to form the daughter product ethene, or that more of the “heavier” DCE was being transformed to VC, or a combination of both.

CSIA was useful in evaluating contaminant fate within the system at Fort Lewis, although the monitoring period was not sufficiently long to see the full benefit. Measuring changes in concentration of chlorinated solvents by gas chromatography has historically been the standard in analyzing field samples. However, concentration measurement can be affected by many physical and transport events, making it difficult to attribute concentration changes to contaminant transformation or destruction. At sites where a good mass balance cannot be obtained, this problem is a serious concern. CSIA has the advantage that it is not affected by physical and transport events.

The mass balance for cis-DCE was lost once significant VC and ethene were produced within the test cells. CSIA allowed for the interpretation of the isotopic change of the parent compound TCE (which was at a higher concentration) to infer the transformation patterns of the daughter product DCE. CSIA did not provide information regarding the loss in mass balance once cis-DCE was converted to VC and ethene. Had the monitoring been sustained until more of the DCE was transformed to VC and ethene, it is likely CSIA would have been able to show the mass balance in spite of the fact that groundwater concentrations would not have shown it.



**Figure 8-1. Results of Compound Specific Isotope Analysis at Fort Lewis**

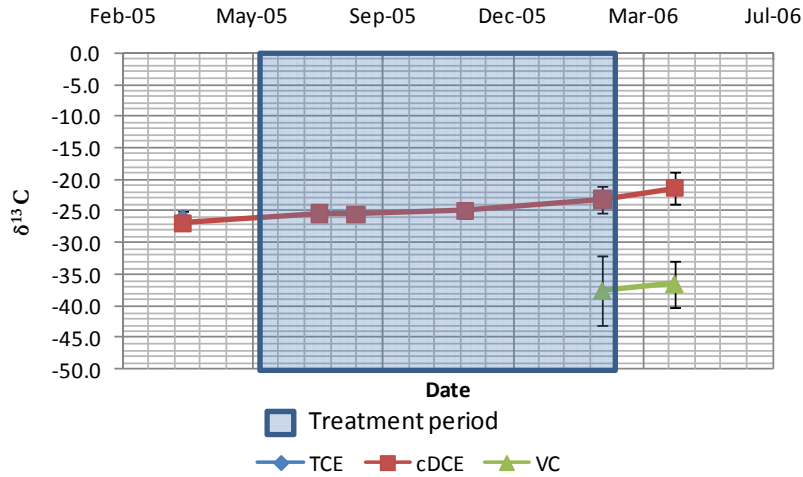

Values Represent the Mean of All Sampling Points (N=16), Except the April 2006 (N=4), Within Two Treatment Cells and Error Bars Represent One Standard Deviation (North Wind, Inc., 2010)

### Watervliet Arsenal

CSIA was performed at the Watervliet Arsenal during a pilot study (2002-2003) and full-scale application (2004-2007) of ISCO using permanganate in fractured rock. One limitation of this application of CSIA was timing, because ISCO with permanganate may degrade contaminant mass in very fast timeframes (e.g., on the order of hours); seeing an isotopic shift required collecting samples impacted by permanganate before rebound occurred and with measurable chlorinated solvent concentrations. All CSIA samples collected from the Watervliet Arsenal were analyzed at the University of Waterloo.

An example of data collected during the pilot study is provided in Table 8-3. Significant isotopic shifts were observed at location Monitoring Well (MW)-65-1 on March 7, 2002, the day that permanganate was first detected at this location. In general, the extent of isotopic enrichment increased as the number of substituted chlorines decreased. The pilot study data verified that decreases in VOC concentrations were the result of contaminant mass destruction, not only displacement.

**Table 8-3. Example Compound Specific Isotope Analysis Data from Watervliet Arsenal Pilot Study**

Well ID	Date Sampled	PCE (ug/L)	TCE (ug/L)	c-DCE (ug/L)	Carbon Isotope ( $\delta^{13}\text{C}$ )		
					PCE (‰)	TCE (‰)	c-DCE (‰)
MW-65-1	20-Feb-02	387	166	1356	-30.57	-30.03	-31.65
MW-65-1	06-Mar-02	1,961.5	387.6	1,948.8	-30.86	-34.22	-31.76
MW-65-1	07-Mar-02	1,282.6	4.9	210.4	-19.48	nd	45.03
MW-65-1	18-Mar-02	3.4	nd	nd	nd	nd	nd

The primary conclusions drawn from the pilot study CSIA monitoring were as follows (note that these are discussed in detail in Malcolm Pirnie and University of Waterloo, 2010):

1. For the most part, changes in PCE concentration observed during the first two days of the March 2002 permanganate injection were the result of dilution and/or mass transport from areas of high PCE concentration due to the pressure front created by the injection process.
2. The  $\delta^{13}\text{C}$  enrichment pattern of PCE observed at MW-65-1 during monitoring immediately after injection was a result of PCE oxidation by permanganate. The permanganate solution traveled preferentially through a fracture network that was tapped by that particular monitoring location. The detection of permanganate only in this monitoring location supported the isotope data.
3. A shift to pre-injection  $\delta^{13}\text{C}$  values after permanganate injection implied that significant VOC mass was present in areas upgradient of certain monitoring points or in the bedrock matrix; this VOC mass was transported to the monitoring points and sustained elevated concentrations at the monitoring points.

During the full-scale application of permanganate at Watervliet Arsenal, CSIA data indicated that significant carbon isotope enrichment occurred only in several locations, many of which had lower initial VOC concentrations compared to the locations where no isotope shifts were discerned. Some relatively low-concentration areas showed  $\delta^{13}\text{C}$  values as high as +12.7‰ for cis-DCE (the pre-injection  $\delta^{13}\text{C}$  values for cis-DCE ranged between -26 and -24 ‰). In general, the full-scale application isotope data provided information about the competing processes of permanganate oxidation and rebound of chlorinated solvent concentrations, which controlled chlorinated solvent concentrations during and after permanganate treatment. The short timeframes for  $\delta^{13}\text{C}$  values to return to pre-treatment isotopic signatures indicated that rebound (whether from advection or back-diffusion from the bedrock matrix) overwhelmed the ISCO treatments. The expected isotope trend associated with oxidation was only observed at monitoring locations characterized by relatively low chlorinated solvent concentrations, where perhaps a relatively smaller mass of chlorinated solvent was present in the shale matrix.

### 8.6.2. *Attributes for Selection*

CSIA applications are gaining acceptance for use at chlorinated solvent sites, complementing traditional site investigation and remediation performance monitoring techniques. To date, CSIA has been applied most frequently to carbon isotopes, and CSIA for carbon isotopes can be considered a **mature technology**. CSIA for other compounds of interest at chlorinated solvent sites (e.g., hydrogen, oxygen, chlorine) has not been performed to the same extent as for carbon; however, this is a topic of active research and shows promise for future use at chlorinated solvent sites.

CSIA analyses are **commercially available**, although the number of vendors is rather limited. This may change in the future as demand for this tool increases.

Application of CSIA is generally not influenced by site geology or hydrologic conditions. CSIA has been used at sites with consolidated (Watervliet Arsenal) and unconsolidated (Fort Lewis) media and found **applicable** to both.

CSIA is **applicable to many remedial technologies**, including enhanced in-situ bioremediation and abiotic in-situ technologies, as well as MNA. CSIA is useful in providing information regarding the mechanisms for degradation, which can be used to ascertain whether a remedy is performing as designed. Theoretically, CSIA could be applied at any sites where reactive processes in groundwater produce a change in the ratio of stable isotopes.

CSIA requires the collection and submittal of subsurface samples. It does not have complex requirements and is therefore **implementable**. The correct interpretation of CSIA data requires knowledge of site geology and geochemistry, so these elements must be accurately characterized before implementation of CSIA.

At the two field sites where CSIA was used as part of this research project, results from the analyses were of sufficient **accuracy and precision** to offer additional insight into degradation processes of chlorinated solvents in groundwater. At Fort Lewis, CSIA had a higher **detection limit** for ethene than did the standard GC analysis. While ethene was detected using conventional analytical methods, it was not detected using CSIA. In order to obtain an accurate isotopic reading, a large volume of groundwater may need to be collected for reductive daughter products that are present in lower concentrations. When analyzing for low concentrations, tedious purge-and-trap methods might need to be used prior to analysis to concentrate the sample. Overall, CSIA data should complement the gas chromatography data and vice versa. There are currently no standard analytical methods for CSIA. Therefore, methods and results can be highly variable among laboratories conducting this work. It is important to use the same methods and laboratories on a given project so that results are comparable. Guidelines to achieve acceptable data quality are provided in Chapter 2 of USEPA (2008).

CSIA analyses are **unique analyses**, in that they can provide evidence that chemicals of concern are being transformed by in-situ biotic or abiotic processes as opposed to concentration changes due to dilution or other physical processes.

CSIA offers unique data, and therefore its **cost** cannot be directly compared to other similar methods. Microseeps is the only commercial laboratory in North America to offer CSIA. They currently offer analyses for various compounds including the chlorinated solvents. The cost ranges from approximately \$300 to \$500 per sample, depending on the number of compounds to be analyzed.

### **8.6.3. Recommendations**

Application of CSIA at two field sites as part of this project confirmed that it provides unique, useful data for the analysis of in-situ degradation processes. Recommendations for its use at chlorinated solvent-contaminated sites are provided below.

#### **Recommendation #1. Use CSIA for multiple purposes throughout the site characterization and remediation process.**

CSIA for carbon isotopes may be applied during the site characterization, active remediation, and long-term monitoring stages of addressing a chlorinated solvent-contaminated site. CSIA does not always indicate whether degradation is occurring currently, however; unless it is used during an active remedy (e.g., during ISCO), the results may be indicating historical degradation. The applications of CSIA during site characterization and remediation were discussed in detail in Section 6.1.3 and include the following:

- Site characterization, including improvement of the CSM and source discrimination
- Qualitative and quantitative evidence for degradation
- Numerical modeling of contaminant transport
- Performance assessment during active remediation
- Demonstration of MNA
- Evaluation of mechanisms of biodegradation
- Evaluation of contaminant degradation versus dilution
- Conservative estimation of extent of degradation
- Long-term monitoring

As part of this project, application of CSIA at Fort Lewis provided useful information for performance assessment and to confirm chlorinated solvent degradation in groundwater by ISCO at some monitoring points. At Watervliet Arsenal, CSIA provided useful data to prove TCE biodegradation versus dilution and to demonstrate the mechanism of biodegradation.

#### **Recommendation #2. Conduct baseline CSIA measurements and analyses to confirm that the required detection limits are achievable.**

The determination of whether CSIA would be a useful tool at a chlorinated solvent site requires collection of baseline samples to obtain a preliminary understanding of fractionation behavior in contaminants at the site. Prior to performing CSIA, the contaminant concentrations should be analyzed using conventional methods to ensure that the CSIA analytical techniques will provide

adequate sensitivity. At Fort Lewis, CSIA had a higher detection limit for ethene than did the standard GC analysis. While ethene was detected using standard methods, it was not detected using CSIA.

A minimum of two baseline sampling events are recommended for sites with heterogeneous geology or variable plumes to ensure reproducibility of the CSIA data.

**Recommendation #3. Overall, use CSIA data to complement conventionally generated analytical data and vice versa.**

CSIA provides unique insights for interpreting and supplementing contaminant fate and transport data obtained using traditional diagnostic tools. It does not, however, replace traditional analyses of constituent concentrations in groundwater.

### **8.7. Molecular Biological Tools**

Section 7.0 of this report addressed the use of molecular biological tools (MBTs). MBTs include a suite of assays targeting biomolecules such as nucleic acids (deoxyribonucleic acid (DNA) and ribonucleic acid (RNA)), lipids, and proteins, as well as isotopes to provide evidence regarding the composition and/or activity of microbial communities. These assays can have utility in remediation applications that rely on biological degradation mechanisms to attenuate contaminants, including bioremediation and MNA. Detailed descriptions of the methods for MBTs were provided in Section 7.2. The MBTs evaluated as part of this report include the following:

- Clone libraries (16S rRNA genes and functional genes)
- CSIA
- DGGE
- Enzyme probes
- FISH
- Microarrays
- PLFA
- Proteomics
- qPCR: 16S rRNA gene
- qPCR: mRNA
- qPCR: functional gene
- T-RFLP

As a summary evaluation of CSIA was provided in Section 8.6, CSIA will not be discussed further in this section.

### 8.7.1. Field Results

MBTs were evaluated as part of this project during the implementation of bioremediation at the Fort Lewis East Gate Disposal Yard, as described in greater detail in Appendix D. At Fort Lewis, MBTs were used to track microbial community changes in response to whey powder injections in two bioremediation treatment cells within a chlorinated solvent DNAPL source area. The relationship between community structure and overall bioremediation performance was evaluated in order to determine the utility of these methods as predictive and performance assessment tools. Below is a summary of results for the various MBTs applied at Fort Lewis. The findings from this field evaluation were considered in the assessment that follows.

- Community-level T-RFLP profiling: These data provided information regarding the shift in predominant bacterial and archaeal populations during enrichment of a microbial community using whey powder. While T-RFLP data can provide interesting scientific information regarding community-level dynamics, potentially including insights into important interactions among populations, they were not necessary to make operational decisions at Fort Lewis.
- qPCR for *Dehalococcoides*: These data were useful in evaluating growth and activity of these contaminant-degrading microbes. First, high initial concentrations of indigenous *Dehalococcoides* that included three reductase genes, followed by growth after whey injection, provided evidence that the bioaugmentation of the site was largely unnecessary. In addition, evaluation of specific strains of *Dehalococcoides* that were native to the site, and not present in the bioaugmentation culture, verified that native *Dehalococcoides* were enriched during the biostimulation. Evaluation of qPCR data with contaminant and geochemical data was useful in evaluating conditions necessary to enrich and maintain a *Dehalococcoides* population capable of efficient degradation to ethene. These data were used to determine key environmental factors that impaired contaminant-degrading efficiency (i.e., pH<6.0). These data can be directly used to define key operational criteria for optimization and maintenance of an efficient bioremediation strategy.
- FISH for *Dehalococcoides*: FISH was essentially redundant to qPCR data for *Dehalococcoides*. In addition, FISH has not been developed for chlorinated solvent reductase genes *bvcA*, *vcrA*, and *tceA*, and the technique is more difficult to perform, requires relatively specialized expertise, and is not commercially available.
- qPCR for methanogenic populations: While these data are useful from a scientific standpoint, they were not used to make operational decisions at Fort Lewis. However, these results are consistent with Macbeth et al. (2004) in suggesting that competition for hydrogen between dechlorinators and methanogens is not a significant concern for optimizing electron donor injection strategies at these particular field sites. For Fort Lewis, the use of chemistry data for methane was sufficient to verify that methane-producing conditions necessary for efficient growth and activity of *Dehalococcoides* were present.
- FISH for methanogenic populations: Similar to qPCR for methanogenic populations, these data are useful from a scientific standpoint, but were not used to make operational decisions at Fort Lewis.

### 8.7.2. Attributes for Selection

An evaluation of the attributes relevant to a VOI analysis for MBTs follows.

MBTs have varying degrees of technology **maturity**. Many molecular tools were only first field-tested during this project. While most MBTs are not commercially available, qPCR for the 16S rRNA gene is commercially available for a few key organisms (e.g., *Dehalococcoides* spp. and methanogens), qPCR for functional genes is commercially available for a few key genes (e.g., reductive dehalogenase genes, sulfate reductase), and DGGE/T-RFLP community analyses are commercially available. Ongoing projects funded through SERDP and ESTCP (e.g., ER-1683, ER-1587, and ER-200708) are researching improvements for use of MBTs at chlorinated solvent-contaminated sites.

**Application** of MBTs is generally not influenced by site geology or hydrologic conditions.

MBTs are only **applicable** for in-situ remedial processes involving microbial transformations, such as bioremediation and MNA.

The **implementability** of MBTs depends partly upon the ease and feasibility of obtaining representative samples from the subsurface. Methods for obtaining samples for MBTs have not been standardized. Once samples have been obtained, molecular analyses can be conducted by research or university laboratories, and, in some cases, by commercial laboratories. Generally, the widespread use of MBTs other than qPCR for *Dehalococcoides* and reductive dehalogenase genes is limited by logistical issues such as the lack of standardized methods and the limited number of commercially available labs.

Based on field trials and evaluation, the qPCR technology provides sufficient **detection limits, accuracy, and precision** for application to biological processes at chlorinated solvent sites. While MBTs are, in general, accurate, many of the analyses are non-specific, fingerprinting tools (DGGE, PLFA, and T-RFLP), provide only qualitative or semi-quantitative information (proteomics and microarrays), or have other limitations that preclude their widespread use. Community fingerprinting analyses (DGGE and T-RFLP) are not comprehensive, provide only relative indications of diversity and abundance, and must be combined with other analyses (e.g., PCR or clone libraries) to actually identify detected organisms. Currently, only limited availability of global microorganism microarrays exists, and the information obtained from microarrays is only as comprehensive as the number of species/gene targets that are present on the array. The comprehensiveness of clone libraries depends on the number of genes that are sequenced, which is in turn constrained by cost. While FISH, EAPs, and proteomics are accurate, their use is significantly limited by commercial availability and cost. PLFA can provide indications regarding general biomass and community structure, but it is generally non-specific; it does not provide information on key populations of interest to chlorinated solvent biodegradation (i.e., contaminant-degrading populations such as *Dehalococcoides*).

MBTs provide **unique data** regarding microbial community structure and potential functions that cannot be obtained by any other diagnostic tool. However, as discussed in Section 7.0, **routine geochemical data** (e.g., dissolved nitrate, iron, sulfate, and methane concentrations) and analyses of degradation products from a site can serve as indirect but reliable and informative evidence for microbial reactions. For chlorinated solvent sites, qPCR analyses of organisms (16S

rRNA gene) and functional genes can provide valuable, unique information for troubleshooting enhanced reductive dechlorination and can provide additional information to support conclusions regarding microbial activity. However, they are best used in combination with geochemical data and only when geochemical data are insufficient to address all performance assessment issues. In addition, MBTs have only limited ability to quantify contaminant attenuation rates relative to standard approaches, which limits their decision-making impact. Geochemical data and CSIA can be coupled with hydraulic modeling to better evaluate attenuation rates controlled by biodegradation.

The criterion of **comparative cost** is not directly applicable to MBTs because they provide unique data that cannot be provided by other techniques. However, the additional expenditure required for MBTs should be weighed against the usefulness of the information they could potentially provide. DGGE/T-RFLP microbial community analyses cost approximately \$300-400/target/sample, for example, and, without additional analyses, are only a screening tool and do not provide identification of microorganisms of interest. The cost of qPCR analyses (\$75-250/target/sample) is more reasonable, and those analyses target specific, key processes or populations of interest (e.g., cometabolic oxidation and *Dehalococcoides*).

### 8.7.3. Recommendations

MBTs provide unique information that facilitates the performance assessment and process optimization of bioremediation and natural attenuation of chlorinated solvents, and their use has provided important insights in research settings. Many of the MBT methods, however, are time-intensive, specialized, qualitative and in many cases not commercially available. The results of this project therefore support the limited use of specific MBTs for application to remediation of chlorinated solvents, as described below in specific recommendations.

**Recommendation #1: Use qPCR at chlorinated solvent sites to: (1) decide whether to bioaugment, (2) troubleshoot engineered bioremediation or monitored natural attenuation, or (3) provide a supporting line of evidence for biodegradation.**

Compared to other MBTs evaluated during this project, qPCR has several advantages, including being quantitative, commercially available, and specific to organisms/genes of particular relevance to chlorinated solvent sites. qPCR provides direct evidence quickly and relatively cheaply regarding the presence of contaminant-degrading populations, including *Dehalococcoides* species. *Dehalococcoides*-specific qPCR is effective at determining the presence of known, native populations at a site and can support the decision whether to bioaugment. In addition, qPCR also allows evaluation of *Dehalococcoides* in response to bioremediation operations and provides data to troubleshoot any conditions that may be adversely impacting *Dehalococcoides* growth and activity (e.g., low pH or unsuitable redox conditions).

For analysis of bioremediation or natural attenuation at chlorinated solvent sites, qPCR of specific organisms such as *Dehalococcoides* and functional genes such as reductive dehalogenases can provide a supporting line of evidence for sustainable biodegradation, in combination with geochemical data and other potential lines of evidence.



**Recommendation #2: Evaluate standard geochemical parameters in groundwater before using MBTs for information for characterization and for troubleshooting many operational issues related to biodegradation of chlorinated solvents.**

Evaluation of groundwater chemistry, including contaminants and degradation products, can be used to identify whether native contaminant-degrading populations are present at a site, to identify whether contaminant-degrading populations are active at a site, and to determine whether processes or conditions limiting biodegradation rates could be optimized to facilitate achieving RAOs. If the extent of degradation, reaction pathways, and reaction rates can be elucidated from aqueous geochemical analyses, MBT data may be unnecessary. However, qPCR data could be useful in some instances for troubleshooting reaction rates that are not sufficient to achieve objectives.

**Recommendation #3: Do not conduct routine molecular evaluation of methanogenic populations unless site-specific conditions require detailed evaluation of these populations.**

Methane generation during bioremediation may be viewed as a potential concern because of undesirable secondary water quality impacts. Evaluation of groundwater chemistry, including concentrations of methane, can be used to evaluate this issue. Generally, MBT data would be unnecessary as part of the evaluation, but the potential exists that they may be useful to develop a strategy to mitigate methane production rates by favoring specific pathways.

Methanogenic activity has historically also been of interest because of potential competition between methanogens and *Dehalococcoides* for hydrogen. The results from FISH and qPCR analyses of methanogens at Fort Lewis are consistent with Macbeth et al. (2004) in suggesting that competition for hydrogen between dechlorinators and methanogens is not a significant concern for optimizing electron donor injection strategies at these particular field sites. For Fort Lewis, the use of chemistry data for methane was sufficient to verify that methane-producing conditions necessary for efficient growth and activity of *Dehalococcoides* were present.

## **8.8. Summary**

This report has discussed a wide range of innovative diagnostic tools for characterization and remedial performance assessment at chlorinated solvent-contaminated sites. The uncertainty faced by practitioners while making decisions regarding remediation at such sites is a significant challenge, as is the decision of whether to expend additional resources to use one or more new diagnostic tools to decrease that uncertainty. This project was an effort to test certain tools and then develop qualitative guidelines regarding the value of information provided by diagnostic tools. A summary of the evaluation of attributes of the tools relevant to a value of information analysis is provided in Table 8-4.

**Table 8-4. Summary of Evaluation of Value of Information Attributes**

<b>Attribute</b>	<b>Multi-level monitoring systems</b>	<b>Rock matrix characterization</b>	<b>MF/MD</b>	<b>CSIA</b>	<b>MBTs</b>
Maturity of the tool	Mature; commercially available	Mature; commercially available	Maturing; some tools commercially available	Mature; commercially available	Variable among tools; some tools commercially available
Applicability to site characteristics	Applicable	Applicable to consolidated media	Consider site characteristics carefully	Applicable	Applicable
Applicability to specific in-situ technology	May be incompatible with certain oxidants or high temperatures	Applicable	Applicable	Applicable to bioremediation, abiotic in-situ treatment (e.g., chemical oxidation), MNA	Applicable to processes involving biological transformations
Ease of implementation	Generally implementable	Involves significant time and effort	Depends on site and level of prior characterization	Implementable	Some tools limited by logistical issues (e.g., lack of standardized methods)
Detection limits, accuracy, and precision	More precise than conventional monitoring; several variables impact accuracy	Sufficient for chlorinated solvents in fractured rock	Depends on accuracy of prior characterization; mixed results regarding PFMs	Some variability; important to follow guidelines to achieve acceptable data quality	Sufficient for some tools (e.g., PCR); other tools are qualitative
Uniqueness of data	Unique	Unique	Unique	Unique	Unique
Cost	Short-term costs likely to result in long-term savings	NA; provides unique data	Site-specific	NA; provides unique data	NA; provides unique data

NA = not applicable

A summary of recommendations for each of the tools is provided in Table 8-5. When implemented according to these recommendations, the tools evaluated in this project can provide sufficient value of information for decision-making to justify the additional investment beyond conventional characterization and performance assessment.

**Table 8-5. Recommendations for Application of Innovative Diagnostic Tools at Chlorinated Solvent-Contaminated Sites**

Diagnostic Tool	Recommendations
Multi-Level Monitoring Systems	<ul style="list-style-type: none"> <li>• Use MLM systems for vertical delineation of hydrogeologic properties and contaminant concentrations, particularly at sites with subsurface heterogeneity.</li> <li>• Balance relevant criteria for the selection of the most appropriate MLM system for a given site.</li> </ul>
Rock Matrix Characterization	<ul style="list-style-type: none"> <li>• Consider rock matrix characterization as a characterization tool at consolidated sites, but carefully weigh the potential value of information collected from the technique against its cost.</li> </ul>
Mass Flux Measurement	<ul style="list-style-type: none"> <li>• Mass flux/discharge should be calculated at all contaminated sites, if possible, because it can be used to improve remedial decisions made at various stages of the cleanup process.</li> <li>• Consider the site hydrogeologic setting when selecting the mass flux/mass discharge measurement method.</li> <li>• Follow best practices during field implementation to increase the accuracy, usefulness, and cost-effectiveness of mass flux/mass discharge measurement methods.</li> </ul>
Compound Specific Isotope Analysis (CSIA)	<ul style="list-style-type: none"> <li>• Use CSIA for multiple purposes throughout site characterization and remediation.</li> <li>• Conduct baseline CSIA measurements and analyses to confirm the required detection limits are achievable.</li> <li>• Overall, use CSIA data to complement conventionally generated analytical data and vice versa.</li> </ul>
Molecular Biological Tools	<ul style="list-style-type: none"> <li>• Use qPCR at chlorinated solvent sites to: (1) troubleshoot engineered bioremediation or monitored natural attenuation, or (2) provide a supporting line of evidence for biodegradation.</li> <li>• Evaluate standard geochemical parameters in groundwater before using MBTs for information for characterization and for troubleshooting many operational issues related to biodegradation of chlorinated solvents.</li> <li>• Do not conduct routine molecular evaluation of methanogenic populations unless site-specific conditions require detailed evaluation of these populations.</li> </ul>

Table 8-6 summarizes the applicability of innovative diagnostic tools for various stages of the remedial decision-making process, based on the value of information provided by the tool for

each decision-making point. The attributes relevant to the determination of value of information were qualitatively evaluated in the preceding sections for each tool. Because of the extent of uncertainty related to the multiple attributes, the evaluation in Table 8-6 is based on professional judgment, in addition to the results of the field testing of this project and results from other field sites with which the authors are familiar.

**Table 8-6. Applicability of Innovative Diagnostic Tools at Chlorinated Solvent Sites**

<b>Remedial Decision</b>	<b>Multi-level monitoring</b>	<b>Rock matrix</b>	<b>MF/MD</b>	<b>CSIA</b>	<b>MBTs</b>
Pre-remedy characterization and CSM development	5	5	5	4	2
Selection of remedial technologies	4	4	3	1	3
Performance assessment	4	3	4	4	3
Process modification/ optimization	4	1	3	3	3
Confirming degradation processes	2	1	1	5	4
Estimating risks to receptors	4	1	4	1	1
Transition to LTM or NFA	4	1	4	3	3

Note: 1 = Not applicable, 5 = Extremely useful and/or applicable

While Table 8-6 provides guidance regarding the applicability of diagnostic tools for various stages of the decision-making process for remediation at chlorinated solvent sites, there are many factors to consider in the selection of the most appropriate and informative tools. These factors have been discussed throughout this report. In each case, therefore, the selection and use of diagnostic tools will be site-specific. However, this report provides relevant criteria to consider during the selection decision, as well as evaluation of the criteria for each tool. Contact information for vendors for the diagnostic tools evaluated in this study is provided in Appendix B.

## REFERENCES

- Abe, Y., Aravena, R., Zopfi, J., Shoukar-Stash, O., Cox, E., Roberts, J.D., and Hunkeler, D. 2009. Carbon and chlorine isotope fractionation during aerobic oxidation and reductive dechlorination of vinyl chloride and cis-1,2-dichloroethene. *Environmental Science and Technology*. 43(1): 101-107.
- Air Force Center for Engineering and the Environment (AFCEE). 2010. Technology Transfer: Models. Retrieved from <http://www.afcee.af.mil/resources/technologytransfer/models/index.asp>
- AFCEE. 2004. Principles and Practices of Enhanced Anaerobic Bioremediation of Chlorinated Solvents. Retrieved from [http://costperformance.org/remediation/pdf/principles\\_and\\_practices\\_bioremediation.pdf](http://costperformance.org/remediation/pdf/principles_and_practices_bioremediation.pdf)
- Alvarez-Cohen, L. and Speitel, G.E. Jr. 2001. Kinetics of aerobic cometabolism of chlorinated solvents. *Biodegradation*. 12(2): p. 105-26.
- Anderson, J.E. and McCarty, P.L. 1997. Transformation yields of chlorinated ethenes by a methanotrophic mixed culture expressing particulate methane monooxygenase. *Applied and Environmental Microbiology*. 63(2): p. 687-93.
- Anderson, M.P. and Woessner, W.W. 1994. *Applied Groundwater Modeling: Simulation of Flow and Advective Transport*, Japanese Translation, Kyoritsy Shuppan Co., Ltd.
- Annable, M.D., Hatfield, K., Cho, J., Klammler, H., Parker, B.L., Cherry, J.A., and Rao, P.S. 2005. Field-scale evaluation of the passive flux meter for simultaneous measurement of groundwater and contaminant fluxes. *Environmental Science and Technology*. 39(18): p. 7194–7201.
- Aulenta, F., Rossetti, S., Majone, M., Tandoi, V. 2004. Detection and quantitative estimation of *Dehalococcoides* spp. in a dechlorinating bioreactor by a combination of fluorescent in-situ hybridisation (FISH) and kinetic analysis. *Applied Microbiology and Biotechnology*. 64(2): p. 206-12.
- Azizian, M.F., Istok, J.D., and Semprini, L. 2007. Evaluation of the in-situ aerobic cometabolism of chlorinated ethenes by toluene-utilizing microorganisms using push-pull tests. *Journal of Contaminant Hydrology*. 90(1-2): p. 105-24.
- Back, P.E., Rosén, L., and Norberg, T. 2007. Value of Information Analysis in Remedial Investigations. *AMBIO: A Journal of the Human Environment*. 36(6): p. 486-493.
- Baldwin, B.R., Nakatsu, C.H., and Nies, L. 2003. Detection and enumeration of aromatic oxygenase genes by multiplex and real-time PCR. *Applied and Environmental Microbiology*. 69(6): p. 3350-3358.
- Barbaro, J.R., and Neupane, P.P. 2006. Use of plume mapping data to estimate chlorinated solvent mass loss. *Ground Water Monitoring and Remediation*. 26(4): p. 115-127.

- Basu, N.B., Rao, P.S.C., Falta, R.W., Annable, M., Jawitz, J.W., and Hatfield, K. 2008. Temporal evolution of DNAPL source and contaminant flux distribution: impacts of source mass depletion. *Journal of Contaminant Hydrology*. 95(3-4): p. 93-109.
- Basu, N.C., Rao, P.S.C., Poyer, I.C., Annable, M.D., and Hatfield, K. 2006. Flux-based assessment at a manufacturing site contaminated with trichloroethylene. *Journal of Contaminant Hydrology*. 86(1-2): p. 105-127.
- Bauer, S., Bayer-Raich, M., Holder, T., Kolesar, C., Muller, D., and Ptak, T. 2004. Quantification of groundwater contamination in an urban area using integral pumping tests. *Journal of Contaminant Hydrology*. 75(3-4): p. 183-213.
- Bayer-Raich, M., Jarsjo, J., Liedl, R., Ptak, T., and Teutsch, G. 2004. Average contaminant concentration and mass flux in aquifers from time-dependent pumping well data - Analytical framework. *Water Resources Research*. 40.
- Beckett, G.D. and Stanley, C.C. 2005. Safe use of ground water in the presence of a proximate MTBE plume: Using Flux and transport-based estimates to ensure groundwater production capacity. Abstract presented at 2005 National Ground Water Association (NGWA) Ground Water Summit. San Antonio, Texas. April 17-20, 2005.
- Berkowitz, B. 2002. Characterizing flow and transport in fractured geologic media: a review. *Advances in Water Resources*. 25(8): 861-884.
- Black, W.H., Smith, H.R. and Patton, F.D. 1986. Multiple-level ground water monitoring with the MP system. Proceedings of the National Water Well Association's Conference on Surface and Borehole Geophysical Methods and Ground Water Instrumentation: p. 41-61. Denver, Colorado. October 15-17, 2005.
- Bockelmann, A., Ptak, T., and Teutsch, G. 2001. An analytical quantification of mass fluxes and natural attenuation rate constants at a former gasworks site. *Journal of Contaminant Hydrology*. 53(3-4): p. 429-153.
- Bockelmann, A., Zamfirescu, D., Ptak, T., Grathwohl, P., and Teutsch, G. 2003. Quantification of mass fluxes and natural attenuation rates at an industrial site with a limited monitoring network: A case study. *Journal of Contaminant Hydrology*. 60(1-2): p. 97-121.
- Borden, R.C., Daniel, R.A., LeBrun, L.E. IV, and Davis, C.W. 1997. Intrinsic biodegradation of MTBE and BTEX in a gasoline-contaminated aquifer. *Water Resources Research*. 33(5): p. 1105-1115.
- Brooks, M.C., Wood, L.A., Annable, M.D., Hatfield, K., Cho, J., Holbert, C., Rao, P.S.C., Enfield, C.G., Lynch, K. and Smith, R.E. 2008. Changes in contaminant mass discharge from DNAPL source mass depletion: Evaluation at two field sites. *Journal of Contaminant Hydrology*. 102: p. 140-153.

- Brusseau, M.L., DiFilippo, M.L., Marble, J.C., and Oostrom, M. 2008. Mass removal and mass flux reduction behavior for idealized source zones with hydraulically poorly accessible immiscible liquid. *Chemosphere*. 71(8): p. 1511-21.
- Bull, I.D., Parekh, N.R., Hall, G.H., Ineson, P., and Evershed, R.P. 2000. Detection and classification of atmospheric methane oxidizing bacteria in soil. *Nature*. 405(6783): p. 175-178.
- Buscheck, T.E. 2002. Mass Flux Estimates to Assist Decision-Making. Technical Bulletin. ChevronTexaco.
- Buscheck, T.E., Nijhawan, N., and O'Reilly, K. 2003. Mass flux estimates to assist remediation decision-making. Proceedings of the Seventh International In Situ and On-Site Bioremediation Symposium. Orlando, Florida. June 2-5, 2003.
- Campbell, T., Hatfield, K., Klammler, H., Annable, M.D., and Rao, P.S. 2006. Magnitude and directional measures of water and Cr(VI) fluxes by passive flux meter. *Environmental Science and Technology*. 40(20): 6392-6397.
- Cardiff, M., Liu, X., Kitanidis, P.K., Parker, J., and Kim, U. 2010. Cost optimization of DNAPL source and plume remediation under uncertainty using a semi-analytic model. *Journal of Contaminant Hydrology*. 113: p. 25-43.
- Castro, H., Ogram, A., and Reddy, K.R. 2004. Phylogenetic characterization of methanogenic assemblages in eutrophic and oligotrophic areas of the Florida Everglades. *Applied and Environmental Microbiology*. 70(11): p. 6559-68.
- Chang, H.L. and Alvarez-Cohen, L. 1995. Transformation capacities of chlorinated organics by mixed cultures enriched on methane, propane, toluene, or phenol. *Biotechnology and Bioengineering*. 45(5): p. 440-9.
- Chapman, S.W., Byerley, B.T., Smyth, D.J.A., and Mackay, D.M. 1997. A pilot test of passive oxygen release for enhancement of in-situ bioremediation of BTEX-contaminated ground water. *Ground Water Monitoring and Remediation*. 17(2): p. 93-105.
- Chapman, S.W. and Parker, B.L. 2005. Plume persistence due to aquitard back diffusion following dense nonaqueous phase liquid source removal or isolation. *Water Resources Research*. 41(W12411).
- Chapman, S.W., Parker, B.L., Cherry, J.A., Aravena, R., and Hunkeler D. 2007. Groundwater-surface water interaction and its role on TCE groundwater plume attenuation. *Journal of Contaminant Hydrology*. 91(304): 203-232.
- Cherry, J.A. and Johnson, P.E. 1982. A multi-level device for monitoring in fractured rock. *Ground-Water Monitoring Review*. 2(3): p. 41-44.
- Cherry, J.A, Parker, B.L., and Keller, C. 2007. A new depth-discrete multilevel monitoring approach for fractured rock. *Ground-Water Monitoring and Remediation*. 27(2): p. 57-70.

- Chuang, A.S. and Mattes, T.E. 2007. Identification of polypeptides expressed in response to vinyl chloride, ethene, and epoxyethane in nocardioideis sp. strain JS614 by using peptide mass fingerprinting. *Applied and Environmental Microbiology*. 73(13): p. 4368-4372.
- Christ, J.A., Goltz, M.N., and Huang, J. 1999. Development and application of an analytical model to aid design and implementation of in-situ remediation technologies. *Journal of Contaminant Hydrology*. 37(3-4): p. 295-317.
- Church, P.E. and Granato, G.E. 1996. Bias in ground-water data caused by well-bore flow in long-screen wells. *Ground Water*. 34(2): p. 262-273.
- Clark, I. and Fritz, P. 1997. *Environmental isotopes in hydrogeology*. Boca Raton, FL: Lewis Publishers.
- Clements, L., Palaia, T., and Davis, J. 2008. Characterization of sites impacted by petroleum hydrocarbons: National Guideline Document. Cooperative Research Centre for Contamination Assessment and Remediation of the Environment. Report No. 11. Retrieved from <http://www.crccare.com/publications/downloads/CRC-CARE-Tech-Report-11-FINAL.pdf>
- Clingenpeel, S.R., Keenerb, W.K., Kellerc, C.R., De Jesus, K.M., Howard, H., and Watwood, M.E. 2005. Activity-dependent fluorescent labeling of bacterial cells expressing the TOL pathway. *Journal of Microbiological Methods*. 60(1): p. 41-46.
- Coleman, N.V. and Spain, J.C. 2003. Distribution of the coenzyme M pathway of epoxide metabolism among ethene- and vinyl chloride-degrading Mycobacterium strains. *Applied and Environmental Microbiology*. 69(10): p. 6041-6.
- Coleman, N.V., Mattes, T.E., Gossett, J.M., and Spain, J.C. 2002. Phylogenetic and kinetic diversity of aerobic vinyl chloride-assimilating bacteria from contaminated sites. *Applied and Environmental Microbiology*. 68(12): p. 6162-71.
- Conant, B. 2004. Delineating and quantifying ground water discharge zones using streambed temperatures. *Ground Water*. 42(2): 243-257.
- Conrad, R. 1999. Contribution of hydrogen to methane production and control of hydrogen concentrations in methanogenic soils and sediments. *FEMS Microbiology Ecology*. 28(3): p. 193-202.
- Crumbling, D.M. 2001. Current Perspectives in Site Remediation and Monitoring: Using the Triad Approach to Improve the Cost-effectiveness of Hazardous Waste Site Cleanup. USEPA. EPA 542-R-01-016. Retrieved from <http://www.clu-in.org/download/char/triad2.pdf>
- Crumbling, D.M., Griffith, J., and Powell, D.M. 2003. Improving decision quality: making the case for adopting next generation site characterization practices. *Remediation: The Journal of Environmental Cleanup Costs, Technologies & Techniques*. 13(2): p. 91-111.



- D'Affonseca, F.M., Blum, P., Finkel, M., Melzer, R., and Grathwohl, P. 2008. Field scale characterization and modeling of contaminant release from a coal tar source zone. *Journal of Contaminant Hydrology*. 102(1-2): p.120-39.
- de Jonge, H. and Rothenberg, G. 2006. New device and method for flux-proportional sampling of mobile solutes in soil and groundwater. *Environmental Science and Technology*. 39(1): p. 274-282.
- Devlin, J.F., McMaster, M.L., Katic, D.J. and Barker, J.F. 2001. Evaluating natural attenuation in a controlled field experiment by mass balances, flux fences and snapshots: A comparison of results. Paper presented at Ground Water Quality 2001, Sheffield, U.K., July 18-21, pp. 282-285.
- DiFilippo, E.L. and Brusseau, M.L. 2008. Relationship between mass-flux reduction and source-zone mass removal: Analysis of field data. *Journal of Contaminant Hydrology*. 98(1-2): p. 22-35.
- Dunbar, J., Takala, S., Barns, S.M., Davis, J.A., and Kuske, C.R. 1999. Levels of bacterial community diversity in four arid soils compared by cultivation and 16S rRNA gene cloning. *Applied and Environmental Microbiology*. 65(4): p. 1662-9.
- Dunbar, J., Ticknor, L.O., and Kuske, C.R. 2000. Assessment of microbial diversity in four southwestern United States soils by 16S rRNA gene terminal restriction fragment analysis. *Applied and Environmental Microbiology*. 66(7): p. 2943-50.
- Dunbar, J., Ticknor, L.O., and Kuske, C.R. 2001. Phylogenetic specificity and reproducibility and new method for analysis of terminal restriction fragment profiles of 16S rRNA genes from bacterial communities. *Applied and Environmental Microbiology*. 67(1): p. 190-7.
- Eby, R.K., Zimmermann, R.E., Paczkowski, M.T., Regan, T. 2004. Hydrogeologic investigation of VOC contamination in bedrock using mass flux analysis: A case history. Presented at 2004 U.S. EPA/NGWA Fractured Rock Conference: State of the Science and Measuring Success in Remediation. Portland, Maine. September 13-15, 2004.
- Einarson, M. 2006. Multilevel ground-water monitoring. In D.M. Nielsen (Ed.), *Practical Handbook of Environmental Site Characterization and Ground-Water Monitoring* (2nd ed.) (p.808-845). Boca Raton, FL: CRC Press.
- Einarson, M.D. and Cherry, J.A. 2002. A new multi-level ground-water monitoring system utilizing multichannel tubing. *Ground-Water Monitoring and Remediation*. 22(4): p. 52-65.
- Einarson, M.D., Cullen, J., Jogia, S., and Warner, S.D. 2005. Restoration of an MTBE-impacted water supply wellfield in Northern California. Abstract presented at 2005 NGWA Conference on MTBE and Perchlorate: Assessment, Remediation, and Public Policy. San Francisco, California. May 26-27, 2005.
- Einarson, M.D. and Mackay, D.M. 2001. Predicting impacts of ground water contamination. *Environmental Science and Technology*. 35(3): p. 66A-73A.

- Elci, A., Molz, F., and Waldrop, W.R. 2001. Implications of observed and simulated ambient flow in monitoring wells. *Ground Water*. 39(6): p. 853-862.
- Elci, A., G.P. Flach, and Molz, F. 2003. Detrimental effects of natural vertical head gradients on chemical and water level measurements in observation wells: identification and control. *Journal of Contaminant Hydrology*. 281: p. 70-81.
- Ensign, S.A., Hyman, M.R., and Arp, D.J. 1992. Cometabolic degradation of chlorinated alkenes by alkene monooxygenase in a propylene-grown *Xanthobacter* strain. *Applied and Environmental Microbiology*. 58(9): p. 3038-3046.
- Ewers, J., Freier-Schröder, D., and Knackmuss, H.-J. 1990. Selection of trichloroethene (TCE) degrading bacteria that resist inactivation by TCE. *Archives of Microbiology*. 154(4): p. 410-413.
- Falta, R.W., Basu, N.B., and Rao, P.S.C. 2005a. Assessing the impacts of partial mass depletion in DNAPL source zones II: Coupling source strength functions to plume evolution. *Journal of Contaminant Hydrology*. 79(1-2): p. 258-280.
- Falta, R.W., Rao, P.S.C., and Basu, N.B. 2005b. Assessing the impacts of partial mass depletion on DNAPL source zones: I. Analytical modeling of source strength functions and plume response. *Journal of Contaminant Hydrology*. 78(4): p. 259-280.
- Farhat, S.K., Newell, C.J., and Nichols, E.M. 2005. Mass Flux Toolkit. Groundwater Services, Inc. Retrieved from <http://www.gsi-net.com/en/software/free-software/mass-flux-toolkit.html>
- Fazi, S., Aulentab, F., Majoneb, M., and Rossetti, S. 2008. Improved quantification of *Dehalococcoides* species by fluorescence in-situ hybridization and catalyzed reporter deposition. *Systematic and Applied Microbiology*. 31(1): p. 62-7.
- Feenstra, S., Mackay, D. M., and Cherry J. A. 1991. A method for Assessing residual NAPL based on organic chemical concentrations in soil samples. *Ground Water Monitoring Review*. 11(2): p. 128-136.
- Feenstra, S., Cherry, J.A., and Parker, B.L. 1996. Conceptual models for the behavior of nonaqueous phase liquids (DNAPLs) in the subsurface. In J.F. Pankow and J.A. Cherry (Eds.), *Dense Chlorinated Solvents and Other DNAPLs in Groundwater*. Portland, OR: Waterloo Press.
- Ford, R.G. 2005. The Impact of Ground-Water/Surface Water Interactions on Contaminant Transport with Application to an Arsenic Contaminated Site. USEPA. EPA/600/S-05/002. Retrieved from [http://www.epa.gov/nrmrl/pubs/600s05002/epa\\_600\\_s05\\_002.pdf](http://www.epa.gov/nrmrl/pubs/600s05002/epa_600_s05_002.pdf)
- Freedman, D.L. and Herz, S.D. 1996. Use of ethylene and ethane as primary substrates for aerobic cometabolism of vinyl chloride. *Water Environment Research*. 68(3): p. 320-328.
- Freeze, R.A. and Cherry, J.A. 1979. *Groundwater*. Englewood Cliffs, NJ: Prentice Hall.

- Freeze, R.A., Bruce, J., Massman, J., Sperling, T., and Smith, L. 1992. Hydrogeological decision analysis: 4. The concept of data worth and its use in the development of site investigation strategies. *Ground Water*. 30(4): p. 574–588.
- Frind, E.O., Molson, J.W., and Rudolph, D.L. 2006. Well vulnerability: a quantitative approach for source water protection. *Ground Water*. 44(5): p. 732-742.
- Fung, J.M., Morris, R.M., Adrian, L., and Zinder, S.H. 2007. Expression of reductive dehalogenase genes in *Dehalococcoides ethenogenes* strain 195 growing on tetrachloroethene, trichloroethene, or 2,3-dichlorophenol. *Applied and Environmental Microbiology*. 73(14): p. 4439-45.
- Fure, A.D., Jawitz, J.W., and Annable, M.D. 2006. DNAPL source depletion: linking architecture and flux response. *Journal of Contaminant Hydrology*. 85(3-4): p. 118-140.
- Gibs, J., Brown, G.A., Turner, K.S., MacLeod, C.L., Jelinski, J.C., and Koehnlein, S.A. 1993. effects of small-scale vertical variations in well-screen inflow rates and concentrations of organic compounds on the collection of representative ground-water quality samples. *Ground Water*. 31(2): p. 201-208.
- Goldstein, K. J., Vitolins, A. R., Navon, D., Parker, B. L., Chapman, S., and Anderson, G. A. 2004. Characterization and pilot-scale studies for chemical oxidation remediation of fractured shale. *Remediation Journal*. 14(4): p. 19–37.
- Goltz, M.N., Kim, S., Yoon, H., and Park J. 2007. Review of groundwater contaminant mass flux measurement. *Environmental Engineering Research*. 12(4): p. 176–193.
- Goltz, M.N., Close, M.E., Yoon, H., Huang, J., Flintoft, M.J., Kim, S., and Enfield, C. 2009. Validation of two innovative methods to measure contaminant mass flux in groundwater. *Journal of Contaminant Hydrology*. 106(1-2): 51-61.
- Gray, A., Wang, A., Strawn, C., and Bauersachs, L. 2005. An evaluation of MTBE plume attenuation using two methods of mass flux analysis and isotope analyses at a drinking water well field. Paper presented at NGWA Petroleum Hydrocarbons and Organic Chemicals in Groundwater Conference. Costa Mesa, California. August 17-19, 2005.
- Guilbeault, M.A., Parker, B.L., and Cherry, J.A. 2005. Mass and flux distributions from DNAPL zones in sandy aquifers. *Ground Water*. 43(1): p. 70-86.
- Hales, B., Edwards, C., Ritchie, D.A., Hall, G., Pickup, R.W., and Saunders, J.R. 1996. Isolation and identification of methanogen-specific DNA from blanket bog peat by PCR amplification and sequence analysis. *Applied and Environmental Microbiology*. 62(2): p. 668-675.
- Hatfield, K., Annable, M., Cho, J.H., Rao, P.S.C., and Klammler, H. 2004. A direct passive method for measuring water and contaminant fluxes in porous media. *Journal of Contaminant Hydrology*. 75(3-4): p. 155-181.

Hatfield, K., Annable, M.D., Kuhn, S., Rao, P.S., and Campbell, T. 2001. A new method for quantifying contaminant flux at hazardous waste sites. Paper presented at the Groundwater Quality 2001 Conference. Sheffield, United Kingdom. June 2001.

Hendrickx, B., Junca, H., Vosahlova, J., Lindner, A., Rüegg, I., Bucheli-Witschel, M., Faber, F., Egli, T., Mau, M., Schlömann, M., Brennerova, M., Brenner, V., Pieper, D.H., Top, E.M., Dejonghe, W., Bastiaens, L., and Springael D. 2005. Alternative primer sets for PCR detection of genotypes involved in bacterial aerobic BTEX degradation: Distribution of the genes in BTEX degrading isolates and in subsurface soils of a BTEX contaminated industrial site. *Journal of Microbiological Methods*.64(2): p. 250-265.

Hendrickx, B., Junca, H., Vosahlova, J., Lindner, A., Rüegg, I., Bucheli-Witschel, M., Faber, F., Egli, T., Mau, M., Schlömann, M., Brennerova, M., Brenner, V., Pieper, D.H., Top, E.M., Dejonghe, W., Bastiaens, L., and Springael, D. 2006. Alternative primer sets for PCR detection of genotypes involved in bacterial aerobic BTEX degradation: distribution of the genes in BTEX degrading isolates and in subsurface soils of a BTEX contaminated industrial site. *Journal of Microbiological Methods*. 64(2): p. 250-65.

Holder, T., Teutsch, G., Ptak, T., and Schwarz, R. 1998. A new approach for source zone characterization: the Neckar Valley study. In *Groundwater Quality: Remediation and Protection*, proceeding of the GQ'98 Conference. Tübingen, Germany, p. 21-25, 1998.

Holmes, V.F., He, J., Lee, P.K.H., and Alvarez-Cohen, L. 2006. Discrimination of multiple *Dehalococcoides* strains in a trichloroethene enrichment by quantification of their reductive dehalogenase genes. *Applied and Environmental Microbiology*. 72(9): p. 5877-5883.

Hopkins, G.D. and McCarty, P.L. 1995. Field evaluation of in-situ aerobic cometabolism of trichloroethylene and three dichloroethylene isomers using phenol and toluene as the primary substrates. *Environmental Science and Technology*. 29(6): p. 1628-1637.

Huang, J., Close, M.E., Pang, L., and Goltz, M.N. 2004. Innovative method to measure flux of dissolved contaminants in groundwater. Paper presented at the Battelle Institute Fourth International Conference on Remediation of Chlorinated and Recalcitrant Compounds. Monterey, California. May 24-27, 2004.

Hunkeler, D., Aravena, R., Berry-Spark, K., and Cox, E. 2005. Assessment of degradation pathways in an aquifer with mixed chlorinated hydrocarbon contamination using stable isotope analysis. *Environmental Science and Technology*. 39(16): p. 5975-5981.

Hunkeler, D., Aravena, R., Parker, B.L., Cherry, J.A., and Diao, X. 2003. Monitoring oxidation of chlorinated ethenes by permanganate in groundwater using stable isotopes: Laboratory and field studies. *Environmental Science and Technology*. 37(4): p. 798-804.

Hunkeler, D., Chollet, N., Pittet, X., Aravena, R., Cherry, J.A., and Parker, B.L. 2004. Effect of source variability and transport processes on carbon isotope ratios of TCE and PCE in two sandy aquifers. *Journal of Contaminant Hydrology*. 74(1-4): p. 265-282.

Hurley, J.C. and Parker, B.L. 2002. Rock core investigation of DNAPL penetration and TCE mobility in fractured sandstone. Proceedings of the 55th Canadian Geotechnical and 3rd Joint IAH-CNC and CGS Groundwater Specialty Conferences, Ground and Water: Theory to Practice. Eds. Stolle D., A.R. Piggott and J.J. Crowder, Southern Ontario Section of the Canadian Geotechnical Society. Niagara Falls, Ontario, Canada. October 20-23, 2001. p. 473-480.

Hutchins, S.R. and Acree, S.D. 2000. Ground water sampling bias observed in shallow conventional wells. *Ground Water Monitoring and Remediation*. 20(1): p. 86-93.

Hyun, S., Jafvert, C.T., Jenkinson, B., Enfield, C., and Johnson, B. 2007. Measuring the flux at the interface of coal-tar impacted sediment and river water near a former MGP site. *Chemosphere*. 68(6): p. 1020-1029.

Interstate Technology & Regulatory Council (ITRC). 2000. Dense Non-Aqueous Phase Liquids (DNAPLs): Review of Emerging Characterization and Remediation Technologies. Retrieved from <http://www.itrcweb.org/Documents/DNAPLs-1.pdf>.

ITRC. 2003. An Introduction to Characterizing Sites Contaminated with DNAPLs. Retrieved from <http://www.itrcweb.org/Documents/DNAPLs-4.pdf>.

ITRC. 2004. Strategies for Monitoring the Performance of DNAPL Source Zone Remedies. Retrieved from <http://www.itrcweb.org/Documents/DNAPLs-5.pdf>

ITRC. 2005. Overview of In Situ Bioremediation of Chlorinated Ethene DNAPL Source Zones. Retrieved from <http://www.itrcweb.org/Documents/BioDNAPL-1.pdf>

ITRC. 2007. In Situ Bioremediation of Chlorinated Ethene DNAPL Source Zones: Case Studies. Retrieved from [http://www.itrcweb.org/Documents/bioDNPL\\_Docs/BioDNAPL-2.pdf](http://www.itrcweb.org/Documents/bioDNPL_Docs/BioDNAPL-2.pdf)

ITRC. 2008. In Situ Bioremediation of Chlorinated Ethene: DNAPL Source Zones. Retrieved from [http://www.itrcweb.org/Documents/bioDNPL\\_Docs/BioDNAPL3.pdf](http://www.itrcweb.org/Documents/bioDNPL_Docs/BioDNAPL3.pdf)

ITRC. 2010a. ITRC Technical Project Teams. Retrieved from <http://www.itrcweb.org/Documents/2010TeamDescriptions.pdf>

ITRC. 2010b. Use and Measurement of Mass Flux and Mass Discharge. Int-DNAPL-1. Washington, D.C.

Isodetect. 2009. Scientific Background: Isotope Field Studies. Retrieved from [http://www.isodetect.de/en/field\\_studies.html](http://www.isodetect.de/en/field_studies.html).

Jackson, R.E., Annable, M.D., Hirasaki, G.J. and Pope, G.A. 2005. DNAPL source zone characterization and remediation at Hill AFB, Utah, 1995-2002. Presented at the 15<sup>th</sup> Symposium in Groundwater Resources Association's (GRA's) Series on Groundwater Contaminants, San Francisco, California, December 7-8, 2005.

James, B.R., and Freeze, R.A. 1993. The worth of data in predicting aquitard continuity in hydrogeological design. *Water Resource Research*. 29(7): p. 2049-2065.

- James, B.R., and Gorelick, S.M. 1994. When enough is enough: the worth of monitoring data in aquifer remediation design. *Water Resource Research*. 30(12): p. 3499–3513.
- Jarsjö, J., Bayer-Raich, M., and Ptak, T. 2005. Monitoring groundwater contamination and delineating source zones at industrial sites: Uncertainty analyses using integral pumping tests. *Journal of Contaminant Hydrology*. 79(3-4) p. 107-134.
- Jawitz, J.W., Fure, A.D., Demmy, G.G., Berglund, S., and Rao, P.S.C. 2005. Groundwater contaminant flux reduction resulting from nonaqueous phase liquid mass reduction. *Water Resources Research*. 41: p. 10408-10423.
- Kao, C.M. and Wang, Y.S. 2001. Field investigation of the natural attenuation and intrinsic biodegradation rates at an underground storage tank site. *Environmental Geology*. 40(4-5): p. 622-631.
- Kauffman, M.E., Keener, W.K., Clingenpeel, S.R., Watwood, M.E., Reeda, D.W., Fujita Y., and Lehman, R.M. 2003. Use of 3-hydroxyphenylacetylene for activity-dependent, fluorescent labeling of bacteria that degrade toluene via 3-methylcatechol. *Journal of Microbiological Methods*. 55(3): p. 801-805.
- Kavanaugh, M. and Kresic, N. 2008. Large urban groundwater basins: Water quality threats and aquifer restoration. In M. Dimkic, H.J. Brauch and M. Kavanaugh (Eds.), *Groundwater Management in Large River Basins* (p. 520-600). London, United Kingdom: IWA Publishing.
- Kaye, A.J., Cho, J., Basu, N.B., Chen, X., Annable, M.D., and Jawitz, J.W. 2008. Laboratory investigation of flux reduction from dense non-aqueous phase liquid (DNAPL) partial source zone remediation by enhanced dissolution. *Journal of Contaminant Hydrology*. 102(1-2): p. 17-28.
- Keener, W.K., Watwood, M.E., and Apel, W.A. 1998. Activity-dependent fluorescent labeling of bacteria that degrade toluene via toluene 2,3-dioxygenase. *Applied Microbiology and Biotechnology*. 49(4): p. 455-462.
- Keener, W.K., Watwood, M. E., Schallera, K. D., Walton, M. R., Partina, J. K., Smith W. A., and Clingenpeel, S. R. 2001. Use of selective inhibitors and chromogenic substrates to differentiate bacteria based on toluene oxygenase activity. *Journal of Microbiological Methods*. 46: p. 171-185.
- King, S.K. 2006. Hydrogeologic Assessment Tools to Determine the Rate of Biodegradation for Organic Contaminants in Groundwater. Science Advisory Board for Contaminated Sites in British Columbia, Canada. Retrieved from <http://www.sabcs.chem.uvic.ca/Decay%20Rates%20Report.pdf>
- King, M.W.G. and Barker, J.F. 1999. Migration and natural fate of a coal tar creosote plume: 1. Overview and plume development. *Journal of Contaminant Hydrology*. 39(3-4): p. 249-279.

- Kong, W. and Nakatsu, C.H. 2009. Optimization of RNA extraction for PCR quantification of aromatic compound degradation genes. *Applied and Environmental Microbiology*. 76(4): p. 1282-1284.
- Kotani, T., Yamamoto, T., Yurimoto, H., Sakai, Y., and Kato, N. 2003. Propane monooxygenase and NAD<sup>+</sup>-dependent secondary alcohol dehydrogenase in propane metabolism by *Gordonia* sp. strain TY-5. *The Journal of Bacteriology*. 185(24): p. 7120-8.
- Krajmalnik-Brown, R., Hölscher, T., Thomson, I.N., Saunders, F.M., Ritalahti, K.M., and Löffler, F.E. 2004. Genetic identification of a putative vinyl chloride reductase in *Dehalococcoides* sp. strain BAV1. *Applied and Environmental Microbiology*. 70(10): p. 6347-6351.
- Kram, M.L., Keller, A.A., Rossabi, J., and Everett, L.G. 2001. DNAPL characterization methods and approaches, Part 1: Performance comparisons. *Ground Water Monitoring and Remediation*. 21(4): p. 109-123.
- Kram, M.L., Keller, A.A., Rossabi, J., and Everett, L.G. 2002. DNAPL characterization methods and approaches, Part 2: Cost comparisons. *Ground Water Monitoring and Remediation*. 22(1): p. 46-61.
- Kubert, M. and Finkel, M. 2006. Contaminant mass discharge estimation in groundwater based on multi-level point measurements: A numerical evaluation of expected errors. *Journal of Contaminant Hydrology*. 84(1-2): p. 55-80.
- Kueper, B.H. and Davies, K.L. 2009. Assessment and Delineation of DNAPL Source Zones at Hazardous Waste Sites. USEPA National Risk Management Research Laboratory, Ground Water Issue. EPA/600/R-09/119. Retrieved from <http://www.epa.gov/nrmrl/pubs/600r09119/600r09119.pdf>
- Landmeyer, J.E., Chapelle, F.H., Herlong, H.H., and Bradley, P.M. 2001. Methyl tert-butyl ether biodegradation by indigenous aquifer microorganisms under natural and artificial oxic conditions. *Environmental Science and Technology*. 35(6): p. 1118-1126.
- Lee, M.H., Clingenpeel, S.C., Leiser, O.P., Wymore, R.A., Sorenson, K.S. Jr., and Watwood, M.E. 2008a. Activity-dependent labeling of oxygenase enzymes in a trichloroethene-contaminated groundwater site. *Environmental Pollution*. 153(1): p. 238-46.
- Lee, P.K.H., Johnson, D.R., Holmes, V.F., He, J., and Alvarez-Cohen, L. 2006. Reductive dehalogenase gene expression as a biomarker for physiological activity of *Dehalococcoides* spp. *Applied and Environmental Microbiology*. 72(9): p. 6161-6168.
- Lee, P.K.H., Macbeth, T.W., Sorenson, K.S., Jr., Deeb, R.A., Alvarez-Cohen, L. 2008b. Quantifying genes and transcripts to assess the in-situ physiology of "*Dehalococcoides*" spp. in a trichloroethene-contaminated groundwater site. *Applied and Environmental Microbiology*. 74(9): p. 2728-2739.

Leeson, A., Hashsham, S., Hazan, T., Tso-Liu, W., Loeffler, F., Lovley, D., Pillai, S., Shepard, A., Steffan, R., Halden, R., Haas, P., Johnson, P., McCarty, P., Stroo, H., Alleman, B., Chandler, D., Cole, J., Edwards, E., Fields, M., Sorenson, K. 2005. SERDP and ESTCP Expert Panel Workshop on Research and Development Needs for the Environmental Remediation Application of Molecular Biological Tools. Retrieved from <http://docs.serdp-estcp.org/viewfile.cfm?Doc=MBT%20Workshop%20Report.pdf>

Li, B.K. and Abriola, L.M. 2009. A multistage multicriteria spatial sampling strategy for estimating contaminant mass discharge and its uncertainty. *Water Resources Research*. 45(W06407). doi:10.1029/2008WR007362

Li, B.K., Goovaerts, P., and Abriola, L.M. 2007. A geostatistical approach for quantification of contaminant mass discharge uncertainty using multilevel samplers. *Water Resources Research*. 43(W06436). doi:10.1029/2006WR005427

Loffler, F.E., Sun, Q., Li, J., and Tiedje, J.M. 2000. 16S rRNA gene-based detection of tetrachloroethene-dechlorinating *Desulfuromonas* and *Dehalococcoides* Species. *Applied and Environmental Microbiology*. 66(4): p. 1369-1374.

Lu, X., Wilson, J.T., and Kampbell, D.H. 2006. Relationship between *Dehalococcoides* DNA in ground water and rates of reductive dechlorination at field scale. *Water Research*. 40: p. 3131-3140.

Luton, P.E., Sun, Q., Li, J., and Tiedje, J.M. 2002. The *mcrA* gene as an alternative to 16S rRNA in the phylogenetic analysis of methanogen populations in landfill. *Microbiology*. 148(11): p. 3521-30.

Macbeth, T.W., Cummings, D. E., Spring, S., Petzke, L.M. and Sorenson, K. S. Jr. 2004. Molecular characterization of a dechlorinating community resulting from in-situ biostimulation in a trichloroethene-contaminated deep, fractured basalt aquifer and comparison to a derivative laboratory culture. *Applied and Environmental Microbiology*. 70(12): p. 7329-7341.

Magnuson, J.K., Stern, R.V., Gossett, J.M., Zinder, S.H., and Burris, D.R. 1998. Reductive dechlorination of tetrachloroethene to ethene by a two-component enzyme pathway. *Applied and Environmental Microbiology*. 64(4): p. 1270-1275.

Malachowsky, K.J., Phelps, T.J., Teboli, A.B., Minnikin, D.E., and White, D.C. 1994. Aerobic mineralization of trichloroethylene, vinyl chloride, and aromatic compounds by *Rhodococcus* species. *Applied and Environmental Microbiology*. 60(2): p. 542-548.

Malcolm Pirnie, Inc. 2004. *Corrective Measures Work Plan for Building 40 Bedrock Groundwater, Main Manufacturing Area, Watervliet Arsenal, Watervliet, New York*. July, 2004.

Malcolm Pirnie, Inc. 2006. Natural attenuation evaluation, North TNT Manufacturing Valley, Volunteer Army Ammunition Plant, Chattanooga, Tennessee. Prepared for the U.S. Army Environmental Center. June.



Malcolm Pirnie, Inc., UC Davis, and Einarson & Associates. 2010. Estimation of Mass Discharge of Groundwater Contaminants: A Controlled Field Comparison of Four Methods at Vandenberg Air Force Base, CA. ESTCP Project Number ER-0318.

Malcolm Pirnie, Inc. and University of Waterloo. 2010. Diagnostic Tools for Performance Evaluation of In Situ Chemical Oxidation of a Chlorinated Solvent Source Area in Fractured Shale. ESTCP Project Number ER-0318.

Marchesi, M., Aravena, R., Otero, N., Soler A., Gil, I., Sra, K.S., Thomson, N.R., and Mancini, S. 2009. Assessment of in-situ chemical oxidation (ISCO) performance for chlorinated solvents contaminated groundwater using stable carbon isotope at laboratory and field scale. *Geophysical Research Abstracts*. 11(EGU 2009-10201-1)

Massman, J. and Freeze, R.A. 1987. Groundwater contamination from waste management sites – the interaction between risk-based engineering design and regulatory policy. *Water Resources Research*. 23: p. 368-80.

Mattes, T.E., Coleman, M., Spain, J., and Gossett, J. 2005. Physiological and molecular genetic analyses of vinyl chloride and ethene biodegradation in *Nocardioides* sp. strain JS614. *Archives of Microbiology*. 183(2): p. 95-106.

Mattes, T., Coleman, N.V, Chuang, A.S, Rogers, A.J, Spain, J.C, and Gossett, J.M. 2007. Mechanism controlling the extended lag period associated with vinyl chloride starvation in *Nocardioides* sp. strain JS614. *Archives of Microbiology*. 187(3): p. 217-226.

McCall, W., Nielsen, D.M., Farrington, S.P., and Christy, T.M. 2006. Use of direct-push technologies in environmental site characterization and ground-water monitoring. In D.M. Nielsen (Ed.), *Practical Handbook of Environmental Site Characterization and Ground-Water Monitoring* (2nd ed.) (p. 345-472). Boca Raton, FL: CRC Press.

McCarty P.L., Goltz, M.N., Hopkins, G.D., Dolan, M.E., Allan, J.P., Kawakami, B.T., and Carrothers, T.J. 1998. Full-scale evaluation of in-situ cometabolic degradation of trichloroethylene in groundwater through toluene injection. *Environmental Science and Technology* 32(1): p. 88–100.

McDade, J.M., McGuire, T.M., Newell C.J. 2005. Analysis of DNAPL source-depletion costs at 36 field sites. *Remediation Journal*. 15(2): p. 9-13.

McDonald, I.R., Holmes, A.J., Kenna, E.M., and Murrell, J.C. 1998. Molecular Methods for the Detection of Methanotrophs. In D. Sheehan (Ed.), *Methods in Biotechnology, Vol. 2: Bioremediation Protocols* (p. 111-126). Totowa, NJ: Humana Press, Inc.

McDonald, I.R., Bodrossy, L., Chen, Y. and Murrell, J.C. 2008. Molecular ecology techniques for the study of aerobic methanotrophs. *Applied and Environmental Microbiology*. 74(5): p. 1305-15.

- McGuire, T.M., McDade, J.M., and Newell, C.J. 2006. Performance of DNAPL source depletion technologies at 59 chlorinated solvent-impacted sites. *Ground Water Monitoring and Remediation*. 26(1): p. 73-84.
- Mercer, J.W., Cohen, R.M., and Noel, M.R. 2010. DNAPL site characterization issues at chlorinated solvent sites. In H.F. Stroo and C.H. Ward (Eds.), *In-situ Remediation of Chlorinated Solvent Plumes* (chapter 8). SERDP and ESTCP Remediation Technology Monograph Series. New York, NY: Springer Science+Business Media.
- Metcalf, M.J. and Robbins, G.A. 2007. Comparison of water quality profiles from shallow monitoring wells and adjacent multilevel samplers. *Ground Water Monitoring & Remediation*. 27(1): p. 84-91.
- Meyer, J.R., Parker, B.L., and Cherry, J.A. 2008. Detailed hydraulic head profiles as essential data for defining hydrogeologic units in layered fractured sedimentary rock. *Environmental Geology*. 56(1): p. 27-44.
- Microseeps, Inc. 2009. CSIA Case Studies: Sites – Questions – Answers. PowerPoint Presentation. Retrieved from [http://www.microseeps.com/pdf/CSIA\\_case\\_studies.pdf](http://www.microseeps.com/pdf/CSIA_case_studies.pdf)
- Miller, A.R., Keener, W.K., Watwood, M.E., and Roberto, F.F. 2002. A rapid fluorescence-based assay for detecting soluble methane monooxygenase. *Applied Microbiology and Biotechnology*. 58(2): p. 183-188.
- Morrill, P.L., Sleep, B.E., Slater, G.F., Edwards, E.A., and Lollar, B.S. 2006. Evaluation of isotopic enrichment factors for the biodegradation of chlorinated ethenes using a parameter estimation model: Toward an improved quantification of biodegradation. *Environmental Science and Technology*. 40(12): p. 3886-3892.
- Morris, R.M., Fung, J.M., Rahm, B.G., Zhang, S., Freedman, D.L., Zinder, S.H., and Richardson, R.E. 2007. Comparative proteomics of *Dehalococcoides* spp. reveals strain-specific peptides associated with activity. *Applied and Environmental Microbiology*. 73(1): p. 320-6.
- Muller, J.A.R., Bettina, M., von Abendroth, G., Meshulam-Simon, G., McCarty, P.L., Spormann, A.M. 2004. Molecular identification of the catabolic vinyl chloride reductase from *Dehalococcoides* sp. strain VS and its environmental distribution. *Applied and Environmental Microbiology*. 70(8): p. 4880-4888.
- National Contingency Plan. 2003. National Oil and Hazardous Substances Pollution Contingency Plan. Title 40 Code of Federal Regulations, Part 300, 7-1-03 ed.
- NRC (National Research Council). 1994. *Alternatives for Ground Water Cleanup*. Washington, DC.: National Academy Press.
- NRC. 1996. *Rock Fractures and Fluid Flow: Contemporary Understanding and Applications*. Washington, DC.: National Academy Press.

- NRC. 2005. *Contaminants in the Subsurface: Source Zone Assessment and Remediation*. Washington, DC.: National Academy Press.
- Newell, C.J. 2008. Personal communication of Murray Einarson with Chuck Newell.
- Newell, C.J., Conner, J.A., and Rowen, D.L. 2003. Groundwater Remediation Strategies Tool. American Petroleum Institute, publication number 4730. Retrieved from [http://www.api.org/ehs/groundwater/upload/4730\\_Final.pdf](http://www.api.org/ehs/groundwater/upload/4730_Final.pdf)
- Nichols, P.D., Smith, G.A., Antworth, C.P., Hanson, R.S., and White, D.C. 1985. Phospholipid and lipopolysaccharide normal and hydroxy fatty acids as potential signatures for methane-oxidizing bacteria. *FEMS Microbiology Letters*, 31(6): p. 327-335.
- Nichols, E.M. and Roth, T. 2004. Flux redux: Using mass flux to improve cleanup decisions. *LUSTline Bulletin*. 46: p. 6-9. Retrieved from <http://icma.org/Documents/Document/Document/2095>
- North Wind, Inc. 2010. Applying Diagnostic Tools for Performance Evaluation of In Situ Bioremediation of a Chlorinated Solvent Source Area. ESTCP Project Number ER-0318.
- Page, J.W.E., Soga, K., and Illangasekare, T.H. 2007. The significance of heterogeneity on mass flux from DNAPL source zones: an experimental investigation. *Journal of Contaminant Hydrology*. 94(3-4): p. 215-234.
- Parker, B.L., Gillham, R.W. and Cherry, J.A. 1994. Diffusive disappearance of immiscible-phase organic liquid in fractured geologic media. *Ground Water*. 32(5): p. 805-820.
- Parker, B.L., McWhorter, D.B., and Cherry, J.A. 1997. Diffusive loss of non-aqueous phase organic solvents from idealized fracture networks in geologic media. *Ground Water*. 35(6): p. 1077-1088.
- Parker, B.L., Cherry, J.A., and Swanson, B.J. 2006. A Multilevel System for High-Resolution Monitoring in Rotasonic Boreholes. *Ground Water Monitoring and Remediation*. 26(4), p. 57-73.
- Parker, B.L. 2007. Investigating contaminated sites on fractured rock using the DFN approach. Proceedings of the 2007 USEPA/NGWA Fractured Rock Conference: State of the Science and Measuring Success in Remediation. Portland, Maine. September 24-26, 2007. p. 150-168.
- Payne, F.C., Quinnan, J.A., and Potter, S.T. 2008. *Remediation Hydraulics*. Boca Raton, FL: CRC Press.
- Piersol, J., Rudolph, D.L., and Einarson, M.D. 2005. Application of a mass flux based approach to assess the impacts of point sources of contamination on water supply wells in Panama. Abstract presented at 2005 NGWA Ground Water Summit. San Antonio, Texas. April 17-20, 2005.

- Pope, D.F., Acree, S., Levine, H., Mangion, S., van Ee, J., Hurt, K., and Wilson, B. 2004. Performance monitoring of MNA remedies for VOCs in ground water. USEPA. EPA/600/R-04/027. Retrieved from <http://www.epa.gov/nrmrl/pubs/600R04027/600R04027.pdf>
- Potter, P.E., Maynard, J.B., and Depetris, P.J. 2005. *Mud and Mudstones: Introduction and Overview*. Berlin, Germany: Springer.
- Poulson, S.R. and Naraoka, H. 2002. Carbon isotope fractionation during permanganate oxidation of chlorinated ethylenes (cDCE, TCE, PCE). *Environmental Science and Technology*. 36(15): p. 3270-3274.
- Price, M and Williams, A T. 1993. The influence of unlined boreholes on groundwater chemistry: a comparative study using pore-water extraction and packer sampling. *Journal of the Institution of Water and Environmental Management*. 7(6): p. 651-659.
- Ptak, T., Schwarz, R., and Teutsch, G. 1998. Groundwater risk assessment at a contaminated site based on integrating and spatially resolving investigations of groundwater pollutant concentrations and fluxes. Proceedings of Sixth International FZK/TNO Conference: Contaminated Soil '98. Edinburgh, United Kingdom. May 17-21, 1998. p. 815-816.
- Rahm, B.G. and Richardson, R.E. 2008. *Dehalococcoides*' gene transcripts as quantitative bioindicators of tetrachloroethene, trichloroethene, and cis-1,2-dichloroethene dehalorespiration rates. *Environmental Science and Technology*. 42(14): p. 5099-105.
- Rahm, B.G., Chauhan, S., Holmes, V.F., Macbeth, T.W., Sorenson, K.S. Jr., and Alvarez-Cohen, L. 2006a. Molecular characterization of microbial populations at two sites with differing reductive dechlorination abilities. *Biodegradation*. 17(6): p. 523-34.
- Rahm, B.G., Morris, R.M., and Richardson, R.E. 2006b. Temporal expression of respiratory genes in an enrichment culture containing *Dehalococcoides* ethenogenes. *Applied and Environmental Microbiology*. 72(8): p. 5486-91.
- Rao, P.S., Jawitz, J.W., Enfield, C.G., Falta, R.W., Annable, M.D., and Wood, L.A. 2001. Technology integration for contaminated site remediation: Cleanup goals & performance criteria. Paper presented at Groundwater Quality 2001 Conference. Sheffield, United Kingdom. June 2001.
- Raskin, L., Stromley, J.M., Rittmann, B.E. and Stahl, D.A. 1994a. Group-specific 16S rRNA hybridization probes to describe natural communities of methanogens. *Applied and Environmental Microbiology*. 60(4): p. 1232-40.
- Raskin, L., Poulsen, L.K., Noguera, D.R., Rittmann B.E., and Stahl, D.A. 1994b. Quantification of methanogenic groups in anaerobic biological reactors by oligonucleotide probe hybridization. *Applied and Environmental Microbiology*. 60(4): p. 1241-8.
- Reichard, E.G. and Evans, J.S. 1989. Assessing the value of hydrogeologic information for risk-based remedial action decisions. *Water Resources Research*. 25: p. 1451-60.

- Reilly, T.E., O.L. Franke, and Bennett, G.D. 1989. Bias in groundwater samples caused by wellbore flow. *Journal of Hydrologic Engineering*. 115: p. 270-276.
- Rein, A., Bauer, S., Dietrich, P., and Beyer, C. 2009. Influence of temporally variable groundwater flow conditions on point measurements and contaminant mass flux estimations. *Journal of Contaminant Hydrology*. 108(3-4): p. 118-133.
- Reinhard, M., Goodman, N.L., and Barker, J.F. 1984. Occurrence and distribution of organic chemicals in two landfill leachate plumes. *Environmental Science and Technology*. 18(12): p. 953-961.
- Richardson, R.E., Bhupathiraju, V.K., Song, D.L., Goulet, T.A., and Alvarez-Cohen, L. 2002. Phylogenetic characterization of microbial communities that reductively dechlorinate TCE based upon a combination of molecular techniques. *Environmental Science and Technology*. 36(12): p. 2652-62.
- Ritalahti, K.M., Amos, B.K., Sung, Y., Wu, Q., Koenigsberg, S.S., and Löffler, F.E. 2006. Quantitative PCR targeting 16S rRNA and reductive dehalogenase genes simultaneously monitors multiple *Dehalococcoides* strains. *Applied and Environmental Microbiology*. 72(4): p. 2765-2774.
- Robbins, G.A. 1989. Influence of purged and partially penetrating monitoring wells on contaminant detection, mapping, and modeling. *Ground Water*. 27(2): p. 155-162.
- Robertson, W.D., Cherry, J.A. and Sudicky, E.A. 1991. Ground-water contamination from two small septic systems on sand aquifers. *Ground Water*. 29(1): p. 82-92.
- Roden, E.E. and Zachara, J.M. 1996. Microbial reduction of crystalline iron(III) oxides: Influence of oxide surface area and potential for cell growth. *Environmental Science and Technology*. 30(5): p. 1618-1628.
- Rossetti, S., Aulenta, F., Majone, M., Crocetti, G., and Tandoi, V. 2008. Structure analysis and performance of a microbial community from a contaminated aquifer involved in the complete reductive dechlorination of 1,1,2,2-tetrachloroethane to ethene. *Biotechnology and Bioengineering*. 100(2): p. 240-9.
- Roth, T., Nichols, E.M., Martin, S. and Kuhnel, V. 2004. MtBE mass flux estimates as an indicator of regulatory compliance. Paper presented at 2004 NGWA Conference on MtBE and perchlorate: Assessment and remediation, June 3-4, Costa Mesa, California.
- Rothauwe, J.H., Witzel, K.P., and Liesack, W. 1997. The ammonia monooxygenase structural gene amoA as a functional marker: molecular fine-scale analysis of natural ammonia-oxidizing populations. *Applied and Environmental Microbiology*. 63(12): p. 4704-12.
- RTDF. 1998. Remediation Technologies Development Forum In Situ Flushing Action Team. Summary of the RDTF Flushing Action Team Meeting. Irving, Texas. September 14-15.

- Russell, K.T. and Rabideau, A.J. 2000. Decision analysis for pump-and-treat design. *Ground Water Monitoring and Remediation*. 20(3): p. 159-168.
- Sale, T., Newell, C., Stroo, H., Hinchee, R., and Johnson, P. 2008. Frequently Asked Questions Regarding Management of Chlorinated Solvents in Soils and Groundwater. ESTCP. Retrieved from <http://www.estcp.org/Technology/upload/ER-0530-FAQ.pdf>
- Sara, M.N. 2003. *Site Assessment and Remediation Handbook* (2nd ed.). Boca Raton, FL: Lewis Publishers, CRC Press.
- Semprini, L., Kitanidis, P.K., Kampbell, D.H., and Wilson, J.T. 1995. Anaerobic transformation of chlorinated aliphatic hydrocarbons in a sand aquifer based on spatial chemical distributions. *Water Resources Research*. 31(4): p. 1051-1062.
- Simeonova, D.D., Susnea, I., Moise, A., Schink, B., and Przybylski, M. 2009. "Unknown genome" proteomics: a new NADP-dependent epimerase/dehydratase revealed by N-terminal sequencing, inverted PCR, and high resolution mass spectrometry. *Molecular and Cellular Proteomics*. 8(1): p. 122-31.
- Sluis, M.K., Sayavedra-Soto, L.A., and Arp, D.J. 2002. Molecular analysis of the soluble butane monooxygenase from *Pseudomonas butanovora*. *Microbiology*. 148(11): p. 3617-29.
- Song, D.L., Conrad, M.E., Sorenson, K.S., and Alvarez-Cohen, L. 2002. Stable carbon isotope fractionation during enhanced in-situ bioremediation of trichloroethene. *Environmental Science and Technology*. 36(10): p. 2262-2268.
- Sorenson, K.S., Peterson, L.N., Hinchee, R.E., Ely, R.L. 2000. An evaluation of aerobic trichloroethene attenuation using first-order rate estimation. *Bioremediation Journal*. 4(4): p. 337-357.
- Steinberg, L.M. and Regan, J.M. 2008. Phylogenetic comparison of the methanogenic communities from an acidic, oligotrophic fen and an anaerobic digester treating municipal wastewater sludge. *Applied and Environmental Microbiology*. 74(21): p. 6663-6671.
- Steinberg, L.M. and Regan, J.M. 2009. *mcrA*-targeted real-time quantitative PCR method to examine methanogen communities. *Applied and Environmental Microbiology*. 75(13): p. 4435-4442.
- Sterling, S.N., Parker, B.L., Cherry, J.A., Williams, J.H., Lane J.W. Jr., Haeni, F.P. 2005. Vertical cross contamination of trichloroethylene in a borehole in fractured sandstone. *Ground Water*. 43(4): p. 557-573.
- Stroo, H.F., Unger, M., Ward, C.H., Kavanaugh, M.C., Vogel, C., Leeson, A., Marqusee, J.A., and Smith B.P. 2003. Remediating chlorinated solvent source zones. *Environmental Science and Technology*. 37(11): p. 224A-230A.

Stroo, H.F., Leeson, A., Shepard, A.J., Koenigsberg, S.S., and Casey C.C. 2006. Monitored natural attenuation forum: Environmental remediation applications of molecular biological tools. *Remediation Journal*. 16(2): p. 125-137.

Stroo, H.F. and Ward, C.H. (Eds.). 2010. *In-situ Remediation of Chlorinated Solvent Plumes*. SERDP and ESTCP Remediation Technology Monograph Series. New York, NY: Springer Science+Business Media.

Suchomel, E.J. and Pennell, K.D. 2006. Reductions in contaminant mass discharge following partial mass removal from DNAPL source zones. *Environmental Science and Technology*. 40: p.6110-6116.

Sueker, J.K. 2001. Isotope applications in environmental investigations: Theory and use in chlorinated solvent and petroleum hydrocarbon studies. *Remediation Journal*. 12(1): p. 5-24.

Thomson, N.R., Hood, E.D., and Farquhar, G.J. 2007. Permanganate treatment of an emplaced DNAPL source. *Ground Water Monitoring and Remediation*. 27(4): p. 74-85

Thomson, N.R., Fraser, M.J., Lamarche, C., Barker, J.F., and Forsey, S.P. 2008. Rebound of a coal tar creosote plume following partial source zone treatment with permanganate. *Journal of Contaminant Hydrology*. 102(1-2): p. 154-171.

Thuma, J., Hihshalwood, G., Kremesec, V. and Kolhatkar, R. 2001. Application of ground water fate and transport models to evaluate contaminant mass flux and remedial options for an MTBE plume on Long Island, NY. Proceedings of the Petroleum Hydrocarbons and Organic Chemicals in Ground Water, Prevention, Detection and Remediation. National Groundwater Association, Houston, Texas.

United States Environmental Protection Agency (USEPA). 1998. Seminars: Monitored Natural Attenuation for Ground Water. Retrieved from <http://www.epa.gov/nrmrl/pubs/625k98001/625k98001.pdf>

USEPA. 1999. Use of Monitored Natural Attenuation at Superfund, RCRA Corrective Action, and Underground Storage Tank Sites. Office of Solid Waste and Emergency Response. Directive Number 9200.4-17P. April 1999.

USEPA. 2003. The DNAPL Remediation Challenge: Is There a Case for Source Depletion. EPA/600/R-03/143. Retrieved from <http://www.siremlab.com/pdf/Is-there-a-case-for-DNAPL.pdf>

USEPA. 2004a. Cleaning Up the Nation's Waste Sites: Markets and Technology Trends. EPA 542-R-04-015. Retrieved from <http://www.clu-in.org/download/market/2004market.pdf>

USEPA. 2004b. Site Characterization Technologies for DNAPL Investigations. EPA 542-R-04-017. Retrieved from <http://www.epa.gov/tio/download/char/542r04017.pdf>

USEPA. 2005. Groundwater Sampling and Monitoring with Direct Push Technologies. OSWER. EPA 540/R-04/005. Retrieved from <http://www.cluin.org/download/char/540r04005.pdf>

USEPA. 2008. Hunkeler, D., Meckenstock, R.U., Sherwood Loller, B., Schmidt, T.C., and Wilson, J.T. A Guide for Assessing Biodegradation and Source Identification of Organic Ground Water Contaminants using Compound Specific Isotope Analysis (CSIA). EPA 600/R-08/148. Retrieved from <http://www.epa.gov/nrmrl/pubs/600r08148/600r08148.pdf>

USEPA. 2009a. Amendment to the Record of Decision for the Commencement Bay – South Tacoma Channel Superfund Site, Operable Unit #1, Well 12A, Tacoma, Washington. Prepared by USEPA Region 10, October.

USEPA. 2009b. Summary of Key Existing EPA CERCLA Policies for Groundwater Restoration. OSWER Directive 9283.1-33. Office of Solid Waste and Emergency Response. June 26, 2009.

USEPA. 2010a. Contaminated Site Clean-up Information. Retrieved from <http://www.clu-in.org/>

USEPA, 2010b. Software and tools. Mass flux toolkit. Available online August 2010 at [www.clu- http://www.clu-in.org/software/](http://www.clu-in.org/software/)

UW GmbH. 2010. Integrated concept for groundwater remediation (INCORE). Available online at [www.umweltwirtschaft-uw.de/incore/index.htm](http://www.umweltwirtschaft-uw.de/incore/index.htm).

van Breukelen. 2007. Quantifying the degradation and dilution contribution to natural attenuation of contaminants by means of an open system Rayleigh equation. *Environmental Science and Technology*. 41(14): p. 4980 – 4985.

van Breukelen, B.M., Hunkeler, D., and Volkering, F. 2005. Quantification of sequential chlorinated ethane degradation by use of a reactive transport model incorporating isotope fractionation. *Environmental Science and Technology*. 39(11): p. 4189-4197.

van der Kamp, G., Luba, L.D., Cherry, J.A. and Maathuis, H. 1994. Field study of a long and very narrow contaminant plume. *Ground Water*. 32(6): p. 1008-1016.

van der Zaan, B., Hannes, F., Hoekstra, N., Rijnaarts, H., de Vos, W.M., Smidt, H., and Gerritse, J. 2010. Correlation of *Dehalococcoides* 16S rRNA and chloroethene-reductive dehalogenase genes with geochemical conditions in chloroethene-contaminated groundwater. *Applied and Environmental Microbiology*. 76: 843-850

van Dijk, G. 2005. Bentonite usage hits new ground. *GeoDrilling International*, Nov. 2005, pp. 36-39.

Vannelli, T., Logan, M., Arciero, D.M. and Hooper, A.B. 1990. Degradation of halogenated aliphatic compounds by the ammonia-oxidizing bacterium *Nitrosomonas europaea*. *Applied and Environmental Microbiology*. 56(4): p. 1169-1171.

Wackett, L.P. and Householder, S.R. 1989. Toxicity of trichloroethylene to *Pseudomonas putida* F1 is mediated by toluene dioxygenase. *Applied and Environmental Microbiology*. 55(10): p. 2723-2725.



- Wackett, L.P., Brusseau, G.A., Householder, S.R., and Hanson, R.S. 1989. Survey of microbial oxygenases: trichloroethylene degradation by propane-oxidizing bacteria. *Applied and Environmental Microbiology*. 55(11): p. 2960-4.
- Werner, J.J., Ptak, A.C., Rahm, B.G., Zhang, S., and Richardson, R.E. 2009. Absolute quantification of *Dehalococcoides* proteins: enzyme bioindicators of chlorinated ethene dehalorespiration. *Environmental Microbiology*. 11(10): p. 2687-97.
- Westbay Instruments, Inc. 1992-1994, Multilevel Groundwater Monitoring with the MP system.
- Wheeldon, J.G., III. 2008. An Evaluation and Implementation Guide for Current Groundwater Mass Flux Measurement Practices. MS thesis. Air Force Institute of Technology, Graduate School of Engineering and Management.
- Wilson, J.T., Cho, J.S., Wilson, B.H., and Vardy, J.A. 2000. "Natural Attenuation of MtBE in the Subsurface Under Methanogenic Conditions", EPA Report EPA/600/R-00/006. Cincinnati, Ohio, U.S. EPA.
- Wilson, R.D., Yip, W.C., and Naas, C.N. 2008. Assessing performance of a permeable biobarrier. *Water Management*. 161(6): p. 375-379.
- Wymore, R.A., Lee, M.H., Keener, W.K., Miller, A.R., Colwell, F.S., Watwood, M.E., and Sorenson, K.S. Jr. 2007. Field evidence for intrinsic aerobic chlorinated ethene cometabolism by methanotrophs expressing soluble methane monooxygenase. *Bioremediation Journal*. 11(3): p. 125 - 139.
- Yang, Y., Pesaro, M., Sigler, W., and Zeyer, J. 2005. Identification of microorganisms involved in reductive dehalogenation of chlorinated ethenes in an anaerobic microbial community. *Water Research*. 39(16): p. 3954-66.
- Yang, Y. and Zeyer, J. 2003. Specific detection of *Dehalococcoides* species by fluorescence in-situ hybridization with 16S rRNA-targeted oligonucleotide probes. *Applied and Environmental Microbiology*. 69(5): p. 2879-2883.
- Yokota, F. and Thompson, K. 2004. Value of Information Literature Analysis: A Review of Applications in Health Risk Assessment. *Medical Decision Making*. 24(3): p. 287-298.
- Yoon, H. 2006. Validation of Methods to Measure Mass Flux of a Groundwater Contaminant. MS thesis. Air Force Institute of Technology, Graduate School of Engineering and Management.
- Yu, Y., Lee, C., and Hwang, S. 2005. Analysis of community structures in anaerobic processes using a quantitative real-time PCR method. *Water Science and Technology*. 52(1-2): p. 85-91.

## APPENDIX A. POINTS OF CONTACT

POINT OF CONTACT Name	ORGANIZATION Name Address	Phone Fax E-mail
Michael Kavanaugh	Malcolm Pirnie, Inc. Geosyntec Consultants 475 14th St., Suite 400 Oakland, CA 94612	P: 510-285-2766 F: 510.836.3036 <a href="mailto:mkavanaugh@geosyntec.com">mkavanaugh@geosyntec.com</a>
Rula Deeb	ARCADIS Malcolm Pirnie 2000 Powell Street, 7 <sup>th</sup> Floor Emeryville, CA 94608	P: 510-596-9596 F: 510.652.4906 <a href="mailto:rdeeb@pirnie.com">rdeeb@pirnie.com</a> <a href="mailto:rula.deeb@arcadis-us.com">rula.deeb@arcadis-us.com</a>
Lisa Alvarez-Cohen	Civil and Environmental Engineering Department University of California 631 Davis Hall, MC 1710 Berkeley, CA 94720-1710	P: 510-643-5969 F: 510-642-7483 <a href="mailto:alvarez@ce.berkeley.edu">alvarez@ce.berkeley.edu</a>
Michael Annable	University of Florida 217 AP Black Hall PO BOX 116450 Gainesville, FL 32611-6450	P: 352-392-3294 F: 325-392-3076 <a href="mailto:manna@eng.ufl.edu">manna@eng.ufl.edu</a>
John Cherry	Department of Earth Sciences University of Waterloo Waterloo ON N2L 3G1 Canada	P: 519-888-4516 F: 516-883-0220 <a href="mailto:cherryja@uwaterloo.ca">cherryja@uwaterloo.ca</a>
Murray Einarson	AMEC Geomatrix 2101 Webster Street, 12 <sup>th</sup> Fl. Oakland, CA 94612	P: 510-663-4209 <a href="mailto:Murray.Einarson@amec.com">Murray.Einarson@amec.com</a>
Ken Goldstein	The Louis Berger Group 565 Taxter Road, Suite 510 Elmsford, NY 10523	P: 914-592-1734 F: 914-798-3714 <a href="mailto:kgoldstein@louisberger.com">kgoldstein@louisberger.com</a>
Mark Goltz	Department of Systems and Engineering Management Air Force Institute of Technology 2950 Hobson Way Wright Patterson AFB, OH 45433-7765	P: 937-255-3636, x4638 F: 937-656-4699 <a href="mailto:Mark.Goltz@afit.edu">Mark.Goltz@afit.edu</a>
Kirk Hatfield	Department of Civil and Coastal Engineering University of Florida P.O. Box 116580 Gainesville, FL 32611-6580	P: 352-392-3795, x1401 F: 352-392-3394 <a href="mailto:khaf@ce.ufl.edu">khaf@ce.ufl.edu</a>
Douglas Mackay	Department of Land, Air & Water Resources University of California, Davis Davis, CA 95616	P: 650-324-2809 F: 650-618-1571 <a href="mailto:dmmackay@ucdavis.edu">dmmackay@ucdavis.edu</a>
Tamzen Macbeth	Camp Dresser & McKee, Inc. 50 West 14th Street Suite 200 Helena, MT 59601	P: 208-569-5147 F: 208-904-0238 <a href="mailto:macbethw@cdm.com">macbethw@cdm.com</a>
Daria Navon	ARCADIS Malcolm Pirnie 1300 East 8th Avenue Suite F100 Tampa, FL 33605	P: 813-248-6900 F: 813-248-8085 <a href="mailto:dnavon@pirnie.com">dnavon@pirnie.com</a> <a href="mailto:daria.navon@arcadis-us.com">daria.navon@arcadis-us.com</a>

<b>POINT OF CONTACT Name</b>	<b>ORGANIZATION Name Address</b>	<b>Phone Fax E-mail</b>
Beth Parker	University of Guelph 39 Edwin Street Guelph, Ontario, Canada N1H 2E1	P: 519-824-4120 F: 519-836-0227 <a href="mailto:bparker@uoguelph.ca">bparker@uoguelph.ca</a>
Suresh Rao	Purdue University School of Civil Engineering 1284 Civil Engineering Bldg. West Lafayette, Indiana 47907-1284	P: 765-496-6554 <a href="mailto:pscr@ecn.purdue.edu">pscr@ecn.purdue.edu</a>
Kent Sorenson	Camp Dresser & McKee, Inc. 1331 17th Street, Suite 1200 Denver, CO 80202	P: 303-383-2430 F: 303-293-8236 <a href="mailto:sorensonks@cdm.com">sorensonks@cdm.com</a>
Andrew Vitolins	Malcolm Pirnie, Inc. 15 Cornell Road Clifton Park, NY 12065	P: 518-250-7359 <a href="mailto:avitolins@pirnie.com">avitolins@pirnie.com</a>

## APPENDIX B. PRODUCT VENDORS

PRODUCT	VENDOR	CONTACT
Groundwater FLUTE™	Flexible Liner Underground Technologies, LLC	<a href="http://www.flut.com/about.html">http://www.flut.com/about.html</a>
CMT® System	Solinst Canada	<a href="http://www.solinst.com/Prod/403/403.html">http://www.solinst.com/Prod/403/403.html</a>
Waterloo System	Solinst Canada	<a href="http://www.solinst.com/Prod/401/401d1.html">http://www.solinst.com/Prod/401/401d1.html</a>
Westbay System	Schlumberger Water Services	<a href="http://www.slb.com/services/additional/water/monitoring/multilevel_well_system.aspx">http://www.slb.com/services/additional/water/monitoring/multilevel_well_system.aspx</a>
ZIST™ System	BESST Inc.	<a href="http://www.besstinc.com/">http://www.besstinc.com/</a>
COREDFN™ (Characterization of Rock Environments – Discrete Fracture Network Approach)	Stone Environmental, Inc.	<a href="http://bio.stone-env.com/profiling/index.php">http://bio.stone-env.com/profiling/index.php</a>
Passive Flux Meter	Enviroflux, LLC	<a href="http://www.enviroflux.com">www.enviroflux.com</a>
Compound Specific Isotope Analysis	Microseeps	<a href="http://www.microseeps.com/html/specialty.html">http://www.microseeps.com/html/specialty.html</a>
PLFA	Microbial Insights, Inc.	<a href="http://www.microbe.com/services.html">http://www.microbe.com/services.html</a>
qPCR	Microbial Insights, Inc.	<a href="http://www.microbe.com/services.html">http://www.microbe.com/services.html</a>
qPCR	SiREM	<a href="http://www.siremlab.com/moleculargeneticsvc.html">http://www.siremlab.com/moleculargeneticsvc.html</a>
SIP	Microbial Insights, Inc.	<a href="http://www.microbe.com/services.html">http://www.microbe.com/services.html</a>
DGGE	Microbial Insights, Inc.	<a href="http://www.microbe.com/services.html">http://www.microbe.com/services.html</a>

## APPENDIX C. OVERVIEW OF IMPORTANT BIOLOGICAL REMEDIATION PROCESSES

In order to understand the utility of MBTs, a basic understanding of biological processes that are being monitored is necessary to provide context to the discussion. Therefore, a brief overview of biological processes, including biodegradation mechanisms and water quality impacts associated with bioremediation of chlorinated solvent contaminants, is provided. Other references (e.g., Stroo and Ward, in press) provide greater detail.

### Contaminant Biodegradation

Numerous mechanisms have been described for chlorinated solvent biodegradation, although the feasibility, rate, and extent of each is highly variable, and depend on prevailing geochemical conditions within the environment and type of chlorinated compound(s) present. Generally, four broad categories can be defined based on evidence for the mechanism: 1) aerobic oxidation, 2) aerobic cometabolism, 3) halorespiration and 4) anaerobic cometabolism. Each of these is discussed individually below.

#### *Aerobic oxidation*

Microorganisms obtain energy for growth and maintenance through coupled oxidation-reduction reactions involving the transfer of electrons from an electron donor to an electron acceptor (AFCEE, 2004; He et al., 2007). Organic contaminants can be transformed via normal catabolic pathways (i.e., aerobic oxidation) in microorganisms based on their suitability as growth substrates. Highly chlorinated compounds (e.g., PCE) are highly oxidized, and thus cannot be utilized by microorganisms as a food source in energy-yielding, biological reactions; this makes traditional aerobic growth-linked bioremediation infeasible. As a result, higher-chlorinated ethenes, such as PCE and TCE, have historically been considered recalcitrant in aerobic aquifers.

Substantial evidence exists for aerobic oxidation of less-chlorinated ethenes, however, such as VC and, to a lesser extent, cis-1,2-DCE. Bacteria demonstrated to assimilate VC directly in energy-yielding aerobic reactions include various *Mycobacterium* spp. (Coleman and Spain, 2003; Hartmans and De Bont, 1992), *Norcardioides* sp. strain JS614 (Coleman et al., 2002b), *Pseudomonas* sp. strain DL1 (Verge et al., 2001), *Pseudomonas aeruginosa* strain MF1 (Verge et al., 2000), *Pseudomonas putida* strain AJ, *Ochrobactrum* sp. strain TD (Danko et al., 2004), and *Ralstonia* sp. strain TRW-1 (Elango et al., 2006). All of these bacteria, except *Ralstonia*, have been demonstrated to facilitate VC oxidation through involvement of alkene monooxygenase and epoxyalkane:coenzyme M transferase, for which the encoding genes are located on a plasmid, and molecular tools have been developed to target these genes (Coleman et al., 2002b; Mattes et al., 2007; Mattes et al., 2005). The only known bacterium demonstrated to oxidize cis-1,2-DCE aerobically in an energy-yielding reaction is *Polaromonas* sp. strain JS666 (Coleman et al., 2002a).

### ***Aerobic cometabolism***

Although direct aerobic oxidation of higher chlorinated ethenes does not occur, aerobic mechanisms exist through which contaminant attenuation has been demonstrated. Many aerobic microorganisms cometabolize highly oxidized solvents (e.g., TCE) through fortuitous transformation by enzymes that target other primary substrates. Cometabolism requires the presence of substrates that induce the enzymes for transformation of contaminants to occur. In addition, contaminant transformation is a competitive process with the primary function of the enzyme; thus, the organism does not benefit, and is sometimes harmed, by the cometabolic reaction. A variety of bacteria can cometabolically degrade TCE, cis-DCE, trans-DCE, and VC via oxygenase-catalyzed reactions, including bacteria that oxidize ammonia, methane, benzene, propane, butane, or toluene as natural growth substrates (Anderson and McCarthy, 1997; Arp et al., 2001; Henrysson and McCarthy, 1993; Alvarez-Cohen and Speitel, 2001; Alvarez-Cohen et al., 1992). Cometabolic oxidation has been considered a potential mechanism contributing to the natural attenuation of chlorinated ethenes in aerobic subsurface environments and may be of substantial importance in contributing to MNA at contaminated groundwater sites (Lee et al., 2008a; Wymore et al., 2007; Sorenson et al., 2000). In addition, bioremediation strategies focused on stimulating these mechanisms have also been demonstrated (Semprini, 1997), although active bioremediation strategies have largely shifted to focus on halorespiration, due largely to easier implementation.

### ***Halorespiration***

To date, the most common engineered approach for bioremediation of chlorinated solvents has focused on anaerobic reductive dechlorination, also termed chlororespiration or halorespiration, a process wherein anaerobic microorganisms use chlorinated solvents as metabolic electron acceptors for energy generation (Maymo-Gatell et al., 1997; Holliger et al., 1999; Löffler et al., 1999). This process is a strictly anaerobic process in which the chlorine atoms are sequentially removed, as electrons and hydrogen are added, resulting in production of lesser-chlorinated and non-chlorinated daughter products (e.g., TCE is sequentially reduced to cis-DCE, VC, and ultimately ethene).

Several microorganisms capable of halorespiration have been isolated from contaminated and pristine sites. These populations are generally strict anaerobes and can be separated into two groups. The first are those capable of reductive dechlorination of PCE or TCE to cis-DCE, including a number of phylogenetic groups such as *Desulfuromonas* sp. strain BB1, *Desulfuromonas chloroethenica*, *Sulfurospirillum multivorans*, *Dehalobacter restrictus* strains PER-K23A and TEA, *Enterobacter* sp. Strain MS1, and *Desulfitobacterium* sp. strain PCE-S (Holliger et al., 1999). Hydrogen is generally an electron donor for these organisms, except for *Desulfuromonas* sp. strain BB1 and *Desulfuromonas chloroethenica*, which require acetate to support reductive dechlorination of TCE. The second group is capable of complete reductive dechlorination of TCE to ethene, and only includes the obligatory hydrogenotrophic genus *Dehalococcoides* (Sung et al., 2006; Cupples et al., 2003; He et al., 2003; Maymo-Gatell et al., 1999). In addition, the presence of this genus *Dehalococcoides* has been linked to the ability to perform complete dechlorination at chloroethene-contaminated field sites (Hendrickson et al., 2002). Therefore, bioremediation strategies increasingly target *Dehalococcoides* for

growth and activity through biostimulation or bioaugmentation (Rahm et al., 2006a; Major et al., 2002; Macbeth et al., 2004).

Different strains of *Dehalococcoides*, however, vary in their capacity for reductive dechlorination. For instance, *Dehalococcoides ethenogenes* strain 195 reduces TCE, cis-DCE, 1,1-DCE, 1,2-DCA, various chlorinated benzenes, phenols, dioxins, naphthalenes, biphenyls (Maymo-Gatell et al., 1997; Fennell et al., 2004), and VC in energy-yielding reactions, but only reduces VC to ethene in a cometabolic reaction, which may result in VC accumulation in the field (Maymo-Gatell et al., 1997; Magnuson et al., 1998). *Dehalococcoides* strain CBDB1 degrades chlorobenzene, dibenzo-p-dioxins, and chlorophenol (Adrian et al., 2007; Bunge and Lechner, 2009), but does not degrade chlorinated ethenes. *Dehalococcoides* strain VS reduces cis-DCE and VC (Cupples et al., 2003; Muller et al., 2004), and strain GT degrades TCE, cis-DCE, and VC (Sung et al., 2006). Finally, *Dehalococcoides* strain BAV1 reduces cis-DCE, trans-1,2-DCE, 1,1-DCE, vinyl bromide, 1,2-DCA, and VC to ethane (Krajmalnik-Brown et al., 2004; He et al., 2003). Therefore, while *Dehalococcoides* spp. are often evaluated as indicator species for the potential for reductive degradation of chlorinated solvents, the presence or absence of different strains dictates the type and extent of dechlorination reactions that might occur.

### ***Anaerobic cometabolism***

Anaerobic cometabolism of less chlorinated ethenes, such as cis-DCE and VC, can occur during either halorespiration, or by enzymes active during other anaerobic processes. An example of the first case is the cometabolism of VC by *Dehalococcoides ethenogenes* strain 195 (Maymo-Gatell et al., 1999). Although anaerobic cometabolism occurs, it can be difficult to distinguish from other mechanisms, such as halorespiration, using groundwater contaminant and geochemistry data.

### **Secondary Biological Processes**

Important biological processes that contribute to an environment that is conducive to efficient anaerobic biodegradation of chlorinated solvents also contribute to secondary water quality impacts in groundwater systems. These processes include hydrolysis, fermentation, acetogenesis, sulfate reduction, metal reduction, and methanogenesis. For example, Figure C-1 provides an illustration of the many processes occurring in a hypothetical TCE-dechlorinating consortium. A brief overview of key concepts is provided following the figure, including descriptions of important biological processes and descriptions of some of the microbial populations of interest. For the sake of brevity, only detailed assessments of microbial communities using community-level MBT assays and those specifically targeting methanogens will be discussed in subsequent sections, and more detailed evaluations of fermentation, sulfate-reducing, and metal-reducing MBT targets are not provided here.

**Figure C-1. Overview of Significant Biological Processes Occurring during Anaerobic Bioremediation of Chlorinated Solvents.**

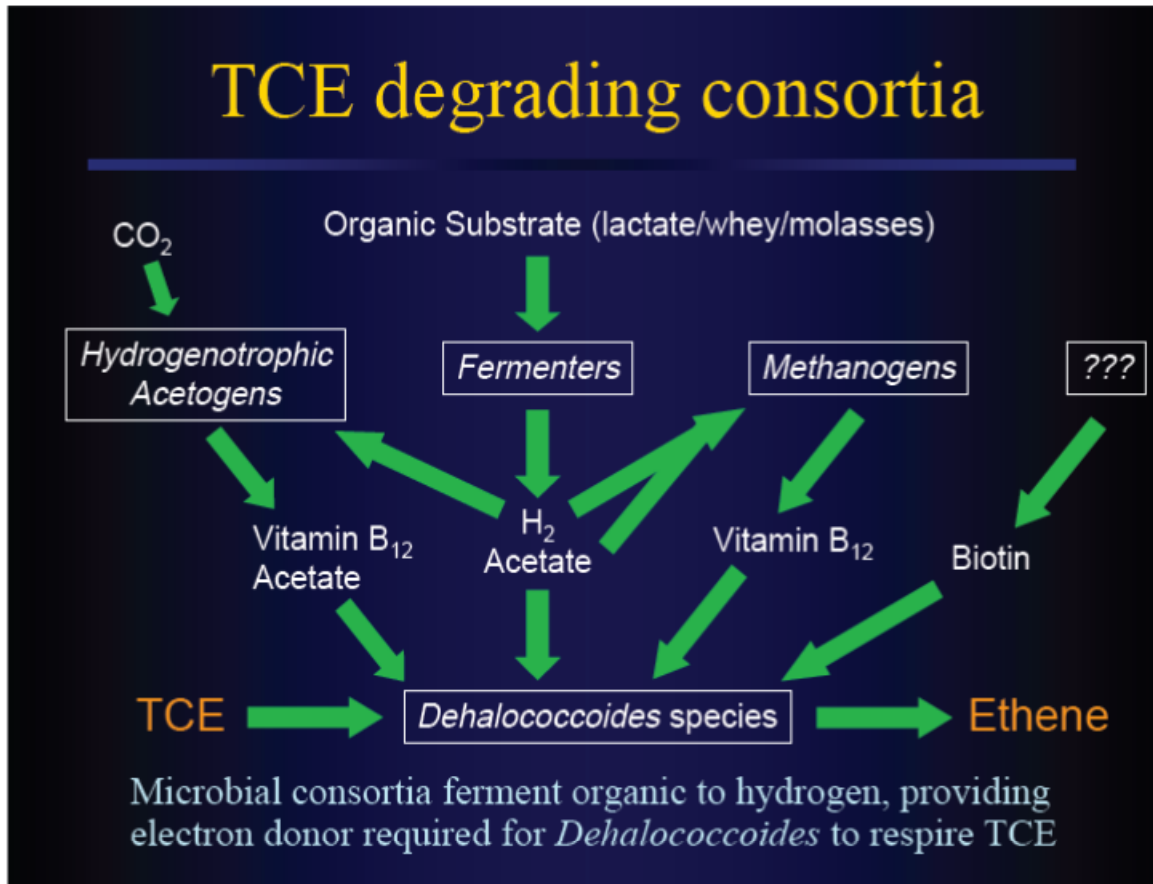

**Anaerobic substrate utilization**

The addition of bioremediation amendments stimulates a variety of anaerobic metabolic processes once oxygen has been depleted. These processes include oxidation of primary substrates (e.g., lactate, lactose, glucose) coupled to nitrate, sulfate, and metal reduction; fermentation; and acetogenesis. Anaerobic fermentation of complex carbohydrates and sugars is often one of the first utilization steps, especially for complex amendments (e.g., molasses, whey, vegetable oil), and generally yields hydrogen and volatile fatty acids (VFAs), such as propionate, butyrate, and acetate, which can themselves be used as electron donor substrates.

Most halorespiring bacteria actually utilize either hydrogen or acetate as the electron donor coupled to reductive dechlorination (Holliger et al., 1999). In addition, homoacetogenic bacteria (i.e., acetate-producing bacteria) can oxidize substrates, such as lactate, propionate, and butyrate, to acetate. They can also oxidize hydrogen, and coupled with carbon dioxide reduction, produce acetate (Mackie and Bryant, 1994; Drake, 1994). A variety of homoacetogenic bacteria have been identified as important members of



reductive-dechlorinating laboratory (Duhamel and Edwards, 2007; Duhamel and Edwards, 2006; He et al., 2007) and field consortia (Macbeth et al., 2004; Dojka et al., 1998). The potential effect of homoacetogenesis on dechlorination is complex. Under certain conditions, homoacetogens compete with dechlorinating bacteria for available hydrogen, and this competition is dictated by the amount of energy that can be obtained from the reaction for metabolism (Duhamel and Edwards, 2007).

In most natural anaerobic environments, the conditions are generally energetically unfavorable for hydrogenotrophic acetogenesis (i.e., hydrogen-based acetate production), especially in the presence of hydrogenotrophic methanogens and dechlorinators. The latter two metabolisms yield more free energy from hydrogen oxidation and have much lower hydrogen thresholds than do acetogenic reactions (Löffler et al., 1999; Fennell and Gossett, 1998). Nevertheless, the generation of vitamin-B12-based complexes in homoacetogens has been implicated as a source of this important nutrient for *Dehalococcoides* spp. in mixed cultures and in the field (He et al., 2007; Macbeth et al., 2004), in addition to production of acetate, which is used as a carbon source for *Dehalococcoides* (He et al., 2002). The mode of methanogenesis (discussed in more detail in the next section) can also have implications for the efficiency of dechlorination with respect to electron donor utilization. Therefore, understanding the microbial populations that are (or are not) supporting an environment conducive to reductive dechlorination might be important for implementing and optimizing bioremediation systems.

Anaerobic biological processes that react with metals in soils also contribute to overall contaminant remediation (Szecsody et al., 2004) and water quality issues associated with dissolution of metals from the geologic formation during and post-bioremediation. Subsurface bioremediation efforts are highly influenced by both aqueous geochemical properties (e.g., pH, ions present, oxidation potential) and soil types and constituents (e.g., clays, iron (Fe) /manganese (Mn) oxides, organic matter) (Szecsody et al., 2004). For example, dissimilatory iron-reducing bacteria couple oxidation of natural or amended substrates to the reduction of amorphous and crystalline Fe(III) oxides and structural iron to dissolved, ferrous Fe(II) (Urrutia et al., 1999; Roden and Zachara, 1996). Manganese oxides, though generally present in lower concentrations than iron oxides, can also play a significant electron shuttle role, wherein Mn(IV) is microbially reduced to Mn(II), which then abiotically reduces crystalline Fe(III) oxides (Fredrickson et al., 2002) producing dissolved Fe(II).

In addition, the type of bioremediation substrate used has been shown to significantly affect the dissolution of metals such as iron and arsenic (McLean et al., 2006), which can impact water quality. Therefore, understanding impacts of bioremediation on metals fate and transport is an important consideration within the remediation industry, and MBTs are being increasingly used to understand these processes during remediation. However, this is an emerging use of MBTs for which the quantity of data available is currently small. Therefore, this topic is included here for completeness, but is not discussed further in this document.

## ***Methanogenesis***

Generally, methanogenic microorganisms require very similar environmental conditions as dehalogenating bacteria, such as *Dehalococcoides*. In fact, methane production has often been used as an indicator that conditions are conducive for efficient dechlorination, although its production can impact water quality. Because of their similarity in environmental niches, extensive laboratory culture studies have been conducted examining the relationship between methanogens and dechlorinating bacteria (Fennell and Gossett, 1997; Fennell and Gossett, 1998) in batch cultures and in column studies (Carr and Hughes, 1998; Yang and McCarty, 1998; Yang and McCarty, 2002). The majority of methane derived in the environment is generated using either hydrogen or acetate. Initial laboratory studies suggested that hydrogen-utilizing methanogens compete with dechlorinating bacteria for available hydrogen, although these studies did not distinguish between hydrogen- (i.e., hydrogenotrophic) and acetate- (i.e., acetoclastic) derived methane (Fennell and Gossett, 1997; Fennell and Gossett, 1998; Yang and McCarty, 1998; Yang and McCarty, 2002).

Field data, including data for ESTCP project ER-0318, have suggested that acetate-derived methane may be more important in most bioremediation treatment zones (Macbeth et al., 2004). Acetate is known to be a precursor for up to 70% of methane formation in most natural anaerobic processes (Conrad, 1999), and all of these microbes belong to the order *Methanosarcinales* comprising two families, *Methanosarcinaceae* and *Methanosaetaceae*. *Methanosaetaceae* have been demonstrated to be significant in the conversion of acetate to methane in bioremediation systems (Macbeth et al., 2004), and are the only organisms that will solely use acetate to make methane, while the *Methanosarcinaceae* can use acetate, H<sub>2</sub>, methanol, and methylamines. MBTs can be very useful for detecting the presence, relative significance, and activity of these different methanogens. Ultimately, data from such MBTs could be used for optimizing bioremediation design to mitigate undesirable impacts during and following remediation.

## **REFERENCES**

- Adrian, L., Hansen, S. K., Fung, J. M., Görisch, H., and Zinder, S. H. 2007. Growth of *Dehalococcoides* strains with chlorophenols as electron acceptors. *Environmental Science and Technology*. 41(7): p. 2318-23.
- AFCEE. 2004. Principles and Practices of Enhanced Anaerobic Bioremediation of Chlorinated Solvents. Retrieved from [http://costperformance.org/remediation/pdf/principles\\_and\\_practices\\_bioremediation.pdf](http://costperformance.org/remediation/pdf/principles_and_practices_bioremediation.pdf)
- Alvarez-Cohen, L. and Speitel, G.E. Jr. 2001. Kinetics of aerobic cometabolism of chlorinated solvents. *Biodegradation*. 12(2): p. 105-26.
- Alvarez-Cohen, L., McCarty, P.L., Boulygina, E., Hanson, R.S., Brusseau, G.A., and Tsien H.C. 1992. Characterization of a methane-utilizing bacterium from a bacterial

consortium that rapidly degrades trichloroethylene and chloroform. *Applied and Environmental Microbiology*. 58(6): p. 1886-1893.

Anderson, J.E. and McCarty, P.L. 1997. Transformation yields of chlorinated ethenes by a methanotrophic mixed culture expressing particulate methane monooxygenase. *Applied and Environmental Microbiology*. 63(2): p. 687-93.

Arp, D.J., Yeager, C.M., and Hyman, M.R. 2001. Molecular and cellular fundamentals of aerobic cometabolism of trichloroethylene. *Biodegradation*. 12(2): p. 81-103.

Bunge, M. and Lechner, U. 2009. Anaerobic reductive dehalogenation of polychlorinated dioxins. *Applied Microbiology and Biotechnology*. 84(3): p. 429-44.

Carr, C.S. and Hughes, J.B. 1998. Enrichment of High-Rate PCE Dechlorination and Comparative Study of Lactate, Methanol, and Hydrogen as Electron Donors to Sustain Activity. *Environmental Science and Technology*. 32(12): p. 1817-1824.

Coleman, N.V., Mattes, T.E., Gossett, J.M., and Spain, J.C. 2002a. Biodegradation of cis-dichloroethene as the sole carbon source by a beta-proteobacterium. *Applied and Environmental Microbiology*. 68(6): p. 2726-30.

Coleman, N.V., Mattes, T.E., Gossett, J.M., and Spain, J.C. 2002b. Phylogenetic and kinetic diversity of aerobic vinyl chloride-assimilating bacteria from contaminated sites. *Applied and Environmental Microbiology*. 68(12): p. 6162-71.

Coleman, N.V. and Spain, J.C. 2003. Distribution of the coenzyme M pathway of epoxide metabolism among ethene- and vinyl chloride-degrading Mycobacterium strains. *Applied and Environmental Microbiology*. 69(10): p. 6041-6.

Conrad, R. 1999. Contribution of hydrogen to methane production and control of hydrogen concentrations in methanogenic soils and sediments. *FEMS Microbiology Ecology*. 28(3): p. 193-202.

Cupples, A.M., Spormann, A.M., and McCarty, P.L. 2003. Growth of a *Dehalococcoides*-like microorganism on vinyl chloride and cis-dichloroethene as electron acceptors as determined by competitive PCR. *Applied and Environmental Microbiology*. 69(2): p. 953-959.

Danko, A.S., Luo, M., Bagwell, C.E., Brigmon, R.L., and Freedman, D.L. 2004. Involvement of linear plasmids in aerobic biodegradation of vinyl chloride. *Applied and Environmental Microbiology*. 70(10): p. 6092-7.

Dojka, M.A., Hugenholtz, P., Haack, S.K., and Pace, N.R. 1998. Microbial diversity in a hydrocarbon- and chlorinated-solvent-contaminated aquifer undergoing intrinsic bioremediation. *Applied and Environmental Microbiology*. 64(10): p. 3869-3877.

- Drake, H.L. 1994. Acetogenesis, acetogenic bacteria, and the acetyl-CoA "Wood/Ljungdahl" pathway: Past and current perspectives. In H.L. Drake (Ed.), *Acetogenesis* (p. 3-60). New York, NY: Chapman and Hall.
- Duhamel, M. and Edwards, E.A. 2006. Microbial composition of chlorinated ethene-degrading cultures dominated by *Dehalococcoides*. *FEMS Microbiology Ecology*. 58(3): p. 538-49.
- Duhamel, M. and Edwards, E.A. 2007. Growth and yields of dechlorinators, acetogens, and methanogens during reductive dechlorination of chlorinated ethenes and dihaloelimination of 1,2-dichloroethane. *Environmental Science and Technology*. 41(7): p. 2303-10.
- Elango, V., Liggenstoffer, A., and Fathepure, B. 2006. Biodegradation of vinyl chloride and cis-dichloroethene by a *Ralstonia* sp. strain TRW-1. *Applied Microbiology and Biotechnology*. 72(6): p. 1270-1275.
- Fennell, D.E., and Gossett, J.M. 1997. Comparison of butyric acid, ethanol, lactic acid and propionic acid as hydrogen donors for the reductive dechlorination of tetrachloroethene. *Environmental Science and Technology*. 31(3): p. 918-926.
- Fennell, D.E. and Gossett, J.M. 1998. Modeling the production of and competition for hydrogen in a dechlorinating culture. *Environmental Science and Technology*. 32(16): p. 2450-2460.
- Fennell, D.E., Nijenhuis, I., Wilson, S.F., Zinder, S.H., and Häggblom, M.M. 2004. *Dehalococcoides ethenogenes* strain 195 reductively dechlorinates diverse chlorinated aromatic pollutants. *Environmental Science and Technology*. 38(7): p. 2075-81.
- Fredrickson, J.K., Zachara, J.M., Kennedy, D.W., Liu, C., Duff, M.C., Hunter, D.B., and Dohnalkova, A. 2002. Influence of Mn oxides on the reduction of uranium(VI) by the metal-reducing bacterium *Shewanella putrefaciens*. *Geochimica et Cosmochimica Acta*. 66(18): p. 3247-3262.
- Hartmans, S. and De Bont, J.A. 1992. Aerobic vinyl chloride metabolism in *Mycobacterium aurum* L1. *Applied and Environmental Microbiology*. 58(4): p. 1220-6.
- He, J., Sung, Y., Dollhopf, M.E., Fathepure, B.Z., Tiedje, J.M., and Löffler, F.E. 2002. Acetate versus hydrogen as direct electron donors to stimulate the microbial reductive dechlorination process at chloroethene-contaminated sites. *Environmental Science and Technology*. 36(18): p. 3945-52.
- He, J., Ritalahti, K.M., Aiello, M.R., and Löffler, F.E. 2003. Complete detoxification of vinyl chloride by an anaerobic enrichment culture and identification of the reductively dechlorinating population as a *Dehalococcoides* species. *Applied and Environmental Microbiology*. 69(2): p. 996-1003.

He, J., Holmes, V.F., Lee, P.K.H., and Alvarez-Cohen, L. 2007. Influence of vitamin B12 and cocultures on the growth of *Dehalococcoides* isolates in defined medium. *Applied and Environmental Microbiology*. 73(9): p. 2847-2853.

Hendrickson, E.R., Payne, A., Young, R.M., Starr, M.G., Perry, M.P., Fahnestock, S., Ellis, D.E., and Ebersole, R.C. 2002. Molecular analysis of *Dehalococcoides* 16S ribosomal DNA from chloroethene-contaminated sites throughout North America and Europe. *Applied and Environmental Microbiology*. 68(2): p. 485-495.

Henrysson, T. and McCarty, P.L. 1993. Influence of the endogenous storage lipid poly- $\beta$ -hydroxybutyrate on the reducing power availability during cometabolism of trichloroethylene and naphthalene by resting methanotrophic mixed cultures. *Applied and Environmental Microbiology*. 59(5): p. 1602-1606.

Holliger, C., Wohlfarth, G., and Diekert, G. 1999. Reductive dechlorination in the energy metabolism of anaerobic bacteria. *FEMS Microbiology*. 22: p. 383-398.

Krajmalnik-Brown, R., Hölscher, T., Thomson, I.N., Saunders, F.M., Ritalahti, K.M., and Löffler, F.E. 2004. Genetic identification of a putative vinyl chloride reductase in *Dehalococcoides* sp. strain BAV1. *Applied and Environmental Microbiology*. 70(10): p. 6347-6351.

Lee, M.H., Clingenpeel, S.C., Leiser, O.P., Wymore, R.A., Sorenson, K.S. Jr., and Watwood, M.E. 2008a. Activity-dependent labeling of oxygenase enzymes in a trichloroethene-contaminated groundwater site. *Environmental Pollution*. 153(1): p. 238-46.

Löffler, F.E., Tiedje, J.M., and Sanford, R.A. 1999. Fraction of electrons consumed in electron acceptor reduction and hydrogen thresholds as indicators of halorespiratory physiology. *Applied and Environmental Microbiology*. 65(9): p. 4049-4056.

Macbeth, T.W., Cummings, D. E., Spring, S., Petzke, L.M. and Sorenson, K. S. Jr. 2004. Molecular characterization of a dechlorinating community resulting from in-situ biostimulation in a trichloroethene-contaminated deep, fractured basalt aquifer and comparison to a derivative laboratory culture. *Applied and Environmental Microbiology*. 70(12): p. 7329-7341.

Mackie, R.I. and Bryant, M.P. 1994. Acetogenesis and the Rumen: Syntrophic Relationships. In H.L. Drake (Ed.), *Acetogenesis* (p. 331-364). New York, NY: Chapman and Hall.

Magnuson, J.K., Stern, R.V., Gossett, J.M., Zinder, S.H., and Burris, D.R. 1998. Reductive dechlorination of tetrachloroethene to ethene by a two-component enzyme pathway. *Applied and Environmental Microbiology*. 64(4): p. 1270-1275.

Major D.W., McMaster, M.L., Cox, E.E., Edwards, E.A., Dwartzek, S.M., and Hendrickson, E.R. 2002. Field demonstration of successful bioaugmentation to achieve

dechlorination of tetrachloroethene to ethane. *Environmental Science and Technology*. 36(23): p. 5106-5116.

Mattes, T.E., Coleman, M., Spain, J., and Gossett, J. 2005. Physiological and molecular genetic analyses of vinyl chloride and ethene biodegradation in *Nocardioides* sp. strain JS614. *Archives of Microbiology*. 183(2): p. 95-106.

Mattes, T., Coleman, N.V., Chuang, A.S., Rogers, A.J., Spain, J.C., and Gossett, J.M.. 2007. Mechanism controlling the extended lag period associated with vinyl chloride starvation in *Nocardioides* sp. strain JS614. *Archives of Microbiology*. 187(3): p. 217-226.

Maymó-Gatell, X., Chien, Y., Gossett, J. M., and Zinder, S. H. 1997. Isolation of a bacterium that reductively dechlorinates tetrachloroethene to ethene. *Science*. 276(5318): p. 1568-1571.

Maymo-Gatell, X., Anguish, T., and Zinder, S.H. 1999. Reductive dechlorination of chlorinated ethenes and 1,2-dichloroethane by "*Dehalococcoides ethenogenes*" 195. *Applied and Environmental Microbiology*. 65(7): p. 3108-3113.

McLean, J.E., Dupont, R.R., and Sorensen, D.L. 2006. Iron and arsenic release from aquifer solids in response to biostimulation. *Journal of Environmental Quality*. 35(4): p. 1193-1203.

Muller, J.A.R., Bettina, M., von Abendroth, G., Meshulam-Simon, G., McCarty, P.L., Spormann, A.M. 2004. Molecular identification of the catabolic vinyl chloride reductase from *Dehalococcoides* sp. strain VS and its environmental distribution. *Applied and Environmental Microbiology*. 70(8): p. 4880-4888.

Rahm, B.G., Chauhan, S., Holmes, V.F., Macbeth, T.W., Sorenson, K.S. Jr., and Alvarez-Cohen, L. 2006a. Molecular characterization of microbial populations at two sites with differing reductive dechlorination abilities. *Biodegradation*. 17(6): p. 523-34.

Roden, E.E. and Zachara, J.M. 1996. Microbial reduction of crystalline iron(III) oxides: Influence of oxide surface area and potential for cell growth. *Environmental Science and Technology*. 30(5): p. 1618-1628.

Semprini, L. 1997. Strategies for the aerobic co-metabolism of chlorinated solvents. *Current Opinion in Biotechnology*. 8(3): p. 296-308.

Sorenson, K.S., Peterson, L.N., Hincee, R.E., Ely, R.L. 2000. An evaluation of aerobic trichloroethene attenuation using first-order rate estimation. *Bioremediation Journal*. 4(4): p. 337-357.

Stroo, H.F. and Ward, C.H. (Eds.). In press. *In-situ Remediation of Chlorinated Solvent Plumes*. SERDP and ESTCP Remediation Technology Monograph Series. New York, NY: Springer Science+Business Media.

- Sung, Y., Ritalahti, K.M., Apkarian, R.P., and Löffler, F.E. 2006. Quantitative PCR confirms purity of strain GT, a novel trichloroethene-to-ethene-respiring *Dehalococcoides* isolate. *Applied and Environmental Microbiology*. 72(3): p. 1980-1987.
- Szecsody, J.E., Fruchter, J.S., Williams, M.D., Vermeul, V.R., and Sklarew D. 2004. In-situ chemical reduction of aquifer sediments: enhancement of reactive iron phases and TCE dechlorination. *Environmental Science and Technology*. 38(17): p. 4656-63.
- Urrutia, M.M., Roden, E.E., and Zachara, J.M. 1999. Influence of aqueous and solid-phase Fe(II) complexants on microbial reduction of crystalline iron(III) oxides. *Environmental Science and Technology*. 33(22): p. 4022-4028.
- Verce, M.F., Ulrich, R.L., and Freedman D.L. 2000. Characterization of an isolate that uses vinyl chloride as a growth substrate under aerobic conditions. *Applied and Environmental Microbiology*. 66(8): p. 3535-3542.
- Verce, M.F., Ulrich, R.L., and Freedman D.L. 2001. Transition from cometabolic to growth-linked biodegradation of vinyl chloride by a *Pseudomonas* sp. isolated on ethene. *Environmental Science and Technology*. 35(21): p. 4242-51.
- Wymore, R.A., Lee, M.H., Keener, W.K., Miller, A.R., Colwell, F.S., Watwood, M.E., and Sorenson, K.S. Jr. 2007. Field evidence for intrinsic aerobic chlorinated ethene cometabolism by methanotrophs expressing soluble methane monooxygenase. *Bioremediation Journal*. 11(3): p. 125 - 139.
- Yang, Y. and McCarty, P.L. 1998. Competition for hydrogen within a chlorinated solvent dehalogenating anaerobic mixed culture. *Environmental Science and Technology*. 32(22): p. 3591-3597.
- Yang, Y., and McCarty, P. L. 2002. Comparison between donor substrates for biologically enhanced tetrachloroethene DNAPL dissolution. *Environmental Science and Technology*. 36: p. 3400-3404.

## APPENDIX D. CASE STUDIES: USE OF MOLECULAR BIOLOGICAL TOOLS

A collection of three case studies is presented in this appendix to illustrate representative field applications of a variety of MBTs, and to show how the data can be used to optimize or supplement bioremediation. Table D-1 provides an overview of the three case studies, including the MBTs used for each one, the biological processes investigated, and reference citations for additional detail. The case study at Fort Lewis was conducted as part of this project. The other two case studies were conducted as separate investigations prior to this ESTCP project and are summarized here to provide more bases for the evaluation of MBTs.

**Table D-1. Overview of Case Studies, MBTs evaluated, and References**

Case Study	Biological Process	MBTs	Reference
Test Area North (TAN), Idaho National Laboratory	Aerobic cometabolism	PCR, EAP	Lee et al., 2008a; Wymore et al., 2007
	Halo-respiration	PCR, qPCR, T-RFLP, clone library, CSIA	Macbeth et al., 2004; Song et al., 2002
	Methanogenesis	T-RFLP, clone library	Macbeth et al., 2004
Fort Lewis Logistics Center, East Gate Disposal Yard, Washington	Halo-respiration	qPCR, T-RFLP, FISH, CSIA	Lee et al., 2008b; North Wind, 2010
	Methanogenesis	qPCR, T-RFLP, FISH	North Wind, 2010
Naval Weapons Station Seal Beach, Site 40, California	General biological activity	PLFA	Rahm et al., 2006
	Halo-respiration	qPCR, T-RFLP	

### Test Area North: Idaho National Laboratory

#### *Aerobic cometabolism*

Idaho National Laboratory's TAN is a site where PCR and EAPs were used to demonstrate and gain acceptance of aerobic cometabolism as the basis for a MNA remedy of a nearly two-mile long, aerobic, TCE plume resulting from waste injections into a deep, fractured rock aquifer (Lee et al., 2008a; Wymore et al., 2007). Previous investigations revealed that TCE was being attenuated with a half-life of nine to 21 years relative to two co-disposed internal tracers, tritium and PCE (Sorenson et al., 2000). Biological attenuation mechanisms were investigated using PCR and EAPs targeting sMMO and the aromatic oxygenases TOD, 2- and 3-monooxygenase, and TOL enzymes (Lee et al., 2008a; Wymore et al., 2007). In addition, samples were analyzed for chlorinated solvents, tritium, redox parameters, primary substrates, and degradation



products. The enzyme probe assays, methanotrophic enrichments and isolations, and DNA analysis documented the presence and activity of indigenous microorganisms expressing the sMMO and toluene-based oxygenase enzymes, indicating that a diversity of active pathways was present that could be cometabolizing TCE (Figure D-1).

3-D groundwater data showed plume-wide aerobic conditions, with low levels of methane and detections of carbon monoxide, a potential by-product of TCE cometabolism. The TCE half-life attributed to aerobic cometabolism was 13 years relative to tritium, based on the tracer-corrected method. Similarly, a half-life of eight years was estimated for DCE. Although these rates are slower than most anaerobic degradation processes, they can be significant for large plumes. These investigations are believed to be the first documentation of intrinsic aerobic TCE and DCE cometabolism in an aquifer by indigenous methanotrophs and bacteria expressing aromatic oxygenases. Demonstration of these biological mechanisms led to the acceptance of MNA as the ROD-prescribed remedy for over one mile of the low-concentration dissolved phase plume.

**Figure D-1. Detections of sMMO and Aromatic Oxygenase Probe Response in the TAN Groundwater Plume**

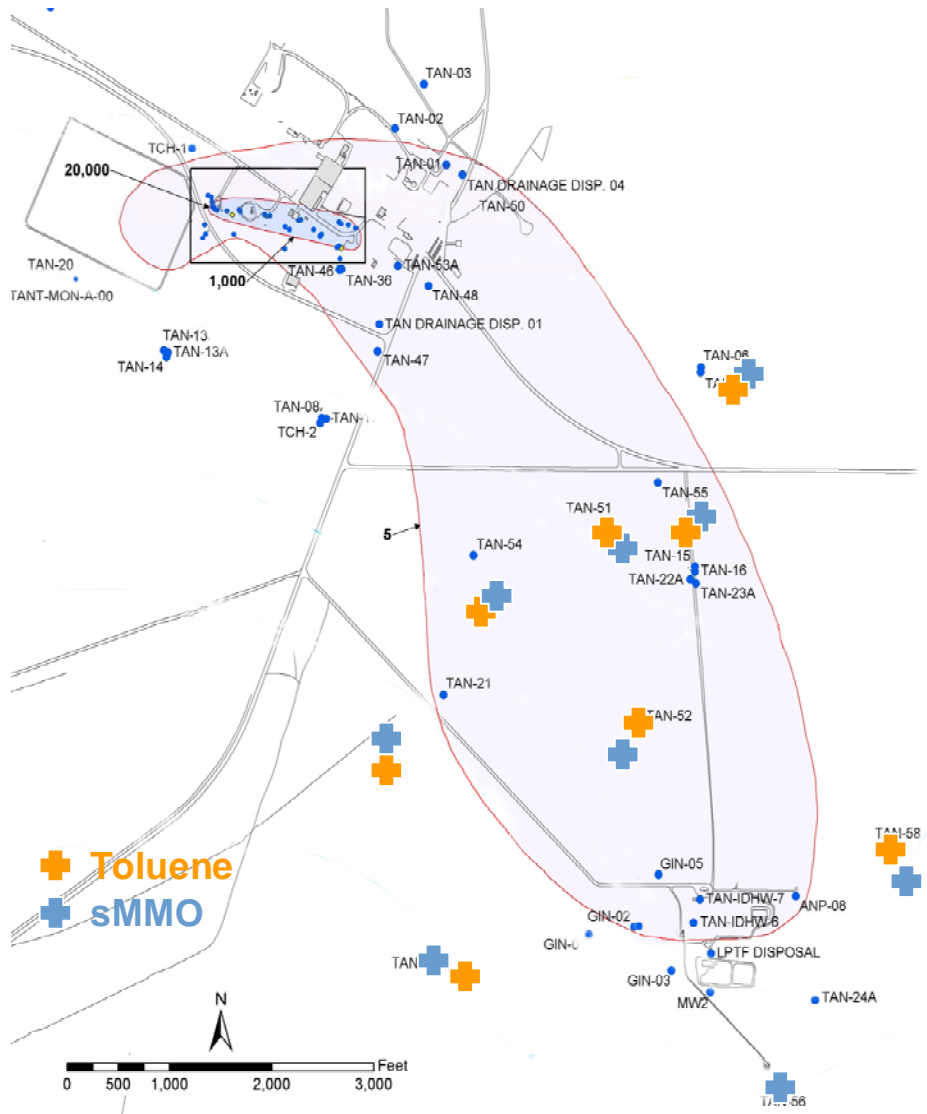

(Lee et al., 2008a)

***Halo-respiration/Methanogenesis***

The groundwater plume remedy at the Idaho National Laboratory site included multiple components, with in-situ bioremediation selected as the treatment for the anaerobic residual source area (Dettmers et al., 2006). Sodium lactate injections were initiated in the original waste disposal well that was the source of the contamination. These injections resulted in the generation of methanogenic redox conditions that corresponded to efficient reductive dechlorination of TCE to ethene within 9 months of initiating the injections. Anaerobic biological degradation was demonstrated by groundwater contaminant data and CSIA (Song et al., 2002). Macbeth et al. (2004) used PCR, T-RFLP, and clone libraries to determine that the biostimulated community was dominated

by homoacetogenic bacteria, and the methanogenic community was dominated by acetate consumers (acetoclastic) rather than hydrogen consumers (hydrogenotrophic). In addition, *Dehalococcoides* spp. was detected using PCR in groundwater. These initial investigations suggested that methanogenesis was not inhibitory to *Dehalococcoides* at the TAN site, and that the majority of methane generated was likely derived from acetate, not hydrogen.

Optimization of the bioremediation at TAN included a period of evaluating whey powder as an alternative amendment to sodium lactate. Whey powder was demonstrated to enhance the effective solubility of TCE DNAPL, in addition to facilitating efficient biodegradation (Macbeth et al., 2006). MBTs were used to evaluate the shift in microbial community from sodium lactate to whey, and to track the community with respect to geochemistry and contaminant biodegradation (Macbeth, 2008). Microbial population dynamics were evaluated over the course of sodium lactate and whey powder injection cycles using DNA extracted from groundwater and evaluated using T-RFLP targeting the 16S rRNA gene for *Bacteria* and *Archaea* with complementary clone library construction and DNA sequencing, and qPCR for *Dehalococcoides* spp.

### ***T-RFLP/Clone Library Results***

T-RFLP profiles were generated to evaluate the microbial community at five time points (Days 1, 3, 7, 21, and 36) following lactate or whey injections. Following lactate injections, the T-RFLP profiles were consistent for a given day post-injection. However, the profiles significantly shifted through the injection cycles, as populations shifted in response to changes in availability of substrates. Figure D-2 was generated to illustrate changes in predominant T-RFs in response to lactate and then to the primary fermentation products propionate and acetate. For example, the most dominant group of fermentative bacteria on Day 7 following injection was associated with T-RF 218, T-RF 224, and T-RF 300 identified using clone libraries as *Acetobacterium* sp. strain HAAP-1 (Macbeth et al., 2004), which was associated with the presence of lactate. Likewise, evaluation of T-RFLP profiles coupled to clone library construction post-whey injection identified predominant groups associated with lactose fermentation and primary fermentative products butyrate, acetate, and propionate. Overall, the communities were very different stimulated with lactate compared to whey.

**Figure D-2. Relationship among Predominant Microbial T-RFs Observed Following Lactate and Whey Injections in Relationship to Lactate and Lactose and VFA Concentrations**

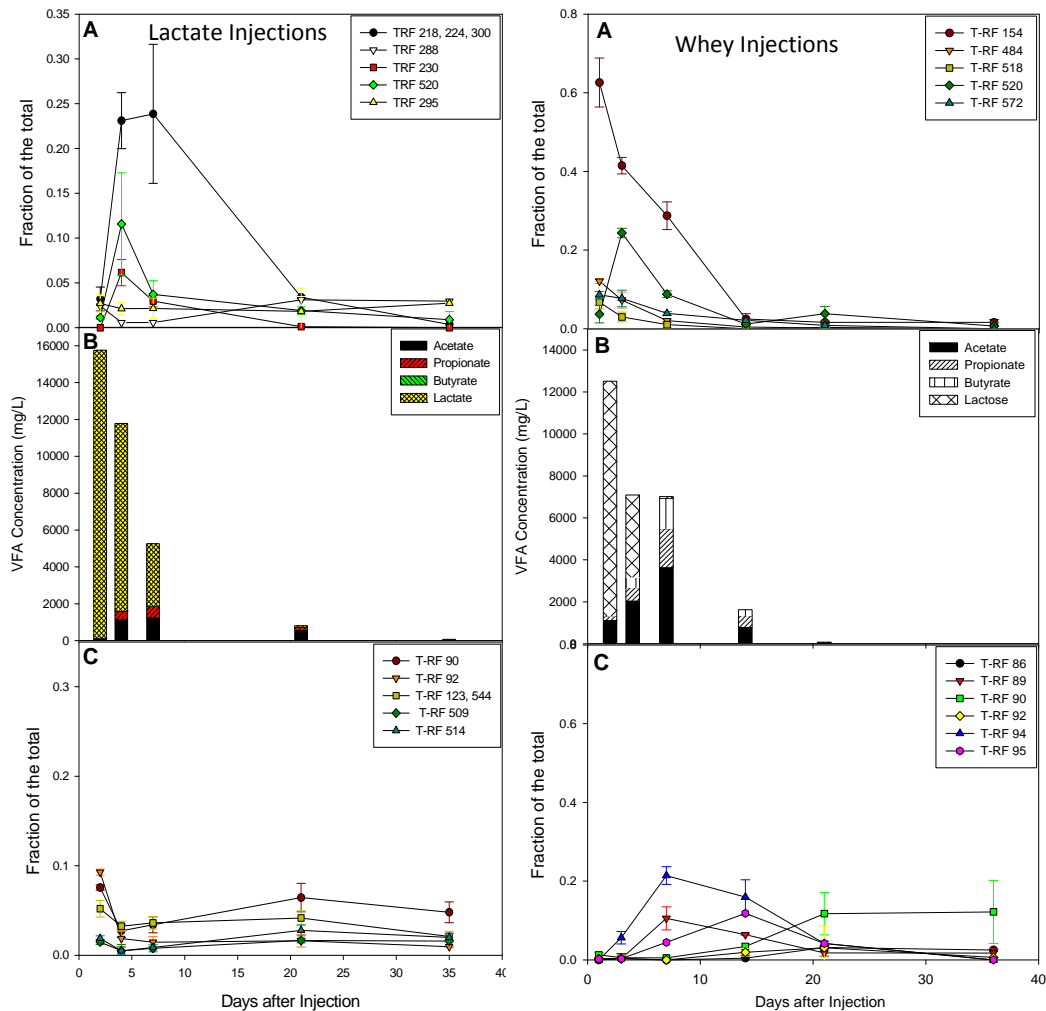

Values represent the average of 3 DNA extractions performed for each of two samples collected on corresponding Days 1, 3, 7, 21, and 36 days following an injection (n=6)

### ***Dehalococcoides* qPCR Results**

In order to understand the fate of *Dehalococcoides* spp., qPCR was performed, targeting the 16S rRNA gene in DNA extracted from TAN groundwater. Figure D-3 illustrates the concentrations of *Dehalococcoides* present following the sodium lactate and whey injections. In general, *Dehalococcoides* concentrations were relatively high and remained fairly stable ( $\sim 10^8$  to  $10^9$  gene copies/L of groundwater) over the course of the lactate injection cycle (n=18), which is consistent with T-RFLP data. Following whey powder injections, concentrations of *Dehalococcoides* were generally lower during a whey injection cycle, ranging from approximately  $10^5$  to  $10^8$  gene copies/L (n=27) of groundwater compared to values observed following sodium lactate injection. The lowest concentrations of *Dehalococcoides* were detected on the Day 21 sampling event following injections. One possible explanation for the difference is reduced pH following

lactose fermentation (Figure D-3). The *Dehalococcoides* response is time-shifted relative to the low point observed for pH (approximately Day 7), which might be attributable to the limitations of the DNA-based qPCR method, which might detect DNA from cells that are inactive and/or dead.

**Figure D-3. Concentrations of *Dehalococcoides* spp. 16S rRNA Genes Following Sodium Lactate and Whey Powder Injection Cycles Compared to pH Response**

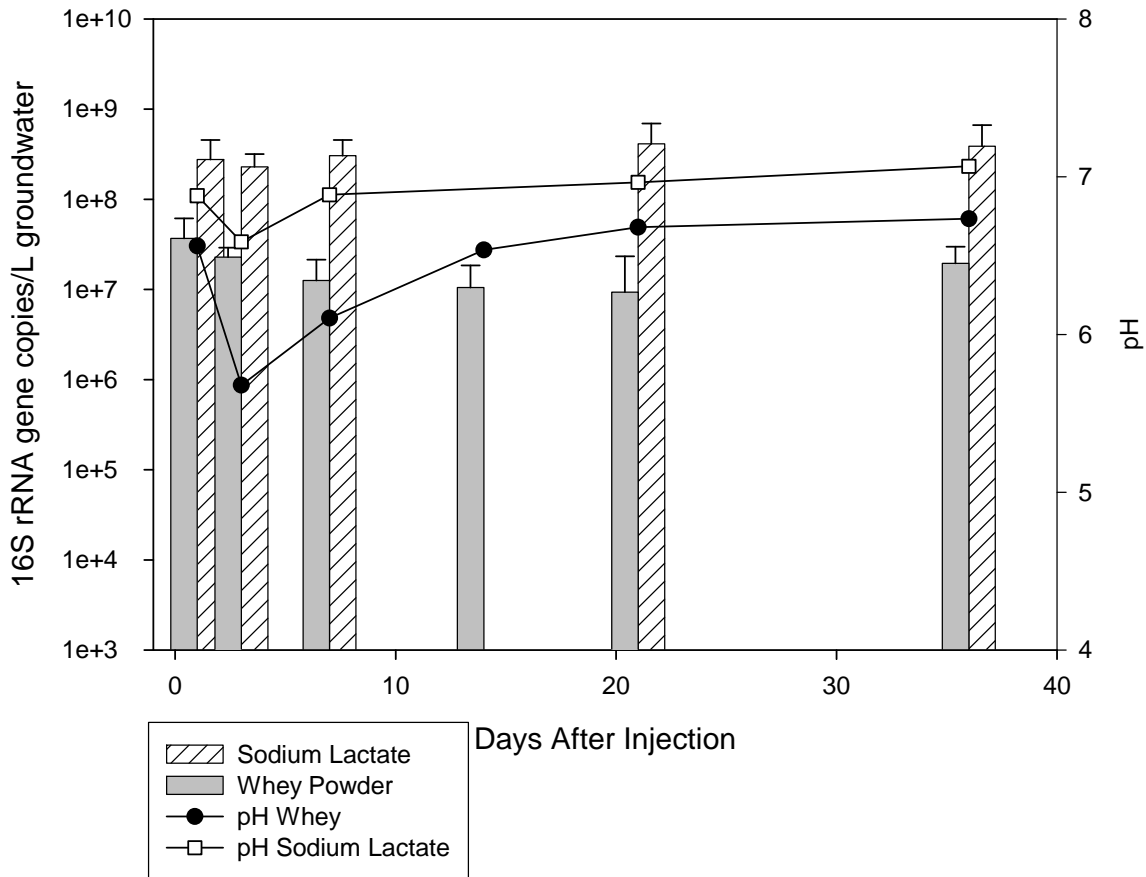

*Dehalococcoides* spp. values represent the average of three DNA extractions, each run in triplicate, from each of two corresponding samplings following sodium lactate (n=18) and three samplings following whey powder (n=27) injections, with one standard deviation from the mean

**Contaminant Fate Results**

The efficiency of the halorespiration reactions was assessed by examining changes in relative concentrations of TCE, cis-DCE, VC, and ethene following injections of lactate compared to whey (Figure D-4). Reductive dechlorination has been ongoing at all of the bioremediation treatment wells evaluated in this study since 1999, when source area concentrations were one to two orders of magnitude higher, resulting in completed reduction of TCE to ethene (Song et al., 2002). In general, amendment injections resulted in dissolution of TCE from the residual source material into groundwater as discussed in Macbeth et al. (2004). Following sodium lactate injections, elevated concentrations of TCE were observed in wells Technical Support Facility (TSF)-05 and TAN-25 that were

rapidly reduced to cis-DCE, which was the primary chloroethene observed by Day 7, with respective mean concentrations of 142 µg/L and 78 µg/L; TCE concentrations were <7 µg/L at both locations by that time. Accumulated cis-DCE remained through Day 21 at mean concentrations of 133 µg/L and 47 µg/L in the two wells, respectively, but was significantly reduced by Day 36 to 52 µg/L and <5 µg/L. Ethene constituted a substantial proportion of the total chloroethene and ethene molar mass (from 30 to 84%) during the injection cycle and was the predominant reductive daughter product by Day 36, accounting for 70 and 81% of the molar mass of total chloroethenes and ethene, respectively.

There were marked differences in the trends of chloroethenes and ethene following whey powder injection relative to sodium lactate. First, a much higher mass of TCE was observed in groundwater within 7 days of injection, with maximum mean concentrations of 314 µg/L at TSF-05 and 240 µg/L at TAN-25, indicating a much higher rate of dissolution following whey injection. Similar to lactate, the dissolved TCE was quickly converted to cis-DCE, which accumulated to relatively high concentrations until approximately Day 21. While conversion of TCE to cis-DCE was equally efficient following whey injection compared to lactate injection, the conversion of cis-DCE to ethene was slower early on with a longer lag period before the onset of ethene production following whey injection. This lag period also corresponded to the period of low pH (Figure D-4).

**Figure D-4. Anaerobic Reductive Dechlorination during Sodium Lactate (A) and Whey Powder (B) Injection Cycles in Monitoring Wells within the TAN Source Treatment Area**

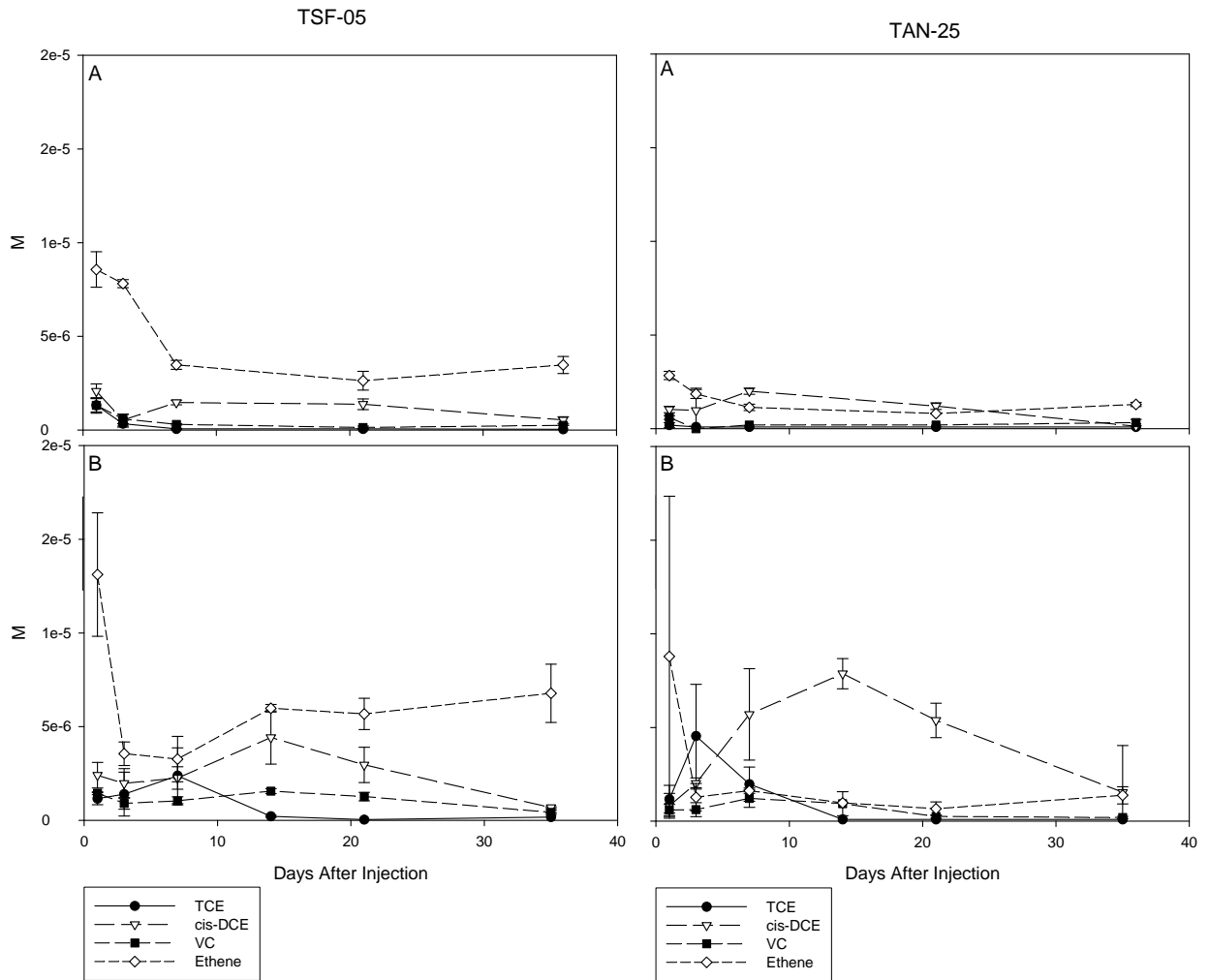

Values represent the average concentration observed on corresponding days following two sodium lactate and three whey powder injections, and error bars represent one standard deviation from the mean

### Discussion

Molecular tools provided information on the microbial community dynamics, as well as growth and activity of specific microbial populations of interest, such as fermentative, *Dehalococcoides*, and methanogenic populations. A summary of the overall performance evaluation of the MBT evaluation at TAN includes:

- EAPs:** EAPs were key in demonstrating the presence of biological degradation mechanisms in the large, dilute, aerobic TCE plume at TAN. This information was necessary to obtain acceptance of MNA as the remedy for this portion of the plume.

- **Community-level T-RFLP profiling:** These data provided information regarding the shift in predominant bacterial and archaeal populations during enrichment of a microbial community using sodium lactate compared to whey powder. In addition, when the MBT data were correlated to chemical data over time, relationships between identified populations and function within the community could be made. Of note is that care should be taken when interpreting the data from amendments that can themselves be sources of microorganisms (e.g., whey). While these data can provide interesting scientific information regarding community-level dynamics, they were not necessary to make operational decisions at TAN.
- **qPCR for *Dehalococcoides*:** These data were extremely useful in evaluating quantities of contaminant-degrading microbes over time during lactate and whey injections. First, both lactate and whey sustained high concentrations of *Dehalococcoides*, although concentrations during whey injection cycles were one to two orders of magnitude lower, with minimums observed following periods of depressed pH, which also corresponded to periods of reduced dechlorination efficiency. Overall, however, reductive dechlorination efficiency increased as pH recovered over the course of the injection cycle, as did *Dehalococcoides* concentrations. At TAN, therefore qPCR data were used to define key operational criteria for optimization and maintenance of an efficient bioremediation strategy.

### **Fort Lewis East Gate Disposal Yard: ESTCP Project ER-0318**

The overall objective of ESTCP demonstration project ER-0318 was to evaluate innovative diagnostic tools, including MBTs, for the implementation and optimization of bioremediation to treat chlorinated solvent residual source areas containing DNAPL. A suite of MBTs was evaluated as part of the demonstration to:

1. Assess impacts of bioremediation amendments on the biological community,
2. Determine presence and enrichment of contaminant-degrading microorganisms during treatment,
3. Monitor microbial community dynamics and correlate population shifts of key organisms with dechlorination performance.

MBTs, including T-RFLP, qPCR, and FISH, were used to track microbial community changes in response to whey powder injections in the two treatment cells within a DNAPL source area. The relationship between community structure and overall bioremediation performance was evaluated in order to determine the utility of these methods as predictive and performance assessment tools. Assays performed are described in Table D-2.



**Table D-2. MBT Targets for Analysis during the ER-0318 Bioremediation Demonstration**

<b>Molecular Target</b>	<b>Purpose</b>	<b>Reference</b>
<b>qPCR</b>		
<i>Bacteria</i> and <i>Archaea</i>	Universal targets <i>Bacteria</i> and <i>Archaea</i> used as general biomass indicators	Suzuki et al., 2000
<i>Dehalococcoides</i> 16S rRNA, <i>vcrA</i> , <i>tceA</i> , <i>bvcA</i>	Presence and abundance of <i>Dehalococcoides</i> spp. and of dechlorinating functional genes	Lee et al., 2008b
<i>Methanosarcinales</i> , <i>Methanococcales</i> , <i>Methanobacteriales</i> , <i>Methanomicrobiales</i>	Presence and abundance of these orders of acetogenic and hydrogenotrophic methanogens	Yu et al., 2005
<b>FISH</b>		
<i>Eubacteria</i> , <i>Archaea</i>	Universal targets for almost all prokaryotes and <i>Archaea</i>	Raskin et al., 1994b
<i>Methanobacteriaceae</i>	Targets one order of <i>Methanobacteriales</i>	Del Nery et al., 2008
<i>Methanococcales</i> , <i>Methanomicrobiaceae</i> , <i>Methanosarcinaceae</i> including <i>Methanosaeta</i> , <i>Methanosaeta</i>	Targets one class of <i>Methanococci</i> , one order of <i>Methanomicrobiales</i> , one order of <i>Methanosarcinales</i> in addition to the genus <i>Methanosaeta</i> , and the genus <i>Methanosaeta</i>	Raskin et al., 1994a
<i>Dehalococcoides</i>	Targets the genus <i>Dehalococcoides</i> , some species of which are known to reduce TCE to ethene	Fazi et al., 2008
<b>T-RFLP/Clone Libraries</b>		
<i>Bacteria</i> and <i>Archaea</i>	Diversity of <i>Bacteria</i> and <i>Archaea</i>	Macbeth et al., 2004

**Contaminant Fate Results**

Contaminant fate was evaluated in order to determine the impact of whey injections on contaminants. Two injection strategies, 10% and 1% whey, were employed alternatively in two treatment cells, 1 and 2. Biodegradation was evaluated by assessing the molar mass balance between parent compounds (TCE) and reductive daughter products (cis-DCE, VC, and ethene). Figure D-5 illustrates the total average moles of contaminants and reductive daughter products before, during, and after biostimulation (whey injections). Overall, the total contaminant mass in treatment cell 2 was greater than treatment cell 1, as it contained residual DNAPL. Prior to whey injections, TCE and cis-DCE were the primary VOCs detected, with an average range of 51-95 µM and 175-228 µM (n=8 sampling points) for all baseline sampling events (n=3) in treatment cells 1 and 2. Following initiation of whey injections, nearly complete conversion to cis-DCE was observed with a relatively good mass balance at all sampling points with an average

range of 69-113  $\mu\text{M}$  and 185-262  $\mu\text{M}$  during 1% whey injections in treatment cells 1 and 2. Following initiation of 10% whey injections, however, the total mass of VOCs (primarily cis-DCE) increased dramatically in treatment cell 2 with concentrations ranging from 303-715  $\mu\text{M}$ , but was similar in treatment cell 1 at 49-61  $\mu\text{M}$ . These data demonstrated that the whey injection strategy did have a significant ( $p>0.05$ ) impact on VOC concentrations for treatment cell 2, but not for treatment cell 1. This is largely attributed to the location of treatment cell 2 within the DNAPL source area, whereas treatment cell 1 was outside the source area. Substantial reductions in total VOC concentrations were observed in both treatment cells at the end of the demonstration concomitant with significant VC and ethene production.

**Figure D-5. Average (n=8) Molar Concentration of TCE and Reductive Daughter Products in Two Treatment Cells during the ER-0318 Bioremediation Demonstration**

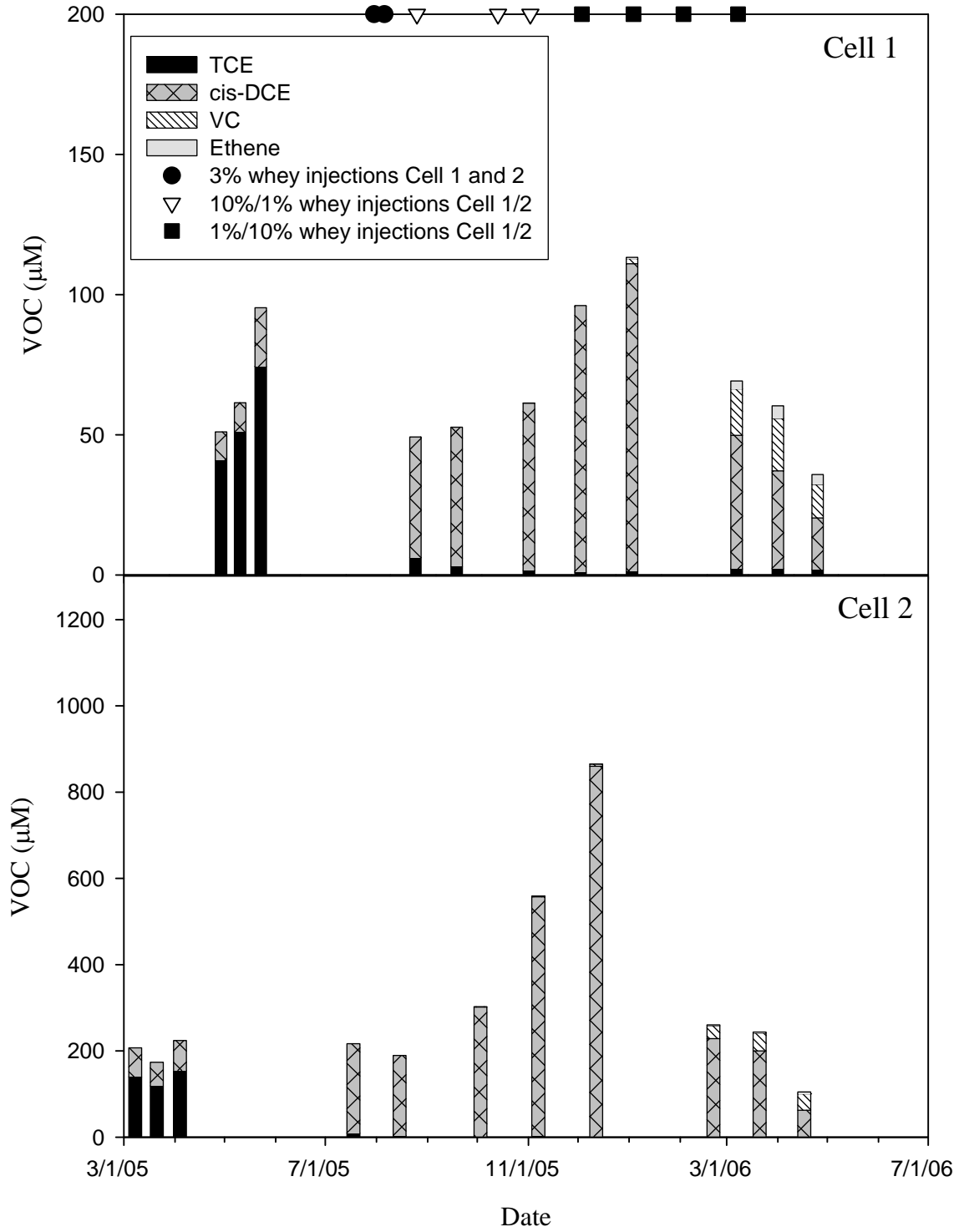

***T-RFLP Results***

T-RFLP was used to evaluate diversity of microbial populations by targeting their 16S rRNA genes. Table D-3 and Table D-4 provide results of the T-RFLP evaluation. In general, significant shifts in the predominant bacterial populations were observed between each sampling time point evaluated. One month after initiation of monthly whey injections (July 2005), T-RFs 489 and 490 bp represented >20% of the total community at all sampling points within the treatment cells. By two months (August 2005), T-RF 565 bp was predominant at all locations. By five (November 2005) and eight months (February 2005), the T-RFLP communities had stabilized somewhat and T-RF 95 bp was the predominant T-RF observed at all locations and time points except one.

Clone library analysis coupled to T-RFLP analysis of groundwater undergoing whey injections in a chlorinated solvent source area at the TAN site in Idaho identified T-RF 95 as a species within the genus *Bacteroides* (Macbeth, 2008). This genus has been linked primarily to carbohydrate fermentation, including lactose (the primary component of whey), and production of VFAs, predominately acetate, propionate, and butyrate in human intestines (McNeil et al., 1978) and anaerobic digestors (Ueki et al., 2008). In addition, *Bacteroides* are also associated with protein degradation-generating ammonia, carbon dioxide, VFAs, and branched-chain fatty acids (Wrong, 1988). Although the identification of this T-RF cannot be confirmed at Fort Lewis without clone library assessment of the Fort Lewis samples, it does illustrate the potential utility of the method.

Table D-4 illustrates the T-RFLP results targeting *Archaea*, which include methanogens. *Archaea* could not be amplified for the one- or two-month samples post-initiation of monthly whey injections using PCR to high enough concentrations to run T-RFLP. This suggests that relatively low concentrations of *Archaea* were present during these sampling events. T-RFLP analysis was performed for *Archaea* on the five- and eight-month sampling events, with the exception of one location. In all of the samples, T-RF 330 predominated the archaeal community, constituting 72-100% of the profile. At the Idaho National Laboratory site undergoing enhanced bioremediation in a source zone, this fragment was associated with the *Methanosarcina* genus, which contains both acetate-utilizing and hydrogen-utilizing species (Macbeth et al, 2004). Again, however, clone libraries would need to be conducted on the Fort Lewis samples to confirm this identification.

**Table D-3. Summary of T-RFLP Results for Bacteria**

Date	Well	S (T-RFs) 2005 <sup>a</sup>	Predominant Fragments <sup>b</sup> (bp)
July 2005	MW1A4	17	490 (42), 491 (42)
	MW1B4	39	489 (21), 490 (23)
	MW1C4	45	490 (26)
	MW1D4	11	489 (44), 490 (43)
	MW2A4	45	95 (10), 120 (39), 490 (30)
	MW2B4	36	490 (23)
	MW2C4	34	410 (45)

Date	Well	S (T-RFs) 2005 <sup>a</sup>	Predominant Fragments <sup>b</sup> (bp)
	MW2D4	34	489 (24), 490 (25)
August 2005	MW2A4	28	84 (17), 532 (15), 565 (15)
	MW2B4	25	84 (14), 92 (37), 565 (12)
	MW2C4	27	532 (12), 565 (24)
	MW2D4	31	520 (10), 565 (17)
	MW1A4	20	528 (13), 554 (19), 565 (16)
	MW1B4	22	84 (18), 532 (22), 565 (19)
	MW1C4	20	532 (14), 565 (25)
	MW1D4	25	84 (12), 532 (18), 565 (19)
November 2005	MW1A4	18	95 (20), 215 (21), 573 (14)
	MW1B4	23	95 (46), 550 (12)
	MW1C4	18	95 (52), 202 (11)
	MW1D4	15	95 (56), 550 (13)
	MW2A4	22	95 (37), 193 (14)
	MW2B4	18	95 (45), 550 (12)
	MW2C4	17	95 (30), 193 (18), 550 (11)
	MW2D4	16	95 (22), 193 (31)
February 2006	MW1A4	9	95 (63), 550 (15)
	MW1B4	32	87 (12), 95 (28)
	MW1C4	25	94 (15), 506 (14), 509 (10), 520 (12)
	MW1D4	20	87 (15), 506 (10)
	MW2A4	17	95 (41), 550 (16)
	MW2B4	14	95 (40), 550 (12), 573 (14)
	MW2C4	16	95 (38), 193 (20), 550 (11)
	MW2D4	15	95 (41), 193 (13), 550 (11)

a. Number of T-RFs in community profile.

b. Value in parenthesis represents % of total community that the T-RF represented.

**Table D-4. Summary of T-RFLP Results for Archaea**

Date	Well	S (T-RFs) <sup>a</sup>	Predominant Fragments (bp) <sup>b</sup>
November 2005	MW1A4	1	330 (100)
	MW1B4	1	330 (100)
	MW1C4	1	330 (100)
	MW1D4	2	327 (13), 330 (81)
	MW2A4	2	323 (9), 330 (91)
	MW2B4	0	No Data <sup>c</sup>
	MW2C4	1	330 (100)
	MW2D4	2	328 (7), 330 (87)
February 2006	MW1A4	1	330 (100)
	MW1B4	1	330 (100)
	MW1C4	1	330 (100)
	MW1D4	1	330 (100)
	MW2A4	2	325 (28), 330 (72)
	MW2C4	1	330 (100)
	MW2D4	2	325 (8), 330 (89)

a. Number of T-RFs in community profile

b. Value in parenthesis represents % of total community that the T-RF represented.

c. Sample did not amplify with PCR.

### ***Dehalococcoides* qPCR Results**

qPCR methods developed by the University of California at Berkeley were used to quantify DNA targeting several genes of the *Dehalococcoides* genus in groundwater samples (Lee et al., 2008b). These data were used to assess the indigenous *Dehalococcoides* population at Fort Lewis, the impact of bioaugmentation with a *Dehalococcoides*-containing culture, and the growth of *Dehalococcoides* coupled to reductive dechlorination performance and geochemistry.

The relationships between *Dehalococcoides* and pH and methane (Figure D-8) was evaluated in order to determine if these parameters either directly or indirectly influenced *Dehalococcoides* growth and activity. For pH, *Dehalococcoides* was evaluated from the initial drop in pH to relatively low values immediately following the onset of whey injections through the recovery observed approximately eight months after injections began (Figure D-8). A positive correlation was observed between *Dehalococcoides* concentrations and pH ( $R^2$  values between 0.36-0.42), with increasing concentrations of *Dehalococcoides* with higher pH. In particular, high concentrations of *Dehalococcoides* were not observed within both treatment cells until pH values had recovered to >5.5-6.0 (i.e., pH greater than a threshold value). Almost uniformly within both treatment cells, concentrations of *Dehalococcoides* 16S rRNA, *vcrA*, and *bvcA* genes that exceeded  $10^7$  gene copies/L of groundwater corresponded to pH values >6.0.

Figure D-6 illustrates the response of *Dehalococcoides* concentrations to the operational phases of the demonstration. In general, relatively low concentrations ( $<10^5$  gene copies/L groundwater) of the *Dehalococcoides* 16S rRNA and functional reductase genes *tceA*, *bvcA*, and *vcrA* were detected during baseline sampling within both treatment cells. Following the onset of whey injections, *Dehalococcoides* concentrations increased one to two orders of magnitude in both treatment cells one month post-injection (July 2005). Bioaugmentation was conducted following the July 2005 whey injection into both treatment cells using a *Dehalococcoides*-containing culture.

Figure D-7 illustrates the qPCR results of the bioaugmentation culture. As can be seen, *bvcA* was not detected in the culture, but was present initially in NAPL Area 3. Sampling results from one month post-bioaugmentation (August 2005) generally indicated that average concentrations increased slightly compared to the July 2005 sampling event. Little significant change in *Dehalococcoides* concentrations was observed until eight months (February 2006) after initiation of biostimulation, when concentrations of all four targets increased by one to two orders of magnitude in both treatment cells. In general, the *vcrA* and *bvcA* reductase genes constituted the greatest fraction of the *Dehalococcoides* population, with *tceA* genes generally two to three orders of magnitude lower in concentration for all time points evaluated. In addition, the sum of the functional reductase genes generally equaled that of the 16S rRNA gene, which indicates that these three functional genes collectively represented the majority of the *Dehalococcoides* population.

Overall, no correlation between concentration of *Dehalococcoides* and dechlorination rate was observed (data not shown). However, during the periods of low concentrations of the three genes indicated above ( $<10^5$  gene copies/L groundwater), TCE and cis-DCE were the predominant contaminants within the treatment cells. Following the onset of whey injections, nearly complete conversion to cis-DCE was observed along with an increase in the gene concentrations ( $<10^7$  gene copies/L groundwater). This initial increase in *Dehalococcoides* was followed by a lag in growth for nearly four months. Once *Dehalococcoides* again increased to high concentrations ( $>10^7$  gene copies/L groundwater), VC and ethene were produced. Therefore, a threshold concentration for *Dehalococcoides* might exist below which dechlorination of the lower chlorinated ethenes cis-DCE and VC does not occur at sufficient rates to be observed.

The relationships between *Dehalococcoides* and pH and methane (Figure D-8) was evaluated in order to determine if these parameters either directly or indirectly influenced *Dehalococcoides* growth and activity. For pH, *Dehalococcoides* was evaluated from the initial drop in pH to relatively low values immediately following the onset of whey injections through the recovery observed approximately eight months after injections began (Figure D-8). A positive correlation was observed between *Dehalococcoides* concentrations and pH ( $R^2$  values between 0.36-0.42), with increasing concentrations of *Dehalococcoides* with higher pH. In particular, high concentrations of *Dehalococcoides* were not observed within both treatment cells until pH values had recovered to  $>5.5$ - $6.0$  (i.e., pH greater than a threshold value). Almost uniformly within both treatment cells, concentrations of *Dehalococcoides* 16S rRNA, *vcrA*, and *bvcA* genes that exceeded  $10^7$  gene copies/L of groundwater corresponded to pH values  $>6.0$ .

**Figure D-6. Summary of *Dehalococcoides* qPCR Results for the 16S rRNA, *bvcA*, *vcrA*, and *tceA* Genes as the mean (n=4) for Each Treatment Cell, and FISH Results Targeting the 16S rRNA Gene**

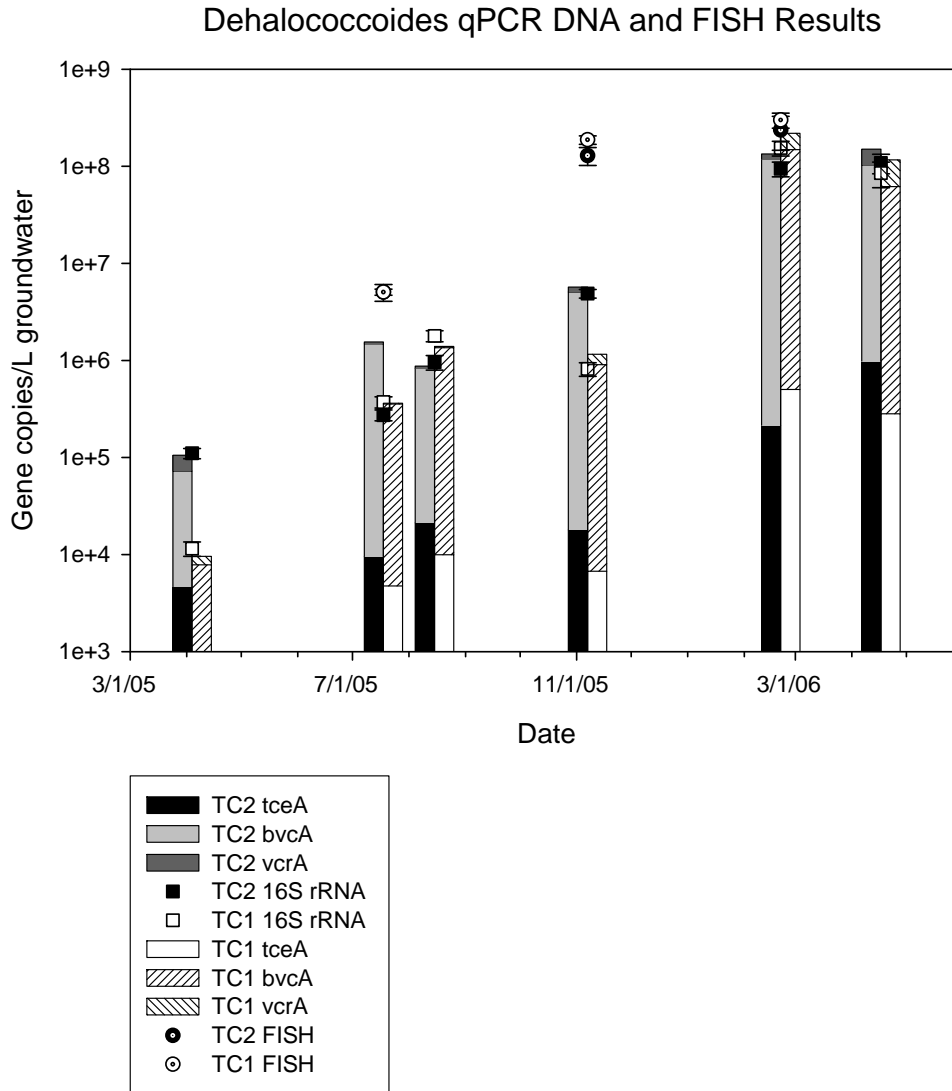



Figure D-7. qPCR Results for Bioaugmentation Culture Used at Fort Lewis

*Dehalococcoides* spp. Bioaugmentation Culture

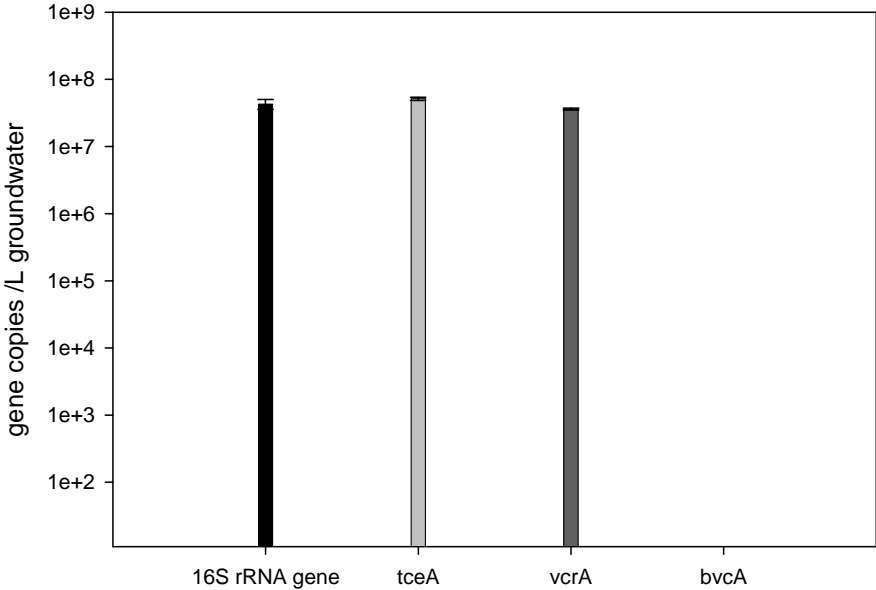
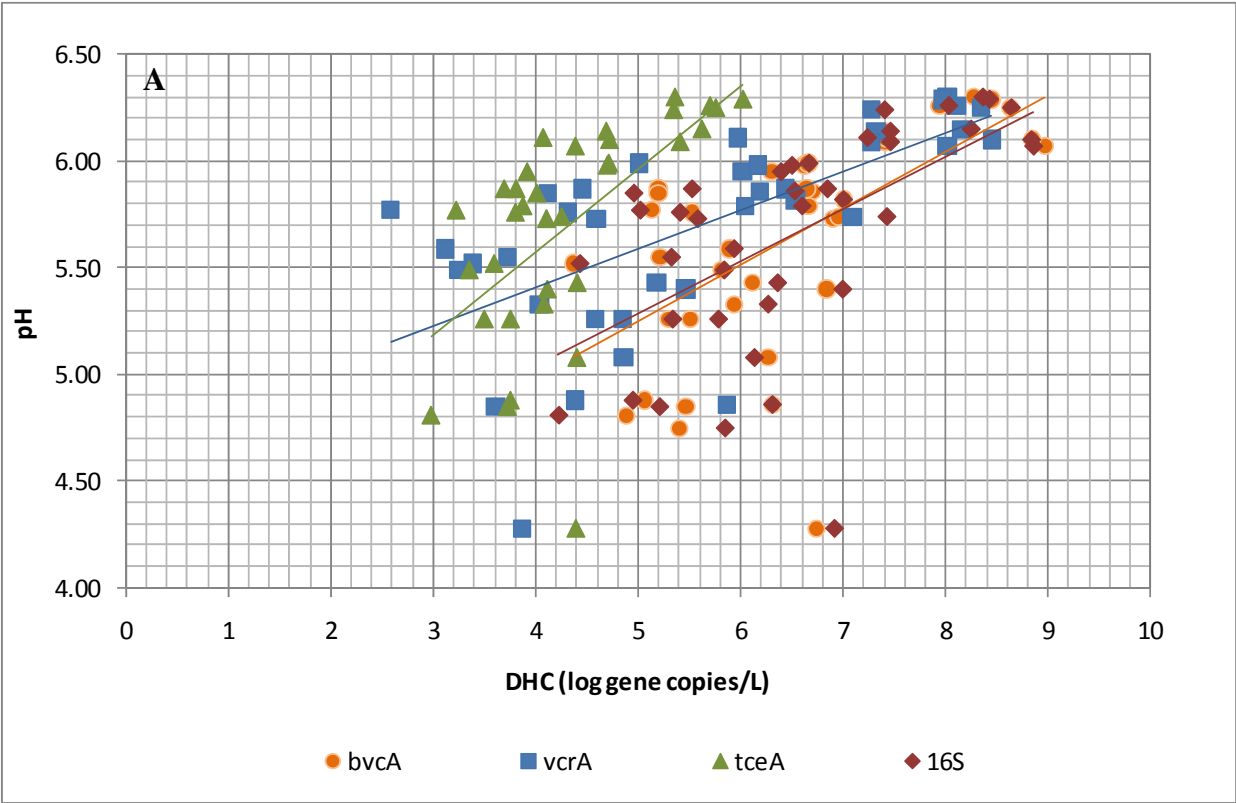
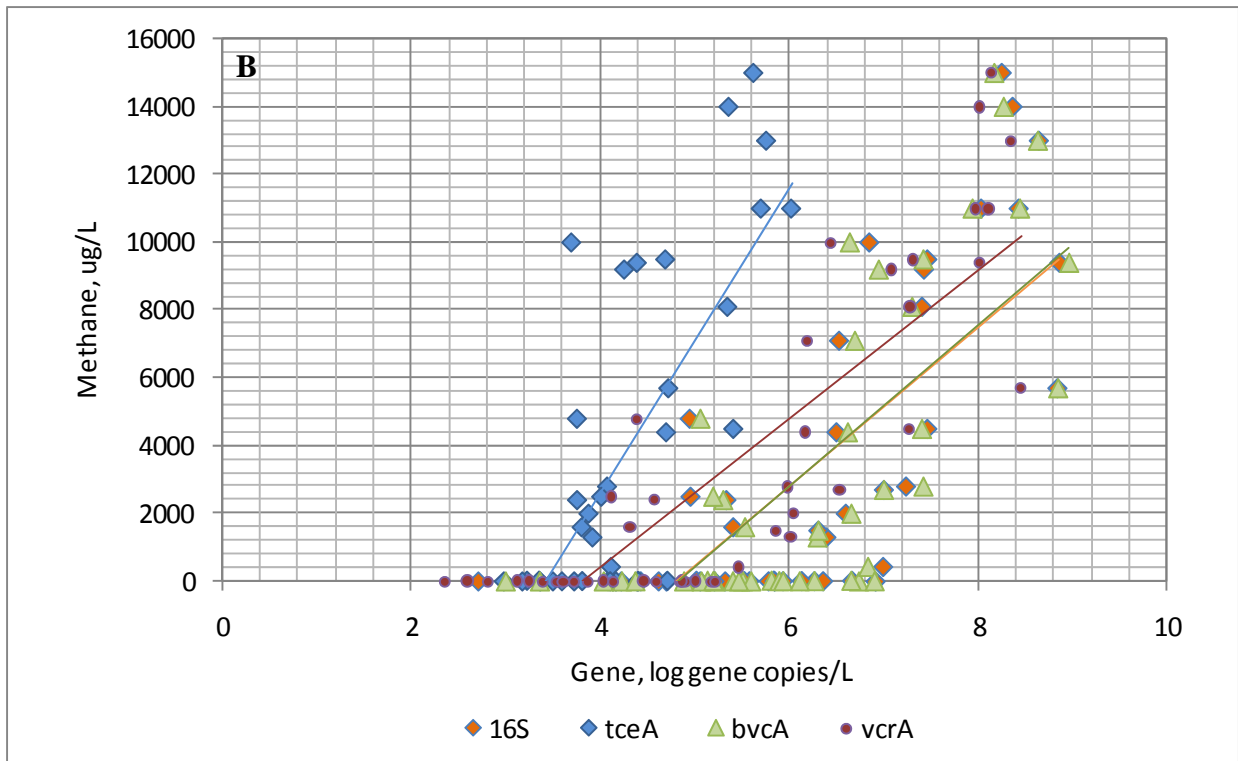

Figure D-8. Relationship between *Dehalococcoides* qPCR Results and Geochemical Parameters pH (A) and Methane (B)





Regarding the relationship between *Dehalococcoides* and methane, *Dehalococcoides* is a strict anaerobe, and previous studies have indicated that growth and activity are generally most efficient under methane-producing conditions. Consistent with this model, a positive correlation was observed between methane production and increasing concentrations of all four of the *Dehalococcoides* targets ( $R^2$  values between 0.56-0.63), as illustrated in Figure D-8. While this does not necessarily mean that methane is directly affecting *Dehalococcoides* growth and activity, it does at least imply that environmental conditions that are conducive to methane production are also conducive to *Dehalococcoides* growth and activity. Furthermore, it demonstrates that increasing methane production is not detrimental to *Dehalococcoides* growth.

These results suggest that in order to enrich high concentrations of *Dehalococcoides* ( $>10^7$  gene copies/L groundwater) necessary to facilitate efficient reductive dechlorination to ethene, the following conditions were necessary:

- pH values  $>6.0$
- Strongly methanogenic conditions.

### ***FISH Results***

FISH was also used to evaluate *Dehalococcoides* spp. FISH is a whole-cell assay used to visualize cells by hybridizing RNA with fluorescent probes that are specific to the desired target. FISH is considered a direct measure of activity since it binds to RNA instead of DNA. In addition, it has the advantage of not requiring DNA or RNA extraction, nor does

it require amplification, as do PCR-based methods, which can induce inefficiencies and bias into results. The FISH probe targeted 16S rRNA of all known *Dehalococcoides* strains for the samples collected one, five, and eight months following the initiation of whey injections.

The relationships between *Dehalococcoides* and pH and methane (Figure D-8) was evaluated in order to determine if these parameters either directly or indirectly influenced *Dehalococcoides* growth and activity. For pH, *Dehalococcoides* was evaluated from the initial drop in pH to relatively low values immediately following the onset of whey injections through the recovery observed approximately eight months after injections began (Figure D-8). A positive correlation was observed between *Dehalococcoides* concentrations and pH ( $R^2$  values between 0.36-0.42), with increasing concentrations of *Dehalococcoides* with higher pH. In particular, high concentrations of *Dehalococcoides* were not observed within both treatment cells until pH values had recovered to >5.5-6.0 (i.e., pH greater than a threshold value). Almost uniformly within both treatment cells, concentrations of *Dehalococcoides* 16S rRNA, *vcrA*, and *bvcA* genes that exceeded  $10^7$  gene copies/L of groundwater corresponded to pH values >6.0.

Figure D-6 illustrates the FISH and qPCR results. Generally, *Dehalococcoides* concentrations measured using FISH were initially higher one and five months post-initiation of whey injections than measured for qPCR (approximately one to two orders of magnitude higher). Eight months post-whey injections, however, concentrations of *Dehalococcoides* as measured for FISH and qPCR were similar. Similar to qPCR results, no discernable trend between concentrations of *Dehalococcoides* and dechlorination rates could be made. However, concentrations of *Dehalococcoides* greater than  $10^8$  gene copies/L groundwater were observed to correspond with VC and ethene production at all locations evaluated. Therefore,  $10^8$  cells/L in groundwater (as measured by FISH) appears to be the “threshold” above which production of VC and ethene is observed at Fort Lewis.

### ***Methanogen qPCR Results***

qPCR was used to evaluate the response of methanogenic populations during the bioremediation treatment at Fort Lewis. Figure D-9 illustrates the results of qPCR assessment of four methanogenic orders following the initiation of whey injections. One month after whey injections began (July 2005), low concentrations of *Methanosarcinales*, an order containing acetate- and hydrogen-utilizing methanogens, were observed in both treatment cells, and *Methanococcales*, an order containing hydrogen-utilizing methanogens, was observed in treatment cell 1. Five months after whey injections began, concentrations of *Methanosarcinales* increased approximately one to two orders of magnitude in both treatment cells, and the *Methanococcales* were non-detect. Eight and nine months after injections began, concentrations of *Methanosarcinales* increased an additional one to two orders of magnitude. During these latter sampling events, the total concentrations of methanogens were much closer to measured concentrations of total *Archaea*, indicating that methanogens became the predominant *Archaea* at the site. In addition, a correlation between *Dehalococcoides* and methanogens was also sought (data

not shown), and the methanogen target with the highest correlation to *Dehalococcoides* was total *Methanosarcinales* ( $R^2 = 0.66$ ). This suggests that as this population was enriched during the demonstration, so was *Dehalococcoides*.

### ***Results of FISH for Methanogens***

Methanogens were also evaluated using FISH analysis. FISH results indicated higher concentrations of methanogenic populations than qPCR (Figure D-9), especially during the one-month post-whey injection event. The predominant populations were also consistent between sampling events with the *Methanomicrobiales* and *Methanosarcinales* (also *Methanosaeta*, which is included in *Methanosarcinales*) representing 60-70% of the total population. Lower concentrations of *Methanobacteriales* and *Methanococcales* were also consistently detected. Methanogen concentrations increased most dramatically two and five months after whey injection began in both treatment cells.

Figure D-10 illustrates the correlation between concentrations of *Dehalococcoides* and methanogen populations using FISH data. These data illustrate positive correlations ( $R^2 = 0.69-0.81$ ) between increasing concentrations of *Dehalococcoides* and methanogens. Similar to the qPCR data, these data suggest that under bioremediation operations conducted at Fort Lewis, developing an environment that facilitates growth and activity of methanogenic populations also generates conditions conducive to the growth and activity of *Dehalococcoides*.

**Figure D-9. Response of Methanogenic Populations Using qPCR and FISH Following Biostimulation with Whey; Values Represent the Mean (n=4 sampling points for each treatment cell)**

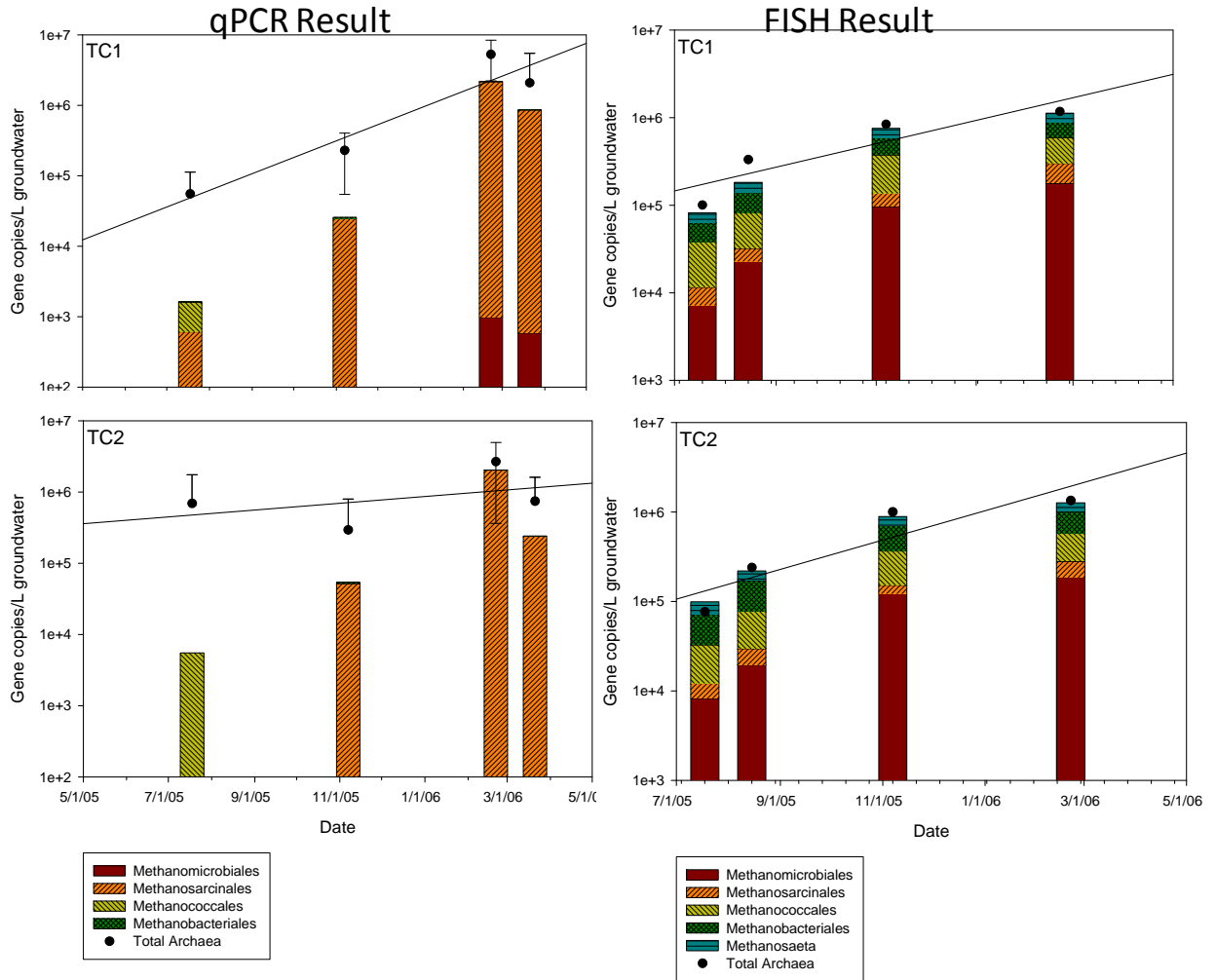

**Figure D-10. Relationship between Methanogenic Populations and *Dehalococcoides* Using FISH during Phase 3 Operations; Values Represent the Mean of Four Sampling Points for each Treatment Cell**

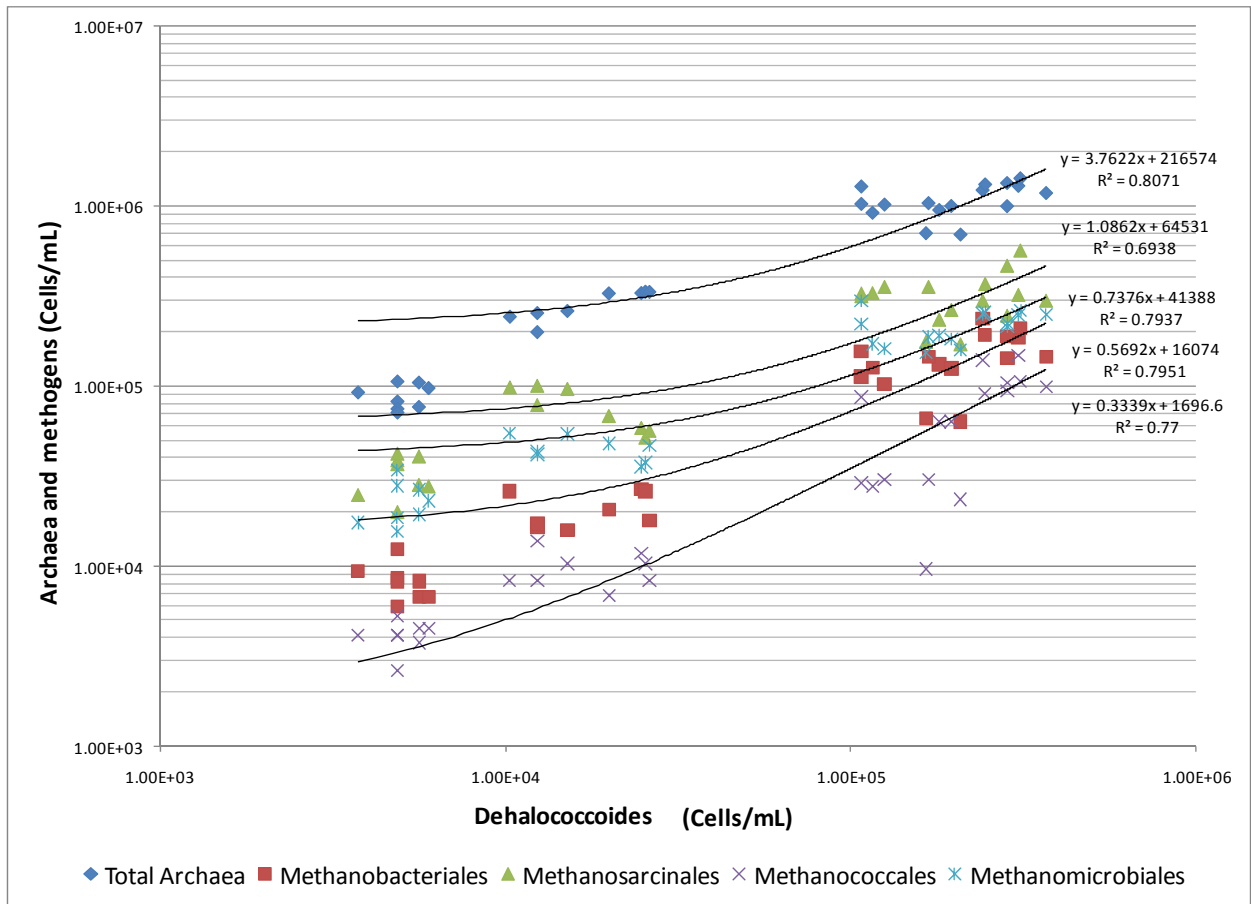

### CSIA Results

CSIA results are presented in Section 8.6.1 of the main report.

### Discussion

Molecular tools provided information on the microbial community dynamics as well as growth and activity of specific microbial populations of interest, such as *Dehalococcoides* and methanogenic populations. A summary of the overall performance evaluation of the tool to assess performance of the ER-0218 demonstration for enhanced bioremediation in a DNAPL source zone includes:

- Community-level T-RFLP profiling:** These data provided information regarding the shift in predominant bacterial and archaeal populations during enrichment of a microbial community using high-concentration whey powder. While these data can provide interesting scientific information regarding community-level dynamics, including insights into important interactions

among populations, they were not necessary to make operational decisions at Fort Lewis.

- **qPCR for *Dehalococcoides*:** These data were extremely useful in evaluating growth and activity of these contaminant-degrading microbes. First, high initial concentrations of indigenous *Dehalococcoides* that included all three reductase genes (*tceA*, *bvcA*, and *vcrA*), followed by growth after whey injection, provided evidence that the bioaugmentation of the site was largely unnecessary. In addition, evaluation of specific strains of *Dehalococcoides* that were native to the site, and not present in the bioaugmentation culture (those exhibiting the *bvcA* gene), verified that native *Dehalococcoides* were enriched during the biostimulation. Evaluation of qPCR data with contaminant and geochemical data was very useful in evaluating conditions necessary to enrich and maintain a *Dehalococcoides* population capable of efficient degradation to ethene. These data were used to determine key environmental factors that impaired contaminant-degrading efficiency (i.e., pH<6.0). These data can be directly used to define key operational criteria for optimization and maintenance of an efficient bioremediation strategy.
- **FISH for *Dehalococcoides*:** These data were also very useful in evaluating growth and activity of *Dehalococcoides*. FISH, however, was essentially redundant to qPCR data. In addition, FISH has not been developed for reductase genes *bvcA*, *vcrA*, and *tceA*, and the technique is more difficult to perform, requires relatively specialized expertise, and is not commercially available.
- **qPCR for methanogenic populations:** These data were very useful for evaluating methanogenic populations. The data suggested the *Methanosarcinales* population, which contains populations capable of both hydrogen- and acetate-utilizing methanogens, predominated the community. A positive correlation was observed between this group and *Dehalococcoides*, suggesting that conditions that facilitated the growth and activity of *Methanosarcinales* also facilitate growth and activity of *Dehalococcoides*. While these data are useful from a scientific standpoint, they were not used to make operational decisions at Fort Lewis. However, these results are consistent with Macbeth et al. (2004) in suggesting that competition for hydrogen between dechlorinators and methanogens is not a significant concern for optimizing electron donor injection strategies at these particular field sites. For Fort Lewis, the use of chemistry data for methane was sufficient to verify whether or not methane-producing conditions necessary for efficient growth and activity of *Dehalococcoides* were present. Routine molecular evaluation of methanogenic populations is likely unnecessary unless site-specific conditions require detailed evaluation of these populations.
- **FISH for methanogenic populations:** Unlike qPCR, FISH probes have been developed to target a wide variety of methanogens, and the evaluation was very comprehensive in terms of capturing a more complete representation of total methanogenic populations. In addition, similar to qPCR data, the FISH

data suggested that *Methanosarcinales* predominated the methanogenic community, but went one step further and verified that within the *Methanosarcinales* order, the *Methanosaeta* family, containing primarily strict acetoclastic methanogens, predominated. One significant difference between the FISH and qPCR data is that FISH data suggested that *Methanomicrobiales*, a hydrogen-utilizing methanogenic population, were nearly equal in number to the *Methanosarcinales* in both treatment cells. This may be due to inefficiency in the DNA extraction and/or primers used for qPCR.

- **CSIA:** CSIA was useful in verifying biological degradation of contaminants, although the method detection limits for VC and ethene were higher than standard analytical techniques. Therefore, at Fort Lewis, CSIA did not provide information regarding the loss in mass balance once cis-DCE was converted to VC and ethene. Had the monitoring been sustained until more of the DCE was transformed to VC and ethene, it is likely CSIA would have been able to show the mass balance in spite of the fact that groundwater concentrations would not have shown it.

## **Seal Beach**

An in-situ enhanced bioremediation pilot test was conducted at Installation Restoration Program Site 40 at Naval Weapons Station Seal Beach, California in support of a feasibility study for the site. Installation Restoration Program Site 40 includes a concrete pit located in the Locomotive Shop (Building 240) and a gravel area located north of and adjacent to the building, which are source areas for a chlorinated solvent plume. Sodium lactate was used to stimulate biological activity, increasing the rate at which PCE was reduced through dechlorination to TCE, DCE, VC, and ethene. The pilot-scale test was conducted in two phases. Phase I involved biostimulation of indigenous bacteria with sodium lactate. During Phase II, bioaugmentation was conducted using a commercially available dechlorinating culture. As this work began in 2001 (early in the development of bioaugmentation), MBTs played a critical role in determining the role of bioaugmentation in facilitating complete reductive dechlorination of PCE to ethene.

### ***Dechlorination Performance Results***

During Phase I, reductive dechlorination was confirmed, but stall at cis-DCE was observed despite conditions conducive to complete dechlorination, including methanogenesis (Figure D-11). MBTs, including PLFA and qPCR for *Dehalococcoides* spp., were employed to determine if bioaugmentation was necessary. Based on qPCR data indicating that *Dehalococcoides* was not present at the site, bioaugmentation was performed at the beginning of Phase II. Shortly after bioaugmentation, cis-DCE concentrations were reduced to low levels, and VC and ethene were observed.

Contaminant mass balance calculations indicated a 97-percent DCE treatment efficiency during Phase II. Not all the treated contaminant mass, however, was recovered as VC and ethene. Soil gas analysis (data not shown) indicated that significant concentrations of VC and ethene partitioned into the gas phase, but estimates of mass in groundwater and soil



gas combined still did not account for all the degraded contaminant. Other factors, such as loss to the atmosphere or oxidative degradation mechanisms may have contributed to the fate of VC and ethene.

**Figure D-11. Reductive Dechlorination Efficiency during Biostimulation (Phase I) with Sodium Lactate Injections Followed by Bioaugmentation (Phase II)**

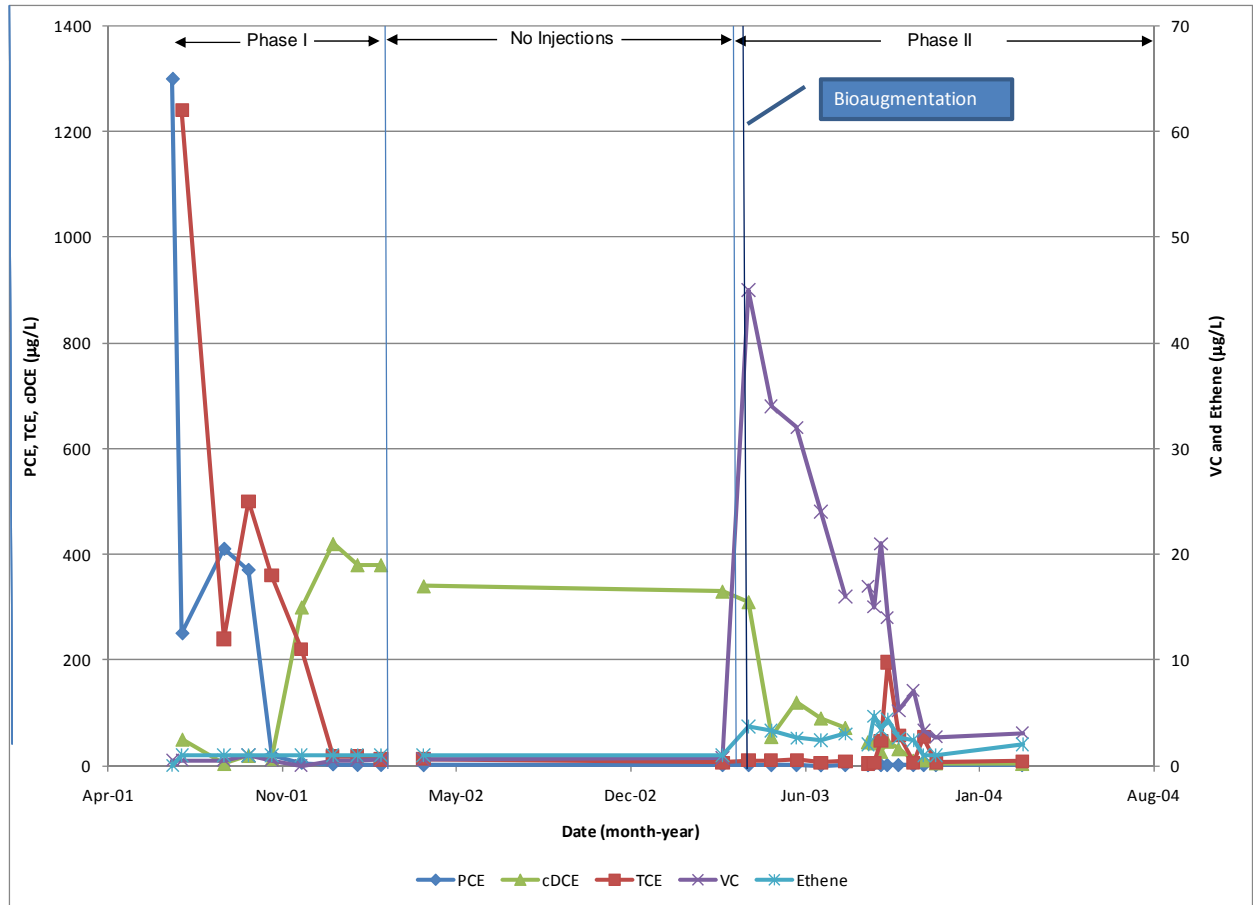

**PLFA Results**

PLFA was used as a general indicator for biomass growth, for changes in the stress conditions experienced by bacteria, and for an overall estimate of the diversity of the microbial community post-Phase 1 lactate injections. Figure D-12 shows the change in biomass measured at several of the monitoring wells during the pilot test. On the basis of the PLFA results, all wells were estimated to have fewer than  $3 \times 10^5$  cells/mL before lactate injection. Biomass increased by more than an order of magnitude, to approximately  $3.5 \times 10^6$  cells/mL, within wells impacted by more than 2 months of lactate injections, providing direct evidence of the general biological growth in response to biostimulation. Where electron donor concentrations were highest, biological activity increased the most, and where no electron donor was observed, no increase in biological activity was observed. Because the PLFA analysis showed convincingly in Phase I that biomass had in fact grown as predicted by all the indirect indicators discussed above

(e.g., dechlorination of PCE to DCE and shift to strongly methanogenic conditions), it was not repeated in Phase II.

**Figure D-12. PLFA-Estimated Biomass Levels at Seal Beach**

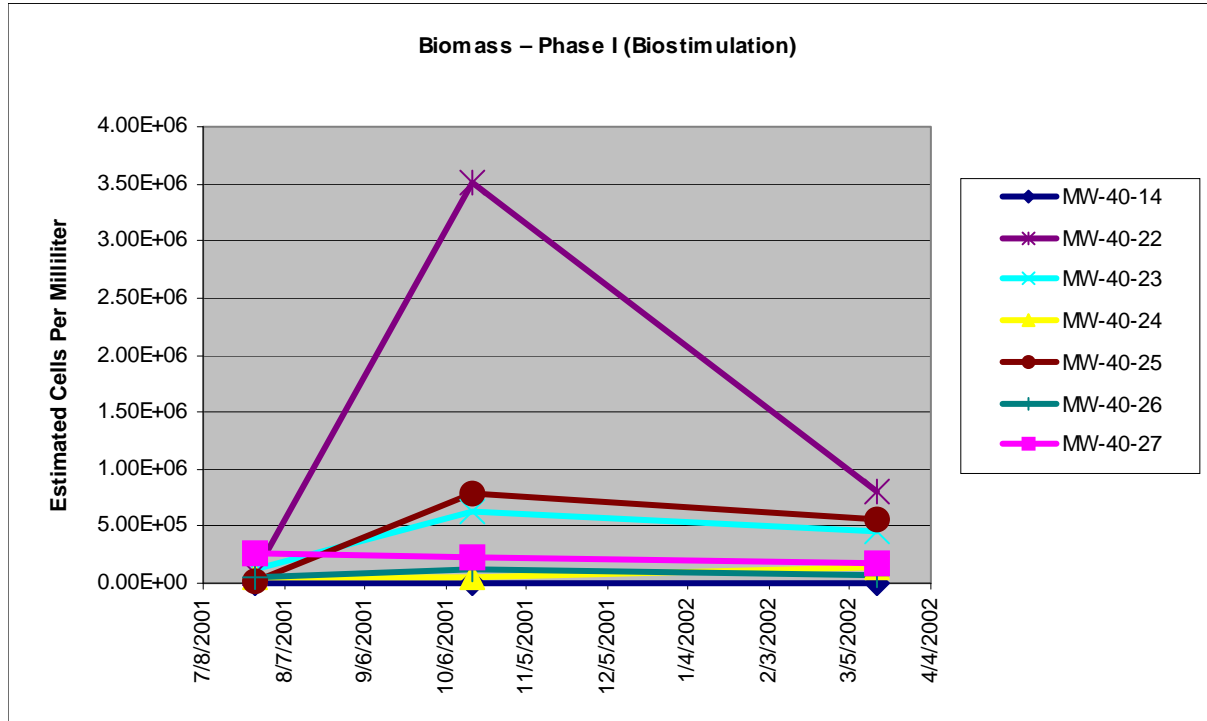

### qPCR Results

During Phase I, no *Dehalococcoides* was detected using qPCR (Figure D-13), which was consistent with the lack of dechlorination beyond cis-DCE. Phase II involved adding a commercially available bioaugmentation culture shown to completely dechlorinate PCE to ethene. qPCR results indicated that following bioaugmentation, *Dehalococcoides* concentrations increased dramatically as cis-DCE concentration declined and VC and ethene were detected in the groundwater and soil gas. In addition, qPCR was used to track the transport of *Dehalococcoides* within the treatment system following injection (Figure D-14). *Dehalococcoides* DNA was reported at high concentrations in both inoculation wells (MW-40-22 and MW-40-25) immediately after inoculation in April 2003. *Dehalococcoides* gene concentrations remained above  $10^7$  gene copies/L throughout Phase II. Three months after inoculation, downgradient monitoring wells MW-40-23 and MW-40-29 were analyzed by qPCR and indicated *Dehalococcoides* had progressed 4.9 m downgradient and 2.5 m upgradient. Concentrations were initially higher in MW-40-23, but within 1 month were equal in both wells at about an order of magnitude less than the inoculation wells, where they remained for the duration of the test. MW-40-24 was analyzed by qPCR after four months post-inoculation, and *Dehalococcoides* was again detected indicating migration of *Dehalococcoides* 12 meters downgradient of the inoculation well.

**Figure D-13. qPCR Results for *Dehalococcoides* sp. 16S rRNA Gene Comparing Concentrations at a Site where Efficient Dechlorination Was Observed (INEEL) and the Seal Beach Site where Cis-DCE Stall Was Observed**

**Figure D-14. Concentrations of *Dehalococcoides* around the Bioaugmentation Well; Inoculation Occurred Mar-03**

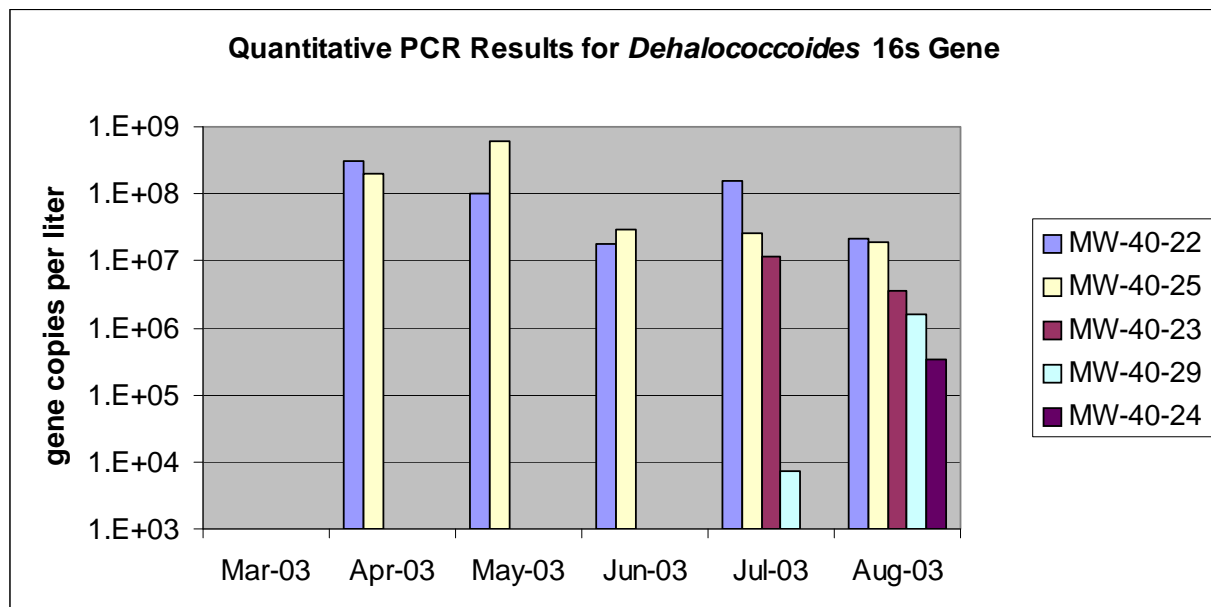

### ***T-RFLP Results***

As discussed in Rahm et al. (2006), the first T-RFLP samples were taken prior to lactate injection. At Seal Beach, the four profiles from July 2001, one month prior to lactate injection, were qualitatively similar to each other and contained roughly the same dominant peaks. Four months later, however, the site had changed significantly: a fragment of approximately 215 bp appeared in soil borings (SB)-25 (MW-40-25), -23 (MW-40-23), and -26 (MW-40-26), and peaks in the 280- to 300-bp region appeared in SB-25. Additional changes were observed in SB-23, where fragments of 400 and 430 bp were lost while a fragment of 520 bp was detected. This shift in community profile likely also reflects the impact of lactate injection. The 513-bp peak, corresponding to *Dehalococcoides* strains, was not detected as a major fragment in any well; however, a minor peak of roughly the correct size was detected in the October sampling of well SB-25.

### ***Conclusions***

- PLFA was useful in determining overall biomass levels, but did not provide significant information that could be used to make decisions regarding bioremediation.
- T-RFLP was useful for making rapid qualitative comparisons of community diversity over time and space. It was not, however, effective at identifying dechlorinating species, or at providing an understanding of how community diversity was linked to degradation activity.
- qPCR measurement of *Dehalococcoides* 16S rDNA provided the most convincing results with respect to evaluating the success of the bioremediation

strategy. The absence of *Dehalococcoides* spp. was correlated to cis-DCE stall. Following bioaugmentation, *Dehalococcoides* increases of several orders of magnitude corresponded to depletion of cis-DCE with detections of VC and ethene (although a mass balance was not observed). In addition, qPCR was used to track transport of *Dehalococcoides* throughout the treatment area after inoculation through a single point, which was important for developing the full-scale design of bioremediation at the site.

## REFERENCES

- Del Nery, V., Pozzib, E., Damianovicb, M.H.R.Z., Dominguesb, M.R., and Zaiat ,M. 2008. Granules characteristics in the vertical profile of a full-scale upflow anaerobic sludge blanket reactor treating poultry slaughterhouse wastewater. *Bioresource Technology*. 99(6): p. 2018-2024.
- Dettmers, D.L., Macbeth, T.W., Sorenson, K.S. Jr., Nelson, L.O., Harris, K.L., Peterson, L.N., Mecham, G.D., and Rothermel, J.S. 2006. Remediation of a TCE plume using a three-component strategy. *Practice Periodical of Hazardous, Toxic, and Radioactive Waste Management*. 10(2): p. 116-125.
- Fazi, S., Aulentab, F., Majoneb, M., and Rossetti, S. 2008. Improved quantification of *Dehalococcoides* species by fluorescence in-situ hybridization and catalyzed reporter deposition. *Systematic and Applied Microbiology*. 31(1): p. 62-7.
- Lee, M.H., Clingenpeel, S.C., Leiser, O.P., Wymore, R.A., Sorenson, K.S. Jr., and Watwood, M.E. 2008a. Activity-dependent labeling of oxygenase enzymes in a trichloroethene-contaminated groundwater site. *Environmental Pollution*. 153(1): p. 238-46.
- Lee, P.K.H., Macbeth, T.W., Sorenson, K.S., Jr., Deeb, R.A., Alvarez-Cohen, L. 2008b. Quantifying genes and transcripts to assess the in-situ physiology of "*Dehalococcoides*" spp. in a trichloroethene-contaminated groundwater site. *Applied and Environmental Microbiology*. 74(9): p. 2728-2739.
- Macbeth, T.W. 2008. Optimization of Enhanced in-situ Bioremediation of a TCE Residual Source Area Derived from Integration of Laboratory Studies with Field Operations in Civil Engineering. University of Idaho: Moscow. p. 155.
- Macbeth, T.W., Cummings, D. E., Spring, S., Petzke, L.M. and Sorenson, K. S. Jr. 2004. Molecular characterization of a dechlorinating community resulting from in-situ biostimulation in a trichloroethene-contaminated deep, fractured basalt aquifer and comparison to a derivative laboratory culture. *Applied and Environmental Microbiology*. 70(12): p. 7329-7341.

- Macbeth, T.W., Harris, K.S., Rothermel, J.S., Wymore, R., Sorenson K. S., and Nelson, L. 2006. Evaluation of whey for bioremediation of trichloroethene source zones. *Bioremediation Journal*. 10(3): p. 115-128.
- McNeil, N.I., Cummings, J. H., and James, W. P. T. 1978. Short chain fatty acid absorbtion by the human large intestine. *Gut*. 19: p. 819-822.
- North Wind, Inc. 2010. Applying Diagnostic Tools for Performance Evaluation of In Situ Bioremediation of a Chlorinated Solvent Source Area. ESTCP Project Number ER-0318.
- Rahm, B.G., Chauhan, S., Holmes, V.F., Macbeth, T.W., Sorenson, K.S. Jr., and Alvarez-Cohen, L. 2006. Molecular characterization of microbial populations at two sites with differing reductive dechlorination abilities. *Biodegradation*. 17(6): p. 523-34.
- Raskin, L., Stromley, J.M., Rittmann, B.E. and Stahl, D.A. 1994a. Group-specific 16S rRNA hybridization probes to describe natural communities of methanogens. *Applied and Environmental Microbiology*. 60(4): p. 1232-40.
- Raskin, L., Poulsen, L.K., Noguera, D.R., Rittmann B.E., and Stahl, D.A. 1994b. Quantification of methanogenic groups in anaerobic biological reactors by oligonucleotide probe hybridization. *Applied and Environmental Microbiology*. 60(4): p. 1241-8.
- Song, D.L., Conrad, M.E., Sorenson, K.S., and Alvarez-Cohen, L. 2002. Stable carbon isotope fractionation during enhanced in-situ bioremediation of trichloroethene. *Environmental Science and Technology*. 36(10): p. 2262-2268.
- Sorenson, K.S., Peterson, L.N., Hincee, R.E., Ely, R.L. 2000. An evaluation of aerobic trichloroethene attenuation using first-order rate estimation. *Bioremediation Journal*. 4(4): p. 337-357.
- Suzuki, M.T., Taylor, L.T., and DeLong, E.F. 2000. Quantitative analysis of small-subunit rRNA genes in mixed microbial populations via 5'-nuclease assays. *Applied and Environmental Microbiology*. 66(11): p. 4605-4614.
- Ueki, A., Abe, K., Kaku, N., Watanabe, K., and Ueki, K. 2008. *Bacteroides propionicifaciens* sp. nov., isolated from rice-straw residue in a methanogenic reactor treating waste from cattle farms. *International Journal of Systematic and Evolutionary Microbiology*. 58(2): p. 346-352.
- Wrong, O.M., ed. 1988. Bacterial metabolism of protein and endogenous nitrogen compounds. In I.R. Rowland (ed.), *Role of the gut flora in toxicity and cancer* (p. 227-262). London, United Kingdom: Academic Press.
- Wymore, R.A., Lee, M.H., Keener, W.K., Miller, A.R., Colwell, F.S., Watwood, M.E., and Sorenson, K.S. Jr. 2007. Field evidence for intrinsic aerobic chlorinated ethene cometabolism by methanotrophs expressing soluble methane monooxygenase. *Bioremediation Journal*. 11(3): p. 125 - 139.

Yu, Y., Lee, C., and Hwang, S. 2005. Analysis of community structures in anaerobic processes using a quantitative real-time PCR method. *Water Science and Technology*. 52(1-2): p. 85-91.