

FINAL REPORT

Development of a Passive Multisampling Method to Measure
Dioxins/Furans and Other Contaminant
Bioavailability in Aquatic Sediments

SERDP Project ER-2538

NOVEMBER 2016

Rainer Lohmann, Ph.D.
University of Rhode Island

Distribution Statement A

This document has been cleared for public release



Page Intentionally Left Blank

This report was prepared under contract to the Department of Defense Strategic Environmental Research and Development Program (SERDP). The publication of this report does not indicate endorsement by the Department of Defense, nor should the contents be construed as reflecting the official policy or position of the Department of Defense. Reference herein to any specific commercial product, process, or service by trade name, trademark, manufacturer, or otherwise, does not necessarily constitute or imply its endorsement, recommendation, or favoring by the Department of Defense.

Page Intentionally Left Blank

REPORT DOCUMENTATION PAGE

Form Approved
OMB No. 0704-0188

Public reporting burden for this collection of information is estimated to average 1 hour per response, including the time for reviewing instructions, searching existing data sources, gathering and maintaining the data needed, and completing and reviewing this collection of information. Send comments regarding this burden estimate or any other aspect of this collection of information, including suggestions for reducing this burden to Department of Defense, Washington Headquarters Services, Directorate for Information Operations and Reports (0704-0188), 1215 Jefferson Davis Highway, Suite 1204, Arlington, VA 22202-4302. Respondents should be aware that notwithstanding any other provision of law, no person shall be subject to any penalty for failing to comply with a collection of information if it does not display a currently valid OMB control number. **PLEASE DO NOT RETURN YOUR FORM TO THE ABOVE ADDRESS.**

1. REPORT DATE (DD-MM-YYYY) 31-05-2016		2. REPORT TYPE FINAL		3. DATES COVERED (From - To) 01-09-2014 - 31-05-2016	
4. TITLE AND SUBTITLE Development of a passive multisampling method to measure Dioxins/Furans and other contaminant bioavailability in aquatic sediments				5a. CONTRACT NUMBER	
				5b. GRANT NUMBER ER2538	
				5c. PROGRAM ELEMENT NUMBER	
6. AUTHOR(S) Lohmann, R Khairy, M.				5d. PROJECT NUMBER	
				5e. TASK NUMBER	
				5f. WORK UNIT NUMBER	
7. PERFORMING ORGANIZATION NAME(S) AND ADDRESS(ES) University of Rhode Island South Ferry Road Narragansett RI 02882 USA				8. PERFORMING ORGANIZATION REPORT NUMBER	
9. SPONSORING / MONITORING AGENCY NAME(S) AND ADDRESS(ES) SERDP 4800 Mark Center Drive, Suite 17D08 Alexandria, Virginia 22350-3605				10. SPONSOR/MONITOR'S ACRONYM(S)	
				11. SPONSOR/MONITOR'S REPORT NUMBER(S)	
12. DISTRIBUTION / AVAILABILITY STATEMENT Approved for public release; distribution is unlimited					
13. SUPPLEMENTARY NOTES					
14. ABSTRACT The project developed a passive sampling method utilizing polyethylene samplers to sample dioxins/furans and a wide range of other hydrophobic organic contaminants <i>in situ</i> , both in sediment and the overlying water column. The sampler was tested to work both in sediments and overlying surface waters at several sites along the Passaic River (NJ). Contaminant concentrations resulting from the multi-sampler deployments were compared with their concentrations in benthic invertebrates to demonstrate the ability to predict tissue concentrations. Good agreement was generally observed between porewater concentrations obtained in the laboratory and the <i>in situ</i> sampler for dioxins/furans and PCBs, implying that the sampler performed well. Lipid normalized PCDD/Fs were better estimated in the current study from porewater and river water for the majority of the congeners.					
15. SUBJECT TERMS					
16. SECURITY CLASSIFICATION OF:			17. LIMITATION OF ABSTRACT	18. NUMBER OF PAGES	19a. NAME OF RESPONSIBLE PERSON Rainer Lohmann
a. REPORT	b. ABSTRACT	c. THIS PAGE			19b. TELEPHONE NUMBER (include area code) 401-874-6612

Page Intentionally Left Blank

Table of Contents

List of Figures	ii
List of Tables in the Supplementary data	iii
List of Acronyms	iv
Keywords	v
Acknowledgment	v
Abstract	1
Objectives	3
Background	4
1- Passive sampling of HOC	4
2- Estimating biota HOC uptake	5
Materials and methods	5
1- Collection of the sediment samples	5
2- Collection of the biota samples	6
3- Deployment of the sediment porewater sampler system	7
4- Sediment tumbling experiment	7
5- Deployment of PEs in the water for measuring the truly dissolved concentrations	8
6- Extraction and cleanup of Pes	8
7- Extraction and cleanup of sediments and biota	10
8- Instrumental analysis of PCBs and PCDD/Fs	10
9- Determination of total organic carbon (TOC) and black carbon (BC) content	11
Results and Discussion	12
3. Porewater concentrations of PCBs and PCDD/Fs	12
3.1. PCBs	12
3.2. PCDD/Fs	13
4. Comparison of different PRC approaches for PCDD/Fs	14
5. Freely dissolved concentrations of PCBs and PCDD/Fs	17
5.1. PCBs	17
5.2. PCDD/Fs	18
6. Concentrations of POPs in the sediment samples	19
6.1. PCBs	19
6.2. PCDD/Fs	19
7. Concentrations of POPs in the benthic species	21
7.1. PCBs	21
7.2. PCDD/Fs	21
8. Estimation of the uptake of PCBs and PCDD/Fs by benthic species	23
Conclusions and implications for future research	33
References	35

List of Figures

Figure 1: Sampling of sediments and biota and deployment locations of the porewater sampler system and water PEs.	6
Figure 2: The porewater sampler system deployed in sediments of the lower Passaic River, NJ.	7
Figure 3: Prototype deployment casing for multi-sampler PE sheets in surface waters.	8
Figure 4: Deployment locations of LDPE in the water.	9
Figure 5: Estimated porewater concentrations of PCBs in the lower Passaic River from the tumbling experiment and the <i>in situ</i> sediment porewater sampler. The <i>in situ</i> sampler bars represent the average of 4 deployments and the error bars represent the standard deviation.	13
Figure 6: Estimated porewater concentrations of PCDD/Fs in the lower Passaic River from the tumbling experiment and the <i>in situ</i> sediment porewater sampler. The <i>in situ</i> sampler bars represent the average of 4 deployments and the error bars represent the standard deviation.	14
Figure 7: Comparison of using either a combination of d-PAHs and ¹³ C ₁₂ -PCDDs as PRCs, solely the ¹³ C ₁₂ -PCDDs, or just the d-PAHs for correcting passive sampler porewater concentration for non-equilibrium at one of the sampling sites (Riverbank Park).	15
Figure 8: Comparison of using either a combination of d-PAHs and ¹³ C ₁₂ -PCDDs as PRCs, solely the ¹³ C ₁₂ -PCDDs, or just the d-PAHs for correcting passive sampler porewater concentration for non-equilibrium using the tumbling experiment for Riverbank Park sediments.	15
Figure 9: Comparison of using either a combination of d-PAHs and ¹³ C ₁₂ -PCDDs as PRCs, solely the ¹³ C ₁₂ -PCDDs, or just the d-PAHs for correcting in situ passive sampler porewater concentration for non-equilibrium to the tumbling experiment using d-PAHs for non-equilibrium correction for Riverbank Park sediments.	16
Figure 10: Average freely dissolved concentrations of PCBs (pg/L) of the three deployments at each of the sampling sites. Error bars represent the standard deviation.	17
Figure 11: Average freely dissolved concentrations of PCDD/Fs (pg/L) of the three deployments at each of the sampling sites. Error bars represent the standard deviation.	18
Figure 12: Contributions of the PCB homologous groups in Passaic River sediment.	19
Figure 13: Contribution of the PCDD/F homologous groups in Passaic River sediment.	20
Figure 14: Contribution of the TEQ of PCDD/Fs in Passaic River sediment.	20
Figure 15: Contributions of the homologous groups of PCBs in Passaic River benthic species.	21
Figure 16: Contribution of the homologous groups of PCDD/Fs in benthic species of the Passaic River.	22
Figure 17: % contribution of the TEQ of PCDD/Fs in benthic species of the Passaic River.	22
Figure 18: Ratios of estimated versus measured lipid normalized concentrations of PCBs in the mud crabs and tube worms samples from Site 1. Predictions based on (a) overlying water concentrations from passive samplers; (b) porewater concentrations from in situ passive samplers; (c) sediment concentrations accounting for both OC+BC; (d) sediment concentrations accounting for OC.	23
Figure 19: Ratios of estimated versus measured lipid normalized concentrations of PCBs in the clams and shrimp samples from Site 3. Predictions based on (a) overlying water concentrations from passive samplers; (b) porewater concentrations from in situ passive samplers; (c) sediment concentrations accounting for both OC+BC; (d) sediment concentrations accounting for OC.	24
Figure 20: Ratios of estimated versus measured lipid normalized concentrations of PCBs in the tube worm sample from Site 4. Predictions based on (a) overlying water concentrations from passive samplers; (b) porewater concentrations from in situ passive samplers; (c) sediment concentrations accounting for both OC+BC; (d) sediment concentrations accounting for OC.	25

Figure 21: Ratios of estimated versus measured lipid normalized concentrations of PCDD/Fs in the mud crabs and tube worm samples from Site 1. Predictions based on (a) overlying water concentrations from passive samplers; (b) porewater concentrations from in situ passive samplers; (c) sediment concentrations accounting for both OC+BC; (d) sediment concentrations accounting for OC.	25
Figure 22: Ratios of estimated versus measured lipid normalized concentrations of PCDD/Fs in the clams and shrimp samples from Site 3. Predictions based on (a) overlying water concentrations from passive samplers; (b) porewater concentrations from in situ passive samplers; (c) sediment concentrations accounting for both OC+BC; (d) sediment concentrations accounting for OC.	26
Figure 23: Ratios of estimated versus measured lipid normalized concentrations of PCDD/Fs in the tube worms from Site 4. Predictions based on (a) overlying water concentrations from passive samplers; (b) porewater concentrations from in situ passive samplers; (c) sediment concentrations accounting for both OC+BC; (d) sediment concentrations accounting for OC.	26
Figure 24: Estimated \sum_{89} PCB concentrations in the porewater (a) and river water (b) using LDPE passive samplers.	27
Figure 25: Estimated \sum_{27} PCDD/F concentrations in the porewater (a) and river water (b) using LDPE passive samplers.	28
Figure 26: Log transformed chemical activities of PCBs (a) and PCDD/Fs in the porewater and river water estimated from LDPE passive samplers at the lower Passaic River.	28
Figure 27: Average sum PCBs (pg/L) along the Passaic River (2011-2012) as a function of river mile.	29
Figure 28: Sum PCBs (pg/L) and water temperature along the Passaic River (2011-2012) over a 1-year period, listed by river mile, where each deployment lasted approximately 2 months each.	30
Figure 29: Sum PBDEs (pg/L) along the Passaic River (2011-2012).	31
Figure 30: Sum PBDEs (pg/L) and water temperature along the Passaic River by river mile (2011-2012).	31

List of Tables in the Supplementary data

Table S1: Porewater concentrations of PCBs (pg/L) at River Bank Park, Passaic River.	A2
Table S2: Porewater concentrations of PCBs (pg/L) at Bridge street, Passaic River.	A4
Table S3: Porewater concentrations of PCBs (pg/L) at Doremus street, Passaic River.	A6
Table S4: Porewater concentrations of PCBs (pg/L) at Passaic Ave, Passaic River.	A8
Table S5: Porewater concentrations of PCDD/Fs (pg/L) at River Bank Park, Passaic River.	A10
Table S6: Porewater concentrations of PCDD/Fs (pg/L) at Bridge Street, Passaic River.	A11
Table S7: Porewater concentrations of PCDD/Fs (pg/L) at Doremus Street, Passaic River.	A12
Table S8: Porewater concentrations of PCDD/Fs (pg/L) at Passaic Ave, Passaic River.	A13
Table S9: Freely dissolved concentrations of PCBs (pg/L) at the Passaic River.	A14
Table S10: Freely dissolved concentrations of PCDD/Fs (pg/L) at the Passaic River.	A18
Table S11: Concentrations of PCBs (ng/g dw) in sediments collected from the lower Passaic River.	A20
Table S12: Concentrations of PCDD/Fs (pg/g dw) in lower Passaic River sediments	A22
Table S13: Concentrations of PCBs (ng/g lipid) in lower Passaic River benthic species	A23
Table S14: Concentrations of PCDD/Fs (pg/g lipid) in lower Passaic River benthic species	A25

List of Acronyms

a_w – chemical activity
BAF – bioaccumulation factor
BC – black carbon
 $C_{lip,OC}$ – estimated lipid concentrations from sediment organic carbon partitioning
 $C_{lip,OC+BC}$ – lipid concentration based on sediment's organic carbon and black carbon
 $C_{lip,PEdw}$ – lipid concentrations based on deep water concentrations
 $C_{lip,PEpw}$ – lipid concentrations based on porewater concentrations
 C_{PE} – concentration in PE membrane
 C_{sed} – concentration in sediments
 $C_{W,app}$ – apparent dissolved HOC concentration
 $C_{W,corr}$ – DOC corrected apparent dissolved HOC concentration
 $C_{W,diss}$ – freely dissolved aqueous concentration
DCM – dichloromethane
DiCDD- dichlorinated dibenzo-*p*-dioxin
DiCDF - dichlorinated dibenzofuran
dioxins/furans – polychlorinated dibenzo-*p*-dioxins and dibenzofurans
DOC – dissolved organic carbon
DoD – Department of Defense
 f_{oc} – organic carbon fraction
 f_{Bc} – black carbon fraction
GC-MS/MS – gas chromatograph coupled to tandem mass spectrometric analyzer
GFF – glass fiber filter
HOCs - hydrophobic organic contaminants
HpCDD - heptachlorinated dibenzo-*p*-dioxin
HpCDF - heptachlorinated dibenzofuran
HxCDD - hexachlorinated dibenzo-*p*-dioxin
HxCDF - hexachlorinated dibenzofuran
 K_{BC} – black carbon–water equilibrium partition constant
 K_{DOCw} – DOC and water equilibrium partition constant
 K_{OC} – organic carbon–water equilibrium partition constant
 K_{ow} – octanol–water equilibrium partition constant
 K_{PEw} – PE-water equilibrium partition constant
LDPE – low density polyethylene
NIST – National Institute of Standards and Technology
OC – organic carbon
OCDD - octachlorinated dibenzo-*p*-dioxin
OCDF - octachlorinated dibenzofuran
OCPs – organochlorine pesticides
PAHs – polycyclic aromatic hydrocarbons
PBBs – polybrominated biphenyls
PBDEs – polybrominated diphenyl ethers
PCBs – polychlorinated biphenyls
PCDD/Fs - dioxins/furans – polychlorinated dibenzo-*p*-dioxins and dibenzofurans
PE – polyethylene
PeCDD- pentachlorinated dibenzo-*p*-dioxin

PeCDF - pentachlorinated dibenzofuran
POPs – persistent organic pollutants
PRC – performance reference compound
PSD – passive sampling device
PUF – polyurethane foam
QA – quality assurance
QC – quality control
RPM – remedial project manager
SERDP – strategic environmental research and development program
SEED – SERDP exploratory development
 S_w – water solubility
TCDD- tetrachlorinated dibenzo-*p*-dioxin
TCDF - tetrachlorinated dibenzofuran
TEQ – toxic equivalents
TOC– total organic carbon
TriCDD- trichlorinated dibenzo-*p*-dioxin
TriCDF - trichlorinated dibenzofuran

Keywords

Passive sampling, dioxins, furans, PCBs, PBDEs, porewater, dissolved, bioaccumulation

Acknowledgments

We thank Kirk Barrett (Manhattan College) for help with field deployments along the Passaic River, and previous support by the Hudson River Foundation for passive sampler work on dioxins/furans.

Abstract

Objectives:

The main research objective was to develop a passive sampling method utilizing polyethylene (PE) samplers to sample dioxins/furans and a wide range of other hydrophobic organic contaminants *in situ*. Other than dioxins/furans, we targeted polychlorinated biphenyls (PCBs) and polybrominated diphenylethers (PBDEs) with the same passive sampling devices.

Furthermore, we proposed to field-test the passive sampling device to sample truly dissolved dioxins/furans and other contaminants both in sediments as well as in the overlying surface water. The proposed PE sampler could be used both as an equilibrium passive sampler for some smaller molecular weight compounds, but needed to rely on performance reference compounds for most dioxins/furans and PBDEs. The specific research objective supported the main interest by SERDP and SEED to simplify and speed up acquisition of relevant exposure to contaminants of interest. Following this research it will then be possible to design and implement projects at contaminated sites to aid in remediation decision making. This will include both pre-cleanup design and post-cleanup monitoring of contaminated sites.

Technical approach:

The technical approach was subdivided into the following 4 tasks:

Task (1): Construction of a new sediment-borne passive multi-sampler, and deployment at several sites along the Passaic River, known to be contaminated by dioxins/furans, and various other organic contaminants. Ground-truth field-deployed porewater concentrations by comparing them to porewater concentrations derived from field-collected sediments, and their equilibration with passive samplers in the laboratory.

Task (2): Deployment of passive samplers in the surface waters of the Passaic River to measure truly dissolved concentrations of dioxins/furans and other contaminants at several sites along the Passaic River.

Task (3): Collection of sediment and different benthic invertebrates from the sites where the sediment-borne passive multi-sampler is deployed, and measure tissue-concentrations of dioxins/furans and other HOCs. Compare porewater concentrations to geochemistry and the animals' lipid-normalized concentrations.

Task (4): Assessment of porewater and truly dissolved concentrations of dioxins/furans at several sites along the Passaic River, and comparison to sediment and water concentrations at the same sites. Demonstrate that the passive multi-samplers yield representative spatial and temporal interrogation of site contaminants when deployed.

Samplers were deployed four times at four different locations along the lower Passaic River in the period from June, 2015 to February, 2016; sediment and biota were also collected. All samples were analyzed for mono- through octa-chlorinated dioxins and furans, and PCBs.

Results:

In the *in situ* porewater samplers, loss rates of PRCs were significantly lower than loss rates in the tumbling experiment ($p < 0.01$). After performing the disequilibrium correction and estimating the porewater concentrations of PCBs and PCDD/Fs, good agreement was generally observed between concentrations measured with the tumbling experiment using two different thicknesses and the *in situ* sampler with RSD % ranging from 0.3 – 39 % for PCBs and 1.0 – 22 % for PCDD/Fs in the four samples. Accordingly, we fulfilled the most important objective of this study which is the construction of an *in situ* porewater sampler that can be used to estimate porewater concentrations.

Concentrations of \sum_{89} PCBs in the porewater as obtained from the *in situ* sampler ranged from 2.0 ng/L (site S1) to 5.0 ng/L (site S2) with an average concentration of 3.0 ng/L. Concentrations of porewater at S2 were significantly higher (at $p < 0.01$) than concentrations at the other sites. Samples were dominated by tri-, tetra- and di-chlorinated biphenyls comprising 86 – 89 % of the total PCB concentrations in the Passaic River. PCDD/F concentrations in porewater generally ranged from 24 pg/L (S1) to 41 pg/L (S3) with an average concentration of 32 pg/L. In general concentrations of furans were higher than dioxin concentrations in the samples. All samples were dominated by the lower chlorinated furans (mono-, di- and tri-) and 2,7/2,8-CDD comprising on average 97 % of the total PCDD/F concentrations in the porewater. Based on the obtained porewater results, our newly constructed sampler was able to determine some spatial and temporal variability in the detected concentrations of PCDD/Fs and PCBs at the sampling locations and thus fulfilling our second major objective of this project.

Freely dissolved concentrations of PCBs in the river water ranged from 1.3 ng/L to 1.8 ng/L, with no statistical significant difference between the different sampling sites. Samples were dominated by the tri-homologous group comprising 43 – 48 %. Concentrations of PCDD/Fs generally ranged from 19 pg/L (S1) to 39 pg/L (S4) with an average concentration of 25 pg/L. Similar to the porewater results, samples were dominated by the lower chlorinated congeners (mono- through tri-chlorinated furans and di-chlorinated dioxins) comprising > 93 % of the total concentrations.

Lipid normalized concentrations of PCBs and PCDD/Fs were estimated from sediment, porewater and river water and compared to measured lipid normalized concentrations in the benthic species. Porewater and sediments using the BC + OC scenario were generally better predictors of lipid concentrations of PCBs and PCDD/Fs. Additionally, good prediction of the lower chlorinated PCBs (mono- through tetra-) were also obtained from the river water (PEs deployed in the water column above the bottom sediments). The only exception was PCBs in the shrimp, which were better predicted from river water for the majority of the investigated PCB congeners.

Based on our results, exposure to porewater and to a lesser extent river water and the probable ingestion of sediment particles are the possible sources of bioaccumulation of PCBs and PCDD/Fs in the lower Passaic River, which may indicate that deployed PEs (either in the river water or the sediments) could predict tissue concentrations of the benthic species and that our constructed *in situ* porewater sampler device can be successfully applied as a fast reliable method to study the exposure of species to hydrophobic contaminants and hence can be applied at DoD sites.

Benefits:

The specific research objective supported the main interest by SERDP and SEED to simplify and speed up acquisition of relevant exposure to contaminants of interest *in situ*. Following this research, it will then be possible to design and implement projects at current DoD sites to aid in remediation decision making. Benefits of the sampler deployments include optimization of both pre-cleanup design and post-cleanup monitoring of contaminated sites. Potential deployments include contaminated sites such as the Lower Willamette River (WA) and Newark Bay (NY/NJ), where PCDD/Fs and other organic contaminants, including PCBs, are of concern. The field-tested sampler developed and validated as part of this project can be used to determine temporal and spatial contaminants concentrations in porewater and water column, and be used to predict the bioaccumulation of these contaminants in benthic invertebrates at these sites.

Objectives

The main objective of this work was to develop and field-test an *in situ* passive multi-sampling method utilizing polyethylene (PE) samplers to quantify polychlorinated dibenzo-*p*-dioxins and dibenzofurans (PCDD/Fs), and other hydrophobic organic contaminants, such as polychlorinated biphenyls (PCBs). The sampler was tested to work both in sediments and overlying surface waters at several sites along the Passaic River (NJ). Contaminant concentrations resulting from the multi-sampler deployments were compared with their concentrations in benthic invertebrates to demonstrate the ability to predict tissue concentrations. The developed and field-tested PE sampler combined working as an equilibrium passive sampler for some lower chlorinated biphenyls and dioxins, but relied on performance reference compounds for most dioxins/furans, PCBs and PBDEs. The specific objectives of the research were

- 1- Construction, deployment and validation of a sediment porewater multi-sampler for dioxins/furans and other HOCs;
- 2- Validate PE porewater/water column multi-sampler concentrations as a proxy for bioaccumulation of dioxins/furans and other HOCs by benthic invertebrates; and
- 3- Demonstrate across multiple sites the viability of the passive multi-sampler to yield representative spatial and temporal interrogation of site contaminants when deployed.

The technology development directly addressed the objectives expressed in SERDP's FY 2015 Statement of Need in the Environmental Restoration Program Area:

(1) 'Develop passive sampling methodologies for one of the following groups of contaminants: dioxin/furans'; and

(2) 'Develop a multi-purpose passive sampling device capable of collecting data on several contaminants of interest; A multi-purpose sampling device could include measurement of multiple hydrophobic organic compounds, metals, or munitions compounds in sediment and the immediate overlying surface water'.

The development of a passive multi-sampler also met the following requirements sought by SERDP, namely:

(3) Passive sampler measurements that can be used as surrogates for tissue contaminant measures in benthic and pelagic organisms; and

(4) Passive samplers that yield representative spatial and temporal interrogation of site contaminants when deployed.

The specific research objective supported the main interest by SERDP and SEED to simplify and speed up acquisition of relevant exposure to contaminants of interest *in situ*. Following this research, it will then be possible to design and implement projects at current DoD sites to aid in remediation decision making. This will include both pre-cleanup design and post-cleanup monitoring of contaminated sites. Examples include contaminated sites such as the Lower Willamette River (WA) and Newark Bay (NY/NJ), where PCDD/Fs and other organic contaminants, including PCBs, are of concern. The field-tested sampler developed and validated as part of this project can be used to determine temporal and spatial contaminants concentrations in porewater and water column, and be used to predict the bioaccumulation of these contaminants in benthic invertebrates at these sites.

Background

1) Passive sampling of HOC

Passive sampling methods can measure the concentration of freely dissolved contaminants ($C_{w, \text{diss}}$), which is directly related to the contaminants' chemical activity (α_w)¹:

$$\alpha_w = C_{w, \text{diss}} / S_w \quad (1)$$

where S_w is the contaminant solubility in water (at the same temperature and salinity). The difference in chemical activity between the two compartments quantifies the potential for spontaneous uptake. This also indicates the bioavailability or pressure (fugacity) of contaminants on organisms² and consequently represents the exposure level for organisms. Consequently, $C_{w, \text{diss}}$ provides a more relevant dose metric than total sediment concentration. Recent developments in passive sampling methods have significantly improved our ability to reliably measure even very low levels of $C_{w, \text{diss}}$. Application of passive sampler methods in sediments is preferably conducted in the equilibrium regime, where freely dissolved concentrations in the sediment are well linked to the measured concentration in the sampler via analyte-specific partition ratios.³

Passive samplers, such as PE sheets, take up organic compounds from the water column via molecular diffusion until phase equilibrium is reached.^{1,4,5} Uptake is driven by the difference in chemical activity between the PSD and the surrounding environment. At equilibrium, the measured PE concentration (C_{PE}), together with the corresponding PE-water partition coefficients (K_{PEw}), can be used to quantify the compound's freely dissolved concentration ($C_{w, \text{diss}}$);

$$C_{w, \text{diss}} = C_{PE} / K_{PEw} \quad (2)$$

Nonpolar passive sampling devices absorb hydrophobic compounds from the aqueous phase and concentrate them to a level that can be easily analyzed with standard equipment, thereby avoiding the procedural errors that result from the processing of large water volumes needed in batch water sampling. The partitioning behavior of PE sheets used in this study is well known under a range of temperatures and salinities.⁶ We have successfully deployed PE sheets to measure concentrations of dissolved PAHs^{7,8} PCBs⁹, PBDEs¹⁰ and emerging contaminants.¹¹

K_{PEw} have been measured for various PCBs and PCDDs⁶, and can be extrapolated by relying on correlations with octanol-water partitioning constants (K_{ow})¹², or aqueous solubility.¹³ As needed, partition coefficients are adjusted for temperature and salinity, using enthalpies of phase change (dissolution, vaporization and air-water partitioning) from Shiu and Ma¹⁴ for PCDD/Fs and from Schenker et al.¹⁵ for PCBs. Comparisons suggests that derived dissolved concentrations from PE samplers are within a factor of two-to-three of snapshot water samples extracted with solvents.⁶

The inclusion of performance reference compounds (PRCs) enables passive samplers to be calibrated *in situ*, thereby accounting for changes in currents, temperature or membrane properties

due to biofouling *etc.* PRCs are compounds included in the passive sampler prior to deployment.^{16,17} PRCs do not occur in the natural environment, guaranteeing that there is only a 1-dimensional flux out of the sampler.

In this work, PRCs were included in the passive samplers deployed in the lower Passaic River. PRCs enable the determination of dissolved POP concentrations even for the heavier molecular weight compounds which will not have reached equilibrium during the exposure time in the field.

2) Estimating biota HOC uptake

Lipid concentrations (ng/g) are estimated from each sorbent phase (OC, OC+BC, porewater PE, and deep water PE) and compared to those measured in tissues (C_{lip}). Lipid concentrations are estimated from sediment OC partitioning ($C_{lip,OC}$) as the product of dissolved concentrations (ng/mL) and the bioaccumulation factor (BAF; unitless) as follows:

$$C_{lip,OC} = C_{diss,OC} BAF = \frac{C_{sed} BAF}{f_{oc} K_{oc}} \quad (3)$$

where C_{sed} is the HOC concentration in the sediment (ng/g), f_{oc} is the fraction of OC in the sediment, and K_{oc} is the OC–water partition coefficient (mL water/g OC).

Similarly, lipid concentrations based on sediment OC and BC ($C_{lip,OC+BC}$) are estimated as the product of the BAF and dissolved concentrations¹⁸ using a Freundlich coefficient of $n = 0.7$:

$$C_{lip,OC+BC} = C_{diss,OC+BC} BAF = \frac{C_{sed} BAF}{f_{oc} K_{oc} + f_{bc} K_{bc} C_{diss}^{n-1}} \quad (4)$$

where f_{bc} is the fraction of BC in the sediment and K_{bc} is the BC–water partition coefficient (mL water/g BC).

Lipid concentrations from porewater ($C_{lip,PEpw}$) and deep water ($C_{lip,PEdw}$) are estimated from PE uptake as follows:

$$C_{lip,PE} = C_{diss,PE} BAF = \frac{C_{PE,so} BAF}{K_{PE-w}} \quad (5)$$

where K_{PE-w} is the PE-water partition coefficient (mL water/g PE).

Materials and Methods

1) Collection of the sediment samples

Four surficial sediment samples were collected during July, 2015 at 4 locations (identified in Figure 1) in the lower Passaic River (RKM 29.6–0). All sediment samples were collected from

mudflats at low tide. A glass jar (previously washed with soap and water and baked at 450 °C for 4 h) was filled by scooping mud by hand using a shovel. The material from the dredge was immediately transferred to a jar, kept in an ice box, and shipped frozen to our laboratory. Samples were then kept in a freezer at -20 °C until extraction and analysis.

2) Collection of the biota samples

We aimed to collect benthic biota from the 4 locations of the sediment samples. However, biota was only found at 3 locations including Sites 1, 3 and 4. At Site 1, tiny mud crab with length 1-1.5 cm (n = 25) were collected from the mud after sieving. Additionally, deposit-feeding tube worms (*Pectinaria gouldii*) were collected from the same location.



Figure 1: Sampling of sediments and biota and deployment locations of the porewater sampler system and water PEs.

At Site 3, Clams (*Mya arenaria*) (n = 60) and shrimp (n = 5) were collected and stored separately. At Site 4, deposit-feeding tube worms (*Pectinaria gouldii*) were collected. Collections of the tube worms were repeated until approximately 1 g of tissue had been collected. Biota were rinsed with tap water, placed in muffled amber jars, and frozen on dry ice.

3) Deployment of the sediment porewater sampler system

The porewater multisamplers were deployed at 4 different locations along the lower Passaic River, NJ (Figure 1). The system consisted of a small, 100 cm x 100 cm frame that held the PE strip in the upper 5 cm of sediment *in situ* (Figure 2). As the concentrations of dioxins/furans in sediments are low (at the pg/g level), and their sorption to carbonaceous particles is high, their mobility in the sediment is greatly reduced. The sampler is thus designed to expose a maximum surface area for a considerable length of time. At each site, four sampling campaigns (~ 6 weeks each) were performed during June, 2015 through February, 2016 (n = 16).

PEs were cut from commercial sheeting (Carlisle Plastics, Inc., Minneapolis, MN) with a thickness of 51 μm , yielding a 10 \times 86 cm strip of ~3.5–4 g each. PEs were pre-cleaned twice in dichloromethane (DCM) and n-hexane for 24 h respectively. After pre-cleaning, PEs were immersed in an 80:20 (v/v) methanol/water solution spiked with performance reference compounds (PRCs) at a nominal concentration of 5 μg per sampler in methanol for 30 days.¹⁶

As in our previous work^{19–22} on PAHs, PCBs, OCPs and PBDEs, the following performance reference compounds (PRCs) were used: 2,5-dibromobiphenyl (PBB 9), 2,2',5,5'-tetrabromobiphenyl (PBB 52), 2,2',4,5',6-pentabromobiphenyl (PBB 103) and octachloronaphthalene for PCBs and fluorene-d₁₀, pyrene-d₁₀, benzo(a)pyrene-d₁₂ for PCDD/Fs. As these PRCs were potentially not ideal surrogates for PCDD/Fs, PE samplers for the last deployment (January-February, 2016) were also spiked with labelled PCDD/Fs namely ¹³C₁₂ 2,3-DiCDD, ¹³C₁₂ 1,3,6,8-TCDD and ¹³C₁₂ 1,2,3,4,6,7,8-HxCDD, to serve as PRCs in addition to the deuterated PAHs.

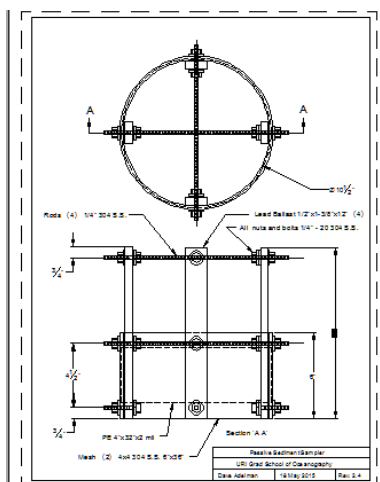

Figure 2: Diagram showing the porewater sampler system deployed in sediments of the lower Passaic River, NJ.

4) Sediment tumbling experiment

As a control to the *in situ* porewater sampler system, sediment samples were collected from the 4 locations and taken back to the laboratory for porewater measurements under agitation according to the method developed in our lab.²³ Briefly, PE sheets were cut and cleaned as detailed in the previous section. Two thicknesses were used for each sample: 25 and 51 μm . PEs were cut with appropriate dimensions to give final weights of 0.7 and 1.2 g for the 25 and 51 μm thicknesses

respectively. For each sample, approximately 100 g wet weight sediments (40-60 g dry weight) were added to a 500 mL glass jar together with a PE sheet, sodium azide (final concentration in the flask = 0.43 $\mu\text{mol/mL}$) and Milli-Q filtered water. The jar was filled with water such that the amount of air in the jar was minimized once sealed. A blank (composed of all the components excluding the sediments) for each PE size was run with the samples. Samples were placed on a shaker table and agitated for 8 weeks. The shaker table was kept in an environmental chamber at $20 \pm 1^\circ\text{C}$ during the shaking period. All PEs used were spiked with PRCs as shown in the previous section.

5) Deployment of PEs in the water for measuring the truly dissolved concentrations

PEs were cut from commercial sheeting (Carlisle Plastics, Inc., Minneapolis, MN) with a thickness of 51 μm , yielding a 10×30 cm strip of $\sim 1\text{--}2$ g. PEs were pre-cleaned and spiked with PRCs as detailed earlier. PEs were placed in a stainless steel-based passive sampler housing (Figure 3) and deployed in duplicates at the 4 sampling sites of the sediments (Figure 1) in the overlying water column. At each site, four sampling campaigns (~ 6 weeks each) were performed during June, 2015 through February, 2016 ($n = 32$). In our previous work²⁴, we deployed LDPE passive along the lower Passaic River (Figure 4). Water samplers were fastened to an anchored rope and suspended in water $\sim 1\text{--}2$ m below the surface. Six sampling campaigns (~ 2 months each) were performed during September, 2011 through November, 2012. Six deployments (2 months each from November, 2011 till November, 2012) were done at each of the six selected sampling locations.

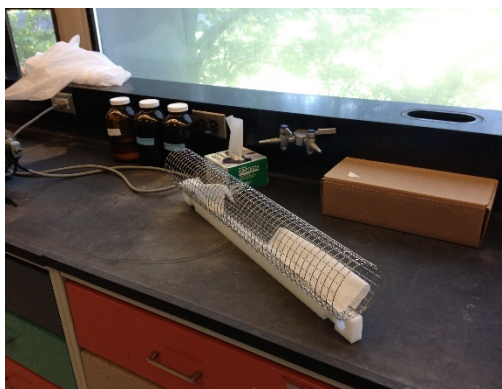

Figure 3: Prototype deployment casing for multi-sampler PE sheets in surface waters.

6) Extraction and cleanup of PEs

The following procedure applies for any PEs used in the current study (*in situ* sediment deployments, water deployments and tumbling experiment) and the 2011-2012 samples.

LDPEs were cold extracted with n-hexane for 24 hours after spiking with 10 μL of a surrogate standard mixture (in nonane) composed of labeled PCBs ($^{13}\text{C}_{12}$ PCB 3, 8, 28, 52, 118, 138, 180, 194, 206, 209; 0.2 ng/ μL) and labeled PCDDs ($^{13}\text{C}_{12}$ 2-CDD, 2-CDF, 2,7- DiCDD, 2,8-DiCDF,

2,3,7-TrCDF, 2,3,7,8- TCDD, 2,3,7,8-TCDF, 1,2,3,7,8-PeCDD, 1,2,3,7,8-PeCDF, 1,2,3,6,7,8-HxCDD, 1,2,3,6,7,8-HxCDF, 1,2,3,4,6,7,8-HpCDD, 1,2,3,4,6,7,8-HpCDF, OCDD; 0.2 ng/μL).



Figure 4: Deployment locations of LDPE in the water.

Extracts were then concentrated to ~1 mL, and further concentrated to ~50 μL under a gentle stream of nitrogen. To that end, samples were spiked with 10 μL of d₁₄-terphenyl (0.2 ng/μL) as injection standards and analyzed for the PRCs used for PCDD/Fs correction for disequilibrium. Before PCB analysis, PE extracts were passed over SPE cartridges filled with 1g active silica gel and 2 g 44 % H₂SO₄ impregnated silica gel.

PCDD/Fs and PCBs were eluted with 50 mL of DCM/hexane (30:70 % v: v). Cleaned extracts were then concentrated (as mentioned earlier in this section) and 10 μL of 2,4,6-tribromobiphenyl (0.2 ng/ μL in nonane) were added as injection standard for PCBs. After this step, samples were analyzed for PCBs. For dioxin analysis, extracts were brought to 1 mL in hexane, and passed through an activated carbon column (0.8 cm i.d filled with 1 g activated carbon/silica gel 5 % w/w) that was preconditioned with toluene and n-hexane. The column was eluted with 200 ml DCM/hexane (25:75, v:v; F1). PCBs were eluted in this fraction. The column was then turned over, and all the other PCDD/Fs were eluted with 100 mL of toluene (F2).²⁵ Toluene extracts were then concentrated to 0.5 mL in the Turbovap at 45°C and 5 psi. Samples were further concentrated to ~25 μL by gently blowing with ultrahigh purity N₂ gas (~1 psi). d₁₀- anthracene was added as an injection standard (10 μL of 0.2 ng/μL solution) for PCDD/Fs analysis.

7) Extraction and cleanup of sediments and biota

Briefly, Sediment (biota samples) samples were mixed with anhydrous sodium sulfate, spiked with labeled surrogates and soxhlet extracted with n-hexane-methylene chloride (1:1, v:v) solvent mixture for 24 hours. For biota samples, portions of the soxhlet extracts were taken to determine the lipid content gravimetrically. Extracts were then concentrated and passed on a multilayer silica column composed from the bottom to top of potassium silicate (4 g), silica gel 1 g), 44 % sulfuric acid impregnated silica gel (9 g), 22 % sulfuric acid impregnated silica gel (9 g), silica gel (1 g), silver nitrate impregnated silica gel (3 g) and sodium sulfate (3 g) to remove co-extracts (lipids). Cleaned extracts were then concentrated, and analyzed for PCBs after adding the injection standard (see the previous section). For PCDD/F analysis, samples were passed on an activated carbon/silica column to separate PCBs from PCDD/Fs as detailed in the previous section.

8) Instrumental analysis of PCBs, PBDEs and PCDD/Fs

89 PCB congeners were measured with a gas chromatography coupled with to a triple quadrupole mass spectrometry. A 30-m long x 0.25-mm I.D. fused silica capillary column with DB-5MS bonded phase, or equivalent was used for GC/MSMS analyses. A triple quadrupole system (Quattro micro tandem MS, waters) operating at 70 eV (nominal) in the electron impact ionization mode and tuned to maximize the sensitivity of the instrument for the mass range 69- 264 amu of daughter ions was used for MRM analysis. The GC capillary column is inserted directly into the ion source of the mass spectrometer. The analytical method for PCB detection is functionally equivalent to the U.S. EPA method 1668b.²⁶ A total of 89 individual PCB congeners (including additional co-eluting congeners) were targeted to analyze all dominant congeners, including all those identified by NOAA and WHO.

A computer system interfaced to the mass spectrometer continuously acquires and stores mass spectra throughout the duration of the chromatographic program. A mass spectrum can be obtained for each peak of interest utilizing background subtraction techniques. The following temperature program was used for the analysis of PCBs, surrogates and PRCs: initial oven temperature was set at 75 °C for 3 minutes, then the temperature ramped at a rate of 15 °C/min to 150 °C (0 min), then ramped at 2 °C/min to 260 °C (0 min), and finally ramped at 20 °C/min to a final temperature of 300 °C and held at this temperature for 1 min. The injector and interface line temperatures were set at 270 °C.

The 13 PCDD congeners: 2-CDD, 2,7-DiCDD, 2,8-DiCDD, 2,3,7-TriCDD, 1,3,6,8-TCDD, 1,3,7,8-TCDD, 1,2,8,9-TCDD and the 2,3,7,8- substituted toxic congeners (2,3,7,8-TCDD, 1,2,3,7,8-PeCDD, 1,2,3,4,7,8- HxCDD, 1,2,3,6,7,8-HxCDD, 1,2,3,7,8,9-HxCDD, 1,2,3,4,6,7,8-HpCDD and OCDD) and 12 PCDF congeners: 2-CDF, 2,8-DiCDF, 2,4,8-TriCDF, 2,3,7,8-TCDF, 1,2,3,7,8-PeCDF, 2,3,4,7,8-PeCDF 1,2,3,4,7,8-HxCDF, 1,2,3,6,7,8-HxCDF, 1,2,3,7,8,9-HxCDF, 2,3,4,6,7,8-HxCDF, 1,2,3,4,6,7,8-HpCDF, 1,2,3,4,7,8,9-HpCDF and OCDF were analyzed in the PE, sediments and biota samples. The same GC/MSMS system used for PCBs was used for the PCDD/F analysis. A 60-m long x 0.25-mm I.D. fused silica capillary column with DB-5MS HT bonded phase was used for PCDD/F analysis. The PCDD/F analysis is functionally equivalent to USEPA method 1613.²⁷ The targeted dioxin and furan congeners include all 2,3,7,8-substituted ones (the WHO list).

In 2011-2012 samples, 29 PCB congeners were analyzed as shown above. PBDEs were analysed on the same GC/MSMS system using a 30-m long x 0.25-mm I.D. fused silica capillary column with DB-5MS bonded phase according to the following temperature program: initial oven temperature was maintained at 101 °C for 3 minutes, followed by a ramp at a rate of 5.0 °C/min until reaching 315 °C and remaining at this temperature for 5.0 minutes. The inlet and GC interface temperatures were both maintained at 300 °C. Helium was used as carrier gas and was adjusted at a flow rate of 1.3 ml/min. The source temperature was set at 200 °C. Quantification was accomplished through the application of a 7-point calibration curve by running a series of standards containing the surrogate standards (100 pg/μL), injection standards and native compounds (1.0-500 pg/μL). Relative response factors were derived for each compound and used to correct the peak area for differences in ionization between analytes.

9) Determination of total organic carbon (TOC) and black carbon (BC) content

TOC and BC content were determined in the sediment samples according to the method detailed in Gustafsson et al.²⁸. OC was determined by subtracting BC content from TOC.

Results and Discussion

The results section will discuss results in the task order.

Task (1): Construction of a new sediment-borne passive multi-sampler, and deployment at several sites along the Passaic River, known to be contaminated by dioxins/furans, and various other organic contaminants. Ground-truth field-deployed porewater concentrations by comparing them to porewater concentrations derived from field-collected sediments, and their equilibration with passive samplers in the laboratory.

During the project, the sediment-borne passive multi-sampler was adopted to be easily deployable while enabling us to measure dioxins/furans and other contaminants in the porewater. The initial double-ringed design (to have duplicate samplers deployed at the same site) was abandoned as it created a strong resistance for sediment deployments. The simpler design contained only 1 circle of double mesh within which the PE was deployed (Figure 2). Lead weights helped the multi-sampler penetrate into the sediment easily. PE sheets remained larger than for other SERDP projects to allow sufficient mass of dioxins/furans to accumulate and overcome our analytical detection limits. The porewater multisamplers were successfully deployed at 4 different locations along the lower Passaic River, NJ (Figure 1).

3. Porewater concentrations of PCBs and PCDD/Fs

In the current study, porewater concentrations were determined by two ways: tumbling experiment in the laboratory using two different PE thicknesses and by the deployment of the *in situ* sediment porewater sampler. As mentioned earlier, all the PEs were spiked with PRCs before deployment. We used these PRCs to correct for disequilibrium. In case of the tumbling experiment, disequilibrium correction was performed according to the method of Booij and Smedes²⁹. For the *in situ* deployed sediment porewater samplers, we used the software available from MIT to correct for disequilibrium according to the method developed by Gschwend et al.³⁰.

3.1. PCBs

Estimated porewater concentrations of PCBs from the tumbling experiment and the *in situ* sampler are given in Tables (S1 – S4). For the *in situ* samplers, loss rates of PRCs were significantly lower than loss rates in the tumbling experiment ($p < 0.01$). However, after performing the disequilibrium correction and estimating the porewater concentrations of PCBs, good agreement was generally observed between concentrations measured with the tumbling experiment using two different thicknesses and the *in situ* sampler (Figure 5a - d) with RSD % ranging from 0.3 – 39 % in the four samples.

For discussing the spatial distribution and patterns of PCBs in the porewater, we will use the data obtained from the *in situ* sampler. Concentrations of \sum_{89} PCBs ranged from 2.0 ng/L (S1) to 5.0 ng/L (S2) with an average concentration of 3.0 ng/L. Concentrations of porewater at S2 were significantly higher (at $p < 0.01$) than concentrations at all the other stations which showed comparable results (Tables S5-S9). The most abundant congeners were PCB 18, 16+32, 28+31, 43+52, and 42+44+59 comprising on average 67 % of the total PCB concentrations. As shown in Figure (5), samples were dominated by tri-, tetra- and di-chlorinated biphenyls comprising 86 – 89 % of the total PCB concentrations in the Passaic River.

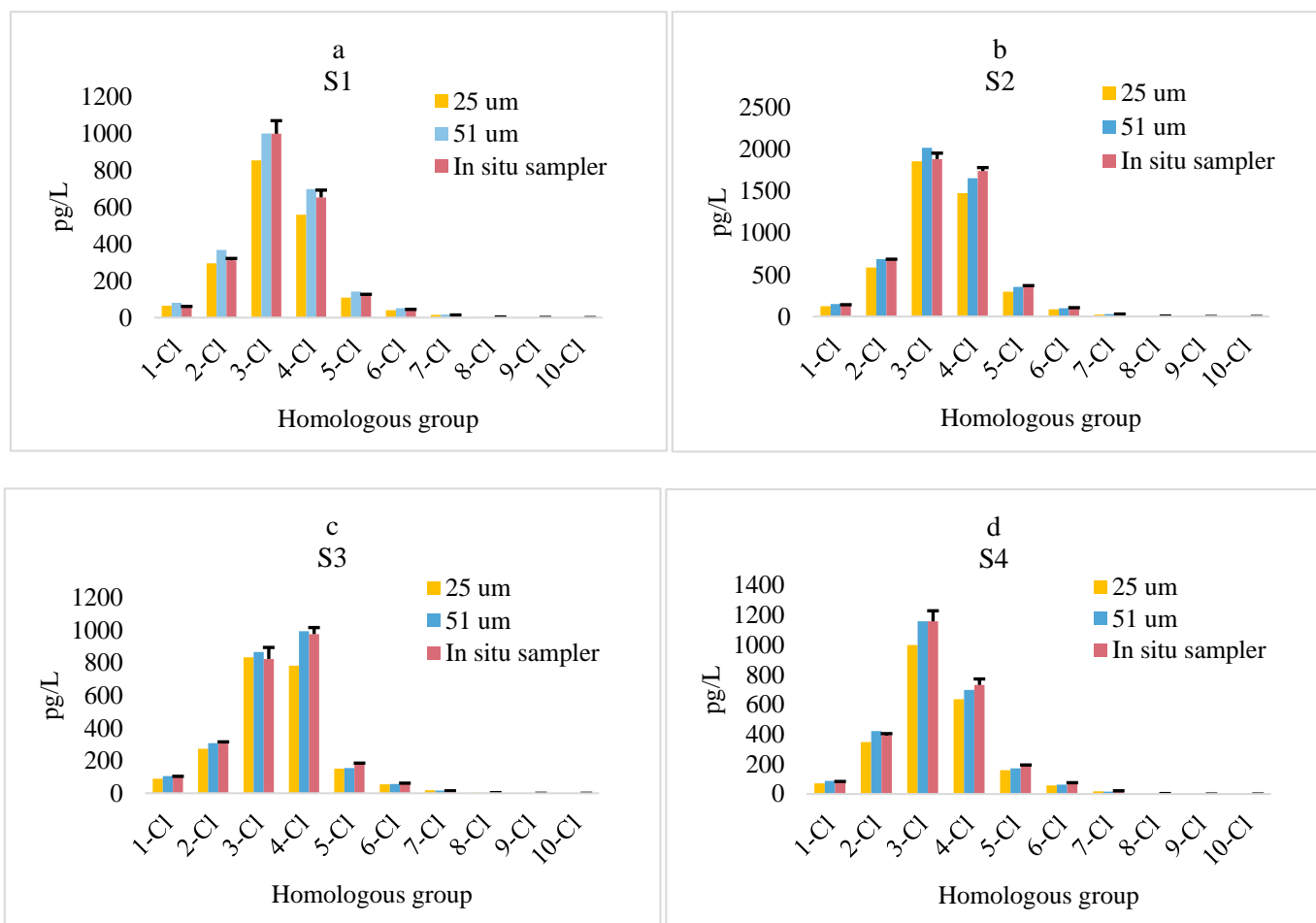

Figure 5: Estimated porewater concentrations of PCBs in the lower Passaic River from the tumbling experiment and the *in situ* sediment porewater sampler. The *in situ* sampler bars represent the average of 4 deployments and the error bars represent the standard deviation. S1: Riverbank Park; S2: Bridge Street; S3: Passaic Avenue; S4: Doremous Street.

3.2. PCDD/Fs

Estimated porewater concentrations of PCDD/Fs from the tumbling experiment and the *in situ* sampler are given in Tables (S5 – S8). Good agreement was generally observed between concentrations measured with the tumbling experiment using two different thicknesses and the *in situ* sampler (Figure 6a - d) with RSD % ranging from 1.0 – 22 % in the four samples. As for the PCBs, discussion from here after will focus on the obtained results from the *in situ* porewater samplers. PCDD/F concentrations generally ranged from 24 pg/L (S1) to 41 pg/L (S3) with an average concentration of 32 pg/L. 2-CDD, 1,3,7,8-TCDD, 1,2,8,9-TCDD, 1,2,3,4,7-PeCDD, 1,2,3,6,7,8-HxCDF, 1,2,3,7,8,9-HxCDF, 2,3,4,6,7,8-HxCDF, 1,2,3,4,7,8-HxCDD, 1,2,3,7,8,9-HxCDD and 1,2,3,4,7,8,9-HpCDF were <LOD in all the samples. In general concentrations of furans were higher than dioxin concentrations in the samples. All samples were dominated by the lower chlorinated furans (mon-, di- and tri-) and 2,7/2,8-CDD (Figure 6) comprising on average 97 % of the total PCDD/F concentrations in the porewater.

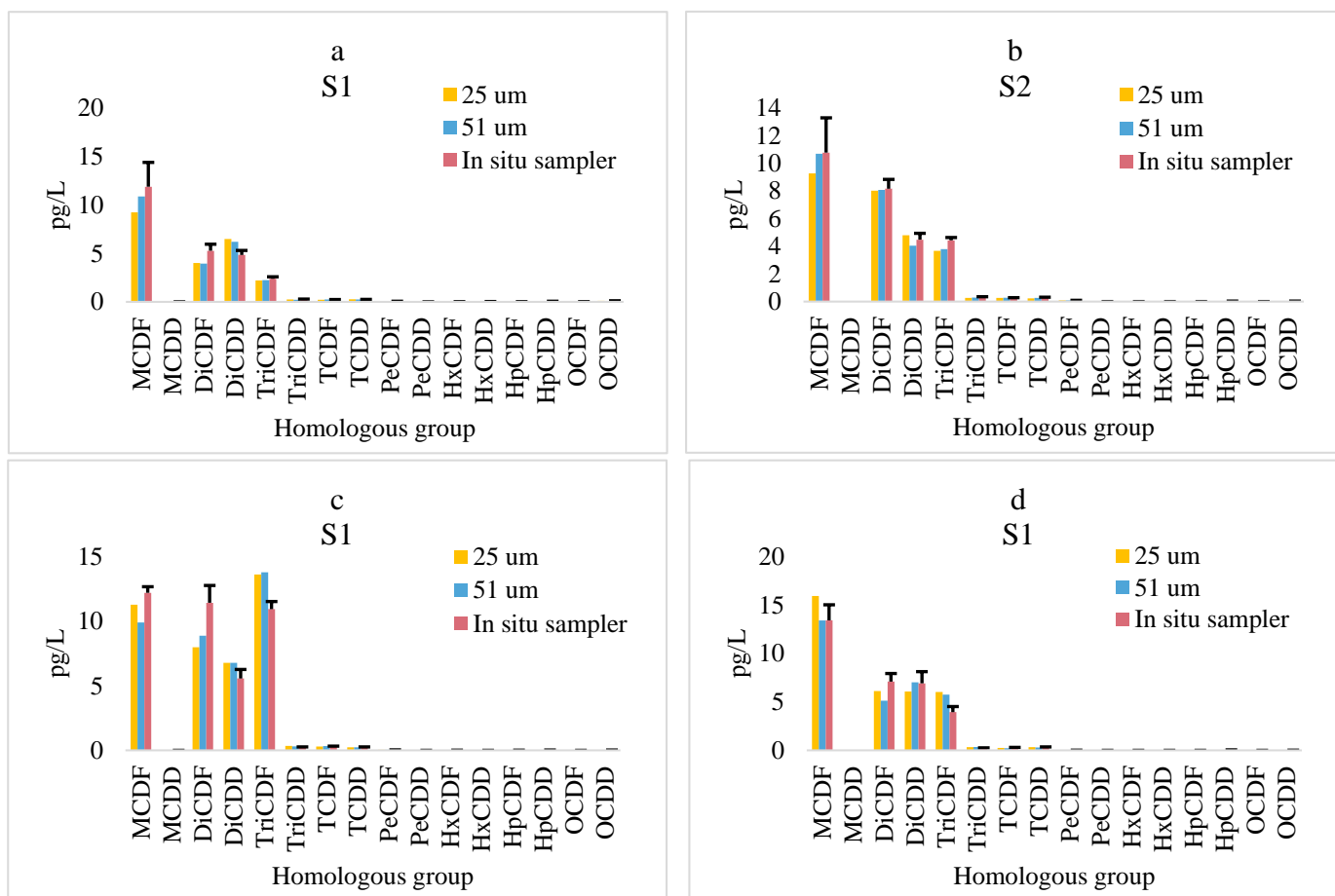

Figure 6: Estimated porewater concentrations of PCDD/Fs in the lower Passaic River from the tumbling experiment and the *in situ* sediment porewater sampler. The *in situ* sampler bars represent the average of 4 deployments and the error bars represent the standard deviation. S1: Riverbank Park; S2: Bridge Street; S3: Passaic Avenue; S4: Doremous Street.

In terms of toxic equivalents, concentrations generally ranged from 0.18 pg TEQ/L (S1) to 0.22 pg TEQ/L (S3), and all the samples were dominated by the 2,3,7,8-TCDD comprising 64 -73 % of the total TEQ concentrations in the porewater.

4. Comparison of different PRC approaches for PCDD/Fs

During the project, concerns were raised whether the use of the generic PRCs we were using (d-PAHs) was adequate for accurately predicting PCDD/F equilibration in the field. We therefore performed one additional field deployment with passive samplers that also contained several $^{13}\text{C}_{12}$ -PCDDs. The comparison relies on the laboratory equilibrations representing the ‘true’ porewater concentrations. Slightly different results are obtained whether we use a combination of d-PAHs and $^{13}\text{C}_{12}$ -PCDDs as PRCs, solely the $^{13}\text{C}_{12}$ -PCDDs, or just the d-PAHs (Figure 7). For the tumbling experiment, the same comparison was made which showed much lower differences between the three approaches (RSD % < 13 %) that in the *in situ* samplers (Figure 8).

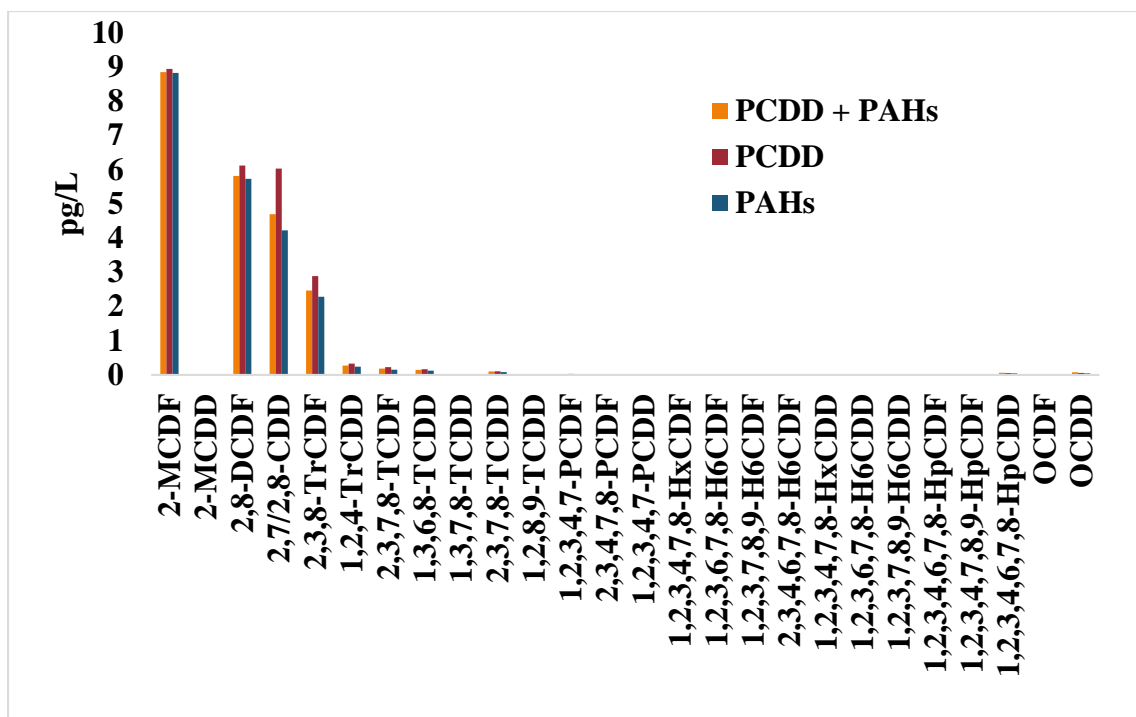

Figure 7: Comparison of using either a combination of d-PAHs and $^{13}\text{C}_{12}$ -PCDDs as PRCs, solely the $^{13}\text{C}_{12}$ -PCDDs, or just the d-PAHs for correcting passive sampler porewater concentration for non-equilibrium at one of the sampling sites (Riverbank Park).

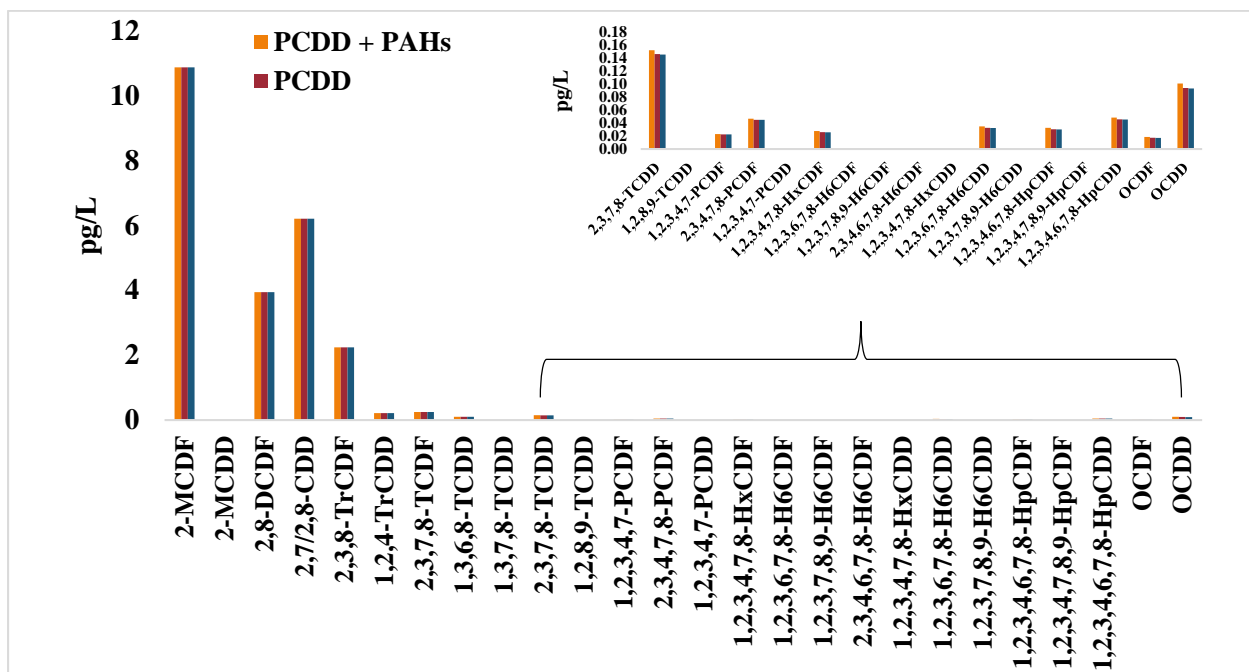

Figure 8: Comparison of using either a combination of d-PAHs and $^{13}\text{C}_{12}$ -PCDDs as PRCs, solely the $^{13}\text{C}_{12}$ -PCDDs, or just the d-PAHs for correcting passive sampler porewater concentration for non-equilibrium using the tumbling experiment for Riverbank Park sediments.

We then compared the results of the tumbling experiment obtained using the PAH PRCs only with the results of the *in situ* experiment using the three PRC approaches (Figure 9). Based on the average relative percent differences (RPD %), the following descending order was observed: d-PAH (47 %) > $^{13}\text{C}_{12}$ -PCDDs (33 %) > d-PAHs + $^{13}\text{C}_{12}$ -PCDDs (30 %).

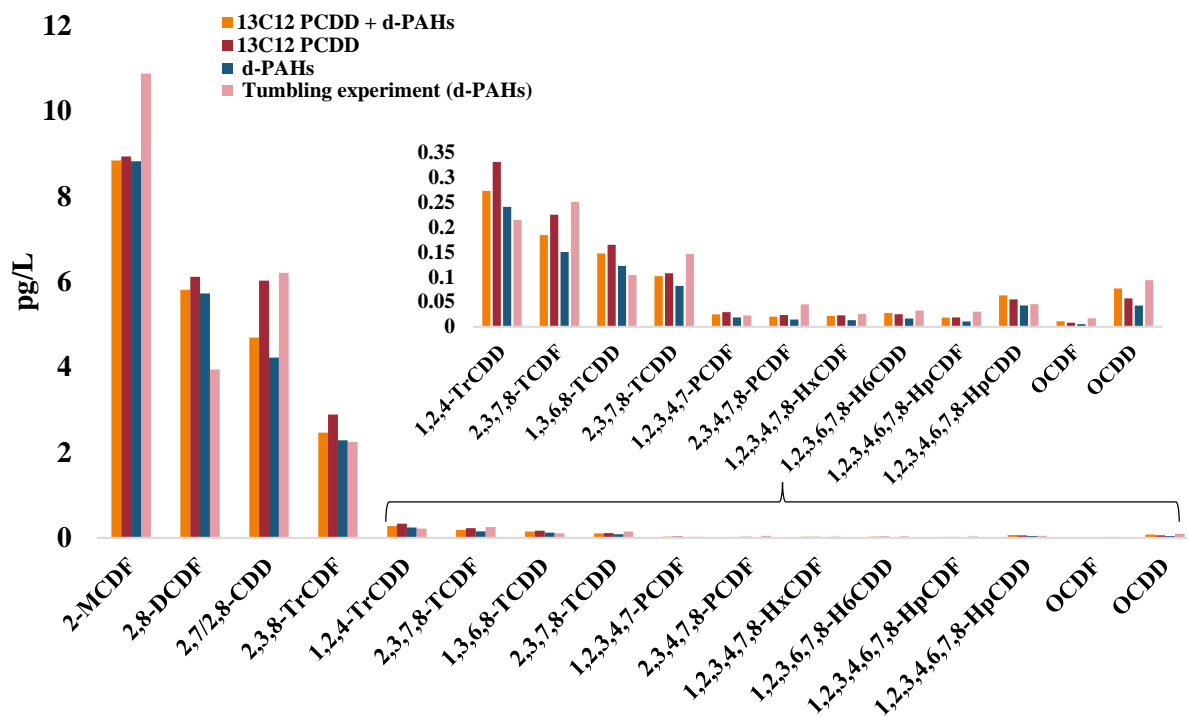

Figure 9: Comparison of using either a combination of d-PAHs and $^{13}\text{C}_{12}$ -PCDDs as PRCs, solely the $^{13}\text{C}_{12}$ -PCDDs, or just the d-PAHs for correcting *in situ* passive sampler porewater concentration for non-equilibrium to the tumbling experiment using d-PAHs for non-equilibrium correction for Riverbank Park sediments.

Based on the obtained results, it can be concluded that either of the three PRC approaches worked much better in the tumbling experiment, which was designed to approach equilibrium, hence corrections were less important than for *in situ* deployments. For the *in situ* multisampler deployments, there is some benefit of using both d-PAHs + $^{13}\text{C}_{12}$ -PCDDs for PCDD/Fs quantitation. Overall, we'd recommend including both as PRCs for the quantification of dioxins/furans.

In summary for our work related to task 1, the modified multisampler was successfully deployed at several sediment sites along the lower Passaic River. Porewater concentrations for PCBs and PCDD/Fs from *in situ* sampling compared well with those from laboratory equilibrations with the same sediments, highlighting the applicability of the *in situ* sampler. As concerns the appropriate choice of PRCs for multi-sampler deployments targeting dioxins/furans in the field, there is some

evidence that including both d-PAHs + $^{13}\text{C}_{12}$ -PCDDs for PCDD/Fs gives better results than solely relying on d-PAHs. There is a cost increase associated with this increased accuracy, though.

We thus met the main SERDP objectives by developing/using a porewater multi sampler:

(1) ‘Develop passive sampling methodologies for one of the following groups of contaminants: dioxin/furans’; and

(2) ‘Develop a multi-purpose passive sampling device capable of collecting data on several contaminants of interest; A multi-purpose sampling device could include measurement of multiple hydrophobic organic compounds, metals, or munitions compounds in sediment and the immediate overlying surface water’.

Task (2): Deployment of passive samplers in the surface waters of the Passaic River to measure truly dissolved concentrations of dioxins/furans and other contaminants at several sites along the Passaic River.

5. Freely dissolved concentrations of PCBs and PCDD/Fs

Three PE deployments were done at three sites including Sites 1, 3 and 4. No statistical significant difference was observed between the detected freely dissolved concentrations of the three deployments for PCBs and PCDD/Fs (except PCBs at Site 1). Accordingly, the discussion here after will be based on the average concentration of the three deployments at each site.

5.1. PCBs

Estimated freely dissolved concentrations of PCBs at the sampling sites are given in Table (S9). Freely dissolved concentrations of PCBs ranged from 1.3 ng/L to 1.8 ng/L, with no statistical significant difference between the different sampling sites. Samples were dominated by the tri-homologous group comprising 43 – 48 % (Figure 10) of the total PCB concentrations followed by tetra- (30 – 34 %) and di- homologous group (9.0 – 14 %). This observed pattern is close to what was observed in the porewater (Figure 5).

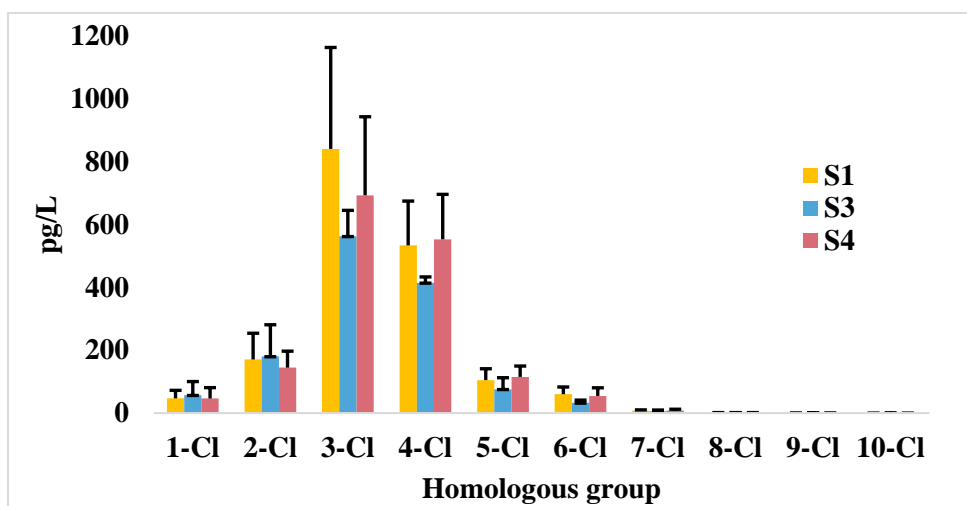

Figure 10: Average freely dissolved concentrations of PCBs (pg/L) of the three deployments at each of the sampling sites. Error bars represent the standard deviation. S1: Riverbank Park; S3: Passaic Avenue; S4: Doremous Street.

5.2) PCDD/Fs

Estimated freely dissolved concentrations of PCDD/Fs at the three sampling sites are given in Table (S10). Concentrations generally ranged from 19 pg/L (Site 1) to 39 pg/L (Site 4) with an average concentration of 25 pg/L. As for the porewater, samples were dominated by the lower chlorinated congeners (mono- through tri-chlorinated furans and di-chlorinated dioxins) comprising > 93 % of the total concentrations (Figure 11). In terms of TEQ, concentrations ranged from 0.16 pg TEQ/L to 0.33 pg TEQ/L. 2,3,7,8-TCDD was the dominant congener comprising 27 – 82 % of the total TEQ concentrations.

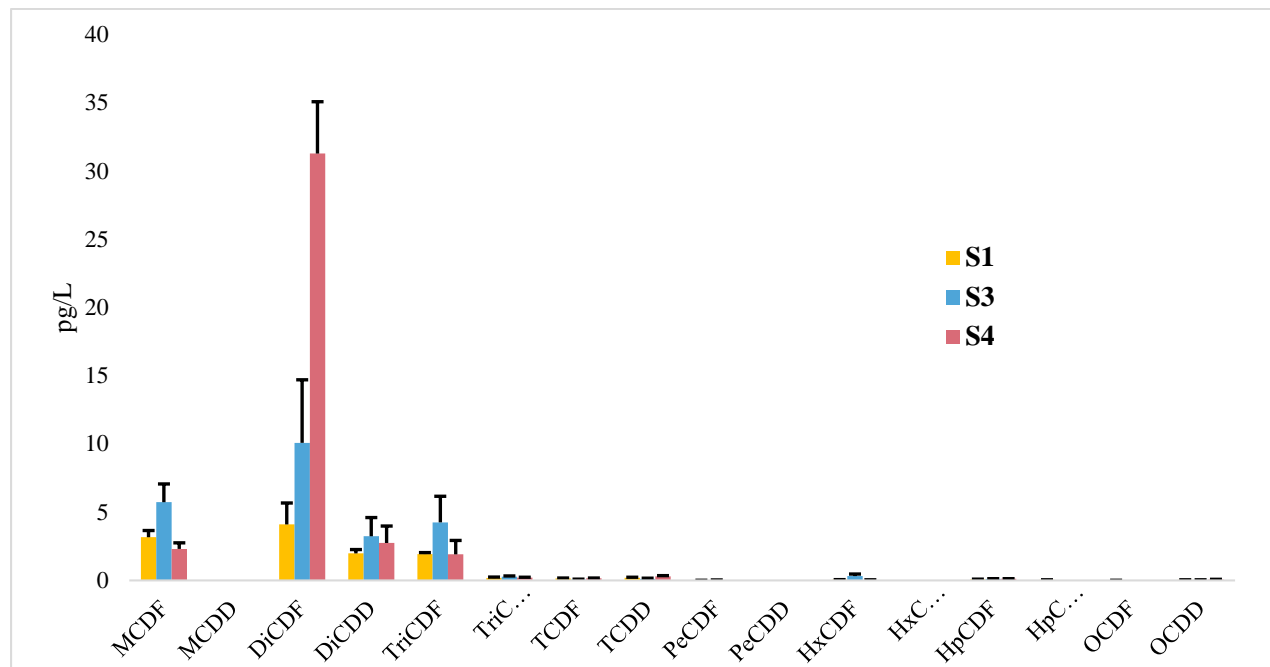

Figure 11: Average freely dissolved concentrations of PCDD/Fs (pg/L) of 3 deployments at each of the sampling sites. Error bars represent the standard deviation. S1: Riverbank Park; S3: Passaic Avenue; S4: Doremous Street.

In summary, for task 2, we successfully deployed a water column multi-sampler and derived dissolved concentrations for PCBs and PCDD/Fs along the Passaic River. The samplers developed in tasks 1 and 2 enable the investigation of pollutant dynamics between sediments/porewater and overlying water at contaminated sites. This shows that we achieved the SERDP objective by developing/using a water column multi sampler:

- (1) 'Develop passive sampling methodologies for one of the following groups of contaminants: dioxin/furans'; and
- (2) 'Develop a multi-purpose passive sampling device capable of collecting data on several contaminants of interest; A multi-purpose sampling device could include measurement of multiple hydrophobic organic compounds, metals, or munitions compounds in sediment and the immediate overlying surface water'.

Task (3): Collection of sediment and different benthic invertebrates from the sites where the sediment-borne passive multi-sampler is deployed, and measure tissue-concentrations of dioxins/furans and other HOCs. Compare porewater concentrations to geochemistry and the animals' lipid-normalized concentrations.

6. Concentrations of POPs in the sediment samples

6.1- PCBs

Fractions of black carbon (BC) and organic carbon (OC) measured in the sediment samples together with PCB concentrations are given in Table (S11). \sum_{89} PCBs ranged from 78 ng/g DW (Site 1) to 171 ng/g dw (Site 2) with an average concentration of 104 ng/g dw. Detected concentration at Site 2 was significantly higher than concentrations detected at the other three locations (ANOVA on Ranks, $p < 0.001$). All samples were dominated by tri- through hepta-chlorinated congeners comprising $> 80\%$ of the total detected concentrations of PCBs in the sediments (Figure 12). Except at Site 3, tetra- and penta-chlorinated biphenyls showed comparable contributions with respect to each other and higher contributions than all the other homologous groups. At Site 3, hexa-chlorinated biphenyls showed the highest contribution (34 %) followed by tetra- (21 %) and penta-chlorinated biphenyls (20 %) thus indicating different sources of PCBs at this location.

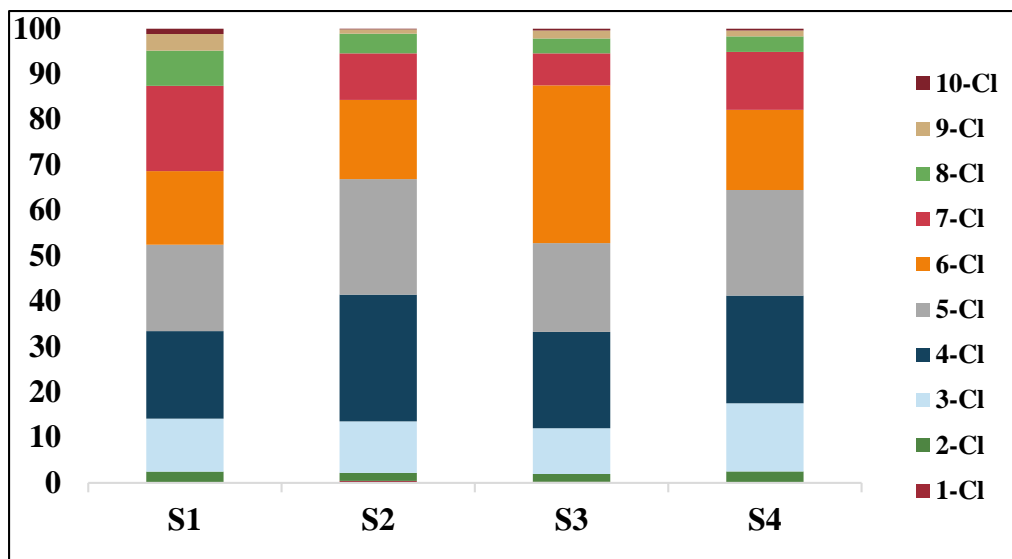

Figure 12: Contributions of the PCB homologous groups in Passaic River sediment. S1: Riverbank Park; S2: Bridge Street; S3: Passaic Avenue; S4: Doremous Street.

6.2- PCDD/Fs

Detected concentrations of PCDD/Fs in the sediment samples are given in Table (S12). \sum_{27} PCDD/Fs ranged from 1.7 ng/g dw (Site 4) to 4.6 ng/g dw (Site 2) with an average concentration of 3.0 ng/g dw. As for PCBs, detected concentrations of PCDD/Fs at Site 2 were higher than concentrations observed at the other locations but was not statistically significant. Detected concentrations were within the same range as previously observed in sediments of the lower

Passaic River in 2011.³¹ Sediments were dominated by OCDD comprising on average 53 % of the total detected concentrations followed by OCDF (11 %), HpCDF (7.0 %), HpCDD (5.0 %) and TCDD, DiCDD, DiCDF and TriCDF (4.0 % each) (Figure 13).

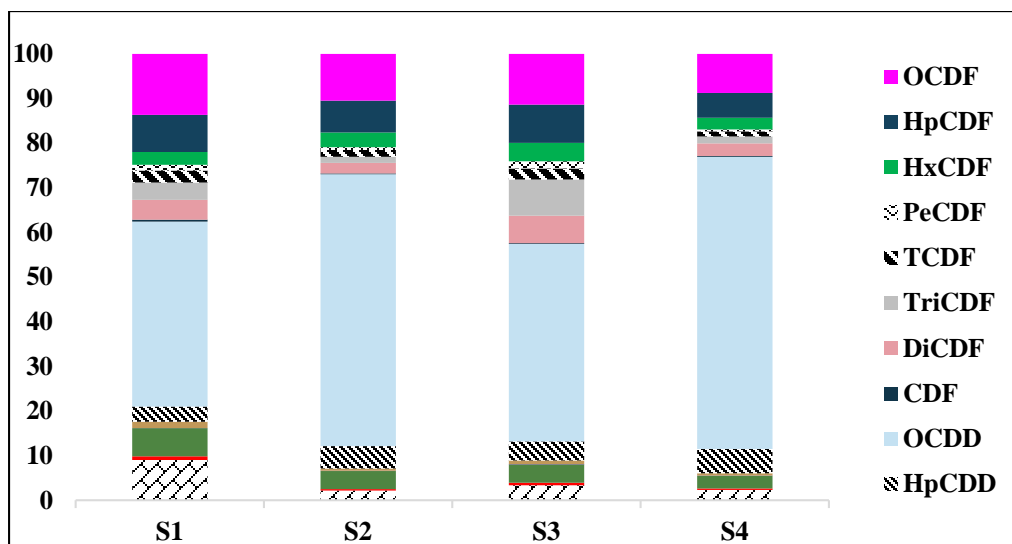

Figure 13: Contribution of the PCDD/F homologous groups in Passaic River sediment. S1: Riverbank Park; S2: Bridge Street; S3: Passaic Avenue; S4: Doremous Street.

In terms of the toxic equivalents of WHO, concentrations ranged from 56 pg TEQ/g dw to 211 pg TEQ/g dw with an average concentration of 147 pg TEQ/g dw. In all the samples 2,3,7,8-TCDD dominated the total WHO-TEQ with contributions ranging from 71 – 81 % followed by HxCDF (sum of both congeners; 5.0 – 9.0 %), PeCDF (sum of both congeners; 3.0 – 8.0 %) and 2,3,7,8-TCDF (3.0 – 5.0 %) (Figure 14).

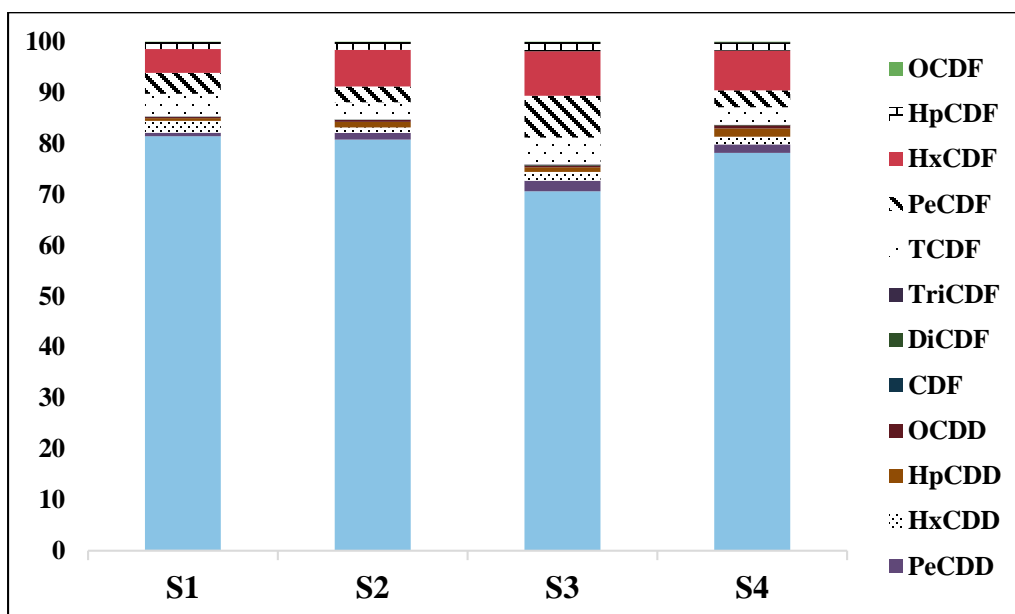

Figure 14: Contribution of the TEQ of PCDD/Fs in Passaic River sediment. S1: Riverbank Park; S2: Bridge Street; S3: Passaic Avenue; S4: Doremous Street.

7. Concentrations of POPs in the benthic species

7.1- PCBs

Detected concentrations (ng/g lipid) of PCBs in the benthic species are given in Table (S13). Σ_{89} PCB concentrations ranged from 2,700 ng/g lipid (shrimp) to 7,100 ng/g lipid (clams) with an average concentration of 5,500 ng/g lipid. Detected concentration of PCBs in the shrimp was significantly lower than concentrations reported for the other species (Friedman Repeated Measures Analysis of Variance on Ranks, $p < 0.001$). Additionally, concentration of PCBs in the tube worms sampled at Passaic Ave (S4) was significantly higher than detected concentrations in the mud crabs and the tube worms collected from River Bank Park (Site 1) (Friedman Repeated Measures Analysis of Variance on Ranks, $p < 0.001$). As for sediments, PCB in the biota samples were dominated by tri- through hepta-chlorinated homologous groups comprising 83 – 94 % of the total lipid normalized PCB concentrations (Figure 15). Very similar homologue patterns were observed in the investigated species (Figure 15). Lower contributions of the lower chlorinated (2-Cl) congeners were observed in the mud crabs and clams compared to the other species, which could possibly be related to the difference in the metabolic activities and/or food items. Additionally, in the mud crab samples, a lower contribution of the tetra-homologous group was observed in comparison with the other species, and a higher contribution of the hepta-group was also observed (Figure 15).

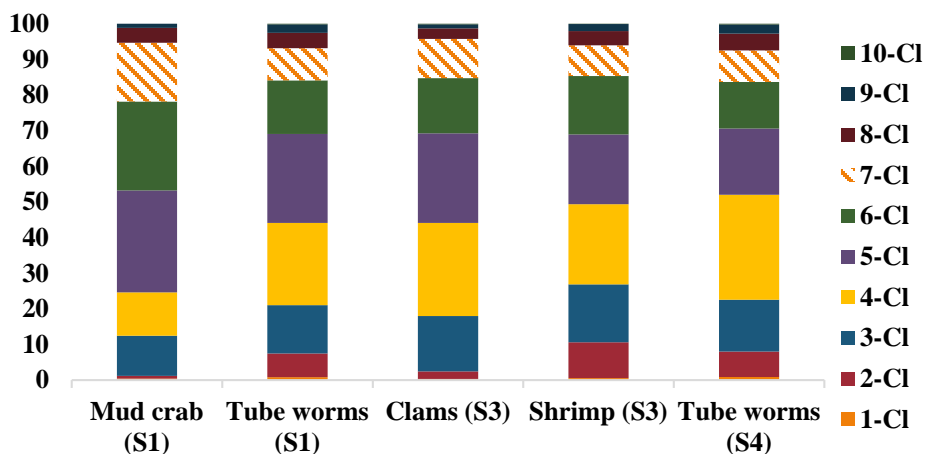

Figure 15: Contributions of the homologous groups of PCBs in the benthic species of the Passaic River.

7.2- PCDD/Fs

Concentrations of PCDD/Fs in the benthic species ranged from 12 ng/g lipids to 34 ng/g lipid with an average concentration of 23 ng/g lipid (Table S14). No statistical significant difference was observed for the detected PCDD/F concentrations in the different investigated benthic species. As shown in Figure (16), different patterns were observed in the benthic species unlike PCBs (Figure 15). OCDD was the dominant congener in mud crabs, tube worms (Site 1) and clams (Site 3) comprising 27 – 35 % of the total lipid normalized PCDD/F concentrations followed by 2,3,8-TriCDF (16 -21 %), 2,7/2,8-DiCDD (11 + 19 %), and OCDF (6.0 – 9.0 %). The shrimp showed a

different pattern, where the sample was dominated by 2,7/2,8-DiCDD and 2,3,8-TriCDF comprising 64 % of the PCDD/F concentrations.

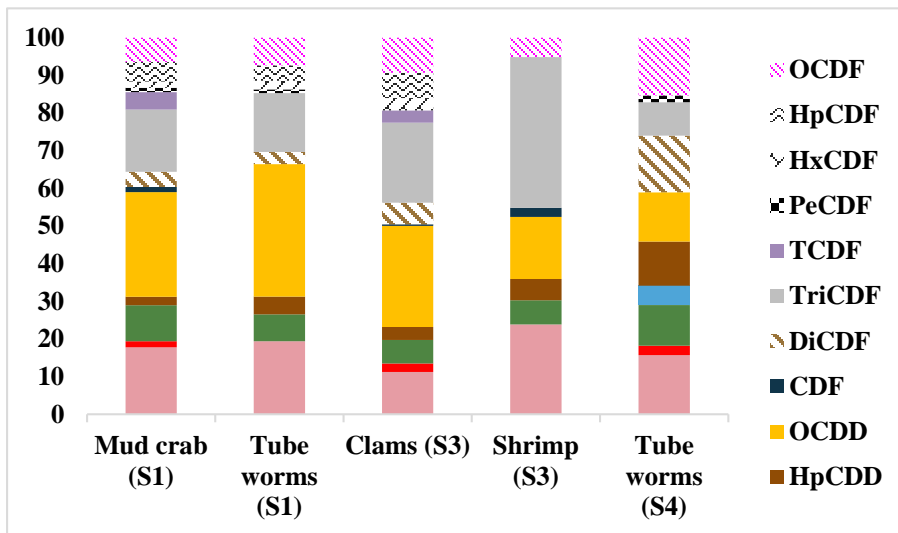

Figure 16: Contribution of the homologous groups of PCDD/Fs in benthic species of the Passaic River. S1: Riverbank Park; S3: Passaic Avenue; S4: Doremous Street.

Another different pattern was observed in the tube worms samples from Passaic Ave (S4), where comparable contributions of 2,7/2,8-DiCDD, TCDD, HpCDD, 2,8-DiCDF and OCDF was observed (11 – 16 %). Concentrations of the most toxic 2,3,7,8-TCDD congener ranged from 0.70 ng/g lipid (Tube worms at Site 1) to 2.0 ng/g lipid (mud crab at Site 1) comprising 2.0 – 9.0 % of the total lipid normalized PCDD/F concentrations.

In terms of TEQ, concentrations ranged from 0.80 ng TEQ/g lipid to 2.2 ng TEQ/g lipid). As expected, 2,3,7,8-TCDD dominated the TEQ concentrations contributing on average 87 % of the total WHO-TEQ concentrations followed by PeCDF (4.0 %) and HxCDF (3.0 %) (Figure 17).

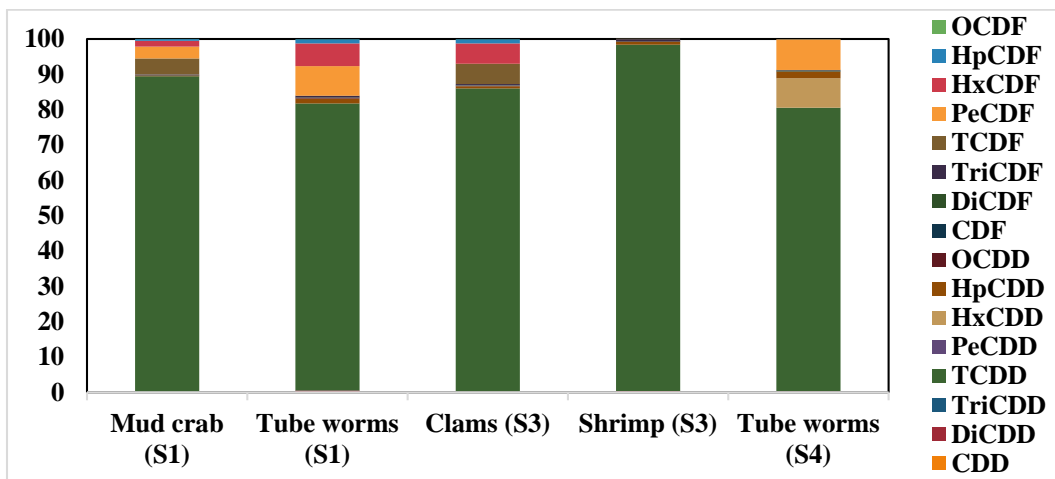

Figure 17: Contribution of the TEQ of PCDD/Fs in benthic species of the Passaic River. S1: Riverbank Park; S3: Passaic Avenue; S4: Doremous Street.

8. Estimation of the uptake of PCBs and PCDD/Fs by benthic species

Lipid normalized concentrations of PCBs and PCDD/Fs were estimated from sediments, porewater and river water using equations 3-5 and compared to measured lipid normalized concentrations in the benthic species. Porewater and sediments using BC + OC were generally better predictors of lipid concentrations of PCBs (Figures 18-20) and PCDD/Fs (Figures 21-23). Additionally, good prediction of the lower chlorinated PCBs (mono- through tetra-) were also obtained from the river water (PEs deployed in the water column above the bottom sediments). The only exception was PCBs in the shrimp (Figure 19), which were better predicted from river water for the majority of the investigated PCB congeners. In the mud crab samples, sediments (OC) overestimated the lipid normalized concentrations of PCBs for the majority of the lower chlorinated congeners (Di- through tri-) and the higher chlorinated ones (hepta- through deca-). In contrast, sediments (using OC) were the best predictors of lipid concentrations for the mono-chlorinated congeners and most of the penta- and hexa- congeners (Figure 18). Lower chlorinated congeners (di- through tetra-) were best predicted from the river water. Higher chlorinated congeners (hexa- through deca-) were better predicted in the mud crab sample either from the sediments (using BC + OC) and/or the porewater. Accordingly, we conclude that the uptake of PCBs in the mud crabs occur from the exposure to the porewater, river water (for the lower chlorinated ones) and probably from the digestion of sediments.

In the tube worm sample collected from Site 1, mono- and most of the di-chlorinated congeners were underestimated by all the abiotic compartment used in the current study (Figure 19). Other than that, the majority of the remaining congeners were better estimated from sediments (especially using BC + OC) and porewater indicating a similar exposure route as the mud crabs.

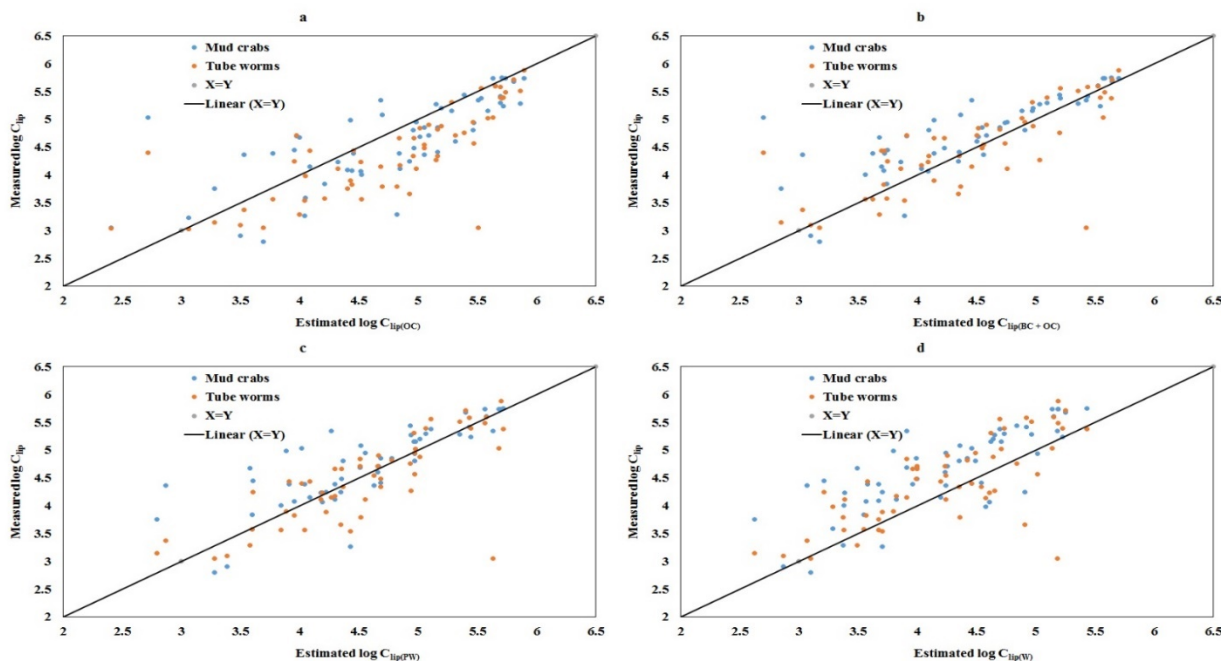

Figure 18: Ratios of estimated versus measured lipid normalized concentrations of PCBs in the mud crabs and tube worms samples from Riverbank Park sampling site. Predictions based on (a) overlying water concentrations from passive samplers; (b) porewater concentrations from in situ passive samplers; (c) sediment concentrations accounting for both OC+BC; (d) sediment concentrations accounting for OC.

In clams (Figure 19), a similar pattern to tube worms and mud crabs were observed. The lower chlorinated congeners (mono- through penta-) were better predicted using sediments (BC + OC), whereas the higher chlorinated congeners were better predicted using porewater. In the shrimp collected from the same site, mono- through di-chlorinated congeners were better predicted from sediments (BC + OC), whereas the rest is better predicted using the river water (Figure 19).

A close pattern was observed for the tube worms sampled from both locations (Figures 18 and 20). However, in the sample collected from Passaic Ave (Site 4), sediments (using OC) were good predictors of PCBs and did not greatly overestimated the lipid normalized concentrations as shown in S1 (Figure 18).

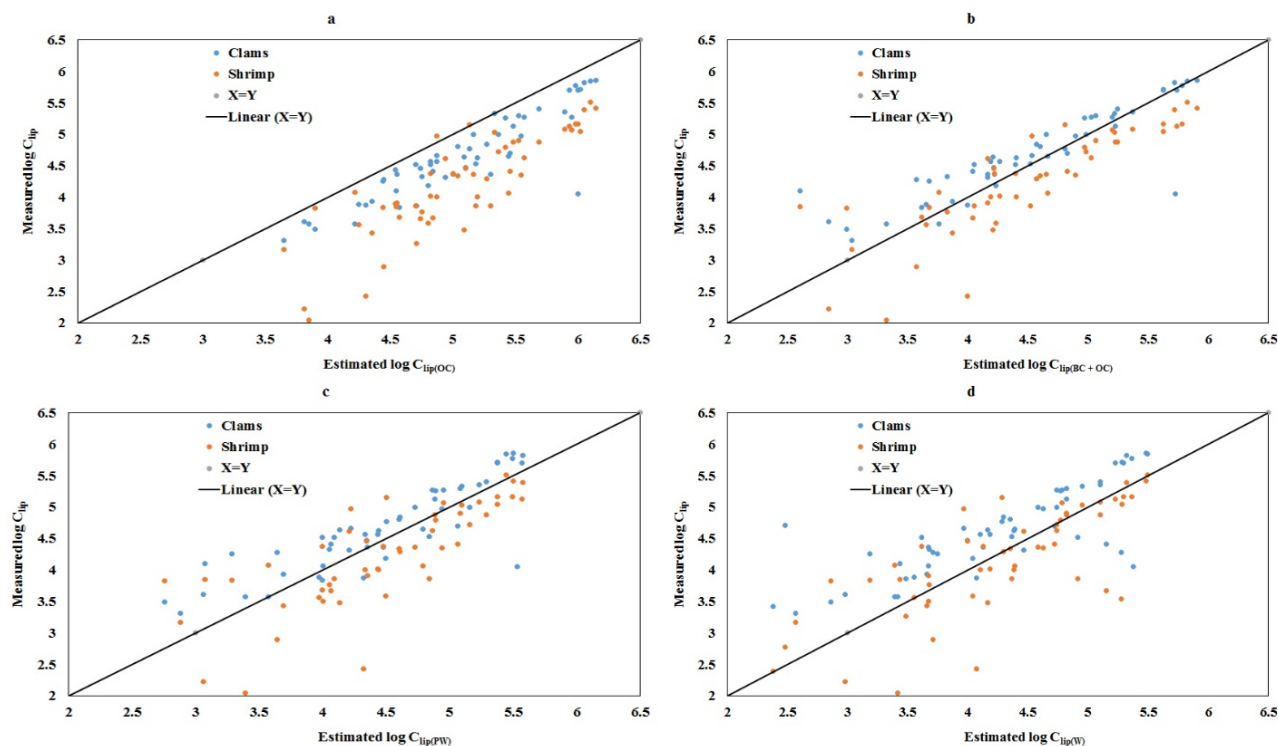

Figure 19: Ratios of estimated versus measured lipid normalized concentrations of PCBs in the clams and shrimp samples from Passaic Avenue sampling site. Predictions based on (a) overlying water concentrations from passive samplers; (b) porewater concentrations from in situ passive samplers; (c) sediment concentrations accounting for both OC+BC; (d) sediment concentrations accounting for OC.

Ratios of estimated versus measured lipid normalized concentrations of PCDD/Fs in the benthic species are shown in Figures (21 – 23). Except for the tube worms samples from Passaic Ave (site 4, see Figure 23), predictions based on OC partitioning overestimated PCDD/Fs concentrations in all the benthic species. Predicted lipid normalized PCDD/F concentrations from sediments in the benthic species were greatly improved when the BC + OC scenario was used indicating the probable role played by BC in the sorption of PCDD/Fs in sediments of the lower Passaic River. Lipid normalized PCDD/Fs were better estimated in the current study from porewater and river water for the majority of the congeners. However, for 2,3,7,8-TCDD in all the samples and most

of the congeners in the tube worms from the last samples (Figure 22), lipid normalized concentrations were better predicted from sediments using the BC + OC scenario.

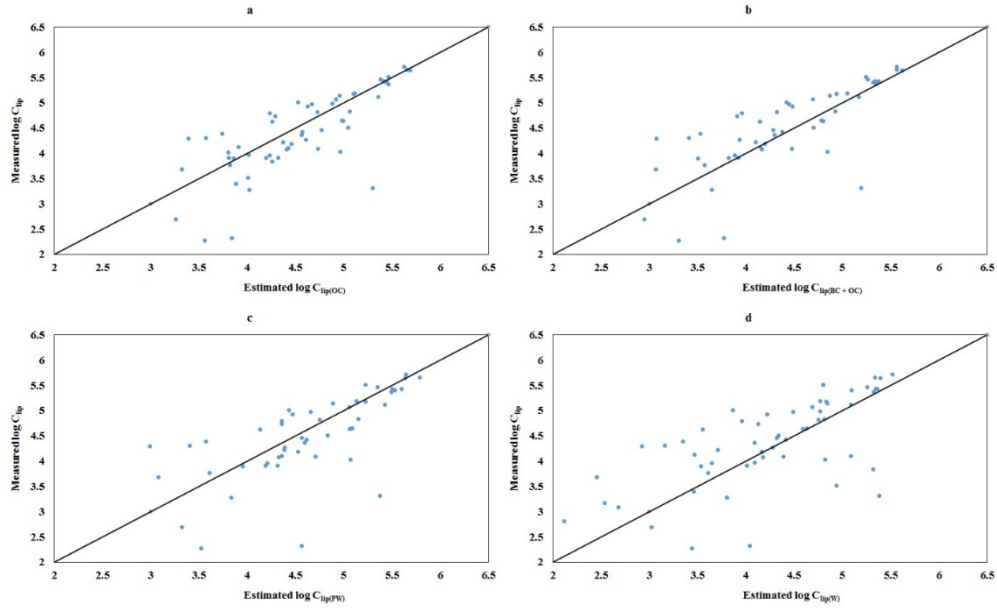

Figure 20: Ratios of estimated versus measured lipid normalized concentrations of PCBs in the tube worm sample from Doremous Street sampling site. Predictions based on (a) overlying water concentrations from passive samplers; (b) porewater concentrations from in situ passive samplers; (c) sediment concentrations accounting for both OC+BC; (d) sediment concentrations accounting for OC.

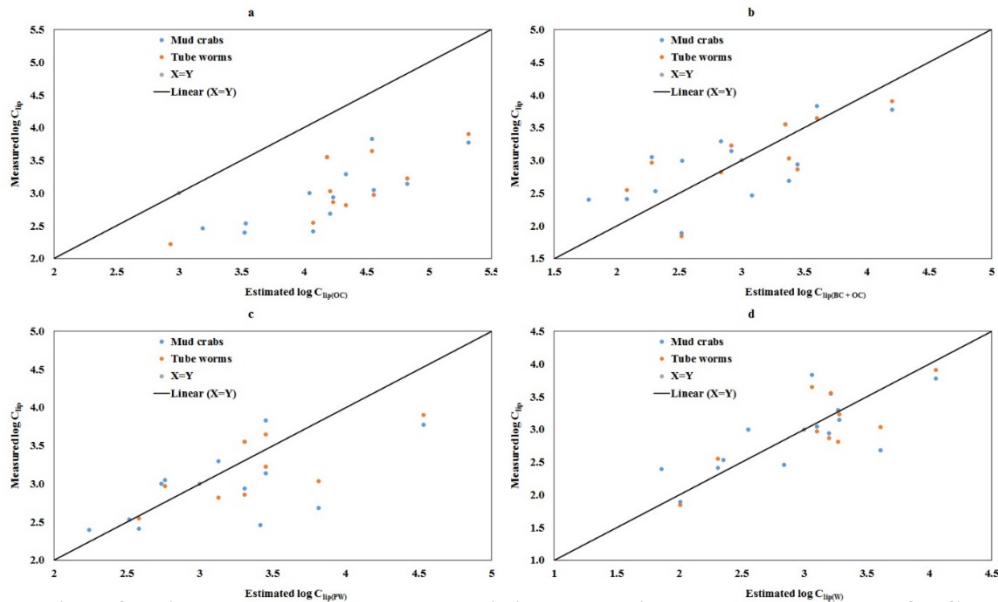

Figure 21: Ratios of estimated versus measured lipid normalized concentrations of PCDD/Fs in the mud crabs and tube worm samples from Riverbank Park sampling site. Predictions based on (a) overlying water concentrations from passive samplers; (b) porewater concentrations from in situ passive samplers; (c) sediment concentrations accounting for both OC+BC; (d) sediment concentrations accounting for OC.

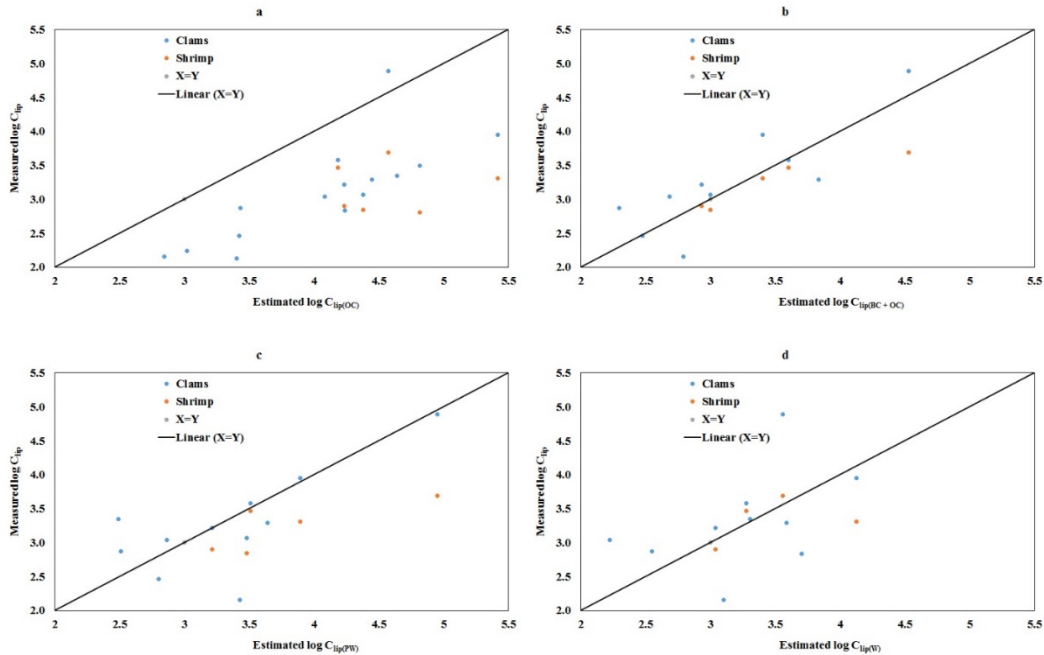

Figure 22: Ratios of estimated versus measured lipid normalized concentrations of PCDD/Fs in the clams and shrimp samples from Passaic Avenue sampling site. Predictions based on (a) overlying water concentrations from passive samplers; (b) porewater concentrations from in situ passive samplers; (c) sediment concentrations accounting for both OC+BC; (d) sediment concentrations accounting for OC.

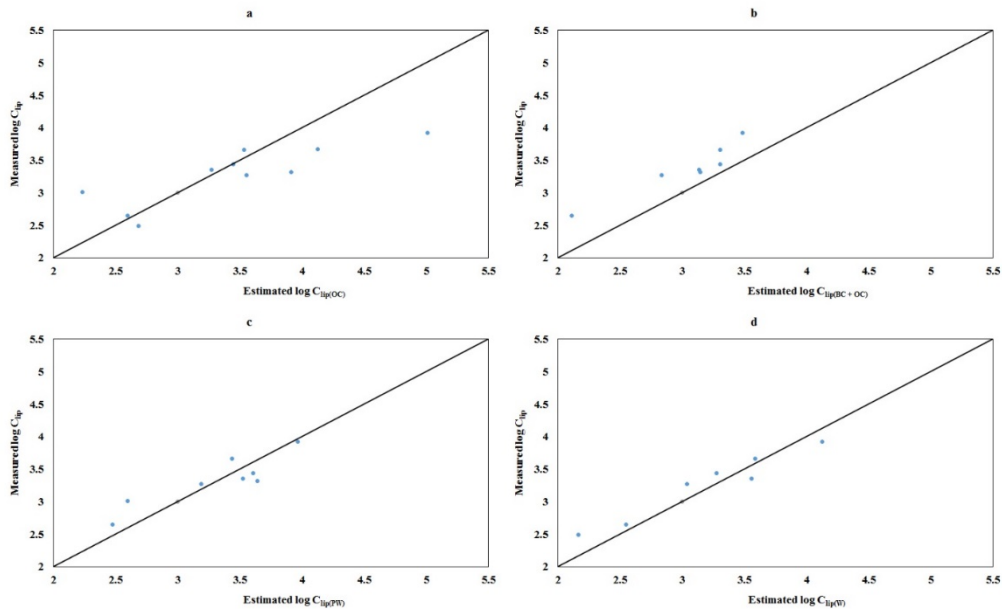

Figure 23: Ratios of estimated versus measured lipid normalized concentrations of PCDD/Fs in the tube worms from Doremous Street sampling site. Predictions based on (a) overlying water concentrations from passive samplers; (b) porewater concentrations from in situ passive samplers; (c) sediment concentrations accounting for both OC+BC; (d) sediment concentrations accounting for OC.

In summary for task 3, results from the in situ porewater sampler, sediment geochemistry and the water column sampler were used to predict the bioaccumulation of PCBs and PCDD/Fs in benthic invertebrates. Porewater concentrations and sediments (OC+BC) were the best predictors of lipid-normalized contaminant concentrations in benthic biota, confirming the benefits of passive sampling in general and the appropriateness of the multi samplers developed, deployed and field-tested here. This confirms that we achieved the SERDP objectives by demonstrating that our

(3) *Passive sampler measurements [...] can be used as surrogates for tissue contaminant measures in benthic and pelagic organisms.*

Task (4): Assessment of porewater and truly dissolved concentrations of dioxins/furans at several sites along the Passaic River, and comparison to sediment and water concentrations at the same sites. Demonstrate that the passive multi-samplers yield representative spatial and temporal interrogation of site contaminants when deployed.

In the previous parts of this report, estimated freely dissolved concentrations of PCBs and PCDD/Fs in the river water and the porewater were presented at each of the sampling sites. In this section, we present an overall summary of our findings. Although temporal variabilities were not observed for the total concentrations of PCBs (Figure 24) and PCDD/Fs (Figure 25) in the porewater and river water, some spatial variability was observed. \sum_{89} PCB porewater concentrations at Site 2 (4.86 – 5.84 ng/L) were significantly higher (Figure 24a) than detected concentrations at the other three sites (2.10 – 2.76 ng/L) which showed comparable porewater concentrations (Mann Whitney U-test, $p < 0.05$). For the river water (Figure 24b), derived PCB concentrations at Site 1 and Site 4 were higher than PCB concentrations at Site 3. However, this difference was statistically insignificant.

Based on the estimated \sum_{27} PCDD/F porewater concentrations, samples can be arranged in the following descending order (Figure 25a): Site 3 (40.65 – 42.15 pg/L) > Site 4 (29.3 – 35.2 pg/L) > Site 2 (27.2 – 30.4 pg/L) > Site 1 (23.2 – 27.5 pg/L) with no statistical significant difference between sites. For river water (Figure 25b), derived PCDD/F concentrations at Site 3 (18.3 – 33.9 pg/L) and Site 4 (34.4 – 41.5 pg/L) were significantly higher (Mann Whitney U-test, $p < 0.05$) than concentrations at Site 1 (10.4 – 14.1 pg/L).

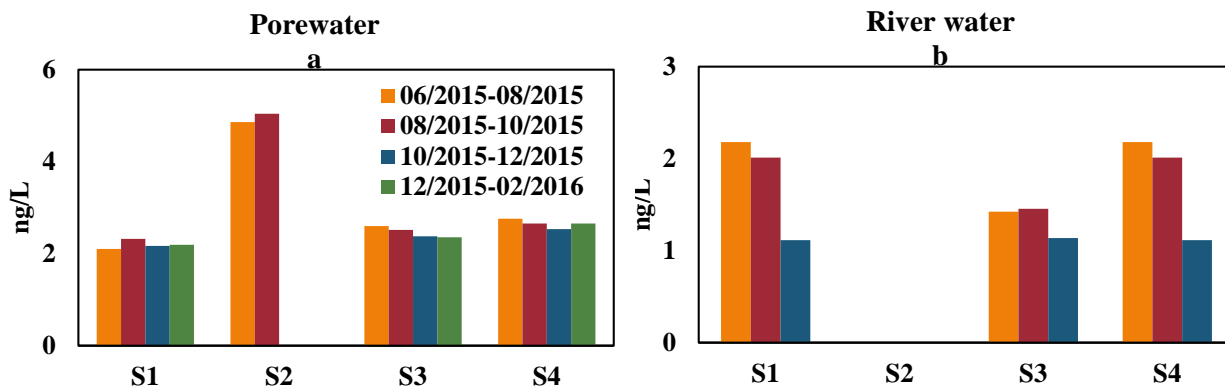

Figure 24: Estimated \sum_{89} PCB concentrations in the porewater (a) and river water (b) using LDPE passive samplers. S1: Riverbank Park; S2: Bridge Street; S3: Passaic Avenue; S4: Doremous Street.

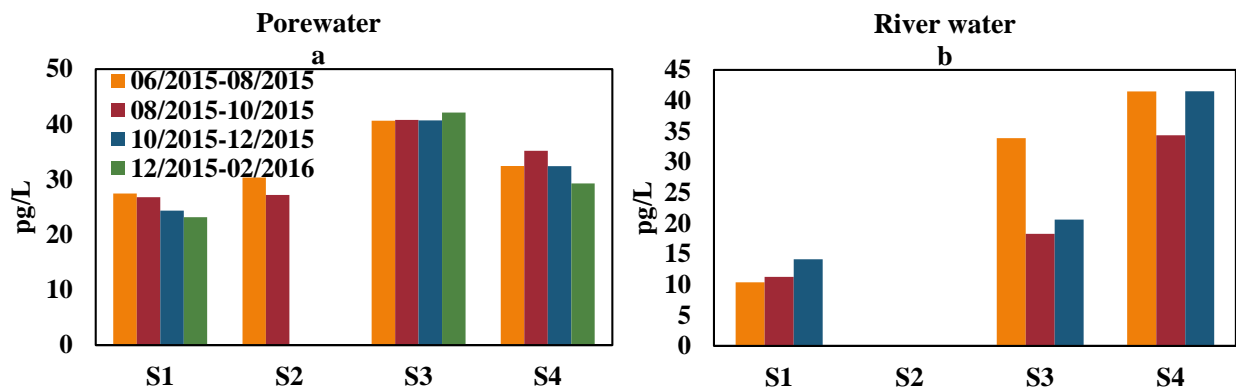

Figure 25: Estimated Σ_{27} PCDD/F concentrations in the porewater (a) and river water (b) using LDPE passive samplers. S1: Riverbank Park; S2: Bridge Street; S3: Passaic Avenue; S4: Doremous Street.

To study the gradients of PCBs and PCDD/Fs between the river water and porewater, activities of PCBs and PCDD/Fs were calculated by normalizing the estimated concentration of each congener (for each of the river water and porewater) to its corresponding water solubility and plotting their log transformed values (Figure 26a and b). As shown in Figure 26, log transformed activities of the majority of the PCB and PCDD/F congeners in the porewater at all the sampling sites were higher than their corresponding river water. This implies that sediments (porewater) were acting as a probable source for PCBs and PCDD/Fs to the overlying water column.

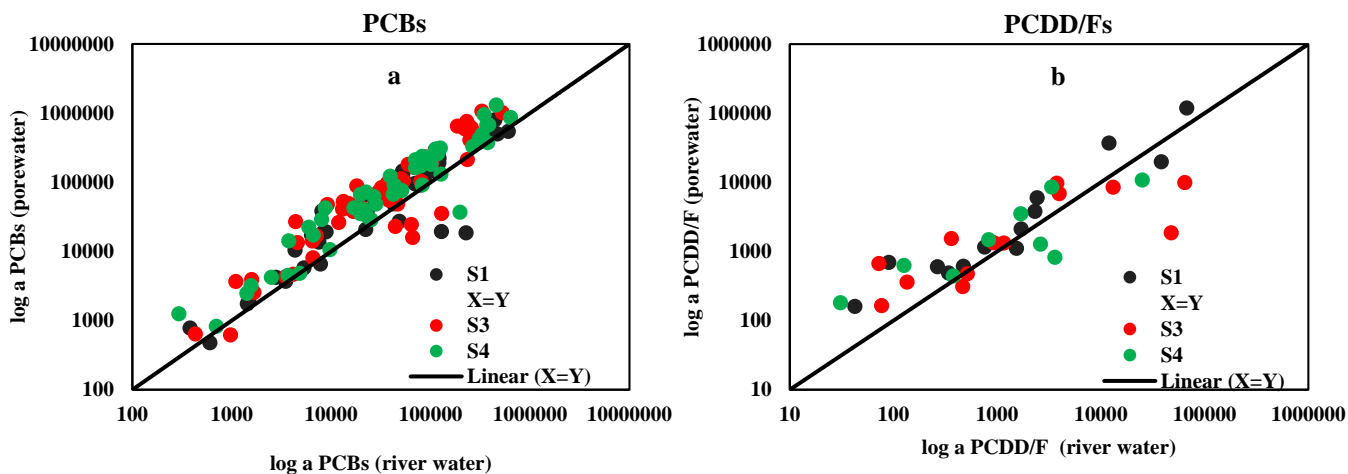

Figure 26: Log transformed chemical activities of PCBs (a) and PCDD/Fs in the porewater and river water estimated from LDPE passive samplers at the lower Passaic River. S1: Riverbank Park; S3: Passaic Avenue; S4: Doremous Street.

Part of the validation of the water sampler was to demonstrate representative spatial and temporal patterns of contaminants. As there is no obvious benchmark to compare our results to, we opted to measure spatial and temporal trends for PCBs and PBDEs along the Passaic River during deployments covering one year, from November 2011-November 2012. Spatial trends for sum PCBs display strong gradients along the Passaic River (Figure 27). Greatest concentrations are observed around the Diamond Alkali Superfund site, which reflects sites with elevated sediment concentrations. This implies that the water column passive sampler indeed yields representative spatial trends.

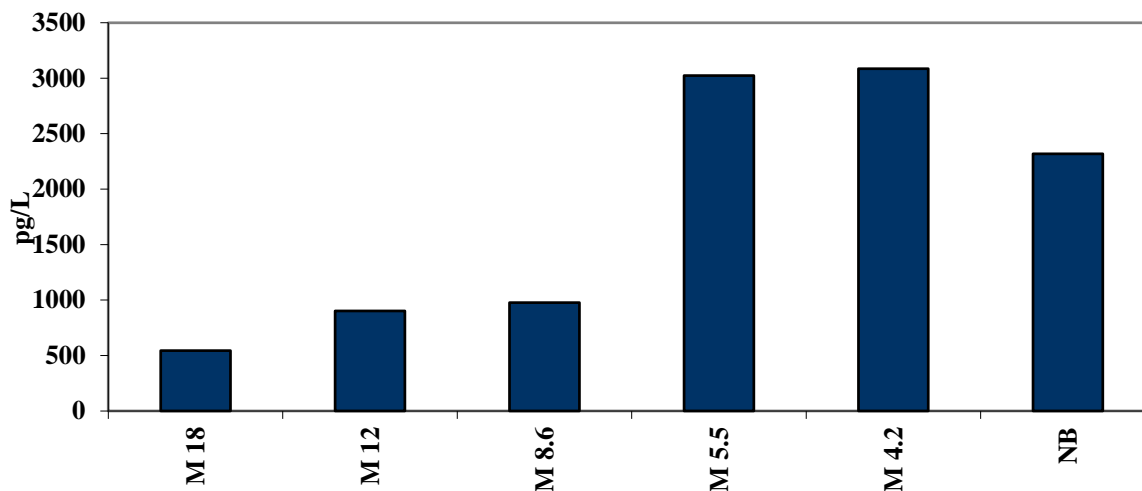

Figure 27: Average sum PCBs (pg/L) along the Passaic River (2011-2012) as a function of river mile.

During the deployment period, samplers were able to cover temporal trends by six consecutive 2-month long deployments (Figure 28) along 6 sites along the Passaic River. Clear temporal trends can be seen, with concentrations increasing towards warmer temperatures, probably linked to enhanced bioturbation during warmer months. These results suggest that the samplers are capable to properly delineating temporal trends.

During the same deployments, samplers were also analyzed for PBDEs (Figure 29), but spatial trends are not as obvious as for PCBs. This can be explained by sediments not being an important source for PDBEs combined with the importance of on-going releases of PBDEs, leading to rather homogenous concentrations along river. Temporal trends of PDBEs (Figure 30) are not as pronounced as for PCBs, but still underscore the importance of warmer temperatures leading to increasing dissolved concentrations of PBDEs.

In summary for task 4, samplers yielded spatial trends for PCBs in the water column of the Passaic River that matched expectations. No major trends were detected for PBDEs. Temporal trends for both compound groups imply that the water column sampler is capable of interrogating both spatial and temporal trends of contaminants. This means that we achieved the SERDP objectives by demonstrating that our

(4) Passive samplers [...] yield representative spatial and temporal interrogation of site contaminants when deployed.

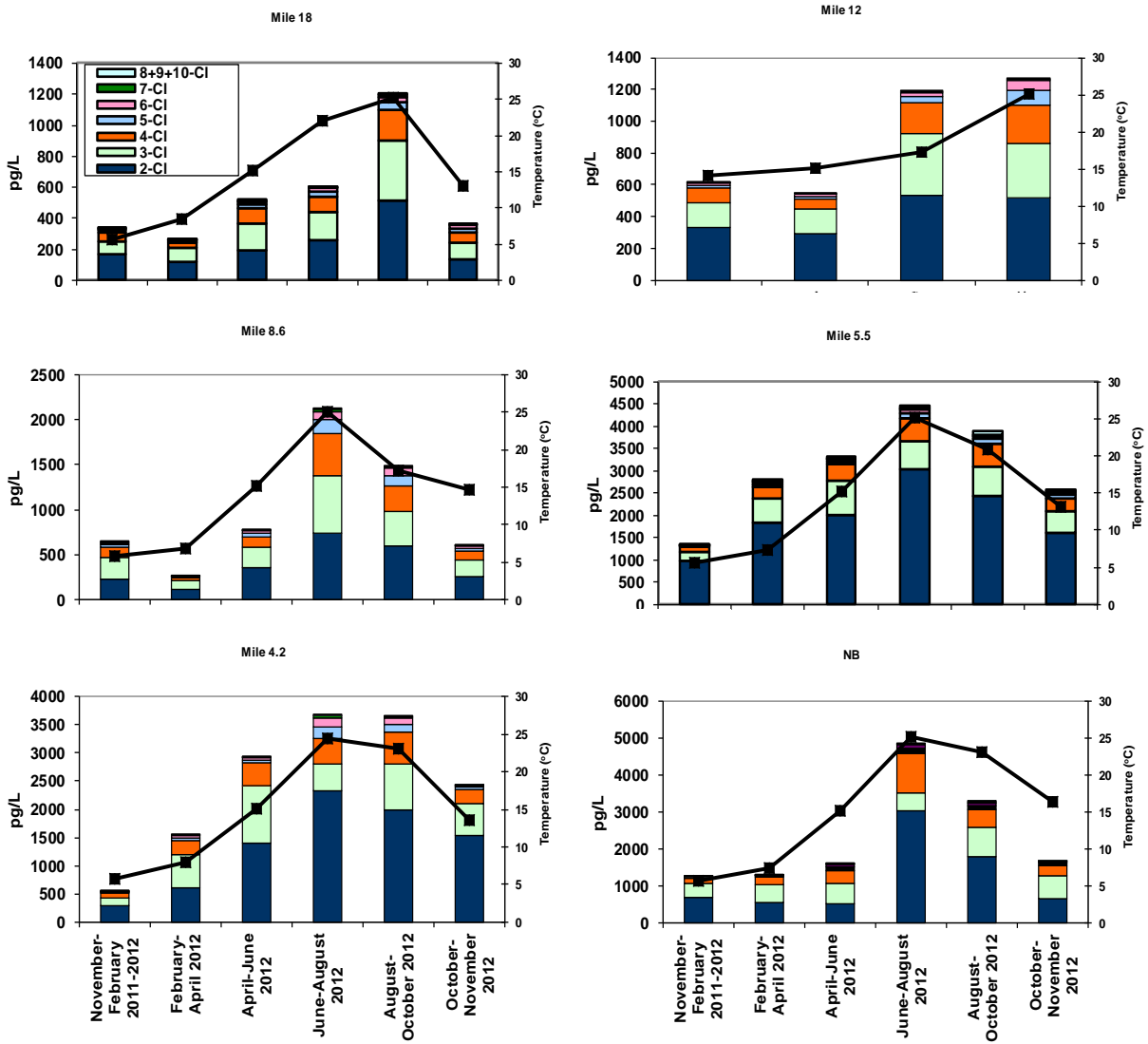

Figure 28: Sum PCBs (pg/L) and water temperature along the Passaic River (2011-2012) over a 1-year period, listed by river mile, where each deployment lasted approximately 2 months each.

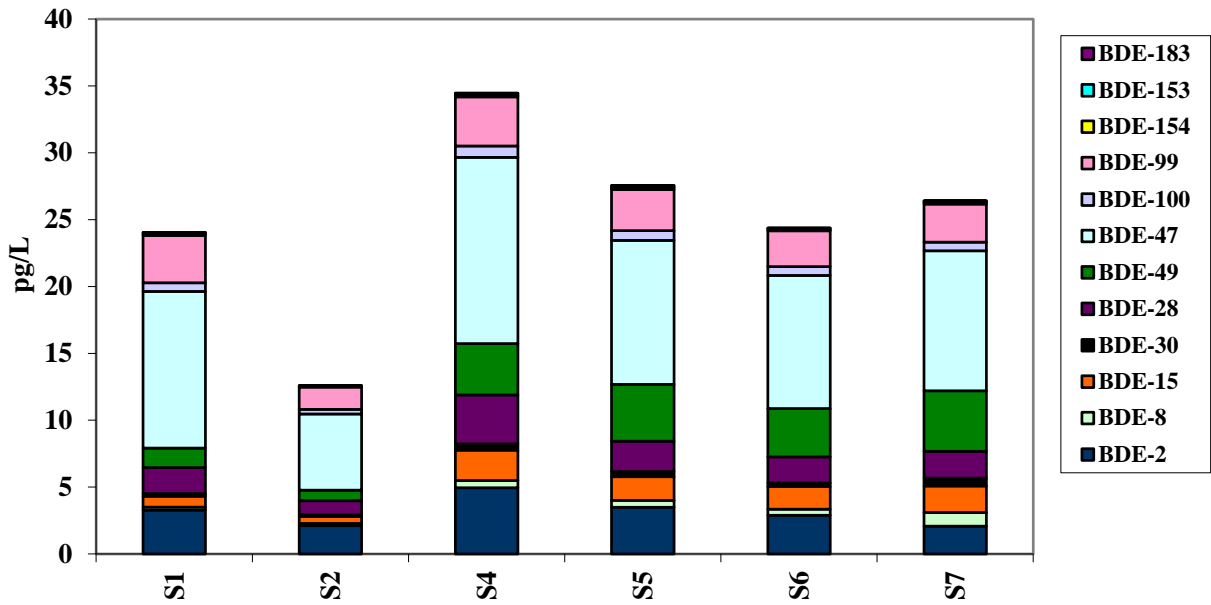

Figure 29: Sum PBDEs (pg/L) along the Passaic River (2011-2012)

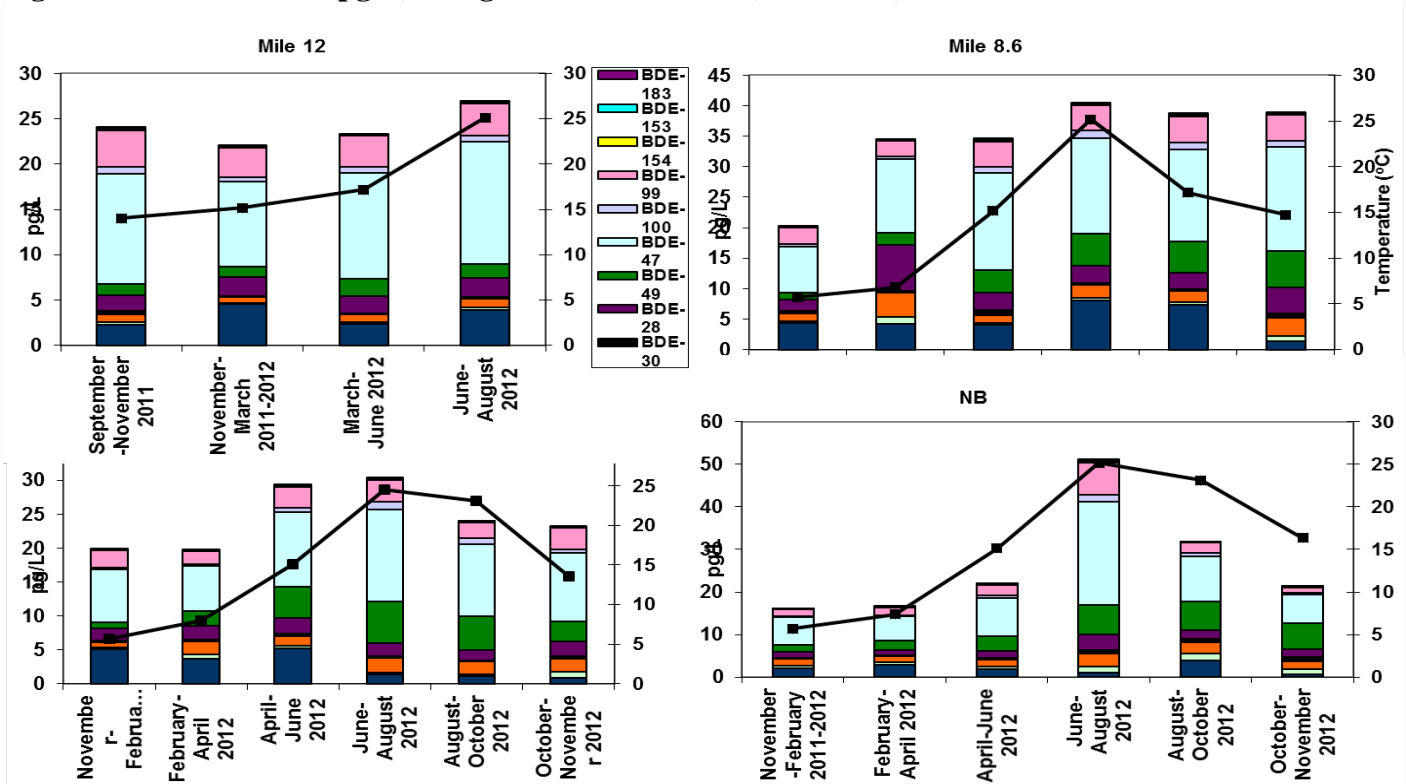

Figure 30: Sum PBDEs (pg/L) and water temperature along the Passaic River, listed by river mile (2011-2012).

Conclusions and implications for future research

In this study, an *in situ* porewater sampler was successfully deployed at four locations along the lower Passaic River and acquired data about the freely dissolved concentrations of PCDD/Fs and PCBs in the porewater. The method was shown to be valid when compared to the well-established laboratory tumbling experiment. When compared to the preparations needed to perform the tumbling experiment, the *in situ* multi-sampler is a good tool that can be successfully and efficiently deployed at shallow sites. The comparison between the tumbling experiment and our proposed *in situ* sampler indicated the importance of spiking PEs with labelled dioxin PRCs together with d-PAHs before deployment. A comparison of passive samplers results with biota also confirmed that the passive multi-sampler was good at predicting lipid-normalized contaminant concentrations in benthic invertebrates. Both the passive multi-sampler and the overlying water column sampler were able to depict spatial and temporal gradients and trends, thereby yield representative spatial and temporal interrogation of site contaminants when deployed.

We thus achieved our goals in support of SERDP's stated needs, namely to

(1) '*Develop passive sampling methodologies for one of the following groups of contaminants: dioxin/furans*':

We developed and field tested both a porewater and water column multisampler.

(2) '*Develop a multi-purpose passive sampling device capable of collecting data on several contaminants of interest; A multi-purpose sampling device could include measurement of multiple hydrophobic organic compounds, metals, or munitions compounds in sediment and the immediate overlying surface water*'.

We could demonstrate mutlisamplers for dioxins/furans, and other organic contaminants, including PCBs and PBDEs; it can also be used for PAHs, etc.

(3) '*Passive sampler measurements that can be used as surrogates for tissue contaminant measures in benthic and pelagic organisms* **Our results show that *in situ* porewater results are best predictors of tissue contaminant measured in benthic invertebrates.**

(4) '*Passive samplers that yield representative spatial and temporal interrogation of site contaminants when deployed. **The water column sampler clearly delineated temporal and spatial trends of PCBs, highlighting its applicability to contaminated sites to interrogate spatial and temporal pollutant dynamics.***

The specific research objective supported the main interest by SERDP and SEED to simplify and speed up acquisition of relevant exposure to contaminants of interest *in situ*. Following this research, it will then be possible to design and implement projects at current DoD sites to aid in remediation decision making. Benefits of the sampler deployments include optimization of both pre-cleanup design and post-cleanup monitoring of contaminated sites.

Potential next steps include deployments include contaminated sites such as the Lower Willamette River (WA) and Newark Bay (NY/NJ), where PCDD/Fs and other organic contaminants, including PCBs, are of concern. The field-tested sampler developed and validated as part of this project can be used to determine temporal and spatial contaminants concentrations in porewater and water column, and be used to predict the bioaccumulation of these contaminants in benthic invertebrates at these sites. There is interest from the RPMs at both sites for field trials. Part of these field trials will also involve testing how the samplers can be effectively delivered in deeper waters,

presumably requiring divers for their placement. At the same time, we'd like to have divers observe whether simple ship-based deployments yield acceptable sediment deployments.

In the Lower Willamette River the objectives involve assessing spatial gradients in dioxins/furans versus those of PCBs ahead of remediative action, and differentiating between porewater and overlying water column concentrations of target contaminants. In Newark Bay, the passive sampler deployments in water column and porewater would be used to verify and validate previous measurements. Porewater concentrations were measured ex situ, which would be ground-truthed with the passive multi-sampler. Similarly, water column measurements were measured previously using active samplers, but could now be investigated with passive samplers. The overarching objective is to better assess the role of sediment contamination affecting water and biota at both sites. Simultaneous passive sampler deployments in sediment and water column can achieve that goal.

References

- (1) Mayer, P.; Tolls, J.; Hermens, J.; Mackay, D. Peer reviewed: Equilibrium sampling devices. *Environ. Sci. Technol.* **2003**, *37* (9), 184A–191A.
- (2) Reichenberg, F.; Mayer, P. Two complementary sides of bioavailability: Accessibility and chemical activity of organic contaminants in sediments and soil. *Environ. Toxicol. Chem.* **2006**, *25* (5), 1239–1245.
- (3) Mayer, P.; Parkerton, T. F.; Adams, R. G.; Cargill, J. G.; Gan, J.; Gouin, T.; Gschwend, P. M.; Hawthorne, S. B.; Helm, P.; Witt, G.; et al. Passive sampling methods for contaminated sediments: scientific rationale supporting use of freely dissolved concentrations. *Integr. Environ. Assess. Manag.* **2014**, *10* (2), 197–209.
- (4) Jonker, M. T. O.; Koelmans, A. A. Polyoxymethylene Solid Phase Extraction as a Partitioning Method for Hydrophobic Organic Chemicals in Sediment and Soot. *Environ. Sci. Technol.* **2001**, *35* (18), 3742–3748.
- (5) Müller, J. F.; Hawker, D. W.; McLachlan, M. S.; Connell, D. W. PAHs, PCDD/Fs, PCBs and HCB in leaves from Brisbane, Australia. *Chemosphere* **2001**.
- (6) Adams, R. G.; Lohmann, R.; Fernandez, L. A.; MacFarlane, J. K.; Gschwend, P. M. Polyethylene devices: Passive samplers for measuring dissolved hydrophobic organic compounds in aquatic environments. *Environ. Sci. Technol.* **2007**.
- (7) Lohmann, R.; Dapsis, M.; Morgan, E. J.; Dekany, V.; Luey, P. J. Determining air-water exchange, spatial and temporal trends of freely dissolved PAHs in an urban estuary using passive polyethylene samplers. *Environ. Sci. Technol.* **2011**, *45*, 2655–2662.
- (8) Reitsma, P. J.; Adelman, D.; Lohmann, R. Challenges of using polyethylene passive samplers to determine dissolved concentrations of parent and alkylated PAHs under cold and saline conditions. *Environ. Sci. Technol.* **2013**, *47*, 10429–10437.
- (9) Morgan, E. J.; Lohmann, R. Detecting Air–Water and Surface–Deep Water Gradients of PCBs Using Polyethylene Passive Samplers. *Environ. Sci. Technol.* **2008**, *42* (19), 7248–7253.
- (10) Sacks, V. P.; Lohmann, R. Freely dissolved PBDEs in water and porewater of an urban estuary. *Environ. Pollut.* **2012**, *162*, 287–293.
- (11) Sacks, V. P.; Lohmann, R. Development and use of polyethylene passive samplers to detect triclosans and alkylphenols in an Urban estuary. *Environ. Sci. Technol.* **2011**, *45*, 2270–2277.
- (12) Lohmann, R.; Muir, D. Global Aquatic Passive Sampling (AQUA-GAPS): using passive samplers to monitor POPs in the waters of the world. *Environ. Sci. Technol.* **2010**, *44* (3), 860–864.
- (13) Lohmann, R. Critical review of low-density polyethylene's partitioning and diffusion coefficients for trace organic contaminants and implications for its use as a passive

- sampler. *Environ. Sci. Technol.* **2012**, *46* (2), 606–618.
- (14) Shiu, W.-Y. Temperature Dependence of Physical–Chemical Properties of Selected Chemicals of Environmental Interest. II. Chlorobenzenes, Polychlorinated Biphenyls, Polychlorinated Dibenzo-p-dioxins, and Dibenzofurans. *J. Phys. Chem. Ref. Data* **2000**, *29* (3), 387.
- (15) Schenker, U.; MacLeod, M.; Scheringer, M.; Hungerbühler, K. Improving Data Quality for Environmental Fate Models: A Least-Squares Adjustment Procedure for Harmonizing Physicochemical Properties of Organic Compounds. *Environ. Sci. Technol.* **2005**, *39* (21), 8434–8441.
- (16) Booij, K.; Smedes, F.; van Weerlee, E. M. Spiking of performance reference compounds in low density polyethylene and silicone passive water samplers. *Chemosphere* **2002**, *46* (8), 1157–1161.
- (17) Huckins, J. N.; Petty, J. D.; Lebo, J. A.; Almeida, F. V.; Booij, K.; Alvarez, D. A.; Cranor, W. L.; Clark, R. C.; Mogensen, B. B. Development of the Permeability/Performance Reference Compound Approach for In Situ Calibration of Semipermeable Membrane Devices. *Environ. Sci. Technol.* **2002**, *36* (1), 85–91.
- (18) Accardi-Dey, A.; Gschwend, P. M. Assessing the Combined Roles of Natural Organic Matter and Black Carbon as Sorbents in Sediments. *Environ. Sci. Technol.* **2001**, *36* (1), 21–29.
- (19) Khairy, M.; Muir, D.; Teixeira, C.; Lohmann, R. Spatial Trends, Sources, and Air – Water Exchange of Organochlorine Pesticides in the Great Lakes Basin Using Low Density Polyethylene Passive Samplers. *Environ. Sci. Technol.* **2014**, *48*, 9315–9324, doi.org/10.1021/es501686a.
- (20) Liu, Y.; Wang, S.; McDonough, C. A.; Khairy, M. A.; Muir, D. C. G.; Helm, P. A.; Lohmann, R. Gaseous and Freely-Dissolved PCBs in the Lower Great Lakes based on Passive Sampling: Spatial Trends and Air-water Exchange. *Environ. Sci. Technol.* **2015**, in press.
- (21) McDonough, C. A.; Khairy, M. A.; Muir, D. C. G.; Lohmann, R. Significance of population centers as sources of gaseous and dissolved PAHs in the lower Great Lakes. *Environ. Sci. Technol.* **2014**, *48*, 7789–7797.
- (22) McDonough, C. A.; Puggioni, G.; Helm, P. A.; Muir, D.; Lohmann, R. Spatial Distribution and Air – Water Exchange of Organic Flame Retardants in the Lower Great Lakes. *Environ. Sci. Technol.* **2016**, *50*, 9133–9141.
- (23) Lambert, M.; Friedman, C.; Luey, P.; Lohmann, R. Role of Black Carbon in the Sorption of Polychlorinated Dibenzo-p-dioxins and Dibenzofurans at the Diamond Alkali Superfund Site, Newark Bay, New Jersey. *Environ. Sci. Technol.* **2011**, *45* (10), 4331–4338.
- (24) Khairy, M. A.; Weinstein, M. P.; Lohmann, R. Trophodynamic behavior of hydrophobic organic contaminants in the aquatic food web of a tidal river. *Environ. Sci. Technol.* **2014**, *48*, 12533–12542.

- (25) Association, J. S. Method for determination of tetra-through octa-chlorodibenzo-p-dioxins, tetra-through octa-chlorodibenzofurans and coplanar polychloro biphenyls in. *JIS K0312* **1999**.
- (26) United States Environmental Protection Agency. *Method 1668B Chlorinated Biphenyl Congeners in Water , Soil , Sediment , Biosolids , and Tissue by HRGC / HRMS*; Washington, DC, 2008.
- (27) United States Environmental Protection Agency. *Method 1613 Tetra- through Octa-Chlorinated Dioxins and Furans by Isotope Dilution HRGC / HRMS*; Washington, DC, 1994.
- (28) Gustafsson, O.; Hagheste, F.; Chan, C.; Macfarlane, J.; Gschwend, P. M. Quantification of the Dilute Sedimentary Soot Phase - Implications for PAH Speciation and Bioavailability. *Environ. Sci. Technol.* **1997**, *31* (1), 203–209.
- (29) Booij, K.; Smedes, F. An improved method for estimating in situ sampling rates of nonpolar passive samplers. *Environ. Sci. Technol.* **2010**, *44* (17), 6789–6794.
- (30) Gschwend, P. M.; Tcaciuc, A. P.; Apell, J. Passive PE Sampling in Support of In Situ Remediation of Contaminated Sediments - Passive Sampler PRC Calculation Software User's Guide. **2014**.
- (31) Khairy, M.; Barrett, K.; Lohmann, R. Changing sources of polychlorinated dibenzo-p-dioxins and furans in sediments and ecological risk for nekton in the lower Passaic River and Newark Bay, New Jersey, USA. *Environ. Toxicol. Chem.* **2016**, *35* (3), 550–562.

**Development of a passive multisampling method to measure
Dioxins/Furans and other contaminant bioavailability in
aquatic sediments**

ER 2538

University of Rhode Island

Lead PI: Rainer Lohmann, Ph.D.

University of Rhode Island

May 31, 2016

Version No 1.

Supplementary data

Table S1: Porewater concentrations of PCBs (pg/L) at River Bank Park, Passaic River.

	Tumbling experiment		<i>In situ</i> sediment porewater sampler			
	25 µm PE	51 µm PE	06/2015-08/2015	08/2015-10/2015	10/2015-12/2015	12/2015-02/2016
PCB 1	46.7	53.2	36.5	42.1	41.1	35.9
PCB 2	7.5	13.3	9.1	8.0	9.6	8.2
PCB 3	10.2	13.9	9.4	10.7	8.6	9.3
PCB 4+10	85.5	118.9	95.2	106.0	107.4	95.5
PCB 9+7	15.3	19.3	17.0	17.7	18.3	17.4
PCB 5+8	92.6	112.0	85.9	82.5	88.4	94.2
PCB 11	91.3	103.4	89.6	82.5	87.6	99.6
PCB 12+13	9.6	12.9	13.4	15.4	14.4	15.7
PCB 18	300.5	386.2	408.2	419.1	350.6	366.6
PCB 16+32	178.1	191.0	186.7	243.1	189.9	204.6
PCB 29	<LOD	<LOD	<LOD	<LOD	<LOD	<LOD
PCB 28+31	374.4	420.8	371.9	432.6	389.9	426.1
PCB 43+52	223.4	252.1	218.0	209.0	275.0	225.1
PCB 104	1.8	2.2	2.5	2.7	1.8	1.8
PCB 44+59+42	181.0	252.0	234.8	272.5	232.9	234.3
PCB 66	98.3	118.2	97.6	138.7	115.2	118.6
PCB 80	51.5	69.7	42.6	54.8	58.8	63.0
PCB 155	1.0	1.2	0.9	1.0	0.8	0.7
PCB 101+113	39.7	52.3	42.3	38.5	42.2	39.8
PCB 119+112	1.7	1.9	1.6	2.5	1.4	1.8
PCB 150	0.4	0.4	0.2	0.3	0.3	0.3
PCB 108+83	<LOD	<LOD	<LOD	<LOD	<LOD	<LOD
PCB 116+117	<LOD	<LOD	<LOD	<LOD	<LOD	<LOD
PCB 111+115+87	9.5	13.8	11.6	10.5	11.0	10.9
PCB 81	0.9	1.1	1.1	1.0	0.8	0.8
PCB 110	30.8	39.5	39.9	33.0	40.2	41.6
PCB 154	1.2	1.5	1.2	1.5	1.2	1.5
PCB 77	3.0	3.9	3.5	2.8	2.9	2.5
PCB 106	4.0	5.1	4.1	4.9	4.8	3.9
PCB 118	11.8	14.6	15.7	14.5	10.6	11.2
PCB 143+134	1.6	1.8	1.5	1.2	1.7	1.5
PCB 114	<LOD	<LOD	<LOD	<LOD	<LOD	<LOD
PCB 132+168+153	23.3	29.6	19.8	29.6	22.3	24.3
PCB 105	7.6	10.0	8.5	7.8	8.2	8.8
PCB 160+138+158	10.0	13.0	10.3	10.5	9.8	7.2
PCB 186	<LOD	<LOD	<LOD	<LOD	<LOD	<LOD
PCB 129	<LOD	<LOD	<LOD	<LOD	<LOD	<LOD
PCB 178	0.8	1.0	0.6	0.8	0.6	0.8
PCB 126	1.2	1.6	1.5	1.2	1.3	1.4

<LOD: below the limit of detection

Table S1: Continued.

	Tumbling experiment		<i>In situ</i> sediment porewater sampler			
	25 μ m PE	51 μ m PE	06/2015- 08/2015	08/2015- 10/2015	10/2015- 12/2015	12/2015- 02/2016
PCB 182+187	3.8	4.3	2.9	4.4	3.6	3.4
PCB 128+162	1.4	1.8	1.7	1.5	1.0	1.1
PCB 167	0.3	0.3	0.3	0.2	0.2	0.3
PCB 185	0.4	0.5	0.3	0.5	0.3	0.4
PCB 174+181	2.6	3.0	1.8	1.9	2.1	1.8
PCB 177	1.9	2.3	1.5	1.8	1.7	1.3
PCB 202	0.6	0.7	0.6	0.6	0.6	0.6
PCB 156	0.7	0.7	0.7	0.9	0.9	1.0
PCB 157	<LOD	<LOD	<LOD	<LOD	<LOD	<LOD
PCB 204	<LOD	<LOD	<LOD	<LOD	<LOD	<LOD
PCB 180+193	4.0	3.9	2.6	3.8	3.3	3.2
PCB 200	0.2	0.2	0.3	0.2	0.2	0.2
PCB 169	<LOD	<LOD	<LOD	<LOD	<LOD	<LOD
PCB 170+190	1.6	2.0	1.4	2.1	1.7	1.6
PCB 198	1.2	1.2	1.6	2.0	1.3	1.3
PCB 189	<LOD	<LOD	<LOD	<LOD	<LOD	<LOD
PCB 208	0.3	0.3	0.2	0.3	0.3	0.3
PCB 195	0.3	0.4	0.4	0.4	0.4	0.4
PCB 207	0.1	0.1	0.1	0.1	0.1	0.1
PCB 194	0.6	0.7	0.7	0.6	0.7	0.6
PCB 205	<LOD	<LOD	<LOD	<LOD	<LOD	<LOD
PCB 206	0.4	0.4	0.4	0.4	0.4	0.4
PCB 209	0.2	0.2	0.1	0.2	0.2	0.2
\sum_{89} PCBs	1,936	2,355	2,101	2,321	2,169	2,193

<LOD: below the limit of detection

Table S2: Porewater concentrations of PCBs (pg/L) at Bridge street, Passaic River.

	Tumbling experiment		<i>In situ</i> sediment porewater sampler			
	25 µm PE	51 µm PE	06/2015-08/2015	08/2015-10/2015	Lost	Lost
PCB 1	81.69	94.64	87.07	94.86		
PCB 2	23.63	29.75	23.83	30.00		
PCB 3	18.79	25.54	23.14	19.63		
PCB 4+10	192.80	195.17	171.89	190.01		
PCB 9+7	24.49	28.37	16.88	17.90		
PCB 5+8	245.50	287.49	282.77	278.79		
PCB 11	106.91	155.13	175.51	183.50		
PCB 12+13	18.20	21.02	16.39	19.08		
PCB 18	812.46	939.89	904.38	925.43		
PCB 16+32	489.37	516.34	444.20	435.44		
PCB 29	<LOD	<LOD	<LOD	<LOD		
PCB 28+31	557.62	564.54	495.21	567.54		
PCB 43+52	752.53	826.55	854.20	902.08		
PCB 104	3.73	4.21	3.18	3.38		
PCB 44+59+42	487.30	550.36	560.19	558.54		
PCB 66	160.97	182.41	196.81	228.13		
PCB 80	68.60	86.59	90.98	75.67		
PCB 155	2.89	2.82	2.43	2.72		
PCB 101+113	82.30	99.67	108.20	98.60		
PCB 119+112	41.30	49.01	45.03	40.28		
PCB 150	0.72	0.85	0.63	0.77		
PCB 108+83	4.32	5.12	5.33	6.16		
PCB 116+117	29.63	39.20	39.71	37.84		
PCB 111+115+87	20.35	26.58	23.35	21.90		
PCB 81	2.36	2.80	3.02	2.34		
PCB 110	62.50	76.31	81.75	85.61		
PCB 154	4.96	5.40	4.67	4.69		
PCB 77	6.44	7.56	7.96	7.40		
PCB 106	9.36	10.85	11.36	11.91		
PCB 118	24.50	22.86	28.33	28.49		
PCB 143+134	3.12	3.63	4.03	4.32		
PCB 114	2.15	3.25	2.95	3.69		
PCB 132+168+153	46.90	50.94	55.71	58.62		
PCB 105	16.70	18.65	21.85	21.75		
PCB 160+138+158	20.30	25.97	22.51	24.33		
PCB 186	<LOD	<LOD	<LOD	<LOD		
PCB 129	1.73	2.15	1.74	2.23		
PCB 178	1.75	1.93	1.82	1.79		
PCB 126	<LOD	<LOD	<LOD	<LOD		

<LOD: below the limit of detection

Table S2: Continued.

	Tumbling experiment		<i>In situ</i> sediment porewater sampler			
	25 µm PE	51 µm PE	06/2015-08/2015	08/2015-10/2015	Lost	Lost
PCB 182+187	7.35	8.60	6.68	7.70		
PCB 128+162	3.26	4.34	4.85	4.29		
PCB 167	0.54	0.68	0.62	0.71		
PCB 185	0.78	1.25	1.17	1.35		
PCB 174+181	4.36	5.77	4.29	4.84		
PCB 177	3.12	4.10	4.09	4.59		
PCB 202	1.35	1.29	1.98	1.41		
PCB 156	1.22	1.50	1.52	1.60		
PCB 157	0.31	0.31	0.41	0.41		
PCB 204	0.47	0.58	0.56	0.57		
PCB 180+193	5.32	6.10	7.32	7.81		
PCB 200	0.36	0.25	0.21	0.24		
PCB 169	<LOD	<LOD	<LOD	<LOD		
PCB 170+190	2.05	1.98	2.52	2.30		
PCB 198	1.42	2.44	3.15	2.59		
PCB 189	<LOD	<LOD	<LOD	<LOD		
PCB 208	0.28	0.35	0.46	0.42		
PCB 195	0.32	0.21	0.47	0.44		
PCB 207	0.08	0.08	0.09	0.08		
PCB 194	0.51	0.69	0.75	0.67		
PCB 205	<LOD	<LOD	<LOD	<LOD		
PCB 206	0.17	0.26	0.37	0.39		
PCB 209	0.06	0.04	0.04	0.04		
∑₈₉ PCBs	4,462	5,004	4,861	5,038		

<LOD: below the limit of detection

Table S3: Porewater concentrations of PCBs (pg/L) at Doremus street, Passaic River.

	Tumbling experiment		<i>In situ</i> sediment porewater sampler			
	25 µm PE	51 µm PE	06/2015-08/2015	08/2015-10/2015	10/2015-12/2015	12/2015-02/2016
PCB 1	62.7	81.2	75.2	85.1	78.3	83.6
PCB 2	9.3	8.1	6.8	7.0	7.2	7.6
PCB 3	17.6	16.4	14.8	11.2	12.2	11.2
PCB 4+10	85.2	97.1	77.2	80.9	74.1	80.0
PCB 9+7	14.4	18.2	23.7	18.3	15.9	14.2
PCB 5+8	87.5	94.3	89.0	91.5	108.7	96.2
PCB 11	76.6	84.7	109.1	93.0	106.0	96.2
PCB 12+13	9.3	12.9	11.3	12.4	10.9	12.8
PCB 18	296.3	287.3	335.0	257.5	224.1	257.3
PCB 16+32	163.4	190.1	219.5	249.1	244.8	230.9
PCB 29	<LOD	<LOD	<LOD	<LOD	<LOD	<LOD
PCB 28+31	374.2	389.2	360.5	330.8	300.0	286.3
PCB 43+52	366.2	464.4	498.4	439.2	399.4	395.3
PCB 104	1.9	1.8	1.9	1.5	1.4	1.3
PCB 44+59+42	280.2	374.1	355.5	410.4	379.8	361.5
PCB 66	87.5	88.0	82.4	100.1	78.4	89.3
PCB 80	41.5	60.1	73.3	64.3	69.9	71.5
PCB 155	1.2	1.0	0.9	1.1	1.2	1.0
PCB 101+113	52.6	53.6	62.0	66.4	60.0	61.2
PCB 119+112	2.9	2.2	2.3	2.5	1.9	2.5
PCB 150	0.6	0.5	0.5	0.6	0.6	0.6
PCB 108+83	2.5	3.2	3.0	2.7	2.5	2.5
PCB 116+117	2.2	2.0	2.3	2.3	1.8	1.7
PCB 111+115+87	12.5	13.7	15.7	15.0	18.4	13.1
PCB 81	2.0	1.2	2.5	2.2	2.6	2.2
PCB 110	43.9	45.4	63.9	58.9	60.7	60.9
PCB 154	1.5	2.0	2.8	3.0	2.4	2.7
PCB 77	5.9	6.5	6.7	6.5	7.3	7.2
PCB 106	5.0	5.1	3.9	3.4	3.5	3.5
PCB 118	17.0	16.2	17.2	18.9	18.2	20.9
PCB 143+134	2.1	3.5	2.6	3.5	2.8	2.3
PCB 114	<LOD	<LOD	<LOD	<LOD	<LOD	<LOD
PCB 132+168+153	31.6	30.2	29.5	32.7	32.0	33.9
PCB 105	10.7	11.3	10.6	9.3	11.0	9.0
PCB 160+138+158	13.7	15.8	15.5	14.2	15.6	15.0
PCB 186	<LOD	<LOD	<LOD	<LOD	<LOD	<LOD
PCB 129	<LOD	<LOD	<LOD	<LOD	<LOD	<LOD
PCB 178	1.2	0.9	0.8	0.7	0.8	0.7
PCB 126	0.4	0.5	0.5	0.5	0.5	0.5

<LOD: below the limit of detection

Table S3: Continued.

	Tumbling experiment		<i>In situ</i> sediment porewater sampler			
	25 µm PE	51 µm PE	06/2015- 08/2015	08/2015- 10/2015	10/2015- 12/2015	12/2015- 02/2016
PCB 182+187	5.0	4.2	3.6	3.4	3.4	3.4
PCB 128+162	2.3	2.1	2.1	1.8	2.0	2.3
PCB 167	0.4	0.3	0.3	0.2	0.3	0.4
PCB 185	0.5	0.4	0.3	0.3	0.3	0.3
PCB 174+181	3.3	3.1	2.1	2.2	2.0	2.3
PCB 177	2.4	2.1	2.0	1.5	1.5	2.2
PCB 202	0.9	0.7	1.4	1.4	1.2	1.0
PCB 156	0.8	0.8	0.6	0.6	0.7	0.6
PCB 157	<LOD	<LOD	<LOD	<LOD	<LOD	<LOD
PCB 204	0.3	0.4	0.3	0.4	0.3	0.3
PCB 180+193	4.7	4.3	4.0	3.3	4.1	3.3
PCB 200	0.2	0.2	0.2	0.1	0.2	0.2
PCB 169	<LOD	<LOD	<LOD	<LOD	<LOD	<LOD
PCB 170+190	2.0	2.0	1.8	1.8	1.5	2.2
PCB 198	1.6	0.9	0.9	1.0	1.2	0.9
PCB 189	<LOD	<LOD	<LOD	<LOD	<LOD	<LOD
PCB 208	0.3	0.2	0.2	0.2	0.2	0.2
PCB 195	0.3	0.3	0.3	0.2	0.3	0.2
PCB 207	<LOD	<LOD	<LOD	<LOD	<LOD	<LOD
PCB 194	0.6	0.5	0.5	0.5	0.5	0.5
PCB 205	<LOD	<LOD	<LOD	<LOD	<LOD	<LOD
PCB 206	0.4	0.3	0.4	0.3	0.3	0.3
PCB 209	0.2	0.1	0.1	0.1	0.1	0.2
∑₈₉ PCBs	2,209	2,506	2,598	2,516	2,375	2,357

<LOD: below the limit of detection

Table S4: Porewater concentrations of PCBs (pg/L) at Passaic Ave, Passaic River.

	Tumbling experiment		<i>In situ</i> sediment porewater sampler			
	25 µm PE	51 µm PE	06/2015-08/2015	08/2015-10/2015	10/2015-12/2015	12/2015-02/2016
PCB 1	44.2	57.6	52.3	53.1	48.4	49.9
PCB 2	10.3	14.0	15.8	16.1	12.0	12.0
PCB 3	17.3	16.9	16.6	20.3	14.7	14.2
PCB 4+10	103.5	157.1	115.5	127.7	158.1	149.3
PCB 9+7	14.5	16.7	18.2	19.6	17.0	15.6
PCB 5+8	120.2	128.8	160.2	157.6	134.2	123.4
PCB 11	98.2	107.4	81.0	88.7	79.3	86.1
PCB 12+13	11.9	12.0	12.4	14.4	11.3	10.8
PCB 18	280.3	298.9	264.4	242.7	244.0	213.8
PCB 16+32	291.3	346.0	377.0	325.0	347.9	419.9
PCB 29	<LOD	<LOD	<LOD	<LOD	<LOD	<LOD
PCB 28+31	428.3	514.3	602.4	533.8	505.4	557.6
PCB 43+52	327.1	356.5	372.5	390.4	362.9	343.6
PCB 104	3.6	3.5	2.9	2.6	2.7	2.5
PCB 44+59+42	225.5	234.0	265.6	257.5	216.2	254.5
PCB 66	54.2	67.0	65.8	72.4	69.0	75.6
PCB 80	24.3	34.5	36.1	40.1	38.7	39.9
PCB 155	2.1	1.3	1.8	1.5	1.4	1.2
PCB 101+113	56.2	60.6	74.3	65.9	66.3	65.0
PCB 119+112	<LOD	<LOD	<LOD	<LOD	<LOD	<LOD
PCB 150	0.5	0.6	0.5	0.5	0.5	0.5
PCB 108+83	<LOD	<LOD	<LOD	<LOD	<LOD	<LOD
PCB 116+117	19.2	23.1	25.0	23.2	22.4	21.5
PCB 111+115+87	<LOD	<LOD	<LOD	<LOD	<LOD	<LOD
PCB 81	1.2	1.2	1.1	1.3	1.9	1.7
PCB 110	46.3	49.7	51.9	48.7	46.2	56.0
PCB 154	3.4	3.2	3.7	4.0	3.7	3.7
PCB 77	4.0	4.9	4.3	4.6	4.4	5.1
PCB 106	4.9	3.7	4.3	4.1	4.7	5.1
PCB 118	18.2	18.2	25.1	25.9	20.0	27.0
PCB 143+134	2.7	4.2	2.7	3.1	2.8	3.1
PCB 114	<LOD	<LOD	<LOD	<LOD	<LOD	<LOD
PCB 132+168+153	32.5	34.4	38.6	44.8	34.4	40.3
PCB 105	10.1	12.6	15.3	14.2	16.5	15.3
PCB 160+138+158	13.3	15.5	20.8	22.7	17.1	15.1
PCB 186	<LOD	<LOD	<LOD	<LOD	<LOD	<LOD
PCB 129	<LOD	<LOD	<LOD	<LOD	<LOD	<LOD
PCB 178	1.2	0.8	1.2	1.6	1.3	1.2
PCB 126	1.8	1.0	1.9	1.6	1.3	1.2

<LOD: below the limit of detection

Table S4: Continued.

	Tumbling experiment		<i>In situ</i> sediment porewater sampler			
	25 µm PE	51 µm PE	06/2015- 08/2015	08/2015- 10/2015	10/2015- 12/2015	12/2015- 02/2016
PCB 182+187	4.9	4.0	5.8	4.9	4.5	4.9
PCB 128+162	1.7	2.1	2.9	2.9	2.2	1.9
PCB 167	0.4	0.3	0.4	0.3	0.4	0.4
PCB 185	0.5	0.4	0.6	0.6	0.5	0.6
PCB 174+181	3.2	3.2	4.4	4.4	4.2	3.8
PCB 177	3.0	1.8	2.8	2.5	2.7	2.5
PCB 202	0.7	0.5	0.6	0.6	0.6	0.6
PCB 156	0.8	0.8	1.0	0.9	1.0	1.2
PCB 157	<LOD	<LOD	<LOD	<LOD	<LOD	<LOD
PCB 204	<LOD	<LOD	<LOD	<LOD	<LOD	<LOD
PCB 180+193	4.1	3.9	4.9	4.4	4.4	3.8
PCB 200	0.3	0.2	0.2	0.3	0.2	0.2
PCB 169	<LOD	<LOD	<LOD	<LOD	<LOD	<LOD
PCB 170+190	1.7	1.7	2.3	2.2	2.6	2.4
PCB 198	1.0	0.9	1.2	1.2	1.3	1.2
PCB 189	<LOD	<LOD	<LOD	<LOD	<LOD	<LOD
PCB 208	0.2	0.1	0.2	0.2	0.2	0.2
PCB 195	0.3	0.2	0.3	0.2	0.3	0.2
PCB 207	<LOD	<LOD	<LOD	<LOD	<LOD	<LOD
PCB 194	0.3	0.4	0.4	0.5	0.4	0.4
PCB 205	<LOD	0.0	0.0	0.0	0.0	0.0
PCB 206	0.1	0.2	0.2	0.2	0.2	0.2
PCB 209	0.1	0.1	0.1	0.1	0.1	0.1
∑₈₉ PCBs	2,295	2,621	2,760	2,656	2,532	2,656

<LOD: below the limit of detection

Table S5: Porewater concentrations of PCDD/Fs (pg/L) at River Bank Park, Passaic River.

	Tumbling experiment		<i>In situ</i> sediment porewater sampler			
	25 µm PE	51 µm PE	06/2015-08/2015	08/2015-10/2015	10/2015-12/2015	12/2015-02/2016
2-MCDF	9.24	10.88	14.69	12.98	11.04	8.86
2-MCDD	<LOD	<LOD	<LOD	<LOD	<LOD	<LOD
2,8-DiCDF	4.02	3.95	4.33	5.25	5.68	5.85
2,7,2,8-DiCDD	6.49	6.21	5.36	4.92	4.24	4.87
2,3,8-TriCDF	2.21	2.25	2.11	2.56	2.34	2.54
1,2,4-TriCDD	0.26	0.21	0.21	0.27	0.26	0.29
2,3,7,8-TCDF	0.22	0.25	0.21	0.25	0.23	0.20
1,3,6,8-TCDD	0.10	0.10	0.12	0.10	0.13	0.16
1,3,7,8-TCDD	<LOD	<LOD	<LOD	<LOD	<LOD	<LOD
2,3,7,8-TCDD	0.18	0.15	0.10	0.14	0.11	0.11
1,2,8,9-TCDD	<LOD	<LOD	<LOD	<LOD	<LOD	<LOD
1,2,3,4,7-PCDF	0.02	0.02	0.03	0.02	0.03	0.03
2,3,4,7,8-PCDF	0.04	0.05	0.04	0.03	0.03	0.02
1,2,3,4,7-PCDD	<LOD	<LOD	<LOD	<LOD	<LOD	<LOD
1,2,3,4,7,8-HxCDF	0.03	0.03	0.02	0.02	0.02	0.03
1,2,3,6,7,8-HxCDF	<LOD	<LOD	<LOD	<LOD	<LOD	<LOD
1,2,3,7,8,9-HxCDF	<LOD	<LOD	<LOD	<LOD	<LOD	<LOD
2,3,4,6,7,8-HxCDF	<LOD	<LOD	<LOD	<LOD	<LOD	<LOD
1,2,3,4,7,8-HxCDD	<LOD	<LOD	<LOD	<LOD	<LOD	<LOD
1,2,3,6,7,8-HxCDD	0.04	0.03	0.03	0.03	0.04	0.03
1,2,3,7,8,9-HxCDD	<LOD	<LOD	<LOD	<LOD	<LOD	<LOD
1,2,3,4,6,7,8-HpCDF	0.04	0.03	0.03	0.03	0.03	0.02
1,2,3,4,7,8,9-HpCDF	<LOD	<LOD	<LOD	<LOD	<LOD	<LOD
1,2,3,4,6,7,8-HpCDD	0.04	0.05	0.05	0.05	0.07	0.07
OCDF	0.02	0.02	0.02	0.02	0.02	0.01
OCDD	0.11	0.09	0.11	0.11	0.09	0.10
∑₂₇ PCDD/Fs	23.05	24.32	27.46	26.79	24.35	23.18

<LOD: below the limit of detection

Table S6: Porewater concentrations of PCDD/Fs (pg/L) at Bridge Street, Passaic River.

	Tumbling experiment		<i>In situ</i> sediment porewater sampler			
	25 µm PE	51 µm PE	06/2015-08/2015	08/2015-10/2015	10/2015-12/2015	12/2015-02/2016
2-MCDF	9.255	10.680	13.408	8.120	Lost	Lost
2-MCDD	<LOD	<LOD	<LOD	<LOD		
2,8-DiCDF	8.013	8.071	6.824	9.481		
2,7/2,8-DiCDD	4.789	4.036	4.341	4.589		
2,3,8-TriCDF	3.661	3.789	4.835	4.011		
1,2,4-TriCDD	0.268	0.280	0.315	0.307		
2,3,7,8-TCDF	0.260	0.268	0.213	0.294		
1,3,6,8-TCDD	0.078	0.093	0.098	0.096		
1,3,7,8-TCDD	0.038	0.033	0.042	0.031		
2,3,7,8-TCDD	0.111	0.135	0.150	0.161		
1,2,8,9-TCDD	<LOD	<LOD	<LOD	<LOD		
1,2,3,4,7-PCDF	0.077	0.077	0.092	0.075		
2,3,4,7,8-PCDF	<LOD	<LOD	<LOD	<LOD		
1,2,3,4,7-PCDD	<LOD	<LOD	<LOD	<LOD		
1,2,3,4,7,8-HxCDF	<LOD	<LOD	<LOD	<LOD		
1,2,3,6,7,8-HxCDF	<LOD	<LOD	<LOD	<LOD		
1,2,3,7,8,9-HxCDF	<LOD	<LOD	<LOD	<LOD		
2,3,4,6,7,8-HxCDF	<LOD	<LOD	<LOD	<LOD		
1,2,3,4,7,8-HxCDD	<LOD	<LOD	<LOD	<LOD		
1,2,3,6,7,8-HxCDD	<LOD	<LOD	<LOD	<LOD		
1,2,3,7,8,9-HxCDD	<LOD	<LOD	<LOD	<LOD		
1,2,3,4,6,7,8-HpCDF	<LOD	<LOD	<LOD	<LOD		
1,2,3,4,7,8,9-HpCDF	<LOD	<LOD	<LOD	<LOD		
1,2,3,4,6,7,8-HpCDD	0.024	0.024	0.026	0.020		
OCDF	<LOD	<LOD	<LOD	<LOD		
OCDD	0.018	0.016	0.017	0.019		
∑₂₇ PCDD/Fs	26.60	27.50	30.36	27.20		

<LOD: below the limit of detection

Table S7: Porewater concentrations of PCDD/Fs (pg/L) at Doremus Street, Passaic River.

	Tumbling experiment		<i>In situ</i> sediment porewater sampler			
	25 µm PE	51 µm PE	06/2015-08/2015	08/2015-10/2015	10/2015-12/2015	12/2015-02/2016
2-MCDF	11.28	9.91	11.98	11.91	12.02	12.90
2-MCDD	<LOD	<LOD	<LOD	<LOD	<LOD	<LOD
2,8-DiCDF	7.99	8.88	10.21	10.53	11.86	13.13
2,7/2,8-DiCDD	6.78	6.78	6.38	5.74	5.47	4.68
2,3,8-TriCDF	13.62	13.79	11.23	11.62	10.37	10.54
1,2,4-TriCDD	0.350	0.316	0.234	0.262	0.277	0.230
2,3,7,8-TCDF	0.297	0.334	0.255	0.336	0.313	0.277
1,3,6,8-TCDD	0.113	0.129	0.113	0.108	0.134	0.135
1,3,7,8-TCDD	<LOD	<LOD	<LOD	<LOD	<LOD	<LOD
2,3,7,8-TCDD	0.125	0.114	0.146	0.156	0.139	0.115
1,2,8,9-TCDD	<LOD	<LOD	<LOD	<LOD	<LOD	<LOD
1,2,3,4,7-PCDF	0.026	0.023	0.027	0.023	0.026	0.030
2,3,4,7,8-PCDF	0.022	0.024	0.019	0.017	0.013	0.013
1,2,3,4,7-PCDD	<LOD	<LOD	<LOD	<LOD	<LOD	<LOD
1,2,3,4,7,8-HxCDF	0.014	0.012	0.009	0.011	0.014	0.012
1,2,3,6,7,8-HxCDF	<LOD	<LOD	<LOD	<LOD	<LOD	<LOD
1,2,3,7,8,9-HxCDF	<LOD	<LOD	<LOD	<LOD	<LOD	<LOD
2,3,4,6,7,8-HxCDF	<LOD	<LOD	<LOD	<LOD	<LOD	<LOD
1,2,3,4,7,8-HxCDD	<LOD	<LOD	<LOD	<LOD	<LOD	<LOD
1,2,3,6,7,8-HxCDD	<LOD	<LOD	<LOD	<LOD	<LOD	<LOD
1,2,3,7,8,9-HxCDD	<LOD	<LOD	<LOD	<LOD	<LOD	<LOD
1,2,3,4,6,7,8-HpCDF	0.010	0.012	0.012	0.013	0.017	0.013
1,2,3,4,7,8,9-HpCDF	<LOD	<LOD	<LOD	<LOD	<LOD	<LOD
1,2,3,4,6,7,8-HpCDD	0.022	0.022	0.023	0.031	0.028	0.032
OCDF	<LOD	<LOD	<LOD	<LOD	<LOD	<LOD
OCDD	0.024	0.020	0.020	0.024	0.024	0.026
∑₂₇ PCDD/Fs	40.67	40.36	40.65	40.78	40.71	42.13

<LOD: below the limit of detection

Table S8: Porewater concentrations of PCDD/Fs (pg/L) at Passaic Ave, Passaic River.

	Tumbling experiment		<i>In situ</i> sediment porewater sampler			
	25 µm PE	51 µm PE	06/2015-08/2015	08/2015-10/2015	10/2015-12/2015	12/2015-02/2016
2-MCDF	15.94	13.42	12.47	15.49	13.87	11.89
2-MCDD	<LOD	<LOD	<LOD	<LOD	<LOD	<LOD
2,8-DiCDF	6.12	5.12	5.93	7.21	7.91	7.35
2,7,2,8-DiCDD	6.08	7.03	8.36	7.48	5.90	5.93
2,3,8-TriCDF	6.03	5.76	4.66	4.04	3.84	3.27
1,2,4-TriCDD	0.34	0.35	0.28	0.23	0.19	0.23
2,3,7,8-TCDF	0.25	0.22	0.26	0.31	0.31	0.26
1,3,6,8-TCDD	0.12	0.12	0.14	0.13	0.10	0.09
1,3,7,8-TCDD	0.06	0.05	0.07	0.07	0.07	0.07
2,3,7,8-TCDD	0.17	0.14	0.15	0.15	0.12	0.11
1,2,8,9-TCDD	<LOD	<LOD	<LOD	<LOD	<LOD	<LOD
1,2,3,4,7-PCDF	0.02	0.02	0.03	0.03	0.02	0.02
2,3,4,7,8-PCDF	<LOD	<LOD	<LOD	<LOD	<LOD	<LOD
1,2,3,4,7-PCDD	<LOD	<LOD	<LOD	<LOD	<LOD	<LOD
1,2,3,4,7,8-HxCDF	<LOD	<LOD	<LOD	<LOD	<LOD	<LOD
1,2,3,6,7,8-HxCDF	<LOD	<LOD	<LOD	<LOD	<LOD	<LOD
1,2,3,7,8,9-HxCDF	<LOD	<LOD	<LOD	<LOD	<LOD	<LOD
2,3,4,6,7,8-HxCDF	<LOD	<LOD	<LOD	<LOD	<LOD	<LOD
1,2,3,4,7,8-HxCDD	<LOD	<LOD	<LOD	<LOD	<LOD	<LOD
1,2,3,6,7,8-HxCDD	<LOD	<LOD	<LOD	<LOD	<LOD	<LOD
1,2,3,7,8,9-HxCDD	<LOD	<LOD	<LOD	<LOD	<LOD	<LOD
1,2,3,4,6,7,8-HpCDF	<LOD	<LOD	<LOD	<LOD	<LOD	<LOD
1,2,3,4,7,8,9-HpCDF	<LOD	<LOD	<LOD	<LOD	<LOD	<LOD
1,2,3,4,6,7,8-HpCDD	0.03	0.03	0.05	0.05	0.04	0.03
OCDF	<LOD	<LOD	<LOD	<LOD	<LOD	<LOD
OCDD	0.02	0.02	0.03	0.03	0.03	0.03
∑₂₇ PCDD/Fs	35.18	32.29	32.43	35.21	32.41	29.27

<LOD: below the limit of detection

Table S9: Freely dissolved concentrations of PCBs (pg/L) at the Passaic River.

	S1			S3		
	06/2015-08/2015	08/2015-10/2015	10/2015-12/2015	06/2015-08/2015	08/2015-10/2015	10/2015-12/2015
PCB 1	26.18	47.88	18.25	10.62	65.52	22.38
PCB 2	3.98	5.76	3.09	2.15	9.17	3.19
PCB 3	3.47	22.76	10.15	12.57	31.57	14.55
PCB 4+10	93.35	23.85	9.05	65.24	121.14	4.57
PCB 9+7	11.53	17.89	5.77	1.83	34.74	7.65
PCB 5+8	57.37	61.43	27.54	16.06	77.89	33.46
PCB 11	74.62	54.42	34.97	51.39	47.56	49.01
PCB 12+13	15.57	17.39	7.99	8.88	13.58	9.32
PCB 18	392.08	295.46	148.74	271.02	232.22	143.13
PCB 16+32	235.17	208.54	93.59	133.37	122.29	107.57
PCB 29	0.42	0.61	0.30	<LOD	<LOD	<LOD
PCB 28+31	505.97	392.16	251.85	249.54	189.31	242.20
PCB 43+52	303.78	294.88	177.67	230.59	249.48	194.80
PCB 104	1.96	2.82	1.47	1.51	0.46	1.03
PCB 44+59+42	213.96	197.64	128.26	92.65	105.82	126.87
PCB 66	48.52	76.10	35.40	69.58	50.13	40.88
PCB 80	40.27	46.66	27.83	27.81	18.24	28.19
PCB 155	0.40	0.62	0.38	0.37	0.08	0.16
PCB 101+113	34.01	43.46	22.49	38.65	19.82	20.70
PCB 119+112	1.05	23.44	12.00	1.50	7.06	9.59
PCB 150	0.25	0.27	0.16	0.28	0.10	0.14
PCB 108+83	<LOD	<LOD	<LOD	1.97	0.47	<LOD
PCB 116+117	<LOD	<LOD	<LOD	16.09	0.75	<LOD
PCB 111+115+87	7.89	10.99	5.95	10.23	4.13	5.49
PCB 81	1.58	1.15	0.60	1.77	0.70	0.55
PCB 110	30.79	40.56	22.15	33.53	15.13	20.00
PCB 154	2.21	3.26	1.79	2.54	1.76	1.40
PCB 77	3.88	3.53	2.07	3.11	1.66	1.69
PCB 106	1.78	4.08	1.64	0.59	0.54	1.58
PCB 118	9.08	10.70	6.68	13.25	3.60	4.85
PCB 143+134	9.42	29.59	15.41	6.69	11.51	12.72
PCB 114	<LOD	<LOD	<LOD	<LOD	<LOD	<LOD
PCB 132+168+153	13.65	16.61	10.00	17.12	6.01	6.69
PCB 105	5.57	9.38	4.21	6.69	2.79	4.07
PCB 160+138+158	7.01	8.68	5.20	8.14	2.64	3.06
PCB 186	0.46	0.74	0.45	0.14	0.25	0.31
PCB 129	11.97	25.49	12.77	0.59	0.22	9.34
PCB 178	0.43	0.51	0.33	0.60	0.19	0.21
PCB 126	0.24	0.41	0.21	0.35	0.14	0.20

<LOD: below the limit of detection

Table S9: Continued.

	S1			S3		
	06/2015- 08/2015	08/2015- 10/2015	10/2015- 12/2015	06/2015- 08/2015	08/2015- 10/2015	10/2015- 12/2015
PCB 182+187	2.17	2.37	1.36	2.69	1.09	1.02
PCB 128+162	1.19	1.48	0.82	1.57	0.42	0.52
PCB 167	0.20	0.00	0.15	1.08	0.08	<LOD
PCB 185	0.19	0.17	0.14	0.20	0.11	0.09
PCB 174+181	1.45	1.75	0.92	1.70	0.57	0.59
PCB 177	0.88	0.95	0.48	1.35	0.31	0.42
PCB 202	0.20	0.38	0.21	0.24	0.34	0.19
PCB 156	0.41	0.62	0.36	0.50	0.17	0.16
PCB 157	0.09	0.15	0.04	0.11	0.04	0.03
PCB 204	0.10	0.04	0.04	0.09	0.04	0.03
PCB 180+193	2.24	2.46	1.48	2.73	0.82	1.00
PCB 200	0.06	0.12	0.07	0.07	0.06	0.05
PCB 169	<LOD	<LOD	<LOD	<LOD	<LOD	<LOD
PCB 170+190	0.87	0.95	0.65	1.13	0.32	0.35
PCB 198	0.54	0.75	0.47	0.64	0.68	0.31
PCB 189	<LOD	<LOD	<LOD	<LOD	<LOD	<LOD
PCB 208	0.08	0.17	0.10	0.13	0.35	0.10
PCB 195	0.11	0.19	0.10	0.13	0.06	0.05
PCB 207	<LOD	<LOD	<LOD	0.03	0.08	<LOD
PCB 194	0.22	0.31	0.28	0.26	0.19	0.12
PCB 205	<LOD	<LOD	<LOD	<LOD	<LOD	<LOD
PCB 206	0.17	0.17	0.21	0.23	0.70	0.15
PCB 209	0.06	0.06	0.07	0.08	0.16	0.05
∑₈₉ PCBs	2181	2013	1114	1424	1455	1137

<LOD: below the limit of detection

Table S9: Continued.

	S4		
	06/2015-08/2015	08/2015-10/2015	10/2015-12/2015
PCB 1	7.77	51.43	28.75
PCB 2	2.02	6.19	1.72
PCB 3	3.13	24.45	14.48
PCB 4+10	71.48	25.62	12.08
PCB 9+7	3.42	19.22	8.93
PCB 5+8	20.24	65.98	29.59
PCB 11	56.58	58.46	26.47
PCB 12+13	8.65	18.68	9.63
PCB 18	222.51	317.38	118.48
PCB 16+32	159.44	224.02	97.81
PCB 29	0.67	0.65	0.19
PCB 28+31	266.64	421.26	252.10
PCB 43+52	315.70	316.76	185.83
PCB 104	2.13	3.03	1.45
PCB 44+59+42	205.07	212.31	122.79
PCB 66	43.79	81.73	46.48
PCB 80	33.02	49.36	34.21
PCB 155	0.37	0.67	0.27
PCB 101+113	39.69	46.09	27.05
PCB 119+112	1.25	24.63	12.74
PCB 150	0.25	0.28	0.21
PCB 108+83	1.97	<LOD	<LOD
PCB 116+117	12.92	<LOD	<LOD
PCB 111+115+87	9.13	11.58	5.85
PCB 81	2.22	1.23	0.68
PCB 110	36.89	42.90	22.85
PCB 154	2.67	3.11	1.90
PCB 77	4.16	3.78	1.75
PCB 106	2.56	4.12	1.96
PCB 118	11.22	10.29	6.16
PCB 143+134	1.21	30.60	15.44
PCB 114	<LOD	<LOD	<LOD
PCB 132+168+153	17.85	14.75	9.03
PCB 105	7.00	9.46	4.79
PCB 160+138+158	9.28	7.45	4.02
PCB 186	0.00	0.73	0.35
PCB 129	0.00	24.73	12.64
PCB 178	0.61	0.39	0.24
PCB 126	0.36	0.36	0.21

<LOD: below the limit of detection

Table S9: Continued.

	S4		
	06/2015-08/2015	08/2015-10/2015	10/2015-12/2015
PCB 182+187	3.26	1.75	1.07
PCB 128+162	1.62	1.22	0.68
PCB 167	0.33	<LOD	<LOD
PCB 185	0.25	0.13	0.10
PCB 174+181	2.20	1.35	0.67
PCB 177	1.31	0.74	0.49
PCB 202	0.26	0.27	0.19
PCB 156	0.59	0.46	0.29
PCB 157	0.12	0.11	0.03
PCB 204	0.14	0.03	0.03
PCB 180+193	3.33	1.65	1.04
PCB 200	0.11	0.09	0.06
PCB 169	<LOD	<LOD	<LOD
PCB 170+190	1.43	0.65	0.42
PCB 198	0.76	0.48	0.34
PCB 189	<LOD	<LOD	<LOD
PCB 208	0.14	0.11	0.10
PCB 195	0.18	0.12	0.08
PCB 207	0.03	<LOD	<LOD
PCB 194	0.37	0.19	0.14
PCB 205	<LOD	<LOD	<LOD
PCB 206	0.24	<LOD	0.15
PCB 209	0.09	0.03	0.04
∑₈₉ PCBs	2181	2013	1114

<LOD: below the limit of detection

Table S10: Freely dissolved concentrations of PCDD/Fs (pg/L) at the Passaic River.

	S1			S3		
	06/2015-08/2015	08/2015-10/2015	10/2015-12/2015	06/2015-08/2015	08/2015-10/2015	10/2015-12/2015
2-MCDF	2.61	3.37	3.52	6.06	4.27	6.88
2-MCDD	<LOD	<LOD	<LOD	<LOD	<LOD	<LOD
2,8-DiCDF	2.91	3.52	5.88	15.42	7.36	7.45
2,7,2,8-DiCDD	2.19	1.66	2.10	4.76	2.87	2.08
2,3,8-TriCDF	1.86	1.86	2.06	6.43	2.87	3.46
1,2,4-TriCDD	0.18	0.25	0.11	0.26	0.33	0.23
2,3,7,8-TCDF	0.15	0.18	0.11	0.09	0.07	0.05
1,3,6,8-TCDD	0.02	0.02	0.01	0.02	0.01	0.01
1,3,7,8-TCDD	0.01	0.01	0.01	<LOD	<LOD	<LOD
2,3,7,8-TCDD	0.20	0.15	0.13	0.16	0.07	0.06
1,2,8,9-TCDD	<LOD	<LOD	<LOD	<LOD	<LOD	<LOD
1,2,3,4,7-PCDF	<LOD	<LOD	<LOD	<LOD	0.01	<LOD
2,3,4,7,8-PCDF	0.02	0.01	0.01	0.03	0.01	0.03
1,2,3,4,7-PCDD	<LOD	<LOD	<LOD	<LOD	<LOD	<LOD
1,2,3,4,7,8-HxCDF	<LOD	<LOD	<LOD	0.47	0.23	0.19
1,2,3,6,7,8-HxCDF	<LOD	<LOD	<LOD	<LOD	<LOD	<LOD
1,2,3,7,8,9-HxCDF	<LOD	<LOD	<LOD	<LOD	<LOD	<LOD
2,3,4,6,7,8-HxCDF	0.04	0.04	0.02	0.02	0.02	0.02
1,2,3,4,7,8-HxCDD	<LOD	<LOD	<LOD	<LOD	<LOD	<LOD
1,2,3,6,7,8-HxCDD	<LOD	<LOD	<LOD	<LOD	<LOD	<LOD
1,2,3,7,8,9-HxCDD	<LOD	<LOD	<LOD	<LOD	<LOD	<LOD
1,2,3,4,6,7,8-HpCDF	0.05	0.06	0.05	0.09	0.11	0.07
1,2,3,4,7,8,9-HpCDF	0.02	0.03	0.02	0.03	0.02	0.03
1,2,3,4,6,7,8-HpCDD	0.05	0.03	0.03	<LOD	<LOD	<LOD
OCDF	0.01	0.01	0.01	<LOD	<LOD	<LOD
OCDD	0.05	0.03	0.02	0.04	0.03	0.04
∑₂₇ PCDD/Fs	10.37	11.25	14.12	33.87	18.26	20.60

<LOD: below the limit of detection

Table S10: Continued.

	S4		
	06/2015-08/2015	08/2015-10/2015	10/2015-12/2015
2-MCDF	1.78	2.63	2.50
2-MCDD	<LOD	<LOD	<LOD
2,8-DiCDF	31.53	27.36	34.95
2,7/2,8-DiCDD	4.14	2.30	1.79
2,3,8-TriCDF	3.08	1.22	1.44
1,2,4-TriCDD	0.24	0.18	0.18
2,3,7,8-TCDF	0.15	0.18	0.15
1,3,6,8-TCDD	0.02	0.03	0.02
1,3,7,8-TCDD	<LOD	<LOD	<LOD
2,3,7,8-TCDD	0.33	0.22	0.27
1,2,8,9-TCDD	<LOD	<LOD	<LOD
1,2,3,4,7-PCDF	<LOD	<LOD	<LOD
2,3,4,7,8-PCDF	<LOD	<LOD	<LOD
1,2,3,4,7-PCDD	<LOD	<LOD	<LOD
1,2,3,4,7,8-HxCDF	<LOD	0.02	0.03
1,2,3,6,7,8-HxCDF	<LOD	<LOD	<LOD
1,2,3,7,8,9-HxCDF	<LOD	<LOD	<LOD
2,3,4,6,7,8-HxCDF	0.03	0.01	0.02
1,2,3,4,7,8-HxCDD	<LOD	<LOD	<LOD
1,2,3,6,7,8-HxCDD	<LOD	<LOD	<LOD
1,2,3,7,8,9-HxCDD	<LOD	<LOD	<LOD
1,2,3,4,6,7,8-HpCDF	0.10	0.08	0.09
1,2,3,4,7,8,9-HpCDF	0.03	0.04	0.03
1,2,3,4,6,7,8-HpCDD	<LOD	<LOD	<LOD
OCDF	<LOD	<LOD	<LOD
OCDD	0.06	0.09	0.06
∑₂₇ PCDD/Fs	41.48	34.35	41.51

<LOD: below the limit of detection

Table S11: Fractions of black carbon (f_{BC}) and organic carbon (f_{OC}), and PCB concentrations (ng/g dw) in sediments collected from the lower Passaic River.

	S1	S2	S3	S4
f_{OC}	0.026	0.052	0.015	0.040
f_{BC}	0.009	0.007	0.010	0.009
PCB 1	0.09	0.54	0.16	0.06
PCB 2	0.02	0.14	0.03	0.03
PCB 3	0.03	0.07	0.05	0.04
PCB 4+10	0.25	0.43	0.37	0.27
PCB 9+7	0.09	0.21	0.09	0.08
PCB 5+8	0.44	1.02	0.41	0.49
PCB 11	0.86	1.18	0.73	0.59
PCB 12+13	0.15	0.17	0.12	0.09
PCB 18	2.20	6.71	1.16	1.28
PCB 16+32	1.27	3.67	1.62	1.84
PCB 29	<LOD	<LOD	<LOD	<LOD
PCB 28+31	5.60	9.05	7.22	6.71
PCB 43+52	4.33	17.37	6.47	5.69
PCB 104	0.04	0.10	0.04	0.05
PCB 44+59+42	3.65	10.46	4.89	3.74
PCB 66	4.34	9.06	4.21	3.10
PCB 80	2.59	10.08	4.82	2.53
PCB 155	0.08	0.21	0.09	0.08
PCB 101+113	4.40	8.91	4.80	3.28
PCB 119+112	0.26	3.32	0.24	0.13
PCB 150	0.03	0.07	0.03	0.02
PCB 108+83	<LOD	0.74	0.26	0.13
PCB 116+117	<LOD	3.20	0.17	1.17
PCB 111+115+87	1.26	4.47	1.79	0.95
PCB 81	0.05	0.31	0.13	0.13
PCB 110	3.60	9.56	5.04	3.64
PCB 154	0.39	1.34	0.41	0.58
PCB 77	0.08	0.51	0.60	0.33
PCB 106	0.82	1.44	0.52	0.46
PCB 118	2.70	5.85	4.25	3.64
PCB 143+134	0.67	0.51	0.33	0.33
PCB 114	<LOD	0.69	0.95	0.08
PCB 132+168+153	6.01	15.70	5.22	5.51
PCB 105	1.51	4.49	1.25	1.43
PCB 160+138+158	3.82	7.51	3.63	3.37
PCB 186	0.52	0.58	<LOD	<LOD
PCB 129	<LOD	0.49	23.08	0.22
PCB 178	0.70	0.68	0.34	0.44
PCB 126	0.22	0.79	0.16	0.28

<LOD: below the limit of detection

Table S11: Continued.

	S1	S2	S3	S4
PCB 182+187	3.69	4.13	1.50	1.48
PCB 128+162	0.86	1.88	0.72	0.65
PCB 167	0.09	0.43	0.25	0.18
PCB 185	0.21	0.61	<LOD	0.20
PCB 174+181	1.11	2.17	0.66	1.18
PCB 177	0.93	1.60	0.84	1.33
PCB 202	0.84	0.98	0.57	0.20
PCB 156	0.52	1.08	0.30	0.34
PCB 157	0.08	0.17	0.23	0.09
PCB 204	0.16	0.31	0.16	0.10
PCB 180+193	5.32	6.15	2.14	2.61
PCB 200	0.25	0.18	0.08	0.08
PCB 169	<LOD	<LOD	<LOD	<LOD
PCB 170+190	2.14	1.65	1.54	1.12
PCB 198	2.78	3.99	0.99	0.94
PCB 189	<LOD	<LOD	<LOD	<LOD
PCB 208	0.65	0.49	0.43	0.22
PCB 195	0.51	0.49	0.27	0.24
PCB 207	0.18	0.19	0.16	0.07
PCB 194	1.49	1.43	1.20	0.67
PCB 205	<LOD	<LOD	<LOD	<LOD
PCB 206	2.03	0.98	1.17	0.58
PCB 209	1.00	0.66	0.62	0.43
∑₈₉ PCBs	77.9	171.2	99.5	65.5

<LOD: below the limit of detection

Table S12: Concentrations of PCDD/Fs (pg/g dw) in sediments collected from the lower Passaic River.

	S1	S2	S3	S4
2-MCDF	14.1	7.1	3.8	2.7
2-MCDD	<LOD	2.0	0.5	0.3
2,8-DiCDF	152.9	108.7	149.3	48.0
2,7/2,8-DiCDD	308.0	96.7	80.6	38.5
2,3,8-TriCDF	132.1	62.0	194.9	25.5
1,2,4-TriCDD	29.0	15.8	13.8	5.3
2,3,7,8-TCDF	91.5	71.0	60.1	19.1
1,3,6,8-TCDD	39.2	6.2	12.7	1.9
1,3,7,8-TCDD	7.3	8.9	5.0	2.2
2,3,7,8-TCDD	168.9	170.7	80.3	43.7
1,2,8,9-TCDD	<LOD	<LOD	<LOD	<LOD
1,2,3,4,7-PCDF	18.2	6.6	8.6	1.7
2,3,4,7,8-PCDF	26.8	21.3	30.3	6.1
1,2,3,4,7-PCDD	1.4	2.8	2.4	0.9
1,2,3,4,7,8-HxCDF	90.8	135.6	80.0	28.5
1,2,3,6,7,8-HxCDF	<LOD	<LOD	<LOD	<LOD
1,2,3,7,8,9-HxCDF	6.6	12.3	11.7	3.0
2,3,4,6,7,8-HxCDF	<LOD	4.1	7.7	12.1
1,2,3,4,7,8-HxCDD	6.9	16.0	14.8	8.4
1,2,3,6,7,8-HxCDD	38.2	<LOD	<LOD	<LOD
1,2,3,7,8,9-HxCDD	3.1	6.6	4.9	
1,2,3,4,6,7,8-HpCDF	275.6	314.6	198.1	90.0
1,2,3,4,7,8,9-HpCDF	9.5	12.4	8.9	3.9
1,2,3,4,6,7,8-HpCDD	115.5	229.3	102.8	92.0
OCDF	467.6	479.6	274.5	147.0
OCDD	1,418.9	2,792.1	1,067.8	1,100.1
∑ ₂₇ PCDD/Fs	3,422	4,582	2,414	1,681

<LOD: below the limit of detection

Table S13: Concentrations of PCBs (ng/g lipid) in the benthic species collected from the lower Passaic River.

	Mud crabs (S1)	Tube worms (S1)	Clams (S3)	Shrimp (S3)	Tube worms (S4)
PCB 1	17.3	27.8	18.0	6.9	39.9
PCB 2	1.4	5.6	2.1	1.5	9.8
PCB 3	2.3	23.2	3.1	6.7	38.8
PCB 4+10	7.9	97.5	33.4	23.7	85.7
PCB 9+7	1.9	47.4	3.7	11.8	48.8
PCB 5+8	14.0	219.4	45.8	93.1	401.8
PCB 11	12.8	88.8	59.3	142.9	169.7
PCB 12+13	3.7	6.9	8.6	2.7	11.8
PCB 18	57.9	277.9	213.0	108.6	479.5
PCB 16+32	18.5	185.7	134.7	75.0	310.3
PCB 29	0.0	1.7	51.9	0.6	2.9
PCB 28+31	518.4	471.9	711.6	259.4	679.0
PCB 43+52	236.6	567.6	696.9	328.2	1,624
PCB 104	1.1	0.6	3.7	0.1	0.4
PCB 44+59+42	106.7	551.3	590.2	147.2	740.2
PCB 66	244.9	174.6	505.4	135.9	577.9
PCB 80	1.1	223.7	11.4	0.0	4.1
PCB 155	3.5	1.8	7.5	0.3	0.4
PCB 101+113	305.7	551.9	510.5	146.4	672.6
PCB 119+112	17.2	11.7	32.8	7.2	6.6
PCB 150	1.3	0.8	4.1	0.2	1.0
PCB 108+83	7.8	17.6	28.5	4.5	18.6
PCB 116+117	24.8	106.8	26.9	7.9	21.5
PCB 111+115+87	76.4	157.5	187.2	42.6	194.3
PCB 81	3.6	24.2	19.1	0.8	3.8
PCB 110	393.6	407.6	523.2	110.4	472.5
PCB 154	6.1	119.5	20.5	41.0	188.8
PCB 77	50.8	50.4	43.6	3.0	23.8
PCB 106	68.8	48.0	64.0	21.8	52.9
PCB 118	362.2	241.7	188.2	115.8	250.3
PCB 143+134	4.5	17.7	25.8	4.7	25.3
PCB 114	18.1	14.5	23.2	7.2	16.1
PCB 132+168+153	759.4	553.6	669.5	244.0	699.2
PCB 105	206.1	142.7	184.3	61.7	136.7
PCB 160+138+158	381.7	258.0	229.0	119.8	300.7
PCB 186	6.1	2.0	18.1	0.0	0.0
PCB 129	13.7	9.7	18.8	3.4	13.7
PCB 178	45.6	30.6	36.6	10.2	46.8
PCB 126	27.6	24.6	23.3	8.2	33.0

<LOD: below the limit of detection

Table S13: Continued.

	Mud crabs (S1)	Tube worms (S1)	Clams (S3)	Shrimp (S3)	Tube worms (S4)
PCB 182+187	248.4	196.6	200.0	79.8	298.4
PCB 128+162	35.4	22.9	41.9	10.1	24.7
PCB 167	27.0	14.0	21.3	5.9	16.3
PCB 185	6.7	11.8	11.5	3.2	18.2
PCB 174+181	66.6	72.1	100.2	23.4	88.0
PCB 177	79.9	51.5	70.0	19.8	65.2
PCB 202	30.7	72.0	29.6	29.2	125.2
PCB 156	46.0	24.1	36.9	10.5	30.3
PCB 157	9.5	3.9	7.3	1.8	5.0
PCB 204	13.0	17.1	12.6	7.0	26.7
PCB 180+193	326.1	190.7	251.0	76.3	262.0
PCB 200	3.6	10.1	7.6	3.7	16.0
PCB 169	1.1	1.1	1.7	0.2	1.3
PCB 170+190	88.1	64.6	94.1	22.7	89.0
PCB 198	105.6	143.7	98.4	53.5	232.2
PCB 189	4.4	2.4	3.0	0.0	22.6
PCB 208	22.0	64.6	23.1	23.9	107.5
PCB 195	15.1	12.9	15.5	3.9	16.3
PCB 207	5.7	12.4	6.9	4.8	20.8
PCB 194	50.9	40.3	44.7	11.5	57.5
PCB 205	1.1	1.7	2.6	0.2	2.4
PCB 206	37.1	86.8	49.9	25.8	131.0
PCB 209	22.2	25.5	33.9	7.2	36.7
∑₈₉ PCBs	5,277	6,907	7,141	2,730	10,096

<LOD: below the limit of detection

Table S14: Concentrations of PCDD/Fs (pg/g lipid) in benthic species collected from the lower Passaic River.

	Mud crabs (S1)	Tube worms (S1)	Clams (S3)	Shrimp (S3)	Tube worms (S4)
2-MCDF	289	<LOD	143	304	<LOD
2-MCDD	<LOD	<LOD	<LOD	<LOD	<LOD
2,8-DiCDF	866	729	1,932		2639
2,7/2,8-DiCDD	3,814	4420	3,770	2,940	2,750
2,3,8-TriCDF	3,540	3,563	7,115	4,933	1,554
1,2,4-TriCDD	342	<LOD	745	<LOD	441
2,3,7,8-TCDF	997	<LOD	1098	<LOD	<LOD
1,3,6,8-TCDD	77	70	287	<LOD	<LOD
1,3,7,8-TCDD	<LOD	896	172	<LOD	1,028
2,3,7,8-TCDD	1,969	653	1635	795	863
1,2,8,9-TCDD	<LOD	<LOD	<LOD	<LOD	<LOD
1,2,3,4,7-PCDF	<LOD	<LOD	<LOD	<LOD	<LOD
2,3,4,7,8-PCDF	249	225	<LOD	<LOD	311
1,2,3,4,7-PCDD			<LOD	<LOD	
1,2,3,4,7,8-HxCDF	258	353	681	<LOD	<LOD
1,2,3,6,7,8-HxCDF	94		283	<LOD	<LOD
1,2,3,7,8,9-HxCDF	<LOD	165	133	<LOD	<LOD
2,3,4,6,7,8-HxCDF	<LOD	<LOD	<LOD	<LOD	<LOD
1,2,3,4,7,8-HxCDD	<LOD	<LOD	<LOD	<LOD	<LOD
1,2,3,6,7,8-HxCDD	<LOD	<LOD	<LOD	<LOD	<LOD
1,2,3,7,8,9-HxCDD	<LOD	<LOD	<LOD	<LOD	898
1,2,3,4,6,7,8-HpCDF	1115	933	2240	<LOD	<LOD
1,2,3,4,7,8,9-HpCDF	<LOD	<LOD	<LOD	<LOD	<LOD
1,2,3,4,6,7,8-HpCDD	484	1,076	1,164	698	2,057
OCDF	1,384	1,678	3,129	638	2,691
OCDD	5,958	8,018	8,991	2,028	2,288
Σ₂₇ PCDD/Fs	21,436	22,780	33,517	12,336	17,519

<LOD: below the limit of detection