



TECHNICAL REPORT 3052
January 2017

Demonstration and Commercialization of the Sediment Ecosystem Assessment Protocol

Project ER-201130 Environmental Restoration Project

Gunther Rosen
D. Bart Chadwick
Marianne A. Colvin
SSC Pacific

Chris Stransky
Amec Foster Wheeler

Allen Burton
University of Michigan

John Radford
Zebra-Tech, Ltd.

Howard Bailey
Adrienne Cibor
Nautilus Environmental

Melissa Grover
Geosyntec Environmental

Marc Greenberg
USEPA ERT

Approved for public release.

SSC Pacific
San Diego, CA 92152-5001

Technical Report 3052
January 2017

Demonstration and Commercialization of the Sediment Ecosystem Assessment Protocol

Project ER-201130 Environmental Restoration Project

Gunther Rosen
D. Bart Chadwick
Marianne A. Colvin
SSC Pacific

Chris Stransky
Amec Foster Wheeler

Allen Burton
University of Michigan

John Radford
Zebra-Tech, Ltd.

Howard Bailey
Adrienne Cibor
Nautilus Environmental

Melissa Grover
Geosyntec Environmental

Marc Greenberg
USEPA ERT

Approved for public release.

SSC Pacific
San Diego, CA 92152-5001



SSC Pacific
San Diego, California 92152-5001

G. E. Bonitz, CAPT, USN
Commanding Officer

C. A. Keeney
Executive Director

ADMINISTRATIVE INFORMATION

The work described in this report was performed for the Environmental Security Technology Certification Program (ESTCP) Office, Arlington, VA, by the Energy & Environmental Sustainability Branch (Code 71760) of the Advanced Systems and Applied Sciences Branch (71700), Space and Naval Warfare Systems Center Pacific, San Diego CA. Further support was provided by Amec Foster Wheeler, San Diego, CA; University of Michigan School of Natural Resources and Environment, Ann Arbor, MI; Zebra-Tech, Ltd., Port Nelson, New Zealand; Nautilus Environmental, San Diego, CA; Geosyntec Environmental, San Diego, CA; and U.S. EPA Environmental Response Team, Edison, NJ.

Released by
R. George, Head
Energy & Environmental Sustainability
Branch

Under authority of
A. J. Ramirez, Head
Advanced Systems & Applied
Sciences Division

This is a work of the United States Government and therefore is not copyrighted. This work may be copied and disseminated without restriction.

The citation of trade names and names of manufacturers in this publication is not to construed as official government endorsement or approval of commercial products or services referenced herein.

AquaGate™ and AquaGate+PAC™ are trademarks of AquaBlok, Ltd.
HOBO® is a registered trademark of Onset Computer Corporation.
Microsoft Excel® is a registered trademark of
Pyrex® is a registered trademark of Corning Incorporated.
Sea Technology™ is a trademark of Compass Publications.
Solo® is a registered trademark of Solo Cup Operating Corporation.
TetraMin® is a registered trademark of Spectrum Brands.
Troll® is a registered trademark of In-Situ® Inc.
YSI® is a registered trademark of YSI Incorporated.

ACKNOWLEDGMENTS

This project was supported by the Department of Defense's Environmental Security Technology Certification Program (ESTCP), project #ER-201130. Collaborators on this project were Gunther Rosen, PI; Dr. Bart Chadwick, Co-PI (Space and Naval Warfare Systems Center Pacific); Dr. Allen Burton, Co-PI (University of Michigan, School of Natural Resources & Environment and Cooperative Institute for Limnology & Ecosystems Research); Dr. Marc Greenberg, regulatory partner (United States Environmental Protection Agency, Environmental Response Team [USEPA ERT]); Chris Stransky and Dr. Howard Bailey (AMEC Environment and Infrastructure, Inc, and Nautilus Environmental, LLC., respectively); and John Radford, industry partner (Zebra-Tech, Ltd).

We gratefully acknowledge technical support from, but not limited to Molly Colvin, Victoria Kirtay, Joel Guerrero, Brad Davidson, Bob Johnston, Chuck Katz, Ernie Arias, Pat Earley, and Rob George (SSC Pacific); Renee Dolecal, Nick Hayman, Jacob Munson-Decker (San Diego State University Research Foundation); Adrienne Cibor (Nautilus Environmental); Kelly Tait and Corey Sheredy (AMEC); Guilherme Lotufo and the analytical chemistry laboratory at the U.S. Army Engineer Research and Development Center (ERDC); Jason Conder (Geosyntec, Inc.); Brian Hester, Jay Word, and staff of the Ramboll Environ Port Gamble Bioassay Laboratory; and laboratory and field support from Dr. Allen Burton's research team (Anna Harrison, Kyle Fetters, and Dr. David Costello). Without critical field support provided by Navy divers at PSNS&IMF, and the USEPA ERT at MCB Quantico, these efforts would not have been possible.

Leveraging with multiple SERDP, ESTCP, NESDI, direct Navy and Marine Corps support, and internal SSC Pacific research programs have been monumental towards completion of this project. This includes, but is not limited to, leverage and collaborations associated with ESTCP Project #ER-201311 (Chadwick, Kirtay et al. [Draft]), ESTCP Project #ER-201368 (Chadwick, Kirtay et al Draft), SERDP Project #ER-2428 (Reible, 2016), SERDP Project #ER-1550 (Burton, Chadwick, Rosen, and Greenberg, 2011), NESDI Project #459 (Rosen et al.), a Navy NISE Project led by Molly Colvin (SSC Pacific) to support the purchase and laboratory demonstration of Version 3 SEA Rings, and much appreciated support from Naval Base San Diego (Jessica Palmer and Len Sinfield), Puget Sound Naval Shipyard (Ellen Brown, Mark Wicklein, Dwight Leisle), and Marine Corps Base Quantico (Fred Evans).

ACRONYMS

AMS	Advanced Monitoring System
ASTM	American Society for Testing and Materials
CERCLA	Comprehensive Environmental Response, Compensation & Liability Act
COPC	Contaminants of potential concern
CWA	Clean Water Act
DDD	Dichlorodiphenyldichloroethane
DDE	Dichlorodiphenyldichloroethylene
DDT	Dichlorodiphenyltrichloroethane
DDX	DDT and its primary metabolites, DDD and DDE
DGT	Diffusive gradient in thin film
DO	Dissolved oxygen
DOC	Dissolved organic carbon
DoD	Department of Defense
EPA	Environmental Protection Agency
ERDC	Engineer Research and Development Center
ESTCP	Environmental Security Technology Certification Program
ETV	Environmental Technology Verification
GPS	Global Positioning System
HDPE	High density polyethylene
IMF	Intermediate Maintenance Facility
MCB	Marine Corps Base
MLLW	Mean Lower Low Water
NBSD	Naval Base San Diego
NESDI	Navy Environmental Sustainability Development to Integration
NISE	Naval Innovative Science and Engineering
NPDES	National Pollutant Discharge Elimination System
OF	Outfall
PAH	Polycyclic aromatic hydrocarbon
PBDE	Polybrominated diphenyl ethers
PCB	Polychlorinated biphenyl
PDMS	Polydimethylsiloxane
PSD	Passive sampling device

RPM	Revolutions per minute
SARA	Superfund Amendments and Reauthorization Act
SCCWRP	Southern California Coastal Water Research Project
SEA Ring	Sediment Ecotoxicity Assessment Ring
SEAP	Sediment Ecosystem Assessment Protocol
SED	Surficial sediment toxicity exposure chamber
SERDP	Strategic Environmental Research and Development Program
SOP	Standard Operating Procedure
SPAWAR	Space and Naval Warfare Systems Command
SPME	Solid phase microextraction
SPI	Sediment Profile Imaging
SWI	Sediment-water interface
TBT	Tributyltin
TIE	Toxicity identification evaluation
TMDL	Total maximum daily load
UHMWPE	Ultra High Molecular Weight Polyethylene
USACE	United States Army Corps of Engineers
USEPA	United States Environmental Protection Agency
WC	Water column
Woe	Weight of Evidence

EXECUTIVE SUMMARY

Prior research has shown that *in situ* and integrative approaches including multiple synoptic measurements may be advantageous over the often disjointed traditional laboratory approaches for assessing ecological risk, especially for time-varying stressors (e.g., stormwater runoff and leakage from underwater unexploded ordnance) and *in situ* sediment remedies (e.g., reactive amendments or thin-layer capping) that can't be otherwise accurately replicated in the laboratory. This project was designed to demonstrate, commercialize, and promote regulatory awareness and acceptance of the Sediment Ecosystem Assessment Protocol (SEAP), an integrated assessment ecological risk assessment approach developed under SERDP Project #ER-1550 (Burton et al., 2012, Rosen et al., 2012a), that focuses largely on the performance of a field-deployed device referred to as the Sediment Ecotoxicity Assessment Ring (SEA Ring).

OBJECTIVES OF THE DEMONSTRATION

The specific technical objectives of the technology demonstration were to:

1. Refine the current prototype SEA Ring to be more robust, user friendly and cost-effective for commercial application, and standardize test and quality control procedures;
2. Generate sufficient pertinent and high-quality data to scientifically validate the SEAP technology, introduce the Department of Defense (DoD) user community to the technology, and promote regulatory acceptance through rigorous demonstrations at select DoD sites located in geographically diverse settings, and;
3. Develop cost and performance data to support the commercialization of the technology and establish a pathway for full-scale DoD implementation.

These technical objectives were accomplished at three unique field demonstration sites utilizing two different commercial prototypes of the SEA Ring for *in situ* bioaccumulation or toxicity testing including one to four monitoring events at each site. Sites had varied applications and included the Puget Sound Naval Shipyard and Intermediate Maintenance Facility (PSNS & IMF); the Marine Corps Base (MCB) in Quantico, VA; and Naval Base San Diego (NBSD) in San Diego, CA.

TECHNOLOGY DESCRIPTION

SEAP technology integrates *in situ* biological uptake and effects measures with passive sampling devices and physicochemical tools to assess the sediment-water interface, surficial sediment, overlying water and advective exposure pathways at contaminated sediment sites. Minor modifications also allow for direct application to surface water exposure pathway assessment. The commercially available SEA Ring, developed and refined under this project, consists of a circular carousel capable of housing an array of *in situ* bioassay chambers and passive sampling devices. The SEA Ring represents a valuable alternative over traditional laboratory-based approaches to toxicity and bioaccumulation testing, particularly for scenarios where laboratory testing cannot sufficiently characterize exposure or effects.

DEMONSTRATION RESULTS

Results from a total of eight SEA Ring deployments at three demonstration sites, in addition to third party technology verification under the EPA Environmental Technology Verification (ETV) Program, were used to address performance objectives (Table ES-1). The incorporation of the technology into monitoring at the demonstration sites provided useful data in all cases. The performance objectives of the SEA Ring, however, largely focused on functional aspects of the commercial prototype to assess practicality for deriving high quality data with which to make site management decisions, including those at for gauging sediment remedy effectiveness and assessment of receiving water impacts from stormwater runoff.

Table ES-1. Quantitative and qualitative performance objectives, success criteria, and results from the demonstration.

Quantitative Performance Objectives				
	Performance Objective	Data Requirements	Success Criteria	Results
1	Water quality maintenance	Within chamber and ambient dissolved oxygen (D.O.), salinity, pH, temp, and/or ammonia	SEA Ring chamber $\pm 50\%$ of ambient conditions	Met in most cases. Water quality met criteria in the ETV study and <i>in situ</i> demonstrations using Version 3 SEA Rings. In some cases, D.O. was reduced to <50% of ambient inside the chambers of Version 2 SEA Rings when pump units stopped pumping prior to recovery or in sediments with particularly high oxygen demand.
2	Pumping rate	Water exchange rate within all 10 exposure chambers on a SEA Ring	Volume exchange rate varies by <50% across chambers; minimum six volume turnovers per day	Met. Flow rate varied 3-9% within a SEA Ring (inclusive of both Version 2 and Version 3 pump designs). A minimum of 14 turnovers/d was achieved across all demonstrations, which increased by up to an order of magnitude (~140 turnovers/d) with introduction of more efficient pumps in the Version 3 unit.
3	Sediment/organism recovery	Recovery rate of sediment and/or organisms across chambers/rings	Recover sediment and/or organisms 80% of the time (e.g., four out of five replicates)	Met. Successful recovery of organisms averaged 80–100% for six species, except for one species, (<i>Nephtys caecoides</i>) which averaged 60% in the field.
4	Control performance	Survival or sublethal effects data in SEA Ring and laboratory tests	No statistical difference and <25% difference between beaker and lab tested SEA Ring control samples (ETV)	Met. No statistical difference and difference between SEA Ring and lab beaker control in ETV testing ranged from 0 to 11% for five species (and six toxicity test endpoints).

Table ES-1. Quantitative and qualitative performance objectives, success criteria, and results from the demonstration. (Continued)

Quantitative Performance Objectives				
	Performance Objective	Data Requirements	Success Criteria	Results
5	Completion rate (Completeness)	Percentage of SEA Ring chambers recovered with useful data	≥80% recovery rate of SEA Ring chambers providing useful data	Met. For site demonstrations, SEA Rings were deployed at a total of 69 stations, 66 (96%) of which provided useful data. Of the eight species used in the site demonstrations, seven provided >80% recovery rates, while the polychaete (<i>Nephtys caecoides</i>) resulted in 60% average recovery.
6	Successful identification of confounding factors	Continuous water quality measurements (DO, salinity, temperature, and pH) in select SEA Rings. NH ₃ measurements at test initiation and termination. Sediment grain size.	>90% completion success for proposed water and sediment quality measurements	Met. Critical parameters were documented on a site-specific basis and used to interpret organism recoveries/toxicity in 100% of deployments and SEA Rings deployed.
7	Contaminant uptake	Concurrent assessment of laboratory beaker and SEA Ring tissue concentrations	No statistical difference and <25% difference between SEA Ring and laboratory uptake in controlled lab (ETV) exposures	Met, for two of three species used in the ETV study. Amphipod bioaccumulation was not statistically different but averaged 44% higher in the laboratory tests compared with the SEA Ring study. High variability among replicates both in lab and SEA Ring was likely associated with observed amphipod rejection of the PCB contaminated sediment during first few days of the exposures.

Table ES-1. Quantitative and qualitative performance objectives, success criteria, and results from the demonstration. (Continued)

Quantitative Performance Objectives				
	Performance Objective	Data Requirements	Success Criteria	Results
8	Ease of operator use	Information from commercial partners and end users	Positive feedback from commercial partners/users	Met. EPA and Navy divers quickly understood operation and use of the technology. Review of diver videos and feedback indicated that deployment and recovery operations were challenging at stations with cobble, high shell hash, or other obstructions, while fine grained sediments were easy for such efforts. AMEC and Nautilus commercial partners routinely successfully use the technology in other monitoring programs.
9	Integration of passive samplers	Inclusion of relevant passive samplers in SEA Ring deployments	Successful integration and recovery of passive samplers	Met. SPME or DGTs were successfully integrated for all events and sites, and provided added value to assessments.
10	Diverless deployment & recovery	Accurate depth and spatial placement of SEA Rings; feedback from divers on improved ease or elimination of capping of open-bottomed sediment chambers	Verification that SEA Rings remained in place where initially anchored ¹ ; positive diver feedback	Partially met. Deployment of SEA Rings was completed successfully without the use of divers for the demonstration at NBSD. For the PSNS and MCB Quantico demonstrations, divers were integrated in to the field design. Promising sediment capture devices were evaluated for different sediment types, but require further optimization for a completely diverless system.
11	Cost-benefit	Lab and SEA Ring costs and overall comparison of value between methods	Value of improved certainty of ecological risk relative to actual cost of technology	Met. Costs, outlined in the Cost Analysis section of this report, are comparable to laboratory-based testing, and we believe benefits of improved accuracy, and better management decisions, warrants implementation of this technology for various applications.

DEMONSTRATION SITE 1:

At the PSNS (Pier 7), a baseline monitoring event was conducted in August 2012, followed by three post-remedy monitoring events 10, 22, and 34 months following placement of a reactive amendment. The contaminated area was amended with powdered activated carbon (PAC), using the AquaGate+PAC™ composite aggregate system, under leveraged ESTCP Project #ER-201131 (B. Chadwick, principal investigator; Kirtay et al.). The goal was to decrease the bioavailability of polychlorinated biphenyls (PCBs), which was assessed by conducting *in situ* exposures using SEA Rings loaded with the bent-nosed clams (*Macoma nasuta*) and polychaetes (*Nephtys caecoides*). Successful bioaccumulation results pre-and post-remediation have shown that the amendment is achieving the desired performance criteria for Project #ER-201131 by substantially reducing bioavailability of PCBs at the site, with post amendment site average sum PCB congener concentrations more than 90% lower in clams and worms deployed in SEA Rings. Synoptic placement of passive samplers revealed similar reductions in porewater PCB concentrations. Performance objectives were largely achieved (Table ES-1), with a few notable challenges, including difficulty with installation and recovery at stations with cobble and/or high degrees of shall hash, and loss of some polychaetes. Contributors to worm loss included unavoidable factors such as escape and predation, but also challenges with capping chambers during recovery operations. Demonstration of Version 3 SEA Rings with improved pump performance and battery longevity virtually eliminated water quality concerns.

DEMONSTRATION SITE 2:

At MCB Quantico, pre-remediation monitoring was conducted in October 2012, with two post-remediation assessments approximately 2 and 14 months following the placement of a thin layer sediment cap at a site with elevated chlorinated pesticides (DDT and breakdown products). This demonstration, which leveraged with ESTCP Project #ER-201368 (PI, Dr. Bart Chadwick), involved 14-day *in situ* bioaccumulation exposures with SEA Rings using the freshwater Blackworm (*Lumbriculus variegatus*) and the Asian clam (*Corbicula fluminea*). Assessment of bioaccumulation potential occurred pre- and post-remediation at five locations where the thin layer cap was placed, and at two nearby reference locations. Overall, performance objectives were achieved with good success deploying and retrieving SEA Rings and test organisms. Clam and worm tissue for analysis of DDX was successfully recovered from 100 and 90% of SEA Rings deployed, respectively. As with Puget Sound Naval Shipyard (PSNS), a substantial reduction of contaminants of concern was observed in monitoring events post-remedy. Within SEA Ring replicate variability was low and similar to that of laboratory exposures, but not unexpectedly, significant differences were observed when comparing *in situ* bioaccumulation from laboratory exposures conducted on intact cores collected during the SEA Ring deployment.

DEMONSTRATION SITE 3:

Understanding the impacts of stormwater runoff on marine receiving water environments is a serious challenge using existing standard laboratory-based methods, with *in situ* assessment providing a much more realistic and defensible approach. A stormwater impact assessment in the receiving waters of San Diego Bay was conducted during a series of large storm events occurring between February 28 and March 1, 2014, at Naval Base San Diego. At several locations, SEA Rings were placed at two depths, 1 and 3 meters below the surface to assess potential impacts related to vertical stratification of freshwater entering a marine environment. Four marine species were tested: (1) embryo development of the Mediterranean mussel *Mytilus galloprovincialis*, (2) spore germination and growth of giant kelp *Macrocystis pyrifera*, (3) survival of the mysid shrimp *Americamysis bahia*, and (4) survival of the polychaete worm *Neanthes arenaceodentata*. Results of

the study found physical conditions in the receiving water to vary dramatically both temporally and spatially among a few of locations due to the dynamics between rainfall periods, salinity stratification, and tides/currents. When compared to the far-field in the bay reference site at NBSD, limited toxic effects to bivalve embryos and mysid shrimp were apparent *in situ* at a few locations where salinity was not identified as a confounding factor. With the exception of bivalve embryo development, significant effects were observed for all species exposed near the surface in the Chollas Creek channel, most likely due to extended periods of low salinity. Performance objectives were achieved with good success deploying and retrieving SEA Rings and test organisms at all targeted sites. Incorporation of passive samplers (diffusive gradients in thin films) into the sampling program showed statistically significant relationships between labile metal concentrations and dissolved metal concentrations in composite samples collected from 8 grabs over a 24-hour period, and provided added benefit for toxicity test data interpretation. Stormwater monitoring is inherently challenging, particularly in active industrialized locations such as NBSD. The successful accomplishment of this ambitious demonstration provided confidence in using the SEAP technology for similar future efforts, with lessons learned providing a solid foundation for future use at such sites.

COST PERFORMANCE

Along with demonstrating and validating the SEAP technology, an important goal of this project was to develop and validate, to the extent possible, the expected operational costs of the technology. A Final Cost Assessment Report was submitted under separate cover for this program, with highlights provided herein. Relevant costs and related data were tracked and documented during the demonstrations so that the operational costs of the technology could be estimated with a high degree of confidence. These costs were compared to estimates for traditional laboratory-only toxicity assessment programs using three hypothetical case studies: a sediment toxicity assessment, a sediment bioaccumulation assessment, and a water column toxicity assessment. The cost comparisons for a typical assessment indicate that the inclusion of *in situ* testing using the SEAP protocol can indeed be very comparable in costs to a program with standard laboratory-based test only, with our estimates differing by only 2 to 17%, depending on the type and size of the program (6 and 10 station examples evaluated for three scenarios types: sediment toxicity, bioaccumulation, and water column testing programs). Having more realistic data with which to base decisions has the potential to substantially reduce the degree of remediation alternatives implemented where more conservative decisions are required due to uncertainty.

IMPLEMENTATION ISSUES

The ability for a third party to verify the technology with multiple species and sediment and water types under the U.S. EPA's Environmental Technology Verification (ETV) Program should instill confidence from regulators and Department of Defense (DoD) end users to consider this technology in relevant monitoring and regulatory programs. The SEA Ring technology also performed well at all three demonstration sites, providing useful data for assessing the performance of two different sediment remedies and the receiving water impacts associated with stormwater runoff. Regulatory interest was high at all three sites. Implementation is underway in numerous ways, including continued incorporation of the SEA Ring in upcoming monitoring efforts Marine Corps Base (MCB) Quantico, incorporation into the assessment of receiving water impacts from stormwater particles under SERDP #ER-2428, ongoing use for Areas of Special Biological Significance (ASBS) monitoring requirements at Scripps Institution of Oceanography, potential inclusion in future southern California Bight monitoring efforts, integration into recently approved a Navy Environmental Sustainability Development to Integration (NESDI) Fiscal Year 2017 (FY17) new start project, and potential incorporation into sediment quality monitoring at Puget Sound Naval

Shipyard and Intermediate Maintenance Facility (PSNS&IMF) under direction of Dr. Bob Johnston. Corrective actions for all issues were identified and addressed throughout the project, which led to the development, procurement and demonstration of the commercially available Version 3 SEA Ring (Zebra-Tech, Ltd), which we recommended for end-user consideration.

CONCLUSION

This project completes the field demonstrations of SEAP with a focus on the commercialization of the SEA Ring *in situ* toxicity testing technology. The SEA Rings have been found to meet laboratory-based quality assurance/quality control (QA/QC) criteria/objectives for various toxicity and bioaccumulation tests, have met additional performance objectives developed as a part of this program, and have thus been able to prove that this new technology can successfully better assess toxicological impacts and bioaccumulation in environments with dynamic processes or physical attributes that are not replicable in a laboratory setting. Furthermore, regulatory knowledge and acceptance has been gained through presentation of the technology at several conferences, one-on-one meetings with end users and regulators, and publication of magazine articles and white papers. Several journal articles are also now in progress. The demonstrations have also provided confidence that the technology can successfully be used cost effectively to support similar assessments at DoD facilities and elsewhere.

CONTENTS

EXECUTIVE SUMMARY	vii
1. INTRODUCTION.....	1
1.1 BACKGROUND	1
1.2 OBJECTIVE OF THE DEMONSTRATION	2
1.2.1 Application 1: Sediment Remedy Effectiveness	3
1.2.2 Application 2: Stormwater Effects Assessment	4
1.3 REGULATORY DRIVERS.....	4
2. TECHNOLOGY	7
2.1 TECHNOLOGY DESCRIPTION.....	7
2.2 TECHNOLOGY DEVELOPMENT	8
2.3 ADVANTAGES AND LIMITATIONS OF THE TECHNOLOGY	12
3. PERFORMANCE OBJECTIVES.....	15
3.1 QUANTITATIVE PERFORMANCE OBJECTIVES.....	18
3.1.1 Performance Objectives #1: Water Quality Maintenance	18
3.1.2 Performance Objective #2: Pump Flow Rate	18
3.1.3 Performance Objective #3: Sediment/Organism Recovery.....	19
3.1.4 Performance Objective #4: Control Performance	20
3.1.5 Performance Objective #5: Completion Rate	21
3.1.6 Performance Objective #6: Identification of Confounding Factors	21
3.1.7 Performance Objective #7: Contaminant Uptake	22
3.2 QUALITATIVE PERFORMANCE OBJECTIVES	23
3.2.1 Performance Objective #8: Ease of Operator Use	23
3.2.2 Performance Objective #9: Integration of Passive Samplers.....	23
3.2.3 Performance Objective #10: Diverless Deployment/Recovery	24
3.2.4 Performance Objective #11: Cost-Benefit	24
4. SITE DESCRIPTION	27
4.1 SITE HISTORY AND CHARACTERISTICS	27
4.1.1 Puget Sound Naval Shipyard	27
4.1.2 Marine Corps Base Quantico	28
4.1.3 Naval Base San Diego.....	29
4.2 CONTAMINANT DISTRIBUTION.....	32
4.2.1 Puget Sound Naval Shipyard	32
4.2.2 Marine Corps Base Quantico	32
4.2.3 Naval Base San Diego.....	35
5. TEST DESIGN	39
5.1 CONCEPTUAL EXPERIMENTAL DESIGN.....	39

5.2	BASILINE CHARACTERIZATION.....	39
5.3	ENVIRONMENTAL TECHNOLOGY VERIFICATION (ETV) STUDY	39
5.4	DESIGNS AND LAYOUT OF TECHNOLOGY COMPONENTS	40
5.5	FIELD TESTING	42
5.5.1	Puget Sound Naval Shipyard	42
5.5.2	Marine Corps Base Quantico	46
5.5.3	Naval Base San Diego.....	50
5.6	SAMPLING METHODS.....	55
5.7	SAMPLING RESULTS	59
5.7.1	EPA ETV	60
5.7.2	Puget Sound Naval Shipyard	61
5.7.3	Marine Corps Base Quantico	70
5.7.4	Naval Base San Diego.....	77
6.	PERFORMANCE ASSESSMENT	93
6.1	QUANTITATIVE PERFORMANCE OBJECTIVES.....	93
6.1.1	Performance Objective #1: Water Quality Maintenance	93
6.1.2	Performance Objective #2: Pump Flow Rate	96
6.1.3	Performance Objective #3: Sediment/Organism Recovery.....	98
6.1.4	Performance Objective #4: Control Performance	99
6.1.5	Performance Objective #5: Completion Rate	100
6.1.6	Performance Objective #6: Identification of Confounding Factors	100
6.1.7	Performance Objective #7: Contaminant Uptake	102
6.2	QUALITATIVE PERFORMANCE OBJECTIVES	102
6.2.1	Performance Objective #8: Ease of Operator Use	102
6.2.2	Performance Objective #9: Integration of Passive Samplers.....	103
6.2.3	Performance Objective #10: Diverless Deployment/Recovery	104
6.2.4	Performance Objective #11: Cost-Benefit	104
7.	COST ASSESSMENT	107
7.1	COST REPORTING	107
7.2	COST ANALYSIS.....	107
7.2.1	Cost Basis	107
7.2.2	Cost Drivers.....	108
7.2.3	Life-Cycle Costs.....	109
7.3	COST COMPARISON.....	110
8.	IMPLEMENTATION ISSUES	121
8.1	COST OBSERVATIONS	121
8.2	PERFORMANCE OBSERVATIONS	121
8.3	SCALE-UP	122

8.4 OTHER SIGNIFICANT OBSERVATIONS	122
8.5 LESSONS LEARNED	122
8.6 END-USER ISSUES	122
8.7 APPROACH TO REGULATORY COMPLIANCE AND ACCEPTANCE	123
9. REFERENCES.....	124

APPENDICES

A: POINTS OF CONTACT	A-1
B: SEA RING STANDARD OPERATING PROCEDURE	B-1
C: SEA RING VERSION 3 OPERATION MANUAL V1.7.....	C-1
D: PSNS DATA TABLES	D-1
E: MCB QUANTICO DATA TABLES	E-1
F: NBSD DATA.....	F-1
G: TEST CONDITIONS.....	G-1
H: DGT STANDARD OPERATING PROCEDURE	H-1

Figures

2-1. Schematic and assembled first-generation SEA Ring (U.S. Patent Number 8,011,239) developed under SERDP #ER-1550	7
2-2. Conceptual diagram of different exposure options possible with the SEA Ring system.....	8
2-3. Smaller organisms (e.g., polychaetes and amphipods) are delivered by pre-loaded syringes while larger organisms (e.g., clams) are placed into chambers prior to deployment.....	8
2-4. SEA Rings acquired and demonstrated during this project. The second-generation product is on the left and the third-generation product is on the right. Version 3 is commercially available from Zebra-Tech, Ltd.....	9
2-5. SEA Ring application main program window.....	10
4-1. Bremerton Naval Complex Operable Units (from Draft Final Pier 7 SMR; U.S. Navy, 2010)	28
4-2. Site map for Quantico Bay, Chopawansic Island, and the Potomac River (Battelle et al., 2007)	29
4-3. Naval Base San Diego and vicinity	30
4-4. Naval Base San Diego SEA Ring installation sites.....	31
4-5. Potential sources of contaminants to the Quantico Embayment and adjacent habitats (Battelle, 2009).....	33
4-6. Concentration of DDx in Quantico Embayment sediment. The orange line represents the boundary between the inner Quantico Embayment and the outer Quantico Embayment. The blue line represents the boundary between the outer Quantico Embayment and the Potomac River (Battelle and Neptune 2004)	34
4-7. Extent of thin layer capping (TLC) in the Quantico Embayment	35
4-8. Regional distribution of copper from the Southern California Bight '08 Monitoring Program (Schiff et al., 2011)	36

4-9. Regional Distribution of PAHs from the Southern California Bight '08 Monitoring Program (Schiff et al., 2011)	37
5-1. SEA Ring platform for conducting <i>in situ</i> toxicity and/or bioaccumulation experiments.....	41
5-2. Toxicity and bioaccumulation test organisms used in this demonstration project	41
5-3. HOBO sensor (top) and Troll [®] sensor (bottom) that can be used with the SEA Ring to measure a variety of water quality parameters inside and/or outside the exposure chambers	41
5-4. Two different approaches for field deployment of solid phase micro extraction (SPME) fibers (left and center) and commercially available Diffusive Gradients in Thin-film (DGT; right)	42
5-5. Intact sediment cores collected for flow-through (left) or static-renewal (right) ex situ bioassays, as well as sampling for sediment chemistry and benthic community analyses.....	42
5-6. Pre- and post-amendment assessment locations using the SEA Ring technology	45
5-7. Sampling locations for MCB Quantico site. The area in green represents where a thin-layer sand cap was installed in April 2014. Cap area encompasses sediment with surface sediment DDx concentrations greater than or equal to 200 µg/kg	48
5-8. SEA Ring anchor configuration to assess stormwater impacts in San Diego Bay.....	52
5-9. Embryo drums used for housing mussel embryos within exposure chambers in the SEA Ring for <i>in situ</i> exposures.....	53
5-10. Summary of reduction in concentrations of total PCBs in tissue and sediment porewater. Results are shown as mean ±95% confidence level (Kirtay et al., 2016)	62
5-11. Percentage of bent-nosed clams (<i>Macoma nasuta</i>) recovered alive at each of 10 stations over four sampling events at PSNS.....	63
5-12. Percentage of the polychaetes (<i>Nephtys caecoides</i>) recovered alive at each of 10 stations over four sampling events at PSNS.....	63
5-13. Comparison of <i>in situ</i> and laboratory-based evaluations of bioaccumulation by <i>Macoma nasuta</i> for baseline and 10-month post-remedy at PSNS Pier 7. ND = not detected. NS = no sample	64
5-14. Comparison of <i>in situ</i> and laboratory-based evaluations of bioaccumulation by <i>Nephtys caecoides</i> for baseline and 10-month post-remedy at PSNS Pier 7. ND = not detected. NS = no sample.....	65
5-15. Dissolved oxygen and temperature data from T = 34 month (2015) post-remedy deployment at PSNS inside and outside SEA Ring chambers (inside only for bottom figures).....	66
5-16. Within chamber water quality monitoring using a flow cell (left) or modification of chamber cap (center) for continuous measurements near the sediment-water interface (right)	67
5-17. Comparison of total PCB concentrations in <i>Macoma</i> (top) and <i>Nephtys</i> (bottom) with that of porewater concentrations derived from SPME. Concentrations are log transformed data from all four monitoring events	68

5-18. Comparison of total PCB concentrations in <i>Macoma</i> (top) and <i>Nephtys</i> (bottom) with that of porewater concentrations derived from SPME. Concentrations are log transformed data averaged from each of the four monitoring events.....	69
5-19. SEA Ring demonstration at MCB Quantico.....	70
5-20. Percentage of Asian clams (<i>Corbicula fluminea</i>) recovered alive at each of seven stations over the sampling events at MCB Quantico. NT = not tested for the 2012 Baseline event (QB1)	71
5-21. Mass of blackworms (<i>Lumbriculus variegatus</i>) submitted for tissue analysis from three sampling events at MCB Quantico. Blue line represents target mass required for analytical requirements. NR = none recovered. NT = not tested for the 2012 Baseline event (QB1).....	71
5-22. Comparison of 14-day bioaccumulation by <i>Lumbriculus variegatus</i> (top) and <i>Corbicula fluminea</i> (bottom) from <i>in situ</i> (top) and laboratory (bottom) exposures from replicate (n = 3) analysis of select cores from MCB Quantico 2012 baseline event. C.V. = Coefficient of variation	73
5-23. Comparison of 14-day bioaccumulation by <i>Lumbriculus variegatus</i> (top) and <i>Corbicula fluminea</i> (bottom) from laboratory and <i>in situ</i> exposures on composites of replicate sediment cores from MCB Quantico 2012 baseline event	74
5-24. Comparison of 14-day bioaccumulation by <i>Lumbriculus variegatus</i> (top) and <i>Corbicula fluminea</i> (bottom) from three SEA Ring deployments at MCB Quantico between 2012 and 2015. NS = no sample (lost).....	75
5-25. Mean (\pm S.D.) 14-day bioaccumulation by <i>Corbicula fluminea</i> and <i>Lumbriculus variegatus</i> from composite samples from three SEA Ring deployments at MCB Quantico between 2012 and 2015. Values above bars are mean sum DDX % reduction from baseline...	76
5-26. Representative photos of stormwater <i>in situ</i> deployment and recovery operations at Naval Base San Diego.....	77
5-27. Profiles of salinity, tide and precipitation as measured at CC1-T & B and OF-N-T & B. Test organisms were added to the SEA Rings between 14:30 and 17:30 on February 27, 2014, at the beginning of the x-axis on this figure.....	78
5-28. Profiles of salinity measured <i>in situ</i> during discrete grab sample times at each SEA Ring location	80
5-29. Continuous measurements of dissolved oxygen and temperature in SEA Ring chambers placed at 3-meter depth at Chollas Creek mouth (CC1-B) and adjacent to outfall OF-N	81
5-30. Results from the <i>in situ</i> SEA Ring exposures for all species tested.....	82
Figure 5-31. Individual species results for <i>in situ</i> and laboratory-based results for bivalve embryos and mysid shrimp, (Mean values \pm 95% CI).....	83
5-32. Results for <i>in situ</i> exposures for kelp (<i>Macrocystis pyrifera</i>) germination and growth (Mean values \pm 95% CI).....	84
5-33. Copper (upper) and zinc (lower) concentrations measured in DGTs inside and outside the exposure chambers, and measured as dissolved from 24-hour composite samples. Note: The outer DGT was lost for Station OF 13N-B.....	91
5-34. Comparison of DGTs deployed outside and inside SEA Rings with dissolved copper and zinc derived from composite grab samples at nine stations during storm event.....	92

6-1. DO measured within and outside an exposure chamber at Station 5 (on cap, top) and Station 7 (off cap, bottom) during the 2014 MCB Quantico deployment using Version 2 SEA Rings	94
6-2. DO measured within and outside an exposure chamber at Station 3 (on cap, top) and Station 6 (off cap, bottom) during the 2015 MCB Quantico deployment using Version 3 SEA Rings	95
6-3. Mean flow rate measured from each port (exposure chamber on a Version 2 SEA Ring. Grand mean (\pm S.D.) across all ports was 108 (\pm 4.22) ml per minute of flow	96
6-4. Mean (\pm S.D.) flow rate measured from each port (exposure chamber on a Version 3 SEA Ring. Grand mean (\pm SD) across all ports was 324 (\pm 23.8) ml per 6 seconds of flow.....	97
6-5. Mean flow rate measured from each Version 2 SEA Ring during the 14-day baseline (2012) assessment conducted at PSNS.....	98
6-6. Temperature measured inside and outside a SEA Ring exposure chamber (Station 6) during the baseline (2012) assessment at PSNS	101
6-7. Example of integration of SPME into SEA Ring chamber at PSNS&IMF	103
6-8. Examples of promising core catcher designs for capturing sediment and test organisms	104

Tables

ES-1. Quantitative and qualitative performance objectives, success criteria, and results from the demonstration	x
1-1. Demonstration sites and associated monitoring dates	3
2-1. Technology development and demonstration history	11
3-1. Performance objectives for the demonstration of the SEA Ring technology	15
5-1. Schedule of field activities for SEA Ring demonstration— <i>in situ</i> remedy assessment at PSNS.....	44
5-2. Schedule of field activities for SEA-Ring deployment at MCB Quantico	47
5-3. Test design for SEA Ring deployment at NBSD.....	50
5-4. Schedule of field activities for SEA Ring demonstration— <i>in situ</i> stormwater toxicity	51
5-5. Laboratory analyses performed for each of the four SEAP demonstrations at PSNS*	56
5-6. Laboratory analyses performed for each of three demonstrations at MCB Quantico	56
5-7. Laboratory toxicity and chemical analyses performed for the demonstration at NBSD	57
5-8. Analytical methods summary for the PSNS and MCB Quantico demonstrations	58
5-9. Analytical Methods Summary for the NBSD Demonstration	58
5-10. Control performance results from the EPA ETV comparability study for each test endpoint in control sediment and/or uncontaminated seawater	60
5-11. Mean PCB concentrations for SEA Ring and laboratory exposures from ETV testing	61
5-12. <i>In situ</i> SEA Ring toxicity test results relative to results from Reference Site OF-Far.....	84
5-13. Laboratory-based results summary for bivalve embryo development	87

5-14. Laboratory-based results summary for mysid survival.....	88
5-15. Laboratory-based results summary for neanthes survival	89
6-1. Laboratory and SEA Ring recoveries from reference locations associated with storm event at NBSD	99
7-1. Site scale and design parameters used for cost analysis	108
7-2. Cost elements for SEA Ring demonstration as a monitoring tool for <i>in situ</i> toxicity and bioaccumulation testing.....	109
7-3. Life-cycle capital cost investment and recovery estimates	110
7-4. Cost-benefit decision assessment for use of the SEAP technology.....	113
7-5. Summary of comparative costs—whole sediment toxicity assessment for a 10-site program	114
7-6. Summary of comparative costs—whole sediment toxicity assessment for a six-site program	115
7-7. Summary of comparative costs—bioaccumulation assessment for a 10-site program	116
7-8. Summary of comparative costs—bioaccumulation assessment for a six-site program.	117
7-9. Summary of comparative costs—water column toxicity assessment for a 10-site program	118
7-10. Summary of comparative costs—water column toxicity assessment for a six-site program	119
7-11. Total per sample cost comparison for the three scenarios provided above ^a	120

1. INTRODUCTION

The purpose of this project was to demonstrate, commercialize, and promote regulatory acceptance of the Sediment Ecotoxicity Assessment Ring (SEA Ring), an integrative sediment and water quality assessment tool, which was developed under the Strategic Environmental Research and Development Program (SERDP), Project #ER-1550. The SERDP project introduced a Sediment Ecosystem Assessment Protocol (SEAP), which integrates *in situ* biological uptake and effects measures with passive sampling devices and physicochemical tools to assess the sediment-water interface, surficial sediment, overlying water and advective exposure pathways at contaminated sediment sites. Minor modifications to the SEAP technology also allow for direct application to surface water exposure pathway assessment. The commercially available SEA Ring consists of a circular carousel capable of housing an array of *in situ* bioassay chambers and passive sampling devices. The SEA Ring represents an improvement over traditional laboratory-based approaches to toxicity testing, particularly with respect to scenarios where laboratory testing cannot sufficiently characterize exposure or effects. The specific technical objectives of the project were to:

1. Refine the current prototype to be more robust, user friendly and cost-effective for commercial application, and standardize test and quality control procedures;
2. Generate sufficient pertinent and high-quality data to scientifically validate the SEA Ring technology, introduce the Department of Defense (DoD) user community to the technology, and promote regulatory acceptance through rigorous demonstrations at select DoD sites located in geographically diverse settings;
3. Develop cost and performance data to support the commercialization of the technology and establish a pathway for full-scale DoD implementation.

This project leveraged with multiple other SERDP (ER-1550, ER-1749), ESTCP (ER-201131, ER-0827, ER-201368), and other DoD funded demonstration programs, including the Navy Environmental Sustainability Development to Integration (NESDI) Program (Project #459 and 460).

1.1 BACKGROUND

Existing tools for characterizing environmental effects of contaminated sediment, the effectiveness of associated remedies, and point and non-point source impacts of surface water bodies, often rely on unrealistic and disjointed independent lines of evidence for exposure, uptake, and response, potentially resulting in inaccurate sediment or water quality management decisions. This problem is particularly acute for applications where the exposure is sensitive to disturbance, dynamic, or in general cannot be easily recreated in the laboratory.

Typical examples include the following:

- In-place sediment remedies where the *in situ* interaction of the remedy with the contaminated sediment controls the exposure;
- Metal contamination in sediment which is highly sensitive to redox conditions;
- Groundwater discharge zones where the exposure is only present under field conditions;
- Underwater unexploded ordnance (UXO) where the exposure source cannot be transferred to the laboratory;
- Stormwater discharge where the exposure is ephemeral and the exposure duration is not consistent with typical static laboratory exposures.

Consequently, there is a need for implementation and acceptance of more environmentally realistic, integrated tools that provide a synoptic assessment of exposure, uptake, and response, particularly for gauging the effectiveness of emerging sediment remediation technologies and the accurate assessment of the time-varying stressors listed above. While *in situ* assessment technologies have been applied previously in a range of research and applied studies, application in regulatory programs has been limited by their perceived lack of experimental control, and the complexity of their application relative to laboratory methods. Thus, for these more realistic exposure methods to gain acceptance, there is a need to improve and standardize quality controls, and to simplify field application to a level where the methods can be carried out routinely by personnel from traditional bioassay labs.

1.2 OBJECTIVE OF THE DEMONSTRATION

The objective of this study was to demonstrate, commercialize, and promote regulatory acceptance of the integrated assessment tools developed in the SERDP Sediment Ecosystem Assessment Protocol (SEAP) project (ER-1550). Three demonstration sites were identified and included application for sediment site characterization, sediment remedy effectiveness verification, and sediment and water-related impacts from time-varying stressors, specifically stormwater runoff. Sites were selected based on applicability of the technology, site-specific characteristics and historical data, and DoD end-user interest and support. Additional criteria towards site selection were based on the desire to maximize demonstration of the technology in a range of conditions (e.g., sediment and surface water, shallow and deep water, and freshwater and marine water). The demonstration also included a laboratory-based comparative study with third-party verification under the EPA's Environmental Technology Verification (ETV) Program using representative species and field collected sediments to address some performance objectives. The demonstration program is summarized in Table 1-1 .

Table 1-1. Demonstration sites and associated monitoring dates.

Demonstration Site	Monitoring Dates
Controlled Laboratory Comparison (EPA ETV)	November 2012 to March 2013
Bremerton Naval Complex, Bremerton, WA	Baseline monitoring – August 2012 Post-remedy monitoring (10 months) – July 2013 Post-remedy monitoring (22 months) – July 2014 Post-remedy monitoring (33 months) – July 2015
Marine Corps Base Quantico, Quantico, VA	Baseline monitoring – October 2012 Post-remedy monitoring (2 months) – September 2014 Post-remedy monitoring (14 months) – August 2015
Naval Base San Diego, San Diego, CA	February 2014

The specific technical objectives of the technology demonstration were to:

1. Refine the current prototype SEA Ring to be more robust, user friendly, and cost-effective for commercial application, and standardize test and quality control procedures;
2. Generate sufficient pertinent and high-quality data to scientifically validate the SEAP technology, introduce the DoD user community to the technology, and promote regulatory acceptance through rigorous demonstrations at select DoD sites located in geographically diverse settings;
3. Develop cost and performance data to support the commercialization of the technology and establish a pathway for full-scale DoD implementation.

1.2.1 Application 1: Sediment Remedy Effectiveness

The utility of SEA Ring technology towards monitoring the effectiveness of sediment amendments at the Puget Sound Naval Shipyard (PSNS) and Marine Corps Base (MCB) Quantico was assessed by placement of SEA Rings at multiple locations within, and/or adjacent to, the location in which a remedy (a reactive amendment or thin layer cap, respectively) was applied. Bioaccumulation and porewater concentrations (derived from passive samplers) of contaminants of concern (COCs), adverse effects, and continuous water quality sensing inside exposure chambers was used in an integrated manner to assess the SEAP approach and to assess remedy effectiveness. Concurrent laboratory testing from select stations using standardized methods was used to evaluate performance objectives, on both quantitative and qualitative bases. Controls and reference stations were incorporated into the study design.

Variability within SEA Rings was compared with variability associated with laboratory testing using intact cores. At both Quantico and PSNS, performance objectives were used to make comparisons between SEA Ring and standard laboratory treatment results and between site samples and control sediments in both regimes. Two geographically relevant benthic invertebrate species were employed at both demonstration sites. The passive sampling devices (PSDs) selected for both sites were involved two different approaches using polydimethylsiloxane (PDMS) coated solid phase microextraction (SPME) fibers.

The field program for the *in situ* bioaccumulation assessments at PSNS and MCB Quantico consisted of evaluation of SEA Ring technology performance under pre-remedy (baseline) and post-remedy conditions, which are described in detail within each site's specific section.

1.2.2 Application 2: Stormwater Effects Assessment

This assessment took place during a storm event to provide a more thorough understanding of the physical and chemical dynamics, and potential impacts to biological communities in the receiving waters in San Diego Bay during wet weather. SEA Rings were deployed at multiple locations at two depths at each location during the storm event. Stations included a permitted stormwater outfall on Naval Base San Diego (NBSD), two stations within the Chollas Creek entrance to San Diego Bay adjacent to NBSD, a waterway with historical occurrences of stormwater toxicity, and two reference stations. Four marine species were placed in each SEA Ring and exposed for the duration of the storm to evaluate organisms of different sensitivity and to measure acute and chronic, sublethal endpoints.

Water quality sondes and HOBO loggers were attached to SEA Rings at all sites to measure the real-time water quality to which the organisms would be exposed, such as salinity and temperature. This action provided valuable data to determine if any effects observed were due to parameters outside the organisms' tolerance range rather than sediment or stormwater-associated contaminants. Multiple stormwater grab samples were collected at each station and submitted to the analytical lab to measure for common contaminants. Diffusive gradients in thin films (DGTs), a passive sampler for metals, were also deployed to measure concentrations of contaminants during the exposure period. Standard laboratory beaker tests were also conducted with stormwater samples for comparison of results obtained through traditional lab toxicity test methods to *in situ* studies using the SEA Ring.

1.3 REGULATORY DRIVERS

PSNS and MCB Quantico (Sediment Remedy Effectiveness). The remedies at the Puget Sound Naval Shipyard (Pier 7) and Quantico Embayment are being conducted in accordance with the Comprehensive Environmental Response, Compensation, and Liability Act (CERCLA) as amended by the Superfund Amendments and Reauthorization Act of 1986 (SARA). Implementation of the CERCLA remediation process is outlined in Title 40 of the Code of Federal Regulations (40 CFR) Part 300, National Oil and Hazardous Substance Contingency Plan (NCP). Sediment quality assessment of the specific remedy performance is required under these regulations.

Naval Base San Diego (Stormwater Effects Assessment). Current methods prescribed in a wide variety of National Pollutant Discharge Elimination System (NPDES) and Municipal Stormwater permits across the United States now require toxicity monitoring of stormwater runoff and receiving waters. The standardized whole effluent toxicity (WET) methods required have been developed for continuous point source discharges (i.e., wastewater treatment plants, etc.), which are relatively homogenous and consistent in all water quality parameters over time. Stormwater chemistry and physical parameters vary substantially over time, often exhibiting a first-flush effect, with a majority of pollutant loading occurring during the first during early runoff periods. Furthermore, runoff intensity and duration will also often vary substantially over time during any given storm event. Current laboratory toxicity tests for these pulses often require the collection of a first-flush grab sample, which is then tested for the entire duration of the test (typically ranging from 48 hours to 7 days). This methodology does not accurately characterize a realistic exposure that will occur in the environment during a storm event.

A site-specific NPDES Permit (R9-2008-0061, Order CA0109169) outlines waste discharge requirements for NBSD. This permit allows for discharge of steam condensate, pier boom, fender and mooring cleaning, utility vault and manhole dewatering, weight test water, miscellaneous discharges associated with facility maintenance, and numerous discharge locations throughout the facility, including stormwater. Under the permit, stormwater monitoring for chemistry and toxicity is

required at end of pipe locations (grab samples during the first-flush). It is anticipated that the SEA Ring demonstration at NBSD will help evaluate whether traditional end-of-pipe monitoring is truly representative of potential receiving water impacts.

In addition, Piers 2 through 7 of NBSD, an area of approximately 103 acres, were listed as a medium-priority Total Maximum Daily Load (TMDL) site for benthic community effects and sediment toxicity (SCCWRP and SPAWAR, 2005). The Total Maximum Daily Load (TMDL) Program is required under Clean Water Act (CWA) Section 303(d). CWA Section 303(d) addresses streams, lakes, and coastal waters that do not meet certain water quality standards by requiring states to identify these waters and develop TMDLs. A TMDL is a quantitative assessment of water quality problems, contributing sources, and load reductions or control actions needed to restore and protect bodies of water. The TMDL approach does not replace existing water pollution control programs but instead provides a framework for evaluating pollution control efforts and for coordination between federal, state and local efforts to meet water quality standards.

2. TECHNOLOGY

2.1 TECHNOLOGY DESCRIPTION

The SEA Ring (U.S. Patent No. 8,011,239) is an integrated, versatile, field-tested, toxicity and bioavailability assessment device. Figure 2-1 shows the patented, first-generation version of the SEA Ring technology.

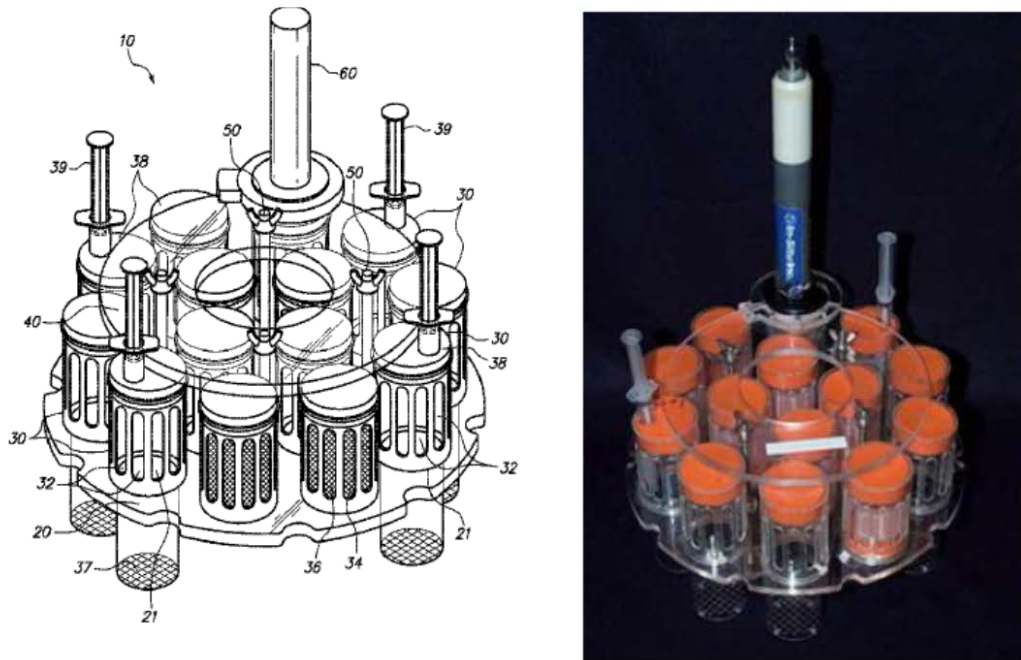

Figure 2-1. Schematic and assembled first-generation SEA Ring (U.S. Patent Number 8,011,239) developed under SERDP #ER-1550.

The SEA Ring technology is derived from an integration of existing and emerging peer-reviewed technologies developed by SERDP and other environmental research programs. An extensive literature review and laboratory assessment was conducted as part of SERDP #ER-1550 (Burton, Chadwick, Rosen, and Greenberg, 2011) to identify/optimize a range of standard test organisms and endpoints for use with the SEA Ring (Rosen et al., 2009). A subset of the tools evaluated was tested in the field to demonstrate proof of concept through field testing under Project ER-1550 (Burton et al., 2012; Rosen et al., 2012a).

The SEA Ring was designed to be extremely versatile and has been used to assess exposure and effects assessment within the water column (WC), sediment water interface (SWI), and/or surficial sediment (SED; Figure 2-2). The SED chambers are 10 to 12" in length, and extend 5 to 7" below the base of the system. Small sediment dwelling organisms can be introduced into the SED chambers *in situ* post-placement through the organism delivery port built into the cap with a modified 30-cc plastic syringe that will hold the pre-loaded test species. The syringe is capped with a silicone stopper to retain the organisms until desired release by a diver or trigger system operated from the surface. For larger organisms, a 1/2" flexible titanium wire mesh is integrated into the bottom of the exposure chamber opening, allowing organisms to be pre-loaded without the use of the syringe mechanism (Figure 2-3). The WC and SWI chambers are 5" in length and have a closed bottom (solid plastic polyethylene cap or mesh insert, respectively). Organisms for the WC and SWI tests can be loaded either in the laboratory or at the site just prior to deployment.

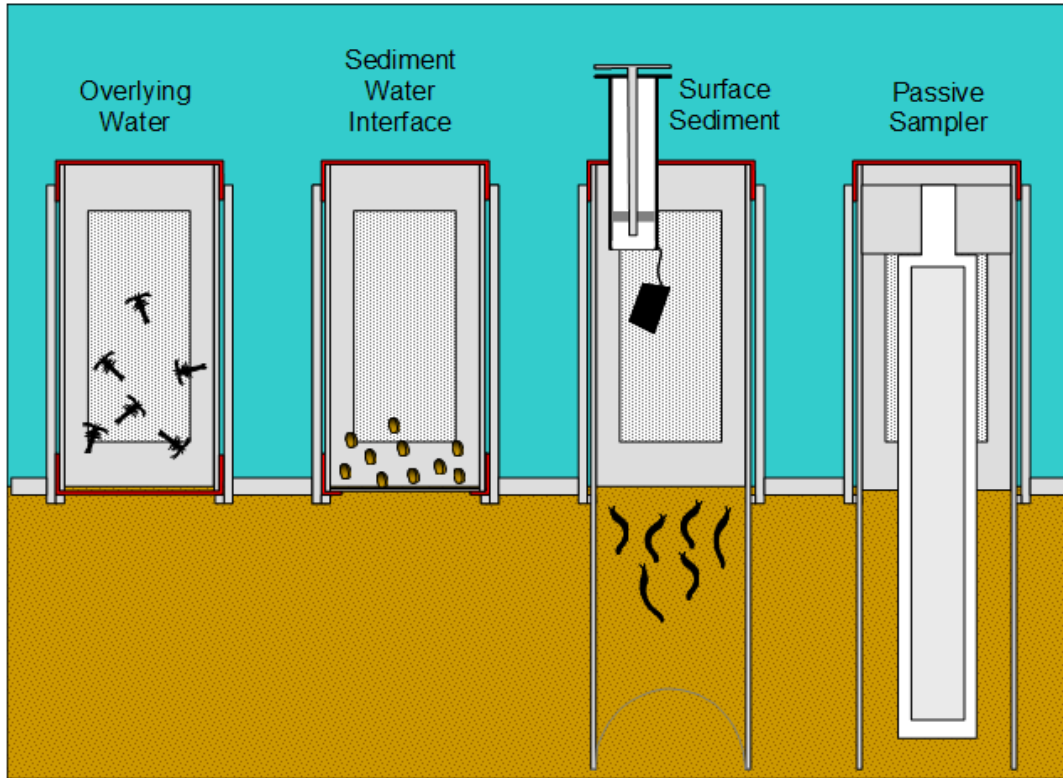

Figure 2-2. Conceptual diagram of different exposure options possible with the SEA Ring system.



Figure 2-3. Smaller organisms (e.g., polychaetes and amphipods) are delivered by pre-loaded syringes while larger organisms (e.g., clams) are placed into chambers prior to deployment.

2.2 TECHNOLOGY DEVELOPMENT

An enhanced second-generation commercial prototype (Version 2) was designed, built, delivered (Qty 12), and thoroughly evaluated in laboratory and pier-side trials at Space and Naval Warfare Systems Center Pacific (SSC Pacific) under Task 1 of this project, prior to use at the site demonstration (Figure 2-4). Following lessons learned during early deployments, a Version 3 unit

was introduced and incorporated into later deployments (Figure 2-4), and is commercially available from Zebra-Tech, Ltd (<http://www.zebra-tech.co.nz/>). The Version 2 and 3 systems were designed to be more user-friendly, more autonomous, and of commercial quality. Both versions include 10 cylindrical chambers fixed to a circular high density plastic (UHMWPE) platform. The top end of each chamber is fitted with an integrated, multifunctional cap. The cap includes both overlying water intake and outlet ports, and an organism delivery port. The intake port connects to a unique peristaltic pump that is housed in the center of the device and powered by rechargeable batteries stored in a separate housing underneath the pump (Version 2) or to a series of low-power individual centrifugal pumps (Version 3). The pumps are programmable based on specific needs (flush rate, exposure duration, etc.) using the software provided by Zebra-Tech (Figure 2-5). The Version 2 pump system delivers ambient water to individual exposure chambers at a rate of 100 mL/min of pumping, while the Version 3 system provides approximately 3000 mL/min. Assuming equal numbers of overlying water turnovers per day are targeted, the Version 3 battery life is up to 4 times longer than that of the Version 2 (including an optional external battery pack), and is demonstrably simpler to maintain.

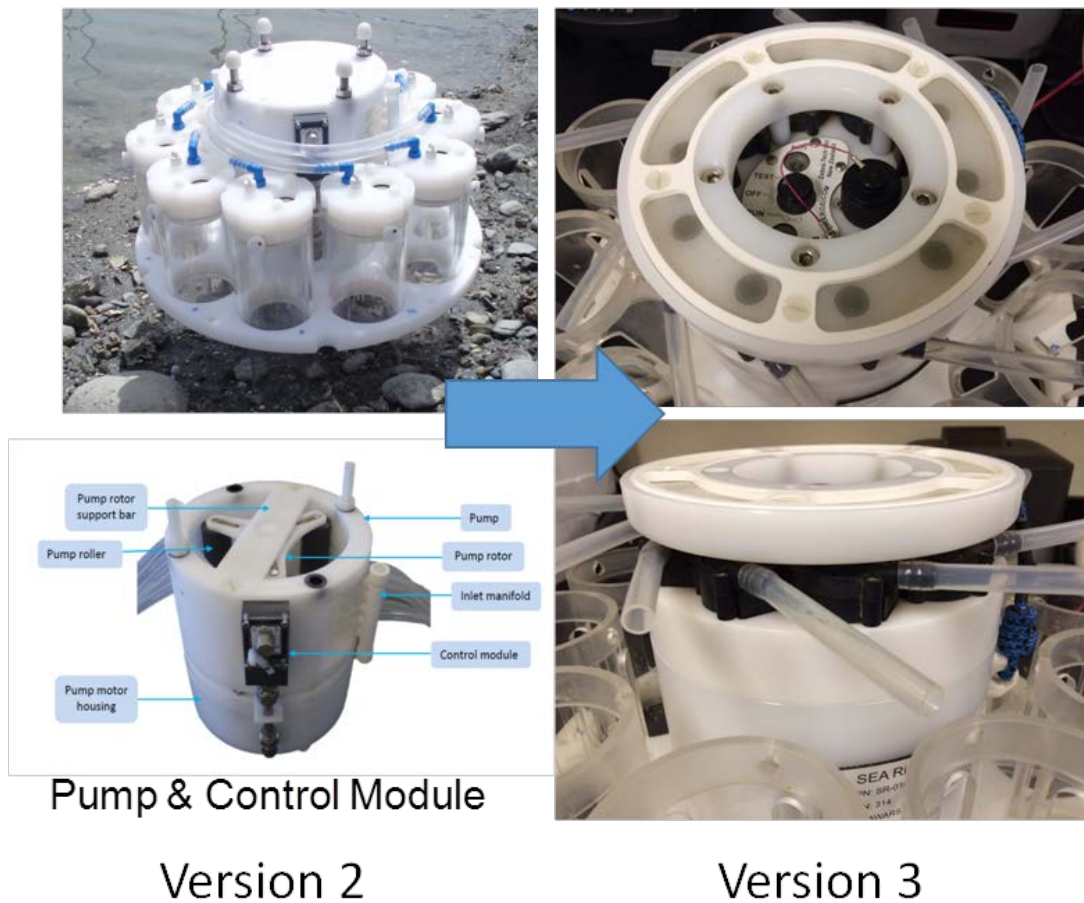

Figure 2-4. SEA Rings acquired and demonstrated during this project. The second-generation product is on the left and the third-generation product is on the right. Version 3 is commercially available from Zebra-Tech, Ltd.

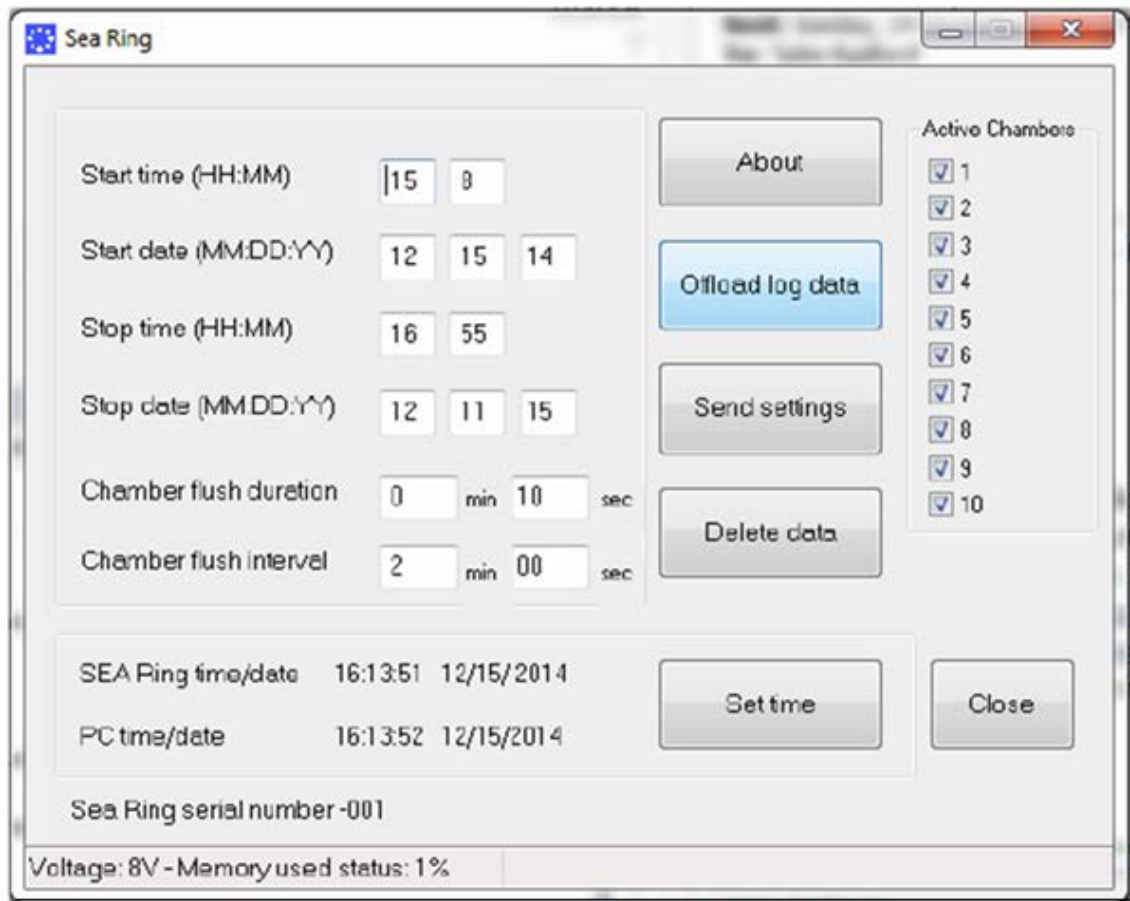

Figure 2-5. SEA Ring application main program window.

A general overview of the technology history is provided in Table 2-1. Design refinements were made based on lessons learned from field efforts conducted with the first-generation SEA Ring, and from laboratory-based testing of the Version 2 SEA Ring as part of the EPA’s Environmental Technology Verification (ETV) Program.

Table 2-1. Technology development and demonstration history.

Development Phase	Time Frame	Project(s)	References
Literature review and laboratory assessment (SERDP #ER-1550) to optimize range of standard test organisms and endpoints	2008–2009	SERDP #ER-1550	Burton et al., 2011 Burton et al., 2012 Rosen et al., 2009a Rosen et al., 2012b
Proof of concept demonstrations of Version 1 device at Naval Base San Diego, Naval Air Station Pensacola, and Chollas Creek in San Diego Bay	2007–2009	SERDP #ER-1550	Rosen et al., 2009b Burton et al., 2012 Rosen et al., 2012a,b
Demonstration of Version 1 device at Marine Corps Base Quantico to support baseline characterization	2009	ESTCP #ER-0827	Chadwick et al., 2009
Delivery and Testing of Second Generation SEA Ring (Version 2)	2011	ESTCP #ER-201130 NESDI #459	SEA Ring Operation Manual (Appendix C)
EPA ETV Testing	2012–2013	NESDI #459 ESTCP #ER-201130	McKernan, Darlington, and Dindal, 2014
Site 1 (PSNS) Demonstration	2012–2015	ESTCP #ER-201130 ESTCP #ER-201131 NESDI #459	Kirtay et al., 2016b; This report
Site 2 (Quantico) Demonstration	2012–2015	ESTCP #ER-201130 ESTCP #ER-201131 NESDI #459	This report
Site 3 (NBSD) Demonstration	2014	ESTCP #ER-201130 NESDI #459	This report; Stransky et al. (2014a)
Delivery and Demonstration of Version 3 device	2015–2016	SSC Pacific NISE, ESTCP #ER-201130	This report
Demonstration of Version 3 at Paleta Creek	2016	SERDP #ER-2428	Reible, 2016

2.3 ADVANTAGES AND LIMITATIONS OF THE TECHNOLOGY

The development, use, advantages, and disadvantages of *in situ* bioassays have been reported extensively in the peer-reviewed literature (e.g., Burton et al., 1996; Pereira, Soares, Goncalves, and Ribeiro, 2000; Sibley et al., 1999; Chappie and Burton, 2000; Geffard et al., 2001; Kater, Postma, Dubbeldam, and Prins, 2001; Anderson et al., 2004; Phillips et al., 2004; Burton et al., 2005; Crane et al., 2007; Liber et al., 2007; Rosen et al., 2009a). Our experience with the Version 3 SEA Rings largely echo the advantages and limitations in the literature, but with the added advantages as pointed out in Sections 2.3.1 and 3.2.2.

2.3.1 Advantages

- Provide greater realism by exposing test organisms to actual concentrations/conditions
- Take into account spatial and temporal variability of contaminant exposure
- Better assessment of effects from volatile or time-varying contaminants/stressors
- Integrate multiple stressors, both natural and anthropogenic
- Minimize changes in sediment by reducing sampling and manipulation
- Increase ability to interpret organism response when combined with laboratory studies
- Site-specific placing to identify toxic sources
- Minimize sample collection and shipping costs
- Sample holding time concerns are eliminated

2.3.2 Limitations

- Reduced control of natural non-treatment factors (e.g., water quality, indirect effects)
- Challenges with caging test organisms (e.g., flow restrictions, escape from chambers)
- Issues associated with feeding for some species
- Transportation and acclimation challenges during cage deployment
- Physical disturbance of test chambers
- Predation and competition
- Risk of equipment loss (e.g., weather, vandalism)

Traditional *in situ* chambers vary in shape and design based on organism type and whether the exposure will be in the water column, sediment, or both. They have historically been enclosed by a mesh screen to keep test organisms in and predatory organisms out (e.g., Burton et al., 2005). Clogging of the mesh screen can be an issue and may reduce the flow of water into the test chamber, which can degrade water quality within the chamber and prevents a true exposure to the ambient water.

The Version 2 and Version 3 SEA Rings were developed, in part, to bridge the gap between laboratory and classical *in situ* bioassays by providing enhanced control over the exposure by means of a highly standardized system that includes controlled pumping, improved water quality maintenance, continuous water quality measurements, and the ability to integrate other measures such as passive sampling, all of which can be used towards improving the characterization of exposure and effects while maximizing certainty with data interpretation.

The SEA Ring is the only autonomous *in situ* bioassay device of its kind that incorporates a pumping system to deliver water to each test chamber equally and individually. The sides of the chambers do not contain any mesh, which reduces the area that can be fouled and clogged, and also results in a smoother surface on the inside of the chamber, a safer environment for test organisms. An integrated pre-filter prevents clogging (particularly in areas with high turbidity or biofouling), yet allows for as realistic an exposure as possible.

Throughout this project, the SEA Ring technology was deployed and recovered from multiple environments with multiple species and test endpoints, and was continuously improved upon in terms of both technology improvements and lessons learned by the technical team.

3. PERFORMANCE OBJECTIVES

The overall strategy for the site demonstrations was to select applications where *in situ* methods are particularly critical to assessment of the exposure pathway, and use these applications as a means to build understanding and acceptance of the technology within the user and regulatory communities. Demonstration and verification of the SEA Ring system relative to current standard methods was conducted in the laboratory under EPA’s ETV program and at three DoD field sites.

Performance objectives for this study are divided into quantitative objectives (objectives that were measured against a standard or set criteria to demonstrate success), and qualitative objectives (objectives that require a particular quality during use of the technology or in the end result). Table 3-1 outlines the performance objectives, success criteria, and brief results for evaluating performance.

Table 3-1. Performance objectives for the demonstration of the SEA Ring technology.

Quantitative Performance Objectives				
	Performance Objective	Data Requirements	Success Criteria	Results
1	Water quality maintenance	Within chamber and ambient dissolved oxygen (D.O.), salinity, pH, temp, and/or ammonia	Table 1-1. Demonstration sites and associated monitoring dates. EA Ring chamber $\pm 50\%$ of ambient conditions	Met in most cases. Water quality met criteria in the ETV study and <i>in situ</i> demonstrations using Version 3 SEA Rings. In some cases, D.O. was reduced to $<50\%$ of ambient inside the chambers of Version 2 SEA Rings when pump units stopped pumping prior to recovery or in sediments with particularly high oxygen demand.
2	Pumping rate	Water exchange rate within all 10 exposure chambers on a SEA Ring	Volume exchange rate varies by $<50\%$ across chambers; minimum six volume turnovers per day	Met. Flow rate varied 3-9% within a SEA Ring (inclusive of both Version 2 and Version 3 pump designs). A minimum of 14 turnovers/d was achieved across all demonstrations, which increased by up to an order of magnitude (~ 140 turnovers/d) with introduction of more efficient pumps in the Version 3 unit.
3	Sediment/organism recovery	Recovery rate of sediment and/or organisms across chambers/Rings	Recover sediment and/or organisms 80% of the time (e.g., four out of five replicates)	Met. Successful recovery of organisms averaged 80-100% for six species, except for one species (<i>Nephtys caecoides</i>), which averaged 60% in the field.

Table 3-1. Performance objectives for the demonstration of the SEA Ring technology. (Continued)

Quantitative Performance Objectives				
	Performance Objective	Data Requirements	Success Criteria	Results
4	Control performance	Survival or sublethal effects data in SEA Ring and laboratory tests	No statistical difference and <25% difference between beaker and lab tested SEA Ring control samples (ETV)	Met. No statistical difference and difference between SEA Ring and lab beaker control in ETV testing ranged from 0 to 11% for five species (and six toxicity test endpoints).
5	Completion rate (completeness)	Percentage of SEA Ring chambers recovered with useful data	≥80% recovery rate of SEA Ring chambers providing useful data	Met. For site demonstrations, SEA Rings were deployed at a total of 69 stations, 66 (96%) of which provided useful data. Of the eight species used in the site demonstrations, seven provided >80% recovery rates, while the polychaete (<i>Nephtys caecoides</i>) resulted in 60% average recovery.
6	Successful identification of confounding factors	Continuous water quality measurements (DO, salinity, temperature, and pH) in select SEA Rings; NH ₃ measurements at test initiation and termination; sediment grain size.	>90% completion success for proposed water and sediment quality measurements	Met. Critical parameters were documented on a site-specific basis and used to interpret organism recoveries/toxicity in 100% of deployments and SEA Rings deployed.
7	Contaminant uptake	Concurrent assessment of laboratory beaker and SEA Ring tissue concentrations	No statistical difference and <25% difference between SEA Ring and laboratory uptake in controlled lab (ETV) exposures	Met, for two of three species used in the ETV study. Amphipod bioaccumulation was not statistically different but averaged 44% higher in the laboratory tests compared with the SEA Ring study. High variability among replicates both in lab and SEA Ring was likely associated with observed amphipod rejection of the PCB contaminated sediment during first few days of the exposures.

Table 3-1. Performance objectives for the demonstration of the SEA Ring technology. (Continued)

Quantitative Performance Objectives				
	Performance Objective	Data Requirements	Success Criteria	Results
8	Ease of operator use	Information from commercial partners and end users	Positive feedback from commercial partners/users	Met. EPA and Navy divers quickly understood operation and use of the technology. Review of diver videos and feedback indicated that deployment and recovery operations were challenging at stations with cobble, high shell hash, or other obstructions, while fine-grained sediments were easy for such efforts. AMEC and Nautilus commercial partners routinely successfully use the technology in other monitoring programs.
9	Integration of passive samplers	Inclusion of relevant passive samplers in SEA Ring deployments	Successful integration and recovery of passive samplers	Met. SPME or DGTs were successfully integrated for all events and sites, and provided added value to assessments.
10	Diverless deployment & recovery	Accurate depth and spatial placement of SEA Rings; feedback from divers on improved ease or elimination of capping of open-bottomed sediment chambers	Verification that SEA Rings remained in place where initially anchored ¹ ; positive diver feedback	Partially met. Deployment of SEA Rings was completed successfully without the use of divers for the demonstration at NBSD. For the PSNS and MCB Quantico demonstrations, divers were integrated in to the field design. Promising sediment capture devices were evaluated for different sediment types, but require further optimization for a completely diverless system.
11	Cost-benefit	Lab and SEA Ring costs and overall comparison of value between methods	Value of improved certainty of ecological risk relative to actual cost of technology	Met. Costs, outlined in the Cost Analysis section of this report, are comparable to laboratory-based testing, and we believe benefits of improved accuracy, and better management decisions, warrants implementation of this technology for various applications.

3.1 QUANTITATIVE PERFORMANCE OBJECTIVES

3.1.1 Performance Objectives #1: Water Quality Maintenance

3.1.1.1 Description

Water from the external environment is supplied to the new-generation SEA Ring exposure chambers via a unique peristaltic pump system (Version 2) or individual pump motors (Version 3) that are connected to an integrated exposure cap with inlet and outlet valves. The exposure chamber itself has no cutouts, simplifying the design from earlier prototypes, but water quality is maintained by programming the pump to exchange the overlying water at a minimum number of volumes per day, which is established on a site-specific basis. Verification of water quality maintenance is conducted through either continuous water quality sensing (e.g., datasondes) or via sampling of water from the outlet valve for discrete periodic water quality measurements.

3.1.1.2 Data Collection

In this demonstration, Troll[®] 9500 (In-Situ, Inc.) datasondes and HOBO loggers were used to measure water quality parameters including dissolved oxygen (DO), pH, salinity, and temperature. In some cases, ammonia concentration in the overlying water was also measured. Site demonstrations included water quality sensing both inside and outside the exposure chambers at a subset of stations.

3.1.1.3 Extent Success Criteria Were Met

In general, water quality inside the chambers very closely resembled site conditions, well within the goal of $\pm 50\%$ of ambient conditions. This was particularly clear for pH, salinity, and temperature. In some cases, however, DO did drop periodically during the exposure, sometimes more than 50% lower than ambient. Reasons for $>50\%$ reduction of internal DO concentration included battery depletion of SEA Ring (resulting in stopped pumping), challenges with using the flow cell designed for the Troll[®] (used in early deployments only), reliability of rental Troll[®] units, or stations with particularly high oxygen demand. The Version 3 SEA Ring seems to have eliminated concerns regarding battery discharge and water exchange, which is consistent with improved DO concentrations even in high oxygen demand sediments. An early flow cell design for housing the Troll's sonde was eliminated after early deployments due to a design flaw that led it to sometimes stagnate. The chamber cap modification for HOBO loggers is much simpler to use and allows for less expensive monitoring of water quality.

3.1.2 Performance Objective #2: Pump Flow Rate

3.1.2.1 Description

The two different pump systems on board the SEA Ring were designed to provide sufficient and uniform flow across all 10 exposure chambers to adequately expose the contents to environmental stressors and also maintain water quality at levels acceptable to the test organisms. The pump rate is programmed by the user with the accompanying SEA Ring software. A minimum of six turnovers per day exceeds the minimum for flow through laboratory bioassays.

3.1.2.2 Data Collection

SEA Rings were programmed to pump at a rate of at least six (often much more) turnovers per day, depending on site-specific requirements. Actual pump flow rate was verified by downloading the data file following recovery, which includes time and duration that the pump cycled for, the battery voltage, and the number of pump revolutions (Version 2) or current load (Version 3), which equate to a specific volume of water based on laboratory calibration studies.

3.1.2.3 Extent Success Criteria Were Met

Pump Flow Variability. Laboratory trials showed that pump flow rate met this objective, with well under 50% variability among the 10 chambers on a given SEA Ring. For the Version 2 system, average flow rate among the 10 ports ranged from 106 to 109 mL/min, varying <3%. For the Version 3 system, average flow rate among the 10 ports ranged from 310 to 340 mL/6 seconds (3.1 to 3.4 L/minute), varying <9% among chambers.

Volume Exchange Rate. For all of the deployments performed, the targeted minimum of 14 turnovers per day was achieved, exceeding the 6 turnover/d minimum criterion by greater than a factor of two. For the baseline deployments at PSNS and Quantico, 14 turnovers per day were achieved. For the PSNS 10- and 22-month post-placement monitoring events and Quantico 2-month, 58 turnovers per day were achieved by adding an external battery pack. For the 33-month post-remedy monitoring at PSNS, a combination of Version 2 and Version 3 SEA Rings were used at the site while 14-month (2015) post-remedy monitoring at Quantico incorporated Version 3 SEA Rings only. Turnover rates were estimated at 58 and 137 volumes/day for Version 2 and 3 units, respectively. For the stormwater demonstration at NBSD, up to 144 turnovers per day were achieved, using the Version 2 units over a 4-day period. At this site, pumps were programmed to pump for 50% of the exposure time, alternating between 1 minute of pumping and 1 minute of down time. This relatively aggressive pump regime was targeted to account for incorporating continuously changing conditions associated with the storm event. For future events, it is interesting to note that Version 3 units would be able to pump continuously during a 4-day exposure.

3.1.3 Performance Objective #3: Sediment/Organism Recovery

3.1.3.1 Description

A successful SEA Ring deployment depends on the ability to successfully deploy a known number of test organisms in a known volume of water or sediment, and be able to successfully recover them upon exposure termination.

3.1.3.2 Data Collection

The recovery rate of test organisms within SEA Ring chambers was assessed. For bioaccumulation tests, sufficient tissue mass to meet analytical laboratory requirements was considered sufficient, especially in cases where recovery of all organisms was impractical due to filamentous algae or other barriers for full recovery, such as with *Lumbriculus*.

3.1.3.3 Extent Success Criteria Were Met

Successful recovery of organisms or sediment within deployed exposure chambers was achieved across all field demonstrations. In some cases, individual replicates (or all replicates in rarer cases) exhibited mortality or loss of test organisms from other reasons. Because toxicity, predation, escape, or diver error/removal difficulties associated with the recovery process are potential causes for lower numbers of recovered organisms compared to deployed organisms, the height of the core was used to address this performance objective and help interpret reasons for organism loss.

PSNS. For the PSNS demonstrations (4 events), *Macoma* numbers recovered alive averaged 72% relative to number deployed, but sufficient tissue mass (as replicates within a station were composited) was recovered for tissue analysis 93% of the time (37 out of 40 stations). *Nephtys* recovery was acceptable in terms of tissue mass required for analysis for 24 out of 40 (60%) SEA Rings deployed over the four sampling events considerably less than that for the freshwater oligochaete (*Lumbriculus*) used at Quantico.

MCB Quantico. For the Quantico demonstrations, *Corbicula* met this criterion with 100% of SEA Rings deployed (20 out of 20) providing tissue to support analytical requirements. In terms of numbers of clams recovered, 92.5% of clams were recovered alive over the three events (range = 83-100%). Sufficient clam tissue for DDX analysis was available for all stations and all events (100%) where SEA Rings were deployed. *Lumbriculus* recoveries met success criteria with 19 out of 20 (95%) SEA Rings deployed over the three sampling events. The one SEA Ring that did not provide sufficient tissue mass was placed at Station 3 during the 2-month post cap placement event (QT2). Upon recovery, it was found that syringes with worms had not been depressed, so they were never released to sediment after the device was installed.

NBSD. For the NBSD demonstration, some minor toxicity was observed both for laboratory and *in situ* exposure, therefore, organism recovery comparisons were made between laboratory reference site test samples (SPAWAR Pier) and the two *in situ* reference sites (SPAWAR Pier and OF-F) for all test species. In most cases, SEA Ring recoveries were similar or better than laboratory recoveries, with the overall average recovery rate for SEA Rings for the two reference stations and four species at 92%.

3.1.4 Performance Objective #4: Control Performance

3.1.4.1 Description

In laboratory toxicity tests, test acceptability often includes some minimum requirement for test organism survival (or absence of a sublethal adverse effect) in controls in order to establish test organism health and technical proficiency with the test method (e.g., ASTM, 1999; USEPA 1995; USEPA 2002). Under normal *in situ* conditions, an appropriate control in the same sense is frequently not possible. In this project, SEA Rings will be loaded in the laboratory with laboratory dilution water and control sediment to establish test organism health, proficiency with the test method, and assurance that the SEA Ring does not have any adverse effects on the test organism batch. The laboratory SEA Ring will be tested alongside standard laboratory controls during concurrent laboratory verification testing.

3.1.4.2 Data Collection

This objective was based largely on the EPA ETV study (McKernan et al., 2014). SEA Rings were loaded in the laboratory with laboratory dilution water and control sediment to establish test organism health, proficiency with the test method, and assurance that the SEA Ring did not present any adverse effects on the test organisms. The laboratory SEA Rings were tested alongside standard laboratory controls during concurrent laboratory verification testing. Success for this performance objective was assessed by comparison of standard laboratory beaker control test results and the laboratory tested SEA Ring control samples. Sediment toxicity, water column toxicity, and bioaccumulation tests were investigated and for each test condition, the mean result in the SEA Ring was compared to that observed using traditional EPA methods using two sample t-tests, assuming unequal variances.

3.1.4.3 Extent Success Criteria Were Met

For all five species tested (and their respective endpoints), there were no significant differences (between the SEA Ring results and traditional laboratory beaker results, with both meeting standard laboratory acceptability criteria. For all test types, the percent difference met the performance objective of <25% difference.

3.1.5 Performance Objective #5: Completion Rate

3.1.5.1 Description

Completion rate refers to the percentage of SEA Ring chambers that are both recovered and provide useful data. A sediment exposure chamber that contained no sediment upon recovery or a water column exposure chamber that became dislodged during exposure or recovery are examples of scenarios that would reduce the completion rate. A criterion of successful recovery of test chambers that provide meaningful data $\geq 80\%$ of the time was targeted.

3.1.5.2 Data Collection

The total number of SEA Rings and individual exposure chambers deployed and successfully retrieved with meaningful data were enumerated. In order to ensure successful recovery, thorough data records were maintained and included: GPS location of SEA Ring at deployment, depth, length of deployment, GPS location at retrieval, and condition of pump system and test chambers at retrieval.

3.1.5.3 Extent Success Criteria Were Met

For the four PSNS demonstrations, all SEA Rings that were deployed were successfully recovered and meaningful tissue data was obtained from 37 of the total 40 SEA Rings deployed (93%). Three units stopped functioning due to battery longevity or jamming of the Version 2 pump system for unknown reasons, which prevented flow through the chambers, leading to anoxic conditions. For the three Quantico demonstrations, a total of 21 SEA Rings were deployed, of which 20 were recovered (95% recovery success). During the T=2 mo (2014) post-remedy assessment, one SEA Ring (Station 3) could not be located on recovery. However, a duplicate SEA Ring was deployed at the same station and meaningful tissue data (for *Corbicula*) was obtained from all stations targeted. For the NBSD demonstration, all SEA Rings were successfully recovered following the deployment period with meaningful data obtained from all stations for all species utilized.

3.1.6 Performance Objective #6: Identification of Confounding Factors

3.1.6.1 Description

In order to avoid false positive results for a given sample or site (i.e., identifying a sample as toxic, when in fact it is not toxic), confounding factors need to be identified and considered in the interpretation of the data. The same is true in a laboratory setting where physical parameters may affect organisms, resulting in an adverse effect falsely interpreted as toxicity. The criteria for this objective was successful measurement and interpretation of select site-relevant water or sediment quality parameters $>90\%$ of the time.

3.1.6.2 Data Requirements

The same water quality parameters that are measured for laboratory toxicity and bioaccumulation testing were measured on a subset of SEA Rings using water quality logging devices described for Performance Objective #1. Water quality sensors were fitted inside a representative exposure chamber and compared with data from sensors placed outside the system. Water quality parameters important for the assessment of potential confounding influences include: pH, DO, temperature, and conductivity/salinity. Ammonia and sediment grain size were used in some cases to help interpret data for benthic invertebrates that are potentially adversely affected past certain thresholds for these parameters.

3.1.6.3 Extent Success Criteria Were Met

Critical parameters were documented on a site-specific basis and used to interpret organism recoveries/toxicity in 100% of deployments. Organisms were strategically selected for site relevance and acclimated to site conditions (salinity, temperature) to extent practicable to avoid false positives due to physiological stress. Temperature, pH, and salinity were typically identical inside and outside exposure chambers. Salinity was important for the NBSD stormwater data interpretation as non-contaminant associated pulses of freshwater in San Diego Bay did impact some test organisms. Dissolved oxygen was sometimes reduced inside the chamber, and was a good indicator of a problem with pump performance (e.g., jam or battery issue) or a pump flow rate insufficient to keep up with high oxygen demand sediments. As discussed throughout this report, the DO concentration insufficiency was eliminated with the introduction of higher flow rates and longer deployment times possible with the Version 3 pump system. Ammonia measurement was incorporated into the ETV study, with concentrations being below effects thresholds for all test species. Similarly grain size collected at site demonstrations did not adversely impact the robust species selected for sediment bioaccumulation (as summarized in Rosen et al., 2009).

3.1.7 Performance Objective #7: Contaminant Uptake

3.1.7.1 Description

Accurate assessment of bioavailable constituents of concern (CoC) is one of the major advantages of *in situ* deployments. Because bioavailability and potential for bioaccumulation of CoC is dependent on site-specific conditions, it is inappropriate to expect concordance between laboratory-exposed organisms with *in situ* exposed organisms. However, it is appropriate to ensure that the SEA Ring technology provides the same opportunity for bioaccumulation to occur assuming comparable exposure in the laboratory and *in situ*, which was possible with the laboratory-based ETV testing, while qualitative observations were made from concurrent lab and field exposures associated with the site demonstrations.

3.1.7.2 Data Collection

Concurrent assessment of laboratory beaker and laboratory (HDPE container-housed) SEA Ring tissue concentrations for PCB contaminated samples collected from Pier 7 at PSNS were used to assess this objective using three sediment dwelling invertebrates in the ETV testing, with a criterion of no statistical difference and <25% difference between laboratory beaker and SEA Ring uptake (ETV Final Report; McKernan et al., 2014). PCB and DDX uptake were compared on a qualitative basis (no specific success criterion) for the site demonstrations.

3.1.7.3 Extent Success Criteria Were Met

This objective was met for two of three species used in the ETV study, differing by 2 and 3% for clams and polychaetes, respectively. Amphipod (*Eohaustorius estuarius*) bioaccumulation was not statistically different but averaged 44% higher in the laboratory tests compared with the SEA Ring test. High variability among replicates both in lab and SEA Ring was likely associated with amphipod rejection of the fine-grained sediment during first few days of the exposures, which is common with this species for sediments.

3.2 QUALITATIVE PERFORMANCE OBJECTIVES

3.2.1 Performance Objective #8: Ease of Operator Use

3.2.1.1 Data Collection

As part of the EPA ETV study, third party unbiased staff from Battelle were trained on and provided feedback on overall ease of use. The investigators also solicited feedback from commercial partners (Nautilus and AMEC), and the various dive teams used on site demonstrations. Success criteria included positive feedback from commercial partners, ability to consistently and easily deploy and recover SEA Rings, produce meaningful data, and ability to monitor unit (e.g., visually with video; download of pump data files) to ensure proper function throughout deployment periods.

3.2.1.2 Extent Success Criteria Were Met

Feedback was successfully obtained from Battelle staff associated with the ETV study, and upon regular interaction with the Navy (PSNS) and EPA (Quantico) dive teams and our commercial partners (AMEC, Nautilus, Zebra-Tech). The ETV report summarizes staff experience with limited training and successful operation of the SEA Rings (McKernan et al., 2014). Multiple operators were required to quickly learn how to use the device and became familiar with the technology evolution over multiple deployments over a 4+ year period. Operation of the instrumentation was straight forward. It is noted that just as with laboratory bioassays, a reasonable amount of training is required with each test organism to successfully meet test acceptability requirements for such tests, which is also true for the SEA Ring. Those most experienced with the SEA Ring development and understanding of the provided Operation Manual and SOPs had the fewest issues with its use. More details are provided in Section 6.

3.2.2 Performance Objective #9: Integration of Passive Samplers

3.2.2.1 Description

Inclusion of passive sampling devices in SEA Ring testing design to provide an additional line of evidence for assessing ecological risk.

3.2.2.2 Data Collection

Relevant passive sampling devices were included based on contaminants of concern at each of the demonstration sites. Solid-Phase Microextraction (SPME) fibers were placed inside and outside SEA Rings in the top 6" of sediment under direction of co-PIs on the leveraged project ER-201131, while Dr. Danny Reible (Texas Tech University) provided modified Henry samplers containing SPME to examine DDX concentrations over depths of 1 to 2'. Sampling methods for the SPMEs are provided in Appendix D. Diffusive Gradient in Thin Films (DGTs) were deployed inside and outside SEA Ring chambers at Naval Base San Diego to quantify labile metals in receiving water samples. Analytical methods are provided in Appendix H.

3.2.2.3 Extent Success Criteria Were Met

Successful integration, recovery, and development of meaningful data from leveraged use of passive samplers inside or adjacent to the SEA Ring were achieved. Although this performance objective is qualitative, comparisons of tissue and passive sampler data are made in relevant sections of the report. Positive correlations of SPME-derived porewater and tissue concentrations from PSNS were generally statistically significant ($\alpha=0.05$) when comparing all data obtained from the four event data set, and when comparing site mean concentrations of the four events, with better correlations observed for polychaetes versus clams. SPME data for MCB Quantico will be reported in the final report for leveraged ESTCP Project #ER-201368. DGT data at NBSD strongly correlated

with dissolved metal concentrations obtained from composite water samples collected over a 24-h period during the primary rain event.

3.2.3 Performance Objective #10: Diverless Deployment/Recovery

DESCRIPTION

The ability to deploy and recover SEA Rings with reduced (or eliminated) diver assistance can provide significant logistical and/or cost benefits. In water-column exposures where piers and other attachment structures are available, diver assistance is eliminated. Diverless deployment in sediments is relatively simple for some species, but the open bottom nature of the SEA Ring chamber design and the small size of many toxicity and bioaccumulation test organisms make this a challenge.

DATA COLLECTION

The specific locations of each SEA Ring deployment were documented with GPS, landmarks, and markings on relevant piers or bulkheads. Where appropriate (e.g., NBSD), attachment lines and marker buoys were also attached to each configuration so they were visible from the water surface. Feedback from novice and advanced divers and collaborators was instrumental in obtaining feedback regarding this objective.

3.2.3.1 Extent Success Criteria Were Met

The stormwater demonstration at NBSD was successfully conducted without diver support. Sediment deployments at PSNS and Quantico were successfully executed with diver support. Feedback and video from divers indicated that SEA Rings remained anchored in sediments, except in rare cases (e.g., where penetration of sediment was particularly difficult). Divers with little or no prior exposure to the technology were able to successfully deploy and recovery devices. Several built-in core catcher devices were developed and employed in site demonstrations. No one design, however, resulted in complete assurance that cores/test organisms would be completely recovered. Hand capping of cores by divers is the most assured mechanism until a fully autonomous core catcher is developed.

3.2.4 Performance Objective #11: Cost-Benefit

3.2.4.1 Data Collection

No comparable off-the-market technology for *in situ* toxicity testing. Instead, the approach taken here evaluates the typical cost for laboratory-based toxicity testing programs compared to *in situ* testing using a defined suite of organism types. Three hypothetical scenarios are compared using commonly used test organisms that were included in this demonstration program: (1) acute/chronic whole sediment tests using an amphipod, a bivalve or echinoderm embryo, and a polychaete worm; (2) acute/chronic water column tests using mysid shrimp, a bivalve or echinoderm embryo, and a plant (giant kelp); and (3) sediment bioaccumulation tests using a bivalve and polychaete worm. Each scenario includes associated planning efforts and labor for field collection of samples to provide a more direct comparison for a total monitoring program that might implement *in situ* testing. The cost difference for similar species within a general class or family is minimal, so all cost comparisons are performed for just the general classes of test species described above.

3.2.4.2 Extent Success Criteria Were Met

The ultimate benefit is the derivation of more realistic and accurate data from which to base subsequent management actions. The cost of potential management actions (e.g., sediment remediation and stormwater pollutant controls) will in many cases far outweigh the costs to provide data based on more representative exposures using the SEA Rings for decision-making purposes.

Significant cost-avoidance may be realized should more realistic *in situ* methods indicate no impact relative to laboratory-based tests that may show an effect under certain scenarios.

The above said, a cost analysis was performed comparing the SEAP technology with standard laboratory-based methods under the three scenarios, including a sediment bioaccumulation program at 10 stations, a sediment toxicity program at 10 stations, and a water column toxicity program at 10 stations. The cost for a survey using the SEAP technology and of the scale employed in this project is expected to be on the order of \$80,000–90,000 for a single sediment or water toxicity testing study and \$70–\$80,000 for a single sediment bioaccumulation assessment evaluation. These costs were quite comparable to independent laboratory-based approaches, differing by an estimated 7–12%, with the SEAP sometimes being less expensive than the lab estimates. A second cost comparison was conducted assuming a smaller scale program with six sampling locations. Based on a hypothetical full-scale site assessment requiring collection and testing of samples at six locations inclusive of a reference site, the cost for an *in situ* survey using the SEAP technology is expected to be on the order of \$70,000–\$75,000 for a single sediment or water toxicity testing study and \$60,000–\$65,000 for a single bioaccumulation assessment evaluation. These estimated costs for the sediment and water toxicity tests are approximately 15–20% greater using the SEAP technology, but nearly identical for an assessment of bioaccumulation.

4. SITE DESCRIPTION

4.1 SITE HISTORY AND CHARACTERISTICS

4.1.1 Puget Sound Naval Shipyard

One of the sites selected for demonstration of the SEA Ring technology is in the near-pier areas (Pier 7) of the Puget Sound Naval Ship Yard and Intermediate Maintenance Facility (PSNS&IMF), which are part of the Bremerton Naval Complex (BNC; Bremerton, WA). PSNS has six dry docks, eight piers and moorings, and numerous industrial shops to support the industrial operations. The specific location for the field demonstration was identified as the SW corner of Pier 7, located at the Shipyard's eastern end (Figure 4-1), where both PCBs and Hg (which is co-located with the PCBs) are listed as contaminants of concern.

The BNC shoreline has been greatly modified from its original condition. Historically, the area consisted of tidelands, marshes, and forests. The area was cleared and filled in several stages beginning in the late 1800s to accommodate naval operations. At present, the shoreline is composed of an industrial waterfront that is armored with quay walls and riprap, and is developed with several large overwater structures. Along the quay walls, water depth drops off more or less vertically to approximately 15 to 20 feet below mean lower low water (MLLW). In rip-rapped areas, depths at the immediate shoreline are commonly less than 5 feet MLLW, but drop off steeply beyond this depth. Recent bathymetric survey data at BNC reveal water depths generally ranging between 40 and 45 feet, except in dredged areas near piers and vessel berthing areas where depths increase to 45 to 50 feet. Offshore of the site, water depths are generally 40 to 45 feet. Depths increase to more than 50 feet in two bathymetric depressions located south of BNC in central Sinclair Inlet.

Nearshore sediments along the north shore of Sinclair Inlet and in the central inlet are dominated by silt and clay, while those along the south shore are predominantly sandy. Coarser sediments are only present in intertidal areas affected by significant wave action (e.g., Ross Point). The implications of the depositional nature of the inlet are for contaminated sediments to remain resident in the inlet for long periods. Tidal currents and winds are the primary sources of water circulation in Sinclair Inlet. Weak tidal currents move water in and out of the inlet with a maximum velocity of 0.2 to 0.3 knots. Analysis of tidal currents in 1994 indicated residual current speeds of less than 0.2 knots (10 cm/s) for more than 90 percent of the time, regardless of site location, water depth, or season. Residual current speeds higher than 0.2 knots were rare, and speeds higher than 0.4 knots occurred less than 0.5 percent of the time. Surface currents generally flow out of the inlet, although surface current flow into the inlet has been observed during summer months. Near-bottom currents primarily flow into the inlet, regardless of season. Currents are generally not capable of resuspending bottom sediments.

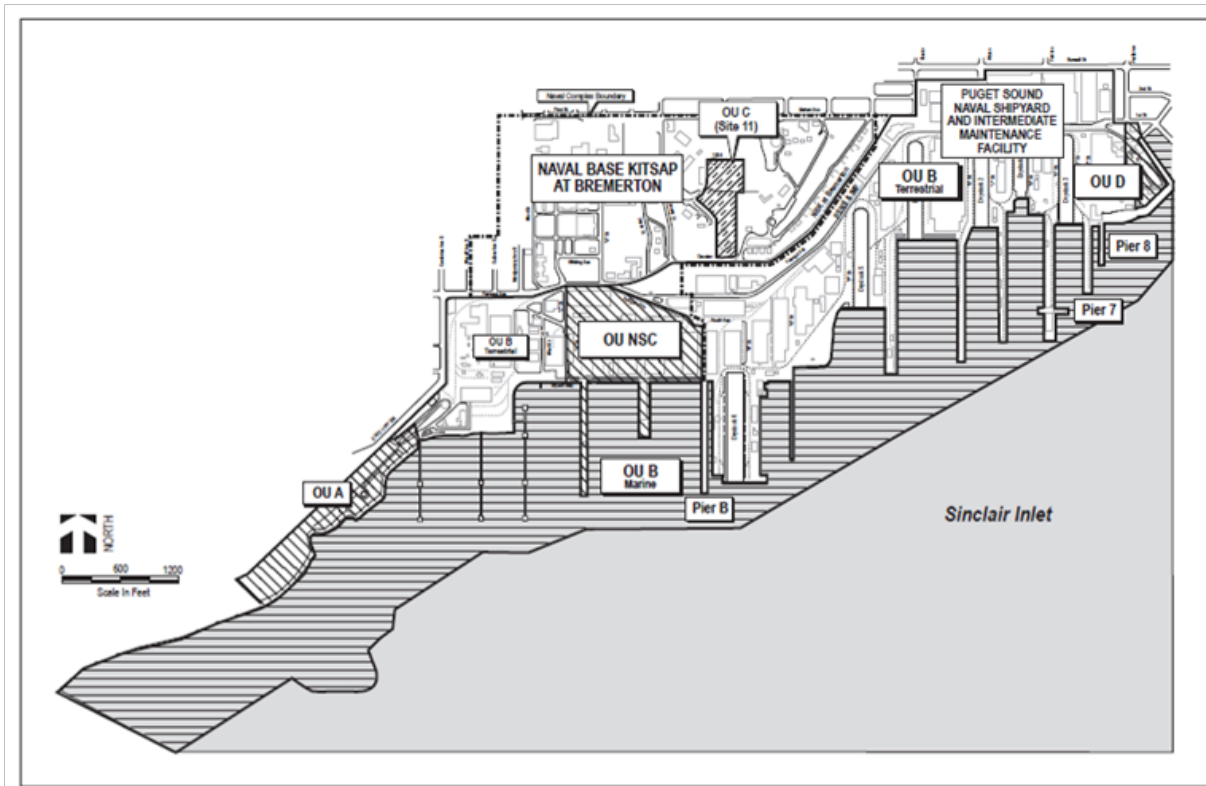

Figure 4-1. Bremerton Naval Complex Operable Units (from *Draft Final Pier 7 SMR*; U.S. Navy, 2010).

4.1.2 Marine Corps Base Quantico

Quantico Embayment is a semi-circular inlet of the Potomac River (Figure 4-2). Its surface area is approximately 190 acres. Within the southern half of the bay, and approximately 500 feet from the shoreline, is a 12-acre private island called Chopawamsic Island (12 acres). A broad shelf between 3 to 5 feet deep is located northeast of the island, and a historical river channel left a small depression approximately 16 to 20 feet deep west of the island. In general, the water depths of the bay range from tidal level along the shoreline to 5 to 6 feet where the bay meets the Potomac River.

This location is defined predominantly as a freshwater system, with minimal tidal influence (between 0.3 to 0.7-meter tidal range). Surface water salinity at this site ranges from between 0.5 practical salinity units (psu) to 3 psu, with the higher salinity occurring during lower river flow conditions in the late summer and early fall. Sediment is typically fine-grained, with greater than 55 percent (%) silt and clay (Battelle and Neptune and Company, 2004). More coarse-grained sediment is located along the shoreline and adjacent to outfalls, and finer-grained sediment (with greater than 80% silt and clay) is located in outer areas of the embayment (Battelle, Otten, and Neptune and Company, 2007). Based on the grain size distribution and evidence of low flow velocities within the embayment, it is assumed that this site is depositional in nature.

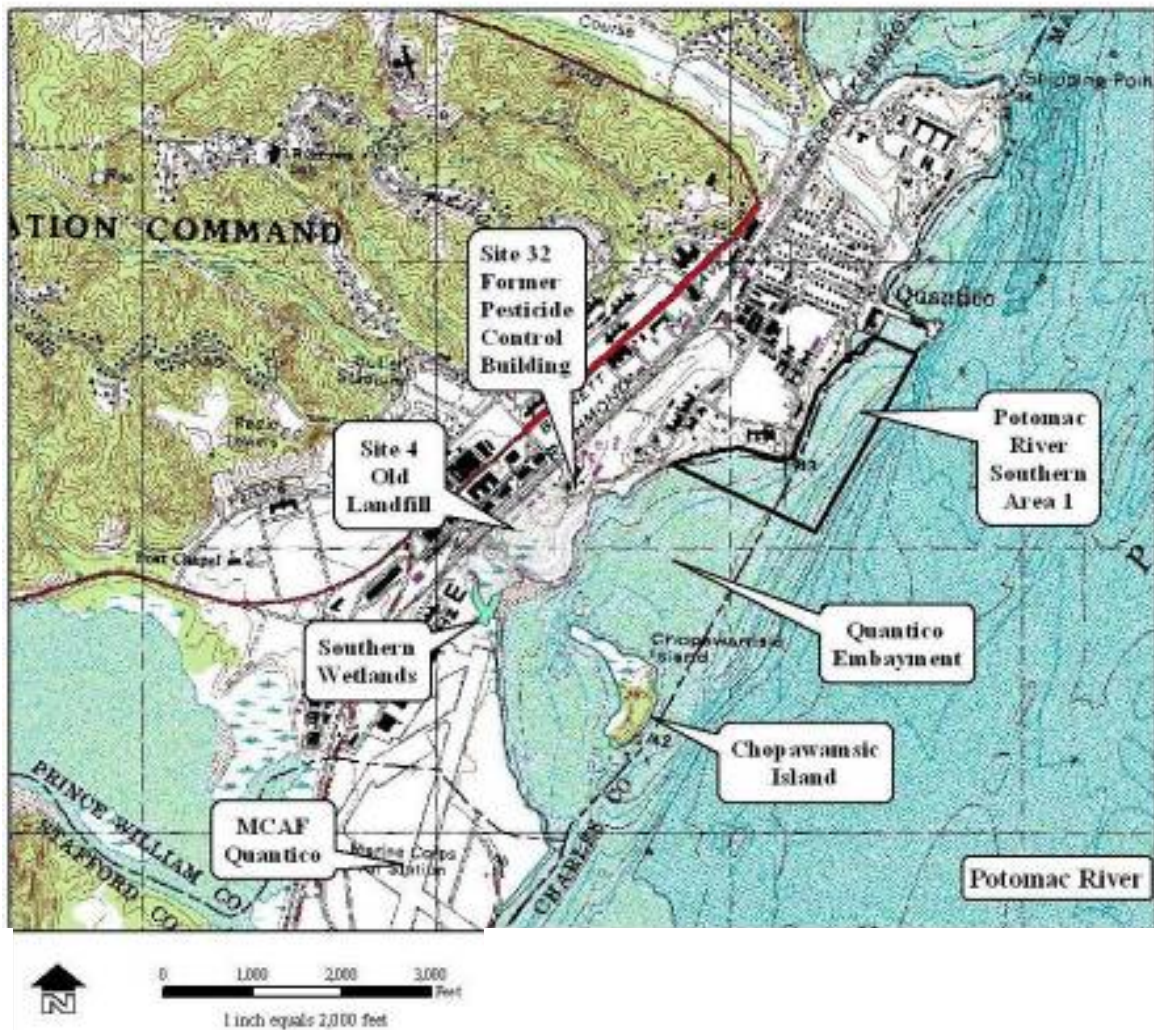

Figure 4-2. Site map for Quantico Bay, Chopawamsic Island, and the Potomac River (Battelle et al., 2007).

4.1.3 Naval Base San Diego

Naval Base San Diego (NBSD, Figure 4-3, Figure 4-4) was selected as the site to assess the time-varying stressor of contaminated stormwater discharge to a receiving environment. Toxicity and chemistry of wet weather runoff have been routinely measured in outfalls and receiving water off NBSD for compliance with NPDES storm water discharge permits. Copper and zinc frequently exceed benchmark concentrations for the protection of aquatic life in stormwater samples from NBSD and have been found to cause acute toxicity to the mysid shrimp *Americamysis bahia* in end-of-pipe stormwater samples using Toxicity Identification Evaluation (TIE) procedures (Katz, Rosen, and Arias, 2006).

Therefore, as part of the SEA Ring demonstration, one of the stormwater discharges at NBSD that is regularly monitored was included as part of the site selection. Additional SEA Rings were placed in Chollas Creek, which is directly adjacent to NBSD and flows through Navy property. Chollas

Creek drains from a highly urbanized watershed to San Diego Bay and has a history of stormwater toxicity. The placement of SEA Rings at multiple sites with possible varying degrees of contamination, along with concurrent laboratory tests, was important to demonstrate whether the organisms exposed to a sample in the SEA Ring have the potential to exhibit effects similar to those exposed to the same site water in the laboratory.

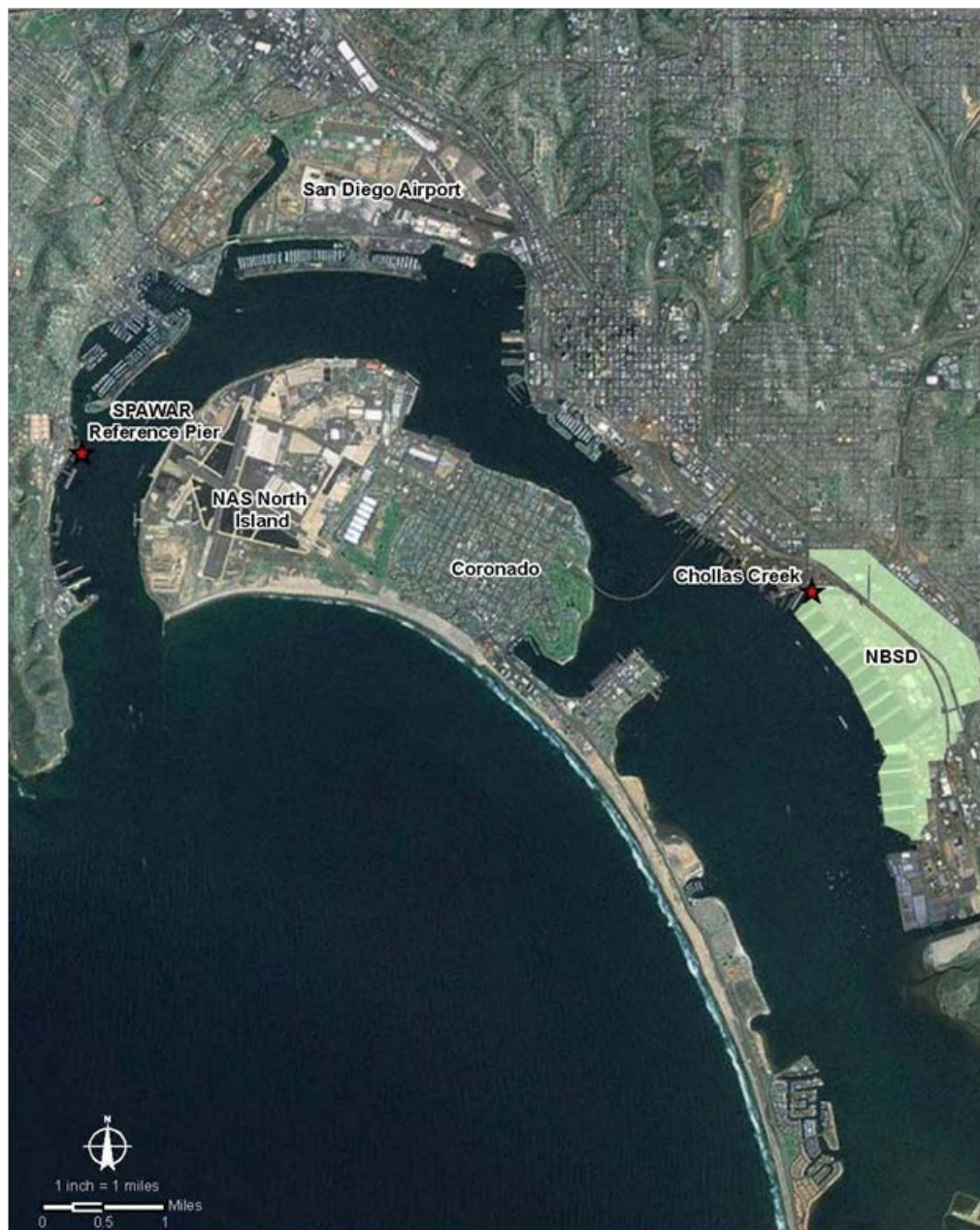
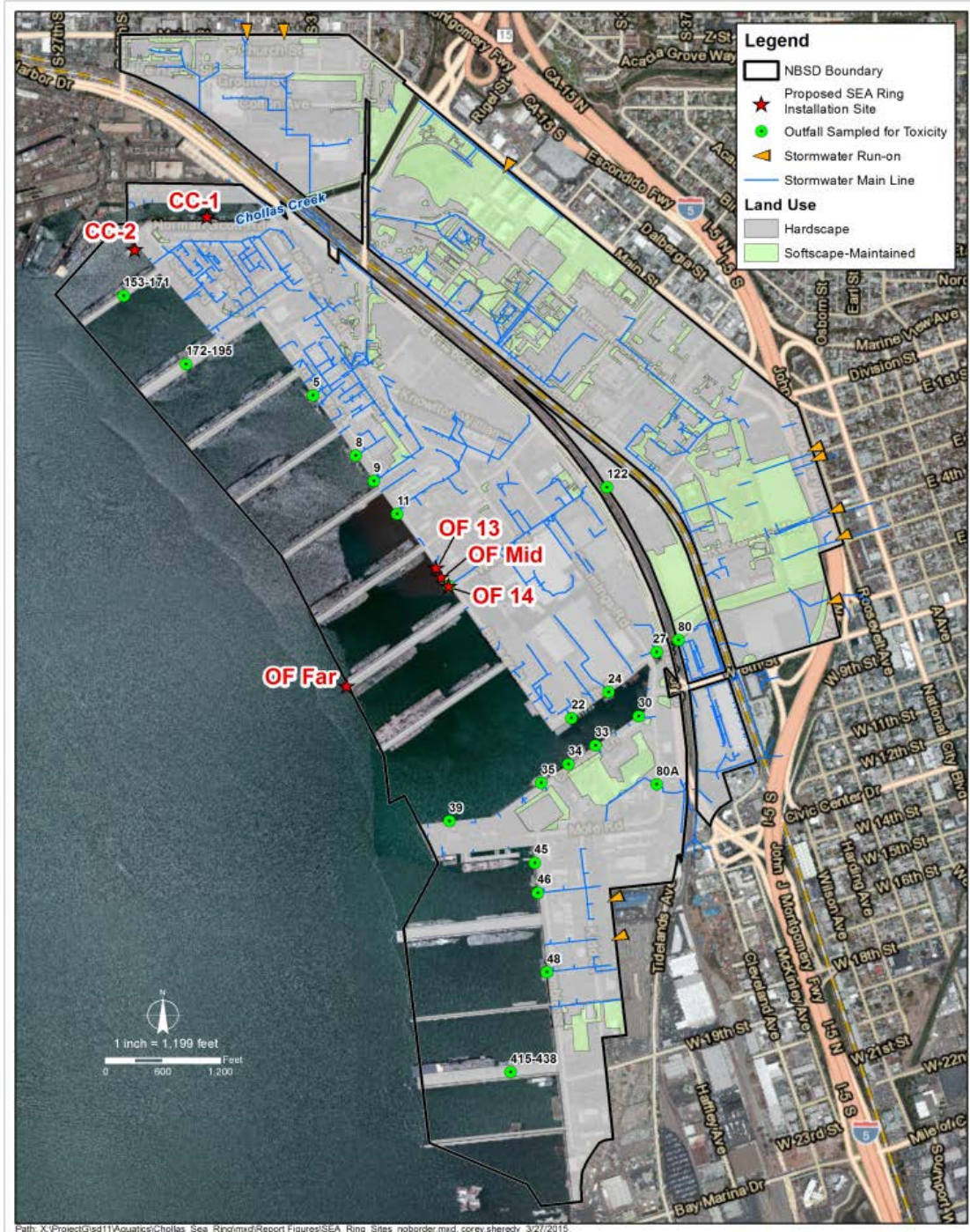

Figure 4-3. Naval Base San Diego and vicinity.

Portions of this document include intellectual property of Esri and its licensors and are used under license. Copyright © (March 2, 2012) Esri and its licensors. All rights reserved.



CC = Chollas Creek, OF = Outfall. SSC Pacific Reference Site not shown.

Figure 4-4. Naval Base San Diego SEA Ring installation sites.

Portions of this document include intellectual property of Esri and its licensors and are used under license. Copyright © (March 2, 2012) Esri and its licensors. All rights reserved.

4.2 CONTAMINANT DISTRIBUTION

4.2.1 Puget Sound Naval Shipyard

Pier 7 lies within an area known as Operable Unit B Marine (OUB Marine) that was previously subject to a Superfund sediment cleanup. The primary components of the remedial action included dredging, disposal in a pit excavated in the sea floor in Sinclair Inlet, capping of contaminated sediments in a small area at the southwest end of the naval complex and placement of a thin layer of clean sediment to promote recovery of sediments (enhanced natural recovery) in the area around the cap, stabilization of a section of shoreline in the center of the naval complex, and allowing for the ongoing processes of sediment natural recovery to continue to decrease the residual contamination throughout the area over a period of 10 years (U.S. Navy, 2008).

The areas within Operable Unit B Marine found to have the highest PCB levels were identified for dredging. The highest levels of PCBs were found mostly in areas along the shoreline or adjacent to the moorings and piers (e.g., Pier 7) of the BNC. A limited amount of additional dredging was included in the remedial action based on a combination of elevated mercury levels and moderately-elevated levels of PCBs. A more comprehensive description of the site is provided in Kirtay et al. (2016b).

4.2.2 Marine Corps Base Quantico

The Quantico Embayment and adjacent habitats, including the Southern Wetlands, have historically received numerous potential contaminants from several sources. These sources include the Site 4 Old Landfill, the Former Pesticide Control Building, the Mainside Sewage Treatment Plant (STP), and the active Marine Corps Air Facility (MCAF) Quantico (Figure 4-5).

In addition, a number of historical and current stormwater outfalls had or have discharge points draining to the Quantico Embayment (Figure 4-5). Prior to the separation of the storm and sanitary sewer systems at MCB Quantico, these outfalls may have been a source of chemical constituents to the embayment from various operations (e.g., maintenance facilities, floor drains, and wash racks). Six outfalls are currently regulated under NPDES permits, and drain directly into the Southern Wetlands and/or Quantico Embayment. Of these six outfalls, two outfalls discharge non-contact cooling water and steam condensate, and one discharges steam condensate only. NPDES permitted outfalls within MCB are not expected to be a significant current source of potential contamination; non-NPDES permitted outfalls are also not expected to be continuing sources of potential contamination as they only drain storm runoff from buildings and parking lots (Battelle, 2009). Present chemical inputs to Quantico Embayment from Potomac River sources are considered minimal (Battelle and Neptune, 2004).

Although CoCs at this site included PAHs, metals, chlorinated pesticides, and PCBs in both surface (0 to 10 cm) and subsurface (greater than 10 cm) sediment, the presence and concentration of DDx compounds drive the requirement for site remedy. DDx compounds, consisting of DDT and its degradation products DDD and DDE, have generally been measured at the highest concentration levels in the northern portion of the inner portion of the Quantico Embayment adjacent to the northern edge of the Site 4 Old Landfill and adjacent to the potential runoff stream from the Former Pesticide Control Building (Figure 4-6). Sediment sampling suggests that DDx concentrations both increase with depth in the sediment and are generally highest in the near-shore area (Figure 4-6), hence the placement of the thin layer cap (Figure 4-7).

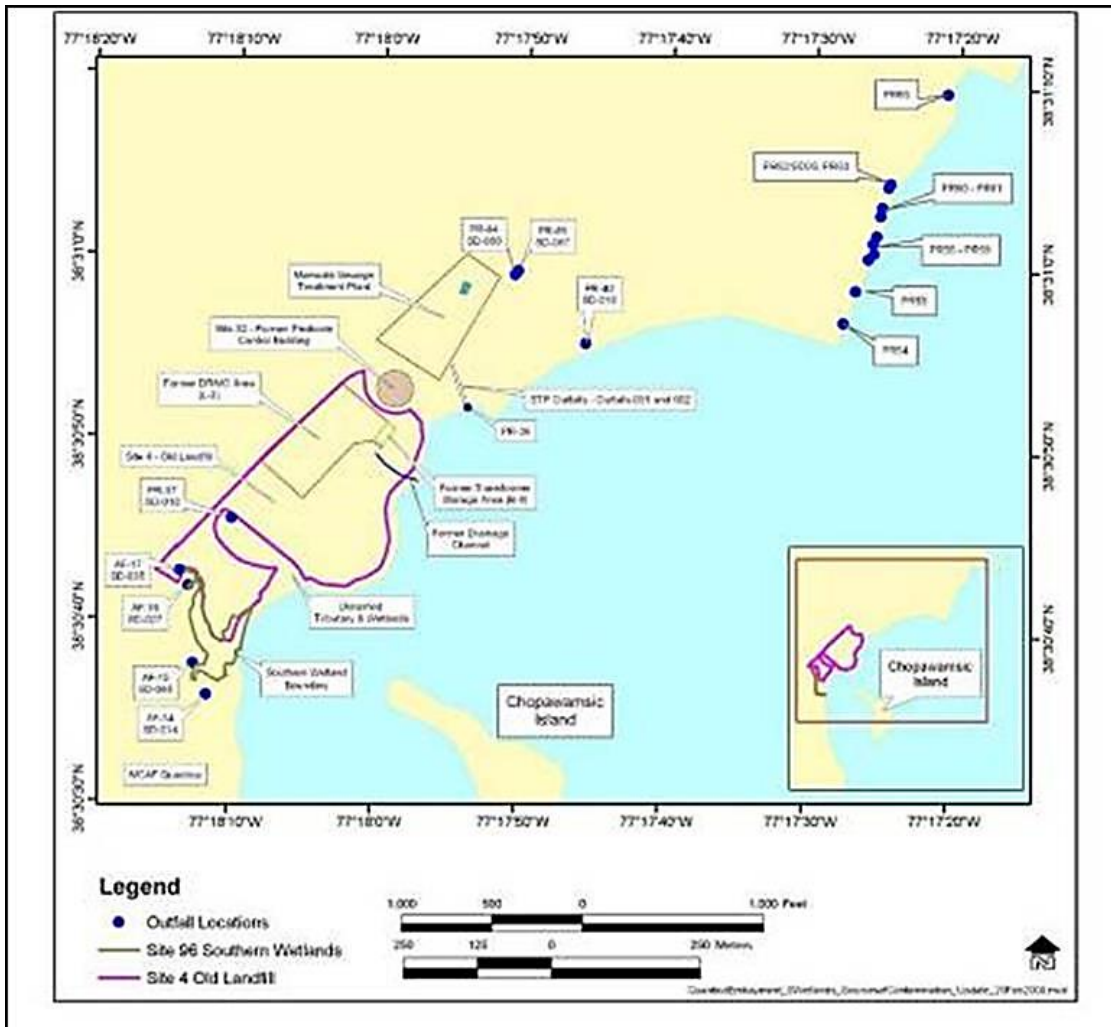

Figure 4-5. Potential sources of contaminants to the Quantico Embayment and adjacent habitats (Battelle, 2009).

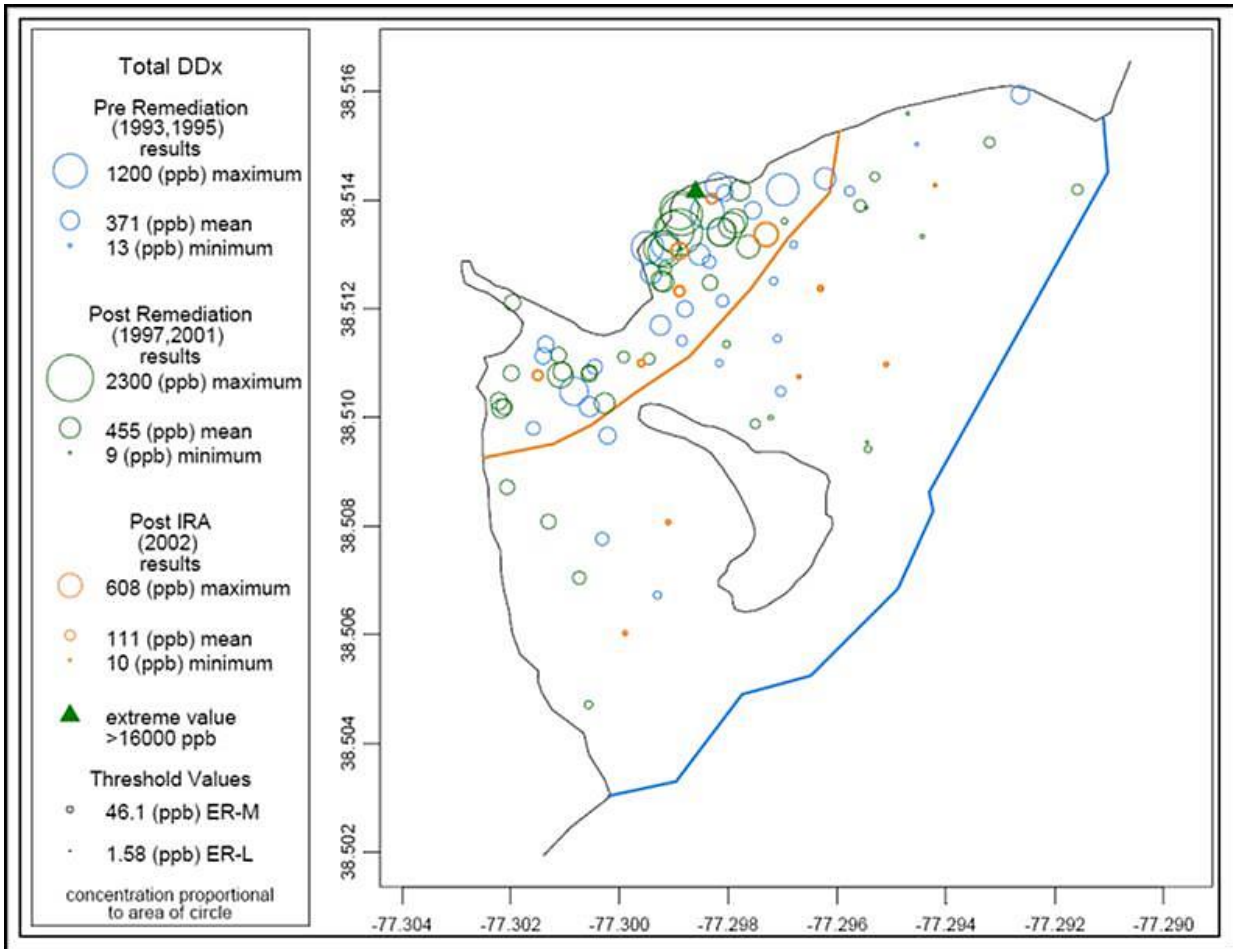

Figure 4-6. Concentration of DDX in Quantico Embayment sediment. The orange line represents the boundary between the inner Quantico Embayment and the outer Quantico Embayment. The blue line represents the boundary between the outer Quantico Embayment and the Potomac River (Battelle and Neptune 2004).



Figure 4-7. Extent of thin layer capping (TLC) in the Quantico Embayment.

4.2.3 Naval Base San Diego

Many areas of San Diego Bay's shoreline have been listed as impaired water bodies under Clean Water Act (CWA) §303[d] by the State Water Resources Control Board (SWRCB) due to identified pollutants. The most recent list was approved by the USEPA in June 2007. Pollutants include bacteria, pesticides, heavy metals, and organic compounds while areas of concern continue to be marinas, shipyards, and outlets of creeks. As a result of these listings, the Regional and State Water Boards are required to prepare a TMDL technical report and action plan for each site and pollutant. Five sites were considered to be "toxic hot spots" in San Diego Bay due to multiple pollutants and toxic effects that require immediate clean-up (Seventh St. Channel, Paleta Creek, Naval Station San Diego, B Street/Broadway Piers, and the Downtown Anchorage). The area near Chollas Creek has been classified as a moderate priority site for cleanup.

Chemical contaminants that are currently of primary concern in San Diego Bay include various heavy metals and organic (chlorinated pesticides and petroleum hydrocarbon) pollutants. A recent regional monitoring program by SCCWRP (Bight '08) also identified pyrethroids and, to a lesser extent, polybrominated diethyl ethers (PBDEs) in sediments from San Diego Bay at locations near major urban runoff inputs (Chollas Creek and the Sweetwater River) (Schiff et al., 2011). Better information for the bay is becoming available through more advanced and frequent monitoring programs such as the Regional Harbor Monitoring Program (RHMP), National Pollutant Discharge Elimination System (NPDES) permit monitoring by 22 dischargers (including Navy, port, county, cities), and the regional Bight Monitoring Program by SCCWRP in 1994, 1998, 2003, 2008, and 2013.

As in previous surveys, San Diego Bay's marinas, ports, and harbors had the highest concentrations of pollutants relative to other locations within the bay (Schiff et al., 2011; Figure 4-8, Figure 4-9). Heavy metals of concern in the bay are primarily copper, lead, mercury, and zinc. Current primary identified sources of copper in the bay are related to passive leaching from anti-fouling paints used on boat hulls (Schiff, Bay, Diehl, 2001), as well as stormwater runoff (Schiff, Bay). One compound, tributyltin (TBT), was formerly a serious problem in the bay's marinas but levels have decreased significantly after this component of anti-fouling paints was phased out for recreational, commercial, and navy vessels,

Organic contaminants consistently identified as constituents of concern at numerous locations throughout San Diego Bay include PAHs (polynuclear aromatic hydrocarbons) and PCBs (polychlorinated biphenyls) (Woodward-Clyde 1996, Schiff et al., 2011, Figure 4-9). Earlier studies evaluated the sources of PAH contaminant for San Diego Bay: the leaching of creosote from pier pilings in the bay (61%), followed by in-place sediments introduced to the water column, mainly through dissolved molecules (27%) (Woodward-Clyde 1996). Urban stormwater also contains PAHs, which were found to be predominantly derived from aerial deposition and subsequent wash-off of PAHs associated with combustion by-products in the Los Angeles region. Arid regions like Los Angeles and San Diego, can deliver high concentrations where high daily traffic is combined with intense rainfall and high surface runoff from impervious surfaces. The 2003 and 2008 Bight Surveys found elevated concentrations of total PAHs at several sites in the bay.

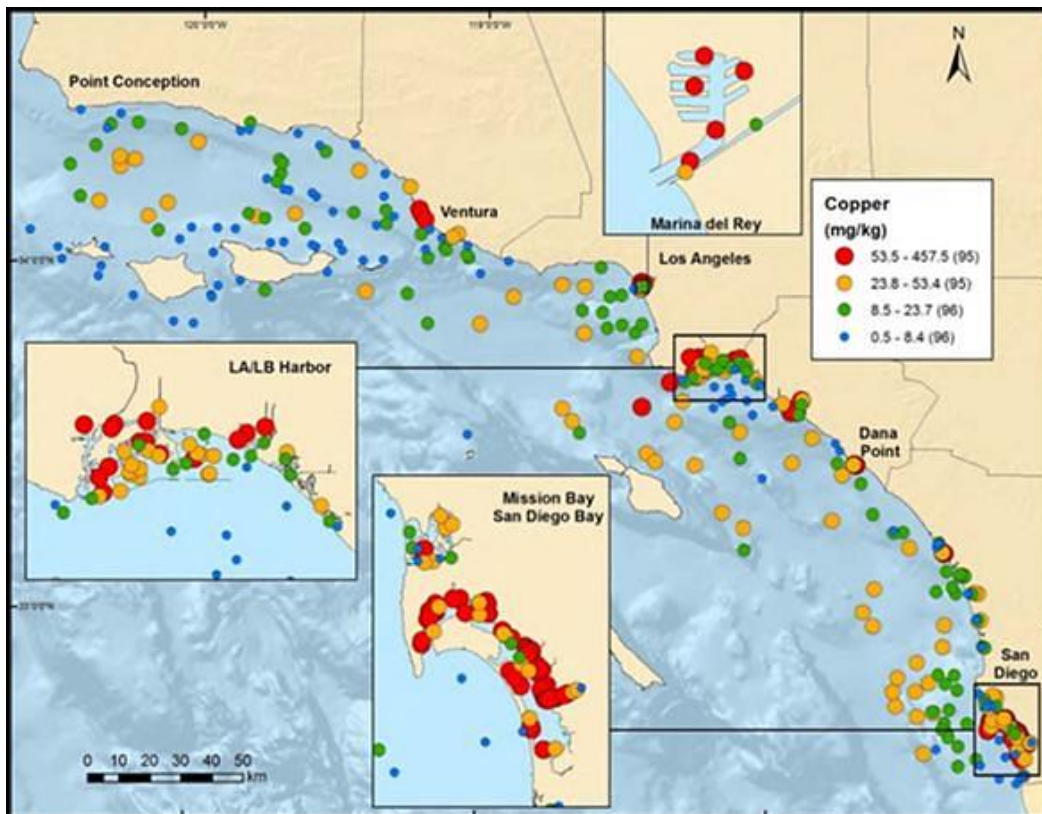

Figure 4-8. Regional distribution of copper from the Southern California Bight '08 Monitoring Program (Schiff et al., 2011).

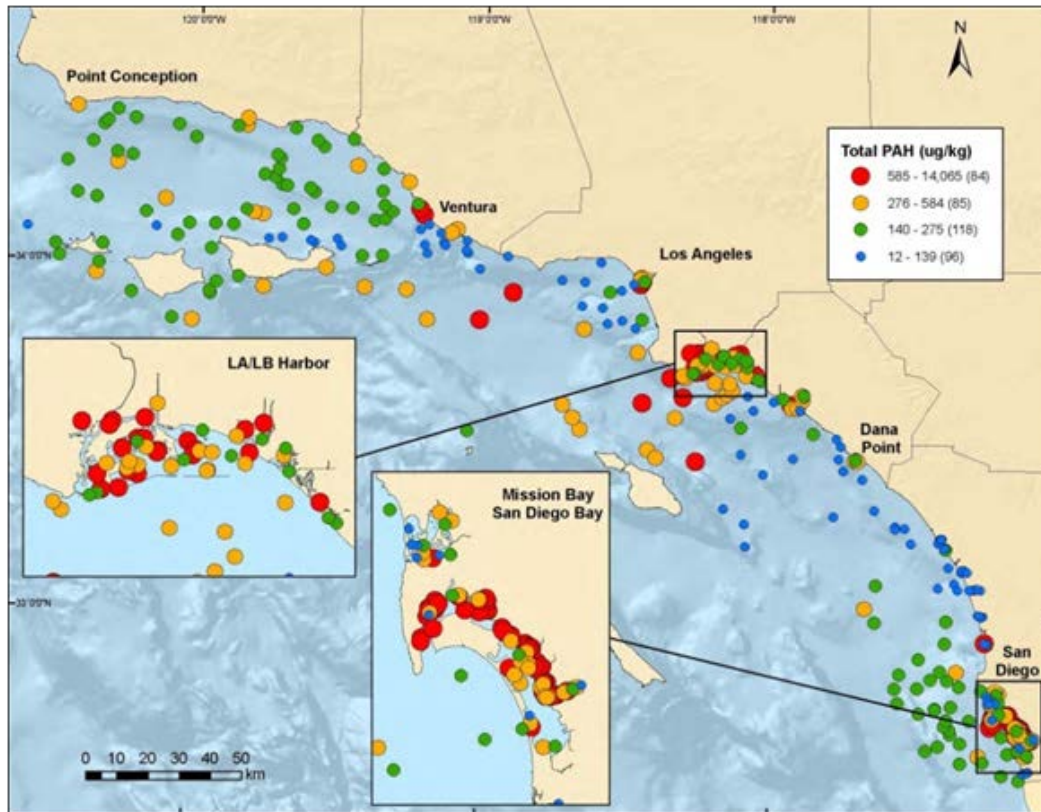

Figure 4-9. Regional Distribution of PAHs from the Southern California Bight '08 Monitoring Program (Schiff et al., 2011).

5. TEST DESIGN

This section provides the detailed description of the experimental design, sampling, and analytical methods used to evaluate the performance of the SEA Ring technology for three different sites, applications, and types of environments.

5.1 CONCEPTUAL EXPERIMENTAL DESIGN

The experimental design was established to evaluate the performance objectives for the SEA Ring technology for a range of applications and field conditions, including fresh and saltwater environments, differing contaminants of concern, and varying sediment or water physico-chemical characteristics. A controlled laboratory-based technology verification (ETV), including concurrent SEA Ring and standard laboratory bioassays was conducted in addition to demonstrations at the three sites.

5.2 BASELINE CHARACTERIZATION

The purpose of this technology demonstration was to demonstrate an integrative *in situ*-based approach that centers on a field-deployed technology. Although it did involve both baseline and post-remedy components associated with the two sediment demonstration sites, the comparison of performance of the associated remedies at these sites (PSNS and MCB Quantico) is provided in the final technical reports associated with those projects (ER-201131 and ER-201368, respectively). As baseline and post-remedy characterization activities involved essentially the same approaches and level of effort, their results are presented together in Sections 5.7.2 and 5.7.3 of this report.

5.3 ENVIRONMENTAL TECHNOLOGY VERIFICATION (ETV) STUDY

The U.S. Environmental Protection Agency (EPA) Environmental Technology Verification (ETV) Program's Advanced Monitoring System (AMS) conducts third-party performance testing of commercially available technologies that detect or monitor natural species or contaminants in air, water, soil, and sediment. The purpose of ETV is to provide objective and quality-assured performance data on environmental technologies so users, developers, regulators, and consultants can make informed decisions about purchasing and applying these technologies. This laboratory-based verification was leveraged with NESDI Project #459. A summary of important elements of the study are included in this report (Section 5.7.1), as they directly address some of the performance objectives associated with this technology demonstration. Additional details can be obtained from the final report (McKernan et al., 2014; https://archive.epa.gov/nrmrl/archive-etv/web/pdf/sea_ring_etv_final_report_23dec13.pdf; https://archive.epa.gov/nrmrl/archive-etv/web/pdf/sea-ring-verification-statement_signed.pdf).

The purpose of the study was to generate performance data on the SEA Ring for assessing sediment and water column toxicity and bioaccumulation potential relative to widely accepted standard laboratory methods. All testing was conducted at the Space and Naval Warfare Systems Center (SSC Pacific) Bioassay Laboratory, with Battelle and AMEC Environment and Infrastructure (AMEC) conducting the technical systems audit and quality assurance (QA) oversight. The performance of the SEA Ring compared to EPA and ASTM laboratory methods was evaluated utilizing two water-column species: Pacific topsmelt (*Atherinops affinis*) and mysid shrimp (*Americamysis bahia*) for aqueous toxicity testing, and three sediment-dwelling species, the bent-nosed clam (*Macoma nasuta*), marine amphipod (*Eohaustorius estuarius*), and marine polychaete (*Neanthes arenaceodentata*) for sediment toxicity and bioaccumulation testing. Four sediment types (two control sediments, a metals contaminated sediment [MS] and a polychlorinated biphenyl [PCB] contaminated sediment from Pier 7 at Puget Sound Naval Shipyard [PSNS]), and four copper

concentrations (0, 100, 200, and 400 µg/L) were used for the sediment and water toxicity tests, respectively. The primary evaluation assessed survival, growth, and bioaccumulation of contaminants in the aquatic and benthic organisms exposed in the SEA Ring compared to responses achieved in the laboratory using standard ASTM and EPA methods. In performing the verification test, SSC Pacific and Battelle followed the technical and QA procedures specified in a SEA Ring Verification Quality Assurance Project Plan (QAPP, 2012; Battelle, 2012), and also complied with the data quality requirements in the AMS Center Quality Management Plan (QMP, 2001; Battelle, 2011).

The SEA Ring tests were evaluated on the following performance parameters:

- Repeatability - the variability in biological response among the five replicate exposure chambers in a SEA Ring;
- Comparability - comparison between results obtained from tests in the SEA Ring and traditional EPA and ASTM laboratory methods;
- Intra-unit Reproducibility - to determine if different SEA Rings are capable of producing the same results;
- Operational factors (qualitative assessment) - includes ease of use, training, and sustainability (sampling time, waste produced, and the amount of protective equipment required by the individual operating the technology).

5.4 DESIGNS AND LAYOUT OF TECHNOLOGY COMPONENTS

Technology components included physical, chemical, and biological devices/characterization for each of the three site demonstrations. Technology components differed to some extent, depending on site-specific objective and leveraging with related projects, but in general included the following:

1. SEA Ring platform and exposure chambers for in situ toxicity and/or bioaccumulation experiments (Figure 5-1 and Figure 5-2);
2. Attachment of water quality sondes such as the Troll[®] 9500 (In-Situ, Inc.) or Hobo Loggers (Onset) for continuous water quality sensing inside and outside exposure chambers for data quality and interpretation (Figure 5-3);
3. Incorporation of passive sampling devices (PSDs), both inside and outside SEA Ring chambers, as an additional indicator of bioavailability of CoCs in surface water and/or sediment porewater (Figure 5-4);
4. Water grab sampling and/or sediment core sampling for concurrent laboratory toxicity and or bioaccumulation testing and relevant chemical analyses to complement interpretation of in situ results and/or use as a measure of technology performance (Figure 5-5).



Figure 5-1. SEA Ring platform for conducting *in situ* toxicity and/or bioaccumulation experiments.



Figure 5-2. Toxicity and bioaccumulation test organisms used in this demonstration project.



Figure 5-3. HOB0 sensor (top) and Troll[®] sensor (bottom) that can be used with the SEA Ring to measure a variety of water quality parameters inside and/or outside the exposure chambers.

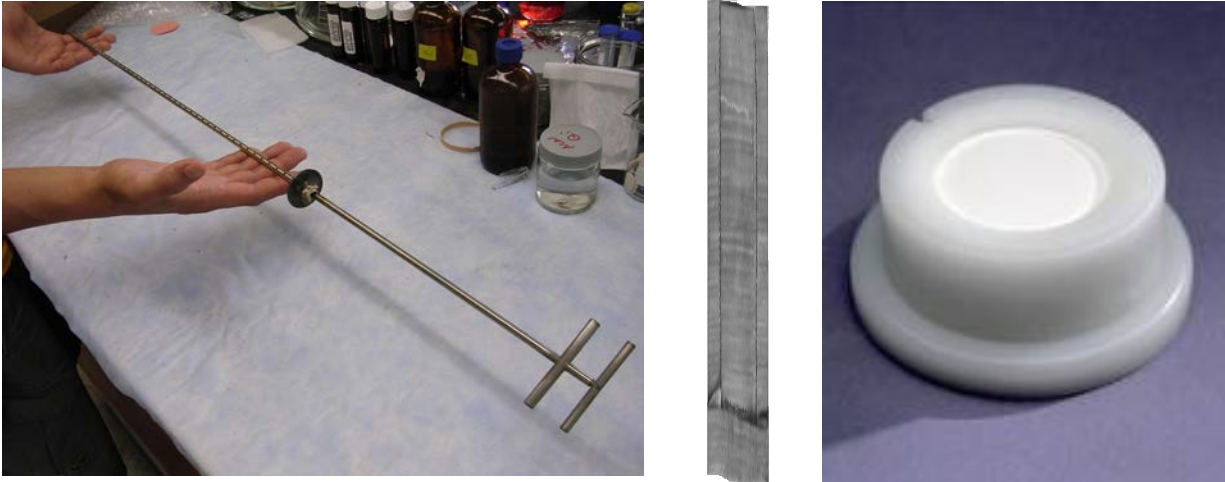

Figure 5-4. Two different approaches for field deployment of solid phase micro extraction (SPME) fibers (left and center) and commercially available Diffusive Gradients in Thin-film (DGT; right).



Figure 5-5. Intact sediment cores collected for flow-through (left) or static-renewal (right) ex situ bioassays, as well as sampling for sediment chemistry and benthic community analyses.

5.5 FIELD TESTING

5.5.1 Puget Sound Naval Shipyard

The field program for PSNS consisted of evaluation of SEA Ring technology performance under four events over a 4-year period, including baseline (pre-remedy) conditions and 10, 22, and 34 months post-remedy. Deployments were coordinated and paired with ESTCP Project #ER-201131 (Kirtay et al. 2016b), which focused on the placement and performance of a reactive amendment (AquaGate) towards sequestration of sediment-associated PCBs.

The primary components for the field testing included:

1. In situ toxicity and bioaccumulation testing with SEA Rings;
2. Concurrent real-time monitoring of water quality conditions inside SEA Rings;
3. Inclusion of passive samplers (SPME) in SEA Ring as another measure of bioavailability;
4. Sediment collection for laboratory bioaccumulation experiments.

A summary of the timeline of events related to field activities for the SEA-Ring demonstration at the BNC is provided in Table 5-1.

In addition to the measurements made as part of this demonstration, leveraging with ER-201131, we added the following supporting components and measures, which are fully described by Kirtay et al., 2016b:

- Sediment coring, for TOC and black carbon assessment;
- Sediment Profile Imagery (SPI) survey, for amendment placement/mixing assessment;
- SPI survey, for assessment of benthos and mixing via bioturbation;
- Benthic community census, for evaluation of ecological conditions.
- Resistivity/Friction Sound Probe Sensing, for amendment placement/mixing assessment

Overview. Field-collected organisms were purchased from commercial vendors, acclimated to field site conditions, and deployed in the SEA Ring in surficial (top 4 to 6”) sediment exposures for 14 days. Each SEA Ring consisted of 10 exposure chambers with organisms for bioaccumulation analysis: five chambers with the polychaete *Nephtys caecoides* and five chambers with the bivalve *Macoma nasuta* (bent-nosed clam). Following exposure, organism tissues were analyzed for PCB congeners and lipid content. SEA Ring devices were deployed at the 10 multi-metric stations within the amendment remedial footprint as shown in Figure 5-6. An overview of the PSNS site was provided previously in Section 4.1, Figure 4-1. At four stations (B4, B5, B6 & B7), 5” core samples that maintained the vertical stratification of the sediments and/or reactive amendment were collected for concurrent assessment of bioaccumulation of PCBs by organisms in the laboratory from the same test batch using modifications of standard laboratory methods (USEPA, 1994a; ASTM, 2000; ASTM 2010).

Table 5-1. Schedule of field activities for SEA Ring demonstration—*in situ* remedy assessment at PSNS.

Field Day #	Tasks
2–7 days prior to Deployment	Order test organisms Prepare field and lab datasheets and laboratory glassware Ship SEA Rings and related equipment to site Pre-label sample collection equipment and bottles for analytical chemistry Inform laboratories of schedule
-2	Ship test organisms to site (and appropriate lab for concurrent laboratory exposures) Arrive on site
-1	Obtain test organisms and begin acclimation Prepare SEA Rings, water quality sondes, and SPMEs for deployment
0	Load organisms, SPMEs, and sondes into SEA Rings and deploy Collect core sediment samples for chemistry and laboratory bioassays Ship samples to appropriate laboratories
1	Initiate laboratory bioassays
2–13	Observe field site as necessary Measure water quality daily and make required water renewals for laboratory exposures (per specific method)
14	Retrieve SEA Rings from each site Sieve, collect, enumerate <i>in situ</i> organisms and initiate overnight depuration Process passive samplers Download sonde water quality data
15	Sieve, collect, enumerate laboratory organisms and initiate overnight depuration Weigh <i>in situ</i> organisms, freeze, and ship to analytical lab
16	Weigh laboratory organisms, freeze, and ship to analytical lab

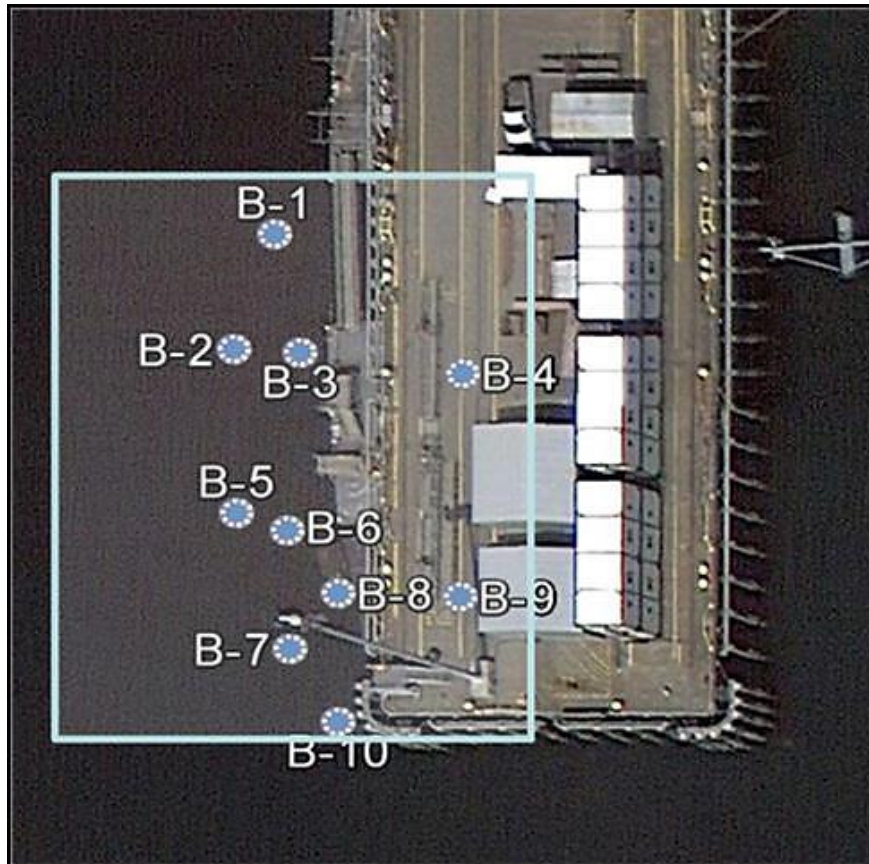

Figure 5-6. Pre- and post-amendment assessment locations using the SEA Ring technology.

Portions of this document include intellectual property of Esri and its licensors and are used under license. Copyright © (March 2, 2012) Esri and its licensors. All rights reserved.

Preparation. SEA Rings were cleaned following laboratory SOPs (Appendix B) prior to shipment to the site. Once on site, SEA Ring devices were fully charged and programmed to the desired pumping interval. SEA Rings, test organisms, water quality sondes, and other required equipment were shipped to and stored on site at PSNS. Test organisms were acclimated to site water conditions (or at the nearby Newfields/Ramboll Environ toxicity laboratory in Port Gamble, WA) for a minimum of 24 hours prior to exposure by slow introduction of pumped surface site seawater into vessels holding the test organisms.

Deployment. On deployment day, five 1" clams were directly loaded into exposure chambers with coarse (1/2" flexible titanium) mesh fastened to the bottom. Ten polychaetes were loaded into the 30-mL syringes embedded in the SEA Ring chamber cap for later release into the open bottomed sediment chambers following placement at the site. SEA Rings were held in 17-gallon plastic Chem-Tainers in site water and lowered to the water surface, where Navy divers (PSNS & IMF Dive Locker) removed them from the container while underwater, followed by deployment of each unit on the sea floor. The SEA Rings were gently pushed in by the divers to a depth where the base plate became flush with the sediment surface, embedding test chambers to a depth of approximately 5 inches. SEA Rings were then attached with large zip ties to pre-deployed plastic-coated fence stakes with a subsurface marker buoy to further secure them and assist with locating the SEA Rings upon recovery. Following placement, 10 5" sediment cores were collected from four of the stations and

hand carried intact to the toxicity laboratory in Port Gamble, WA, for concurrent laboratory exposures. A series of cores were also collected and composited for sediment chemistry (PCB congeners, total mercury/methylmercury, total organic carbon, grain size) under ER-201131.

Recovery. Following the 14-day exposure period, SEA Rings were recovered by Navy divers. Following an initial visual assessment of each ring, the device was gently lifted out of the sediment and polyethylene end caps were immediately affixed to the bottom of each exposure chamber upon removal from the sediment. In some cases, pre-installed core catchers were used instead of capping by divers. Each SEA Ring was then placed into a Chem-Tainer while under water prior to transfer to the boat crew. Polychaetes were recovered on site using seawater pumped over a 500- μ m stainless steel sieve to retain the organisms. Clams were recovered from the sediment by hand. Organisms were depurated overnight and prepared for analysis.

Tissue Preparation and Analysis. Following recovery, polychaetes and clams were purged in clean seawater overnight, and the soft-body portion saved for tissue analysis. Wet tissue weights were assessed on a per-replicate basis for both organism types, then typically composited on a per-station basis, and tissues were frozen and shipped on dry ice to the USACE ERDC analytical chemistry laboratory, where extraction and analysis were conducted using modifications of standard methods for small sample sizes (Jones, Millward, Karn, and Harrison, 2006).

Water Quality Characterization. Troll[®] 9500 probe (In-Situ, Inc.) or HOBO loggers (Onset Corp) were used to measure D.O., temperature, conductivity/salinity, and pH inside and outside a representative SEA Ring chamber at select stations. The loggers were used to verify that (1) parameters within test chambers remain within organism tolerance ranges, and (2) parameters within the test chambers did not vary more than 50% from ambient conditions. Continuous water quality data were collected at 5- or 10-minute intervals.

Porewater Sampling Analysis. Solid-phase microextraction (SPME) passive samplers were deployed directly inside one replicate SEA Ring chamber and immediately adjacent (outside) to the SEA Ring at each of the 10 multi-metric stations to provide a measurement of freely dissolved PCBs present in porewater of the surface sediment layer (top 15 cm). SPMEs were retrieved after 14 days, extracted with organic solvent, and the extract was analyzed for PCBs following procedures outlined by Yu et al. (2011) and Harwood et al. (2012), and discussed in detail in the final report for ER-201131.

Concurrent Laboratory Testing. Laboratory bioaccumulation exposures were conducted using standard methods (USEPA, 1994; ASTM, 2000; ASTM, 2010) on intact replicate core samples collected from the site immediately adjacent to deployed SEA Rings. Four of the 10 field stations were selected for concurrent laboratory testing for comparisons of variability between the lab and *in situ* at those stations.

(Note: The sampling of intact cores differs from most laboratory-based approaches that involve extensive manipulation (e.g., homogenization, sieving), and we believe that the approach used is more relevant for in place sediment remedy assessment. This approach has been incorporated into other projects as well where compositing techniques are inappropriate).

5.5.2 Marine Corps Base Quantico

The field program at MCB Quantico Embayment was coordinated with ER-201368. Detailed results that include additional measures to characterize the performance of the thin-layer cap will be provided in that report. For this project, there were three primary components for the field testing at MCB Quantico: (1) *in situ* bioaccumulation testing of the oligochaete worms, *Lumbriculus variegatus*, and the Asian clam, *Corbicula fluminea*, using the SEA Rings; (2) concurrent real-time

monitoring of water quality conditions using data sondes attached to SEA Ring; (3) concurrent deployment of *in situ* SPMEs (coordinated with D. Reible) around the SEA Ring; and (4) sediment collection for a single laboratory bioaccumulation comparison (baseline only) and sediment chemistry (all three deployments). A summary of the timeline of events related to field activities for a given SEA-Ring demonstration at MCB Quantico is provided in Table 5-2.

Table 5-2. Schedule of field activities for SEA-Ring deployment at MCB Quantico.

Field Day #	Tasks
Day 1–7 Prior To Deployment	Order animals or prepare <i>Lumbriculus</i> and <i>Corbicula</i> for shipment to Quantico, VA Prepare datasheets and laboratory glassware Pre-label sample collection equipment and bottles for analytical chemistry Research teams travel to Quantico, VA
Day 1 Prior to Deployment	Acclimate <i>Lumbriculus</i> and <i>Corbicula</i> to site conditions Prepare SEA Rings, sondes, anchors, and buoys Observe site
Day 0 Deployment Day	Weigh <i>Lumbriculus</i> and place in test tubes prior deployment Count out <i>Corbicula</i> and place in holding containers Load organisms and sondes into SEA Rings and deploy Collect sediments adjacent to SEA-Ring for the 14-day laboratory experiments to be conducted in the laboratory.
Days 1–2 Post- Deployment	Observe site Collect any additional samples for lab experiments
Day 14	Retrieve SEA Rings, anchors, and buoys from each site Sieve and begin organism purge in clean water Download water quality data from sondes Download pump rate data from SEA Rings
Day 15	Weigh and freeze tissue for shipment to analytical lab Begin demobilization process

The 2012 baseline characterization event was conducted October 10–24, 2012. Six sampling locations (Figure 5-7) were evaluated using two organisms, the aquatic oligochaete (*Lumbriculus variegatus*) and the Asian clam (*Corbicula fluminea*). The baseline event did not include station QB7 (also referred to as Q7), while subsequent post-remedy events included all seven stations shown in Figure 5-7.



Figure 5-7. Sampling locations for MCB Quantico site. The area in green represents where a thin-layer sand cap was installed in April 2014. Cap area encompasses sediment with surface sediment DDX concentrations greater than or equal to 200 $\mu\text{g}/\text{kg}$.

Preparation. SEA Rings were cleaned following laboratory SOPs (Appendix B prior to shipment to the site. Once on site, SEA Ring devices were fully charged and programmed to the desired pumping interval (see SEA Ring Operations Manual, Appendix C). SEA Rings, water quality sondes, and other required equipment were shipped to Quantico, VA, and stored until deployment.

Organisms. Farm-raised aquatic *Lumbriculus* and field-collected *Corbicula* were purchased from California Blackworm Co. and Dr. Harriett Phelps (University of the District of Columbia) or Dr. Jennifer Bouldin (Arkansas State University), respectively. Organisms were acclimated to the site temperature in fresh culture water using a mixture of three parts Perrier water and seven parts deionized water, aerated, for at least 24 hours prior to deployment. *Lumbriculus* was fed ground Tetramin™ fish flake food, following methods employed by University of Michigan for laboratory testing, and modifications of standard USEPA procedures (USEPA, 2000b).

Deployment. On deployment day, 10 1" *Corbicula* were directly loaded into exposure chambers with coarse (1/2" titanium wire) mesh fastened to the bottom. Approximately 3-g *Lumbriculus* were loaded into the 30-mL syringes embedded in the SEA Ring chamber cap for later release into the open-bottomed sediment chambers following placement at the site. SEA Rings were held in 17-gallon Chem-Tainers in site water and lowered to the water surface off a pontoon boat where EPA Environmental Response Team (Edison, NJ) divers removed the SEA Ring from the container while underwater and deployed the unit on the sea floor.

Recovery. Following the 14-day exposure period, SEA Rings were recovered by EPA divers. Following an initial visual assessment of each SEA Ring, the device was gently lifted out of the sediment. Polyethylene end caps were affixed to the bottom of each exposure chamber upon removal from the sediment, followed by placement of the device into a Chem-Tainer, and diver transfer to the boat crew. Oligochaetes were recovered on site using seawater pumped over a 250- or 425- μm sieves to retain the organisms. Clams were recovered from the cores by hand. Organisms were depurated and prepared for analysis as described below.

Tissue Preparation and Analysis. Oligochaetes and clams were purged in site water overnight. Soft-body portions of clams were removed from shells, and saved for tissue analysis. Wet tissue weights were assessed on a per-site basis for both organism types, and tissues were frozen and shipped on dry ice to the USACE ERDC Analytical Chemistry Laboratory for analysis of DDX and lipid content.

Water Quality Characterization. Troll[®] 9500 (In-Situ, Inc.) or HOBO[®] (Onset Corp.) datasondes were used to measure DO, temperature, conductivity/salinity, turbidity, and pH indirectly inside one replicate SEA Ring chamber, and immediately adjacent (outside) to the SEA Ring at select stations. The datasondes were used to verify that (1) parameters within test chambers remained within organism tolerance ranges, and (2) parameters within test chambers did not vary more than 50% from ambient measurements. Water quality data was collected at 5- or 10-minute intervals.

Porewater Sampling. SPMEs were provided by Dr. Danny Reible (Texas Tech University) as modified Henry samplers with a 1- (2012) or 2-foot (2014 and 2015) total length. A description of the methods is provided in Appendix D. The samplers were deployed immediately adjacent to the SEA Ring at each of the stations to provide a measurement of dissolved DDX present in porewater at different depths. SPMEs were retrieved after 14 days, extracted with organic solvent, and the extract was analyzed for DDX following procedures outlined in Appendix D.

Laboratory Bioassay. Concurrent laboratory bioaccumulation tests were conducted for the baseline study (QB1) in 2012. Nine intact (unmanipulated) core samples were collected adjacent to where SEA Rings were deployed at three select stations where the cap was intended for placement (Stations 1, 3, and 5). A fourth station (Station 6) was also sampled for laboratory analyses as an off-cap (reference) location. Samples were collected in 10" cores (5" of sediment), identical to those used in the SEA Ring. Cores were hand carried to the University of Michigan laboratory and the bioassay initiated on October 15, 2012. The organisms used were from the same test batch as those used in the field effort. Cores were stored at 4 °C until test initiation. Water quality was monitored daily and overlying water was renewed once daily. Following a 14-day lab exposure, organisms were recovered, enumerated, purged in clean water overnight, weighed, and transferred to vials for shipment and chemical analysis. Other than the modification of using intact cores, laboratory experiments followed the EPA's guidelines for freshwater sediment bioaccumulation tests using *Lumbriculus* and *Corbicula* (USEPA, 2000). A summary of the test conditions for the laboratory bioassay is provided in Appendix G.

Sediment Chemistry. A subset of the collected cores not used for bioaccumulation testing was composited and subsampled for bulk DDX concentration, grain size, and TOC.

5.5.3 Naval Base San Diego

There were four primary components of the field activities for this demonstration:

1. *In situ* toxicity testing using the SEA Ring;
2. Concurrent laboratory-based toxicity studies for comparison to the SEA Ring exposure;
3. Analytical chemistry on grab samples, composite samples, and passive samplers;
4. Stormwater plume characterization using real-time water quality sondes.

SEA rings were deployed with test organisms the day before a series of strong winter storms with a total of 2.59” of precipitation recorded during the field exposures spanning up to 4 days between February 27 and March 2, 2014. A summary of the test design using the SEA Rings is provided in Table 5-3, and a summary of the timeline of events related to field activities for the SEA Ring demonstration at NBSD is provided in Table 5-4.

Table 5-3. Test design for SEA Ring deployment at NBSD.

Site Name	Station ID	Description	Depth Profile
Chollas Creek	CC1	Mid-Channel – Security Finger Pier	Top
			Bottom
	CC2	Entrance of Chollas Creek to San Diego Bay (inside MHP Pier)	Top
			Bottom
NBSD Outfalls 13 and 14	OF13	Near Outfall 13 discharge point	Top
			Bottom
	OF Mid	~100 ft south of OF 13 and 250 ft north of OF 14	Top
	OF Far	End of Pier 6	Top
SSC Pacific Reference Site	REF	SSC Pacific Pier	Top

Notes: Top - 1 meter below the surface; Bottom - 3 meters below the surface. CC = Chollas Creek, OF = Outfall. Each SEA Ring contained: five replicates with mussel embryos (two chambers, two to three embryo drums each), four replicates with 10 mysids each, two replicates with 10 *Neanthes*, and one replicate with kelp blades.

Table 5-4. Schedule of field activities for SEA Ring demonstration—*in situ* stormwater toxicity.

Field Day #	Tasks
2–7 Days Prior to Storm	Order animals, acclimate in the lab Prepare datasheets and laboratory glassware Pre-label sample collection equipment and bottles for analytical chemistry Inform laboratories and Navy Base security and field ops of schedule
-1	Set anchors, buoys, and lead lines Prepare SEA Rings and sondes Measure pre-storm water quality (pH, D.O., salinity, temperature, ammonia) and collect receiving water samples for analysis of trace metals, DOC, and PAHs at Site CC-1, OF13-Near, and the SSC Pacific dock. Observe sites, take photos Collect kelp, rinse, dry, and keep cool overnight.
0	Prepare all test species in the lab and bring to the sites for inoculation (1 technician) Load organisms and sondes into SEA Rings and deploy (Team#1 - 3 people) Following initiation of visible runoff, start collection of receiving water and stormwater grab samples for field measurements, analytical chemistry, and laboratory exposures (Team #2–2 people) Observe sites, take photos
1	Continue collecting grab samples as needed to achieve 8 samples at approx. 1-hr intervals at each SEA Ring site. Observe sites, take photos Prepare vials to preserve bivalve embryos
2	Observe sites, take photos Retrieve 48-hour duration test organisms (bivalve embryos and kelp blades)
3	Prepare supplies for retrieval and subsequent lab tests for kelp and <i>Neanthes</i>
4	Retrieve SEA Rings, anchors and buoys from each site Count mysids and <i>Neanthes</i> . Transport <i>Neanthes</i> to the lab for post-feeding exposure assay. Retrieve kelp blades and transport to the lab for post-exposure spore release and germination/growth tests. Download water quality data from sondes Download pump rate data from SEA Rings Observe site, take photos

CC = Chollas Creek, OF = Outfall. SSC Pacific Reference Site not shown.

In Situ Toxicity Tests. SEA Rings were installed at three locations centered on two primary outfall locations (OF 13 and OF 14), and at two locations within the Chollas Creek channel as shown in CC = Chollas Creek, OF = Outfall. SSC Pacific Reference Site not shown.

Figure 4-4. A map of the general vicinity and sample locations for the demonstration at NBSD (including the SSC Pacific dock) in relation to all of San Diego Bay, was provided previously in Figure 4-3.

Outfall 14, with a greater catchment area, is located approximately 275 ft. north of OF 13. The OF 14 location was originally targeted for the demonstration, but a large vessel blocked access to this site. SEA Ring test locations were positioned near Outfall 13 (OF-N), and between OF 13 and 14 (OF-M). A SEA Ring located at the far end of Pier 6 at NBSD (OF-F) and the SSC Pacific dock (near the mouth of the bay) served as comparative “reference” locations at a distance from direct freshwater influences. Sites assessing impacts from Chollas Creek were located directly in the middle of the channel between the security finger piers and bulkhead (CC-1), and just outside the entrance of Chollas Creek to San Diego Bay (CC-2), located between the quay wall and the eastern edge of a large portable Pier (the MHP Pier).

Each SEA Ring housed four test species (mysid shrimp, giant kelp sporophylls, polychaete worms, and mussel embryos). SEA Rings were suspended 1 meter below the surface at MLLW all locations, a depth where direct influence of stormwater was anticipated based on prior salinity depth profile measurements during large storm events. At the two Chollas Creek sites, and the site closest to OF 13, an additional SEA Ring was situated at a depth of approximately 3 meters below the water surface (bottom) to assess any vertical spatial differences related to salinity stratification.

SEA Rings were deployed off of docks or quay walls, and suspended in the water column with lines and buoys attached to an anchor weight as depicted in Figure 5-8. A photograph of the screened drum chambers used for housing mussel embryos within the SEA Ring is provided in Figure 5-9, while other organisms were housed in the primary SEA Ring exposure chambers.

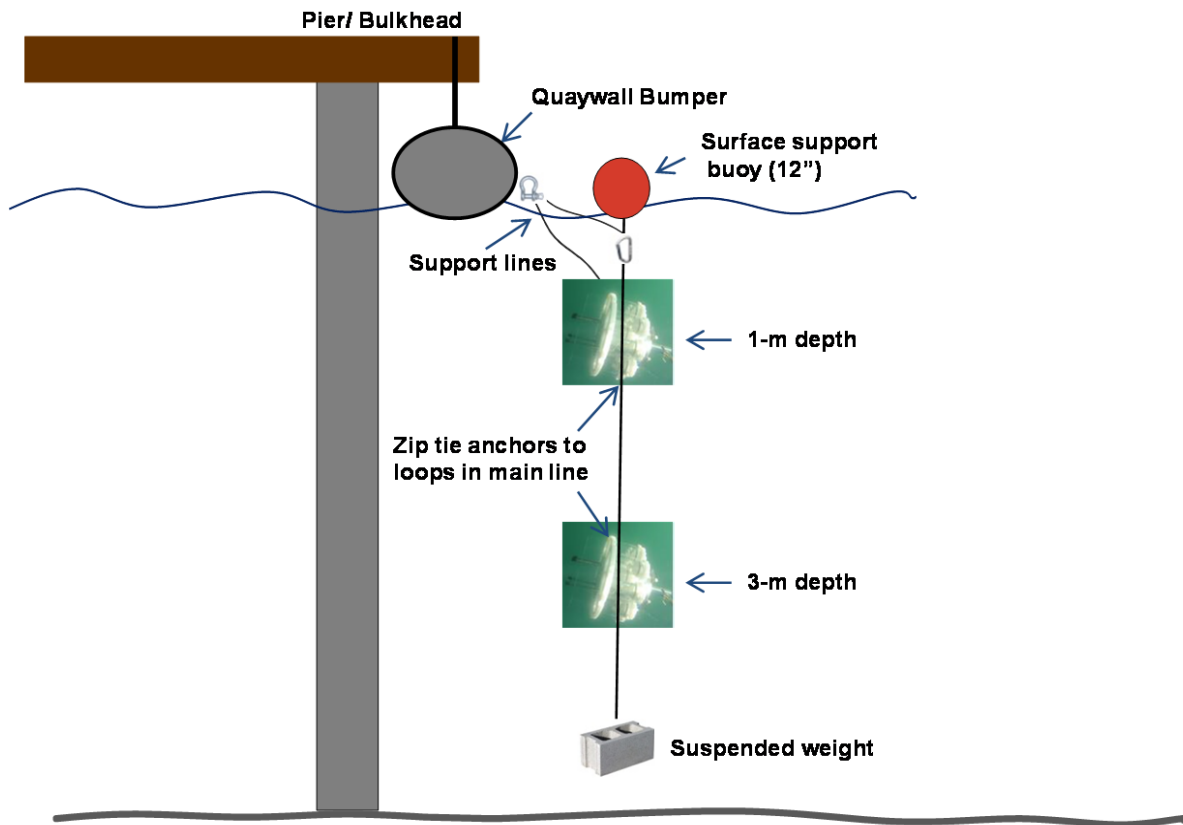

Figure 5-8. SEA Ring anchor configuration to assess stormwater impacts in San Diego Bay.



Figure 5-9. Embryo drums used for housing mussel embryos within exposure chambers in the SEA Ring for *in situ* exposures.

Each SEA Ring unit contained nine test chambers. One of these chambers housed kelp sporophyll blades (*Macrocystis pyrifera*), four contained mysid shrimp (*Americamysis bahia*; 10 shrimp per chamber), two contained polychaete worms (*Neanthes arenaceodentata*; 10 worms per chamber), and two contained mussel embryos (*Mytilus galloprovincialis*; two to three replicates per chamber; five replicates total). Test summaries are provided in Appendix G. Mussels and kelp were exposed for 48 hours and mysids and polychaetes were exposed for 96 hours per standard methods.

At approximately 48 hours, post-deployment, kelp blades and bivalve embryo drums were recovered from the chambers and transported to the appropriate laboratory. SEA Rings were carefully redeployed for 96-hour exposure with kelp and *Neanthes*. Kelp blades were transferred to Nautilus Environmental, where blades were desiccated, and then submerged in clean filtered seawater to allow for the release of kelp spores. Spores then underwent the traditional 48-hour germination and growth test (USEPA, 1995). Embryo drums were transferred to the SSC-Pacific laboratory where embryos were collected from the drums and fixed with 10% buffered formalin for evaluation of larval development.

Under the current EPA germination and germ-tube growth test method for the giant kelp, zoospores are released from the sporophylls (reproductive kelp blades), and then directly exposed to a test sample for a period of 48 hours. Because the zoospores are mobile and microscopic, it is very difficult to conduct real-time *in situ* exposures where desired to better characterize dynamic environments (i.e., storm water plumes). In this study, sporophylls were placed inside test chambers of the SEA Ring and exposed *in situ* for 48 hours (Cibor, Payne, Stransky, and Rosen, 2014).

At approximately 96-hour post-deployment, the SEA Rings were removed from each site and the remaining test chambers transferred to the SSC Pacific laboratory for the enumeration of surviving mysids and polychaete worms.

Water Quality Characterization. Characterization of the receiving water at locations monitored for toxicity using the SEA Rings was conducted through the use of a variety of supporting real-time and discrete measurements as described below.

- **SEA Ring Test Chamber Water Quality.** HOBO loggers (Onset Corp) that recorded temperature and DO were placed inside a single test chamber on two of the SEA Rings to verify that these parameters remained within organism tolerance ranges to test the chambers, and did not differ by more than 50% from ambient conditions. All continuous water quality data within and outside SEA Ring test chambers was collected at 10-minute intervals. Discrete measurements of pH, temperature, DO, and salinity were also recorded in a single test chamber for each test species immediately after retrieval of the SEA Rings.
- **Ambient Water Quality Monitoring.** HOBO loggers and sondes were mounted to the external frame of each SEA Ring to monitor ambient salinity and temperature conditions at each SEA Ring unit. A snapshot field measure of DO, pH, temperature, and salinity was also performed at each SEA Ring location using portable YSI™ field meters. These measurements were collected concurrent with multiple grab samples at each site prior to and during the storm event, as well as at 48- and 96-hour time points. These field measures provided valuable information to assess the dynamic water quality conditions to which test organism were exposed *in situ*, and also to determine if any effects observed were due to parameters outside the organisms' physiological tolerance rather than sediment or stormwater-associated contaminants.
- **Diffusive Gradients in Thin-films (DGT).** Diffusive Gradients in Thin-films (DGTs) were incorporated for *in situ* determinations of labile metal species (INAP, 2002). The DGT device passively accumulates labile organic species and inorganic complexes from solution while deployed, which provides a time-averaged concentration of metal ions independent of flow rate over a given time period. Use of DGTs eliminates contamination problems commonly associated with conventional water collection and filtration procedures. Since DGTs offer an operationally defined measure of the labile, or "bioavailable," fraction of metals concentrations, this aids in the interpretation of metals toxicity data comparable to an organism's real-time exposure. Two DGT passive samplers were deployed concurrently with each SEA Ring at each of the nine stations, one inside an exposure chamber to measure the metals content in water pumped into the SEA Ring where organisms were exposed, and one attached outside to measure ambient water. DGTs were retrieved after a 48-hour exposure, and underwent an acid-extraction of the resin layer followed by metal analysis of the extract via ICP-MS. Measured metals concentrations using the DGTs were calculated as outlined in Appendix H.
- **Collection of Grab Samples for Laboratory Analysis and Toxicity Testing.** For comparison to the SEA Ring exposures for stormwater monitoring, discrete water samples were collected at the same locations and depths where SEA Rings were deployed for laboratory toxicity assessment and chemical analyses. Site ID and collection details are provided in Appendix F. Water samples from open sites were collected by a team of two people using a Niskin bottle. Samples from the stormwater outfalls, OF13 and OF14, were collected from the manhole access cover using a peristaltic pump, and transferred into high-density polyethylene (HDPE) cubitainers. Three temporally distinct sample types were collected: (1) pre-storm samples, (2) first-flush grab samples (Grab 1 and/or Grab 2), and (3) time-weighted 24-hour composite samples consisting of up to eight grab samples collected over the 24-hour period. Pre-storm samples were collected only at the surface for Sites CC-1, CC-2, OF-14, and REF within 24 hours prior to the rain event that occurred on February 27, 2014. Rain began to fall in earnest on February 28, 2014, and up to eight grab samples were collected at each site, with the first grab sample collected as close to the first hour of observable runoff as possible. Six additional grab samples were collected on the

same day and the remaining two grab samples collected on March 1, 2014, based on the duration of the rainfall and safety concerns (Table 5-4). Grab 1 and 24-hr composite samples were collected from every site noted in Table 5-3. Additional grab samples were collected when timing and conditions permitted during distinctly heavy rainfall and subsequent runoff. Approximately 1 liter of sample water was collected from each site for the pre-storm and subsequent grab samples. An additional 9 liters of sample was collected at each site for the Grab 1 for additional testing. All sampling times and conditions at each site were recorded by the sampling teams. Water quality parameters were measured at each site during sample collection by the field crew using YSI® Professional Plus portable meters. Samples were then stored on site in coolers with ice to maintain appropriate temperature until transported to the SSC Pacific Bioassay Laboratory.

All samples were received in the laboratory on March 1, 2014. The eight grab samples from each station were composited in equal parts and water quality parameters, including pH, DO, salinity, and temperature were measured prior to testing. Water quality parameters were also measured on the pre-storm and Grab 1 samples. Toxicity tests were performed using the same suite of four organisms as described above.

- **Chemical Analysis of Grab and Composite Samples.** First-flush grab samples from the receiving water at each SEA Ring location, Outfalls 13 and 14, as well as an event-wide receiving water composite sample were submitted to analytical laboratories (Weck and SSC Pacific) for analysis of a select suite of CoCs (trace metals and PAHs) and physical characteristics, including dissolved organic carbon (DOC) and total suspended solids (TSS) as described further in Section 5.6.
- **Photo/Video Documentation.** Photos and video were taken after installation at each site above and also below the water surface by attaching a waterproof camera to a retractable pole. In addition, GPS coordinates for location were recorded at the time of installation, and a second time to verify placement when the SEA Rings were retrieved.

5.6 SAMPLING METHODS

A description of the samples collected for each demonstration, including number, quality control samples and locations, is described below in Table 5-5 through Table 5-7. A summary of the analytical methods is presented in Table 5-8 and Table 5-9.

Table 5-5. Laboratory analyses performed for each of the four SEAP demonstrations at PSNS*.

Analysis*		Samples per Station	Number of Stations	QA/QC Sample Duplicates	Total Number of Samples
SEA Ring tissue	Polychaetes: PCBs, lipids	1	10	3	13
	Bivalves: PCBs, lipids	1	10	3	13
Laboratory tissue	Polychaetes: PCBs, lipids	1	4	3	7
	Bivalves: PCBs, lipids	1	4	3	7
Sediment	PCBs, grain size, TOC	1 Composite	10	1	11
SPME	PCBs in sediment porewater	2	10	1	22

*Note: Numbers of samples per event are shown. Multiply values by 4 to obtain total number of samples for the entire project (pre and post-remediation). Multiple other measurements were made under requirements of ER-201131, not shown here.

Table 5-6. Laboratory analyses performed for each of three demonstrations at MCB Quantico.

Analysis		Samples per Station	Number of Stations	QA/QC Sample Duplicates	Total Number of Samples
SEA Ring tissue	Oligochaetes and clams: DDx, lipids	3	6-7 ^a	3	18-21
Laboratory tissue ^b	Oligochaetes: DDx, lipids	3	5	3	18
Sediment	DDx, grain size, TOC	1 Composite	6-7	3	18-21
SPME	DDx in sediment porewater	2	6-7	4	12-14

^a Six stations were evaluated under ER-201130 in 2012 baseline, while a second off-cap station (Q7) was added for post-remedy monitoring under ER-201368.

^b For 2012 baseline survey only.

Table 5-7. Laboratory toxicity and chemical analyses performed for the demonstration at NBSD.

Site Name	Total # of Grabs ^a	Comp ^b	Chemical Analyses		Laboratory Toxicity Tests			
			Diss. Cu, Zn, TSS ^c	DOC, PAHs ^d	Bivalve Embryo Dev ^e	Mysid Surv ^e	<i>Neanthes</i> Surv	Kelp Spore Growth/Germ ^f
CC1-T	4 (PS, 1, 2, 4)	1	3	2	5	5	5	1
CC1-B	3 (PS,1,2)	1	3	2	4	4	4	1
CC2-T	1	1	2	1	2	2	2	1
CC2-B	1	1	2	1	2	2	2	1
OF13N-T	3 (PS,1,2)	1	3	2	4	4	4	1
OF13N-B	1	1	1	1	2	2	2	1
OF-Far-T	1	1	1	1	2	2	2	1
OF-Mid-T	1	1	1	1	2	2	2	1
OF13-SW	1	---	1	---	1	1	1	---
OF14-SW	2 (1,2)	---	1	1	2	2	2	---
SSC Pacific Dock (REF)	2 (PS,1)	1	2	2	3	3	3	1

CC = Chollas Creek; T = top SEA Ring; B = bottom SEA Ring; M = mid-distance from OF13 and 14 (approx. 100 ft south of OF13 and 250 ft north of OF 14; F = far-field from OF13 and 14 at NBSD (end of Pier 6); CC = Chollas Creek; PS = pre-storm sample; DGT = Diffusive Gradients in Thin films; -- = not tested

^a The first grab sample (#1) was collected at the beginning of a storm soon after rainfall began and was tested for all sites. Additional grab samples were tested as denoted in parentheses for some of the sites. Pre-storm (PS) samples were collected and tested.

^b Equal volume comp. of a total of eight grab samples collected over an ~24-hour period after rainfall first began.

^c Analysis at Weck Labs for all constituents (pre-storm, Grab 1, and composites only). Additionally total and dissolved Cu, Pb, Ni, and Zn were analyzed at SSC Pacific on a number of samples for comparison, including OF13-SW which not analyzed at Weck Labs.

^d Analysis at Weck Labs for DOC and PAHs (pre-storm and composites only).

^e All grab samples and composites tested (undiluted 100% samples).

^f Laboratory exposures were performed for kelp by exposing spores released from *in situ* exposed blades to clean laboratory seawater at Nautilus to assess subsequent germination and growth over a 48-hour period. Simultaneous to the *in situ* tests, kelp blades were also exposed for 48 hours to a series of copper concentrations (Lab Control (0), 32, 100, 320, and 560 µg/L) in both clean filtered laboratory water and pre-storm "Reference site" water from the SSC Pacific dock. Spores exposed in these copper dose series were then released and also tested in clean filtered laboratory control water to assess germination and growth over a 48-hr period.

Table 5-8. Analytical methods summary for the PSNS and MCB Quantico demonstrations.

Matrix	Analyte ^a	Method	Container	Preservative	Holding Time
Sediment	Total Organic Carbon	Lloyd Kahn	8-oz Glass	Chill: 4 ±2 °C	28 days
	Grain size	ASTM D422-63	Plastic	None	28 days
	Polychlorinated biphenyl (PCB) Congeners	EPA 8082	Glass	<0 °C	14 days until extraction, 1 year after extraction
	DDx (sum DDT, DDD, DDE)	EPA 8081	Glass	<0 °C	14 days until extraction, 1 year after extraction
Tissue	PCB congeners	EPA 1668	Glass vial	<0 °C	14 days until extraction, 1 year after extraction
	DDx	EPA 8081	Glass vial	<0 °C	14 days until extraction, 1 year after extraction
	Lipid	Gravimetric	Glass vial	<0 °C	1 year, if frozen
SPME Extracts	PCB congeners	EPA 1668	Glass	Chill: 4 ±2 °C	14 days
	DDx	EPA 8081	Glass	Chill: 4 ±2 °C	14 days

^a All analyses conducted under oversight of the ERDC chemistry laboratory in Vicksburg, MS. Some analyses (TOC, grain size) were subcontracted.

Table 5-9. Analytical Methods Summary for the NBSD Demonstration.

Analyte	Method	Container	Preservative	Holding Time
Dissolved Cu and Zn ^a	EPA 1640	250-mL HDPE	HNO ₃	180 days
Labile Cu and Zn from DGT	EPA 1640	50-mL HDPE	HNO ₃	180 days
PAHs	8270C SIM Low-level	1-L amber glass (x2)	4°C	7 days
Total Suspended Solids (TSS)	SM 2540 D	1-L HDPE	4°C	7 days
Dissolved Organic Carbon (DOC)	SM 5310B	40-ml VOA vials (x2)	4°C	7 days

SM = Standard Methods

^a Conducted by Weck Laboratories, with some supplemental and comparative data from analyses using same methods at SSC Pacific.

Quality Assurance. Field duplicates were collected for each set of chemical analyses (sediment core samples, water samples, tissues, and SPMEs as appropriate). Additional laboratory quality control samples required by the referenced method, including laboratory control sample/laboratory control sample duplicate analyses, matrix spike/matrix spike duplicate analyses, surrogate recoveries, and other method specific quality control samples were included.

All analytical equipment was calibrated according to manufacturer instructions. Information on calibration of field instruments or URLs that link to detailed calibration instructions is provided in Appendix B

In addition, the following quality assurance procedures were employed during sampling and laboratory analyses.

- **Calibration of Analytical Equipment.** The SEA Ring was calibrated according to the SEA Ring Standard Operation Procedures (SOP manual (Appendix B)). Pump rate and duration were determined on a case-by-case basis depending on desired exposure duration, site conditions, and type of exposure.
- **Internal Quality Control (QC).** QA checks of sampling and analytical procedures were performed by submitting and evaluating field QC samples to the laboratory for analysis. This process included the collection of field duplicates. One field duplicate (sediment, surface water, and/or SPME) was collected and analyzed, to satisfy the typical requirement of one field duplicate for up to 20 field samples. In some cases, individual replicate analysis of tissue from SEA Rings or laboratory-exposed organisms served as QC for duplicates. The field duplicates were analyzed for the same list of compounds as the other samples for the specific site to check for sample homogeneity and laboratory accuracy.

Analytical laboratory QA/QC was maintained during the analytical portion of this study by using duplicate sample analyses, reagent blanks, and spiked samples as specified in the USEPA methods for individual chemicals. All QA/QC information was included with the analytical testing report.

- **Decontamination Procedures.** Prior to deployment, the SEA Ring hardware was prepared by cleaning in a dilute (2%) detergent (Liquinox) overnight, followed by conditioning in uncontaminated, filtered laboratory seawater, and a final soak in flowing deionized water. Disposable parts (pump tubing, bottom end caps, inner exposure chambers) were replaced prior to each demonstration. Once the organisms were retrieved from the test chambers in the field or in the lab, the SEA Rings were immediately rinsed with warm tap water and cleaned as described above before the next deployment.
- **Sample Documentation.** Samples collected for laboratory testing followed standard chain-of-custody (COC) procedures, including name of sample collector(s), sample ID, collection time and date, and temperature at the time of collection. Appropriate holding times for each analyte were met and proper signatures accompanied the COC form at each point of transfer of the samples. Sample containers and SEA Ring units were clearly pre-labeled prior to field work. All field and laboratory data collected was recorded on pre-printed datasheets. A sample documentation program was in place, including sample labels, custody seals, field logbooks, photographs, chain-of-custody forms, and laboratory logbooks.

5.7 SAMPLING RESULTS

Key sampling results summarizing organism recoveries, bioaccumulation and passive sampling data and comparisons are provided in this section. Some results, however, are provided in Section 6 and in Appendices, to reduce redundancy.

5.7.1 EPA ETV

The results of the above described ETV study are reported in detail in McKernan et al., (2014). Only those data required for addressing this project’s Performance Objectives for the technology are provided in detail in this report.

SEA Ring Control Performance. Control performance is routinely evaluated to establish test organism health and technical proficiency with the test method for laboratory tests (e.g., ASTM, 1999; USEPA, 1995; USEPA, 2002a). Under normal *in situ* conditions, an appropriate control in the same sense is typically not possible. For the ETV study, SEA Rings were loaded in the laboratory with laboratory dilution water and control sediment to establish test organism health, proficiency with the test method, and assurance that the SEA Ring did not present any adverse effects on the test organisms. The laboratory SEA Rings were tested alongside standard laboratory controls during concurrent laboratory verification testing.

Success for this performance objective was assessed by comparison of standard laboratory beaker control test results and the laboratory tested SEA Ring control samples. Sediment toxicity, water column toxicity, and bioaccumulation tests were investigated and for each test condition, the mean result in the SEA Ring was compared to that observed using traditional EPA methods using two sample t-tests, assuming unequal variances.

For all species tested and their respective endpoints, there were no significant differences (between the SEA Ring results and traditional laboratory beaker results (Table 5-10). For all test types, the percent difference met the performance objective of <25% difference.

Contaminant Uptake. Comparisons of contaminant uptake between laboratory-exposed and SEA Ring-exposed test organisms was conducted in two ways: (1) beaker and SEA Ring exposures conducted concurrently in the laboratory under controlled conditions (ETV) and (2) SEA Rings deployed in the field and qualitatively compared with results from intact cores set up in the laboratory.

Table 5-10. Control performance results from the EPA ETV comparability study for each test endpoint in control sediment and/or uncontaminated seawater.

Test Type	Species Tested & Endpoint	SEA Ring		Laboratory		ρ -value	% Difference
		Mean	SD	Mean	SD		
Sediment Toxicity & Uptake	Polychaete survival	94	1.9	95	1.7	0.85	1.1
	Polychaete growth (mg wet weight)	8.98	1.56	8.24	2.04	0.55	9.0
	Amphipod survival	96	1.3	94	1.1	0.61	2.1
	Clam survival	100	0	100	0	> 0.05	0.0
Water Column Toxicity	Topsmelt survival	96	0.4	100	0	0.37	4.0
	Mysid survival	90	1.2	100	0	0.18	10

The potential for a more accurate assessment of bioavailable contaminants of concern (CoC) is one of the major advantages of *in situ* exposures or laboratory-based exposures. Because bioavailability and potential for biouptake of CoCs is dependent on site-specific conditions, it is inappropriate to expect concordance between laboratory-exposed organisms with *in situ* exposed organisms. However, it is appropriate to ensure that the SEA Ring technology provides the same opportunity for bioaccumulation to occur, assuming comparable exposure in the laboratory and *in situ*. Through the laboratory-based study conducted under the ETV program, appropriate data and success criteria were obtained with which to make an appropriate comparison of biouptake assuming all conditions were equal.

The marine amphipod (*Eohaustorius estuarius*), the marine polychaete (*Neathes arenaceodentata*), and the bent-nosed clam (*Macoma nasuta*) were used for bioaccumulation comparability tests ranging from 10 to 28 days. The bioaccumulation of total PCBs (as a sum of National Oceanic and Atmospheric Administration [NOAA] 18 PCB congeners) was evaluated to the organisms exposed to sediments in both SEA Ring and laboratory beaker exposures (Table 5-11). The sediment was collected from the equivalent of Station 6 adjacent to Pier 7 at PSNS, as identified in ESTCP Project #ER-201131.

For select deployments associated with all three demonstration sites, laboratory bioassays were also conducted on intact sediment cores to demonstrate the difference in variability among SEA Ring replicates with laboratory replicates. This was also an opportunity to make qualitative observations on the difference between *in situ* and laboratory data, as holding such a comparison is inappropriate considering the expected differences between field and laboratory, and thus the rationale for conducting bioassays *in situ*. These results are incorporated on a site-specific basis in the sections below.

Table 5-11. Mean PCB concentrations for SEA Ring and laboratory exposures from ETV testing.

Species	SEA Ring				Laboratory Test			
	PCB (µg/kg)	SD	% Lipid	PCB Normalized to % Lipid (mg/kg)	PCB (µg/kg)	SD	% lipid	PCB Normalized to % Lipid (mg/kg)
Amphipod	3,151	2,215	1.27	248	5,644	5,373	1.21	466
Clam	87	24	0.36	24	85	2	0.34	25
Polychaete	379	10	1.94	20	367	82	1.94	19

5.7.2 Puget Sound Naval Shipyard

The results of the AquaGate™ study at BNC Pier 7 are extensively reported by Kirtay et al. (2016a,b). Results shown here include a brief overview of the performance of the remedy for easy reference, but in general, results provided here address the performance objectives associated with this project and not the performance of the remedy site.

Overall Performance at Site. The overarching result of ER-201131 was a significant and persistent reduction of PCB bioavailability (compared with pre-remedy conditions) following placement of the reactive amendment at Pier 7 (Figure 5-10). In that project, bioavailability was assessed using *in situ*

placement of *M. nasuta* and *N. caecoides* and deployment of SPME in surface sediments in or adjacent to SEA Ring chambers, which supported the overall findings associated with the remedy.

The reduction in concentrations of total PCBs in *M. nasuta* tissue from baseline to the 33-month event was 88% on average. The reduction in concentrations of total PCBs in *N. caecoides* tissue from baseline to the 33-month event was 97% on average. The reduction in concentrations of total PCBs in sediment porewater from baseline to the 33-month event was 81% on average.

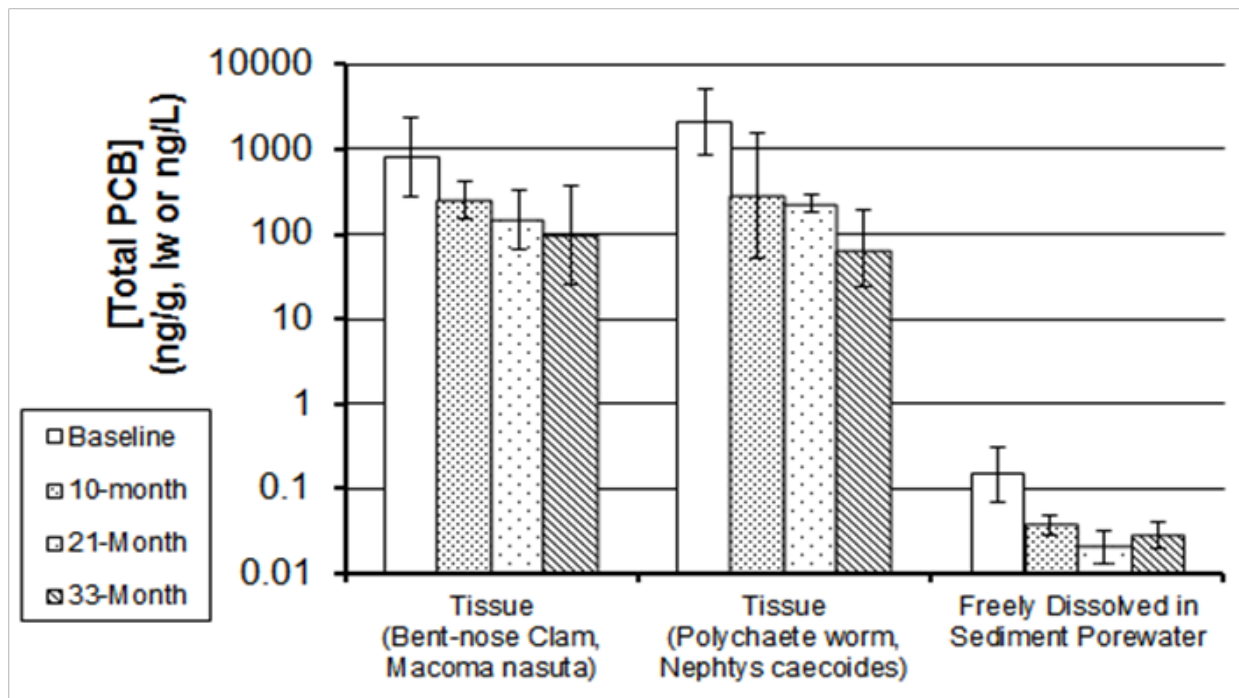

Figure 5-10. Summary of reduction in concentrations of total PCBs in tissue and sediment porewater. Results are shown as mean \pm 95% confidence level (Kirtay et al., 2016b).

Sediment/Organism Recovery. For the four PSNS deployments, *Macoma* numbers recovered alive averaged 72% of those deployed (Figure 5-11), while sufficient tissue mass was recovered for composite tissue analysis 93% of the time (37 out of 40 units deployed). Improvements in the recovery of *Macoma* were observed in events following the 2012 baseline event after integration of lessons learned (e.g., extended battery life and ultimately a more efficient pumping system).

Nephtys recovery was acceptable in terms of tissue mass required for analysis for 24 out of 40 (60%) SEA Rings deployed over the four sampling events (Figure 5-12), considerably less than that for the freshwater oligochaete (*Lumbriculus*) used at MCB Quantico (Section 5.7.3). The number of stations providing sufficient tissue mass for analysis was relatively consistent across the four events, ranging from 5 to 7 of 10 stations. As mentioned previously, worms that were recovered using the concurrent flow through bioassay conducted on intact cores were used when SEA Ring worms were not available in order to support tissue requirements for ER-201131. This was considered acceptable based on the high level of realism incorporated into the flow-through intact sediment core exposure approach.

Reasons for loss of some organisms include escape, predation, toxicity, water quality issues, and deployment or recovery challenges (e.g., cobble and shell hash) that in some cases resulted in insufficient penetration of the SEA Ring into the sediment or individual sediment core loss. Higher recoveries of live clams were possible as larger clams were retained with a 1/2" diameter coarse wire

mesh that minimized disruption of sediment, while polychaetes were deployed in open-bottom chambers.

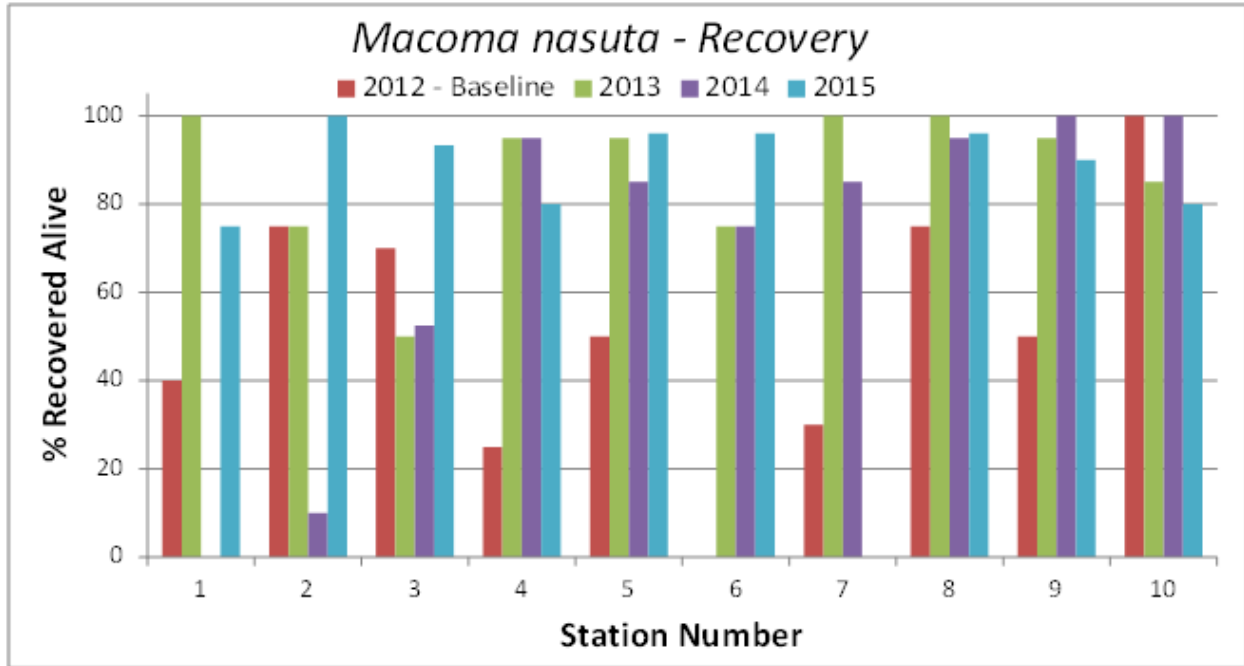

Figure 5-11. Percentage of bent-nosed clams (*Macoma nasuta*) recovered alive at each of 10 stations over four sampling events at PSNS.

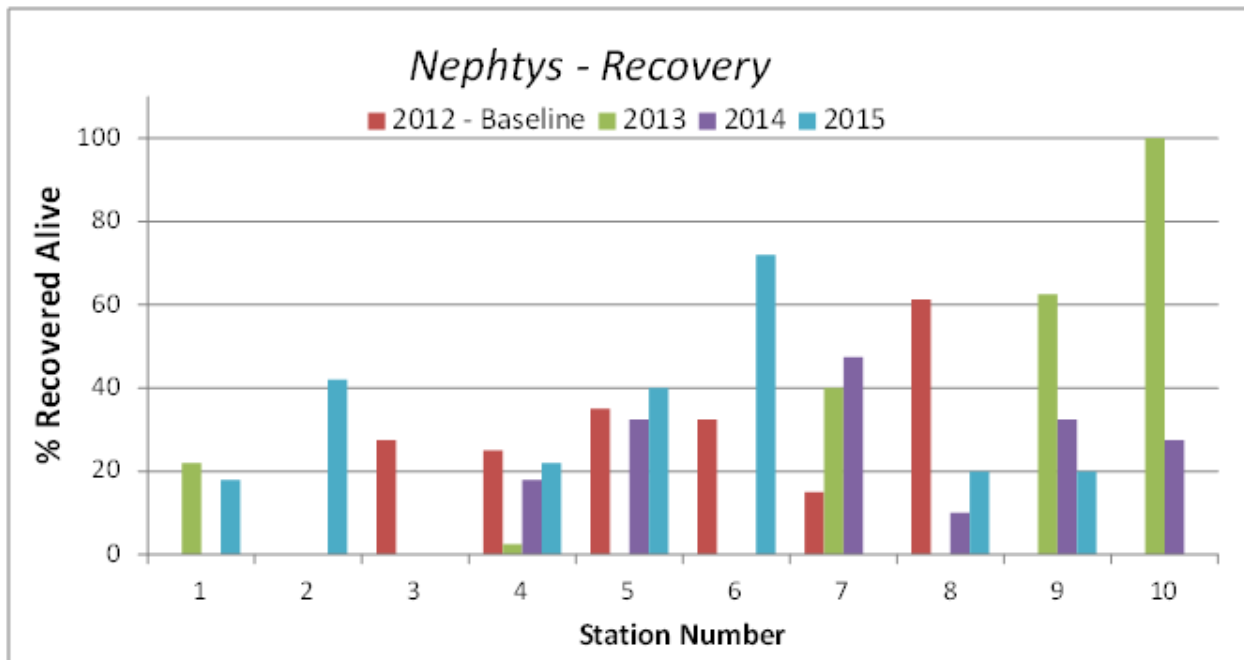

Figure 5-12. Percentage of the polychaetes (*Nephtys caecoides*) recovered alive at each of 10 stations over four sampling events at PSNS.

In Situ and Laboratory Study Comparison from PSNS&IMF. Figure 5-13 and Figure 5-14 summarize PCB concentrations for *M. nasuta* and *N. caecoides*, for four stations for which both *in situ* and ex situ data were generated. The data showed that bioaccumulation of PCBs differed when conducted in the field when compared to the laboratory. No predictable trend was observed in terms of greater uptake in one exposure over the other, except that, in general, Station B6, previously identified as a hot spot, resulted in the highest uptake. Comparison between baseline and 10-month post-remedy results, however, do show substantial reduction of PCB tissue concentrations for both species.

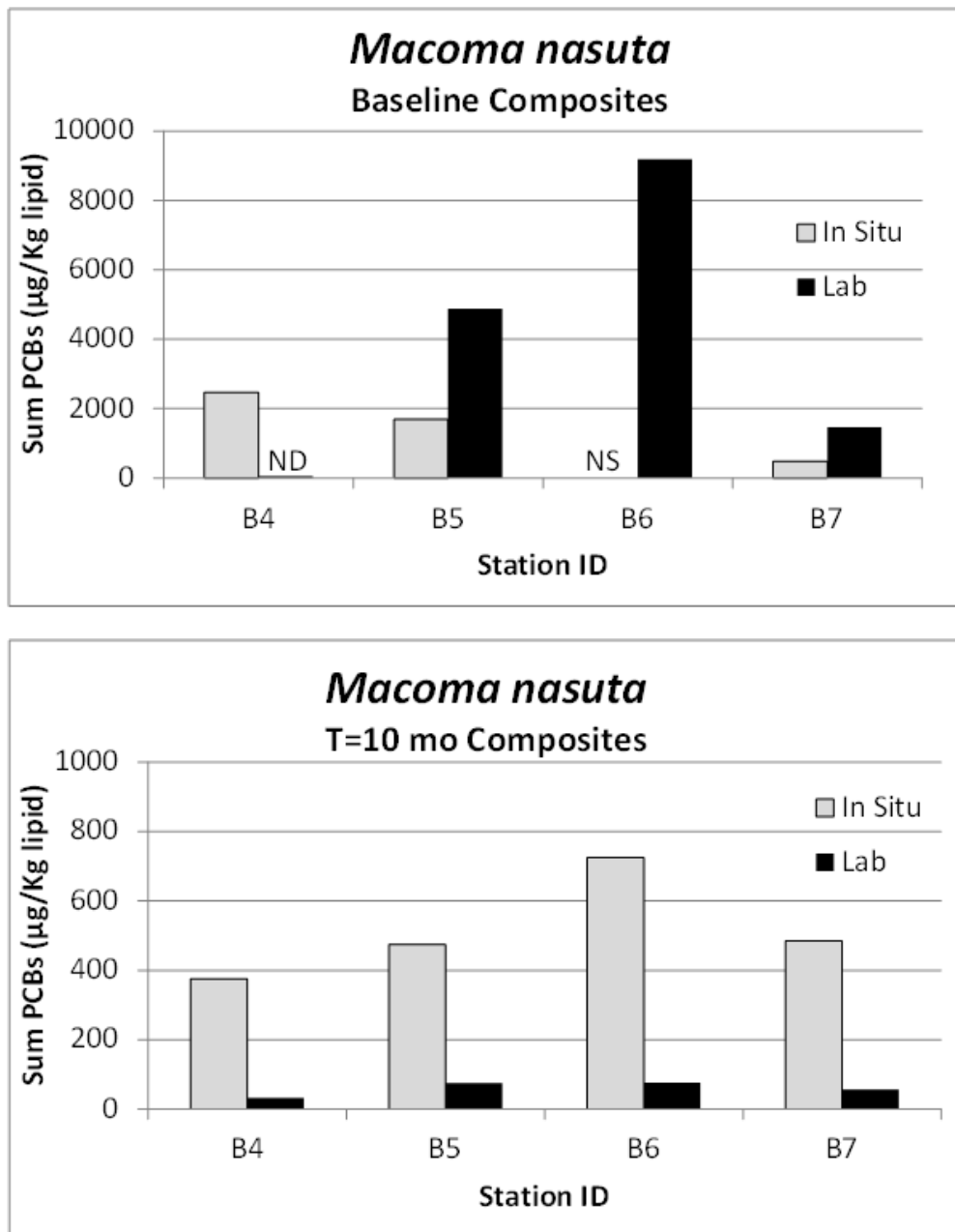

Figure 5-13. Comparison of *in situ* and laboratory-based evaluations of bioaccumulation by *Macoma nasuta* for baseline and 10-month post-remedy at PSNS Pier 7. ND = not detected. NS = no sample.

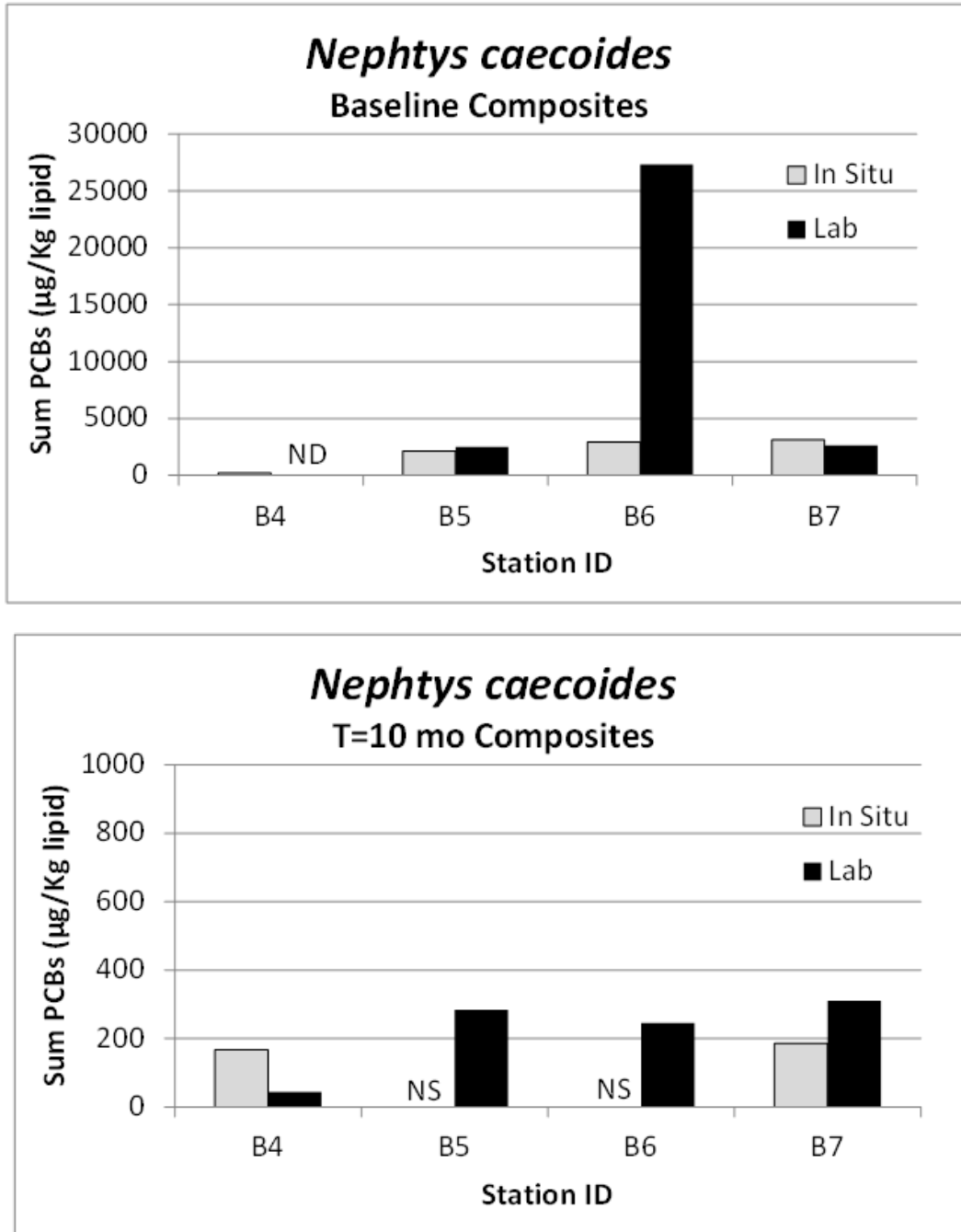

Figure 5-14. Comparison of *in situ* and laboratory-based evaluations of bioaccumulation by *Nephtys caecoides* for baseline and 10-month post-remedy at PSNS Pier 7. ND = not detected. NS=no sample.

Water Quality Maintenance. Example water quality measurements from the PSNS site are shown in Figure 5-15, and include continuously logged data representing conditions both inside and outside individual SEA Ring chambers. A more comprehensive summary of the water quality data from PSNS are provided in Appendix D. Conditions inside the SEA Ring chamber were generally similar to those outside. In some cases, rental datasondes had technical issues functioning partway through

the deployment. In addition, the initial flow cell design for housing the Troll® 9500 sondes also turned out to be difficult to keep flowing in cases.

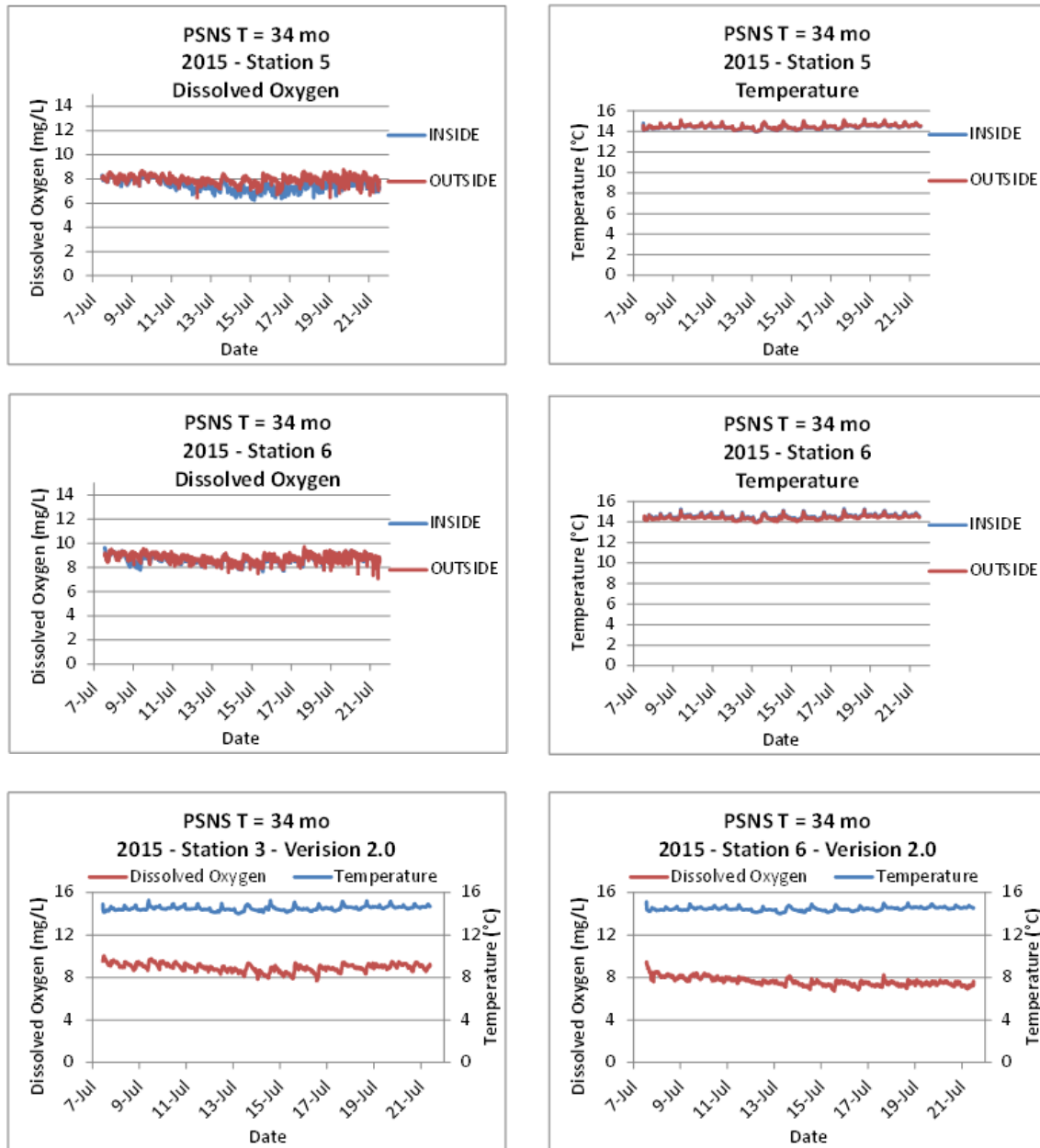

Figure 5-15. Dissolved oxygen and temperature data from T = 34 month (2015) post-remedy deployment at PSNS inside and outside SEA Ring chambers (inside only for bottom figures).

Therefore, the flow cell was eliminated and a modification of the chamber cap was made (Figure 5-16) to accommodate SSC Pacific-procured HOBO data loggers, which proved to be much easier to use, more reliable, and allowed the chamber to house organisms (unlike the flow cell).

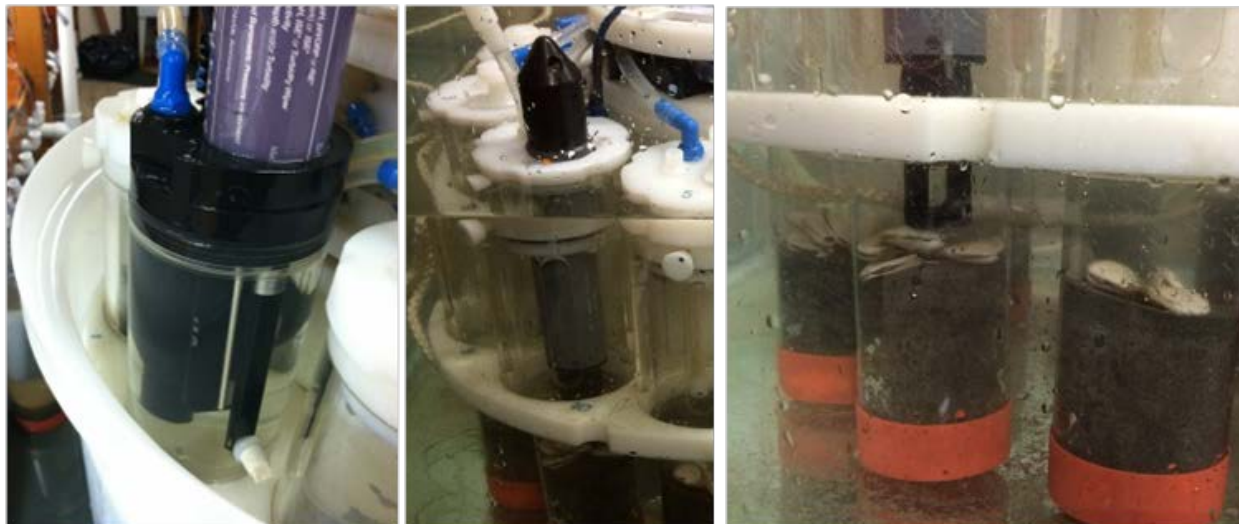

Figure 5-16. Within chamber water quality monitoring using a flow cell (left) or modification of chamber cap (center) for continuous measurements near the sediment-water interface (right).

Tissue Uptake and Porewater Comparison. Total PCB concentrations in tissues and in porewater (SPME) are tabulated in Appendix D, while a more detailed compilation of all tissue and passive sampling data are reported in Kirtay et al. (2016b). Log transformed tissue and porewater concentrations are compared in Figure 5-17 and Figure 5-18. For simplicity, this comparison includes composited data from all SEA Ring stations and events for which organisms were recovered. The SPME data points represent the mean of two replicate SPMEs placed at each station, one inside a core in the SEA Ring and one in a core immediately outside the SEA Ring.

A positive relationship was observed between tissue and porewater concentration for both species when all data points ($n = 37$ and $n = 23$ for *Macoma* and *Nephtys*, respectively) for which both tissue and porewater data were available. For *Macoma*, the relationship was relatively weak ($r^2 = 0.050$) and was not statistically significant ($p = 0.184$). For *Nephtys*, the relationship was stronger ($r^2 = 0.276$) and was statistically significant ($p = 0.010$). When the data were averaged across the entire site and expressed on a per event basis, the relationship became much stronger, with r^2 values of 0.651 and 0.917, for *Macoma* ($p = 0.193$) and *Nephtys* ($p = 0.043$), respectively. It is conceivable that the stronger relationship observed for *Nephtys* is associated with their preference to deposit feed at a subsurface level (as compared to the surface deposit feeding clam), thus being more closely in contact with the top several inches of the sediment.

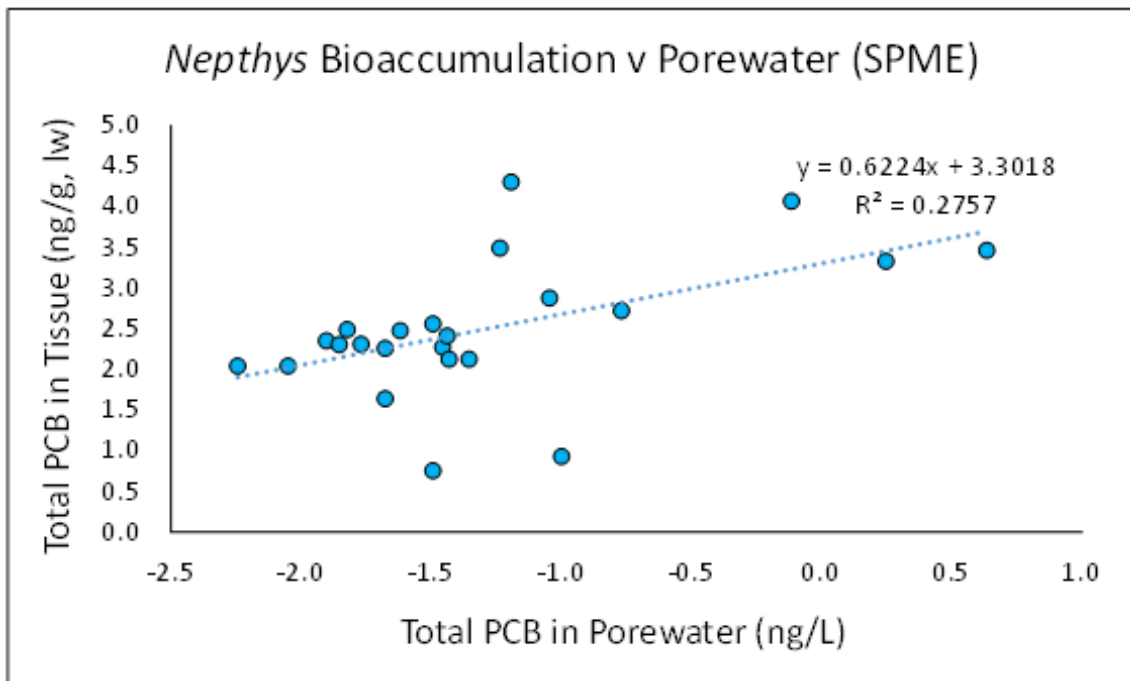
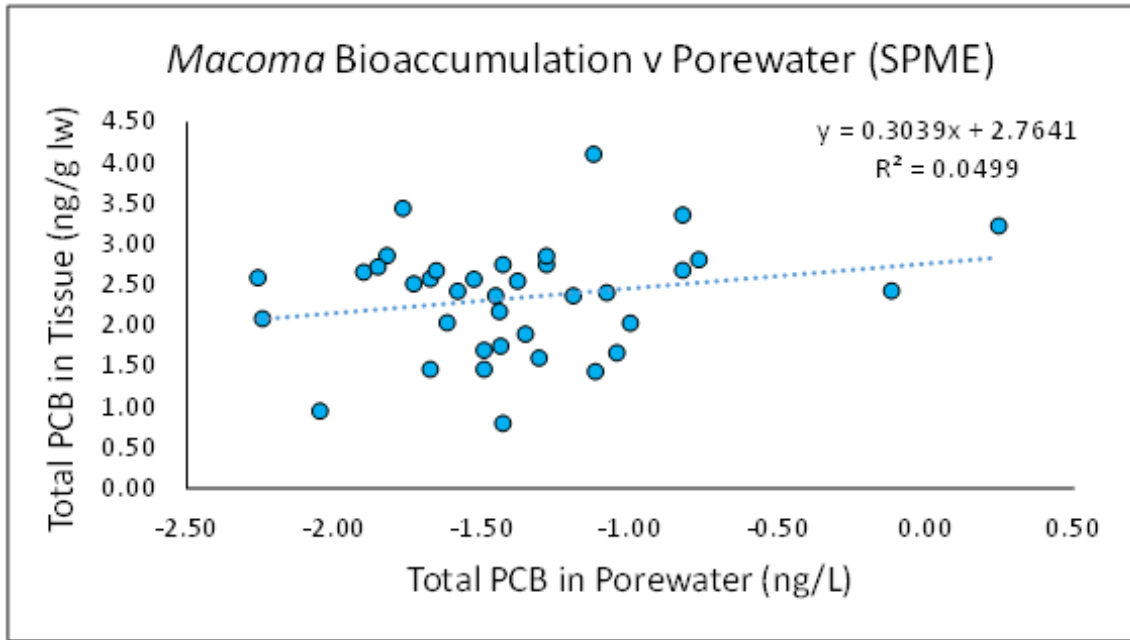

Figure 5-17. Comparison of total PCB concentrations in *Macoma* (top) and *Nephtys* (bottom) with that of porewater concentrations derived from SPME. Concentrations are log transformed data from all four monitoring events.

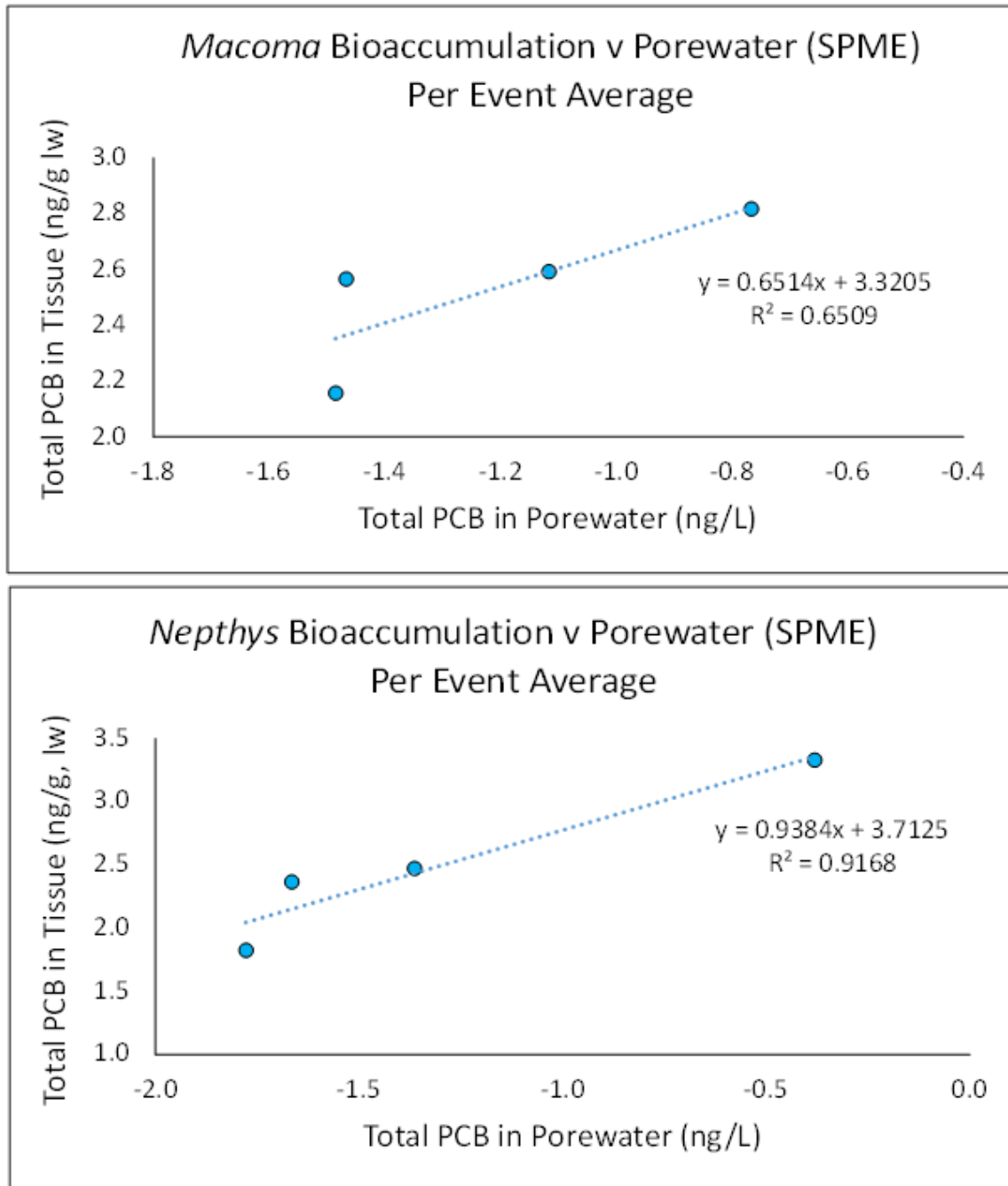

Figure 5-18. Comparison of total PCB concentrations in *Macoma* (top) and *Nephtys* (bottom) with that of porewater concentrations derived from SPME. Concentrations are log transformed data averaged from each of the four monitoring events.

5.7.3 Marine Corps Base Quantico



Figure 5-19. SEA Ring demonstration at MCB Quantico.

Overview of SEA Ring Pump Performance. Version 2 SEA Rings were deployed during the 2012 Baseline and first post-remedy event (T = 2 months, 2014), while Version 3 units were deployed during the second post-remedy event (T = 14 months, 2015; Figure 5-19). SEA Rings were successfully deployed and recovered for all events, except for a duplicate unit deployed at Station Q3 in 2014, which was lost. Pump rates were calculated as averaging 107 ± 6.7 mL/chamber/min (<5 % difference) for the first two events (Version 2 SEA Ring), which equated to 17 or 40 water exchanges within a given chamber per day, depending on whether or not an external battery pack was present, the latter of which allowed for a more aggressive pumping regime. For the third event (Version 3), pump rates averaged 3,240/chamber/minutes (324 mL/chamber/6 seconds), equating to 140 or more turnovers per day. Variation among individual pumps on a SEA Ring unit was <9%.

Sediment/Organism Recovery. Detailed data associated with the MCB Quantico demonstration are provided below and in Appendix E. *Corbicula* were recovered from 100% of SEA Rings (Figure 5-20), providing sufficient tissue mass for analysis. Sufficient *Lumbriculus* tissue mass was recovered from 19 out of 21 (90%) of units deployed over the three events, with one unit being lost and plungers accidentally not depressed by divers to release worms for the other (Figure 5-21).

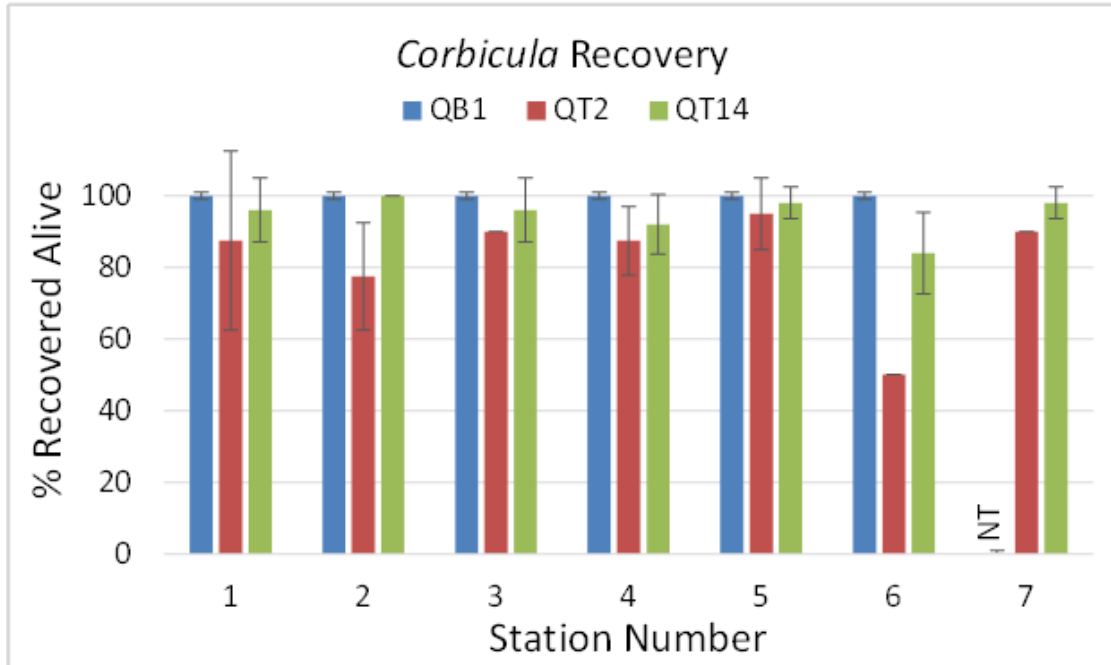

Figure 5-20. Percentage of Asian clams (*Corbicula fluminea*) recovered alive at each of seven stations over the sampling events at MCB Quantico. NT = not tested for the 2012 Baseline event (QB1).

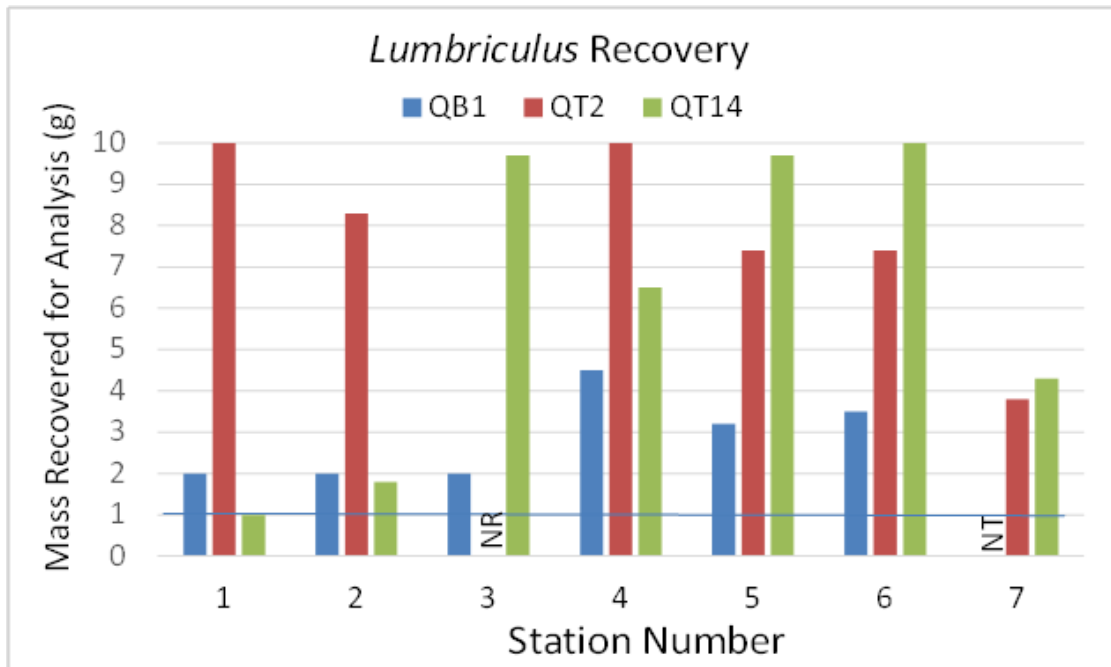

Figure 5-21. Mass of blackworms (*Lumbriculus variegatus*) submitted for tissue analysis from three sampling events at MCB Quantico. Blue line represents target mass required for analytical requirements. NR = none recovered. NT = not tested for the 2012 Baseline event (QB1).

Lumbriculus mass reported in Figure 5-21 does not necessarily reflect actual survival or health of worms. The reported recoveries varied considerably from station to station, and among events, primarily for two reasons: (1) interference with benthic algal mats during the baseline event; and (2) insufficient penetration of the SEA Ring device at a couple of stations (Stations 1 and 2) during the QT14 event (14-month post-remedy).

Baseline conditions at the site hosted a benthic filamentous algae in which the deployed worms were tightly intertwined. Recovery of all worms from these samples would have been an inefficient use of time on site; therefore, in some cases efforts to separate the worms from the algal mats ceased once enough tissue was recovered for required analyses. The algal mats were not present during post-remedy monitoring, and visibly healthy worms were relatively easy to recover from the top few cm of sediment.

Low recovery at Stations 1 and 2 during QT14 is likely associated with difficulty encountered with penetration of the SEA Ring to the desired depth at those stations, which likely contributed to loss (escape) of some worms from the exposure chamber either during the exposure or during the recovery operation.

Replicate Comparison Between In Situ and Laboratory. For the 2012 Baseline event, three of the five SEA Ring cores associated with each species were processed as individual replicates for comparisons of within station variability for both *in situ* and laboratory-based exposures. As with all other events, a subsample from each of the five replicates (or number of replicates containing live organisms at the end of the exposure) was also composited for determination of a single composite sample on a station by station basis.

Sum DDX concentrations, standard deviations, and coefficient of variations (CV) associated with six stations (*in situ*) and four stations (laboratory) are shown for both species evaluated in Figure 5-22. For this comparison, tissues were not-normalized to lipid as lipid values showed some variability among replicates. For *L. variegatus*, the same trend of decreasing uptake in the order of station Q1>Q3>Q5>Q6 was observed both *in situ* and in the laboratory, although the magnitude of uptake was greater in the laboratory. For *C. fluminea*, uptake was marginally higher than the time zero samples *in situ* in the proposed cap area, and lowest for the reference site (Q6), but all site samples were lower than the time zero sample after 14 days in the laboratory exposure.

The CV for *L. variegatus* averaged 30.5 and 37.8 for laboratory and *in situ* exposures, respectively. The CVs for *C. fluminea* averaged 28.8 and 19.9 for laboratory and *in situ* exposures, respectively. T-tests ($\alpha = 0.05$) comparing laboratory and *in situ* CVs resulted in p-values of 0.383 and 0.211, for *L. variegatus* and *C. fluminea*, respectively, indicating no significant differences in replicate variability between the SEA Ring and laboratory exposures. The bulk of the presentation of results for MCB Quantico below, therefore, are expressed using the composite sample data.

In Situ Bioaccumulation Compared with Ex Situ Bioaccumulation. By design, the MCB Quantico baseline study was the most robust dataset for which both field and laboratory data were collected for both test species. Post-remedy monitoring included field data collection per the design under leveraged project #ER-201368. Composite sample bioaccumulation data are shown for four stations for which both *in situ* and laboratory exposures were conducted (Figure 5-23). As alluded to above with replicate samples, a positive relationship among stations was observed ($r^2 = 0.922$ and 0.753 for *L. variegatus* and *C. fluminea*, respectively), with lowest uptake both *in situ* and in the lab for the reference location (Q6). However, the magnitude of uptake differed by as much as a factor of four, with higher DDX concentrations observed in the laboratory for *L. variegatus*, but higher *in situ* for *C. fluminea*. Differences are likely associated with site-specific factors (e.g., food sources, suspended solids, water quality, time-varying contaminant and physical stressors) that differed in the

field while conditions were held constant in the laboratory. The different trends observed for each species may be due to species-specific behavioral factors. For example, *C. fluminea* tends to filter feed from the sediment surface and may have had less direct contact with porewater in the field, while *L. variegatus* tends to deposit feed.

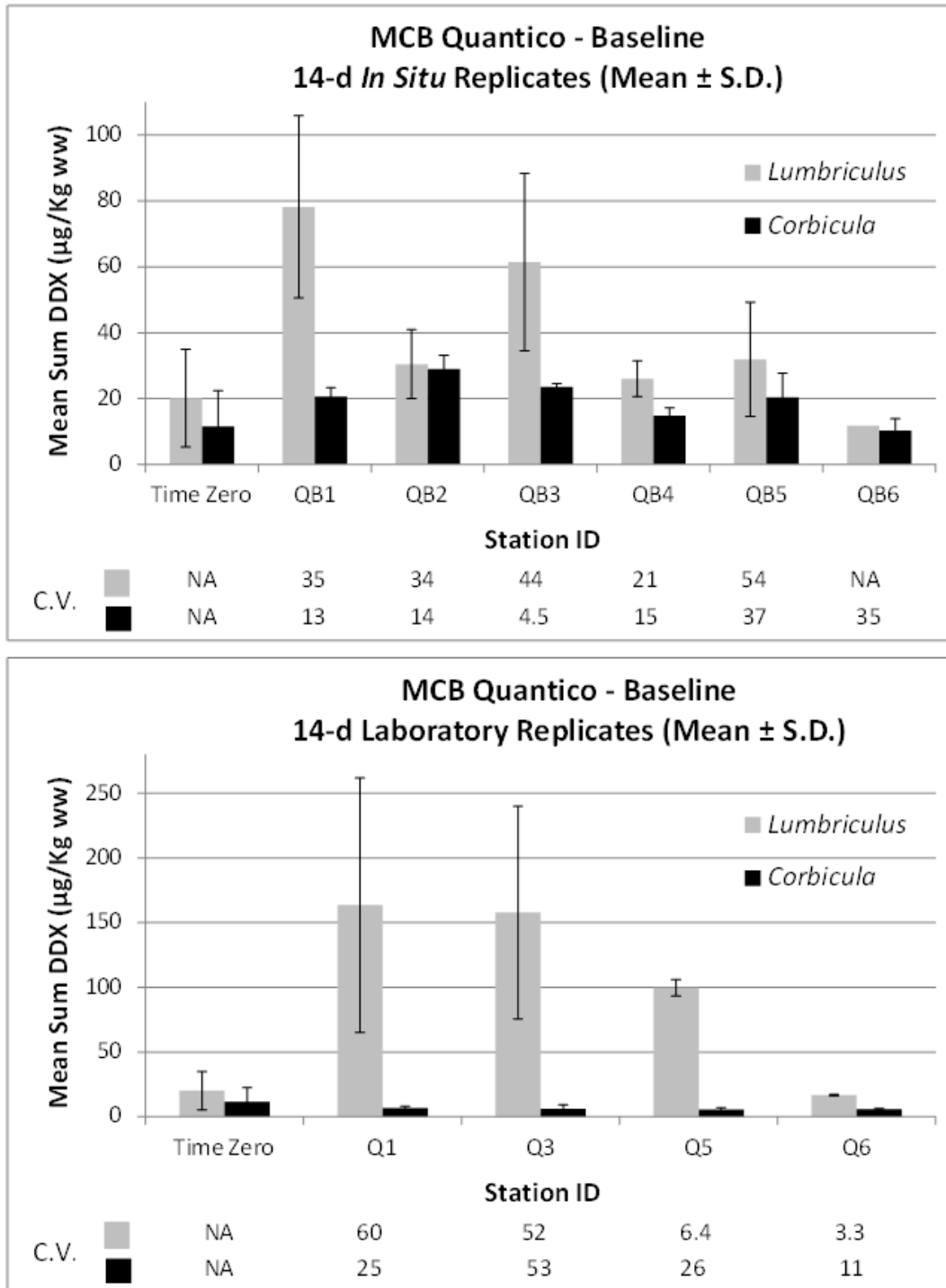

Figure 5-22. Comparison of 14-day bioaccumulation by *Lumbriculus variegatus* (top) and *Corbicula fluminea* (bottom) from *in situ* (top) and laboratory (bottom) exposures from replicate (n = 3) analysis of select cores from MCB Quantico 2012 baseline event. C.V. = Coefficient of variation.

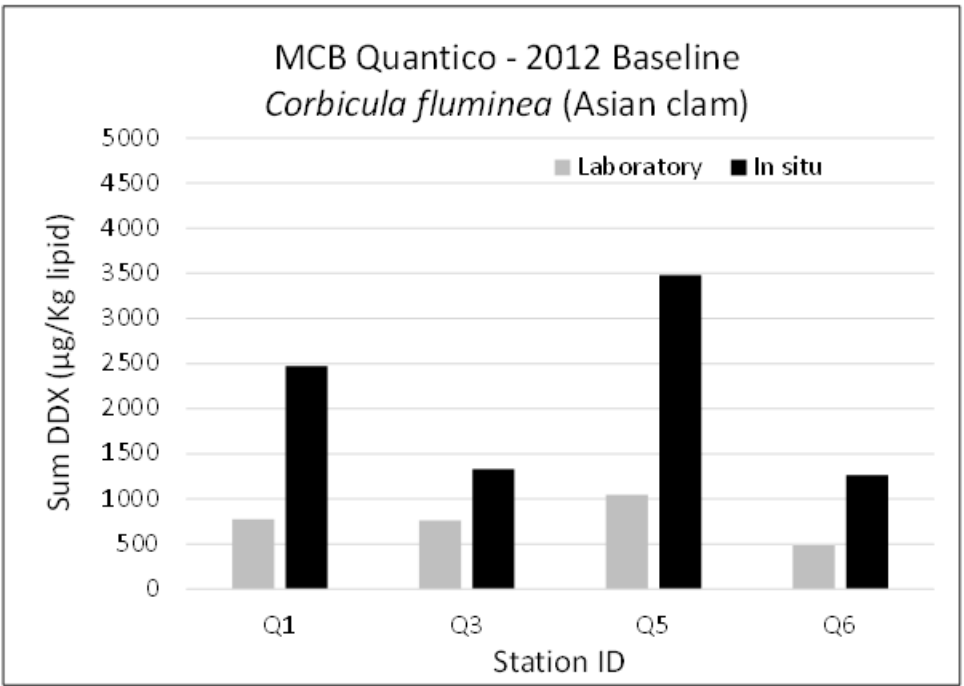
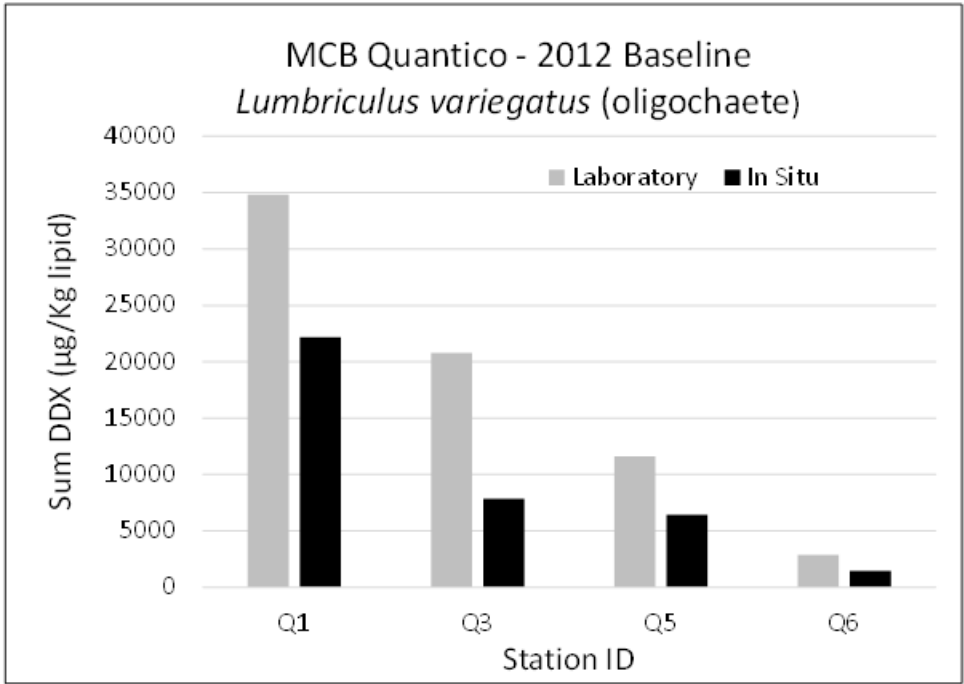

Figure 5-23. Comparison of 14-day bioaccumulation by *Lumbriculus variegatus* (top) and *Corbicula fluminea* (bottom) from laboratory and *in situ* exposures on composites of replicate sediment cores from MCB Quantico 2012 baseline event.

In Situ Comparison Over Time. SEA Rings were used for all three monitoring events at MCB Quantico. Bioaccumulation data for three events, including one baseline (2012) and two post-remedy events, conducted 2 and 14 months post-cap installation in 2014 and 2015, respectively, are shown for both species in Figure 5-24.

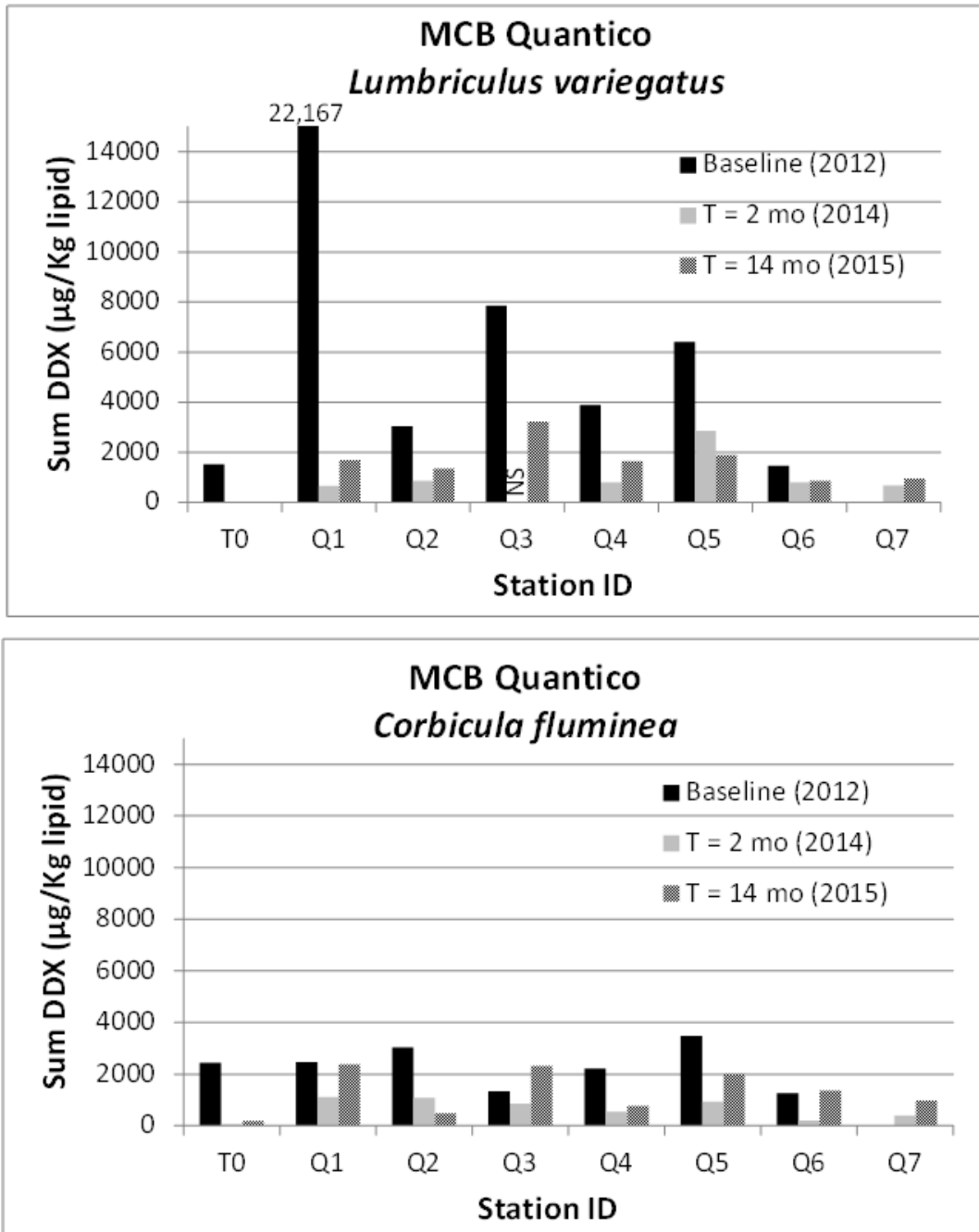

Figure 5-24. Comparison of 14-day bioaccumulation by *Lumbriculus variegatus* (top) and *Corbicula fluminea* (bottom) from three SEA Ring deployments at MCB Quantico between 2012 and 2015. NS = no sample (lost).

The related ESTCP Project (#ER-201368; Kirtay et al., in prep) is evaluating the performance of the remedy at MCB Quantico, but a simple comparison of differences in bioaccumulation over time on as site-wide basis is provided in Figure 5-25 as the mean tissue concentration for the five on-cap stations (Q1, Q2, Q3, Q4, and Q5). A statistical evaluation of remedy performance based on bioaccumulation data is presented by Kirtay et al. (in prep).

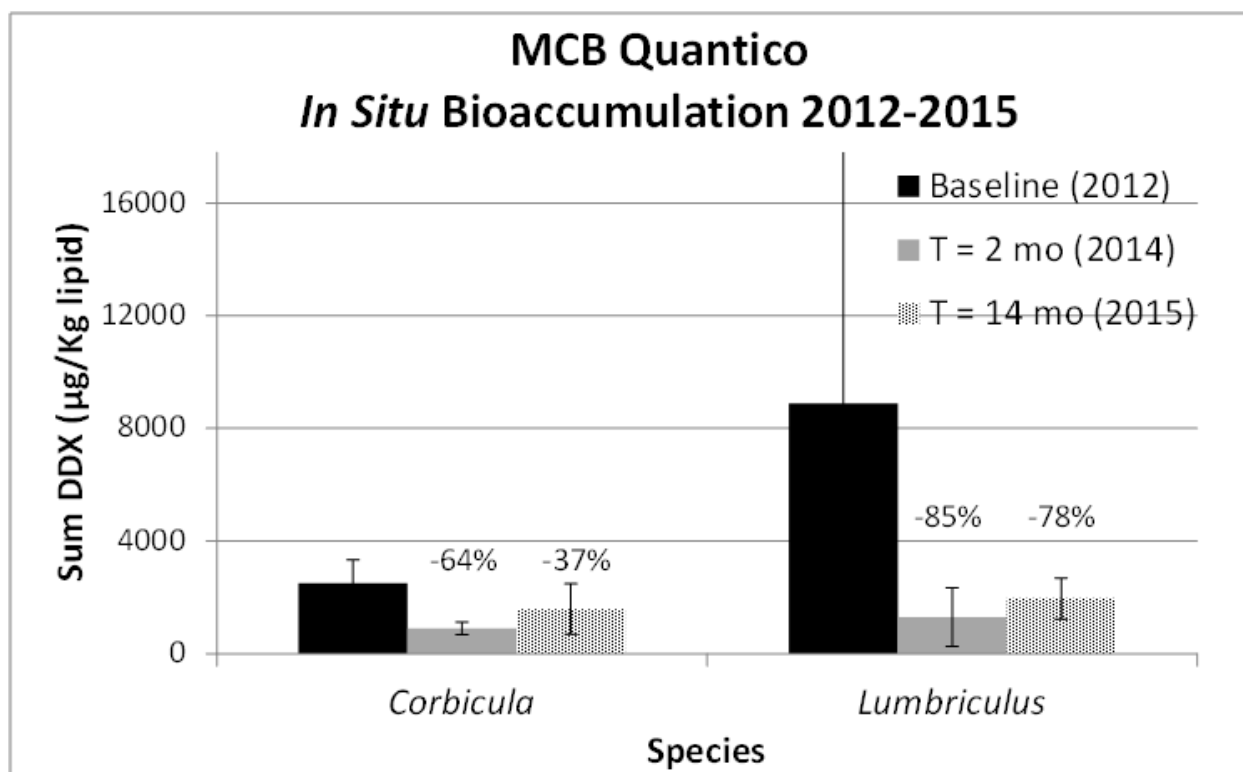
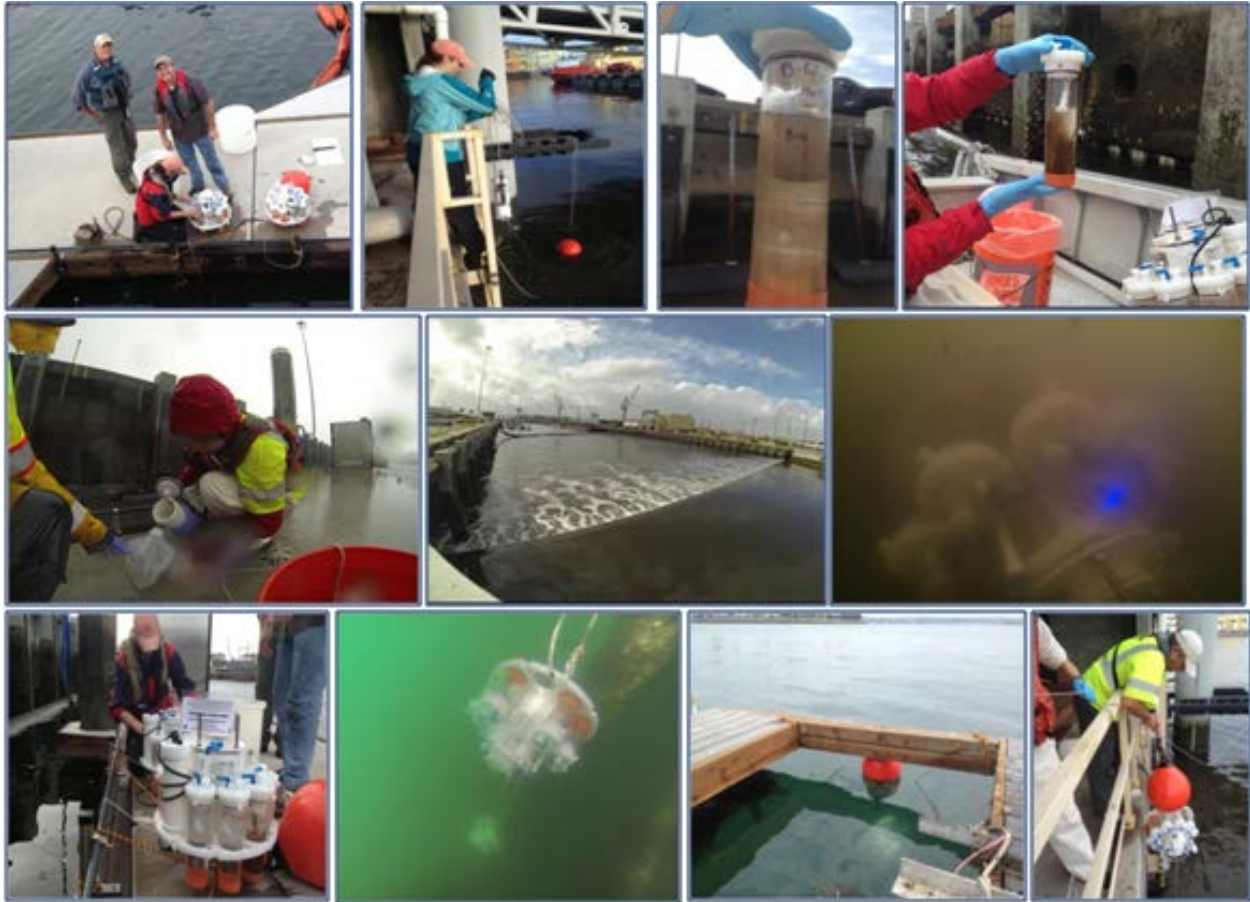

Figure 5-25. Mean (\pm S.D.) 14-day bioaccumulation by *Corbicula fluminea* and *Lumbriculus variegatus* from composite samples from three SEA Ring deployments at MCB Quantico between 2012 and 2015. Values above bars are mean sum DDX % reduction from baseline.

Incorporation of Passive Sampling Devices (SPME). Porewater concentrations were estimated using *ex situ* methods under ER-201368 (data pending final report) and *in situ* (paired with SEA Rings) using SPME provided by Texas Tech University (Dr. Danny Reible). Modified Henry samplers housing 30- or 60-cm lengths of PDMS-coated SPME fibers were deployed with SEA Rings at each station for all three events. The SPME samplers were deployed and recovered by divers concurrent with the SEA Ring deployment, and positioned within a few inches away from the SEA Ring base plate approximately equidistant apart (on opposite sides of the SEA Ring). Due to some differences in the approach used among different sampling events and the in progress status for ER-201368, it is anticipated that these data will be incorporated into the associated report (Kirtay et al., in prep).

5.7.4 Naval Base San Diego



Top row left to right: SEA Ring preparation for deployment at Chollas Creek Site 1; water sampling at Chollas Creek Site 2; recovery of mussel embryos at Chollas Creek Site 1; and deployment of kelp sporophylls near Outfall 13.

Middle row: Storm sampling during heavy rainfall at Chollas Creek Site 1; Chollas Creek runoff 24-hour post storm; and near surface SEA Ring at Chollas Creek Site 1 showing heavy turbidity 24-hours post-storm.

Bottom row: Final SEA Ring prep prior to deployment at Chollas Creek Site 1; SEA Ring setup (1- and 3-meter depth) near Outfalls 13 and 14; SEA Ring deployment at the reference site (SSC Pacific dock near the mouth of San Diego Bay); and SEA Ring deployment at Chollas Creek Site 2.

Figure 5-26. Representative photos of stormwater *in situ* deployment and recovery operations at Naval Base San Diego.

Environmental Exposure Conditions. SEA rings were deployed with test organisms the day before a series of strong winter storms, with 2.47 inches of precipitation recorded during the exposures between February 27 and March 3, 2014. Light rain with a total of 0.12” was recorded during the day on February 27 prior to deploying the test organisms; however, little runoff was observed during this timeframe. Organisms were then exposed to ambient conditions for approximately 12–15 hours prior to the start of rainfall from the main storm front arriving early on February 28. Rainfall was sporadic and very heavy at times over the next 4 days (Figure 5-27).

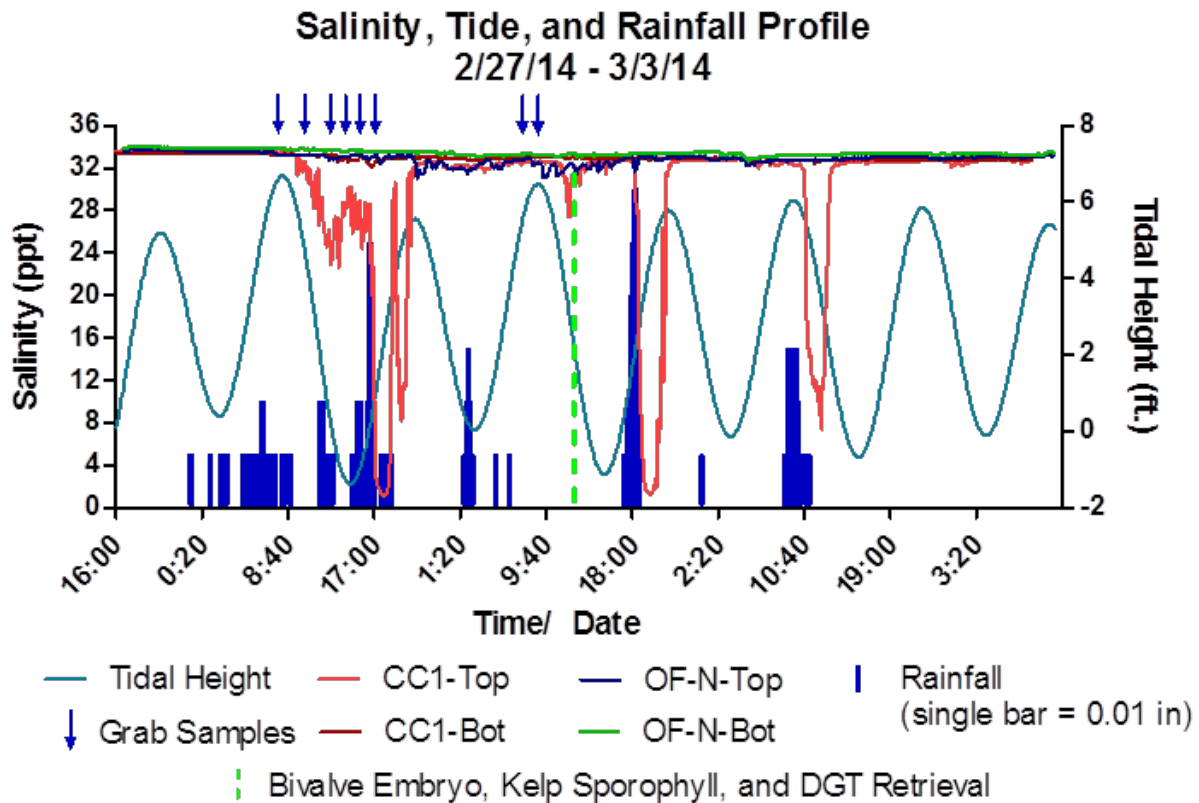

Figure 5-27. Profiles of salinity, tide and precipitation as measured at CC1-T & B and OF-N-T & B. Test organisms were added to the SEA Rings between 14:30 and 17:30 on February 27, 2014, at the beginning of the x-axis on this figure.

Tidal cycles throughout the duration of the deployment were extreme for the San Diego region (spring tides), ranging from a low of -1.7 to +6.7 ft, as shown in Figure 5-27. The SEA Rings were all deployed at a consistent depth of 1 meter below the surface at all sites (top), and 3 meters below the surface at select locations (bottom). A strong freshwater signal was observed at the SEA Ring located near the surface in the channel of Chollas Creek (CC1-T), but only limited reductions in salinity were observed at all other deployment locations at depths where SEA Rings were deployed (Figure 5-27 and Figure 5-28). The presence of freshwater runoff in Chollas Creek was visually apparent with a substantial reduction in water clarity at the surface. This plume was observed beyond Site CC-2 moving out into San Diego Bay. Subsurface video footage showed a dramatic improvement in water clarity in the Chollas Creek channel below the freshwater lens at the halocline. A sharp halocline also was observed at depths ranging from 0.5 meter to 1.0 meters when grab samples were collected during the approximate 24-hour sampling period after runoff began. Often, the salinity profile was abrupt between brackish (15–25 ppt) and ambient marine (32–34 ppt) within a 2–4 cm or so band. A thermocline was also associated with the change in salinity at the same depths, ~17.5–18 °C in ambient seawater and 15.5 °C in the freshwater lens. Salinity and temperature profiles were similar just outside the mouth of Chollas Creek at Site CC-2, though the depth of the halocline was reduced, and greater mixing was apparent (Figure 5-27 and Figure 5-28). Despite an intense storm with heavy runoff, the freshwater influence observed near the monitored outfalls along the quay wall was primarily limited to surface samples only (top 0–4 cm), with the lowest salinity reading of 29 ppt nearest the outfall (Site OF-N). Minor transient dips in salinity of 1–2 ppt from ambient conditions

were observed at the top SEA Ring 1 meter below the surface, as shown in Figure 5-28. At the end of Pier 6 at NBSD (OF-F), little to no freshwater signal was apparent, even at the surface during the storm.

Dissolved oxygen and temperature at the 3-meter depth were continuously monitored over the 4-day period, and did not differ between the Chollas Creek or adjacent to the Outfall at NBSD (Figure 5-29).

Another significant observation was related to the intensity of the storm at times, with heavy wind and resulting rough surface conditions in the bay, particularly at the end of Pier 6 and along the exposed quay wall where the outfalls are located. These conditions also likely had a substantial influence on stormwater mixing dynamics in the bay.

As shown and observed, the dynamics between rainfall duration, timing and intensity, runoff, and tides, and subsequent freshwater influence in the marine environment are highly interrelated and complex. After the initial rainfall, there is a lag time before runoff occurs, depending on rain intensity, watershed characteristics, and surface imperviousness. Runoff was almost immediate following initial rainfall from the outfalls along the quay wall, but was not measureable in the Chollas Creek channel for several hours thereafter until the tide began to drop. In the marine environment a freshwater lens may develop with subsequent vertical and horizontal mixing as the plume spreads out as observed at the mouth of Chollas Creek. As shown in the channel at Chollas Creek (CC1-T), low salinity conditions followed multiple pulses of rainfall, but the duration was limited to only a few hours at any given time at 1-meter depth. The interplay between runoff and tides results in extremely dynamic and transient conditions. Conditions have been documented to vary substantially with different rainfall patterns and tidal cycles as shown in previous monitoring studies performed at the mouth of Chollas Creek (Schiff, Bay and Diehl, 2001).

These dynamics highlight the substantial challenges related to capturing a single “representative” sample for testing the effects of stormwater runoff in a laboratory setting, and the substantial need for more realistic *in situ* testing methods.

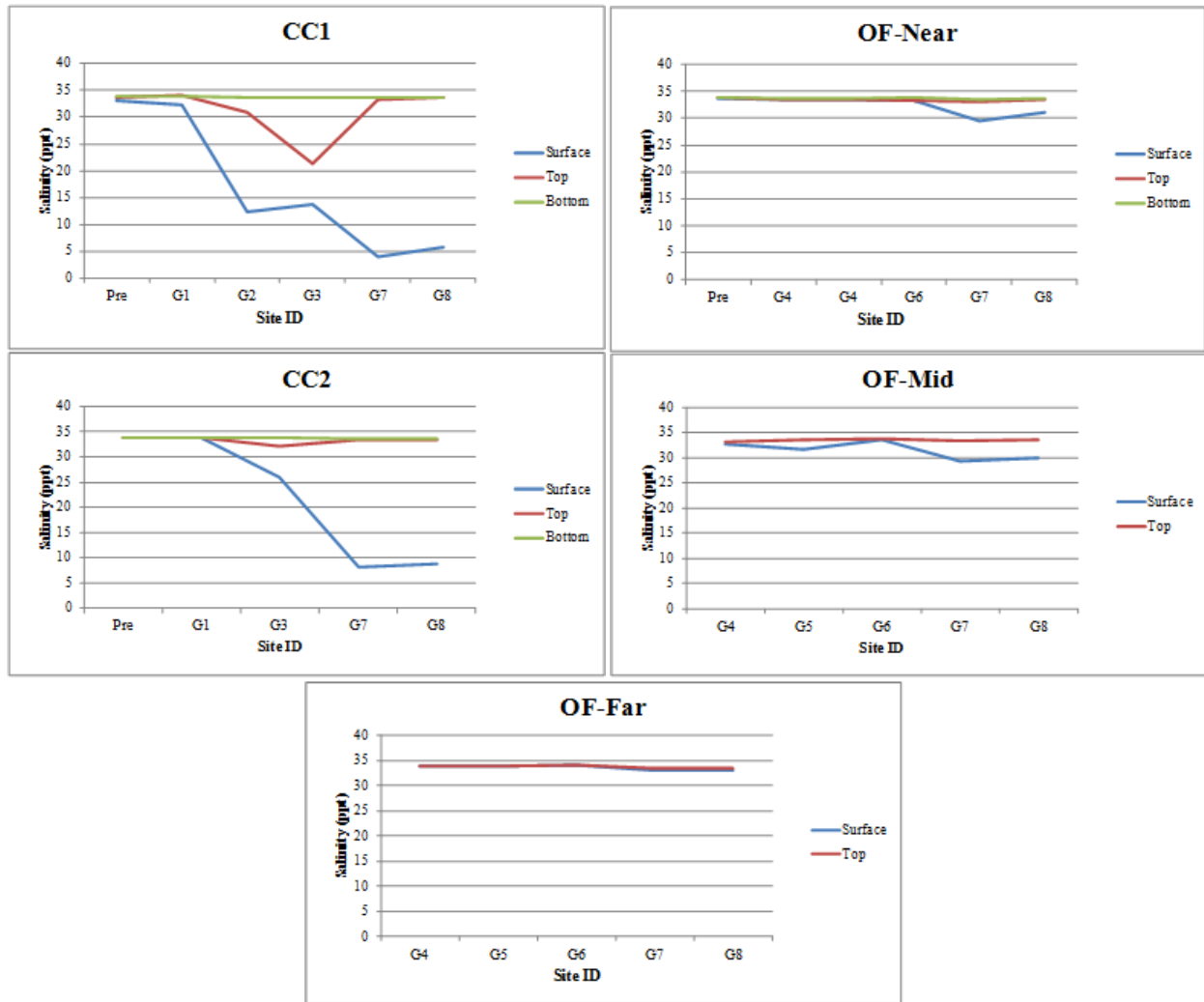

Figure 5-28. Profiles of salinity measured *in situ* during discrete grab sample times at each SEA Ring location.

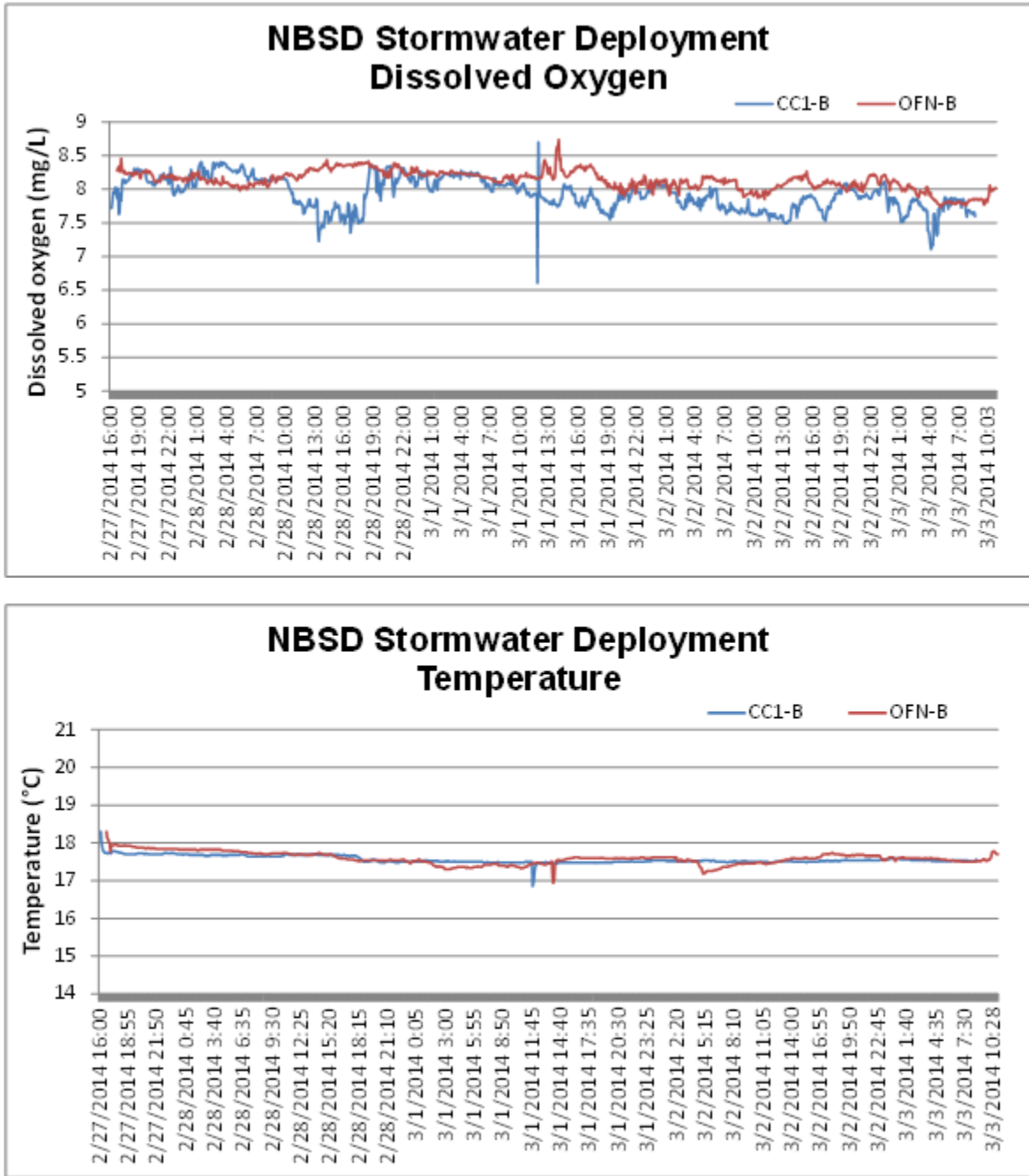

Figure 5-29. Continuous measurements of dissolved oxygen and temperature in SEA Ring chambers placed at 3-meter depth at Chollas Creek mouth (CC1-B) and adjacent to outfall OF-N.

SEA Ring Deployment, Recovery, and Performance. Deployment and recovery of the SEA Rings and test organisms was successful at all nine targeted locations. This demonstration proved the SEA Ring as a valid implementable tool for stormwater assessment, as shown with the predecessor passive version used for compliance monitoring off SIO over the past 5 years (AMEC, 2010–2014a, b).

In Situ Toxicity Results. A summary of results for all *in situ* toxicity tests is shown in Figure 5-30. Individual species results for *in situ* and laboratory-based results for mysid shrimp and bivalve embryos are shown in Figure 5-31. *In situ* test results for kelp germination and growth are shown graphically in Figure 5-32.

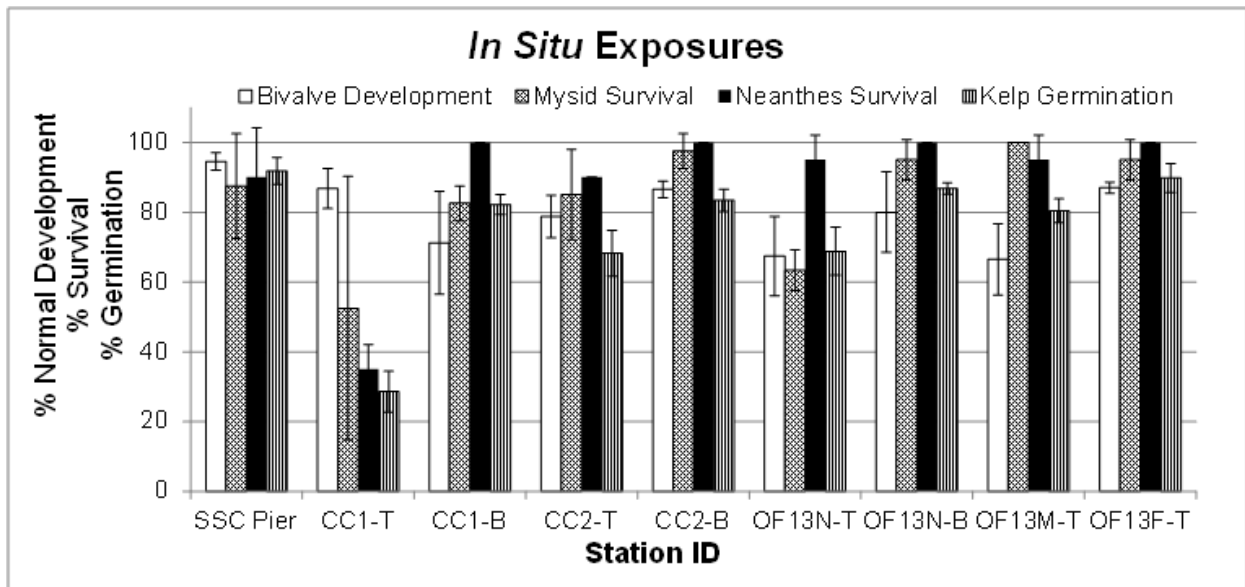

Figure 5-30. Results from the *in situ* SEA Ring exposures for all species tested.

Notably, all toxicity tests met applicable laboratory-based control performance criteria in SEA Rings placed *in situ* at reference locations (e.g., SSC Pacific Pier and OF-F) expected to be minimally impacted by runoff. This observation provides additional confidence that SEA Rings performed well and provided an environment conducive of sustaining healthy organism throughout the exposure periods.

Bivalve embryos, kelp blades and DGTs were exposed to a single large pulse of runoff over the 48-hr exposure period, whereas mysid shrimp and *Neanthes* were exposed to 3 large pulses of rainfall over the 96-hour exposure period (Figure 5-27). Results from each site were compared against those for OF-F as a nearby reference location. The SEA Ring located at the SSC Pacific dock was also considered a “reference” location, though environmental conditions given the close proximity to the mouth of the bay are different than that in the central portion of the bay at NBSD. Single pair-wise statistical comparisons between results at OF-F and all other sites were performed using the EPA Test for Significant Toxicity (TST) method (USEPA 2010). Results for these tests are presented in Table 5-12.

General trends were similar among the four species though some notable differences were also observed. The greatest effects to survival of mysid shrimp and *Neanthes*, and germination of spores from giant kelp occurred in the SEA Ring most directly influenced by stormwater runoff at the surface in the Chollas Creek channel (CC1-T). Effects for these three species ranged from only 32 to 55% of the reference location (OF-F). Bivalve embryos showed no effect in the top SEA Ring at this location, but did show a slight statistically significant effect (84% of OF-F) in the bottom SEA Ring (CC1-B). Mysid shrimp and kelp also showed significant adverse responses in the top SEA Rings at Site CC-2 and nearest the outfalls (OF-N), though to a lesser degree, ranging from 67 to 90% relative to OF-F. Bivalve embryos also showed a significant effect at OF-N-T (78% of OF-F), and was the

only species to show an effect at Site OF-M-T with a similar response (76% of OF-F). No sites were observed to be significantly lower from OF-F for the kelp spore growth endpoint.

Mussel Embryo Development

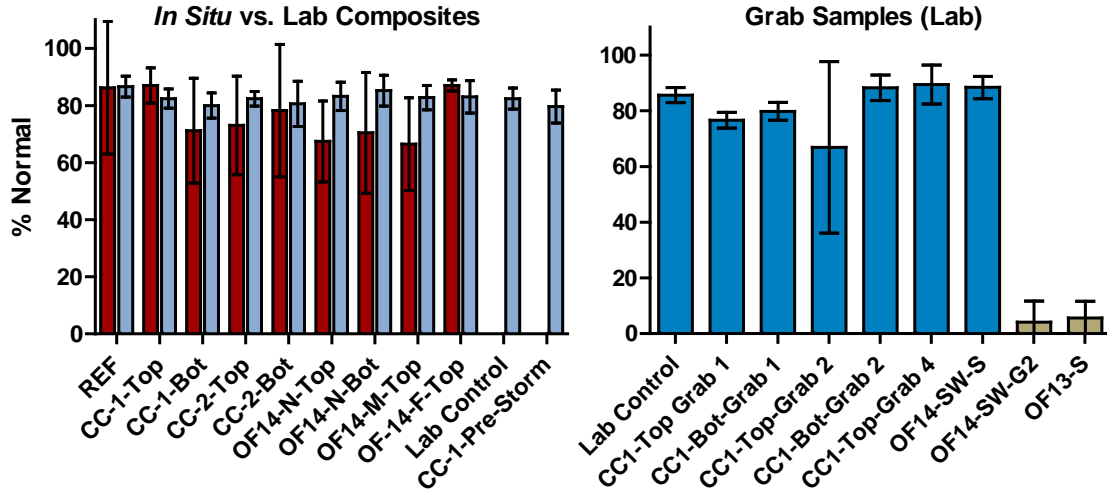

Mysid Survival

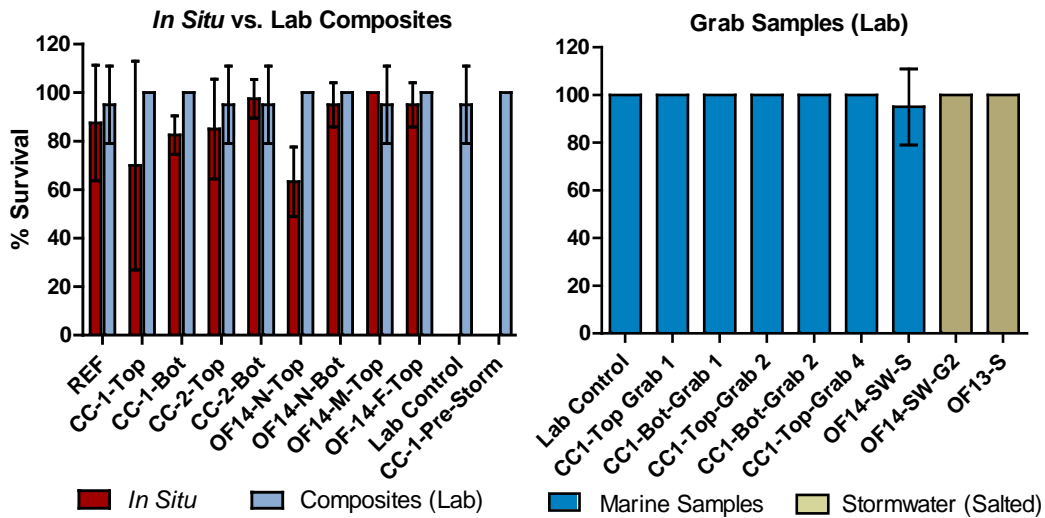

Figure 5-31. Individual species results for *in situ* and laboratory-based results for bivalve embryos and mysid shrimp, (Mean values \pm 95% CI).

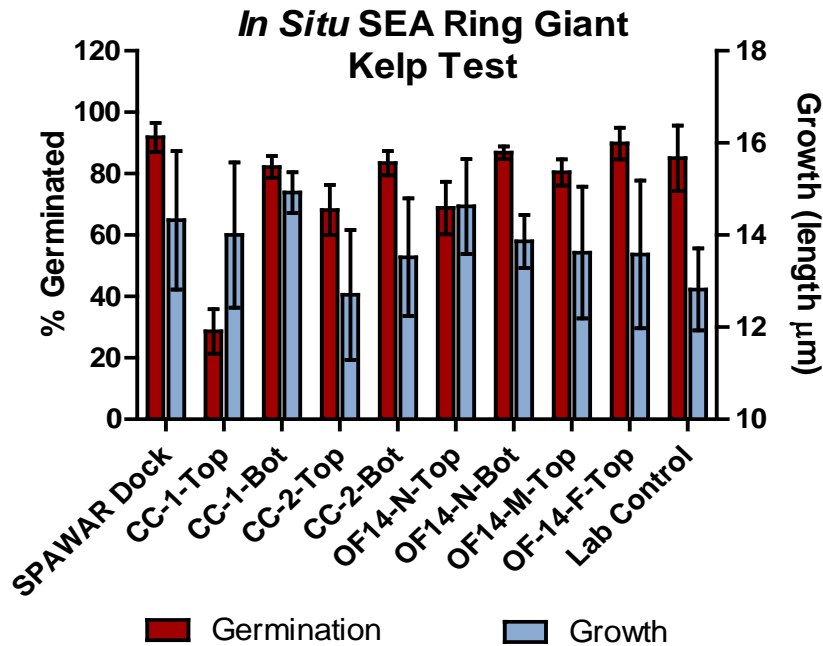

Figure 5-32. Results for *in situ* exposures for kelp (*Macrocystis pyrifera*) germination and growth (Mean values ±95% CI).

Table 5-12. *In situ* SEA Ring toxicity test results relative to results from Reference Site OF-Far.

Site	Species/ Endpoint Results Shown as % of OF-Far				
	Bivalve Embryo Development	Mysid Survival	<i>Neanthes</i> Survival	Kelp Germination	Kelp Growth
SSC Pacific REF	109	92	90	102	105
CC-1-T	100	55	35	32	103
CC-1-B	82	87	100	92	110
CC-2-T	91	90	90	76	94
CC-2-B	99	103	100	93	100
OF-N-T	78	67	95	77	108
OF-N-B	92	100	100	97	102
OF-M-T	76	105	95	90	100

*Values in **bold** are significantly reduced from the respective reference site (OF-F for Grab and Composite Samples (USEPA TST, 2010, EPA 833-R-10-003).

Values > 100 indicate a greater response in the SEA Ring site relative to that observed at OF-F.

The freshwater doses experienced at the CC1-T SEA Ring were likely sufficient to cause the observed responses at this location. A study by Weston (2011) found that a reduced salinity to 10 ppt or less for a period of 6 hours affected survival of *A. bahia*, with few to no survivors following exposure to 6 ppt for the same timeframe. Given that *A. bahia* is known to tolerate brackish salinities, it is highly likely that fully marine giant kelp and *Neanthes* would also be affected by the pulses of fresh water observed at CC-1-T, and possibly CC-2-T. Direct transfer of *Neanthes* from saline to salinities of 15 to 20 ppt have been shown to have significant effects on mortality and growth (Dillon et al., 1993). Though published salinity tolerance data does not appear to exist for kelp, kelp spores

degrade quickly when exposed to reductions in salinity (Stransky, personal observations). Salinity tolerance studies recently conducted for the City of San Diego have found that the marine kelp shrimp *Holmesimysis costata* is very sensitive to brief reductions in salinity, resulting in zero percent acute survival following exposure to a salinity of 20 ppt for only 30 minutes (AMEC, 2015). The sensitivity of bivalve embryos (*M. galloprovincialis*) depends on when the developing embryos are dosed. The embryos are sensitive to a moderate reduction in salinity between 22 and 25 ppt if dosed for a period of 2 to 3 hours soon after cell division, but are insensitive at salinities down to 15 ppt for up to 3 hours if dosed approximately 20 hours post-cell division (AMEC, 2015). A high proportion of normal embryos exposed to the reduced salinity at CC1-T suggest that they had surpassed a developmental stage where they were particularly sensitive to salinity decreases. Indeed, bivalve embryos were approximately 16 to 18 hours post-initial cell division by the time the first noticeable freshwater influence occurred in the Chollas Creek channel.

With the exception of those results for CC1-T, observed significant effects at other locations among all three species was limited to less than a 33% difference from that observed at OF-F. Test organisms in SEA Rings at CC-2-T and OF-N-T may have been affected by the restricted flow created by these two units being plumbed backwards, which resulted in air space remaining in some of these test chambers. This could have presented a physical stressor on the test organisms associated with the turbulence during the storm and resulting sloshing in the chambers. *In situ* video footage documented this issue during the study.

The potential cause for observed effects to bivalve embryos in properly operating SEA Rings at Sites CC-1-B and OF-M-T is uncertain, though effects were limited with a difference of 18 and 24%, respectively, relative to embryo development at OF-F.

Laboratory-Based Toxicity Results. Laboratory-based tests were performed as a part of the demonstration at NBSD to:

1. Provide a standard for QA/QC by which to assess test organism sensitivity and performance under controlled laboratory conditions to a reference toxicant test and field collected samples;
2. Compare general patterns and conclusions derived from standard discrete sampling and composite preparations to that determined using the *in situ* methods with the SEA Rings.

Given the known dynamics for stormwater runoff, there is an expectation that no individual grab samples, nor 24-hour composites, will accurately represent exposure *in situ* over 48 to 96 hours. Comparisons between the two methods herein are thus qualitative only without statistical analyses. The primary goal was to assess the ability of the SEA Rings to operate successfully and provide robust and quality data.

Laboratory toxicity test methods using bivalve embryos and mysid shrimp followed standard EPA (1995 and 2002) and ASTM (1999) protocols. Acute survival of *Neanthes* followed the EPA and ASTM methods as well, though this species is not identified specifically in these protocols. The kelp assay was conducted only for *in situ* exposures, though laboratory-based methods are required to germinate and grow out spores exposed in the field. This is a modified EPA (1995) method (Cibor et al., 2014). summaries of the toxicity test methods are included in Appendix G

A complete summary of laboratory-based results for bivalve embryos, mysid shrimp, and *Neanthes* is provided in Table 5-13 through Table 5-15 Concurrent laboratory controls and reference toxicant tests were included for all assays, and all tests met applicable protocol QA/QC procedures.

In summary, effects were not observed with any species tested in grab and composite samples from the receiving water with the exception of a single grab sample (Grab 2) collected at Site CC2-T

using bivalve embryos. Despite a statistically significant difference in this one sample, the effect was limited, a 12 and 16% reduction from the laboratory control and the OF-F Grab 1 sample, respectively. The overall lack of laboratory-based effects observed in the receiving water during storm events is consistent with the limited effects observed in a prior large stormwater assessment project conducted by SSC Pacific in San Diego Bay (Katz et al., 2006).

Laboratory-based results contrast from data derived from the SEA Ring that found a slight effect on mussel embryo development at CC1-B and OF-M-T. The effects observed *in situ* for mysids and *Neanthes* exposed at CC-1-T also contrasts with the laboratory-based tests that found no effect. This result, as described in Section 5.7.3 above, is likely due to the reduced salinity at this location. Grab samples for toxicity testing in the laboratory just happened to occur when a lowered salinity signal was not present at the SEA Ring depth.

In contrast to receiving water samples, tests of salinity-adjusted undiluted stormwater from OF13 and 14 caused substantial impairment to bivalve embryos (<10% normal development). However, no acute survival effects were observed to mysid shrimp or *Neanthes* exposed to the salinity-adjusted stormwater grab samples. The results observed for bivalve embryos were consistent with that observed in prior studies with more than 50% of samples resulting in chronic effects to marine invertebrates (Katz et al., 2006, and AMEC, 2006–2014 Wet Weather Monitoring Reports for UCSD SIO).

Note, however, that the sampling period of undiluted stormwater in this study differed from that required under typical end-of-pipe NPDES monitoring requirements (first-flush within 1–4 hours of runoff). The intended first-flush sample from OF14 (Grab-1) was collected during the first-flush (<1 hour post-rainfall) from the outfall through a manhole cover at high tide on 2/28/14 at 14:50. Due to an extreme high tide at the time, the sample was unexpectedly marine with a salinity of 33.5 ppt. A second sample (G-2) collected in the afternoon on the same day at 14:00 was freshwater with a salinity of 0.2 ppt. For comparison, an additional undiluted stormwater sample was collected from nearby OF13 on 28 February 2014 at 17:30. These two samples were collected approximately 13–15 hours post-initial rainfall, well beyond the first-flush, which many studies have found to contain greater contaminant concentrations and toxicity (Katz et al., 2006; Kayhanian et al., 2008). It is likely that the extended runoff period and heavy rainfall reduced contaminant concentrations observed in this study relative to what might have been observed during the first-flush.

Table 5-13. Laboratory-based results summary for bivalve embryo development.

Test Group	Sample ID	Mean % Normal	SD	Test Group	Sample ID	Mean % Normal	SD
Pre-storm	CC1-T-Pre	80	4.4	Composite Samples	CC1-T-COMP	82	2.8
	CC2-T-Pre	83	6.6		CC1-B-COMP	80	3.2
	OF-N-T-Pre	86	1.4		CC2-T-COMP	82	1.9
	REF-T-Pre	80	6.2		CC2-B-COMP	81	6.2
RW Grab #1 samples	CC1-T-G1	77	2.4		OF-N-T-COMP	83	4.0
	CC1-B-G1	80	2.6		OF-N-B-COMP	85	4.3
	CC2-T-G1	78	3.7		OF-M-T-COMP	83	3.4
	CC2-B-G1	79	2.4		OF-F-T-COMP	83	4.7
	OF-N-T-G1	85	3.9		REF-T-COMP	87	3.0
	OF-N-B-G1	83	2.7				
	OF-M-T-G1	87	2.5				
	OF-F-T-G1	83	3.1				
	REF-T-G1	79	2.5				
RW Grab 2 and four samples	CC1-T-G2	67	25				
	CC1-B-G2	79	0.9				
	CC1-B-G2 Dup	88	3.7				
	CC1-T-G4	90	5.7				
SW samples	OF13-SW-G1^a	5.5	5.0				
	OF14-SW-G1 ^b	88	3.4				
	OF14-SW-G2^b	4.2	6.1				

Values in bold are significantly reduced from the respective reference site (OF-F for Grab and Composite Samples (USEPA TST, 2010, EPA 833-R-10-003).

^a The undiluted stormwater sample from OF13 (salinity of 0.1 ppt) was collected in the evening on 2/28/14 at 17:30, approximately 15 hours post-initial rainfall on the same date.

^b Sample 1 from OF14 (G-1) was collected during the first-flush rain from the outfall through a manhole cover on 2/28/14 at 14:50. Due to an extreme high tide, the sample was unexpectedly marine with a salinity of 33.5 ppt. A second sample (G-2) collected in the afternoon on the same day at 14:00 was freshwater with a salinity of 0.2 ppt.

RW = Receiving water

SW = Stormwater

Table 5-14. Laboratory-based results summary for mysid survival.

Test Group	Sample ID	Mean % Survival	SD	Test Group	Sample ID	Mean % Survival	SD
Pre-storm	CC1-T-Pre	100	0	Composite samples	CC1-T-COMP	100	0
	CC2-T-Pre	100	0		CC1-B-COMP	100	0
	OF-N-T-Pre	95	10		CC2-T-COMP	95	10
	REF-T-Pre	80	23		CC2-B-COMP	95	10
RW Grab #1 samples	CC1-T-G1	100	0		OF-N-T-COMP	100	0
	CC1-B-G1	100	0		OF-N-B-COMP	100	0
	CC2-T-G1	100	0		OF-M-T-COMP	95	10
	CC2-B-G1	100	0		OF-F-T-COMP	100	0
	OF-N-T-G1	90	20		REF-T-COMP	95	10
	OF-N-B-G1	100	0				
	OF-M-T-G1	95	10				
	OF-F-T-G1	100	0				
	REF-T-G1	100	0				
RW Grab #2 and four samples	CC1-T-G2	100	0				
	CC1-B-G2	100	0				
	CC1-T-G4	100	0				
SW samples	OF13-SW-G1 ^a	100	0				
	OF14-SW-G1 ^b	95	10				
	OF14-SW-G2 ^b	100	0				

^a The undiluted stormwater sample from OF13 (salinity of 0.1 ppt) was collected in the evening on 2/28/14 at 17:30, approximately 15 hours post-initial rainfall on the same date.

^b Sample 1 from OF14 (G-1) was collected during the first-flush rain from the outfall through a manhole cover on 2/28/14 at 14:50. Due to an extreme high tide, the sample was unexpectedly marine with a salinity of 33.5 ppt. A second sample (G-2) collected in the afternoon on the same day at 14:00 was fresh water with a salinity of 0.2 ppt.

RW = Receiving water

SW = Stormwater

Table 5-15. laboratory-based results summary for *neanthes* survival.

Test Group	Sample ID	Mean % Survival	SD	Test Group	Sample ID	Mean % Survival	SD
Pre-storm	CC1-T-Pre	100	0	Composite samples	CC1-T-COMP	95	7.1
	CC2-T-Pre	100	0		CC1-B-COMP	100	0
	OF-N-T-Pre	100	0		CC2-T-COMP	95	7.1
	REF-T-Pre	100	0		CC2-B-COMP	95	10
RW Grab #1 samples	CC1-T-G1	100	0		OF-N-T-COMP	100	0
	CC1-B-G1	100	0		OF-N-B-COMP	100	0
	CC2-T-G1	100	0		OF-M-T-COMP	95	10
	CC2-B-G1	95	7.1		OF-F-T-COMP	100	0
	OF-N-T-G1	95	7.1		REF-T-COMP	95	10
	OF-N-B-G1	100	0				
	OF-M-T-G1	100	0				
	OF-F-T-G1	100	0				
	REF-T-G1	100	0				
RW Grab 2 & 4 samples	CC1-T-G2	100	0				
	CC1-B-G2	95	7.1				
	CC1-T-G4	100	0				
SW samples	OF13-SW-G1 ^a	95	7.1				
	OF14-SW-G1 ^b	95	7.1				
	OF14-SW-G2 ^b	100	0				

^a The undiluted stormwater sample from OF13 (salinity of 0.1 ppt) was collected in the evening on 2/28/14 at 17:30, approximately 15 hours post-initial rainfall on the same date.

^b Sample 1 from OF14 (G-1) was collected during the first-flush rain from the outfall through a manhole cover on 2/28/14 at 14:50. Due to an extreme high tide, the sample was unexpectedly marine with a salinity of 33.5 ppt. A second sample (G-2) collected in the afternoon on the same day at 14:00 was fresh water with a salinity of 0.2 ppt.

RW = Receiving water

SW = Stormwater

Analytical Chemistry Receiving Water. As described previously, a limited suite of analytical measurements were performed to assess magnitude of influence for previously identified COPCs in stormwater runoff to San Diego Bay, trace metals, and PAHs. A complete summary of these measurements, along with DOC and TSS, are provided in Appendix F. Of those measurements recorded, only dissolved copper was found to exceed national ambient marine water quality (<http://water.epa.gov/scitech/swguidance/standards/criteria/current/index.cfm>), an acute value of 4.8 µg/L and chronic value of 3.1µg/L. Measured concentrations of dissolved copper during the stormwater demonstration ranged 3.7 to 11 µg/L (mean of 4.8 µg/L) among all receiving water samples tested (individual grabs and 24-hour composites) in the Chollas Creek channel and off NBSD. The greatest concentration was noted during collection of the first grab sample at the innermost location in the Chollas Creek channel (Site CC1-T). For comparison, dissolved concentrations of copper ranged from 4.3 to 4.8 µg/L in the three pre-storm receiving water samples collected in the same area, and was 3.2 µg/L at the SSC Pacific dock near the mouth of San Diego Bay.

Measured concentrations of dissolved zinc (another commonly identified constituent of concern in stormwater runoff) in all samples from San Diego Bay, were below EPA acute and chronic criteria of 90 and 81 µg/L, respectively. Concentrations of dissolved zinc ranged from 10 to 32 µg/L in all samples from the Chollas Creek channel and off NBSD. This compares to pre-storm sample

concentrations off NBSD ranging from 18 to 27 $\mu\text{g/L}$, and a concentration of 14 $\mu\text{g/L}$ at the SSC Pacific dock near the mouth of San Diego Bay.

Dissolved concentrations of Ni and Pb measured in select receiving water composite samples also did not exceeded toxic concentrations of concern (Appendix F).

DGTs Compared to Receiving Water Composites. Time-weighted average labile concentrations of trace metals were measured by mounting DGTs both inside and outside a single test chamber on each SEA Ring for another more integrated measure of exposure to trace metals. Measured dissolved concentrations of copper and zinc in 24-hour receiving water composite samples relative to time-weighted values derived from the DGTs inside and outside the SEA Ring test chambers are shown in Figure 5-33. All data, including that for nickel and zinc, are provided in Appendix F. Labile copper and zinc concentrations closely mimicked spatial trends observed for composites of the eight grab samples collected at each station, but DGT concentrations were consistently lower. DGT copper averaged 43 and 56% of the dissolved composite value inside and outside the SEA Rings, respectively. DGT zinc averaged 71 and 76% of the composites, respectively. Correlations were statistically significant ($p < 0.05$) for all comparisons, with the exception of Inside DGTs for copper (Figure 5-34). These results are expected as the DGT provides a labile metal concentration that is typically a fraction of the operationally defined dissolved ($< 0.45 \mu\text{m}$) fraction (Zhang and Davison, 1995). These results provide confidence that the exposure conditions inside the SEA Rings were similar to ambient conditions outside, while also successfully demonstrating the ability to integrate passive sampling technologies to better match *in situ* toxicity and chemical exposures.

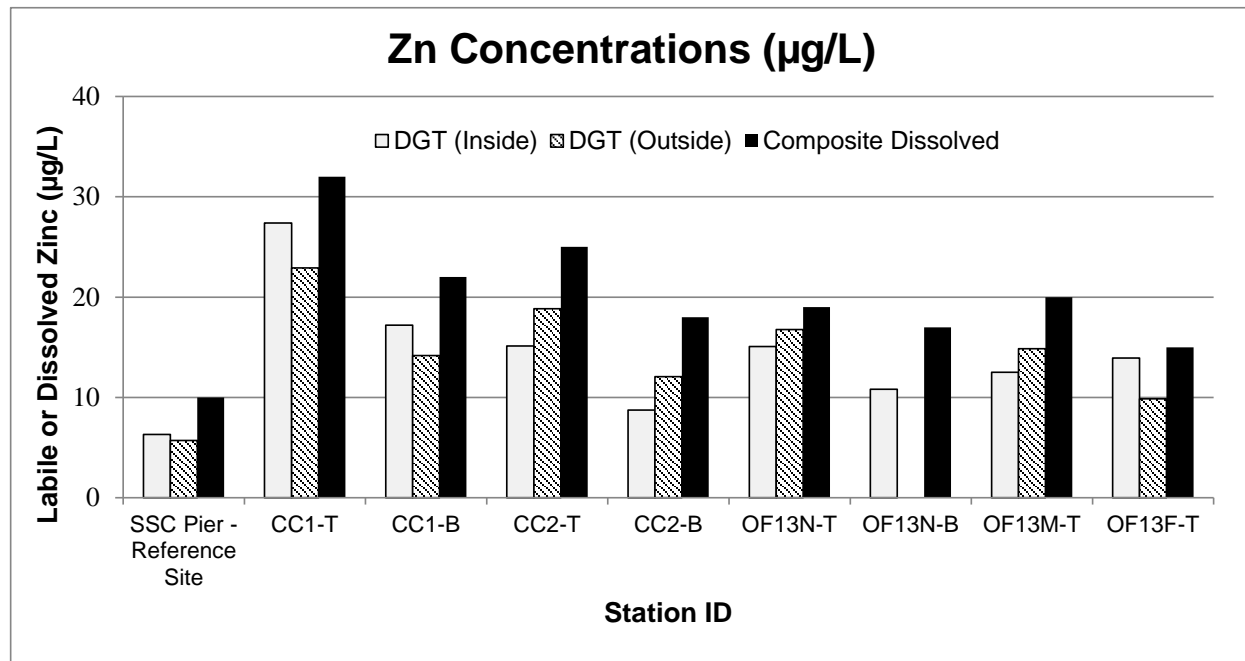
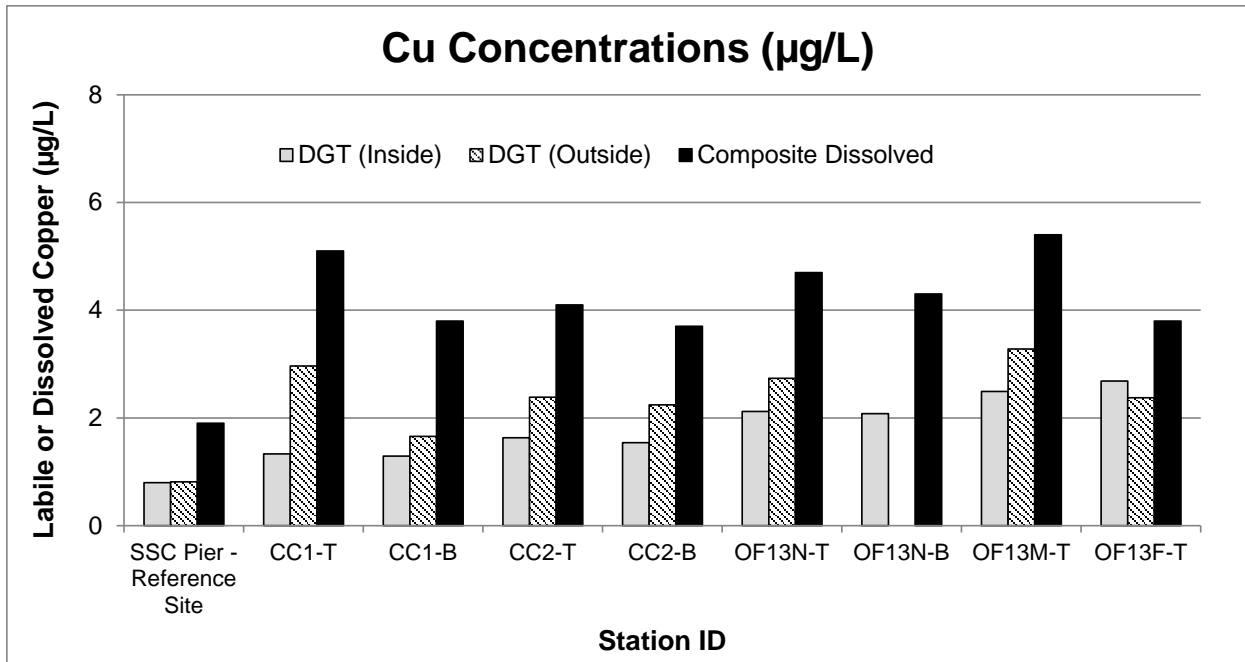

Figure 5-33. Copper (upper) and zinc (lower) concentrations measured in DGTs inside and outside the exposure chambers, and measured as dissolved from 24-hour composite samples. Note: The outer DGT was lost for Station OF 13N-B.

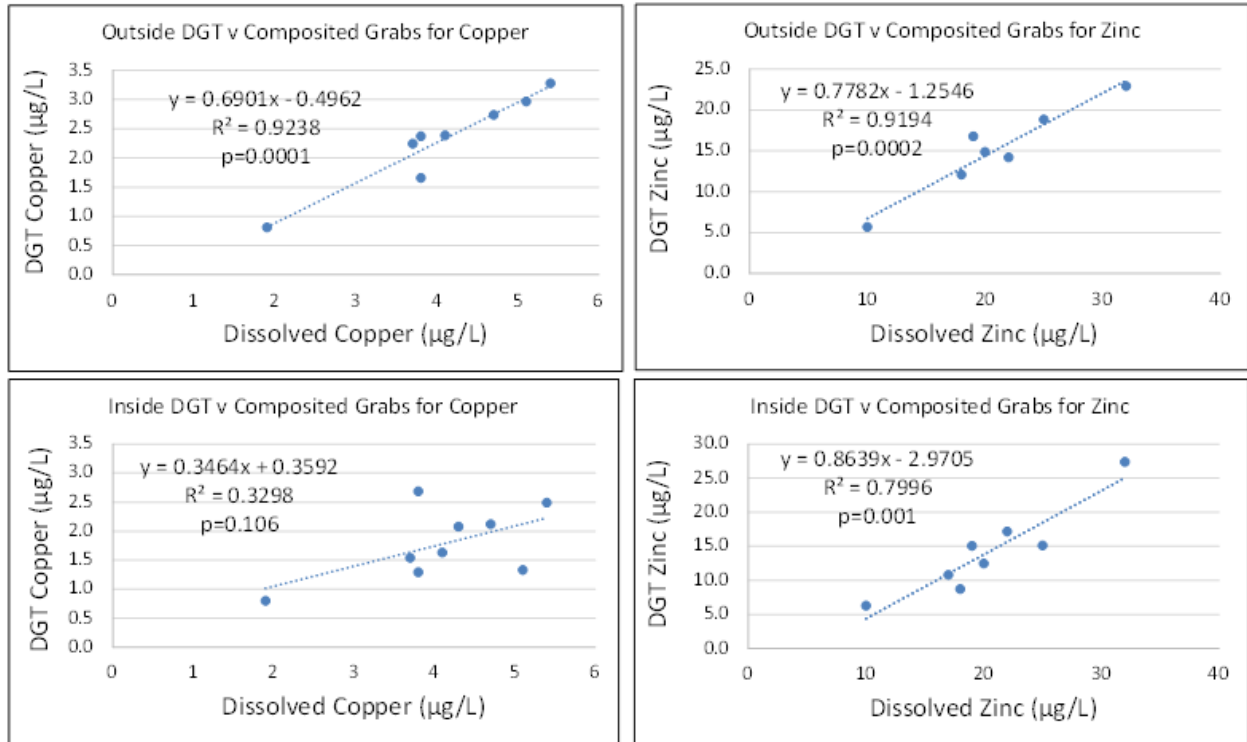

Figure 5-34. Comparison of DGTs deployed outside and inside SEA Rings with dissolved copper and zinc derived from composite grab samples at nine stations during storm event.

Analytical Chemistry: Stormwater. Samples of stormwater from OF13-SW-G1 and OF14-SW-G1 had the greatest copper and zinc concentrations (copper ranging from 14 to 87 µg/L and zinc from 150 to 176 µg/L, total recoverable basis), and were also the only samples resulting in a low percentage of normal embryo mussel development. The copper concentrations were well above effects levels for *Mytilus*, in the range of effects levels for giant kelp (at OF 14), but below acute survival effects levels for mysid shrimp and *Neanthes* (see reference toxicant summary in Appendix F).

SEA Ring Demonstration Conclusion for NBSD. As with the prior two demonstrations, this unique assessment further highlights the ability to gather more realistic exposure data using the SEAP technology under very different exposure scenario and conditions. Understanding the impacts of stormwater runoff on marine receiving water environments is a serious challenge using existing standard laboratory-based methods, with *in situ* assessment providing a much more realistic and defensible approach. Given that fresh water alone will cause effects to marine species depending on the duration and magnitude of exposure, concurrent real-time salinity data is critical to help tease out potential effects related to this stressor alone versus contaminants. Incorporation of passive samplers for chemicals of potential concern was also demonstrated to provide substantial added benefit to help interpret results.

6. PERFORMANCE ASSESSMENT

6.1 QUANTITATIVE PERFORMANCE OBJECTIVES

6.1.1 Performance Objective #1: Water Quality Maintenance

This performance objective was met most of the time, and through lessons learned and design refinements over the course of the project, deficiencies have been virtually eliminated. Water quality (temperature, dissolved oxygen [DO], pH, salinity) was monitored in select SEA Rings during all deployments. Small data loggers (Troll[®] 9500 multi-sensor or HOBO conductivity, temperature, and DO loggers) were typically placed both inside and outside a representative exposure chamber to compare the effects of the SEA Ring system on water quality maintenance relative to ambient conditions. Water quality data for all of the demonstrations are summarized in Appendices C, D, and E.

In general, water quality inside the chambers very closely resembled site conditions, well within the goal of $\pm 50\%$ of ambient conditions. In $\sim 20\%$ of cases, however, DO was recorded as less than 50% of ambient at some point in the exposure period. Reasons for logger documentation of large drops in DO included battery depletion of SEA Ring (resulting in termination of flow), challenges with using the flow cell designed for the Troll[®] (used in early deployments only), reliability of rental Troll[®] units, and stations with particularly high oxygen demand. The Version 3 SEA Ring appears to have eliminated concerns regarding battery discharge and water exchange, which is consistent with improved DO concentrations, even in high oxygen demand sediments. A chamber cap modification allows for use of smaller, less expensive, and more reliable documentation of water quality monitoring (Figure 5-16).

As an example, data for MCB Quantico are shown here for two events (2 months and 14 months post-cap placement, conducted in 2014 and 2015, respectively). Station 5 (on cap) and Station 7 (off-cap) represent conditions that were relatively low or high in the silt clay fraction (5.7 and 55% fines, respectively, in 2014). The DO concentration (recorded every 10 minutes) inside the SEA Ring at Station 5 (low fines) was within 5% of the ambient DO concentration, while we provide an example of a worst case scenario for DO at Station 7 (high fines), where DO dropped to near 0 mg/L midway through the exposure (Figure 6-1). The periodic observation of depressed DO concentration led to development of a Version 3 SEA Ring with more efficient pumping. The DO concentration monitored at stations 3 and 6 in 2015 (14-month, post-cap placement), where fines in surface sediments were 10 and 52%, respectively, was comparable to ambient concentrations (Figure 6-2).

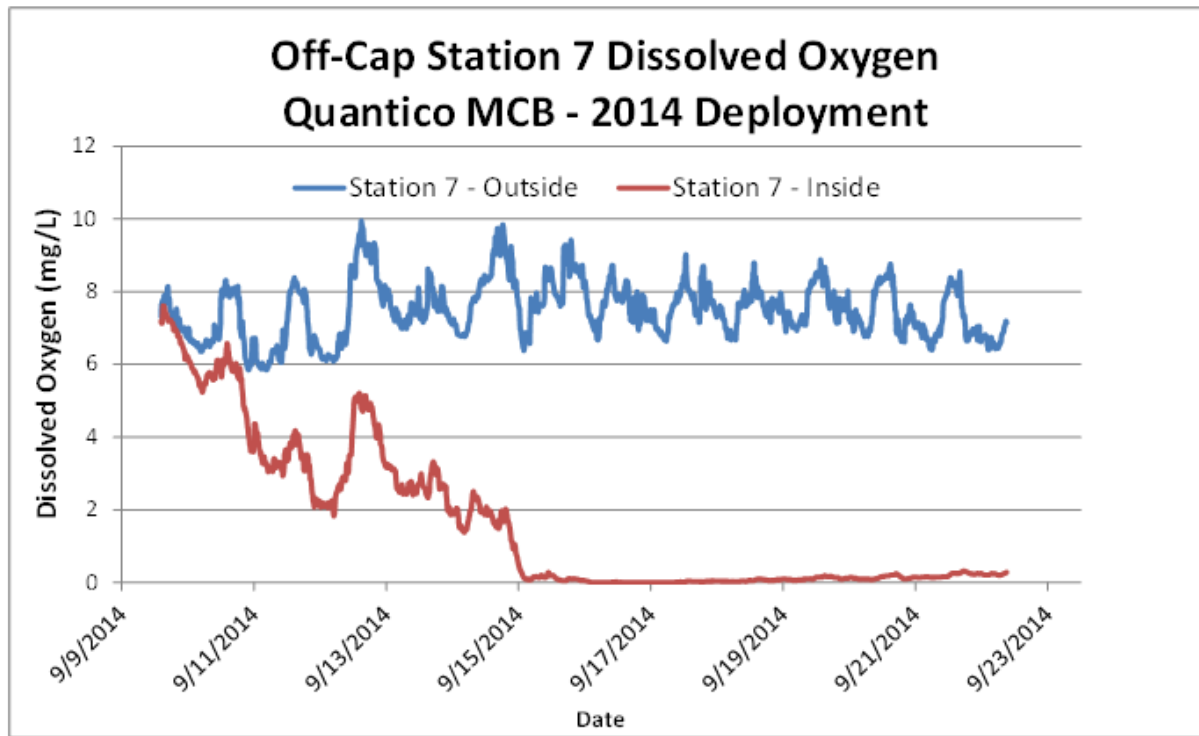
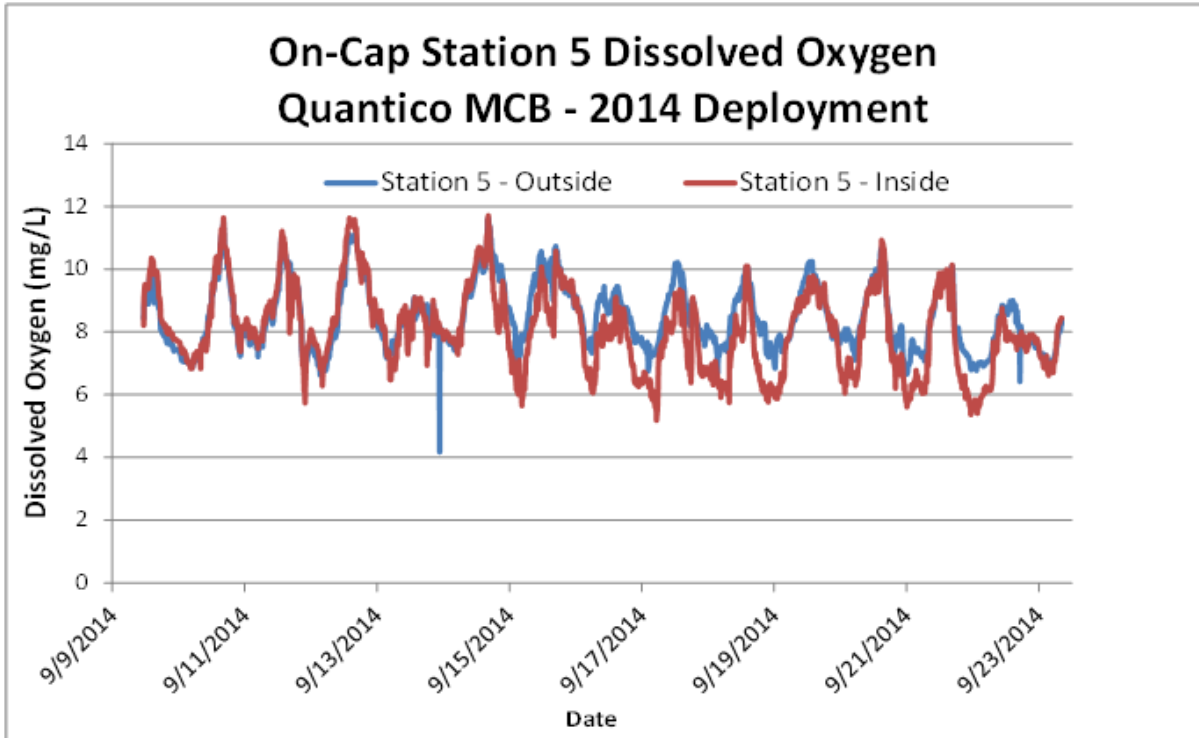

Figure 6-1. DO measured within and outside an exposure chamber at Station 5 (on cap, top) and Station 7 (off cap, bottom) during the 2014 MCB Quantico deployment using Version 2 SEA Rings.

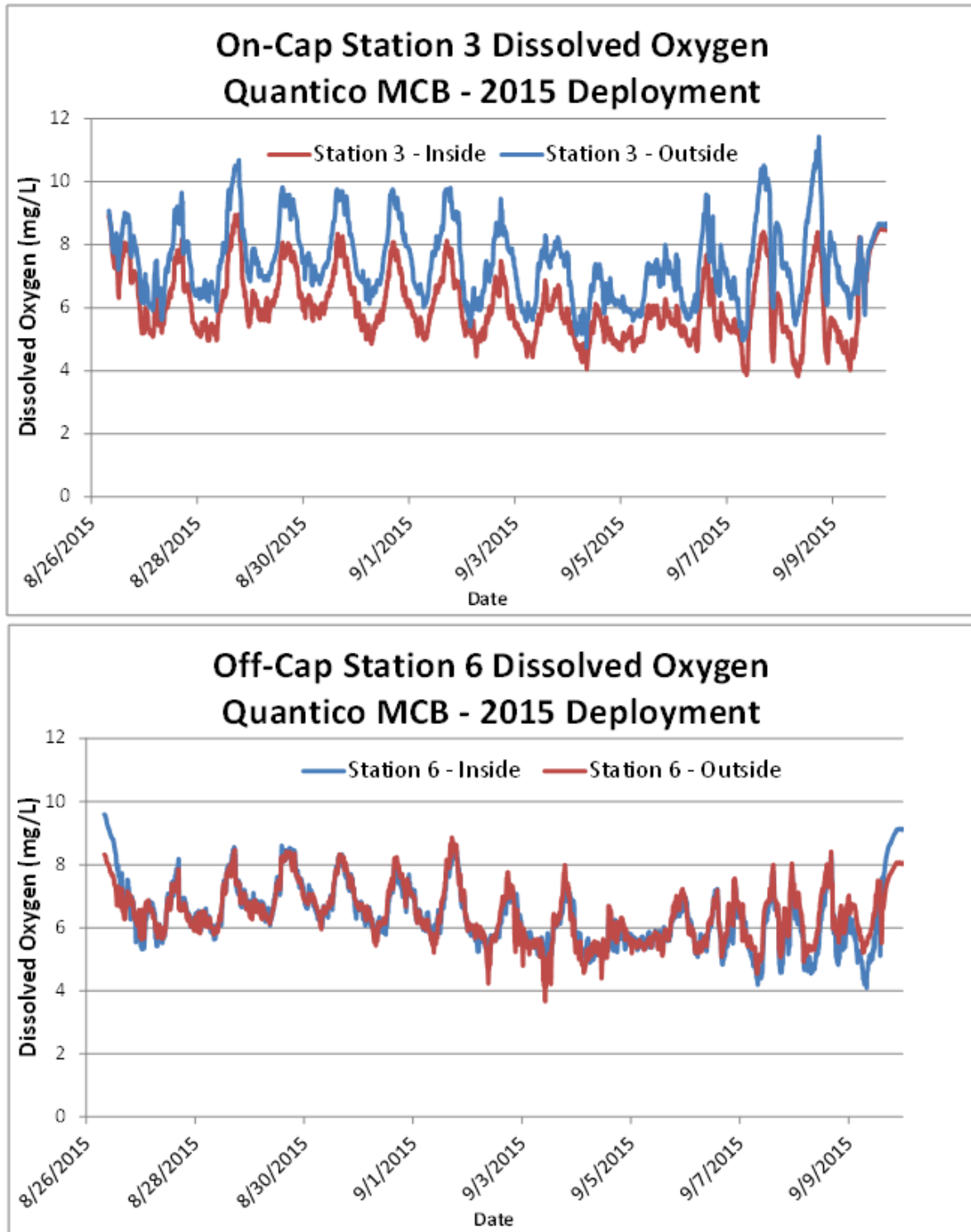

Figure 6-2. DO measured within and outside an exposure chamber at Station 3 (on cap, top) and Station 6 (off cap, bottom) during the 2015 MCB Quantico deployment using Version 3 SEA Rings.

6.1.2 Performance Objective #2: Pump Flow Rate

The goal for this performance objective was to minimize the variation associated with individual chamber performance in terms of volume exchange rate, with the goal of a minimum of six volume turnovers per day during a deployment.

Pump Flow Variability. Laboratory trials showed that pump flow rate met this objective, with well under 50% variability among the 10 chambers on a given SEA Ring. Figure 6-3 shows average flow rates from measured volumes from each port for a given exposure chamber over a 6-hour test period, during which the Version 2 peristaltic pump flushed for 12 minutes per hour. Average flow rate among the 10 ports ranged from 106 to 109 mL/min, varying <3%.

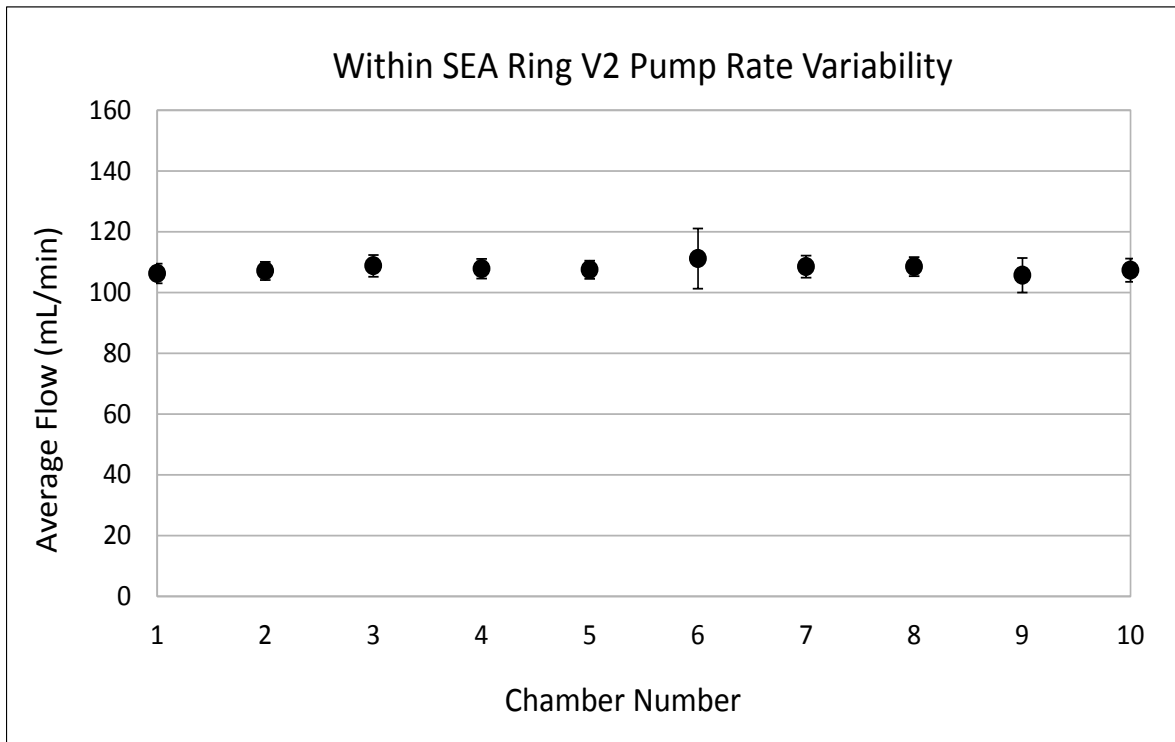

Figure 6-3. Mean flow rate measured from each port (exposure chamber on a Version 2 SEA Ring). Grand mean (\pm S.D.) across all ports was 108 (\pm 4.22) ml per minute of flow.

Figure 6-4 shows average flow rates from measured volumes from each port for a given exposure chamber for the Version 3 10-motor centrifugal pump system using a pumping duration of 6 seconds, which was desirably compatible with the V3 system. Average flow rate among the 10 ports ranged from 310 to 340 mL/6 seconds (3.1 to 3.4 L/minute), varying <9% among chambers.

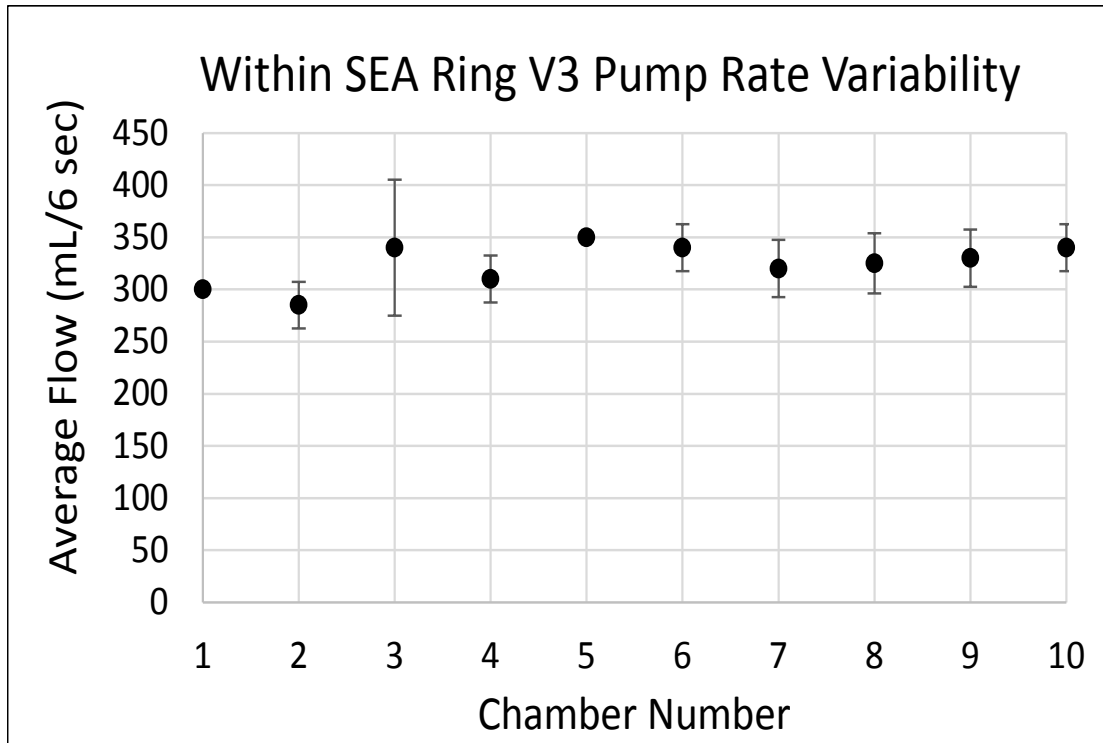

Figure 6-4. Mean (\pm S.D.) flow rate measured from each port (exposure chamber on a Version 3 SEA Ring. Grand mean (\pm SD) across all ports was 324 (\pm 23.8) ml per 6 seconds of flow.

Volume Exchange Rate. For all of the deployments performed, the targeted minimum of 14 turnovers per day were achieved, exceeding the 6 turnover/day minimum criterion by greater than a factor of two. Due to concerns associated with water quality, even at this exchange rate in high oxygen demand sediments, an external battery pack was added to the system following baseline deployments at both PSNS and MCB Quantico, resulting in daily turnover rates of more than 40 chamber volumes per day over a 14-day exposure. Flow rates were verified by downloading data files from each SEA Ring following deployments, which included time and duration that the pump(s) cycled for, battery voltage, and the number of pump revolutions (Version 2), or current load (Version 3).

For the baseline deployments at PSNS and MCB Quantico, 14 turnovers per day were achieved (no battery pack). For the PSNS 10- and 22-month post-placement monitoring events and MCB Quantico 2-month, 58 turnovers per day were achieved (included battery pack) using a program of 1 minute of pumping every 5 minutes. For the 34-month (2015) post-remedy monitoring at PSNS, a combination of Version 2 and Version 3 SEA Rings were used at the site while 14-month (2015) post-remedy monitoring at MCB Quantico incorporated Version 3 SEA Rings only. Turnover rates were estimated at 58 and 137 volumes/day for Version 2 and 3 units, respectively.

For the stormwater demonstration at NBSD, up to 144 turnovers per day were achieved using the Version 2 units over a 4-day period. At this site, pumps were programmed to pump for 50% of the exposure time, alternating between 1 minute of pumping and 1 minute of downtime. This relatively aggressive pump regime was targeted to account for incorporating continuously changing conditions associated with the storm event.

Mean flow rate among chambers within a given SEA Ring also did not vary by more than 50% of the mean flow rate among chambers on other SEA Rings deployed. Figure 6-5 shows the average flow rate (L/day) for each of 10 SEA Rings deployed during the baseline assessment conducted at PSNS. Overlying water volume in a given test chamber was approximately 500 mL, thus with a minimum flow rate of approximately 7 L/day, the minimum number of turnovers equated to 14/d. It should be noted that various enhancements to the SEA Ring over the course of the project only increased the turnover rate, as discussed above.

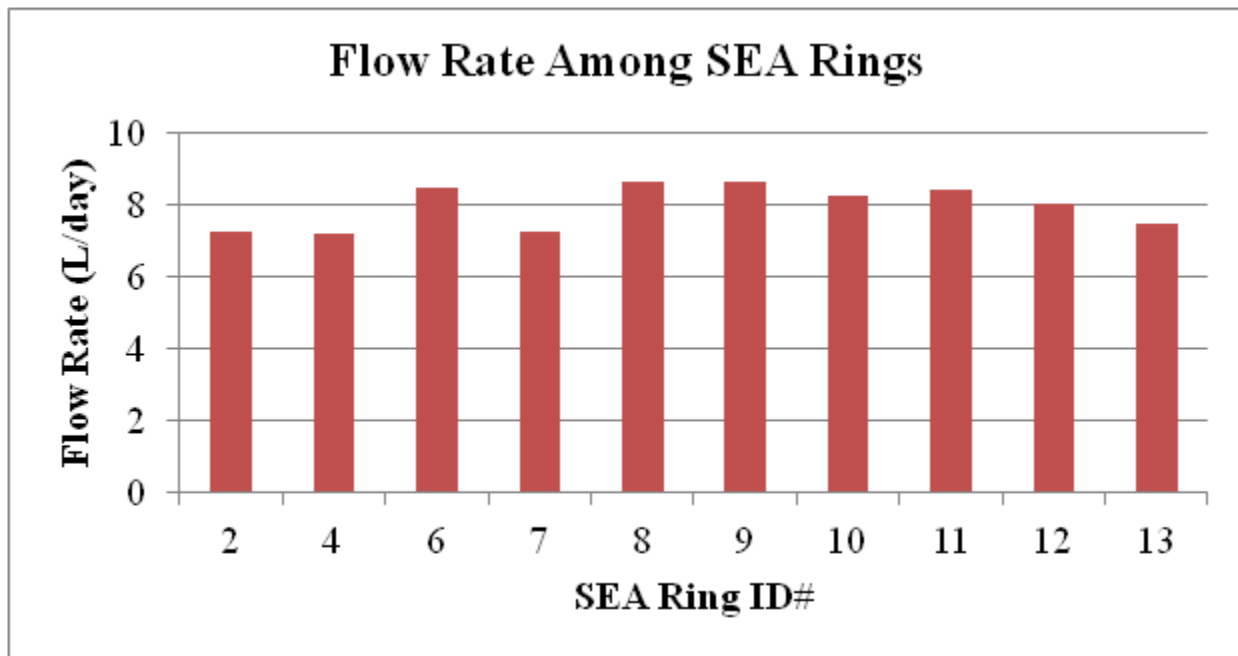

Figure 6-5. Mean flow rate measured from each Version 2 SEA Ring during the 14-day baseline (2012) assessment conducted at PSNS.

6.1.3 Performance Objective #3: Sediment/Organism Recovery

Successful recovery of organisms or sediment within deployed exposure chambers was achieved across all field demonstrations, and averaged well over the 80% goal. In some cases, individual replicates (or all replicates in rarer cases) exhibited mortality or loss of test organisms from other reasons. Because toxicity, predation, escape, or diver error/removal difficulties associated with the recovery process are potential causes for lower numbers of recovered organisms compared to deployed organisms, the height of the core was documented and sometimes used to help interpret reasons for organism loss.

PSNS. For the PSNS demonstrations (four events), *Macoma* numbers recovered alive averaged 72% relative to number deployed (Figure 5-11), but sufficient tissue mass (as replicates within a station were composited) was recovered for tissue analysis 93% of the time (37 out of 40 stations).

Nephtys recovery was acceptable in terms of tissue mass required for analysis for 24 out of 40 (60%) SEA Rings deployed over the four sampling events (Figure 5-12), considerably less than that for the freshwater oligochaete (*Lumbriculus*) used at MCB Quantico. As mentioned previously, worms that were recovered using the concurrent flow through bioassay conducted on intact cores were used when SEA Ring worms were not available to support tissue requirements for ER-201131.

MCB Quantico. For the MCB Quantico demonstrations, *Corbicula* met this criterion with 100% of SEA Rings deployed (20 out of 20), providing tissue to support analytical requirements. In terms of numbers of clams recovered, 92.5% of clams were recovered alive over the three events (range = 83–100%), with the baseline 2012 event resulting in the highest recovery (100% clams deployed recovered alive; Figure 5-20). Sufficient clam tissue for DDX analysis was available for all stations and all events (100%), with the exception of Station 7 for the 2012 baseline event, which was intentionally not included.

Lumbriculus recoveries met success criteria with 19 out of 20 (95%) SEA Rings deployed over the three sampling events (Figure 5-21). The one SEA Ring that did not provide sufficient tissue mass was placed at Station 3 during the 2-month post cap placement event (QT2). Upon recovery, it was found that syringes with worms had not been depressed (miscommunication with divers), so they were never released to sediment after the device was installed. Note that tissue mass submitted to the analytical labs varied considerably (Figure 5-21). The delicate process required to separate *Lumbriculus* from sediment associated fauna such as filamentous algae can be extremely difficult, so once sufficient mass was obtained for analysis, subsequent efforts to recover were sometimes deemed unnecessary.

NBSD. For the NBSD demonstration, some minor toxicity was observed both for laboratory and *in situ* exposures (Figure 5-30), therefore, organism recovery comparisons were made between laboratory reference controls and the two reference sites (SSC Pacific Pier and OF-F) for all test species (Table 6-1). Laboratory controls in this case are the pre-storm grab samples collected at the SSC Pacific Pier reference location. In most cases, SEA Ring recoveries were similar or better than laboratory recoveries. The overall average recovery rate for SEA Rings for the two reference stations and four species was 92%.

Table 6-1. Laboratory and SEA Ring recoveries from reference locations associated with storm event at NBSD.

Species	Endpoint	Laboratory SSC Pacific Pier	SEA Ring SSC Pacific Pier	SEA Ring Outfall Farfield (OF-F)
<i>Neanthes arenaceodentata</i>	% survival	100 (0)	90 (14)	100 (0)
<i>Mytilus galloprovincialis</i>	% normal	80 (6.2)	95 (2.5)	87 (1.6)
<i>Americamysis bahia</i>	% survival	80 (23)	88 (15)	95 (5.8)
<i>Macrocystis pyrifera</i>	% germination	NA	92 (3.8)	88 (4.2)

6.1.4 Performance Objective #4: Control Performance

This objective was successfully met and is based largely on the EPA ETV study (McKernan et al., 2014). This study was conducted under controlled laboratory conditions, in which test-acceptability included minimum requirements for test organism survival (or sublethal effects) in controls. Control performance is routinely evaluated to establish test organism health and technical proficiency with the test method for laboratory tests (e.g., ASTM, 1999; USEPA, 1995; USEPA, 2002a). Under normal *in situ* conditions, an appropriate control in the same sense is typically not possible. For the ETV study, SEA Rings were loaded in the laboratory with laboratory dilution water and control sediment to establish test organism health, proficiency with the test method, and assurance that the

SEA Ring did not present any adverse effects on the test organisms. The laboratory SEA Rings were tested alongside standard laboratory controls during concurrent laboratory verification testing.

Success for this performance objective was assessed by comparison of standard laboratory beaker control test results and the laboratory tested SEA Ring control samples. Sediment toxicity, water column toxicity, and bioaccumulation tests were investigated and for each test condition, the mean result in the SEA Ring was compared to that observed using traditional EPA methods using two sample t-tests, assuming unequal variances.

For all species tested and their respective endpoints, there were no significant differences (between the SEA Ring results and traditional laboratory beaker results (Table 5-10). For all test types, the percent difference met the performance objective of <25% difference.

6.1.5 Performance Objective #5: Completion Rate

For the four PSNS demonstrations, all SEA Rings that were deployed were successfully recovered and meaningful tissue data was obtained from 37 of the total 40 SEA Rings deployed (93%).

For the three MCB Quantico demonstrations, a total of 21 SEA Rings were deployed, of which 20 were recovered (95% recovery success). During the T = 2 month (2014) post-remedy assessment, one SEA Ring (Station 3) could not be located on recovery. However, a duplicate SEA Ring was deployed at the same station and meaningful tissue data (for *Corbicula*) was obtained from all stations targeted, allowing overall 95% completion for *Corbicula* and 90% completion for *Lumbriculus* (as worms at one station were accidentally not released from syringes and never exposed to sediment; see Section 5.7.3).

For the NBSD demonstration, 100% of SEA Rings were successfully recovered following the deployment period with meaningful data obtained from all stations for all species utilized.

6.1.6 Performance Objective #6: Identification of Confounding Factors

To avoid false positive results for a given sample or site, water quality parameters were measured within a representative exposure chamber on the SEA Ring. This action was taken to ensure that physical parameters were within tolerances of the organisms utilized and prevent inaccurate interpretation of adverse effects associated with non-anthropogenic factors.

Water quality sensors were fitted into an integrated cap that allowed for real-time measurements of conditions within an exposure chamber. In some cases, additional water quality sensors were mounted onto the exterior of the exposure chambers for comparative purposes.

Here, we discuss the potential for parameters, including temperature, dissolved oxygen, salinity, ammonia, and grain size to have played a role in affecting normal organism behaviors and potential for invalid interpretation of toxicity in site demonstrations or the controlled ETV study.

Temperature. As described for Performance Objective #1 (Water Quality Maintenance), temperature was essentially identical inside and outside the exposure chambers (Figure 6-6; see Appendices C, D, and E for additional examples). More importantly for this objective, temperatures were documented to be within the normal range for the test organisms employed at the various sites. Therefore, we don't believe that temperature had any adverse impacts on test organisms or confounded test data.

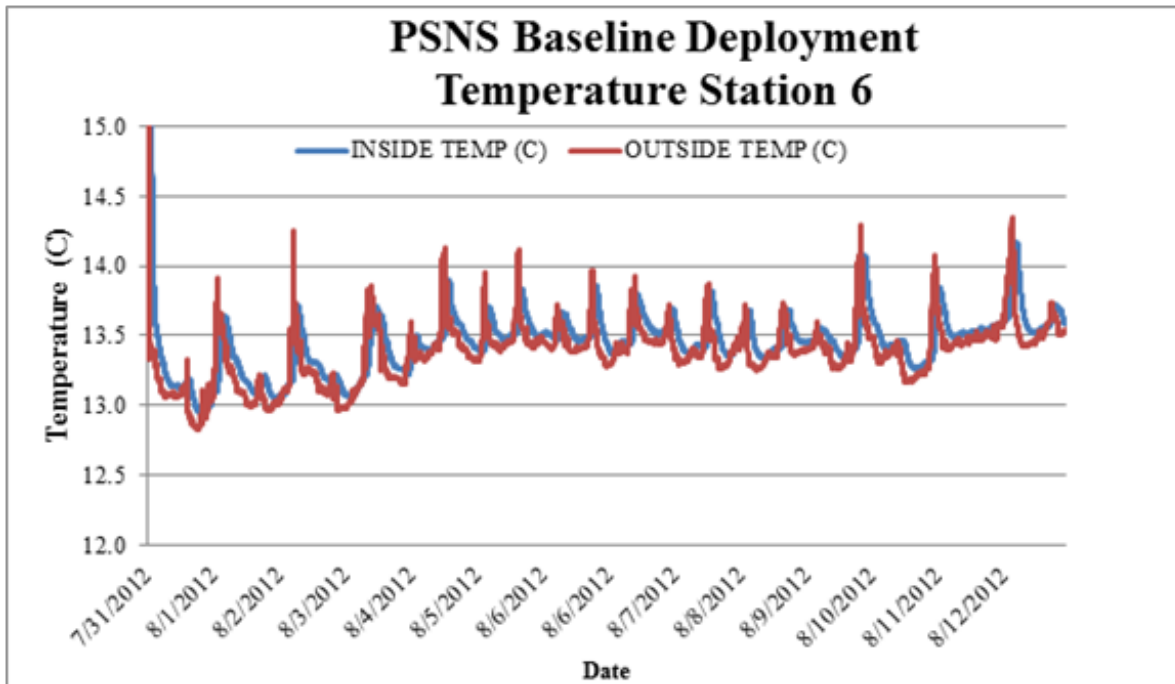

Figure 6-6. Temperature measured inside and outside a SEA Ring exposure chamber (Station 6) during the baseline (2012) assessment at PSNS.

Dissolved Oxygen. Dissolved oxygen (DO) inside and outside chambers did vary in some cases (see Performance Objective #1 and Appendices C, F, and G, for examples). Low DO was nearly always observed if a SEA Ring stopped pumping during the deployment, which would affect the likelihood for recovering live, healthy organisms. The potential for DO to drop below critical thresholds inside a SEA Ring led to an improved design for measuring water quality (integrated chamber cap with HOBO loggers) development and integration of the Version 3 pump instrumentation, which seems to have resolved this potential confounding factor.

Salinity. Salinity was essentially constant at the PSNS and MCB Quantico sites, and within test organism tolerance. For the NBSD demonstration, however, salinity varied significantly during the storm phase of the demonstration in the Chollas Creek (Figure 5-28) locations. A salinity gradient was not unexpected as the SEA Rings were intentionally placed close to sources (e.g., the mouth of Chollas Creek), which resulted in potentially substantial runoff, particularly near the water surface. The three drops in salinity to near 0‰ observed at the site likely affected *Neanthes* survival, as this marine species is largely intolerant to such drops (Dillon, Moore, and Gibson, 1993). Therefore, salinity can be a non-contaminant related stressor that needs to be accounted for in stormwater *in situ* monitoring near coastal areas.

Ammonia. Ammonia concentrations were measured in the overlying water from the ETV study only, using HACH Method 10031. Following 20- and 28-day exposures to the marine polychaete (*Neanthes arenaceodentata*) and the bent-nosed clam (*Macoma nasuta*), respectively, overlying water total ammonia concentrations from the three sediments tested (see McKernan et al., 2014) ranged from non-detectable to a maximum of 7.6 mg/L, below effect thresholds for these species. Therefore, ammonia was not considered to have contributed to toxicity in the ETV testing.

Sediment Grain Size. Sediment grain size was not believed to be of concern as a confounding factor in this project because the test organisms used in sediment exposures are not known to have any problems with accepting multiple grain sizes (as summarized in Rosen et al., 2009). That said, the potential for adverse effects associated with organically rich sediments that have high fines was a concern with respect to potential impacts on overlying water quality in SEA Ring chambers and has been discussed above.

6.1.7 Performance Objective #7: Contaminant Uptake

This objective was met for two of the three ETV tests, differing by 2 and 3% for clams and polychaetes, respectively (Table 5-11). Amphipod uptake was 44% higher in the laboratory tests compared with the SEA Ring test, but this difference was not statistically different due to relatively high variability observed for both the laboratory and SEA Ring tests. Amphipods were somewhat averse to burrowing in the relatively fine-grained (50% silt and clay) test sediment during early parts of the exposure which may have affected their exposure to PCBs.

The potential for a more accurate assessment of bioavailable contaminants of concern (CoC) is one of the major advantages of *in situ* exposures or laboratory-based exposures. Because bioavailability and potential for biouptake of CoCs is dependent on site-specific conditions, it is inappropriate to expect concordance between laboratory-exposed organisms with *in situ* exposed organisms. However, it is appropriate to ensure that the SEA Ring technology provides the same opportunity for bioaccumulation to occur assuming comparable exposure in the laboratory and *in situ*. Through the laboratory-based study conducted under the ETV program, appropriate data and success criteria were obtained with which to make an appropriate comparison of biouptake assuming all conditions were equal.

For select deployments, laboratory bioassays were also conducted on intact sediment cores to demonstrate the difference in variability among SEA Ring replicates with laboratory replicates. This was also an opportunity to make qualitative observations on the difference between *in situ* and laboratory data, as holding such a comparison is inappropriate considering the expected differences between field and laboratory, and thus the rationale for conducting bioassays *in situ*. (See comparisons made for both PSNS and MCB Quantico demonstrations in Section 5.7 for details).

6.2 QUALITATIVE PERFORMANCE OBJECTIVES

6.2.1 Performance Objective #8: Ease of Operator Use

ETV Assessment. As part of the USEPA ETV process, operational factors were evaluated. The SEA Ring was operated in the laboratory by the staff at SSC Pacific, and also by a Battelle staff member (third-party unbiased verification). During a 4-hour period, the Battelle staff member was trained on use of the SEA Ring, including loading of organisms and measurement of water quality parameters. The Battelle staff member found the SEA Ring easy to operate, but noted that care must be taken when loading some species due to their small size. Note that this is also the case with standard laboratory test methods. The SEA Ring was found to be easy to transport by one person. The waste obtained when operating the SEA Ring was minimal. No maintenance was required when the Battelle staff was onsite.

Site Demonstrations. In the field, operators included at least 10 members of our extended technical team (over multiple sites and events over a 4+ year period), each with varying levels of familiarity of the test protocols (ranging from nearly none to those who developed and were intimately aware of its use). In addition to the project team, operators also included on-site diver support (e.g., Navy divers at PSNS and EPA ERT divers at MCB Quantico), all of whom had on the spot training on its use.

Those most experienced with the SEA Ring development and understanding of the provided Operation Manual and SOPs had the fewest issues with operation, typical with specialized underwater mechanical equipment. Technical problems experienced with the device were sometimes associated with user inexperience and/or limited understanding of project goals. The multiple details and potential issues associated with using live organisms in the laboratory extend to the field, and this project demonstration was largely successful in that in most cases.

6.2.2 Performance Objective #9: Integration of Passive Samplers

Passive sampling devices such as DGTs and SPMEs were successfully integrated in all demonstration deployments for both sediment remedy effectiveness and stormwater assessments (Figure 67).

PSNS. A positive relationship was observed between tissue and porewater concentration for both species when all data points ($n = 37$ and $n = 23$ for *Macoma* and *Nephtys*, respectively) for which both tissue and porewater data were available. These comparisons are shown in Figure 5-17 and Figure 5-18, and the raw data are shown in Appendix D. For *Macoma*, the relationship was relatively weak ($r^2 = 0.050$) and was not statistically significant ($p = 0.184$). For *Nephtys*, the relationship was stronger ($r^2 = 0.276$) and was statistically significant ($p = 0.010$). When the data were averaged across the entire site and expressed on a per event basis, the relationship became much stronger, with r^2 values of 0.651 and 0.917, for *Macoma* ($p = 0.193$) and *Nephtys* ($p = 0.043$), respectively. It is possible that the stronger relationship observed for *Nephtys* is associated with their preference to deposit feed at a subsurface level (as compared to the surface filter or deposit feeding by *Macoma*), thus being more closely in contact with the top several inches of the sediment.

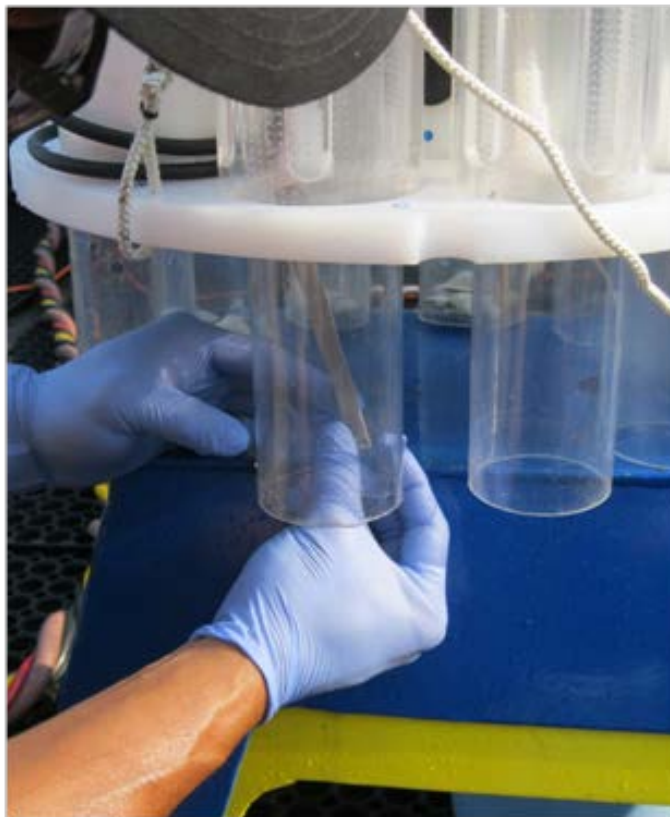

Figure 67. Example of integration of SPME into SEA Ring chamber at PSNS&IMF.

MCB Quantico. SPME deployments were conducted for all three events conducted thus far at the site, and results will be included in the final report associated with the leveraged project, ESTCP Project #ER-201368 (Kirtay et al, in prep)..

NBSD. Labile copper and zinc concentrations from DGT deployments closely mimicked spatial trends observed for composites of the eight grab samples collected at each station, but DGT concentrations were consistently lower. As expected, labile concentrations were lower than dissolved, but correlations between the two were generally highly statistically significant (Figure 5-34). These results provide confidence that the exposure conditions inside the SEA Rings were similar to ambient conditions outside, while also successfully demonstrating the ability to integrate passive sampling technologies to better match *in situ* toxicity and chemical exposures.

6.2.3 Performance Objective #10: Diverless Deployment/Recovery

Successful deployment of the SEA Rings for stormwater evaluations at NBSD were completed without the use of divers for the deployment and recovery operations. However, for PSNS and MCB Quantico demonstrations, divers were required. Note that other activities, including SPI camera, passive sampler deployments, and sediment collection also required diver support. Poor visibility at MCB Quantico and depths of 50 feet or more at PSNS presented challenges that ultimately required diver assistance.

Several methods towards diverless recovery at sediment sites have been developed and tested that show promise, including a modification of the Trident Probe pole system (D. B. Chadwick et al., 2003) and simplified core catchers (Figure 6-8). However, consistent success for any of the methods was dependent on the sample type and potential physical interferences at any given site. The heterogeneity of sediment characteristics at sites evaluated presented challenges, so diver assistance may still be required until an optimal design is verified.

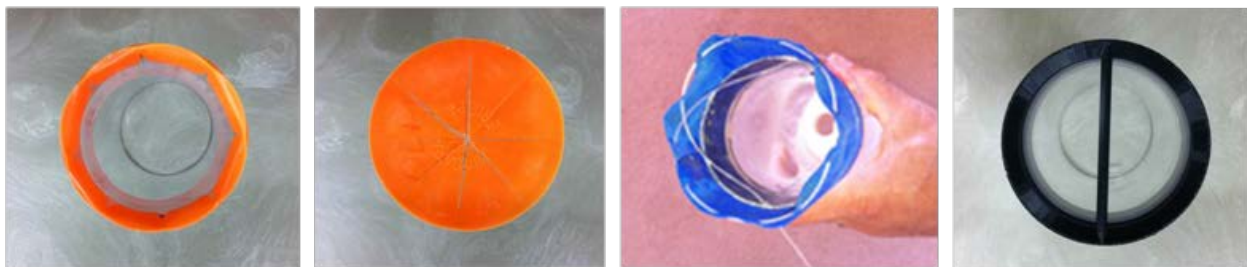

Figure 6-8. Examples of promising core catcher designs for capturing sediment and test organisms.

6.2.4 Performance Objective #11: Cost-Benefit

The ultimate benefit is the derivation of more realistic and accurate data from which to base subsequent management actions. The cost of potential management actions (e.g., sediment remediation and stormwater pollutant controls) will in many cases far outweigh the costs to provide data based on more representative exposures using the SEA Rings for decision-making purposes. Significant cost-avoidance may be realized should more realistic *in situ* methods indicate no impact relative to laboratory-based tests that may show an effect under certain scenarios.

The above said, a cost analysis was performed comparing the SEAP technology with standard laboratory-based methods under the three scenarios, including a sediment bioaccumulation program at 10 stations, a sediment toxicity program at 10 stations, and a water column toxicity program at 10 stations. The cost for a survey using the SEAP technology and of the scale employed in this project is expected to be on the order of \$80,000 to \$90,000 for a single sediment or water toxicity

testing study and \$70,00 to \$80,000 for a single bioaccumulation assessment evaluation. These costs were quite comparable to independent laboratory-based approaches, differing by an estimated 7–12%, with the SEAP sometimes being less expensive than the lab estimates. For comparison purposes, a similar assessment was also performed for a smaller program consisting of six stations as highlighted and described further in the Section 7.2.

7. COST ASSESSMENT

7.1 COST REPORTING

Cost issues are critical to the evaluation and acceptance of innovative technologies. Along with demonstrating and validating the Sediment Ecosystem Assessment Protocol (SEAP) technology, an important goal of this project was to develop and validate, to the extent possible, the expected operational costs of the technology. Relevant costs and related data as described in this section were tracked and documented during the demonstration so that the operational costs of the technology can be estimated with a high degree of confidence.

During the course of the project, commercialization has proceeded in partnership with three private companies: (1) Zebra-Tech Ltd., a specialty marine equipment design and engineering firm, designed and manufactured the SEA Rings; (2) AMEC Environment & Infrastructure (AMEC), an environmental consulting firm, has supported design, testing, and commercial/regulatory outreach support for the SEAP Technology; and (3) Nautilus Environmental, a commercial toxicity lab, provided field, laboratory, data analysis, and reporting support. AMEC has also purchased four of the latest version SEA Rings and has been conducting *in situ* testing with them off Scripps Institution of Oceanography (SIO) in support of its National Pollutant Discharge Elimination System (NPDES) Permit for facility and stormwater discharges to an Area of Biological Significance (ASBS). The costs summarized below are largely based on data provided by these commercial entities through their experience on the demonstration projects and many additional efforts completed during the demonstration project. Documentation of associated labor efforts and equipment costs from program leads and partners at Space and Naval Warfare Systems Center Pacific (SSC Pacific) and the University of Michigan have also been incorporated into the final estimates provided herein.

7.2 COST ANALYSIS

7.2.1 Cost Basis

The cost basis (e.g., scale of operation) that was used for the future cost analysis was based on an estimated site scale developed from the ESTCP demonstration sites, and other sites that are currently under investigation or considering investigation. The cost basis for the SEAP technology is primarily controlled by the spatial scale of the site and the number of stations and samples that must be evaluated to adequately satisfy the data quality objectives. For this cost analysis, the site scale and design parameters were similar to that used for the demonstration projects as summarized in Table 7-1. Note that the costs derived for this comparison include a full scale assessment from the planning stages through sampling/testing and final reporting. In reality, there are many cases where the SEAP technology might provide a valuable add-on component to existing monitoring programs. In these cases, the additional cost to incorporate supporting *in situ* data using the SEA Rings may be very cost effective and a relatively minor component of the cost for an entire more comprehensive program.

A cost benefit analysis is an important step for any environmental assessment program. In this case, the cost of implementing an in-situ based program that can provide a more realistic assessment of site-specific conditions, particularly where conditions may vary temporally, must be weighed against the cost of a more controlled laboratory-based assessment that may provide less realism, but requires fewer logistical challenges and resources dedicated to the field. Both situations will still require a field team, sampling equipment, travel logistics/costs, project coordination and oversight, and proper field documentation. However, due to the extra equipment and requirement to both install and retrieve SEA Rings, the field effort costs will be greater for this approach relative to that for a laboratory-only based testing program. A field based *in situ* program on the other hand will likewise

require fewer resources for laboratory-based tests; testing in the field is performed in lieu of laboratory-based tests. Per sample unit test costs are available and provided by certified analytical toxicity testing laboratories. A field-based program using the SEA Ring technology will require only a very limited number of laboratory-based tests for QA/QC purposes to assess the health of the test animals used for testing: (1) a control exposure of equal duration to that in the field (exposure to clean water or sediment), (2) a water-only reference toxicant test to evaluate the health and sensitivity of the organisms to a known toxicant in relation to historic results for the laboratory, and (3) a travel or other associated method control to assess health of the organisms after transport to and from the field. Note that the laboratory control would be performed as a part of a standard reference toxicant test. In the costing examples provided below, a program that requires an assessment of 10 sample locations will require 10 unit test costs per species for a laboratory-based program, but only a single test per species (travel controls plus a reference toxicant test) for an *in situ* based effort using the SEA Rings. Thus, the number unit costs for lab testing differ between the two approaches as shown below in Table 7-5 through 7-10 for various water and sediment testing program scenarios.

Cost estimates to perform an evaluation using the SEA Ring technology will depend on a number of project-specific factors. Key considerations during the cost assessment planning stage will include travel requirements, shipping, security, site accessibility and accessibility of sufficient controlled space to prepare and take care of test organisms prior to deployment, water depths, currents and tides, sediment characteristics, topography and potential obstacles, and SCUBA requirements.

The cost assessment provided herein for comparison to a laboratory only evaluation makes two key assumptions as follows:

1. The project is local not requiring extensive travel and shipping effort;
2. Field deployment and recovery is performed by a SCUBA team of two with land side or vessel support.

Table 7-1. Site scale and design parameters used for cost analysis.

Parameter	Scale or Design Element
Sediment toxicity/bioaccumulation	10 sites, including a reference site, one SEA Ring per site (10 total), and six sites, including a reference site, one SEA Ring per site (six total)
Water column tests	10 sites (either five sites at two depths per site or 10 locations at a single depth), one SEA Ring per depth (10 total), and six sites at a single depth, one SEA Ring per depth (six total)

7.2.2 Cost Drivers

The expected cost drivers for the SEAP technology are largely driven by labor, analytical laboratory, supplies, transportation, and capital equipment costs associated with planning, mobilizing, operating, demobilizing, data analysis, and reporting. Capital costs for the SEAP technology has been developed by the manufacturer, Zebra-Tech Ltd., and service cost options are available as the company develops the technology.

For purchase of the equipment, it is expected that capital costs would be amortized over a number of site evaluations before the purchase of new equipment would be required, and that these costs would be recouped through equipment fees passed on to the customer. Estimated costs for other ancillary capital equipment were documented during the demonstrations. Most of the future

engineering, modifications, and upgrades to the equipment are expected to be capitalized by the manufacturer and recouped in the purchase, lease, or service cost for the technology.

Operating costs for the technologies are largely controlled by the labor rates and number of personnel required to field the equipment, analyze the data, and generate the documentation associated with the project. These factors were carefully documented during the demonstrations. Other operating costs include analytical costs, consumables, residuals handling, and system maintenance. Most maintenance functions can be carried out by the operating team. Mobilization and demobilization costs are largely related to labor and shipping costs. Shipping costs can vary considerably, depending on the distance to the site and the shipment method. Labor costs for mobilization and demobilization should be relatively constant. Mobilization and demobilization costs were documented as part of the demonstration.

Analytical and installation costs as well as the performance monitoring costs for the various tools employed were tracked during each demonstration program. All costs, such as labor, materials, analytical costs, shipping, and travel were also monitored and resolved. Specific elements for costing purposes and tracking are shown in Table 7-2.

Table 7-2. Cost elements for SEA Ring demonstration as a monitoring tool for *in situ* toxicity and bioaccumulation testing.

Cost Element	Data Tracked
Baseline characterization	Costs associated with labor Costs associated with material purchases and rentals Analytical costs Costs associated with data analysis and interpretation
SEA Ring deployment	Costs associated with maintaining SEA Rings so that they are ready for deployment (parts, maintenance costs) Costs associated with SEA Ring installation, including labor, cost of materials, and organisms Costs associated with pre- and post-monitoring: organism acclimation, water quality monitoring, concurrent laboratory verification tests, and analytical chemistry
Post-placement monitoring costs	Costs associated with labor Costs associated with material purchases and rentals Analytical costs Costs associated with data analysis and interpretation
Waste disposal	Costs associated with waste disposal (i.e., potentially contaminated material captured by the SEA Rings). Solvents for cleaning testing materials.
Operation and maintenance costs	Costs associated with labor
Long-term monitoring	The SEA Ring deployment period for these site demos range from 2–14 days; therefore, long-term monitoring does not apply to this demonstration.

7.2.3 Life-Cycle Costs

Estimates of life-cycle costs for the technology were based on the expected working life of the systems (5 to 10 years). Capital cost estimates provided by the manufacturer, along with estimated capital costs for ancillary equipment, were used to develop a life-cycle cost for the technology in collaboration with AMEC and Nautilus. The cost analysis incorporates these costs via equipment

fees that are passed on to the customer (Table 7-3). The current rates indicate that the capital investment for the SEA Rings, including ancillary equipment, could be recouped within the expected 5- to 10-year working life, with approximately 25 uses/year, which is well within the expected market demand for the technology. The market demand for this technology appears to be growing based on new regulations nationwide that are including a greater emphasis on understanding impacts to the receiving water systems we are trying to protect. As an example, new Municipal Separate Stormwater System (MS4) regulations in California now require assessment of sediments in the receiving waters as a part of their permit obligations. New requirements to capture and treat stormwater, and continued efforts to clean up historically contaminated sites are in desperate need of assessment approaches that can better assess *in situ* conditions to help determine whether more intensive best management practices (BMPs) or remediation efforts are required in the first place. Such methods are also greatly needed to better assess long-term trends and whether actions taken result in a positive benefit to the environment.

Table 7-3. Life-cycle capital cost investment and recovery estimates.

Item	Initial Unit Cost (\$)	Purchase for Proposed Program to Evaluate 10 sites	Total Cost (\$)
SEA Ring unit	6,000	10	60,000
Ancillary – spare parts/toolkit	2,000	1	2,000
Ancillary – field computer	1,000	1	1,000
		TOTAL	63,000
Equipment Replacement Cost Estimate			
Inflation rate estimate – 4%			
	Years of Use		
	0	5	10
SEA Rings and ancillary equipment	63,000	76,649	93,255
Equipment Rental Rates Including Inflation and Maintenance			
Maintenance rate estimate – 5%			
	Rental Rate (Per SEA Ring)		
	Years of Use		
	Uses/Yr	5	10
SEA Rings and ancillary equipment	2	\$805	\$490
	5	\$322	\$196
	10	\$161	\$98
	15	\$107	\$65
	20	\$80	\$49
Current rental rates			
Per SEA Ring/week			\$500

7.3 COST COMPARISON

No comparable off-the-market technology exists for *in situ* toxicity testing. Instead, the approach taken here evaluates the typical cost for laboratory-based toxicity testing programs compared to *in situ* testing using a defined suite of organism types. Three hypothetical scenarios are compared using commonly used test organisms that were included in this demonstration program:

- (1) acute/chronic whole sediment tests using an amphipod, a bivalve, or echinoderm embryo, and a polychaete worm;
- (2) acute/chronic water column tests using mysid shrimp, a bivalve, or echinoderm

embryo, and a plant (giant kelp); and (3) sediment bioaccumulation tests using a bivalve and polychaete worm. Each scenario includes associated planning efforts and labor for field collection of samples to provide a more direct comparison for a total monitoring program that might implement *in situ* testing. The cost difference for similar species within a general class or family is minimal, so all cost comparisons are performed for just the general classes of test species described above.

A cost analysis for the SEAP technology relative to laboratory-based methods under the three scenarios described above is summarized in Table 7-5 to Table 7-10. Comparisons were included for both a 6-site and 10-site sampling program with specific assumptions included in the notes section of each table. Costs provided assume a local project and a commercial SCUBA dive team of two for deployment and retrieval of SEA Rings. Additional costs would be incurred for travel and shipping of equipment for a non-local project, and any potential requirements for a DoD-certified dive team which entails additional support.

Based on a hypothetical full scale site assessment requiring collection and testing of samples at 10 locations inclusive of a reference site, the cost for an *in situ* survey using the SEAP technology is expected to be on the order of \$80,000 to \$90,000 for a single sediment or water toxicity testing study and \$70,000 to \$80,000 for a single bioaccumulation assessment evaluation. At the scale represented, these ranges are very comparable to that for programs using standard laboratory-only based methods; nearly identical for a sediment toxicity assessment, a 12% reduction relative to laboratory-only methods for assessment of bioaccumulation, and a 7% increase relative to laboratory methods only for water column toxicity tests. Excluding or replacing the giant kelp test would make both water column approaches nearly equivalent due to the post-*in situ* analysis required in a laboratory setting for this test species. These costs do not include any supporting analyses that might be conducted on a project/site-specific basis. Additional assumptions related to these costs are provided in the notes column of each table. Much of the cost difference stems from the greater field labor associated with preparing, installing, and recovering the SEA Rings. Although the focus of the assessment is *in situ* using the SEAP technology, limited concurrent laboratory-based tests may still be required, depending on project objectives to assess animal health, sensitivity, and test acceptability.

A second cost comparison was conducted assuming a smaller scale program with six sampling locations. Based on a hypothetical full scale site assessment requiring collection and testing of samples at six locations inclusive of a reference site, the cost for an *in situ* survey using the SEAP technology is expected to be on the order of \$70,000 to \$75,000 for a single sediment or water toxicity testing study and \$60,000 to \$65,000 for a single bioaccumulation assessment evaluation. These estimated costs for the sediment and water toxicity tests are approximately 15–20% greater using the SEAP technology, but nearly identical for an assessment of bioaccumulation. This shows the economy of scale for using the *in situ* SEA Ring methodology. Depending on the program needs, additional options and leveraging may be accomplished by conducting simultaneous toxicity and bioaccumulation tests *in situ*.

Note that the unit costs under the laboratory-based section in Table 7-5 to Table 7-10 differ between the traditional laboratory-only based program and a field-based *in situ* testing program, as fewer tests will be conducted in a lab setting if *in situ* testing using the SEA Rings is desired. To provide managers a rough per site cost comparison for the above scenarios, the lab and field costs were combined for both laboratory-only and *in situ*-based programs and divided by the number of locations (see Table 7-11). Note that costs for a field program using SEA Rings will depend more on the time required in the field as opposed to the specific number of sites tested. Based on experience, we have been able to deploy up to 12 SEA Rings in a single day; however,

at a larger or more complex site it may be possible to only deploy three to four SEA Rings in a single day. The laboratory-based unit costs are set a priori and are completely independent of the time required in the field.

It is also important to recognize that the SEAP method represents a new technology that provides more realistic information that cannot be achieved through existing laboratory-based methods. Note that *in situ* testing with the SEA Rings will still typically require some degree of side-by-side laboratory-based exposures for quality assurance, so the technology does not strictly replace laboratory methods per se. Thus, a cost-benefit analysis would be a critical first step prior to entertaining the use of the SEAP technology, as described in Section 7.2.1. A summary of conditions where the greatest benefit of using the SEAP technology might be realized is provided in Table 7-4. The ultimate benefit is the derivation of more realistic data on which to base subsequent management actions. The cost of potential management actions (e.g., sediment remediation and stormwater pollutant controls) will in many cases far outweigh the costs to provide data based on more representative exposures using the SEA Rings for decision-making purposes. Significant cost-avoidance may be realized should more realistic *in situ* methods indicate no impact relative to laboratory-based tests that may show an effect under certain scenarios.

As demonstrated off shore from NBSD for this program, elevated chemical concentrations and toxicity in grab samples of stormwater at the end-of-pipe does not necessarily translate to negative biological effects in the immediate marine receiving waters using comparable test methods and exposure periods. Similarly, use of the predecessor version and latest refined SEA Rings have consistently shown no toxic effects in the marine receiving waters off SIO in La Jolla, CA, during rainfall events over the past 4 years, despite frequent toxicity in stormwater collected at the end-of-pipe (semi-annual NPDES monitoring reports for UCSD (2010–2014)). The implementation of *in situ* exposures provides much greater confidence in the outcome relative to collecting and testing of individual grab samples from the receiving water where one could argue that a critical condition might have been missed. Current NPDES permits for the Navy bases in San Diego require regular chemical analysis and toxicity testing of industrial discharges and stormwater from outfalls at more than 100 locations for compliance determination. If toxicity is observed, additional testing is required for confirmation. If toxicity is consistent in more than one sample, implementation of a Toxicity Reduction Evaluation (TRE) Plan is required, followed by contaminant identification and control activities. Such activities may result in overprotective actions with little or no added environmental benefit. Such activities are also very expensive. As an example, an estimate to contain or treat stormwater to meet current recommended end-of pipe criteria for trace metals at the Ports of Los Angeles and Long Beach was close to \$1 billion for a 2- to 5-year, 24-hour design storm (AMEC, 2011). Similarly, a more realistic *in situ* toxicity assessment of a contaminated sediment site will provide more confidence for the determination of a most appropriate cost-effective management action. Sediment remediation alternatives are expensive, typically several million dollars or more at any given site depending on the alternative chosen and volume of questionable material. Leaving the material in place for natural recovery or limiting the area of impact through a more definitive and refined assessment can easily save millions.

Finally, the SEAP technology has also been shown to provide a more realistic *in situ* assessment of in-place sediment contaminant remedial actions related to reducing contaminant bioavailability, as demonstrated at both Quantico, VA, and Bremerton, WA. The data derived *in situ* without collecting and substantially altering the physical structure of the remedial material provides substantially greater confidence in the results. Laboratory-based exposures in some cases during the demonstrations indicated enhanced bioavailability relative to that *in situ*. Relying on these laboratory-based results alone could lead to expensive unwarranted follow-up actions. Alternatively,

environmental impact costs through impaired beneficial uses could be high if laboratory-based studies show less bioaccumulation or toxicity than more realistic field exposures.

As mentioned in Section 5.2, there will be many cases where the SEAP technology might provide a valuable add-on component to existing monitoring programs. In these cases, the additional cost to incorporate supporting *in situ* data using the SEA Rings may be very cost effective and a relatively minor component of the cost for an entire more comprehensive program. As an example, testing with the SEA Rings has been performed as an add-on component to dry and wet-weather ocean receiving water NPDES compliance monitoring for SIO. Tests have been conducted with a suite of three to four species similar to those used for the demonstration project at NBSD. The added cost to include the SEA Ring testing and data analysis at a single compliance location in the receiving water has been approximately \$15,000 per event, a relatively small component (10%) of the overall annual program costs.

Table 7-4. Cost-benefit decision assessment for use of the SEAP technology.

Greater Benefit	Lesser Benefit
Sites with a developed conceptual site model and known contaminant pathways	Sites with no conceptual site model
Sites with a history of known contaminants and potential to cause toxicity/bioaccumulation based on historical data	Sites with limited “screening-level” assessment data or well documented contaminant pathways
Sites that show “sporadic” toxic effects in laboratory-based tests Sites with documented degraded biological communities	Sites with well documented limited contamination, “reference-like” biological communities, or sites that are known to be highly contaminated/toxic
Difficult to mimic exposure conditions (i.e., in place sediment remedies, stormwater, groundwater influenced locations, other pulsed exposures) Sites with unexploded ordnance	Easy to mimic scenarios in a laboratory (e.g., continuous wastewater discharges to a receiving water body with relatively consistent water quality conditions over time)
In-place remedial activity assessment	Testing of multiple experimental remedial alternatives—more cost effective in laboratory-based tests to refine and narrow alternatives for <i>in situ</i> trials
Large, complex sites with potentially expensive remedial actions	Small sites with low-cost remedial opportunities

Table 7-5. Summary of comparative costs—whole sediment toxicity assessment for a 10-site program.

Task Description	In Situ SEA Ring Technology Program				Standard Laboratory Testing Program				Notes
	Rate \$	Units	Days	Subtotal \$	Rate \$	Units	Days	Subtotal \$	
Project Management/ Meetings	\$1,200 \$800	1 1	4 3	\$4,800 \$2,400	\$1,200 \$800	1 1	3 2	\$3,600 \$1,600	Project Manager (\$1,200/day) and a blended rate for a Project Administrator + Field Manager & Technician (\$800/day). Additional meetings are anticipated if SEA Ring efforts are planned.
Project Management/ Meetings Total				\$7,200				\$5,200	
Planning - Site Logistics/ Permits + Workplan and Quality Assurance Project Plan (QAPP)	\$1,200 \$800	1 1	5 5	\$6,000 \$4,000	\$1,200 \$800	1 1	4 4	\$4,800 \$3,200	
Planning Total				\$10,000				\$8,000	
Field Efforts	*This cost estimate assumes a local project. Additional travel and shipping costs for both <i>in situ</i> SEA Ring and standard lab testing only programs would need to be added for non-local projects. Travel, lodging and shipping costs would be greater for the <i>in situ</i> efforts given the need to have a second trip for SEA Ring retrieval and shipping of the SEA Rings.								
Mobilization	\$650	2	3	\$3,900	\$650	2	1	\$1,300	2 Technicians (8-hr days; \$650/day ea.)
SEA Ring and Datasonde Deployment/ Retrieval	\$1,500 \$1,000	1 3	4 4	\$6,000 \$12,000	\$0 \$0	0 0	0 0	\$0 \$0	PM, and a blended rate for 2 Techs and 1 Field Manager (2 days to deploy + 2 days to retrieve - 10-hr days). PM rate: \$1,500/day, blended Tech/Field Manager rate: \$1,000/10-hr day)
Sample Collection (Tox and Chem)	\$1,000	2	2	\$4,000	\$1,000	2	2	\$4,000	
SEA Ring Cost Reimbursement Fee	\$500	20	---	\$10,000	\$0	---	---	\$0	\$500 per SEA Ring per wk (10 units x 2 wks)
Datasonde Rental Fee (<i>in situ</i> pH, temp, salinity/cond, DO)	\$250	5	14	\$2,500	\$0	0	0	\$0	Assumes 5 datasondes total to capture field replicate variability
Misc. Equipment/ Boat Use Fees	\$3,000	---	---	\$3,000	\$2,000	---	---	\$2,000	Additional for <i>in situ</i> testing to include SEA Ring disposables (tubing), SCUBA support + anchoring supplies and additional small support vessel
Demobilization	\$650	2	3	\$3,900	\$650	2	1	\$1,300	2 Technicians (8-hr days), \$650/day
Field Effort Total				\$45,300				\$8,600	
Laboratory Efforts	---	---	---	---	---	---	---	---	QA/QC required for both <i>in situ</i> and standard laboratory-only testing. Costs include data entry, dose response calculations, and QA/QC review.
<i>Water-only Reference Toxicant Tests</i>	---	---	---	---	---	---	---	---	
Amphipod 96-hr Survival	\$800	1	---	\$800	\$800	1	---	\$800	
Echinoderm or Bivalve Embryo Development	\$1,500	1	---	\$1,500	\$1,500	1	---	\$1,500	
Polychaete 96-hr Survival	\$800	1	---	\$800	\$800	1	---	\$800	
<i>Whole Sediment Tests</i>	---	---	---	---	---	---	---	---	Test animal costs only are included for the <i>in situ</i> testing program using SEA Rings. Unit test costs for the laboratory only program include all testing activities and individual sample data entry, analysis, and QA/QC review.
Amphipod 10-day Survival	\$1,500	1	---	\$1,500	\$1,500	10	---	\$15,000	
Echinoderm or Bivalve Embryo	\$250	1	---	\$250	\$1,500	10	---	\$15,000	
Polychaete 10-day Survival/Growth	\$800	1	---	\$800	\$1,800	10	---	\$18,000	
Whole Sediment QA (Lab and Grain Size Control)	\$1,500	2	---	\$3,000	\$1,500	1	---	\$1,500	Costs for the home sediment laboratory control is included in the standard lab only testing program.
Laboratory Total				\$8,650				\$52,600	
Data Analysis and Reporting	*Analysis costs are provided for toxicity data only. Anticipated efforts related to analysis and reporting of supporting data (e.g. chemistry and benthic community) are site-specific and are expected to be the same for either program for standard analyses.								
Datasondes download/ summary	\$650	1	3	\$1,950	\$650	0	0	\$0	Technician at \$650/day
Field Toxicity Data Summary/Analysis	\$1,200 \$800	1 1	1 2	\$1,200 \$1,600	\$1,200 \$800	0 0	0 0	\$0 \$0	Project Manager (\$1,200/day) and a blended rate for a Project Administrator + Field Manager & Technician (\$800/day).
Laboratory Efforts (incl. QA)	\$1,200 \$800	1 1	2 2	\$2,400 \$1,600	\$1,200 \$800	1 1	2 2	\$2,400 \$1,600	
Draft and Final Report	\$1,200 \$800	1 1	4 4	\$4,800 \$3,200	\$1,200 \$800	1 1	4 4	\$4,800 \$3,200	
Data Analysis and Reporting Total				\$16,750				\$12,000	
PROGRAM TOTAL				\$87,900				\$86,400	

Table 7-6. Summary of comparative costs—whole sediment toxicity assessment for a six-site program.

Task Description	In Situ SEA Ring Technology Program				Standard Laboratory Testing Program				Notes
	Rate \$	Units	Days	Subtotal \$	Rate \$	Units	Days	Subtotal \$	
Project Management/ Meetings	\$1,200	1	4	\$4,800	\$1,200	1	3	\$3,600	Project Manager (\$1,200/day) and a blended rate for a Project Administrator + Field Manager & Technician (\$800/day). Additional meetings are anticipated if SEA Ring efforts are planned.
	\$800	1	3	\$2,400	\$800	1	2	\$1,600	
Project Management/ Meetings Total				\$7,200				\$5,200	
Planning - Site Logistics/ Permits + Workplan and Quality Assurance Project Plan (QAPP)	\$1,200	1	5	\$6,000	\$1,200	1	4	\$4,800	<i>In situ</i> testing requires additional planning due to potential permits/ permission requests. Proj Manager (\$1,200/day) and a blended Field Manager/Tech rate (\$800/day).
	\$800	1	5	\$4,000	\$800	1	4	\$3,200	
Planning Total				\$10,000				\$8,000	
Field Efforts	*This cost estimate assumes a local project. Additional travel and shipping costs for both <i>in situ</i> SEA Ring and standard lab testing only programs would need to be added for non-local projects. Travel, lodging and shipping costs would be greater for the <i>in situ</i> efforts given the need to have a second trip for SEA Ring retrieval and shipping of the SEA Rings.								
Mobilization	\$650	2	2	\$2,600	\$650	2	1	\$1,300	2 Technicians (8-hr days; \$650/day ea.)
SEA Ring and Datasonde Deployment/ Retrieval (SCUBA)	\$1,500	1	3	\$4,500	\$0	0	0	\$0	PM, and a blended rate for 2 Techs and 1 Field Manager (2 days to deploy + 2 days to retrieve - 10 hr days). PM rate: \$1,500/day, blended Tech/Field Manager rate: \$1,000/10-hr day). This effort assumes SCUBA is required to deploy and retrieve SEA Rings using a dive team of 2. For DoD sites an in water team of 3 is required in addition to an additional surface support person. Assume an additional \$2,000/day if a DoD-certified team is required.
	\$1,000	3	3	\$9,000	\$0	0	0	\$0	
Sample Collection (Tox and Chem)	\$1,000	2	1	\$2,000	\$1,000	2	1	\$2,000	Field Manager/Technician (10-hr days). Blended rate of \$1,000/day
SEA Ring Cost Reimbursement Fee	\$500	12	---	\$6,000	\$0	---	---	\$0	\$500 per SEA Ring per wk (6 units x 2 wks)
Datasonde Rental Fee (<i>in situ</i> pH, temp, salinity/cond, DO)	\$250	3	14	\$1,500	\$0	0	0	\$0	Assumes 3 datasondes total to capture field replicate variability
Misc. Equipment/ Boat Use Fees	\$2,500	---	---	\$2,500	\$1,500	---	---	\$1,500	Additional for <i>in situ</i> testing to include SEA Ring disposables (tubing), SCUBA support + anchoring supplies and extra sm. support vessel
Demobilization	\$650	2	3	\$3,900	\$650	2	1	\$1,300	2 Technicians (8-hr days), \$650/day
Field Effort Total				\$32,000				\$6,100	
Laboratory Efforts									
<i>Water-only Reference Toxicant Tests</i>	---	---	---	---	---	---	---	---	QA/QC required for both <i>in situ</i> and standard laboratory-only testing. Costs include data entry, dose response calculations, and QA/QC review.
Amphipod 96-hr Survival	\$800	1	---	\$800	\$800	1	---	\$800	
Echinoderm or Bivalve Embryo Development	\$1,500	1	---	\$1,500	\$1,500	1	---	\$1,500	
Polychaete 96-hr Survival	\$800	1	---	\$800	\$800	1	---	\$800	
<i>Whole Sediment Tests</i>	---	---	---	---	---	---	---	---	Test animal costs only are included for the <i>in situ</i> testing program using SEA Rings. Unit test costs for the laboratory only program include all testing activities and individual sample data entry, analysis, and QA/QC review.
Amphipod 10-day Survival	\$1,200	1	---	\$1,200	\$1,500	6	---	\$9,000	
Echinoderm or Bivalve Embryo	\$250	1	---	\$250	\$1,500	6	---	\$9,000	
Polychaete 10-day Survival/Growth	\$600	1	---	\$600	\$1,800	6	---	\$10,800	
Whole Sediment QA (Lab and Grain Size Control)	\$1,500	2	---	\$3,000	\$1,500	1	---	\$1,500	Costs for the home sediment laboratory control is included in the standard lab only testing program.
Laboratory Total				\$8,150				\$33,400	
Data Analysis and Reporting	*Analysis costs are provided for toxicity data only. Anticipated efforts related to analysis and reporting of supporting data (e.g. chemistry and benthic community) are site-specific and are expected to be the same for either program for standard analyses.								
Datasondes download/ summary	\$650	1	3	\$1,950	\$650	0	0	\$0	Technician at \$650/day
Field Toxicity Data Summary/Analysis	\$1,200	1	1	\$1,200	\$1,200	0	0	\$0	Project Manager (\$1,200/day) and a blended rate for a Project Administrator + Field Manager & Technician (\$800/day).
	\$800	1	2	\$1,600	\$800	0	0	\$0	
Laboratory Efforts (incl. QA)	\$1,200	1	2	\$2,400	\$1,200	1	2	\$2,400	Project Manager (\$1,200/day) and a blended rate for a Project Administrator + Field Manager & Technician (\$800/day).
	\$800	1	2	\$1,600	\$800	1	2	\$1,600	
Draft and Final Report	\$1,200	1	3	\$3,600	\$1,200	1	3	\$3,600	Project Manager (\$1,200/day) and a blended rate for a Project Administrator + Field Manager & Technician (\$800/day).
	\$800	1	4	\$3,200	\$800	1	4	\$3,200	
Data Analysis and Reporting Total				\$15,550				\$10,800	
PROGRAM TOTAL				\$72,900				\$63,500	

Table 7-7. Summary of comparative costs—bioaccumulation assessment for a 10-site program.

Task Description	In Situ SEA Ring Technology Program				Standard Laboratory Testing Program				Notes
	Rate \$	Units	Days	Subtotal \$	Rate \$	Units	Days	Subtotal \$	
Project Management/ Meetings	\$1,200	1	4	\$4,800	\$1,200	1	3	\$3,600	Project Manager (\$1,200/day) and a blended rate for a Project Administrator + Field Manager & Technician (\$800/day). Additional meetings are anticipated if SEA Ring efforts are planned.
	\$800	1	3	\$2,400	\$800	1	2	\$1,600	
Project Management/ Meetings Total				\$7,200				\$5,200	
Planning - Site Logistics/ Permits + Workplan and Quality Assurance Project Plan (QAPP)	\$1,200	1	4	\$4,800	\$1,200	1	3	\$3,600	In situ testing requires additional planning due to potential permits/ permission requests. Proj Manager (\$1,200/day) and a blended Field Manager/Tech rate (\$800/day).
	\$800	1	4	\$3,200	\$800	1	3	\$2,400	
Planning Total				\$8,000				\$6,000	
Field Efforts	*This cost estimate assumes a local project. Additional travel and shipping costs for both in situ SEA Ring and standard lab testing only programs would need to be added for non-local projects. Travel, lodging and shipping costs would be greater for the in situ efforts given the need to have a second trip for SEA Ring retrieval and shipping of the SEA Rings.								
Mobilization	\$650	2	3	\$3,900	\$650	2	1	\$1,300	2 Technicians (8-hr days; \$650/day ea.)
SEA Ring and Datasonde Deployment/ Retrieval (SCUBA)	\$1,500	1	4	\$6,000	\$0	0	0	\$0	PM, and a blended rate for 2 Techs and 1 Field Manager (2 days to deploy + 2 days to retrieve - 10-hr days). PM rate: \$1,500/day, blended Tech/Field Manager rate: \$1,000/10-hr day). This effort assumes SCUBA is required to deploy and retrieve SEA Rings using a dive team of 2. For DoD sites an in water team of 3 is required in addition to an additional surface support person. Assume an additional \$2,000/day if a DoD-certified team is required.
	\$1,000	3	4	\$12,000	\$0	0	0	\$0	
Sample Collection (Bioaccum and Chem)	\$1,000	2	2	\$4,000	\$1,000	2	2	\$4,000	Field Manager/Technician (10-hr days). Blended rate of \$1,000/day
SEA Ring Cost Reimbursement Fee	\$500	20	---	\$10,000	\$0	---	---	\$0	\$500 per SEA Ring per wk (10 units x 2 wks). Total rental fee is considered sufficient in this case whether total exposure is 14 days or 28-days.
Datasonde Rental Fee (in situ pH, temp, salinity/cond, DO)	\$250	5	14	\$2,500	\$0	0	0	\$0	Assumes 5 datasondes total to capture field replicate variability
Misc. Equipment/ Boat Use Fees	\$2,500	---	---	\$2,500	\$1,500	---	---	\$1,500	Additional for in situ testing to include SEA Ring disposables (tubing), SCUBA support + anchoring supplies and extra sm. support vessel
Demobilization	\$650	2	4	\$5,200	\$650	2	1	\$1,300	2 Technicians (8-hr days), \$650/day
Field Effort Total				\$46,100				\$8,100	
Bioaccumulation Laboratory Efforts	---	---	---	---	---	---	---	---	QA/QC required for both in situ and standard laboratory-only testing. Costs include data entry, analysis, and QA/QC review.
Bivalve 14-28-Day Exposure	\$1,400	1	---	\$1,400	\$3,000	10	---	\$30,000	Test animal costs only are included for in situ program using the SEA Rings. Unit test costs for the standard laboratory only program include sample data entry, analysis, and QA/QC review. Analytical tissue chemistry costs are not included in either estimate.
Polychaete 14-28-Day Exposure	\$500	1	---	\$500	\$3,000	10	---	\$30,000	
Laboratory QA (Water only and home sediment controls)	\$2,500	2	---	\$5,000	\$0	0	---	\$0	Costs for a water-only and home sediment laboratory control are included in the unit test costs for the standard laboratory only testing program.
Laboratory Total				\$6,900				\$60,000	
Data Analysis and Reporting	*Analysis costs are provided for bioaccumulation survival and test water quality data only. Anticipated efforts related to analysis and reporting of supporting data (e.g. chemistry, toxicity, and benthic community) is site-specific and are expected to be the same for either program for any standard analyses.								
Datasondes download/ summary	\$650	1	3	\$1,950	\$650	0	0	\$0	Technician at \$650/day
Field Bioaccumulation Data Summary/Analysis	\$1,200	1	0.5	\$600	\$1,200	0	0	\$0	Project Manager (\$1,200/day) and a blended rate for a Project Administrator + Field Manager & Technician (\$800/day).
	\$800	1	1	\$800	\$800	0	0	\$0	
Laboratory Efforts (incl. QA)	\$1,200	1	0.5	\$600	\$1,200	1	1	\$1,200	Project Manager (\$1,200/day) and a blended rate for a Project Administrator + Field Manager & Technician (\$800/day).
	\$800	1	0.5	\$400	\$800	1	2	\$1,600	
Draft and Final Report	\$1,200	1	2	\$2,400	\$1,200	1	2	\$2,400	Project Manager (\$1,200/day) and a blended rate for a Project Administrator + Field Manager & Technician (\$800/day).
	\$800	1	3	\$2,400	\$800	1	3	\$2,400	
Data Analysis and Reporting Total				\$9,150				\$7,600	
PROGRAM TOTAL				\$77,350				\$86,900	

Table 7-8. Summary of comparative costs—bioaccumulation assessment for a six-site program.

Task Description	In Situ SEA Ring Technology Program				Standard Laboratory Testing Program				Notes
	Rate \$	Units	Days	Subtotal \$	Rate \$	Units	Days	Subtotal \$	
Project Management/ Meetings	\$1,200 \$800	1 1	4 3	\$4,800 \$2,400	\$1,200 \$800	1 1	3 2	\$3,600 \$1,600	Project Manager (\$1,200/day) and a blended rate for a Project Administrator + Field Manager & Technician (\$800/day). Additional meetings are anticipated if SEA Ring efforts are planned.
Project Management/ Meetings Total				\$7,200				\$5,200	
Planning - Site Logistics/ Permits + Workplan and Quality Assurance Project Plan (QAPP)	\$1,200 \$800	1 1	4 4	\$4,800 \$3,200	\$1,200 \$800	1 1	3 3	\$3,600 \$2,400	In situ testing requires additional planning due to potential permits/ permission requests. Proj Manager (\$1,200/day) and a blended Field Manager/Tech rate (\$800/day).
Planning Total				\$8,000				\$6,000	
Field Efforts	*This cost estimate assumes a local project. Additional travel and shipping costs for both in situ SEA Ring and standard lab testing only programs would need to be added for non-local projects. Travel, lodging and shipping costs would be greater for the in situ efforts given the need to have a second trip for SEA Ring retrieval and shipping of the SEA Rings.								
Mobilization	\$650	2	2	\$2,600	\$650	2	1	\$1,300	2 Technicians (8-hr days; \$650/day ea.)
SEA Ring and Datasonde Deployment/ Retrieval (SCUBA)	\$1,500 \$1,000	1 3	3 3	\$4,500 \$9,000	\$0 \$0	0 0	0 0	\$0 \$0	PM, and a blended rate for 2 Techs and 1 Field Manager (2 days to deploy + 2 days to retrieve - 10-hr days). PM rate: \$1,500/day, blended Tech/Field Manager rate: \$1,000/10-hr day). This effort assumes SCUBA is required to deploy and retrieve SEA Rings using a dive team of 2. For DoD sites an in water team of 3 is required in addition to an additional surface support person. Assume an additional \$2,000/day if a DoD-certified team is required.
Sample Collection (Bioaccum and Chem)	\$1,000	2	1	\$2,000	\$1,000	2	1	\$2,000	
SEA Ring Cost Reimbursement Fee	\$500	12	---	\$6,000	\$0	---	---	\$0	\$500 per SEA Ring per wk (6 units x 2 wks). Total rental fee is considered sufficient in this case whether total exposure is 14 days or 28-days.
Datasonde Rental Fee (in situ pH, temp, salinity/cond, DO)	\$250	3	14	\$1,500	\$0	0	0	\$0	Assumes 3 datasondes total to capture field replicate variability
Misc. Equipment/ Boat Use Fees	\$2,500	---	---	\$2,500	\$1,500	---	---	\$1,500	Additional for in situ testing to include SEA Ring disposables (tubing), SCUBA support + anchoring supplies and additional small support vessel.
Demobilization	\$650	2	3	\$3,900	\$650	2	1	\$1,300	2 Technicians (8-hr days), \$650/day
Field Effort Total				\$32,000				\$6,100	
Bioaccumulation Laboratory Efforts	---	---	---	---	---	---	---	---	QA/QC required for both in situ and standard laboratory-only testing. Costs include data entry, analysis, and QA/QC review
Bivalve 14-28-Day Exposure	\$1,400	1	---	\$1,400	\$3,000	6	---	\$18,000	Test animal costs only are included for in situ program using the SEA Rings. Unit test costs for the standard laboratory only program include sample data entry, analysis, and QA/QC review. Analytical tissue chemistry costs are not included in either estimate.
Polychaete 14-28-Day Exposure	\$500	1	---	\$500	\$3,000	6	---	\$18,000	
Laboratory QA (Water only and home sediment controls)	\$2,500	2	---	\$5,000	\$0	0	---	\$0	Costs for a water-only and home sediment laboratory control are included in the unit test costs for the standard laboratory only testing program.
Laboratory Total				\$6,900				\$36,000	
Data Analysis and Reporting	*Analysis costs are provided for bioaccumulation survival and test water quality data only. Anticipated efforts related to analysis and reporting of supporting data (e.g. chemistry, toxicity, and benthic community) is site-specific and are expected to be the same for either program for any standard analyses.								
Datasondes download/ summary	\$650	1	3	\$1,950	\$650	0	0	\$0	Technician at \$650/day
Field Bioaccumulation Data Summary/Analysis	\$1,200 \$800	1 1	0.5 1	\$600 \$800	\$1,200 \$800	0 0	0 0	\$0 \$0	Project Manager (\$1,200/day) and a blended rate for a Project Administrator + Field Manager & Technician (\$800/day).
Laboratory Efforts (incl. QA)	\$1,200 \$800	1 1	0.5 0.5	\$600 \$400	\$1,200 \$800	1 1	1 2	\$1,200 \$1,600	
Draft and Final Report	\$1,200 \$800	1 1	2 2	\$2,400 \$1,600	\$1,200 \$800	1 1	2 2	\$2,400 \$1,600	
Data Analysis and Reporting Total				\$8,350				\$6,800	
PROGRAM TOTAL				\$62,450				\$60,100	

Table 7-9. Summary of comparative costs—water column toxicity assessment for a 10-site program.

Task Description	In Situ SEA Ring Technology Program				Standard Laboratory Testing Program				Notes
	Rate \$	Units	Days	Subtotal \$	Rate \$	Units	Days	Subtotal \$	
Project Management/ Meetings	\$1,200	1	4	\$4,800	\$1,200	1	3	\$3,600	Project Manager (\$1,200/day) and a blended rate for a Project Administrator + Field Manager & Technician (\$800/day). Additional meetings are anticipated if SEA Ring efforts are planned.
	\$800	1	3	\$2,400	\$800	1	2	\$1,600	
Project Management/ Meetings Total				\$7,200				\$5,200	
Planning - Site Logistics/ Permits + Workplan and Quality Assurance Project Plan (QAPP)	\$1,200	1	5	\$6,000	\$1,200	1	4	\$4,800	In situ testing requires additional planning due to potential permits/ permission requests. PM (\$1,200/day) and a blended Field Manager/Tech rate (\$800/day).
	\$800	1	5	\$4,000	\$800	1	4	\$3,200	
Planning Total				\$10,000				\$8,000	
Field Efforts	*This cost estimate assumes a local project. Additional travel and shipping costs for both in situ SEA Ring and standard lab testing only programs would need to be added for non-local projects. Travel, lodging and shipping costs would be greater for the in situ efforts given the need to have a second trip for SEA Ring retrieval and shipping of the SEA Rings.								
Mobilization	\$650	2	3	\$3,900	\$650	2	1	\$1,300	2 Technicians (8-hr days; \$650/day ea.)
SEA Ring and Datasonde Deployment/ Retrieval (SCUBA)	\$1,500	1	4	\$6,000	\$0	0	0	\$0	PM, and a blended rate for 2 Techs and 1 Field Manager (2 days to deploy + 2 days to retrieve 10-hr days). PM rate: \$1,500/day, blended Tech/Field Manager rate: \$1,000/10-hr day). This effort assumes SCUBA is required to deploy and retrieve SEA Rings using a dive team of 2. For DoD sites an in water team of 3 is required in addition to an additional surface support person. Assume an additional \$2,000/day if a DoD-certified team is required.
	\$1,000	3	4	\$12,000	\$0	0	0	\$0	
Sample Collection (Tox and Chem)	\$1,000	2	1	\$2,000	\$1,000	2	1	\$2,000	Field Manager/Technician (10-hr days). Blended rate of \$1,000/day
SEA Ring Cost Reimbursement Fee	\$500	10	---	\$5,000	\$0	---	---	\$0	\$500 per SEA Ring per wk (10 units x 1 wk)
Datasonde Rental Fee (in situ pH, temp, salinity/cond, DO)	\$250	5	7	\$2,500	\$0	0	0	\$0	Assumes 5 datasondes total to capture field replicate variability
Misc. Equipment/ Boat Use Fees	\$2,500	---	---	\$2,500	\$2,000	---	---	\$2,000	Additional for in situ to include SEA Ring disposables (tubing), SCUBA support + anchoring supplies and extra sm. support vessel
Demobilization	\$650	2	4	\$5,200	\$650	2	1	\$1,300	2 Technicians (8-hr days), \$650/day
Field Effort Total				\$39,100				\$6,600	
Laboratory Efforts	---	---	---	---	---	---	---	---	Lab-based QA/QC testing (lab controls and reference toxicant tests) are required for both in situ and standard laboratory-only testing. Unit test costs include data entry, analysis, and QA/QC review. For giant kelp, 2 reference toxicant tests are required to support in situ testing: 1) a standard exposure of spores to a reference toxicant dilution series; and 2) exposure of sporophyll blades to a reference toxicant dilution series followed by a release and 48-hr exposure in clean seawater.
Reference Toxicant Tests	---	---	---	---	---	---	---	---	
Mysid Acute 96-hr Survival	\$800	1	---	\$800	\$800	1	---	\$800	
Echinoderm or Bivalve Embryo Development	\$1,500	1	---	\$1,500	\$1,500	1	---	\$1,500	
Giant Kelp 48-hr spore germ. and growth	\$1,800	2	---	\$3,600	\$1,800	1	---	\$1,800	
Water Column Tests	---	---	---	---	---	---	---	---	Test animal costs only are provided for mysids and echinoderm/bivalve embryos for the in situ testing program using the SEA Rings. The cost for in situ giant kelp includes exposure of sporophyll blades from each site to clean laboratory seawater, followed by extraction and testing of the spores in clean seawater (laboratory-based tests). Costs include all testing activities and individual sample data entry and QA/QC review.
Mysid Acute 96-hr Survival	\$500	1	---	\$500	\$800	10	---	\$8,000	
Echinoderm or Bivalve Embryo Development	\$250	1	---	\$250	\$1,500	10	---	\$15,000	
Giant Kelp 48-hr spore germ. and growth	\$2,500	1	---	\$2,500	\$1,800	10	---	\$18,000	
Laboratory Total				\$9,150				\$45,100	
Data Analysis and Reporting	*Analysis costs are provided for toxicity data only. Anticipated efforts related to analysis and reporting of supporting data (e.g. chemistry and benthic community) are site-specific and are expected to be the same for either program for any standard analyses.								
Datasondes download/ summary	\$650	1	3	\$1,950	\$650	0	0	\$0	Technician at \$650/day
Field Toxicity Data Summary/Analysis	\$1,200	1	1	\$1,200	\$1,200	0	0	\$0	Project Manager (\$1,200/day) and a blended rate for a Project Administrator + Field Manager & Technician (\$800/day).
	\$800	1	2	\$1,600	\$800	0	0	\$0	
Laboratory Efforts (incl. QA)	\$1,200	1	2	\$2,400	\$1,200	1	2	\$2,400	
	\$800	1	2	\$1,600	\$800	1	2	\$1,600	
Draft and Final Report	\$1,200	1	4	\$4,800	\$1,200	1	4	\$4,800	
	\$800	1	4	\$3,200	\$800	1	4	\$3,200	
Data Analysis and Reporting Total				\$16,750				\$12,000	
PROGRAM TOTAL				\$82,200				\$76,900	

Table 7-10. Summary of comparative costs—water column toxicity assessment for a six-site program.

Task Description	In Situ SEA Ring Technology Program				Standard Laboratory Testing Program				Notes
	Rate \$	Units	Days	Subtotal \$	Rate \$	Units	Days	Subtotal \$	
Project Management/ Meetings	\$1,200	1	4	\$4,800	\$1,200	1	3	\$3,600	Project Manager (\$1,200/day) and a blended rate for a Project Administrator + Field Manager & Technician (\$800/day). Additional meetings are anticipated if SEA Ring efforts are planned.
	\$800	1	3	\$2,400	\$800	1	2	\$1,600	
Project Management/ Meetings Total				\$7,200				\$5,200	
Planning - Site Logistics/ Permits + Workplan and Quality Assurance Project Plan (QAPP)	\$1,200	1	5	\$6,000	\$1,200	1	4	\$4,800	In situ testing requires additional planning due to potential permits/ permission requests. Proj Manager (\$1,200/day) and a blended Field Manager/Tech rate (\$800/day).
	\$800	1	5	\$4,000	\$800	1	4	\$3,200	
Planning Total				\$10,000				\$8,000	
Field Efforts	*This cost estimate assumes a local project. Additional travel and shipping costs for both in situ SEA Ring and standard lab testing only programs would need to be added for non-local projects. Travel, lodging and shipping costs would be greater for the in situ efforts given the need to have a second trip for SEA Ring retrieval and shipping of the SEA Rings.								
Mobilization	\$650	2	2	\$2,600	\$650	2	1	\$1,300	2 Technicians (8-hr days; \$650/day ea.)
SEA Ring and Datasonde Deployment/ Retrieval (SCUBA)	\$1,500	1	3	\$4,500	\$0	0	0	\$0	PM, and a blended rate for 2 Techs and 1 Field Manager (2 days to deploy + 2 days to retrieve 10-hr days). PM rate: \$1,500/day, blended Tech/Field Manager rate: \$1,000/10-hr day). This effort assumes SCUBA is required to deploy and retrieve SEA Rings using a dive team of 2. For DoD sites an in water team of 3 is required in addition to an additional surface support person. Assume an additional \$2,000/day if a DoD-certified team is required.
	\$1,000	3	3	\$9,000	\$0	0	0	\$0	
Sample Collection (Tox and Chem)	\$1,000	2	1	\$2,000	\$1,000	2	1	\$2,000	Field Manager/Technician (10-hr days). Blended rate of \$1,000/day
SEA Ring Cost Reimbursement Fee	\$500	6	---	\$3,000	\$0	---	---	\$0	\$500 per SEA Ring per wk (6 units x 1 wk)
Datasonde Rental Fee (in situ pH, temp, salinity/cond, DO)	\$250	3	7	\$1,500	\$0	0	0	\$0	Assumes 3 datasondes total to capture field replicate variability
Misc. Equipment/ Boat Use Fees	\$2,000	---	---	\$2,000	\$1,500	---	---	\$1,500	Additional for in situ to include SEA Ring disposables (tubing), SCUBA support + anchoring supplies and extra sm. support vessel
Demobilization	\$650	2	3	\$3,900	\$650	2	1	\$1,300	2 Technicians (8-hr days), \$650/day
Field Effort Total				\$28,500				\$6,100	
Laboratory Efforts	---	---	---	---	---	---	---	---	Lab-based QA/QC testing (lab controls and reference toxicant tests) are required for both in situ and standard laboratory-only testing. Unit test costs include data entry, analysis, and QA/QC review. For giant kelp, 2 reference toxicant tests are required to support in situ testing: 1) a standard exposure of spores to a reference toxicant dilution series; and 2) exposure of sporophyll blades to a reference toxicant dilution series followed by a release and 48-hr exposure in clean seawater.
Reference Toxicant Tests	---	---	---	---	---	---	---	---	
Mysid Acute 96-hr Survival	\$800	1	---	\$800	\$800	1	---	\$800	
Echinoderm or Bivalve Embryo Development	\$1,500	1	---	\$1,500	\$1,500	1	---	\$1,500	
Giant Kelp 48-hr spore germ. and growth	\$1,800	2	---	\$3,600	\$1,800	1	---	\$1,800	
Water Column Tests	---	---	---	---	---	---	---	---	
Mysid Acute 96-hr Survival	\$500	1	---	\$500	\$800	6	---	\$4,800	Test animal costs only are provided for mysids and echinoderm/bivalve embryos for the in situ testing program using the SEA Rings. The cost for in situ giant kelp includes exposure of sporophyll blades from each site to clean laboratory seawater, followed by extraction and testing of the spores in clean seawater (laboratory-based tests). Costs include all testing activities and individual sample data entry and QA/QC review.
Echinoderm or Bivalve Embryo Development	\$250	1	---	\$250	\$1,500	6	---	\$9,000	
Giant Kelp 48-hr spore germ. and growth	\$1,800	1	---	\$1,800	\$1,800	6	---	\$10,800	
Laboratory Total				\$8,450				\$28,700	
Data Analysis and Reporting	*Analysis costs are provided for toxicity data only. Anticipated efforts related to analysis and reporting of supporting data (e.g. chemistry and benthic community) are site-specific and are expected to be the same for either program for any standard analyses.								
Datasondes download/ summary	\$650	1	3	\$1,950	\$650	0	0	\$0	Technician at \$650/day
Field Toxicity Data Summary/Analysis	\$1,200	1	1	\$1,200	\$1,200	0	0	\$0	Project Manager (\$1,200/day) and a blended rate for a Project Administrator + Field Manager & Technician (\$800/day).
	\$800	1	2	\$1,600	\$800	0	0	\$0	
Laboratory Efforts (incl. QA)	\$1,200	1	2	\$2,400	\$1,200	1	2	\$2,400	
	\$800	1	2	\$1,600	\$800	1	2	\$1,600	
Draft and Final Report	\$1,200	1	3	\$3,600	\$1,200	1	3	\$3,600	
	\$800	1	4	\$3,200	\$800	1	4	\$3,200	
Data Analysis and Reporting Total				\$15,550				\$10,800	
PROGRAM TOTAL				\$69,700				\$58,800	

Table 7-11. Total per sample cost comparison for the three scenarios provided above^a.

Program Type and Scope ^b	Laboratory-Only Testing Program (\$)	<i>In Situ</i> -Based Testing Program Using the SEA Rings (\$)
Whole sediment toxicity assessment for a 10-site program	8,790	8,640
Whole sediment toxicity assessment for a six-site program	12,150	10,583
Bioaccumulation assessment for a 10-site program	7,735	8,690
Bioaccumulation assessment for a six-site program	10,408	10,017
Water column toxicity assessment for a 10-site program	8,220	7,690
Water column toxicity assessment for a six-site program	11,617	9,800

^a Per sample cost estimates include all planning, field sampling, laboratory and/or field testing for all listed species and endpoints, and associated reporting efforts.

^b Costs for this assessment assume a local project. Add travel and shipping for a remote effort.

8. IMPLEMENTATION ISSUES

8.1 COST OBSERVATIONS

The key cost drivers for the SEAP technology are labor, analytical laboratory, supplies, transportation, and capital equipment costs associated with planning, mobilizing, operating, demobilizing, data analysis, and reporting. Based on potential charge rates, capital costs for the SEA Rings are easily recaptured over the life of the unit. SEA Ring capital costs could be reduced if more units are manufactured over time.

Operating costs for the technologies should decrease (1) as field personnel grow in experience, and become more efficient in executing the projects, and (2) as the equipment becomes more widely used and personnel at lower labor rates are available to execute the projects.

8.2 PERFORMANCE OBSERVATIONS

Performance of the SEA Rings was generally in line with expectations. Lessons learned and minor design modifications were implemented between sampling events, resulting in optimized SOPs and equipment design. The magnitude and gradient of PCB contamination at the PSNS remediation site was less than anticipated, though a clear trend in bioaccumulation was still successfully observed using the SEA Ring methodology. The toxicity and concentration of key chemicals of primary concern in end-of-pipe stormwater off NBSD was also less than anticipated, likely due to the extreme size of the storm and resulting dilution. However, the demonstration at this site also was able to meet test acceptability criteria and successfully differentiate locations with greater impact from those further away from the outfall. Three of the SEA Rings used for the NBSD stormwater demonstration were, however, found to be plumbed backwards after deployment. This resulted in a pocket of air and potentially less flow in those test replicates with reverse plumbing. This was a user error, not equipment malfunction, and thus a standard operating procedure lesson learned for future efforts.

Battery life was a documented issue in a few cases where the pumps stopped working prior to the termination of the full exposure. Those SEA Rings plumbed backwards in the NBSD demonstration were found to also have extinguished batteries on retrieval, presumably due to increased friction and load on the pumps. A few SEA Rings used at the Bremerton and Quantico demonstrations also lost battery power sometime before retrieval for unknown reasons. Given these challenges, a Version 3 SEA Ring was introduced in 2015 and 13 units were purchased through an SSC Pacific internal research program, which optimized the pumping system. The most significant change was the replacement of the central peristaltic pump with small submersible centrifugal pumps, one for each replicate chamber. These small pumps can be to pump at rates as desired, and also use much less collective energy than the single peristaltic pump. The new pump system in the Version 3 unit has performed very well and has virtually eliminated battery life (and pump jamming) issues, and has increased the deployment time option to well over a month while maintaining water quality at levels above that from previous 2-week deployments. As an example, four Version 3 SEA Rings were recently (2016) incorporated into the *in situ* receiving water monitoring under Dr. Danny Reible's SERDP Project #ER-2428, during which all units performed optimally for 28 days. The existing SEA Ring platform can easily be re-configured to accommodate the new pump system at a cost of approximately \$2,500 per SEA Ring.

One additional performance objective not achieved at every site has been the ability to deploy and retrieve the SEA Rings for sediment assessments without diver support. Several methods have been developed and tested that show promise, but consistent success for any of the methods tried is highly dependent on the sample type and potential physical interferences at any given site. The

heterogeneity of the bottom at those sites evaluated during the demonstrations raised enough concern to abandon any attempts without diver-assisted deployments and recovery. Extensive shell debris and worm tubes along with the amendment itself at PSNS made deployment and recovery of the SEA Rings challenging, even with divers. Likewise, woody debris at MCB Quantico made this a challenging site as well. The use of divers ensured secure placement in areas with limited interference, and successful recovery of sediment in each replicate core by digging around and manually securing a cap to each. On the other hand, all deployments and recovery of SEA Rings for the stormwater demonstration at NBSD were conducted from the surface without any in-water support.

8.3 SCALE-UP

Scale-up for this technology is not a factor because the demonstrations were performed at full scale. All three site demonstrations were designed to include the range of issues associated with a full-scale integrative *in situ* assessment. Based on the experience with these sites and others that have been assessed recently using the SEAP technology, the SEA Rings are adaptable to a range of scales in various ways to meet a given site's specific requirements.

8.4 OTHER SIGNIFICANT OBSERVATIONS

No significant obstacles are anticipated for the implementation of this technology. Commercialization of both the equipment and the service support functions has already occurred, and many independent sites have already been characterized using the technology.

8.5 LESSONS LEARNED

A number of important lessons were learned during the progression of the demonstrations. All three demonstrations were based on commercial off-the-shelf SEA Rings that were produced by Zebra-Tech Ltd. Based on experience from the demonstrations, a list of modifications to further enhance the capability of the SEA Rings and to make them more user friendly have since been identified and developed into the latest commercially available system (Version 3). Revised standard operating procedures, a new pumping system, and modified test chambers to increase flow have been developed as described in earlier sections of this report and in Appendices A and B.

Sediment capture devices can be entertained and used for locations with a known physically consistent surface, however, in-water support should currently still be planned for near term sediment assessment programs until a more fail safe capture device demonstrated. Underwater video/photo/audio capabilities were also very useful during the demonstration projects to confirm placement and monitor performance without being in the water. Use of this ancillary support is recommended as a standard practice, whenever available.

Additional knowledge was gained related to effective anchoring methods for the SEA Ring units *in situ*, use of clear and proper labeling to withstand the elements, and planning stages including the importance of good communication and obtaining proper permission(s) for *in situ* installations and testing. These lessons learned have been incorporated into updated SOPs where appropriate.

8.6 END-USER ISSUES

End-user concerns, reservations, and decision-making factors have been assessed throughout the demonstrations, and to the extent possible, these issues were addressed through modifications to the technology or methodologies that describe its use.

8.7 APPROACH TO REGULATORY COMPLIANCE AND ACCEPTANCE

There have been extensive efforts over the past several years of the demonstration program to gain acceptance to use the technology for a range of regulatory compliance efforts at both DoD and non-DoD locations. Demonstration results for this effort were incorporated into a much broader evaluation of sediment remedy effectiveness at PSNS and Marine Corps Base Quantico. These results will be available for review and comment by relevant local, state, and federal regulators, and stakeholders. The demonstration at NBSD will provide valuable support related to NPDES Permit compliance for stormwater discharges from the base.

The ability of the SEA Rings to provide comparable toxicity and bioaccumulation data relative to traditional EPA and ASTM-approved laboratory methods in concurrent side-by-side testing was evaluated under the U.S. EPA's Environmental Technology Verification (ETV) third party testing program. Results of this evaluation concluded that the SEA Ring produced toxicity and bioaccumulation test results that were highly comparable to standard laboratory-based methods when conducted under similar exposure conditions in both spiked seawater and contaminated sediments. Although the SEA Rings are intended for field use, the study suggested that the device can provide data that meets standard EPA and ASTM recommendations for quality assurance and quality control. The demonstration has been signed off by EPA and a Final ETV Report was published in 2014 (McKernan et al., 2014); https://archive.epa.gov/nrmrl/archive-etv/web/pdf/sea-ring-verification-statement_signed.pdf; and https://archive.epa.gov/nrmrl/archive-tv/web/pdf/sea_ring_etv_final_report_23dec13.pdf.

Extensive outreach efforts have also been conducted throughout the course of the SEAP technology demonstration program. Technology transfer of the SEAP methodology to numerous DoD and non-DoD activities that could use this technology has been accomplished through the publication of articles (Burton et al., 2012 and Rosen et al., 2012), the distribution of a white paper (Stransky et al., 2009), and the presentation of the technology and demonstration results at conferences (Rosen et al., 2011, Rosen et al., 2012b, Burton et al., 2013, Stransky 2011, 2013, and 2014; Stransky et al., 2014a; and Tait et al., 2014). An article was also published in the widely distributed international SEA Technology™ magazine (Rosen, Radford and Stransky, 2014). Further information regarding the technology and its commercial availability through Zebra Tech, Ltd are available online (<http://www.zebra-tech.co.nz/>).

Finally, in-person meetings have been organized to present the potential benefits of the SEAP technology with various local and regional regulators in California as new state policies and NPDES Permits are being drafted related to assessing the toxicity of stormwater. The interest level received has been exceptionally high and encouraging. The technology was highlighted in front of a regional monitoring coalition in southern California to support large-scale regional efforts in 2013 known as Bight '13 (Stransky, 2014b). We expect that demonstration of similar sediment testing methods will occur as part of future monitoring efforts to support the Bight program.

As stated previously, commercial equipment suppliers and service providers have already been identified and are currently applying the technologies at many sites. At the time of this publication negotiations are also in progress to potentially use the SEA Ring Technology to support NPDES compliance requirements for the first large-scale desalination plant on the U.S. West Coast, as well as the first offshore aquaculture facility currently in the development stage to be placed off the coast of southern California. Together, these collective efforts should help to successfully transition this technology to support both DoD and commercial needs.

9. REFERENCES

- AMEC Environment & Infrastructure (AMEC). 2011. Storm Water Treatment System Evaluation and Cost Estimate. Technical Memorandum prepared for the Ports of Los Angeles and Long Beach. January 31, 2011.
- AMEC. 2010–2014a. NPDES Semi-Annual Wet Weather Monitoring Reports for UCSD’s Scripps Institution of Oceanography. (2010, 2011, 2012, 2013, and 2014 semi-annual wet weather reports).
- AMEC. 2010–2014b. NPDES Semi-Annual Dry Weather Monitoring Reports for UCSD’s Scripps Institution of Oceanography. (2010, 2011, 2012, 2013, and 2014 semi-annual dry weather reports).
- AMEC. 2015. Pulsed Salinity, Pyrethroid and Copper Study. Report Submitted to City of San Diego. May 2015.
- Anderson B.S., J.W. Hunt, B.M. Phillips, P.A. Nicely, R.S. Tjeerdema, and M. Martin. 2004. A comparison of *in situ* and laboratory toxicity tests with the estuarine amphipod *Eohaustorius estuarius*. Arch. Environ. Contam. Toxicol., 46:52-60.
- ASTM. 1999. Standard Guide for Conducting Acute Toxicity Tests with Echinoid Embryos (ASTM E1563-98).
- ASTM. 2000a. Standard Guide for Conducting Sediment Toxicity Tests with Marine and Estuarine Polychaetous Annelids. American Society for Testing and Materials. E1611-99. In Annual Book of Standards, Vol. 11.05, Philadelphia, PA.
- ASTM. 2000b. Standard Guide for Determination of the Bioaccumulation of Sediment Associated Contaminants by Benthic Invertebrates. E1688-00.
- ASTM. 2010. Standard Test Method for Measuring the Toxicity of Sediment-Associated Contaminants with Freshwater Invertebrates. E1706-05.
- Battelle and Neptune and Company. 2004. Final Quantico Watershed Study, Post Interim Remedial Action (Post IRA) Study Report. Prepared for the U.S. Navy, Chesapeake Division Naval Facilities Engineering Command, Washington, Washington, D.C.
- Battelle, M. Otten, and Neptune and Company. 2007. Final Quantico Embayment (Site 99) Southern Wetlands (Site 96), and Potomac River Southern Area 1 Feasibility Study.
- Battelle. 2009. Draft-Final Remedial Design IR Site 96 Southern Wetlands and IR Site 99 Quantico Embayment Marine Corps Base Quantico Quantico, Virginia Revision No. 00. Contract N62470-D-08-1006. Prepared for NAVFAC Washington, Washington D.C.
- Burton GA Jr, Hickey CW, DeWitt TH, Roper DS, Morrisey DJ, and Nipper MG. 1996. *In situ* toxicity testing: teasing out the environmental stressors. SETAC News 16 (5), 20-22.
- Burton GA Jr, M.S. Greenberg, C.D. Rowland, C.A. Irvine, D.R. Lavoie, J.A. Brooker, L. Moore, D.F.N. Raymer, and R.A. McWilliam. 2005. *In situ* exposures using caged organisms: a multi-compartment approach to detect aquatic toxicity and bioaccumulation. Environmental Pollution, 134: 133-144.
- Burton GA, D.B. Chadwick, G. Rosen, and M.S. Greenberg. 2011. Sediment Ecosystem Assessment Protocol (SEAP): An Accurate and Integrated Weight-of-Evidence (WOE) Based System. SERDP Project #ER-1550, Final Technical Report, January 2011.

- Burton GA Jr., G. Rosen, D.B. Chadwick, M.S. Greenberg, K. Taulbee, G. Lotufo, and D. Reible, 2012. A sediment ecotoxicity assessment platform for *in situ* measures of chemistry, bioaccumulation, and toxicity. Part 1: System description and proof of concept. *Environmental Pollution* 162:449-456.
- Burton GA, G. Rosen, D.B. Chadwick, C. Stransky, H. Bailey, M.S. Greenberg, and J. Radford. 2013. Improved *In Situ* Approach for Assessing Sediment Ecological Risk, Remediation Effectiveness and Stormwater Impacts. 7th Intern Conf Remediation of Contaminated Sediments. Dallas, TX.
- Chadwick D.B., V.J. Kirtay, K. Merritt, J. Conder, and V. Magar 2009. Demonstration and Validation of Enhanced Monitored Natural Recovery at DoD Sites. ESTCP Project #ER-0827.
- Chappie DJ, and G.A. Burton, Jr., 2000. Applications of aquatic and sediment toxicity testing *in situ*, *Soil and Sediment Contamination* 9(3):219-245.
- Cibor A, K. Payne, C. Stransky, and G. Rosen, 2014. Modified Test Method to Conduct *In Situ* Toxicity Tests with Giant Kelp - Performance Results for Storm Water Exposures in Marine Receiving Water. SETAC North America 35th Annual Meeting, Vancouver, Canada, 9-13 Nov 2014.
- Crane M, G.A. J.M. Burton, M.S. Culp, K.R. Greenberg, R. Munkittrick, M.H. Ribeiro, Salazar, and S.D. St-Jean. 2007. Review of *in situ* approaches for stressor and effect diagnosis. *Integr Environ Assess Mgmt.* 3:234-245
- Dillon T.M., D.W. Moore, and A.B. Gibson. 1993. Development of a chronic sublethal bioassay for evaluating contaminated sediment with the marine polychaete worm *Nereis (Neanthes) arenaceodentata*. *Environ. Toxicol. Chem.*, 12:589-605.
- INAP. 2002. Diffusive gradients in thin-films (DGT): A technique for determining bioavailable metal concentrations. International Network for Acid Prevention. March 2002.
- Fairey R., C. Bretz, S. Lamerdin, J. Hunt, B. Anderson, S. Tudor, C. Wilson, F. LaCaro, M. Stephensen, M. Puckett, and E. Long. 1996. Chemistry, toxicity and benthic community conditions in sediments of the San Diego Bay Regions. State Water Resources Control Board, Sacramento, CA. 169 pp.
- Jones R.P., R.N. Millward, R.A. Karn, and A.H. Harrison. 2006. Microscale analytical methods for the quantitative detection of PCBS and PAHS in small tissue masses. *Chemosphere* 62: 1795-1805.
- Kater B.J., J.F. Postma, M. Dubbeldam, J. Prins. 2001. Comparison of laboratory and *in situ* sediment bioassays using *Corophium volutator*. *Environ. Toxicol. Chem.*, 20:1291-1295.
- Katz C.N., G. Rosen, E. Arias. 2006. Storm water toxicity evaluation at Naval Station San Diego, Naval Submarine Base San Diego, Naval Amphibious Base Coronado, and Naval Air Station North Island. SPAWAR Systems Center San Diego Technical Report 1938, May 2006, 151 pp.
- Kayhanian M., C. Stransky, S. Bay, S.L. Lau, and M.K. Stenstrom. 2008. Toxicity of urban highway runoff with respect to storm duration. *Sci Tot Environ* 389:386-406.
- Kirtay V.J., D. B. Chadwick, G. Rosen, E. Arias, and J. Germano. 2016a "Reactive Amendments Treatability Study." Technical Report. (in prep). " Space and Naval Warfare Systems Center (SSC Pacific). San Diego, CA.

- Kirtay .V, G. Rosen, M. Colvin, J. Guerrero, L. Hsu, E. Arias, R.K. Johnston, D.B. Chadwick, M. Grover, J. Arblaster, V. Magar, J. Conder, R. Webb, J. Collins, J. Germano, and A. Conrad. 2016b. Demonstration of *In Situ* Treatment with Reactive Amendments for Contaminated Sediments in Active DoD Harbors. Draft Final Report for ESTCP Project ER-201131.
- Kirtay .V, G. Rosen, M. Colvin, J. Guerrero, C. Katz, B. Chadwick, M. Grover, J. Conder, K. Fetters, V. Magar, J. T. Weidner, in prep. Demonstration and Validation of Enhanced Monitored Natural Recovery at Department of Defense Sediment Sites. Draft Final Report for ESTCP Project ER-201368.
- Liber K., W. Goodfellow, A. Green, W. Clements, P. den Bester, T. Galloway, A. Gerhardt, and S. Simpson. 2007. *In situ*-based effects measures: Considerations for improving methods and approaches. *Integr. Environ. Assess. Manag.*, 3:246-257.
- Lussier S.M., J.H. Gentile, and J. Walker. 1985. Acute and Chronic Effects of Heavy Metals and Cyanide on *Mysidopsis bahia* (Crustacea:Mysidacea). *Aquatic Toxicology*, 7:25-35.
- Mayer P., W.H.J. Vaes, F. Wijnker, K.C.H.M. Legierse, H. Kraaij, J. Tolls, and J.L.M. Hermens. 2000a. Sensing dissolved sediment porewater concentrations of persistent and bioaccumulative pollutants using disposable solid-phase microextraction fibers. *Environmental Science & Technology*, 34:5177–5183.
- McKernan, J., R. Darlington, and A. Dindal. 2014. Sediment Ecotoxicity Assessment Ring Verification Report and Statement. U.S. Environmental Protection Agency, Washington, DC, 2014. http://cfpub.epa.gov/si/si_public_record_report.cfm?dirEntryId=285833
- Pereira A.M.M., A.M.V.M. Soares F. Goncalves, and R. Ribeiro. 2000. Water-column, sediment, and *in situ* chronic bioassays with cladocerans. *Ecotoxicology and Environmental Safety*, 47:27-38.
- Phillips B.M., B.S. Anderson, J.W. Hunt, P.A. Nicely, R.A. Kosaka, R.S. Tjeerdema, V. de Vlaming, and N. Richard. 2004. *In situ* water and sediment toxicity in an agricultural watershed. *Environ.Toxicol. Chem.*, 23:435-422.
- Reible D.D. 2016. Assessment and Management of Stormwater Impacts on Sediment Recontamination. SERDP Project #ER-2428.
- Rosen G., D.B. Chadwick, S.L. Poucher, M.S. Greenberg, and G.A. Burton. 2009a. *In Situ* Estuarine and Marine Toxicity Testing: A Review, Including Recommendations for Future Use in Ecological Risk Assessment. Space and Naval Warfare Systems Center Pacific (SSC Pac) Technical Report 1986. September 2009a. 73pp.
- Rosen G., D.B. Chadwick, M.S. Greenberg, and G.A. Burton, , Jr. 2009b. Development of a Novel *In situ* Based Monitoring Approach for Contaminated Sediment Assessment. Oral presentation, 5th International Conference on Remediation of Contaminated Sediments, Jacksonville, FL, Feb 2-5, 2009b.
- Rosen G., and K. Miller. 2011. A post exposure feeding assay using the marine polychaete *Neanthes arenaceodentata* suitable for laboratory and *in situ* exposures. *Environmental Toxicology and Chemistry*, 30: 730-737.
- Rosen G., D.B. Chadwick, G.A. Burton Jr., M.S. Greenberg, K. Taulbee, G. Lotufo, and D. Reible. 2012a. A sediment ecotoxicity assessment platform for *in situ* measures of chemistry, bioaccumulation, and toxicity. Part 2: Integrated application to a shallow estuary. *Environmental Pollution*, 162:457-465.

- Rosen G., D.B. Chadwick, G.A. Burton, C. Stransky, H. Bailey, M.S. Greenberg, and J. Radford. 2012b. Preliminary evaluation of a new tool for assessment of *in situ* biological exposure and effects in aquatic environments. Oral Presentation, Society of Environmental Toxicology and Chemistry (SETAC) Europe 22nd Annual Meeting, Berlin, Germany, 20-24 May 2012.
- Rosen G., J. Radford, and B.C. Stransky. 2014. Ecological Risk Assessment Using the Sediment Ecotoxicity Assessment Ring - Applications for an Integrative *In Situ* Bioassay System. Sea Technology Magazine, October 2014. pp. 10-13.
- San Diego Regional Water Quality Control Board (SDRWQCB). 2008. Waste Discharge Requirements for the University of California, San Diego Scripps Institution of Oceanography. National Pollution Discharge Elimination System (NPDES) Permit No. CA0107239; Order R9-2005-0008 (as amended on November 12, 2008).
- SCCWRP and SSC San Diego. 2002. Sediment Assessment Study for the Mouths of Chollas and Paleta Creek, San Diego. Phase 1 Final Report. Prepared by the Southern California Coastal Water Research Project and Space and Naval Warfare Systems Center (SSC) San Diego. For San Diego Regional Water Quality Control Board and Commander Navy Region Southwest. May 2005. 200 pp.
- Schiff K.C., S.M. Bay, D.W. Diehl. 2001. Stormwater Toxicity in Chollas Creek and San Diego Bay. Southern California Coastal Water Research Project Technical Report 340. March 29, 2001.
- Schiff K.S., Bay, and C. Stransky. 2002. Characterization of stormwater toxicants from an urban watershed to freshwater and marine organisms. *Urban Water*, 4:215-227.
- Schiff K.S., R. Gossett, K. Ritter, L. Tiefenthaler, N. Dodder, W. Lao, and K. Maruya. 2011. Southern California Bight 2008 Regional Monitoring Program III. Sediment Chemistry. July 2011. Southern California Coastal Water Research Project Technical Report. 64pp.
- Sibley P.K., D.A. Benoit, M.D. Balcer, G.L. Phipps, C.W. West, R.A. Hoke, and G.T. Ankley. 1999. *In situ* bioassay chamber for assessment of sediment toxicity and bioaccumulation using benthic invertebrates. *Environ. Toxicol. Chem.*, 18:2325-2336.
- SCCWRP and SSC San Diego. 2005. Sediment Assessment Study for the Mouths of Chollas and Paleta Creek, San Diego. Phase 1 Final Report. Prepared by the Southern California Coastal Water Research Project and Space and Naval Warfare Systems Center (SSC) San Diego. For San Diego Regional Water Quality Control Board and Commander Navy Region Southwest. May 2005. 200 pp.
- SSC San Diego. 2003. Coastal contaminant migration monitoring: The Trident Probe and UltraSeep System: Hardware description, protocols, and procedures, SPAWAR Systems Center San Diego, Technical Report 1902, 26pp.
- Stein E.D., L.L. Tiefenthaler, and K. Schiff. 2006. Watershed-based sources of polycyclic aromatic hydrocarbons in urban storm water. *Environ Toxicol Chem*, 25: 373-385.
- Stransky B.C. 2011. Stormwater Toxicity Challenges and Innovative Solutions – Case Study at UCSD’s Scripps Institution of Oceanography. Presented at the annual California Stormwater Quality Association (CASQA) Conference. Monterey, CA. September 2011.

- Stransky B.C., G. Rosen, B. Chadwick, J.M. Guerrero, M.A. Colvin, K. Tait, and G.A. Burton. 2013. Chesapeake Bay is our Laboratory – *In Situ* Sediment Toxicity and Bioaccumulation Assessment at Marine Corps Base Quantico, Virginia. Poster presentation, Annual Meeting of the North American Society of Environmental Toxicology and Chemistry (SETAC), Nashville, TN, November 19, 2013.
- Stransky B.C. 2014a. The Ocean is Our Laboratory – Demonstration of the SEA Ring: *In situ* Water and Sediment Toxicity Testing Technology. Dinner meeting guest speaker for the Southern California Chapter of the Society of Environmental Toxicology and Chemistry (So Cal SETAC). February 2014.
- Stransky B.C. 2014b. An Integrated Approach to Assess Potential Storm Water Impacts to Marine Receiving Water Environments. Presented to the Bight '13 ASBS Regional Monitoring Committee at the Southern California Coastal Water Research Project (SCCWRP), November 2014.
- Stransky B.C., D. McCoy, R. Schottle, S. Hanna, S. Jarrell, P. Dayton, B. Bernstein, K. Tait, and A. Cibor. 2014. La Jolla Shores ASBS Ecosystem Assessment Monitoring 2011-2013, Draft Report. Prepared for the City of San Diego August 2014. Weston Solutions, Inc., AMEC Environment & Infrastructure Inc., and the University of California Scripps Institution of Oceanography.
- Tait K., B.C. Stransky, G. Rosen, M. Colvin, A. Cibor, and R. Dolecal. 2014. *In situ* Storm Water Impact Assessment in San Diego Bay, CA, USA. Presented at the National Society of Environmental Toxicology and Chemistry (SETAC) Annual Meeting, Vancouver, B.C. November 2014.
- USEPA. 1994a. Method 200.8. Revision 5.4. Determination of Trace Elements in Waters and Wastes by Inductively Coupled Plasma-Mass Spectrometry. Environmental Monitoring Systems Laboratory. USEPA-ORD. Cincinnati, OH.
- USEPA. 1994b. Methods for measuring the toxicity of Sediment-Associated Contaminants with Estuarine and Marine Amphipods. EPA 600/R-94/025. U.S. Environmental Protection Agency Narragansett, RI.
- USEPA. 1994c. Short-Term Methods for Estimating the Chronic Toxicity of Effluents and Receiving Water to Marine and Estuarine Organisms. Second edition. EPA/600/4-91/003. U.S. Environmental Protection Agency, Office of Research and Development, Washington, DC.
- USEPA. 1995. Short-term Methods for Estimating the Chronic Toxicity of Effluents and Receiving Waters to West Coast Marine and Estuarine Organisms. United States Environmental Protection Agency Office of Research and Development, Cincinnati, OH. EPA/600/R-95-136.
- USEPA. 2000a. Understanding and Accounting for Method Variability in Whole Effluent Toxicity Applications under the National Pollutant Discharge Elimination System Program. USEPA, OWM, EPA 833-R-00-003 (June), Washington, DC.
- USEPA. 2000b. Methods for Measuring the Toxicity and Bioaccumulation of Sediment-Associated Contaminants with Freshwater Invertebrates, second edition, 600/R-99/064.
- USEPA. 2002. Methods for Measuring the Acute Toxicity of Effluents and Receiving Waters to Freshwater and Marine Organisms. EPA-821-R-02-012. Fifth Edition. U.S. Environmental Protection Agency, Office of Water, Washington DC.

USEPA. 2010. National Pollutant Discharge Elimination System Test of Significant Toxicity Implementation Document. United States Environmental Protection Agency, Office of Wastewater Management, EPA 833-R-10-003, June 2010.

Weston. 2011. La Jolla Shores Area of Special Biological Significance Regional Compliance Monitoring 2009–2011. Final Report. Prepared for the City of San Diego June 17, 2011. Weston Solutions, Inc.

Woodward-Clyde Consultants. 1996. PAH waste load determinations for San Diego Bay. Prepared for the San Diego Interagency Water Quality Panel, San Diego, CA.

Zhang H., W. Davidson. 1995. Performance characteristics of the technique of diffusion gradients in thin-films (DGT) for the measurement of trace metals in aqueous solution. *Anal. Chem.* 67, 3391–3400.

APPENDIX A: Points of Contact

Point Of Contact Name	Organization Name Address	Phone Fax E-mail	Role in Project
Gunther Rosen	SSC - Pacific 53475 Strothe Rd., Bldg. 111 San Diego, CA 92152	(619) 553-0886 (T) (619) 553-6305 (F) gunther.rosen@navy.mil	Principle Investigator
G. Allen Burton	University of Michigan School of Natural Resources and Environment 440 Church St. Ann Arbor, MI 48109-1041	(734) 763-3601 (T) burtonal@umich.edu	Co-Principle Investigator
D. Bart Chadwick	SSC - Pacific 53475 Strothe Rd., Bldg. 111 San Diego, CA 92152	(619) 553-5333 (T) (619) 553-3097 (F) bart.chadwick@navy.mil	Co-Principle Investigator
Marc S. Greenberg	USEPA 2890 Woodbridge Ave., Bldg. 18, MS-101, Edison, NJ 08837	(732) 452-6413 (T) (732) 321-6724 (F) greenberg.marc@epa.gov	Co-Principle Investigator/ Regulator
B. Chris Stransky	AMEC Environment & Infrastructure 9210 Sky Park Court Suite 200 San Diego, CA 92123	(858) 300-4350 (T) (858) 300-4301 (F) chris.stransky@amec.com	Co-Principle Investigator/ Industry
John Radford	Zebra-Tech Ltd. 175 Cross Quay Nelson, New Zealand 7010	(+64) 3-548-0468 (T) (+64) 3-548-0466 (F) john@zebra-tech.co.nz	Co-Principle Investigator/ Industry
Howard Bailey	Nautilus Environmental, LLC. 4340 Vandever Ave San Diego, CA 92120	858-587-7333 x203 (T) 858-587-6769 (F) howard@nautilusenvironmental.com	Co-Principle Investigator/ Industry

**APPENDIX B
SEA RING STANDARD OPERATING PROCEDURES**

**STANDARD OPERATING PROCEDURES FOR CONDUCTING
IN SITU TOXICITY AND BIOACCUMULATION TESTS WITH THE
SEDIMENT ECOTOXICITY ASSESSMENT RING (SEA RING)
FOR VERSION 2.0 OR 3.0 SEA RINGS**

May 2016

Prepared by:
Gunther Rosen and Molly Colvin
53475 Strothe Road
Bldg. 111 Room 116
San Diego, CA 92152-5000
619-553-0886 • 619-553-2788

APPENDIX B ACRONYMS

ASTM	American Society for Testing and Materials
BLT	Battery Longevity Test
CAB	Cellulose Acetate Butyrate
DI	Deionized Water
DO	Dissolved Oxygen
EPA	Environmental Protection Agency
FSW	Filtered Seawater
LED	Light-Emitting Diode
PC	Personal Computer
PPT	Parts Per Thousand
SEA Ring	Sediment Ecotoxicity Assessment Ring
SOP	Standard Operating Procedure
SPAWAR	Space and Naval Warfare Systems Center Command
SS	Stainless Steel (316)

PREFACE

This document describes the standard operating procedures (SOPs) associated with the preparation, performance, and demobilization steps associated with conducting *in situ* bioassays with the Sediment Ecotoxicity Assessment Ring (SEA Ring) system. Please note that this document is complementary to the Zebra-Tech, Ltd. SEA Ring Operation Manual (Appendix C) that provides critical additional details with respect to the SEA Ring assembly, proper use, and maintenance. Users of the technology must become familiar with both documents to ensure that the equipment is used safely and properly, and that quality results are obtained. Technology users must also be experienced with the procedures used to conduct standard laboratory-based bioassays such as those published by the Environmental Protection Agency (EPA) and the American Society for Testing and Materials (ASTM), as these methods are based primarily on derivations of standard protocols for toxicity and bioaccumulation testing in the laboratory.

The majority of this document describes procedures used for conducting *in situ* bioassays with estuarine or marine organisms in water column or surface sediment exposures. Slight modifications of various procedures might be required to accommodate testing in freshwater environments or other applications. In some cases, referencing to freshwater methods is included. In all cases, however, it is advised that relevant EPA or ASTM methods be consulted as appropriate. In general, the use of the SEA Ring test system is intended to utilize only slight modifications of standardized test methods for toxicity and bioaccumulation test approaches designed for the laboratory.

B1. EQUIPMENT CLEANING

B1.1 PRIOR TO USE

B1.1.1 New Hardware

All new hardware should be cleaned prior to use including, but not limited to, CAB exposure chamber tubing, exposure chamber caps, pump tubing, and SEA Ring Assembly:

1. Lightly scrub all components with a soft brush/pad in warm soapy water (2% Alconox/Liquinox solution).
2. Run warm soapy water through all tubing and inner component spaces that cannot be reached with a brush.
3. Rinse thoroughly (at least 3x) with deionized water (DI) water.
4. Soak in DI or nanopure water overnight.
5. Rinse 3x with DI or nanopure water.
6. Dry and store until use.
7. 1–2 days prior to deployment rinse all components again with DI or nanopure water followed by a soak in appropriate clean test water (filtered seawater (FSW) for marine testing and DI water or filtered site water for freshwater tests).

B1.2 AFTER USE

B1.2.1 SEA Ring Assembly and Components

Any equipment coming in contact with samples must be washed to remove surface contaminants as described below:

1. Remove surface residuals immediately (preferably during demobilization phase).
2. Disassemble and clean SEA Ring components separately by rinsing with DI water.
3. Loosen and float particulate material by lightly scrubbing all components with a soft brush and soaking in warm detergent soap solution overnight. Use 2% Alconox/Liquinox solution.^a
4. Rinse 3x with DI or nanopure water to remove trace deposits.
5. Soak all plastic components in a dilute acid bath for at least 2 hours. Use 10% (1.6 N) Nitric Acid solution.
6. Rinse 3x with DI or nanopure water and allow all components (inner and outer spaces) to dry thoroughly.
7. Prior to assembly, secure SEA Ring parts/components in plastic (Ziploc) bags and stage in a clean area.

^a Flush, soak, rinse, and wash metal parts (stainless steel (SS) rods, washers, nuts, bolts, etc.) separately.

8. Silicone pump tubing is replaceable and should be replaced regularly to ensure proper performance. Tubing may be required to be disposed of in between individual deployments to ensure transfer of contaminants from one site to others does not occur if cleaning protocol is not sufficient.

B1.2.2 Embryo/Larval Development in situ drums

1. Remove plastic screws from ends.
2. Soak drums and screws in a 2% Alconox/Liquinox DI water bath for 24 hours.
3. Scrub screens very gently with brush and rinse 2–3 times DI water.
4. Dip drums in 10% nitric acid for no more than 5 minutes.
5. Rinse 3x with DI or nanopure water and allow to dry thoroughly before storage.
6. 1–2 days prior to deployment rinse drums again with DI or nanopure water followed by a soak in appropriate clean test water (filtered seawater [FSW] for marine testing and DI water or filtered site water for freshwater tests).

B2. RECEIVING AND HOLDING TEST ORGANISMS

B2.1 OBJECTIVE

This protocol highlights receiving and holding procedures for a limited suite of test organisms commonly used to date for *in situ* testing in the SEA Ring (amphipods, fish, mysid shrimp, mussels, echinoderms, polychaetes, and clams). General methods will be similar for most any other species that might be used; however, specific EPA/ASTM protocols should always be referenced for particular species requirements.

B2.2 MATERIALS AND SUPPLIES

- Water quality meters capable of measuring pH, DO, salinity, conductivity, and temperature
- Holding tanks – aquariums or bowls of sufficient size
- Squirt bottles
- Air pump or access to air grid
- Plastic tubing – to provide aeration in holding tanks
- Glass Pasteur pipettes/air stones
- Food source (*Artemia* nauplii and TetraMin[®] flakes common)
- Plastic transfer pipettes
- Tubing of appropriate size for siphoning overlying water and debris (¼ to ½”)

B2.3 METHODS

1. Upon arrival, check temperature before placing organisms into aquarium/holding bowls (Holding tank sizes may range from 4 to > 20 L (glass or plastic) depending on the number and size of organisms. Test organisms should not be subjected to changes of more than 3 °C in water temperature or 3 ppt in any 12-hour period.
2. The following should be recorded upon arrival (if applicable):
 - Condition of the organisms upon arrival including # of mortalities
 - Temperature
 - Dissolved oxygen concentration
 - Salinity or conductivity
 - pH
3. Acclimate organisms, place shipping bag in an environmental chamber or float bag in a clean aquarium/holding tank with control test water for at least 60 minutes at the desired test temperature. After initial water quality measurements are taken, the top of the bag should be propped open and water should be gently aerated. A small amount of food may be added if the organisms do not appear stressed.
4. After temperature in the shipping bag has approached appropriate holding temperature (depending on test method), remove the shipping bag and slowly add control test water to the holding tank.

5. An alternative method is to empty the entire contents of the shipping bag and animals into a clean holding tank/bowl and set up a drip system that slowly mixes control test water of the appropriate temperature directly with that in the shipping bag. A screened outlet or small holes at the top of the shipping bag may be needed to allow overflow water to drain without losing small test organisms.
6. To empty bagged test organisms without unnecessarily disturbing them, place the bag in a clean bowl, open the top of the bag and slowly slide the bag out from the bottom–up. Carefully examine the bag and rinse out any animals that may have remained stuck to the sides. Remove any dead animals and excess debris with a pipette or small siphon hose. Gently aerate each holding tank/bowl with a small air stone or 1-mL glass pipette.
7. Check temperature frequently to make sure it is maintained at appropriate holding temperature ± 2 °C. If temperature is not maintained in range, organisms should be held an additional day prior to testing. In general, organisms should be acclimated for at least 2 days prior to testing.
8. Ensure that the photoperiod to be used during testing is being used during acclimation.
9. Renew holding water every other day or renew one half of the water every day. This depends on the amount of fecal matter and density of animals in the holding tank. All fecal matter, dead, etc. should be siphoned daily.
10. If the organisms need to acclimate to the testing salinity, mix FSW with the appropriate amount of DI water to obtain the desired salinity (do not adjust salinity more than 3 ppt in a 12-hour period) during water changes.
 - The following should be recorded during the holding period:
 - Daily condition of the organisms (i.e., erratic behaviors, # mortalities)
 - Temperature in holding tanks
 - Dissolved oxygen level in holding tanks
 - Frequency of water change and siphoning
 - Frequency and approximate quantity of feeding
 - General appearance of water (cloudy, clear, etc.)

Before disposal, any excess test organisms are killed, generally by concentrating into a container and freezing, or food source for other animals in holding. Under no circumstances are test organisms ever released to the wild or used more than once for testing.

More specific holding and acclimating conditions are provided below for a variety of commonly used test organisms for in situ testing:

Mysid Shrimp and Fish – Holding bowl loading rates for mysid shrimp should not exceed 20/L. Loading rates for fish should not exceed 0.4 g/L. Both mysid shrimp and fish generally require feeding with *Artemia* nauplii soon after shipment. However, some time (1–2 hours) for acclimation is suggested before adding food. Never feed immediately if fish or mysids appear stressed upon arrival or excess food is present in the shipping bags upon arrival. Observe holding bowls 30 minutes to 1-hour after feeding to see if excess food should be removed or potentially more food added.

Mussels, Oysters, Abalone, Sea Urchins, and Sand Dollars – If organisms are not being used immediately for obtaining gametes, carefully place healthy adults in a flow-through seawater tank with ample flow and aeration. Closely monitor for induction of spawning and if observed, remove

individuals promptly and place in a separate holding tank. Feed sea urchins and abalone blades of rinsed kelp while in holding until ready for use. Mussels, oysters, and sand dollars should be fed a daily mixture of algae and TetraMin[®] or other commercially available invertebrate food mixtures. Optimal holding temperature is 15 °C for all species with the exception of sand dollars (20 °C). Sand dollars should also be held in a tank with a clean sand substrate.

Polychaetes – *Neanthes* are generally received in small Whirl Pak bags containing green algae (*Ulva sp.*) for substrate and food. Gently open the bag and pour entire contents into a clean holding bowl. Rinse the bag with FSW and check for worms that may have stuck to the sides of the bag. Add sufficient laboratory seawater to gently begin acclimation process to testing temperature and salinity. *Nephtys sp.* is generally shipped within their home sediment. Empty entire contents (worms and sediment) into a clean aquarium with aeration and initiate a slow drip with water of the appropriate temperature and salinity. *Nereid sp.* is generally shipped moist in a bed of native macroalgae and wet towels or newspaper. Carefully place worms and some of the algae in a clean aquarium with aeration and initiate a slow drip with water of the appropriate temperature and salinity. Freshwater *Lumbriculus sp.* is generally shipped in water without substrate. Carefully empty entire contents into a holding bowl and initiate acclimation with water of the appropriate conductivity and temperature. For long-term holding, *Lumbriculus* can be successfully held at 4 °C to minimize growth, reproduction, and mortality if desired. A ground mixture of TetraMin[®] in control water is recommended as a food source for *Neanthes* and *Lumbriculus*. Extra care should be taken to minimize overfeeding and degradation of water quality (no more than a light coating of food on the bottom of the holding bowl). Food is not required for *Nereis* or *Nephtys* since they are shipped and acclimated in their own control sediment which should provide a sufficient food source.

Amphipods – Amphipods should be ordered within a week and at least three days prior to testing date to allow for acclimation to testing conditions. Field collected marine amphipods generally require more time to acclimate than those cultured (i.e., *Hyalella azteca*). Marine amphipods are typically received in small Tupperware containers or plastic bags filled with sediment from the collection site (control sediment). Gently rinse sediment and amphipods into a clean holding tank with a squirt bottle containing filtered seawater and check for amphipods that may have stuck to the sides of the container. Discard any mortalities. *Hyalella* are shipped in water without substrate and can be poured out and acclimated as-is without sediment. A substrate consisting of 250 or 500 µm mesh screen may be used if desired. A ground mixture of TetraMin[®] in control water is recommended as a food source, with extra care to minimize overfeeding and degradation of water quality (no more than a light coating of food on the bottom of the holding bowl or sediment surface). Food is not required for marine amphipods since they are shipped and acclimated in their own control sediment which should provide a sufficient food source.

Clams – Gently place clams into a clean holding tank with appropriate clean control water and discard any mortalities (e.g., individuals with gaping shells that are unresponsive to touch). Freshwater clams can be held on spring water with minimal attention (periodic water changes). Marine clams require regular water changes and gentle aeration. No feeding is generally required.

B3. HATCHING BRINE SHRIMP AND THEIR USE AS TEST ORGANISM FOOD

B3.1 OBJECTIVE

Brine shrimp (*Artemia spp*) are the preferred and most convenient food for mysid shrimp and fish larvae for toxicity testing and holding/acclimation. They are also used in post exposure feeding rate assays for sediment quality assessment (e.g., marine polychaete, *Neanthes arenaceodentata*).

B3.1 MATERIALS AND SUPPLIES

- Separatory Funnels – (2), 2-L capacity and ring stands to hold the funnels
- Air pump
- Plastic tubing – to provide aeration in separatory funnels
- Glass Pasteur pipettes
- Portable light source (flashlight or incandescent bulb)
- Dark material – to assist with collection of hatched shrimp
- Brine shrimp (*Artemia*) cysts

Note: EPA suggests use of Brazilian or Colombian brine shrimp cysts. These can be purchased from Aquarium Products, 180L Penrod Ct., Glen Burnie, MD 21061. Other suppliers are on p. 28 of EPA/600/R-95/136.

B3.1 METHODS

1. Add 1 L of seawater to a 2-L separatory funnel, or equivalent.
2. Add 10 mL or 1–2 grams of *Artemia* cysts to the separatory funnel and aerate for 24 hours at 27 °C. Actual hatching time will vary with temperature and strain.
3. After 24 hours, remove the air supply from the separatory funnel. Cover funnel with a dark cloth while directing the beam of a flashlight or incandescent lamp through the bottom of the funnel for 5–10 minutes. *Artemia* are phototactic, and will concentrate at the bottom of the funnel. Do not leave concentrated nauplii at bottom for more than 10 minutes without aeration, or they will die.
4. Drain the nauplii into a funnel fitted with a < 150- μ m Nitex or stainless steel screen, and gently rinse with seawater.
5. Gently spray nauplii into a beaker and fill until desired concentration is reached.
6. Approximately 40–50 nauplii per feeding per test organism is targeted for most tests. In order to feed 10 organisms, this requires 200 μ L of a suspension with a density of 2000 nauplii/mL. This concentration can be achieved by dilution or concentration of nauplii following cell counts under a light microscope. For test protocols using 5 organisms per beaker, 100 μ L of the suspension would be used.

B4. SEA RING SETUP FOR WATER COLUMN TESTING

B4.1 OBJECTIVE

Assess acute and chronic *in situ* exposure and effects in the water column (e.g., sediment overlying water, point source receiving water discharges, stormwater discharges to receiving waters, and other ambient conditions). Species successfully tested to date using the SEA Ring have included mysid shrimp (*Americamysis bahia* and *Holmesimysis costata*), fish larvae (*Atherinops affinis* and *Menidia beryllina*), polychaetes (*Neanthes arenaceodentata*), and embryo development tests using bivalves (*Mytilus galloprovincialis*) and echinoderms (purple sea urchin – *Strongylocentrotus purpuratus*). A wide variety of other marine and freshwater test species may also be successfully used. The acute endpoint for these tests is 96-hour survival for mysid shrimp and larval fish. Chronic 7-day tests may be employed to quantify growth over a 7-day or longer period. A sublethal feeding rate for polychaete worms as well as kelp spore germination and growth evaluations have been successfully conducted in the SEA Ring deployed in the water column.

B4.2 MATERIALS AND SUPPLIES

- Test organisms + 10% for incidental mortalities (mysid/fish only)
- Exposure chambers and caps, pre-soaked in appropriate control water
- Mysid/fish exposure: 5” exposure chambers.
- Embryo exposure: 2-µm screen embryo drums with screws inside 5” or 10” exposure chambers
- Control water of the appropriate salinity/ conductivity
- Pipettes, automatic – adjustable, to cover a range of 0.01 to 5 mL and pipette tips
- Wash bottles –for seawater and DI rinsing of glassware
- SEA Rings
- Computer
- SEA Ring charging and AC adapter cords
- Programming cord
- Flat head screwdriver
- Plastic transfer pipettes
- Solo[®] cups 1- to 5-oz. soufflé cups
- Light box
- Small plastic funnel
- Pyrex[®] dishes

B4.3 METHODS

B4.3.1 Programming the SEA Ring – Version 2

1. Connect the SEA Ring Version 2 to a PC with the programming cord and start the SEA Ring V2 Application (most recent version available).

Note: Control module switch needs to be in position **2** (Center) for PC communications.

2. Press the **Set time** button to synchronize the SEA Ring internal clock to the PC.
3. Press the **Delete data** button to clear the SEA Ring of previously stored data or programs.

4. Enter in Start time, Start date, Stop time and Stop date for the desired program

Note: Use military (24-hour) time.

5. Enter in the desired amount of time for chamber flushing (i.e., pump on).

Note: Pump operates at an estimated 100 mL/min. If using a 5” exposure chamber with an internal volume of approximately 500 mL, a full turnover of internal water will take approximately 5 minutes while the pump is on. If the start time/date has not been reached when the switch is turned on, the SEA Ring will sleep until the start time/date rolls over. The first flush then occurs after the flush interval has expired. With the enhanced external battery pack, a total running time of a fully charged unit (8.6 +V) until auto shut-off (6.5 V) is achieved is approximately 5600 minutes.

6. Enter in the desired amount of time for chamber flush interval (i.e., pump off). See Table B-1 for an example of a 4-day exposure with 57.6 turnovers per day.

Table B-1. Example for a 4-day exposure with 57.6 turnovers per day (57.6 exchanges of overlying water in 5” chamber per day).

Start time	13:00
Start date	03/05/2012
Stop time	13:00
Stop date	03/10/2012
Chamber flush duration (min)	1
Chamber flush interval (min)	4
Total # minutes pump on	1152

*Note: Programmed time in example was 5 days for a 4-day deployment, which allows for flexibility in recovery date/time. If the unit is not recovered and has already stopped the program, water quality may be compromised, so it is advised to build in an appropriate buffer.

7. Press the **Upload settings** button to program the SEA Ring.
8. Note programming details on a data sheet.
9. Disconnect programming cord and replace connector cap.
10. Move control module switch to “Position 3” (right) to begin program.

Note: Two indicator LEDs should periodically illuminate when placed in “Position 3”. When battery voltage reaches 6.5 V the pump will turn off and data output will indicate “user force stop”. The left LED indicates battery status and the right LED indicates program status, as shown in Table B-2.:

Table B-2. Battery status indicator (left LED).

LED Blink Sequence	Status
Green	Fully charged/OK
Orange	Moderate charge
Red	Low-battery warning (< 7.3 V)

Table B-3 shows operation/program mod indicator settings.

Table B-3. Operation/program mode indicator (right blue LED).

LED Blink Sequence	Status
Continual flashing	Actively pumping
One flash	Idle
Two flashes	Active program operating
Three flashes	Programmed with delayed start
Four flashes	Memory full
No flashes	Low-battery shutdown (< 6.5 V)

B4.3.2 Programming the SEA Ring – Version 3

1. Connect the SEA Ring Version 3 to a PC with the programming cord and start the SEA Ring V3 application (most recent version available).

Note: Control module switch needs to be in OFF position for PC communications. Currently, the PC date MUST be set to 2015 in order for the SEA Rings to communicate with the PC.

2. Verify the unit is fully charged (battery = 8.2 V+). If not, charge the unit. **Do not plug the charger into the wall until it is connected to the unit to avoid shorting the unit.** Line up the charging cord attachment with the SR port (there is a little indent on one side); it should slide on with very little effort, do not force it. Charge the unit three times, disconnecting the cord from the wall outlet after each charge for a few seconds. After the three cycles, allow the unit to off gas for at least an hour (remove the charger and leave the port open).
3. Press the **Set time** button to synchronize the SEA Ring internal clock to the PC.
4. Press the **Delete data** button to clear the SEA Ring of previously stored data or programs.
5. Enter in Start time, Start date, Stop time and Stop date for the desired program.

Note: Use military (24-hour) time. Make sure to account for the fact that the computer's date is set in 2015.

6. Enter in the desired amount of time for chamber flushing (i.e., time pump on).

Note: Version 3 pumps operate in sequence with Pump 1 running first, then Pump 2, then 3, and so on. The interval timing begins when the first pump finishes running. Version 3 pumps operate at an estimated 2 L/min. If using a 5” exposure chamber with an internal volume of approximately 500 mL, a full turnover of internal water will take approximately 15 seconds while the pump is on. The total flushing time entered multiplied by 10, must be less than the interval period. Otherwise, the SEA Ring will not log any data. For example: if 3 seconds is entered, each pump will run for 3 seconds in sequence for 30 seconds of activity. If the interval period entered is 30 seconds, the first pump will begin running immediately following the tenth and last pump. The system will not have entered an interval period and no data will be recorded.

If the start time/date has not been reached when the switch is turned on, the SEA Ring will sleep until the start time/date rolls over.

A total pump running time of a fully charged unit (8.2+V) until auto shut-off (6.5V) is achieved is approximately 900 minutes (the amount of time that at least one pump in pumping on the SR is 900×10 (pumps) = 9000 mins).

7. Enter in the desired amount of time for chamber flush interval (i.e., time pump off), see Table B-4 for an example for 4-day exposure settings used.

Table B-4. Example for a 4-day exposure with 288 turnovers per day (288 exchanges of overlying water in 5” chamber per day)

Start time	13:00
Start date	03/05/2012
Stop time	13:00
Stop date	03/10/2012
Chamber flush duration (sec)	6
Chamber flush interval (min)	2
Total # minutes each pump on	72

*Note: Programmed time in example was 5 days for a 4-day deployment, which allows for flexibility in recovery date/time. If the unit is not recovered and has already stopped the program, water quality may be compromised, so it is advised to build in an appropriate buffer.

8. Select which pumps are to be active by checking the ones desired.
9. Press the Upload settings button to program the SEA Ring.
10. Note programming details on a data sheet.
11. Disconnect programming cord and replace connector cap. Ensure that the cap is seated correctly and tighten it fully; any water that gets in will short the SEA Ring.

12. Turn control module switch to “Run” (counter-clockwise) to begin program.

Note: Two indicator LEDs should periodically illuminate when placed in “Run”. When battery voltage reaches 6.5 V the pump will turn off and data output will indicate “low battery shutdown”; see Table B-5 for batter status indicator results and Table B-6 for operation/program mode indicator settings. The top LED indicates battery status and the bottom LED indicates program status:

Table B-5. Battery status indicator (op LED).

LED Blink Sequence	Status
Green	Fully charged/OK
Orange	Moderate charge
Red	Low-battery warning (< 7.3 V)

Table B-6. Operation/program mode indicator (bottom blue LED).

LED Blink Sequence	Status
Continual flashing	Actively pumping
One flash	Idle
Two flashes	Active program operating
Three flashes	Programmed with delayed start
Four flashes	Memory full
No flashes	Low-battery shutdown (< 6.5 V)

B4.3.3 Preparation of Exposure Chambers

Note: All tubing, filters, fittings, connectors and valves should be previously cleaned and conditioned prior to use. Refer to Zebra-Tech Operations Manual for detailed descriptions of parts and processes (V1.7 at time of writing of this SOP).

1. Place Nitex mesh inserts into outlet ports on chamber cap and secure (use 250- μ m screens for Mysid shrimp and 500- μ m screens for most other organisms).

Note: Outlet filter size = 1.8-cm diameter (roughly the size of a dime).

2. Attach inlet filter to exposure chamber cap using Zebra-Tech supplied silicone tubing (perforated) (approximately 2") and male connector. Make sure the silicone tubing has Nitex mesh rolled inside of it (use 250- μ m screens for Mysid shrimp and 500- μ m screens for most other organisms).
3. Secure inlet connector and duck bill valves to chamber cap.
4. Fit exposure chambers of the desired length with solid end cap on bottom of chamber. For most water-only tests with small test organisms, 5" chambers are sufficient, but longer chambers may be used as desired.
5. Fit chamber cap on top of exposure chambers and place into SEA Ring ensuring the numbering on the caps corresponds to the numbering on the base plate.
6. Align exposure chamber and cap holes with chamber holder hole and secure retaining pin.
7. Secure tubing from the appropriate pump to each exposure chamber duck bill inlet connector.
8. Make sure that the Sea Ring has its top with a 500- μ m filter in place over each of the pump inflows.
9. Submerge SEA Ring into Chem-Tainer (previously cleaned and conditioned with FSW) filled with FSW or site water.

Note: Do not secure syringe port stopper into place before final addition of organisms.

B4.3.4 Loading Organisms into SEA Ring

Note: Organisms are introduced into exposure chambers immediately prior to field deployment.

1. Count out organisms over light box in groups of five into plastic Solo® cups.
2. For quality control, a second person should double check organism counts and condition.
3. Place a small funnel into syringe port of chamber cap.

Note: To prevent overflow of water from chamber and potential loss of organisms, some water may need to be siphoned from the exposure chambers prior to addition.

4. Gently pour desired number of organisms into funnel ensuring that they enter the exposure chamber. Rinse Solo® cup and funnel with dilution water as necessary.
5. Gently replace syringe port stopper into syringe port.
6. Note time of organism introduction into SEA Ring chambers on data sheet.

Note: In some situations, it may be more appropriate to load the organisms while already in the field (e.g., aboard a boat or from a pier). In this case, organisms should be counted out in the laboratory into supplied syringes, which are then topped off with relevant control water or filtered site water, and contained with supplied silicone stoppers. It is best to transport the syringes in a small cooler filled with control or filtered site water to maintain temperature and

cushion syringes from physical stress. A travel control is advised in all cases, in which a subset of syringes are brought back to the laboratory and placed in appropriate vessels to carry out laboratory-based exposures to ensure stress associated with transport was not a significant artifact.

B4.3.5 Loading Organisms into SEA Ring – Embryo Drums

Note: Embryo drums are placed inside exposure chamber, followed by placement in SEA Ring.

1. Prepare stock of fertilized eggs with an approximate density of 300 embryos/mL.
2. Place one screw into embryo drum and tighten with a flat-head screwdriver.
3. Submerge embryo drum in seawater to the top edge of the top hole.
4. Pipette 1 mL (or relevant volume) of thoroughly homogenized stock fertilized egg solution to target a loading density of approximately 300 embryos/drum.
5. Carefully secure second screw into the top hole with flat-head screwdriver.
6. Gently tap sides of drum while submerged to release any air bubbles caught inside drum.
7. Place embryo drum inside exposure chamber through bottom and secure end cap.
8. Carefully place exposure chambers into SEA Ring and submerge the SEA Rings into the Chem-Tainer filled with seawater.
9. Gently replace syringe port stopper into syringe port.
10. Note time of organism introduction into SEA Ring chambers on data sheet.

B4.3.6 SEA Ring Deployment

1. Transfer loaded Chem-Tainer and SEA Ring to deployment site.
2. While submerged in site water, gently remove SEA Ring from Chemtainer, paying close attention not to disrupt tubing connections.
3. Secure SEA Ring to selected anchoring point.
4. Turn control module to “Run” (Counter-clockwise) for pre-programmed pumping regime.
5. Ensure that LEDs are flashing as appropriate and SEA Ring (and water quality datasonde, if used) is secure.
6. Note time of deployment on data sheet.

B4.3.7 SEA Ring Recovery

1. Make initial observations of SEA Ring condition (hoses, LED status, organism movement/health, and overall integrity), if possible.
2. Slowly place SEA Ring in its already submerged Chem-Tainer. The Chem-Tainer should ideally be submerged during transfer to ensure that the device is transferred intact.
3. Disconnect anchor points on SEA Ring.
4. Carefully retrieve entire Chem-Tainer and SEA Ring set-up and bring to surface.
5. Switch control module switch to “Off” (Center).
6. Note time of recovery on data sheet.
7. Immediately return to lab or staging area for breakdown and assessment.

Note: If practical, SEA Ring may be retained in active pumping mode (either Test or Run) to ensure that water quality is maximized during transport to laboratory for assessment.

B4.3.8 Recovery of Organisms

1. Disconnect tubing from chamber caps.
2. Remove retaining pin on chamber holder.
3. Carefully remove exposure chamber.
4. Gently remove chamber cap. Alternatively, for water column exposures, the end cap can be removed if the SEA Ring chamber cap presents challenges.
5. Enumerate surviving organisms and note any mortalities observed.
6. If necessary, gently pour contents of exposure chamber into Pyrex[®] dish and rinse chamber with dilution water to more accurately count surviving organisms to remove from crevices of chamber cap.

B4.3.9 Recovery of Organisms – Embryo Drums

1. Prepare/label a scintillation vial for each embryo drum.
2. Place small funnel in scintillation vial.
3. Disconnect tubing from chamber caps.
4. Remove retaining pin on chamber holder.
5. Carefully remove exposure chamber.
6. Gently remove chamber end cap.
7. Carefully remove embryo drums from the exposure chambers one at a time.
8. While keeping embryo drum submerged half way, remove one of the screws, being careful not to submerge the entire drum which might result in loss of embryos.
9. Place finger (with Latex glove) over open hole and invert drum over small funnel placed into scintillation vial.
10. Remove finger from hole and gently tap sides of drum to evacuate contents of embryo drum.
11. Remove second screw from drum and briefly rinse drum with filtered seawater making sure not to overflow scintillation vial.

Note: If needed, contents of scintillation vial may need to be filtered on a 20- μ m screen to concentrate embryos and then reintroduce to vial to reduce final volume in vial.

12. Terminate test by addition of 1 mL of 10% buffered formalin to vial contents and record time on data sheet.
13. Observe embryos within one week of preservation. For each test replicate, the proportion of normal to abnormal larvae will be determined per relevant standard methods.

B4.3.10 Downloading data from SEA Ring

1. After ensuring that the programming port is dry, attach the programming cord to the SEA Ring and to a PC, and start the SEA Ring application.
2. Press the Offload button and save the file in a designated folder. This file is a comma separated file and can be opened in Microsoft Excel[®].

Note: The data in the SEA Ring is stored in non-volatile memory, meaning that if the battery goes flat, the data will not be lost.

3. Delete data from SEA Ring if desired.

B5. SEA RING SETUP FOR SEDIMENT TESTING

B5.1 OBJECTIVE

Assess *in situ* sediment quality with benthic invertebrates (e.g., polychaetes, oligochaetes, amphipods, clams) using modifications of standard toxicity and bioaccumulation testing protocols. Freshwater equivalents may also be used, but are not covered here.

B5.2 MATERIALS AND SUPPLIES

- Test organisms + 10% for incidental mortalities
- Exposure chambers and caps, pre-soaked in control water or filtered site water
 - Polychaetes, oligochaetes, amphipod: 10 or 11” open-ended exposure chambers.
 - Clam: 10 or 11” exposure chambers with ½” stainless steel or flexible titanium mesh on bottom (“clam catchers”)
- Control water of the appropriate salinity/conductivity.
- Wash bottles – for seawater and deionized (DI) rinsing of glassware
- SEA Rings
- Deployment bracket and poles
- Syringe deployment plate
- Laptop computer
- Charging and AC adapter cords
- Programming cord
- Flat-head screwdriver
- Plastic transfer pipettes
- Solo[®] cups 1-oz. soufflé cups
- Modified 30-mL syringes with silicone stopper, for retaining organisms
- Light box
- Small plastic funnel
- Pyrex[®] dishes
- Stainless steel or Nitex mesh sieves (typically 400 to 500 µm) for recovering organisms at test end

B5.3 METHODS

B5.3.1 Programming the SEA Ring – VERSION 2

1. Connect the SEA Ring Version 2 to a PC with the programming cord and start the SEA Ring V2 application (most recent version available).
2. Press the Set time button to synchronize the SEA Ring internal clock to the PC.
3. Press the Delete data button to clear the SEA Ring of previously stored data or programs.
4. Enter in Start time, Start date, Stop time, and Stop date for the desired program
5. Note: Use military (24-hour) time.
6. Enter in the desired amount of time for chamber flushing (i.e., pump on).

Note: Pump operates at an estimated 20 mL/min. If using a 5” exposure chamber with an internal volume of approximately 500 mL, a full turnover of internal water will take approximately 5 minutes while the pump is on. If the start time/date has not been reached when the switch is turned on, the SEA Ring will sleep until the start time/date rolls over. The first flush then occurs after the flush interval has expired. With the enhanced external battery pack, a total running time of a fully charged unit (8.6 +V) until auto shut-off (6.5 V) is achieved is approximately 5600 minutes. An example of a 4-day exposure is provided in Table B-7.

7. Enter in the desired amount of time for chamber flush interval (i.e., pump off). Table B-7 shows an example for a 4-day exposure.

Table B-7. Example for a 4-day exposure with 57.6 turnovers per day (57.6 exchanges of overlying water in 5” chamber per day).

Start time	13:00
Start date	03/05/2012
Stop time	13:00
Stop date	03/10/2012
Chamber flush duration (min)	1
Chamber flush interval (min)	4
Total # minutes pump on	1152

Note: Programmed time in example was 5 days for a 4-day deployment, which allows for flexibility in recovery date/time. If the unit is not recovered and has already stopped the program, water quality may be compromised, so it is advised to build in an appropriate buffer.

8. Press the Upload settings button to program the SEA Ring.
9. Note programming details on a data sheet.
10. Disconnect programming cord and replace connector cap.
11. Move control module switch to “Position 3” (right) to begin program. Battery status indicator settings used are shown in Table B-8. Operation/program mode indicator settings used are shown in Table B-9.

Note: Two indicator LEDs should periodically illuminate when placed in “Position 3”. When battery voltage reaches 6.5 V the pump will turn off and data output will indicate “user force stop”. The left LED indicates battery status and the right LED indicates program status:

Table B-8. Battery status indicator (left LED).

LED Blink Sequence	Status
Green	Fully charged/OK
Orange	Moderate charge
Red	Low-battery warning (< 7.3 V)

Table B-9. Operation/program mode indicator (right blue LED).

LED Blink Sequence	Status
Continual flashing	Actively pumping
One flash	Idle
Two flashes	Active program operating
Three flashes	Programmed with delayed start
Four flashes	Memory full
No flashes	Low-battery shutdown (< 6.5 V)

B5.3.2 Programming the SEA Ring – Version 3

1. Connect the SEA Ring Version 3 to a PC with the programming cord and start the SEA Ring V3 Application (most recent version available).

Note: Control module switch needs to be in OFF position for PC communications. Currently, the PC date MUST be set to 2015 in order for the SEA Rings to communicate with the PC.

2. Verify the unit is fully charged (Battery = 8.2V+). If not, charge the unit. **Do not plug the charger into the wall until it is connected to the unit to avoid shorting the unit.** Line up the charging cord attachment with the SR port (there is a little indent on one side); it should slide on with very little effort, do not force it. Charge the unit three times, disconnecting the cord from the wall outlet after each charge for a few seconds. After the three cycles, allow the unit to off gas for at least an hour (remove the charger and leave the port open).
3. Press the **Set time** button to synchronize the SEA Ring internal clock to the PC.
4. Press the **Delete data** button to clear the SEA Ring of previously stored data or programs.
5. Enter in Start time, Start date, Stop time and Stop date for the desired program.

Note: Use military (24-hour) time. Make sure to account for the fact that the computer's date is set in 2015

6. Enter in the desired amount of time for chamber flushing (i.e., pump on).

Note: Version 3 pumps operate in sequence with Pump 1 running first, then Pump 2, then 3, and so on. The interval timing begins when the first pump finishes running. Version 3 pumps operate at an estimated 2 L/min. If using a 5" exposure chamber with an internal volume of approximately 500 mL, a full turnover of internal water will take approximately 15 seconds while the pump is on. The total flushing time entered multiplied by 10, must be less than the interval period. Otherwise, the SEA Ring will not log any data. For example: if 3 seconds is entered, each pump will run for 3 seconds in sequence for a total of 30 seconds of activity. If the interval period entered is 30 seconds, the first pump will begin running immediately following the 10th and last pump. The system will not have entered an interval period and no data will be recorded.

If the start time/date has not been reached when the switch is turned on, the SEA Ring will sleep until the start time/date rolls over.

A total pump running time of a fully charged unit (8.2+V) until auto shut-off (6.5V) is achieved is approximately 900 minutes (the amount of time that at least one pump in pumping on the SR is $900 * 10(\text{pumps}) = 9000 \text{ mins}$). Settings used for a 4-day exposure are shown in Table B-10.

7. Enter in the desired amount of time for chamber flush interval (i.e. pump off).

Table B-10. Example for a 4-day exposure with 288 turnovers per day (288 exchanges of overlying water in 5" chamber per day).

Start time	13:00
Start date	03/05/2012
Stop time	13:00
Stop date	03/10/2012
Chamber flush duration (sec)	6
Chamber flush interval (min)	2
Total # minutes each pump on	72

**Note:* Programmed time in example was 5 days for a 4-day deployment, which allows for flexibility in recovery date/time. If the unit is not recovered and has already stopped the program, water quality may be compromised, so it is advised to build in an appropriate buffer.

8. Select which pumps are to be active by simply checking the ones you want to be active.
9. Press the **Upload settings** button to program the SEA Ring.
10. Note programming details on a data sheet.
11. Disconnect programming cord and replace connector cap. Ensure that the cap is sitting correctly and you tighten it fully, as any water that gets inside will short the SEA Ring.
12. Turn control module switch to "Run" (counterclockwise) to begin program. Battery status indicator settings used are shown in Table B-11. Table B-12 shows operation/program mode indicator settings used.

Note: Two indicator LEDs should periodically illuminate when placed in "Position 3". When battery voltage reaches 6.5V the pump will turn off and data output will indicate "low battery shutdown". The right LED indicates battery status and the left LED indicates program status:

Table B-11. Battery status indicator (right red LED).

LED Blink Sequence	Status
Green	Fully charged/OK
Orange	Moderate charge
Red	Low-battery warning (< 7.3 V)

Table B-12. Operation/program mode indicator (left blue LED).

LED Blink Sequence	Status
Continual flashing	Actively pumping
One flash	Idle
Two flashes	Active program operating
Three flashes	Programmed with delayed start
Four flashes	Memory full
No flashes	Low-battery shutdown (< 6.5 V)

B5.3.3 Preparation of Exposure Chambers and SEA Ring

Note: All tubing, filters, fittings, connectors, and valves should be previously cleaned and conditioned prior to use. Refer to Zebra-Tech Operations Manual (Appendix C) for detailed descriptions of parts and processes (V1.7 at time of writing of this SOP).

1. Place Nitex mesh inserts into outlet ports on chamber cap and secure (500- μ m screens for most other organisms).

Note: Outlet filter size = 1.8-cm diameter (roughly the size of a dime).

2. For Version 2 SEA Rings, ensure that Nitex mesh inserts are placed into inlet ports on chamber cap and secure. For Version 3 SEA Rings, attach inlet filter to exposure chamber cap using Zebra-Tech supplied silicone tubing (perforated) (~ 2") and male connector. Make sure the silicone tubing has Nitex mesh rolled inside of it (use 250- μ m screens for Mysid shrimp and 500- μ m screens for most other organisms).

Note: Inlet filter size for Version 2 SEA Ring set-ups are ~ 2-cm diameter (roughly the size of a nickel)

3. Secure inlet connector and duck bill valves to chamber cap.
4. Fit 11" exposure chambers with solid end cap on bottom of chamber.
5. Fit chamber cap on top of exposure chambers and place into SEA Ring ensuring the numbering on the caps corresponds to the numbering on the base plate.
6. Align exposure chamber and cap holes with chamber holder hole and secure retaining pin.
7. Secure tubing from pump to each exposure chamber inlet connectors.
8. Make sure that the Sea Ring has its top with a 500- μ m filter in place over each of the pump inflows.
9. Submerge SEA Ring into Chem-Tainer (previously cleaned and conditioned) filled with control water or filtered site water.
10. Temporarily activate pump in Position 1 (turn dial to "Test") to remove air bubbles that may exist in tubing.

Note: Do not secure syringe port stopper into place before addition of organisms.

B5.3.4 Loading Organisms into SEA Ring – e.g., Polychaetes, Amphipods

1. Count out organisms over light box in groups of five into plastic Solo[®] cups.
2. For quality control, a second person should double-check organism counts and condition.
3. Carefully transfer organisms into seawater filled 30-mL plastic syringes and place silicone stopper on end of syringe.
4. Place syringe into syringe port and secure screws, being sure not to depress syringe, as it will inadvertently release organisms into chamber before start of desired exposure period.
5. Note time of organism introduction into SEA Ring chambers on data sheet.

Note: Total time of organisms in syringe should not exceed 30 minutes due to potential increased stress.

B5.3.5 Loading Organisms into SEA Ring – Clams

Note: Clams should be placed inside exposure chamber prior to placement into SEA Ring.

1. Place desired number of clams inside exposure chambers fitted with clam chamber bottom (e.g., ½” stainless steel or titanium wire; See SEA Ring Operation Manual for details) on bottom, and secure chamber cap as described above.
2. Carefully place exposure chambers into SEA Ring and submerge the SEA Rings into the Chemtainer filled with FSW or other appropriate dilution water.
3. Be sure syringe port stopper is in syringe port.
4. Note time of organism introduction into SEA Ring chambers on data sheet.

B5.3.6 SEA Ring Deployment

1. Transfer Chem-Tainer and SEA Ring set-up to deployment site.
2. While submerged in site water, gently remove SEA Ring from Chem-Tainer, paying close attention not to disrupt tubing, manifold connections, or organism-filled syringes.
3. Push SEA Ring into surficial sediment at desired exposure location firmly until base plate of SEA Ring is even with the sediment surface (~ 5" beneath sediment surface).
4. Gently depress plunger on organism-filled syringes to release organisms into exposure chambers.
5. Switch control module to "Run" (counter-clockwise) to start pre-programmed pumping regime.
6. Ensure that LEDs are flashing as appropriate and SEA Ring (and water quality sonde, if used) is secure.
7. Note time of deployment on data sheet.

B5.3.7 SEA Ring Recovery

1. Bring Chem-Tainer to sea floor for recovery.
2. Make initial observations of SEA Ring condition (hoses, LED status, organism movement, and overall integrity), if possible.
3. Switch control module switch to "Position 2" (Center).
4. Dig around bottom of chambers and place plastic end caps over opening of chambers one at a time. (Note: clam chambers do not require end caps unless recovery of clam sediment is desired).
5. Remove SEA Ring from sediment and place in Chem-Tainer.
6. Note time of recovery on data sheet.
7. If desired, place pump switch in "Run" (counterclockwise) or "Test" (clockwise) to ensure pumping and water quality maintenance during transport to staging area.
8. Return to lab or staging area for breakdown and assessment.

B5.3.8 Organism Recovery

1. Disconnect tubing from chamber caps.
2. Remove retaining pin on chamber holder.
3. Carefully remove exposure chamber.
4. Gently remove chamber end cap.
5. Sieve contents of exposure chamber through a 400- to 500- μ m sieve using control or site water and place contents into Pyrex[®] dish. The smaller sieve size is recommended for *Hyalella* and *Ampelisca*.
6. Enumerate surviving organisms and note any mortalities observed and record on data sheet.
7. If required, collect organisms for subsequent measurements and/or prepare for depuration in uncontaminated dilution water prior to freezing for chemical analysis.

B5.3.9 Downloading data from SEA Ring

1. Ensuring that the programming port is dry, attach the programming cord to the SEA Ring and to a PC and start the SEA Ring Application.
2. Press the **Offload** button and save the file in a designated folder. This file is a comma separated file and can be opened in Microsoft Excel[®].

Note: The data in the SEA Ring is stored in non-volatile memory, meaning that if the battery goes flat, the data will not be lost.

B6. SEA RING QUALITY CHECK AND TROUBLESHOOTING

B6.1 OBJECTIVE

Provide the user the ability to assess the functionality of the SEA Ring in comparison to standard operation. In addition, a few common guidelines to assist the user are provided in the case of malfunctioning equipment.

B6.2 QUALITY CHECK

It is recommended that prior to use, a thorough visual and mechanical inspection of pump and battery operation is conducted to ensure proper functioning of SEA Ring.

To check pump operation, ensure flow of water is consistent across all chambers (should be approximately 100 mL/min), run a Battery Longevity Test (BLT), and run a Pump Performance Test.

B6.2.1 Version 2 SEA RING – Procedure for Battery Longevity Test:

1. Assemble SEA Ring per manufacturer’s guidelines
 2. Program SEA Ring for 29 minutes “ON” and 1 minute “OFF” with a running period of 1 week.
 3. Immerse in water
 4. Turn control module to “Position 3” (right) to start program
 5. Ensure LED lights are functioning.
 6. Check for flow from each exposure chamber outlet (inspect tubing and duckbill valve)
 7. Run SEA Ring until battery is depleted or voltage reaches 6.4 V (no blue light flashes and red blinking LED light).
 8. Following program, dry COM port and hook up to computer.
 9. Start SEA Ring software and download data file.
 10. Locate and assess voltage, revolutions, error codes, and running time for proper functioning.
- A summary of an example Battery Longevity Test is provided in Table B-13. Once a curve is established based on SEA Rings operated by the user, shorter Battery Longevity Tests (e.g., 24 hours) may be conducted to verify proper functioning (i.e., expected number of pump revolutions and voltage reduction over time Pump longevity with enhanced battery packs is shown in Figure B-1.

Table B-13. Example: Battery Longevity Test results.

	Total Minutes Pumped Prior to Shutoff (6.4 V)	Average Daily Turnover Rate (turnovers/day)	Total Turnovers per Full Charge
SR#4	5684	81	1137
SR#3	5481	78	1096
SR#2	5800	83	1160
Mean	5655	80.8	1131
SD	161	2.31	32.3
CV	2.9	2.9	2.9

Total turnovers per charge = ((pumping time until 6.4 V x 100^a)/500 mL^b)

Daily turnover rate = (total turnovers per charge)/14 days

^a100-mL/min. flow rate of water through exposure chambers

^b500-mL total water volume in exposure chamber

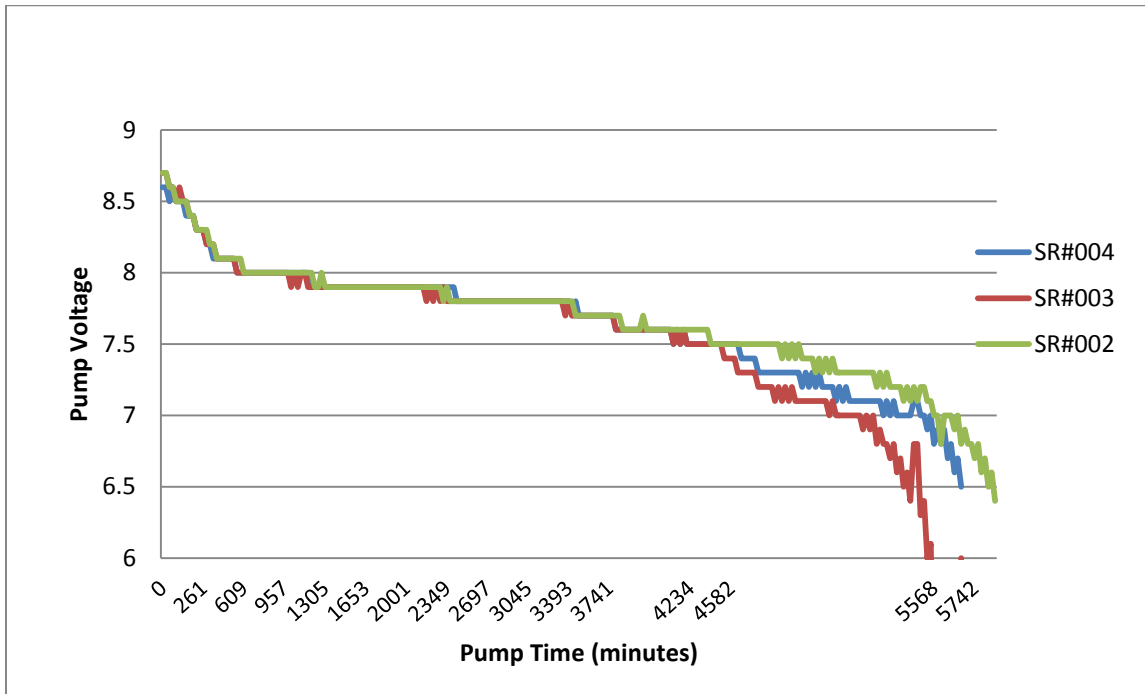

Figure B-1. Pump longevity with enhanced battery packs.

Using this information, the user can then calculate the appropriate pump rates to maximize turnovers per day for the duration of a trial.

B6.2.2 Pump Rate Calculation Example

From the above results, assume a conservative 5000-minute battery life (number of minutes of actual pump time, not deployment time) before auto-shut off at 6.4 V.

For a desired flush rate of **1-minute** pump “on”, followed by **4-minute** pump “off”:

- $60 \text{ min}/5 \text{ min} = 12 \text{ min/hr} \times 24 \text{ hrs} = 288 \text{ min/day} \times 14 \text{ days} = \mathbf{4032 \text{ total minutes}}$ of pump time required to complete program with a target **57.6 turnover rate/day**.
- Total turnovers per charge = $((\text{time until } 6.4 \text{ V} \times 100)/500)$
- Total turnovers per charge = $((4032 \times 100)/500)$
- Total turnovers per charge = 806.4
- 14-day flow rate = $(\text{total turnovers per charge})/14$
- 14 day flow rate = $806.4/14$
- 14 day flow rate = 57.6 turnovers/day

If flush rate is altered to 1-minute pump “on” followed by 3-minutes pump “off”:

- 60 min/4 min = 15 min x 24 hrs = 360 min/day x 14 days = **5043 total minutes** of pump time required to complete program with a target **72 turnover rate/day**
- 14 day flow rate = (total turnovers per charge)/14
- Total turnovers per charge = 1008.6
- 14-day flow rate = **72 turnovers/day**

Although a flush rate of 1 minute on/3 min off results in more flushing, maximum battery capacity will be exceeded in a 14-day deployment; therefore, a more conservative flush rate is required (increase “off” time). Recommended programming options based on the Version 2 are shown in Table B-14.

Table B-14. Recommended programming options based on the Version 2 SEA Ring system design (Zebra-Tech, Ltd. Operation Manual V1.7).

Exp. Period (days)	Target Turnover Rate (Ex/day)	Pump Flush ON (min)	Pump Interval OFF (min)	Battery Config. (1,2)	Avg. Minutes ON per Hour (min)	Program Pump Minutes ON	Maximum Pump Minutes ON
4	36	1	8	1	7.5	720	1867
4	58	1	4	1	12	1152	1867
4	72	1	3	1	15	1440	1867
4	96	1	2	1	20	1920	1867
4	96	1	2	2	20	1920	5600
4	144	1	1	2	30	2880	5600
4	192	2	1	2	40	3840	5600
4	240	5	1	2	50	4800	5600
14	19	1	14	1	4	1344	1867
14	24	1	11	1	5	1833	1867
14	24	1	11	2	5	1833	5600
14	36	1	8	2	7.5	2520	5600
14	43	1	6	2	9	3024	5600
14	60	1	4	2	12	4032	5600
14	72	1	3	2	15	5040	5600
14	96	1	2	2	20	6720	5600
28	24	1	11	2	5	3360	5600
28	29	1	9	2	6	4032	5600
28	43	1	6	2	9	6048	5600
28	96	1	2	2	20	13440	5600

Battery configuration 1 = Internal battery only

Battery configuration 2 = Internal + external battery pack

Note: Red values indicate that pump rate for given exposure period may exceed acceptable limits based on battery power for the given rate.

Note: Bold values indicate recommended pump regimes (for current generation of SEA Rings, per Zebra Tech, Ltd. Operation Manual V1.7).

B6.2.3 Procedure for Assessing Pump Performance

A Battery Longevity Test also provides information for pump performance, that is, the reliability of the pump turning at a consistent rate. The SEA Ring data file provides both voltage and the number of pump revolutions per time. For the scenario described above for assessing battery longevity (29 minutes ON, 1 minute OFF pump regime), we find that the pump generally turns consistently at functional voltages in the range of 150–170 revolutions per 29-minute ON cycle. The Figure B-2 summarizes the performance of several SEA Rings over approximately a 24-hour period. The revolution data were downloaded and plotted. Any major changes in the pump performance may suggest a potential problem such as strain on the motor due to grit in the pump head tension springs, need for lubrication of tension springs, misalignment of the pump or pump tubing, or other issue (see Troubleshooting Guide in Table B-15). The Pump Performance Test is conducted concurrently with the Battery Longevity Test shown in Figure B-2.

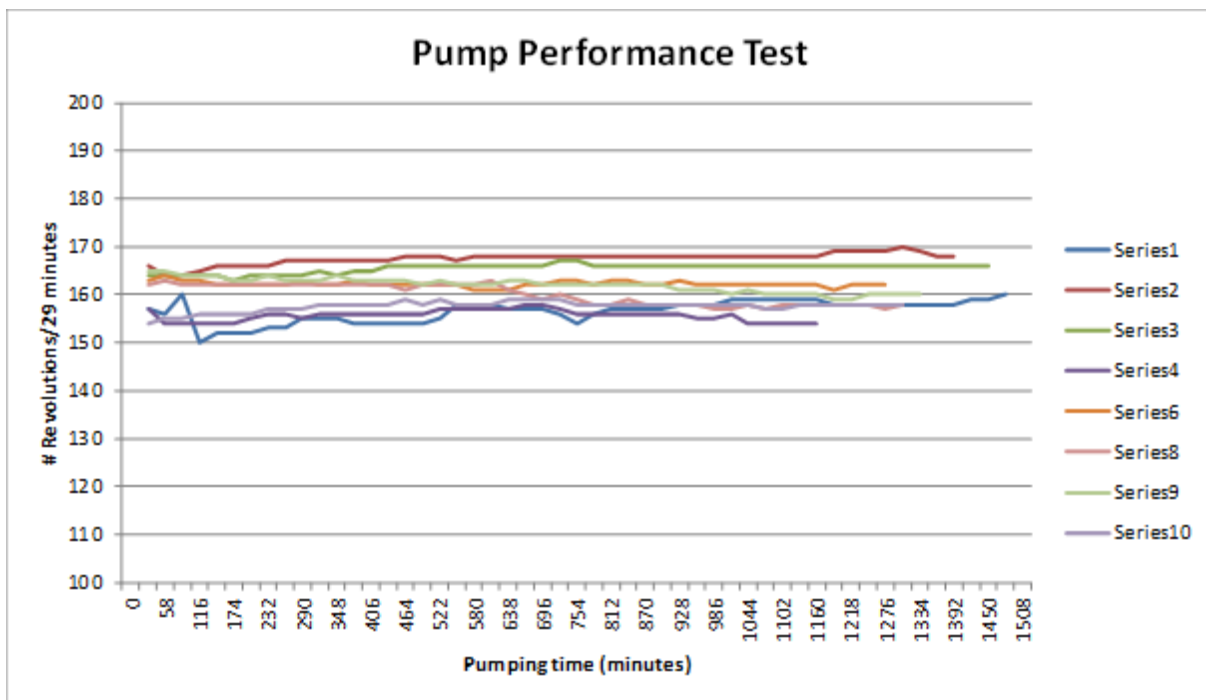

Figure B-2. Pump performance test results.

Table B-15. Troubleshooting Guide.

Issue	Potential Cause	Solution
Reduction in flow rate to one or more chambers	<ul style="list-style-type: none"> • Pinched or misaligned tubing • Loss of connection • Pump failure • Flooding in electronic components (e.g., bad O-rings) • Clogged filters • Air bubbles in chamber preventing proper flow • Syringe port stopper not properly secured 	<ul style="list-style-type: none"> • Un-pinch tubing or reconfigure tubing • Reconnect tubing to manifolds or pre-filter • Check for obstructions in rotor and ensure proper tension and lubrication of springs (Omega 580 Lubricant); check battery power • Servicing required; check O-rings on control modules prior to deployment • Remove debris • Ensure all air bubbles are flushed from system prior to organism introduction • Push syringe stopper down fully and secure with screws
Low dissolved oxygen	<ul style="list-style-type: none"> • Insufficient pump turnover rate • Insufficient exchange of water inside exposure chamber • Pump stopped functioning during deployment 	<ul style="list-style-type: none"> • Increase flushing interval • Ensure that extension tubing is used on inlet filter to ensure release of incoming water low in the chamber to maximize internal mixing • Ensure battery was charged appropriately, download pump file to verify pump performance (e.g. ,revolutions per minute at least 5?)
Loss of organisms	<ul style="list-style-type: none"> • Incorrect mesh size in inlet and outlet ports in exposure chamber cap • Syringe port stopper not properly secured 	<ul style="list-style-type: none"> • Replace mesh with proper size and properly secure with retaining rings • Push syringe stopper down fully and secure with screws
Premature termination of SEA Ring program	<ul style="list-style-type: none"> • Battery depletion • Strain on pump rotor • Incorrect sync of time when programming SEA Ring 	<ul style="list-style-type: none"> • Ensure batteries had three rounds of trickle charging to ensure full charge • Check SEA Ring pump performance by downloading file from the problem unit. • Remove grit and lubricate rotor springs (Omega 580 lubricant from Zebra-Tech), and adjust tension. • Ensure that the internal clock is synced with computer when programming.
LED lights do not work	<ul style="list-style-type: none"> • Battery depletion 	<ul style="list-style-type: none"> • Ensure batteries have three rounds of charge to ensure full charge/function.
Control module switch does not work	<ul style="list-style-type: none"> • Broken switch 	<ul style="list-style-type: none"> • Servicing required
Unable to fit/remove exposure chamber to/from exposure chamber cap	<ul style="list-style-type: none"> • Too snug 	<ul style="list-style-type: none"> • Use rubber mallet for installation – tap on chamber cap evenly. • Soak in hot water (after removal of test organisms) for removal/cleaning.

B6.2.4 Version 3 Sea Ring – Procedure for Battery Longevity Test:

1. Assemble SEA Ring per manufacturer’s guidelines.
2. Program SEA Ring for 24 seconds “chamber flush duration” and 4 minutes and 15 seconds “chamber flush interval” with a running period of 10 days .
3. Immerse in water.
4. Turn control module to “Run” (counterclockwise) to start program.
5. Ensure LED lights are functioning.
6. Check for flow from each exposure chamber outlet (inspect tubing and duckbill valve). Ensure visual confirmation that each pump is operating appropriately.
7. Run SEA Ring until battery is depleted or voltage reaches 6.4 V. If the SR turns off and goes into idle, DO NOT try to restart the program. Sometimes the voltage increases when it goes through a low battery shutdown. Running the program a second time might cause the charge to decrease too far (past 6.5 V).
8. Following program, dry COM port and hook up to computer.
9. Start SEA Ring software and download data file.
10. Locate and assess voltage, revolutions, error codes, and running time for proper functioning. A summary of an example Battery Longevity Test is provided in Table B-16. Once a curve is established based on SEA Rings operated by the user, shorter Battery Longevity Tests (e.g., 24 hours) may be conducted to verify proper functioning (i.e., expected number of pump revolutions and voltage reduction over time). Figure B-3 shows battery voltage compared to pump time/minutes.

Table B-16. Example: battery longevity test results.

Focus	Total Minutes Pumped Prior to Shutoff (6.4 V)	Average Daily Turnover Rate (turnovers/day)	Total Turnovers per Full Charge
SR#303	913	261	3651
SR#304	912	261	3650
SR#305	878	251	3514
Mean	901	257	3605
SD	19.7	5.6	79.0
CV	2.2	2.2	2.2

Total turnovers per charge = ((pumping time until 6.4V x 2000^a)/500 mL^b)

daily turnover rate = (total turnovers per charge)/14 days

^a2000-mL/min. flow rate of water through exposure chambers

^b500-mL total water volume in exposure chamber

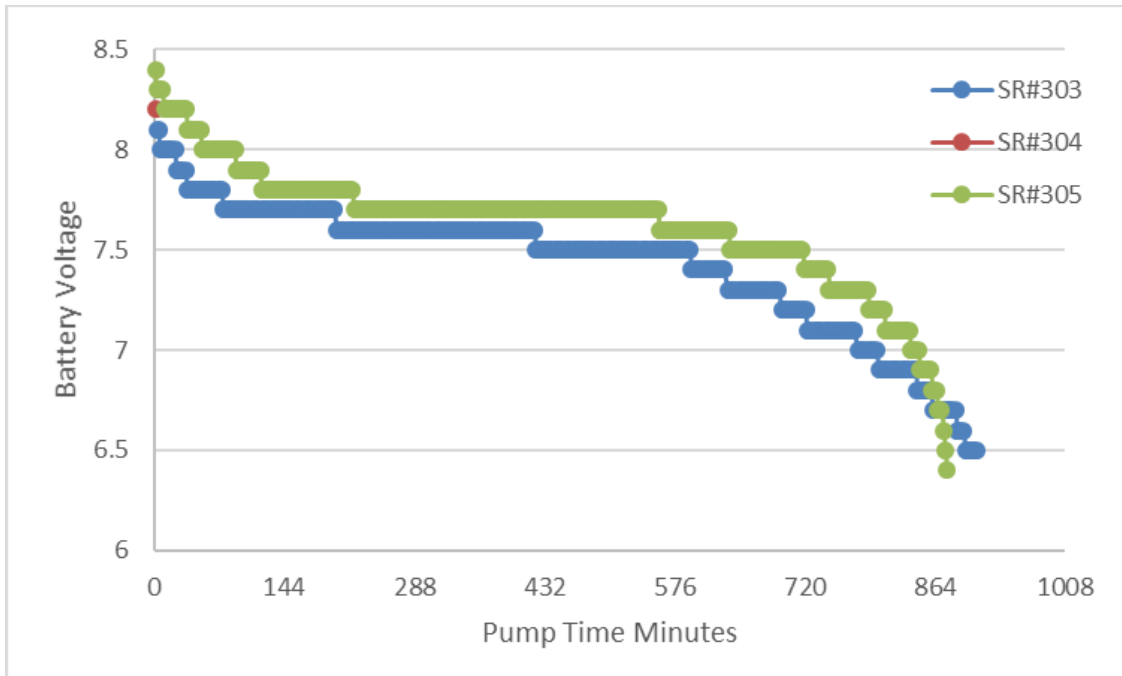

Figure B-3. Battery voltage as compared to pump time/minutes.

Using this information, the user can then calculate the appropriate pump rates to maximize turnovers per day for the duration of a trial.

B6.2.5 Pump Rate Calculation Example

From the above results, assume a conservative 900-minute/pump battery life (number of minutes of actual pump time, not deployment time) before auto-shut off at 6.4 V.

For a chamber flush duration 6 seconds pump “on” followed by 3 minutes pump “off”:

- $120\text{secs/hr} / 60\text{secs/min} = 2 \text{ mins/hr} \times 24\text{hrs/day} = 48 \text{ mins/day} \times 14 = \mathbf{672 \text{ total minutes}}$ of pump time required to complete program with a target **192 turnover rate/day**
- Total turnovers per charge = $((\text{time until } 6.4 \text{ V} \times 100)/500)$
- Total turnovers per charge = $((672 \times 2000)/500)$
- Total turnovers per charge = 2688
- 14-day flow rate = $(\text{total turnovers per charge})/14$
- 14-day flow rate = $2688/14$
- 14-day flow rate = **192 turnovers/day**

If flush rate is altered to **12** seconds “on” followed by **3** minutes pump “off”:

- $240 \text{ secs/hr} / 60 \text{ secs/min} = 4 \text{ min} \times 24 \text{ hrs} = 24 \text{ min/day} \times 14 \text{ days} = \mathbf{1334 \text{ total minutes}}$ of pump time required to complete program with a target **384 turnover rate/day**
- 14-day Flow Rate = $(\text{Total Turnovers per Charge})/14$
- Total Turnovers per Charge = 5376
- 14-day Flow Rate = **384 turnovers/day**

Although a flush rate of 12 seconds ON/3 minutes OFF results in more flushing, maximum battery capacity will be exceeded in a 14-day deployment, therefore, a more conservative flush rate is required (increase “OFF” time). Recommended programming options are detailed in Table B-17.

Table B-17 also provides recommended programming options based on the Version 3 SEA Ring system design (Zebra-Tech, Ltd. Operation Manual V1.7).

Table B-17. Recommended programming options.

Exp. Period (days)	Target Turnover Rate (Ex/day)	Pump Flush ON (sec)	Pump Interval OFF (min)	Avg. Minutes ON per Hour (min)	Program Pump Minutes ON	Maximum Pump Minutes ON
14	192	6	3	2	672	900
28	138	6	5	1.2	806.4	900

B6.2.6 Procedure for Assessing Pump Performance

A Battery Longevity Test also provides information with respect to pump performance, that is, the reliability of the pump turning at a consistent rate. The SEA Ring data file provides both voltage and the number of pump revolutions per time. For the scenario described above for assessing battery longevity (24 second ON, 4.25 minutes OFF), we find that the Smean (speed) generally is consistently at functional voltages in the range of 200–250. The Imean (current) is between 145–190. We have found that encumbered SRs (vs. unencumbered) appear to have longer battery life as the Imean is smaller for encumbered SRs. The figure below summarizes the performance of several SEA

Rings over approximately a 24-hour period. The revolution data were downloaded and plotted. Any major changes in the pump performance may suggest a potential problem such as strain on the motor due to grit prevent the propeller from or other issue (see Table B-19). The Pump Performance Test is conducted concurrently with the Battery Longevity Test. With unusual pump performance, the SR Ver 3 software with give a possible fault (in the same spreadsheet at the Imean and Smean data). Table B-18 shows an error code summary, and Table B-19 summarizes these error codes:

Table B-18. Error code summary.

Error Code	Imean Values (electrical current)	Smean Values (motor speed)
Overcurrent	> 220	--
Stalled	--	< 175
Dry	< 125	> 300
Blockage	125–145	250–300

Table B-19. Troubleshooting Guide.

Issue	Potential Cause	Solution
Reduction in flow rate to one or more chambers	<ul style="list-style-type: none"> Pinched or misaligned tubing Loss of connection Pump failure Flooding in electronic components (e.g. bad O-rings) Clogged filters Air bubbles in chamber preventing proper flow Syringe port stopper not properly secured 	<ul style="list-style-type: none"> Un-pinch tubing or reconfigure tubing Check battery power Take apart the top of the pump and clean the area around the propeller Servicing required; check O-rings on control modules prior to deployment Remove debris Ensure all air bubbles are flushed from system prior to organism introduction Push syringe stopper down fully and secure with screws
Low dissolved oxygen	<ul style="list-style-type: none"> Insufficient pump turnover rate Insufficient exchange of water inside exposure chamber Pump stopped functioning during deployment 	<ul style="list-style-type: none"> Increase flushing interval Ensure that extension tubing is used on inlet filter to ensure release of incoming water low in the chamber to maximize internal mixing Ensure battery was charged appropriately, download pump file to verify pump performance (e.g. revolutions per minute at least 5?)
Loss of organisms	<ul style="list-style-type: none"> Incorrect mesh size in inlet and outlet ports in exposure chamber cap Syringe port stopper not properly secured 	<ul style="list-style-type: none"> Replace mesh with proper size and properly secure with retaining rings Push syringe stopper down fully and secure with screws
Premature termination of SEA Ring program	<ul style="list-style-type: none"> Battery depletion Strain on pump rotor <p>Incorrect sync of time when programming SEA Ring</p>	<ul style="list-style-type: none"> Ensure batteries had three rounds of trickle charging to ensure full charge Check SEA Ring pumps performance by downloading file from the problem unit. Clean the grit around the propellers of the malfunctioning pump. <p>Ensure that the internal clock is synced with computer when programming.</p>

Table B-19. Troubleshooting Guide (continued).

Issue	Potential Cause	Solution
Premature termination of SEA Ring program	<ul style="list-style-type: none"> • Battery depletion • Strain on pump rotor • Incorrect sync of time when programming SEA Ring 	<ul style="list-style-type: none"> • Ensure batteries had three rounds of trickle charging to ensure full charge • Check SEA Ring pumps performance by downloading file from the problem unit. • Clean the grit around the propellers of the malfunctioning pump. • Ensure that the internal clock is synced with computer when programming.
LED lights do not work	<ul style="list-style-type: none"> • Battery depletion 	<ul style="list-style-type: none"> • Ensure batteries have three rounds of charge to ensure full charge/function.
Control module switch does not work	<ul style="list-style-type: none"> • Broken switch 	<ul style="list-style-type: none"> • Servicing required
Unable to fit/remove exposure chamber to exposure chamber cap	<ul style="list-style-type: none"> • Too snug 	<ul style="list-style-type: none"> • Use rubber mallet for installation – tap on chamber cap evenly. • Soak in hot water (after removal of test organisms) for removal/cleaning.

SEA Ring

Operation Manual

Version 1.7

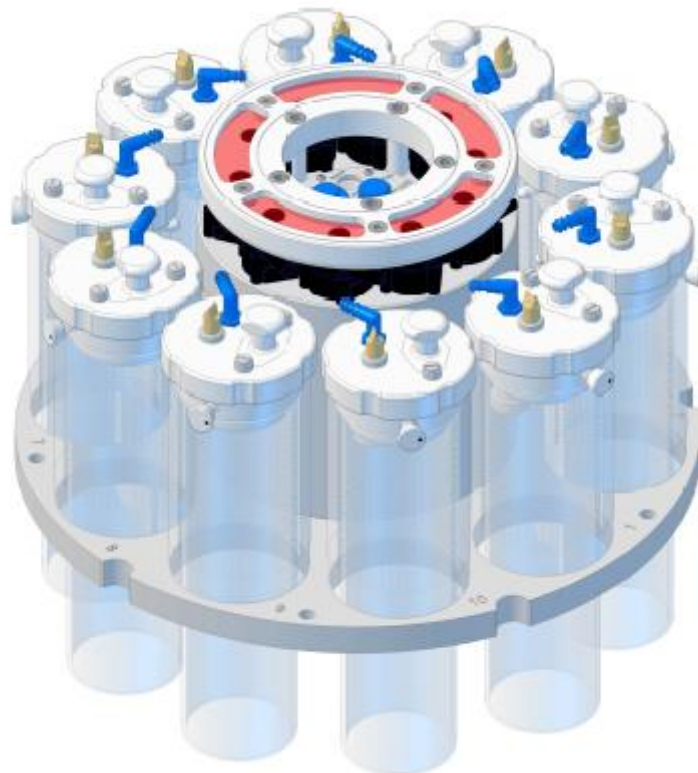

Contents

1. Overview	2
2. Hardware	3
Unpacking your SEA Ring	3
A SEA Ring consists of:	3
Pump	4
Control module	4
LED flash sequence	4
Control switch	5
Charging/communication connector	5
Chamber cap	5
3. SEA Ring Assembly Procedure	7
4. Software Installation	9
5. Charging	10
6. Field Operation	11
Chamber cap removal	11
Fitting exposure chambers	11
Software	12
Control Switch	13
7. Datafile	14
The data file format is comma separated ASCII values (.CSV), and so can be opened directly in Excel.	14
8. Servicing	16
Changing the filter screen	16
Cleaning the pumps	17
Replacing a pump	19
9. Firmware Upgrade	20
10. Appendices	21
Appendix 1: Connectors	21
Appendix 2: Construction materials	21
Appendix 3: O-rings	22
Appendix 4: Power	22
Appendix 5: Mounting v3 pump housing onto v2 base plate	23

Appendix 6: Dimensions	25
Appendix 7: Accessories	26
Appendix 8: Core Catcher	27
Appendix 9: Clam Catcher	31
11. Further Assistance	34

1. Overview

The Sediment Ecotoxicity Assessment Ring (SEA Ring) is an in-situ toxicity and bioavailability assessment device.

The SEA Ring can accommodate up to 10 exposure chambers mounted in the chamber holders. A central self-contained battery powered pumping unit flushes water at a consistent rate through all 10 chambers. The flushing duration and frequency are software controlled. All pumping operations are internally logged and can be offloaded after retrieval.

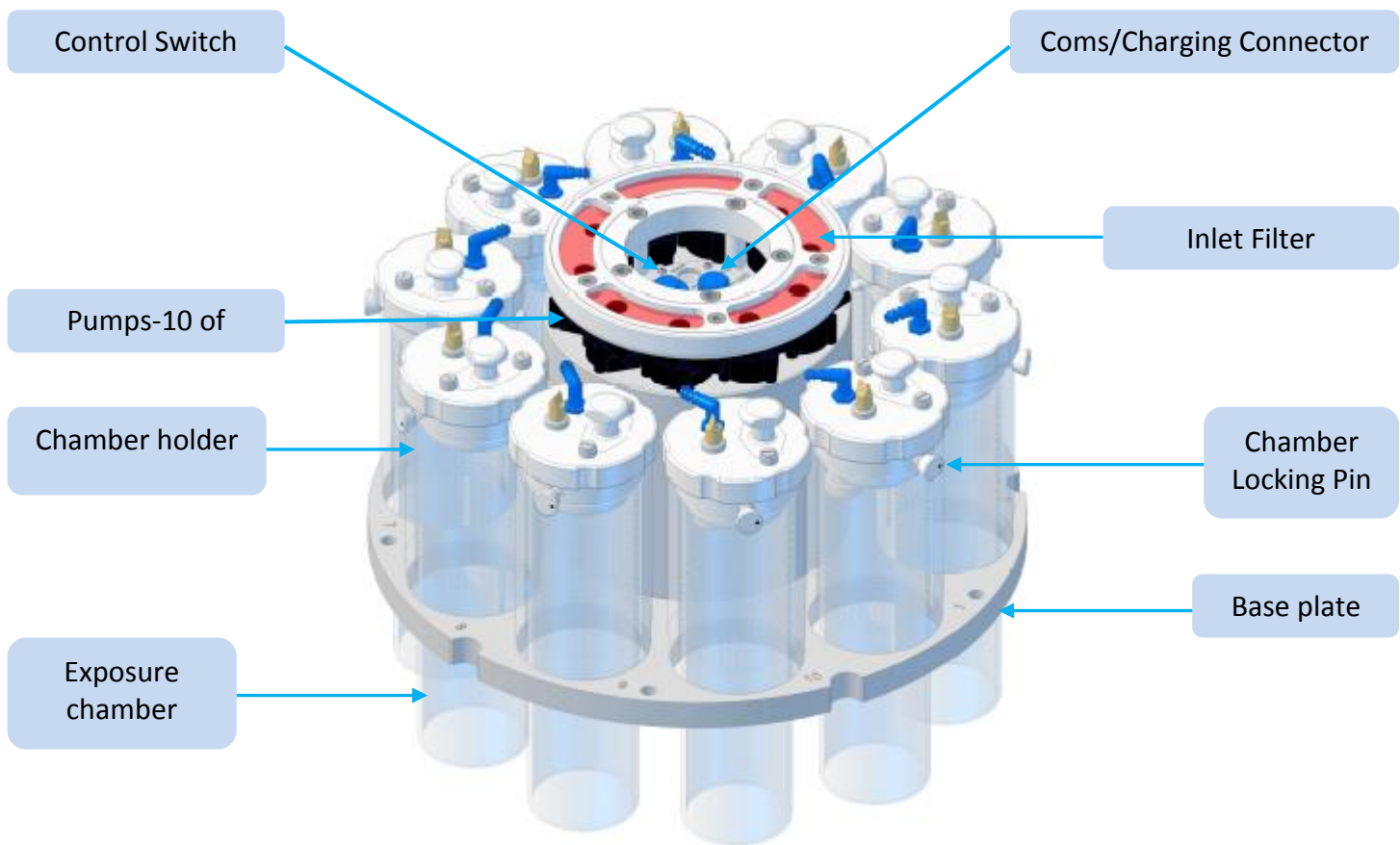

2. Hardware

Unpacking your SEA Ring

A SEA Ring consists of:

- 10 of full length core tubes
- 10 of chamber holders, fitted
- 10 of chamber holder caps with inlet fitting, extension outlet fitting with extension tube and filter screen fitted, duckbill valve
- 10 of syringe stoppers
- Pump housing, containing internal battery pack
- 10 of organism syringes

Each SEA Ring is supplied with:

- Battery charger
- Download cable
- Field service kit which includes 2 x chamber cap retaining pins, 4 x chamber cap inlet 500um filters, 4 x chamber cap outlet filter 500um, 2 x chamber cap inlet tube fitting, packet of cable ties for pump tube, assorted O-rings (2 x chamber cap, 2 x syringe stopper, 2 x coms connector cap), O-ring grease, assorted fasteners and pump lubrication oil

Each SEA Ring order is supplied with:

- 2 of 17mm spanners
- Tube of silicone glue
- Operation Manual
- USB flash drive containing software and electronic manual

Optional accessories are listed in Appendix 6 on page 25.

Pump

The SEA Ring has 10 individual pumps. Each pump is dedicated to a chamber. The pump motor housing contains the rechargeable batteries, pump control and data logging circuit boards.

During a flush cycle, the pumps run one at a time, sequentially. Each pump runs for the time set in the SEA Ring software, in the “Chamber Flush” field.

The pump housing contains the battery pack. The batteries are metal hydride rechargeable batteries, with a nominal voltage of 8 volts. The batteries are charged in situ. The charging connector features a vent that enables any gas to vent out of the housing during the charging process.

Control module

The control module features two status indicator LED’s, a control switch and the charging/communication connector.

LED flash sequence

The status indicator LED’s blink every 10 seconds.

Battery status indicator:	LED Blink Sequence:	Status Description:
	Green	Fully charged
	Orange	Moderate charge
	Red	Low battery

Mode indicator:	LED Blink Sequence:	Status Description:
	1 flash	Idle
	2 flashes	Operating
	3 flashes	Delayed start
	4 flashes	Memory full
	No flash	Low battery shutdown

Control switch

The control switch has 3 positions:

- 1) Test pumps. Selecting this position will initiate a flush cycle, in accordance with the flush durations set by with the SEA Ring software.
- 2) Idle – The SEA Ring enters a low power sleep mode. PC communications can still be used.
- 3) Operate – The flushing schedule will proceed. If the start time has elapsed, then flushing will commence when the next chamber flush interval has expired. Otherwise, the first pump flush will start after the delayed start time has been reached AND the flush interval has expired.

Charging/communication connector

The charging connector can be accessed by removing the charging connector cap. When replacing the charging connector, ensure that the O-ring is cleaned and re-greased.

Chamber cap

The chamber caps secure the exposure chambers in the chamber holders. Each chamber cap houses an inlet filter, outlet filter and duckbill outlet valve.

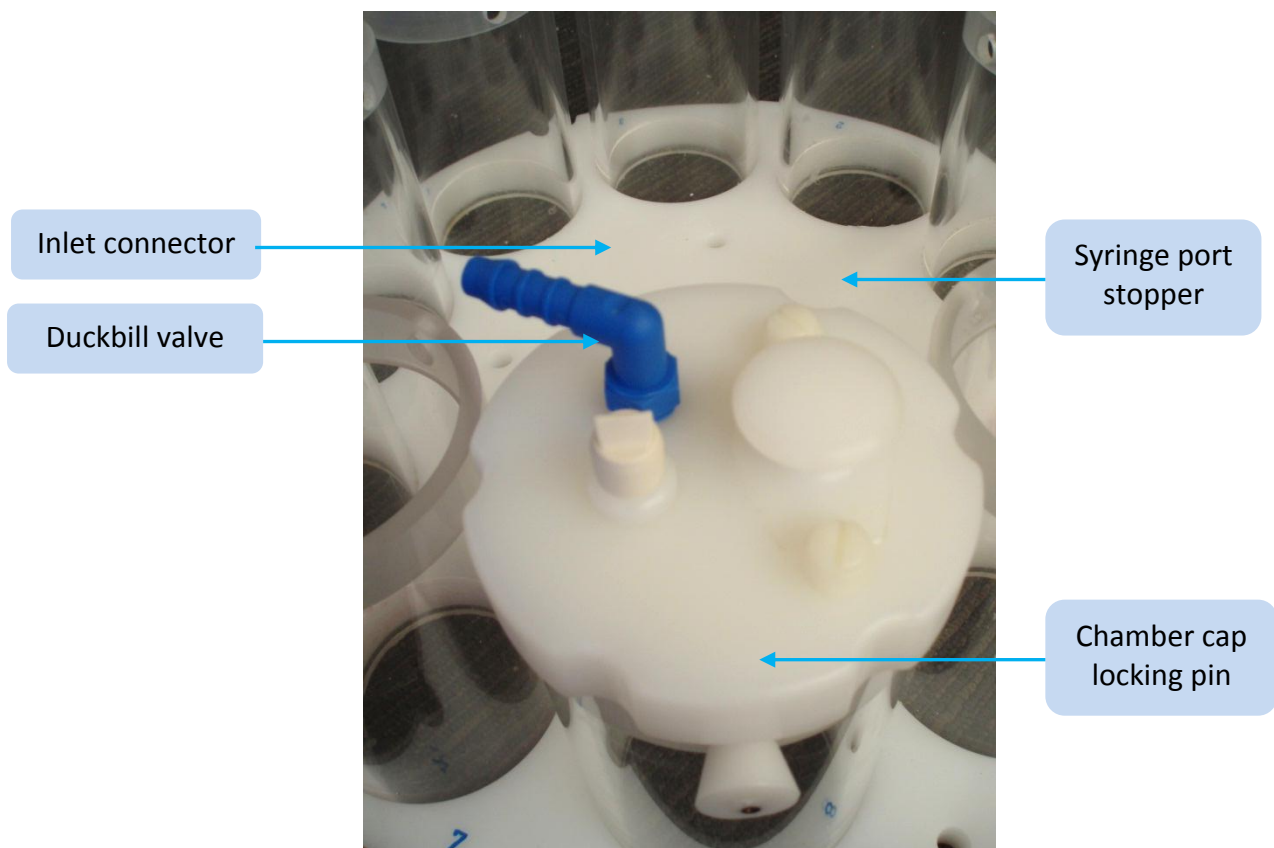

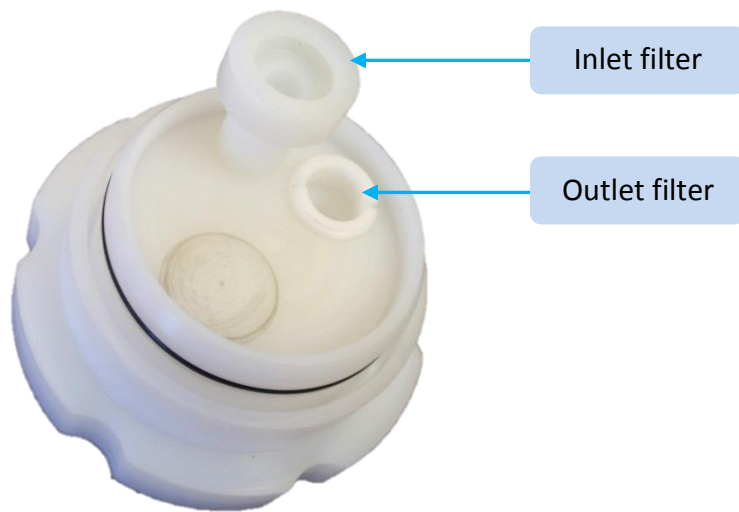

3. SEA Ring Assembly Procedure

The SEA Rings are supplied disassembled to minimize freight costs. Assembly is a relatively straight forward operation, requiring just some RTV Silicone sealer (provided) and a 17mm spanner.

1. Attach the pump housing to the base plate.

The electronics housing is attached to the base plate using four of 288mm long threaded rods. The orientation of the electronics housing relative to the base plate is denoted by the location dots. Use a FULL NUT on the top side of the electronics module. Tighten the nuts. To avoid the possibility of the nuts vibrating loose, wick in Loctite #290 can be optionally used after the nuts have been tightened. (Refer to <http://tds.loctite.com/tds5/docs/290-EN.pdf>).

Place pump bottom cover plate as per next photo.

2. Attach the chamber holders to the base plate.



Ensure the base plate is positioned with the numbering on the upper surface. Apply a finger wipe of RTV silicone glue onto the thread of the chamber holder. Screw the chamber holder into the base plate. Tighten the chamber holder until the cross holes are squarely orientated. The RTV will act as a thread locker to help prevent the chamber holder from rotating, however it will allow for disassembly if required at a later date.

Place the chamber caps into the top of each chamber holder, ensuring the numbering on the caps corresponds to the numbering on the base plate.

Connect the tube between the chamber cap fittings and the pump hose tails.

The SEA Ring batteries are in a fully discharged condition for freighting, and should be fully charged prior to use (refer to charging instructions).

4. Software Installation

The SEA Ring is supplied with a USB flash drive. This contains the SEA Ring communication software installation package. Double clicking this should launch the installer. When upgrading to a more recent version, the previous version does not need to be removed prior to installation.

The latest software is available for the Zebra-Tech web site:

<http://www.zebra-tech.co.nz/downloads>

5. Charging

The SEA Ring is an on-board Metal Hydride battery pack. The pack can be re-charged using the supplied charger.

Using the standard SEA Ring charger, 3 full charging cycles are required to ensure the full charge capacity is attained. After the charger indicates a complete charge, switch the charger off from the mains, wait 30 seconds, then switch the charger back on to perform the second charge cycle, at the end of which the power should be cycled again for the final charge cycle.

After disconnecting the charger, do not replace the coms connector cap on the SEA Ring for 1 hour. This enables any gas discharged by the battery pack to vent through the charge/coms connector.

6. Field Operation

Chamber cap removal

The chamber caps are secured in the chamber holder with a locking pin. The locking pin is secured by a keyhole style locking mechanism. To remove the locking pin, rotate it so that the black dot is uppermost. The pin can then be pulled out of the chamber holder.

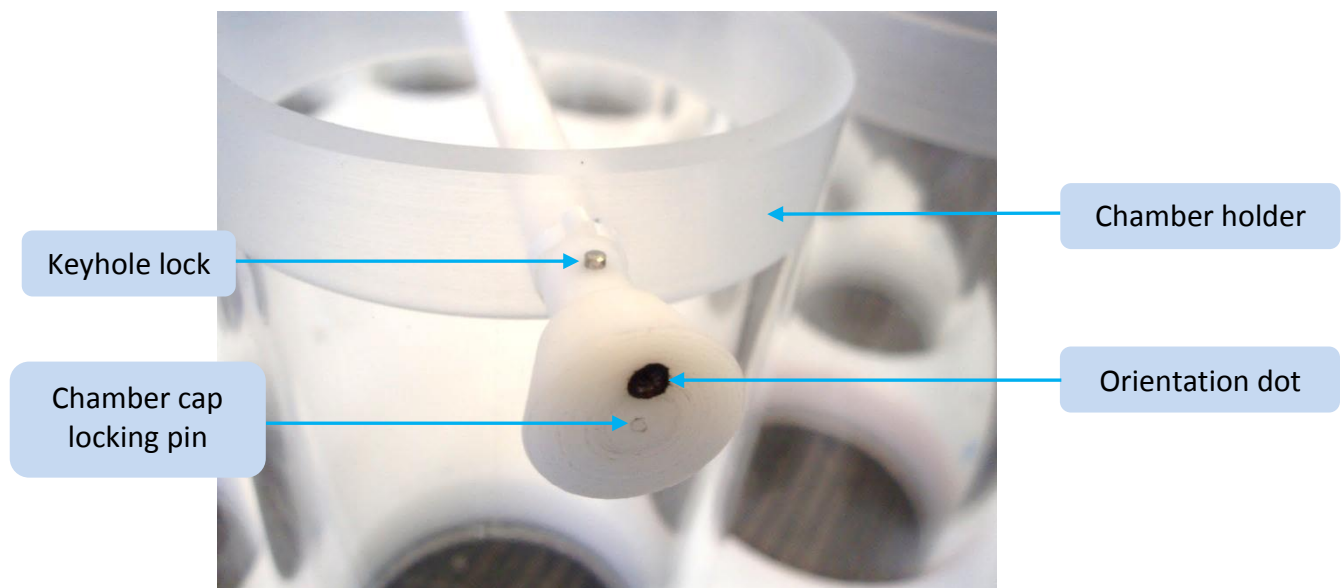

Fitting exposure chambers

The exposure chambers can be made out of Butyrate tube. The size is 2.75 OD x 2.625 ID.

Ordering information is provided in the Appendix 6 on page 25.

A cross-hole for the chamber cap pin needs to be drilled through the tube:

1. Using a 9mm drill, drill the cross hole through the walls of the tube, using the cap or a Zebra-Tech drill jig as the guide.
2. De-burr the 2 holes, particularly the internal sides of the holes.

Software

Ensure the SEA Ring is charged. Connect the coms cable to the SEA Ring and a USB port on the PC. Start the SEA Ring communication application. Provided the SEA Ring is correctly connected and operational, the main window should open.

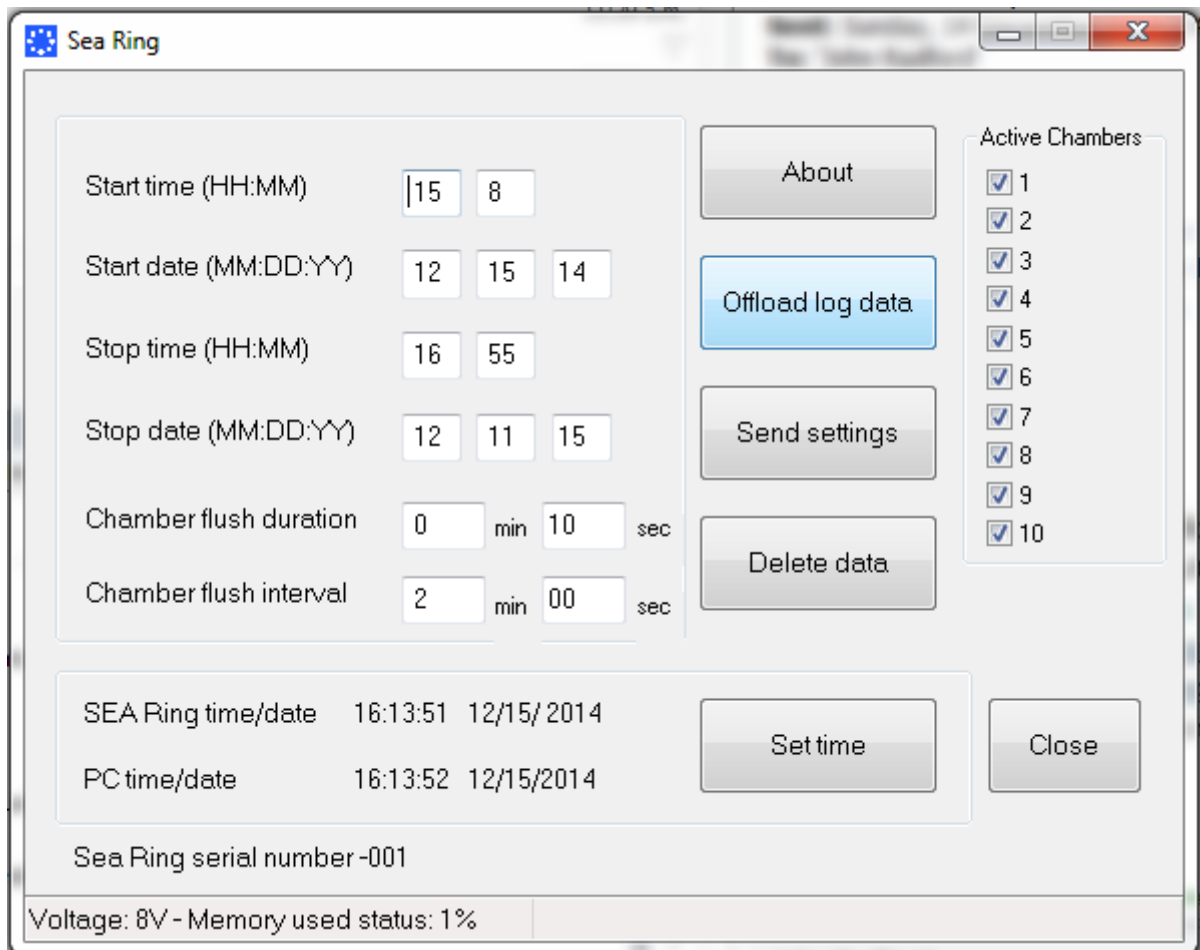

Figure 1: SEA Ring application main program window

Offload log data

The Offload button downloads data from the SEA Ring to a user selected file on the PC. The file format is ASCII, comma separated, and can be opened in Excel.

The data in the SEA Ring is stored in non-volatile memory. If the battery goes flat, data is not lost.

Send settings

Once the operating parameters have been set, they are sent to the SEA Ring by pressing the 'Upload settings' button.

Delete data

Data can be deleted off the SEA Ring using the 'Delete data button'.

Active chambers

The tick boxes can be used to set which pumps are required to operate during the flush cycle.

Set time

The current time and date of the SEA Ring can be synchronised with the PC time and date. The SEA Ring time will be reset if the battery goes completely flat.

Chamber flush duration

This field is the length of time that each pump will operate for during the flush cycle.

Chamber flush interval

This field is the time between the START of one flush cycle and the START of the next flush cycle.

Voltage

This field indicates the battery voltage. Around 9 volts is fully charged, 7.5 volts is mid-charge, and 6.5 volts is flat. If the battery voltage drops lower than 6.5 volts, the SEA Ring will cease functioning and enter a low power shutdown mode. The pump will not operate until the batteries have been recharged.

Memory status

This is the percentage of the memory used.

Control Switch

Once the SEA Rings start time has been uploaded, the clock set and optionally the data deleted, the coms cable can be disconnected. The coms cap O-ring should be serviced and then the cap can be screwed onto the coms connector.

The control switch can then be moved to either the center 'off' position or the 'run' position.

If it is in the 'run' position, the pumping schedule will begin at the programmed time and date. If it is the 'off' position, the pumping schedule will not run.

If the control switch is moved from the 'off' position, to the 'run' position, and the start time and date has elapsed, the pumping schedule will start immediately.

7. Datafile

The data file format is comma separated ASCII values (.CSV), and so can be opened directly in Excel.

SEA Ring serial number: -001																
PC download time 15/12/2014 16:24																
Event	Time	Date	Battery Voltage	Chamber 1			Chamber 2			Chamber 3			Chamber 4			
				Imean	Smean	Fault	Imean	Smean	Fault	Imean	Smean	Fault	Imean	Smean	Fault	
New schedule received	15:06:55	12/15/2014														
Switch to RUN	15:06:59	12/15/2014														
Switch to IDLE	15:07:23	12/15/2014														
New schedule received	15:07:46	12/15/2014														
Switch to RUN	15:07:49	12/15/2014														
SCHEDULE START	15:08:01	12/15/2014														
Pump start	15:08:02	12/15/2014														
Pump stop	15:09:42	12/15/2014	8	72	333 DRY	76	308 DRY	72	334 DRY	66	354 DRY					
Pump start	15:10:02	12/15/2014														
Pump stop	15:11:42	12/15/2014	8	72	331 DRY	76	309 DRY	72	335 DRY	66	354 DRY					
Pump start	15:12:02	12/15/2014														
Pump stop	15:13:42	12/15/2014	8	72	336 DRY	76	306 DRY	72	335 DRY	65	355 DRY					
Pump start	15:14:02	12/15/2014														
Pump stop	15:15:42	12/15/2014	8	72	333 DRY	76	307 DRY	71	339 DRY	66	351 DRY					
Pump start	15:16:02	12/15/2014														
Pump stop	15:17:42	12/15/2014	8	72	331 DRY	69	344 DRY	71	337 DRY	66	355 DRY					
Pump start	15:18:02	12/15/2014														
Pump stop	15:19:42	12/15/2014	8	72	334 DRY	69	337 DRY	71	341 DRY	65	352 DRY					
Pump start	15:20:02	12/15/2014														
Pump stop	15:21:42	12/15/2014	8	72	338 DRY	69	333 DRY	71	338 DRY	66	353 DRY					
Pump start	15:22:02	12/15/2014														
Pump stop	15:23:42	12/15/2014	8	72	332 DRY	76	305 DRY	71	341 DRY	66	356 DRY					
Pump start	15:24:02	12/15/2014														
Pump stop	15:25:42	12/15/2014	8	72	332 DRY	69	340 DRY	72	338 DRY	66	354 DRY					
Pump start	15:26:02	12/15/2014														

IMean

This field is the mean current drawn by each pump during the flushing cycle of each chamber, expressed in milliamperes.

Smean

This is the mean speed of the pump the, during the flushing cycle of each chamber, expressed as poles per second (there are 6 poles, so multiply by 10 to give RPM).

If the pump runs dry then the speed increases above normal, and current drops.

If the pump rotor is impeded or jammed then the speed will be significantly reduced (or zero) and the current will be increased. In this event, the motor is shutdown.

If the motor current is less than 125 or the speed above 300 then the pump is deemed to be running dry.

If the motor current is between 125 and 145 or the speed is between 250 and 300 then it is deemed that there is a blockage.

If the current exceeds 220 then it is deemed that there is an overcurrent situation.

If the speed is less than 175 then it is deemed that the motor is stalled.

Speed between 175 and 250 with current between 145 and 220 is deemed to be normal operation.

Fault

If there is a fault, the most likely self-diagnosis is presented in this field.

The possible fault cases are; Dry running, blocked pump inlet/outlet, jammed pump, malfunctioning pump.

8. Servicing

Changing the filter screen

1. Undo the five white plastic screws on the filter plate

Location of screws

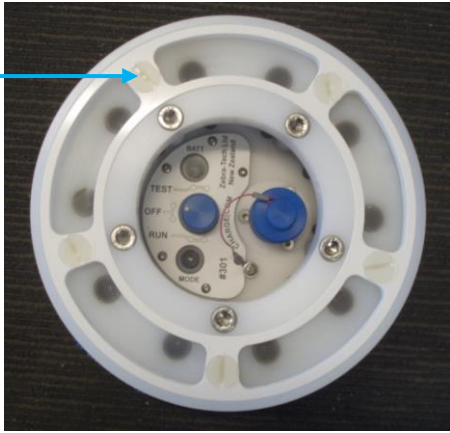

2. Remove the white filter plate from the Sea Ring

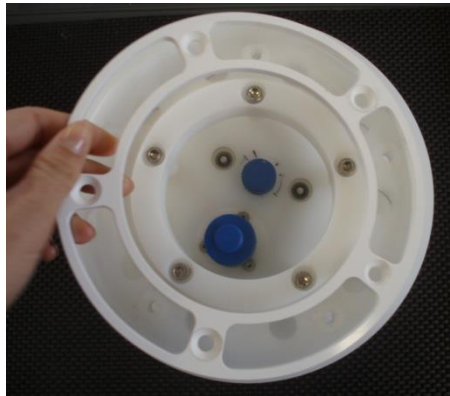

3. The filter screen is now easily removed by hand. Replace it with a new filter screen which can be stretched to fit securely in place.

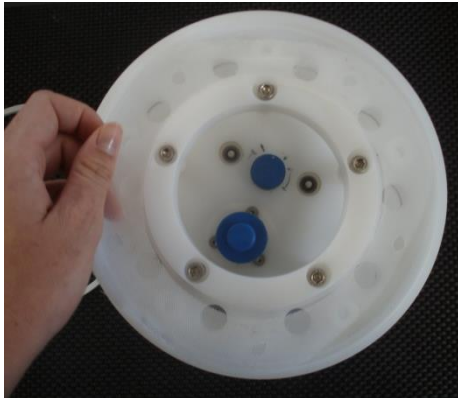

Cleaning the pumps

1. Unscrew the 5 stainless steel hex bolts on the inner circle of the Sea Ring

Location of bolts

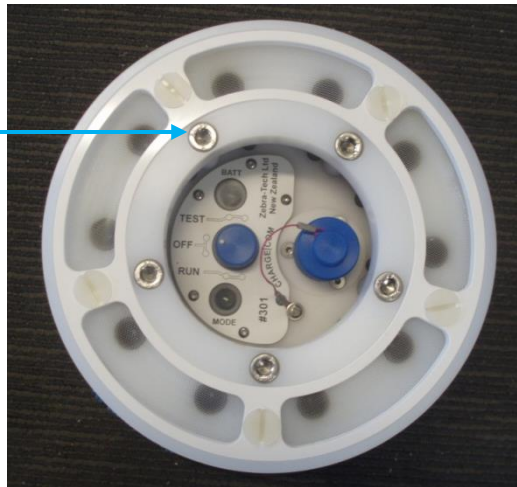

2. Remove the top of the Sea Ring

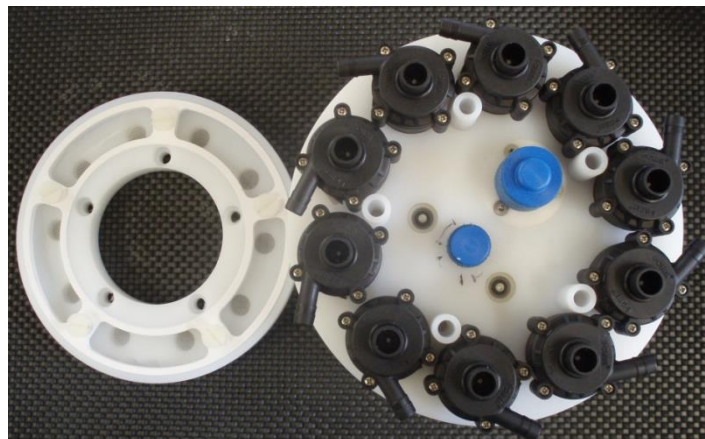

3. The pump is held in place with an O-ring and can be lifted out





4. Disconnect the wire underneath the pump. The pump can now be replaced with a new pump if required.
5. Undo the 4 screws on the top of the pump

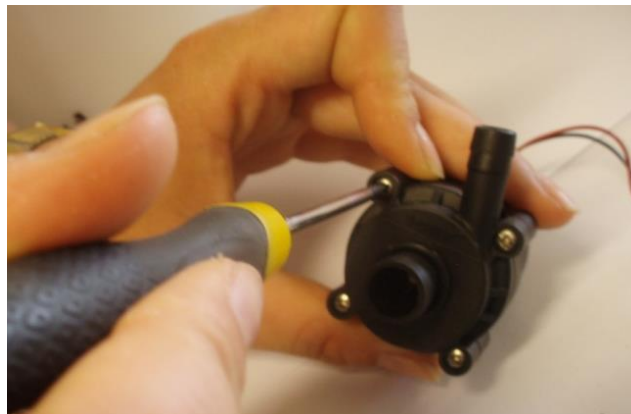

6. Remove the pump plate and clean the impellor



Ensure when you are fitting the pump together again that the outlet spigot is at right angles to the flat of the base.

Replacing a pump

To replace the pump follow steps 1-4 of the Cleaning Pump procedure above and replace the pump with a new one. Apply grease to the base of the new pump. Before replacing it back into the correct position ensure that it is correctly aligned (the flat face in indent) and the wires are connected.

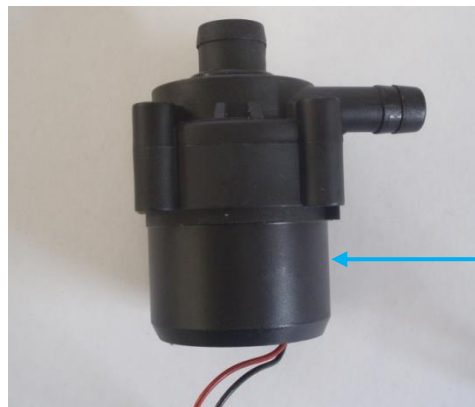

Apply grease here

9. Firmware Upgrade

From time to time Zebra-Tech may release a firmware upgrade to enhance the operating performance of the SEA Rings. Zebra-Tech will notify users when this occurs.

The firmware inside the SEA Ring can be updated using the boot-loader application provided on the Zebra-Tech USB flash drive. This is a straight forward process.

1. Ensure SEA Ring application is closed on your PC, and the SEA Rings batteries are well charged. Save the latest firmware to a convenient location on your PC.
2. Connect the SEA Ring to the coms cable and plug the cable into the PC.
3. Start the boot-loader application.
4. Select the correct com port for your PC and set all other parameters according to the window below.

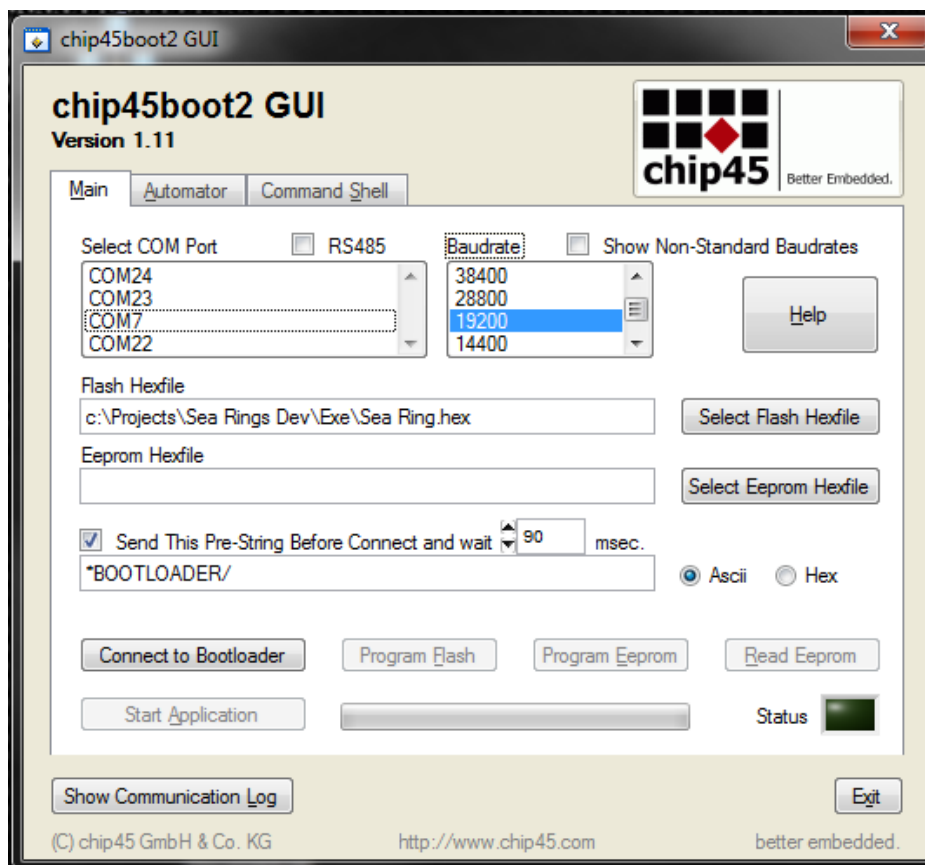

5. Press the 'Connect to Bootloader' button.
6. Once a connection has been established, press the 'Program Flash' button and select the latest firmware version that you have received from Zebra-Tech.
7. Once the firmware has been successfully installed, disconnect the coms cable and close down the Boot-loader software.

10. Appendices

Appendix 1: Connectors

Charging/Communication Cable:

Pin number:	Function:
1	Charge
2	Ground
3	PC Transmit
4	PC Receive

Appendix 2: Construction materials

Component	Construction material
Base plate	UHMWPE
Chamber holder	Cast acrylic
Chamber cap	UHMWPE
Chamber pin	Delrin
Syringe stopper	UHMWPE
Duckbill valve	Silicone, ML154
Duckbill nipple	UHMWPE
Inlet tube fitting	Nylon
Inlet filter holder	UHMWPE
Outlet filter securing ring	UHMWPE
Exposure chamber	Butyrate
Pump tubing	Silicone, 60A
Pump inlet manifold	UHMWPE

Appendix 3: O-rings

Chamber cap	Nitrile 2 3/8" x 3/32"
Syringe port	Nitrile 1" x 3/32"
Coms cap	Nitrile #617

Appendix 4: Power

Internal Batteries: 12 packs of 3 x Twicell HR-4/3FAU 4500mA NiMH

Power consumption:

Mode	Power consumption mAh
Idle	0.05
Run	0.06
Pumping	200mA per pump

Charger: Cell-Con Model 452215-NA

Appendix 5: Mounting v3 pump housing onto v2 base plate

New bolt holes need to be drilled in the v2 baseplate, to mount the v3 pump.

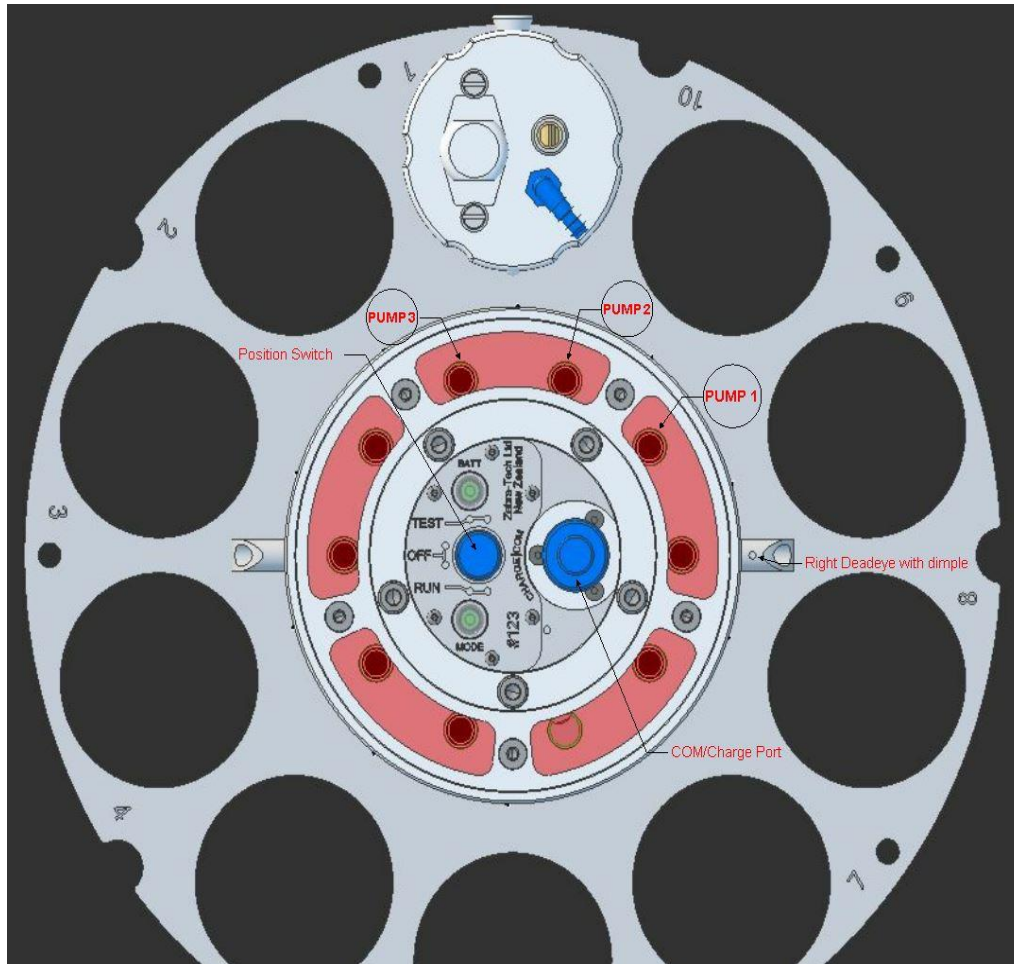

1. The 2 deadeyes for the rope handle, the Position Switch and the COM/Charge Port are all in-line. The right deadeye has a small dimple drilled into the top. This is used as an orientation indicator when mounting the SEA Ring Pump Housing onto the Base Plate.
2. To identify PUMP 1, look at the SEA Ring from the top, making sure the deadeye with the dimple is on the right; the pump between the COM/Charge port and the right deadeye is PUMP 10, the pump directly above it is PUMP 1.
3. Pump number is incremented in a COUNTER-CLOCKWISE direction, as indicated in the diagram above.
4. To identify the correct mounting orientation when mounting the SEA Ring Pump Housing onto the SEA Ring Base Plate: orient the right deadeye (with the dimple) in between Chamber 8 and 9, then orient the left dead eye in between Chamber 3 and 4, as shown in

the diagram above.

5. To identify the correct mounting orientation for remounting the PUMP Plate when the SEA Ring is opened: line up the COM/Charge port, PUMP 10 with the right deadeye (the one with the dimple), as shown in the pic above.

6. Drill new mounting holes in the baseplate, as per the drawing below;

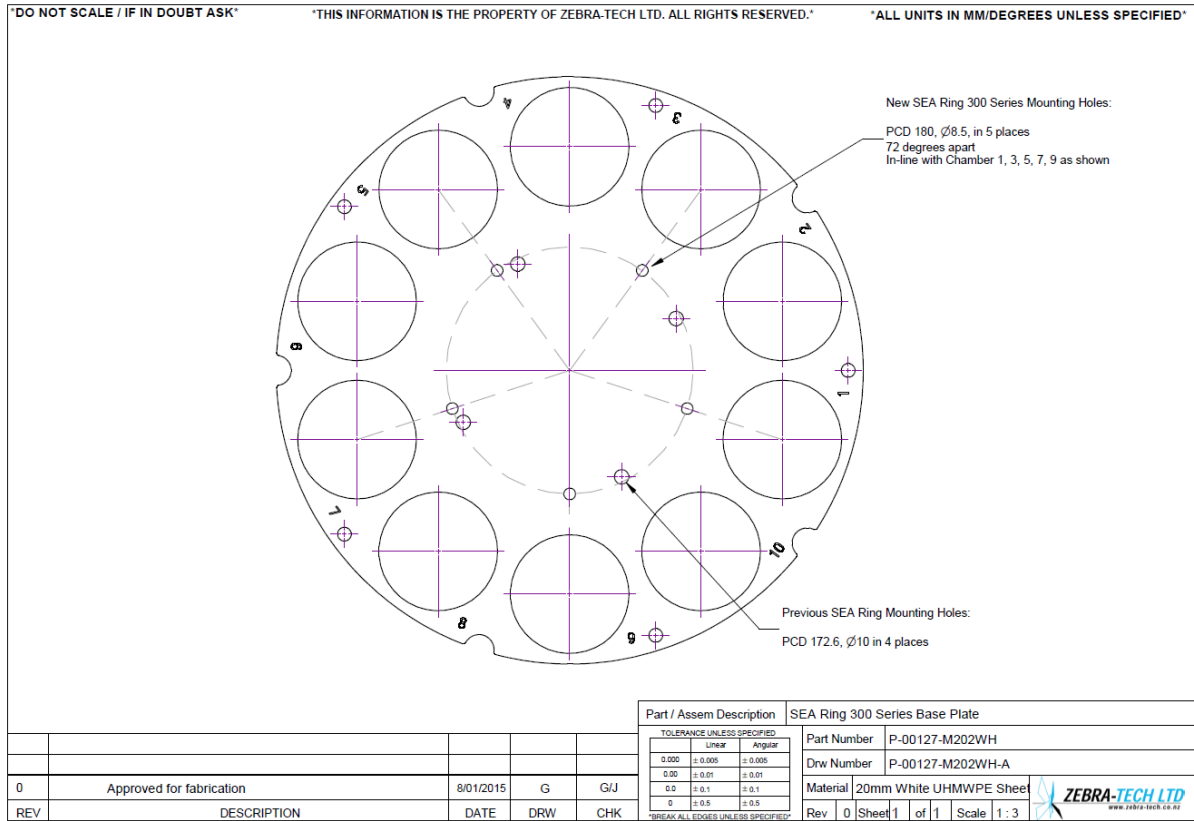

7. Bolt the pump unit onto the baseplate using 5 of 316 (A4) stainless Hex Head bolt M8 x 40, using M8 washers.

Appendix 6: Dimensions

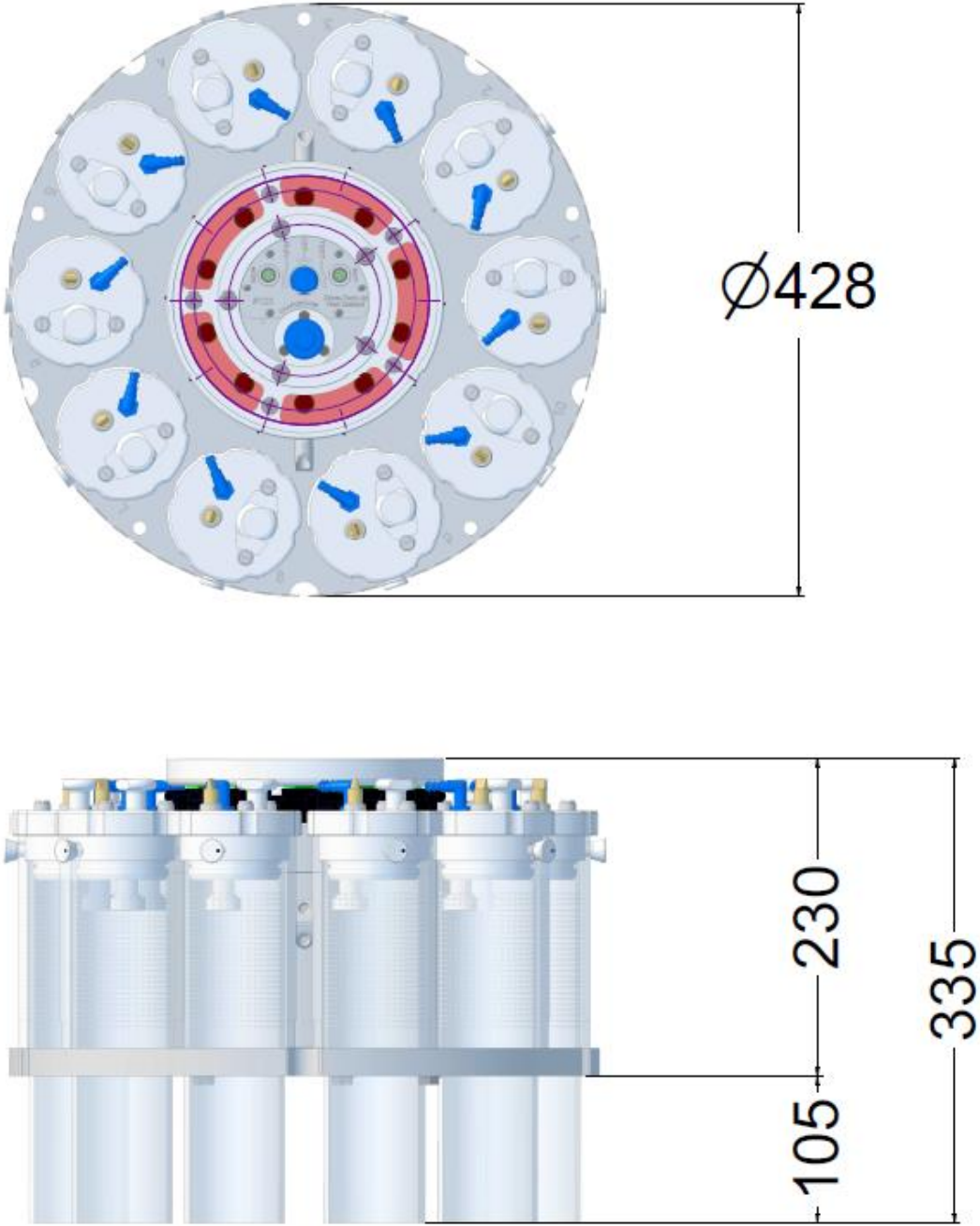

All dimensions in MM

Appendix 7: Accessories

Order Code	Optional Accessories:
PP	Pump tube replacement pack
ED	Embryo drum: acrylic tube, 25 µm nylon mesh, 2 access ports
EDF	Embryo drum, flanged: acrylic tube, 25 µm nylon mesh, 2 access ports
PF	Pump Inlet filter: 500 µm nylon screens, includes fixing hardware and tube fittings
CO250	Chamber cap outlet filter screens – packet of 10, 250um
CO500	Chamber cap outlet filter screens – packet of 10, 500um
CI250	Chamber cap inlet filter screens – packet of 10, 250um
CI500	Chamber cap inlet filter screens – packet of 10, 500um
CDV	Chamber cap duck bill valves – packet of 10
CIT	Inlet tubing (4" extension), packet of 10
CW	Titanium wire for clam chamber bottom. Makes 10, includes assembly plans.
FX	Extra washers, nuts (both sizes)
DJ	Jig for drilling holes in CAB tubing (core tubes). For drilling cap through-pin hole and holes for building wire clam catcher.
TK	Tool kit – wrench, pliers, screwdriver, tie wraps etc
OS	Organism syringe: 20ml syringe modified with silicone bung
CC	Core catcher, pack of 10, includes core catcher fabric, activation line, adhesive and fitting instructions
CCA	Core catcher auto activation rig, includes frame, fixing hardware, instructions and 10 bungee cords

Ordering information for parts that should be obtained by user domestically

End caps	Part # A2-3/4A http://www.alliance-express.com
Core tubes	Tenite CAB Tubing, 2.75" OD X 2.625" ID X 0.062" wall Part # KM-2340 http://k-mac-plastics.com/butyrates-tubes.htm
Chemtainer	Part # TC1815AA (current 17 gal chemtainer and lid) 18" Diameter x 15" Height (interior height is closer to 17" including lip) http://www.chemtainer.com/opentop/cyl_default.aspx

Appendix 8: Core Catcher

The Zebra-Tech Core Catcher has been specifically designed to aid the SEA Ring retrieval process. When the SEA Ring is lifted from the sediment, the Core Catcher closes, retaining the sediment core in the exposure chamber.

The Core Catcher consists of a piece of fabric that is stuck around the bottom of the exposure chamber. A piece of mono-filament nylon line is threaded through the Core Catcher. An elastic bungee cord is used to activate the Core Catcher.

Core Catcher Assembly

The Core Catcher is supplied in the form of a strip of fabric, cut to the correct shape and with all necessary holes. A high grade adhesive tape is attached on one side.

1. Thoroughly clean the exposure chamber. Ensure the edge is not sharp.
2. Place the core catcher on a hard flat surface with the self-adhesive tape facing upward and remove the backing.
3. Place the exposure chamber on the edge of the core catcher, ensuring the exposure chamber fixing holes are vertically aligned and the edge of the tape is parallel to the edge of the core tube. See photo 1.

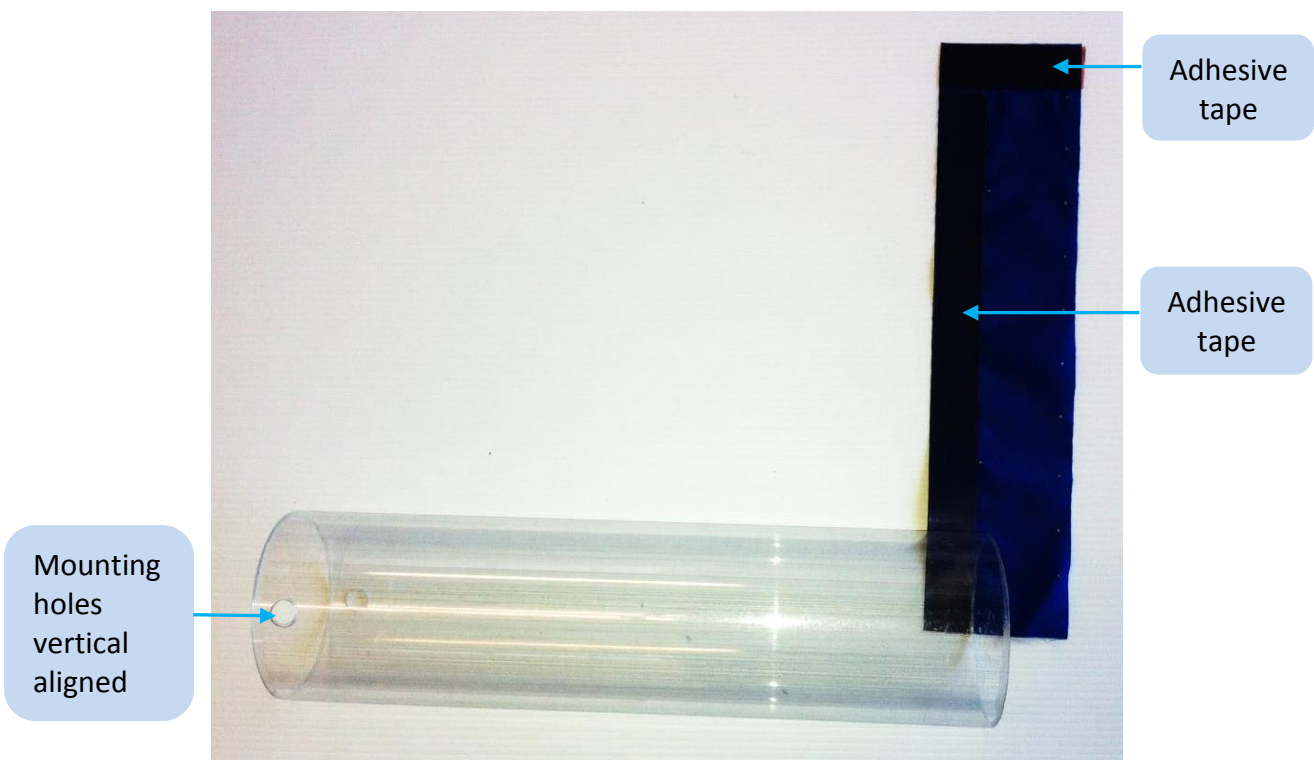

Photo 1: Attaching the core catcher onto the exposure chamber

4. Roll the core tube along the core catcher so that they stick together.
5. Squeeze the overlapping ends of the nylon together to ensure a good bond.
6. Apply pressure to the taped bonds on the core tube. Note that the greater the pressure the better the bond.
7. Place the exposure chamber vertically with the core catcher at the top and the seam facing you.
8. Thread the end of the fishing line into the hole on the bottom left hand side of the core catcher. See photo 2.



Photo 2: Threading the core catcher line

9. Weave the line in and out of the top edge holes until thread is out of the right hand hole. See photo 3.

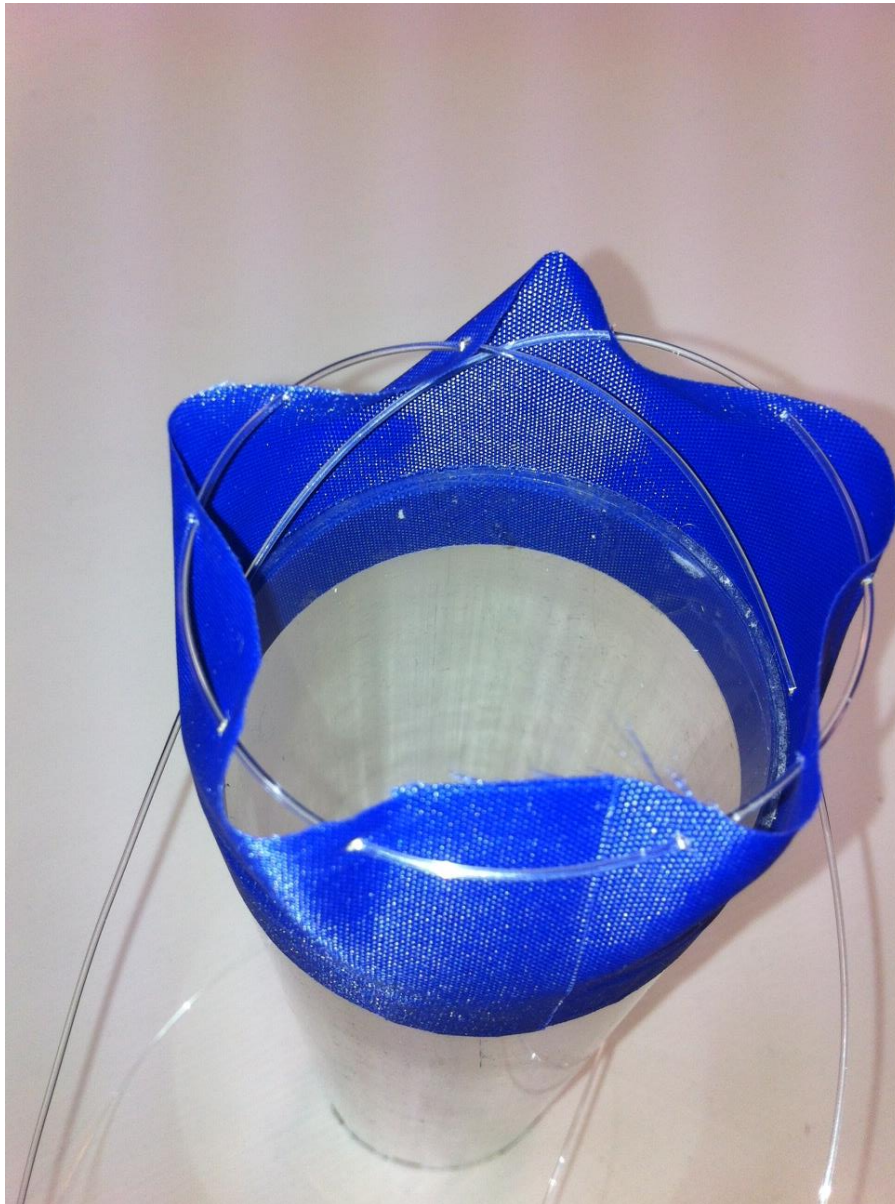

Photo 3: Threading the core catcher line

10. Mount the core tube into the core chamber. Attach the chamber cap and pin.
11. Fully open the core catcher and then tie the ends of the line together using a Double Uni Knot, see Figure 2. The line loop should extend just above the top of the base plate when the core catcher is open.

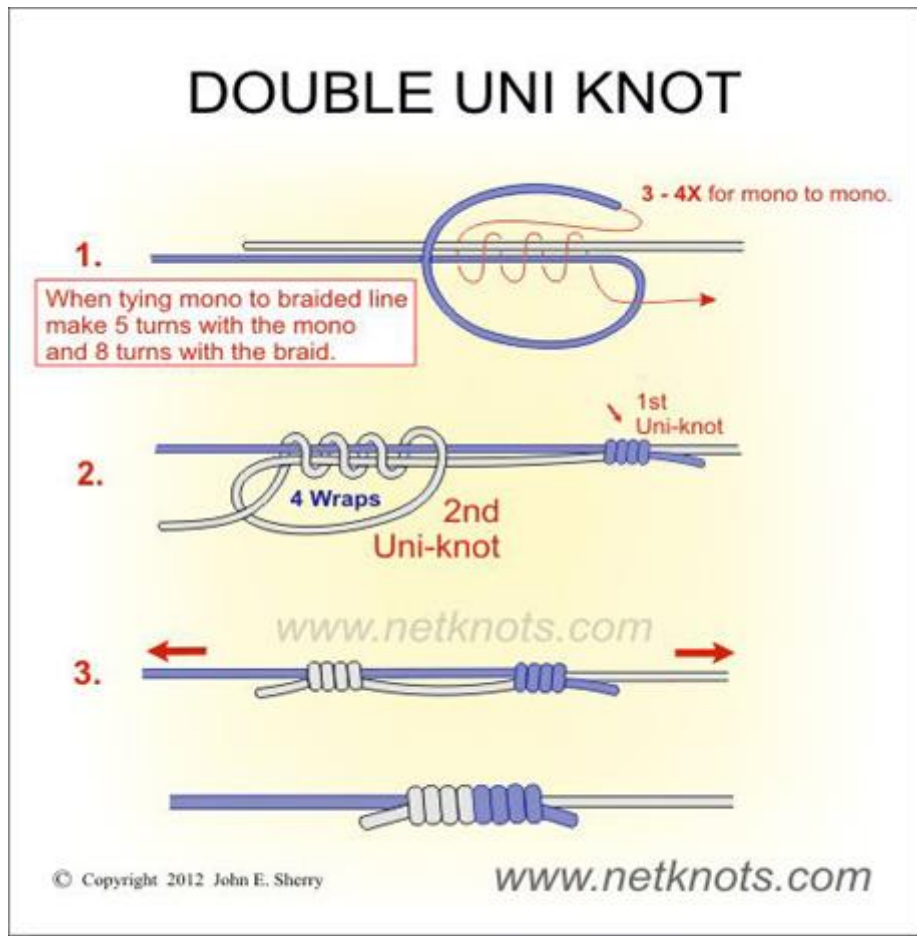

Figure 2: Double Uni Knot http://www.netknots.com/fishing_knots/double-uni-knot/

- a. Overlap the ends of lines to be joined. Take the end of the line from the left and double back and make 3 to 4 wraps around both lines and through the loop that was formed. Pull tag end to tighten.
- b. Repeat with the end of the line on the left, making the same number of wraps, unless tying with braided line, in which case you should double the number of wraps.
- c. You have now tied two Uni knots. Pull the standing lines in opposite directions to slide the two knots together.
- d. Clip the ends of the line close to the knot.

Operation of the Core Catcher

Deployment

- 1) Ensure the core catcher is completely open, with the fabric lying around the inside wall of the exposure chamber.
- 2) Deploy the SEA Rings.

Retrieval

- 1) Attach the core catcher activation ring onto the top of the 4 threaded rods that run through the SEA Rings.
- 2) Attach the elastic cords onto the core catcher line loops.
- 3) Slowly lift the SEA Ring out of the sediment. The core catchers should close.

Appendix 9: Clam Catcher

The clam catcher is a wire grid that can be incorporated into the bottom of exposure chambers to retain larger organisms. Zebra-Tech can supply both the drill template, and 0.025" Grade 2 Titanium Wire. A 1m length of wire is required for each clam catcher.

Construction

1. Using the Zebra-Tech Clam Catcher drilling template, mark out the holes.



2. Drill the holes using a 1.5mm drill



3. Attach the end of the Titanium wire using a double hole.

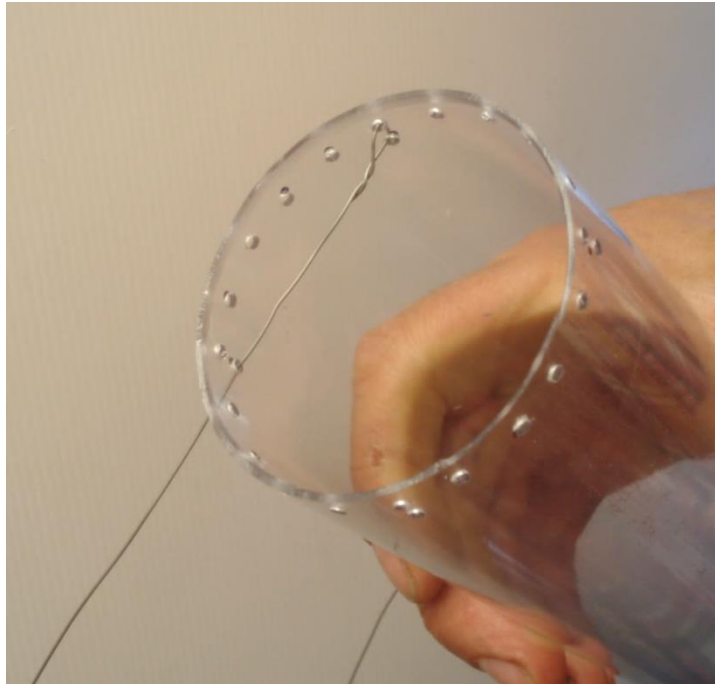

4. Thread the wire through the holes.

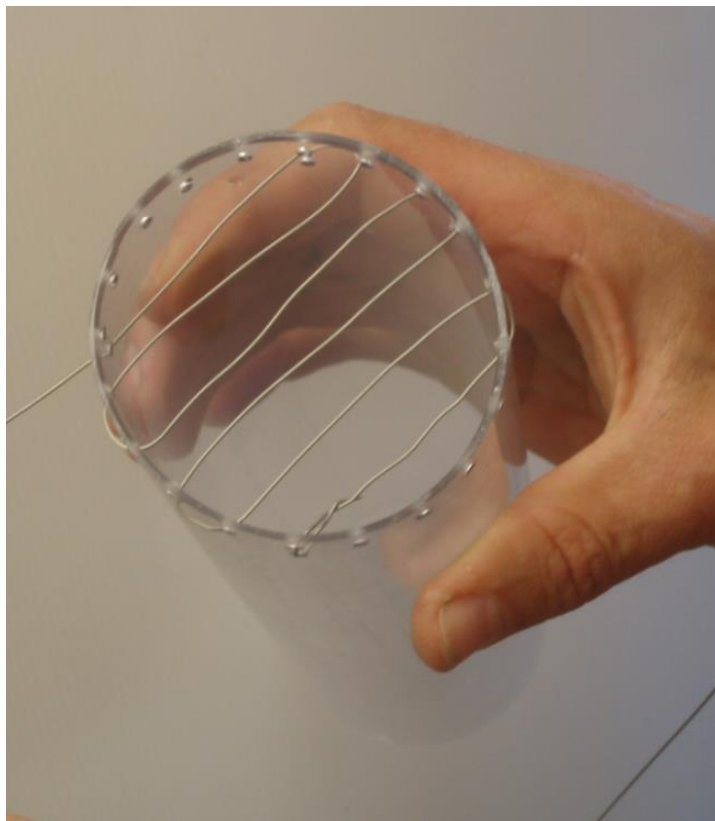

5. Secure the end of the wire back onto itself and cut off excess wire.

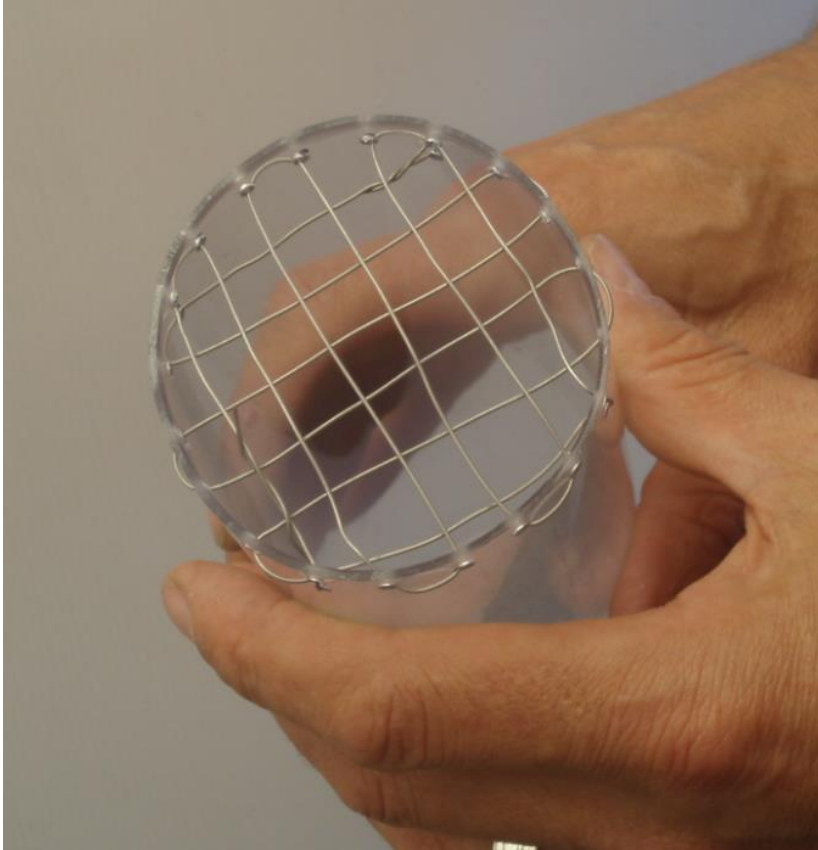

11. Further Assistance

For further assistance with this or any other **Zebra-Tech** product, please contact:

Zebra-Tech Ltd
PO Box 1668
Nelson 7040
New Zealand

Tel: International 0064 3 548 0468

Fax: International 0064 3 548 0466

Email: enquiry@zebra-tech.co.nz

For up to date information on Zebra-Tech products, please visit the **Zebra-Tech Ltd** website at: <http://www.zebra-tech.co.nz>

APPENDIX D
MCB QUANTICO DATA FIGURES AND TABLES

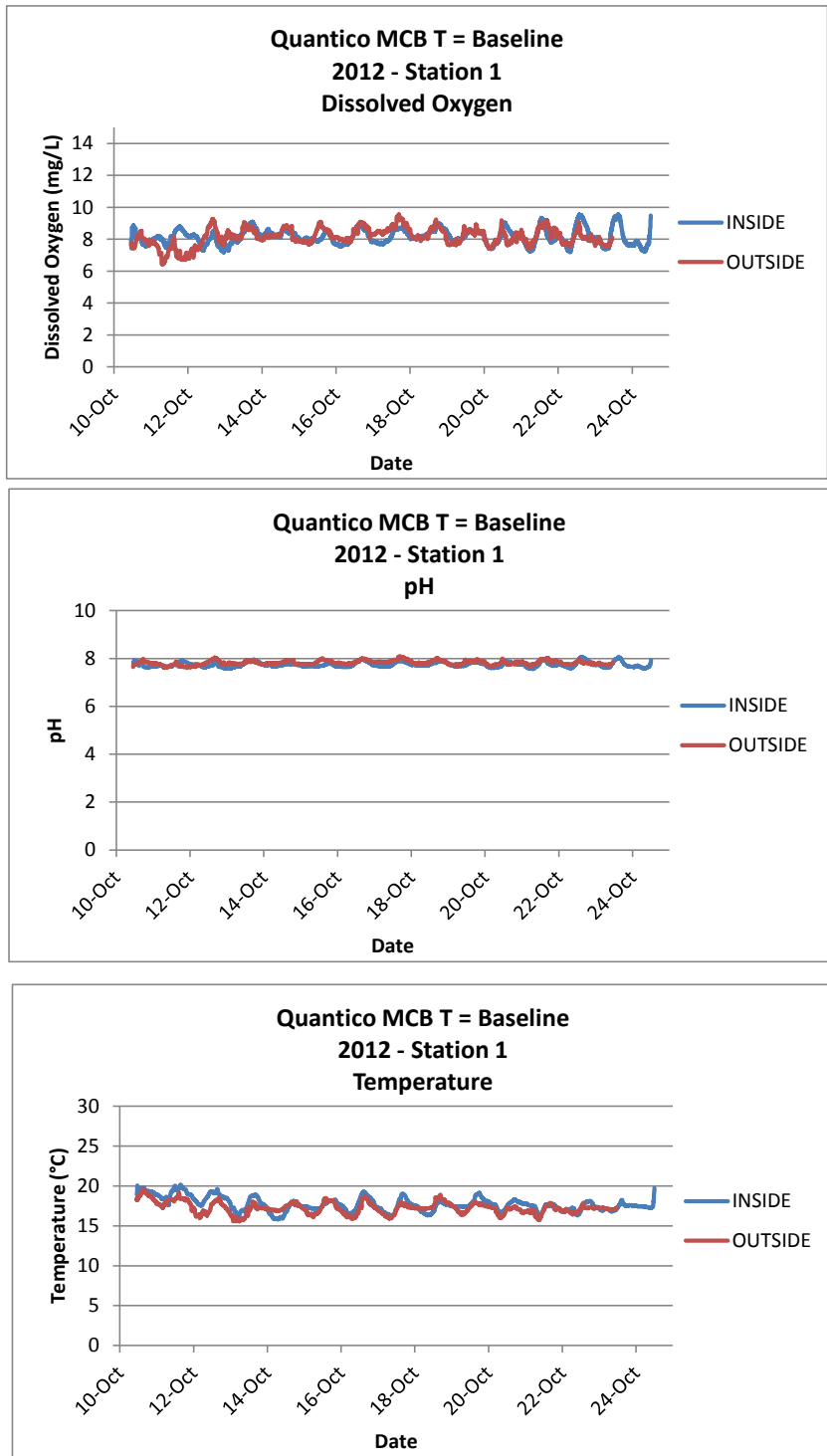

Figure D-1. For the 2012 Baseline event at MCB Quantico, Troll® 9500 rental units were incorporated into a flow cell on Version 2 SEA Rings at Stations 1 and 5. The Inside Troll® at Station 5 did not perform due to an air gap in the flow cell. The Outside (ambient) Troll® at Station 5 shut down 2 days into the deployment. Therefore, there are no logged water quality data for Station 5.

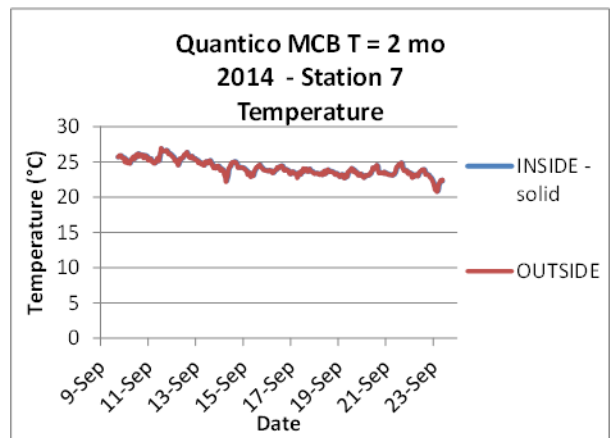
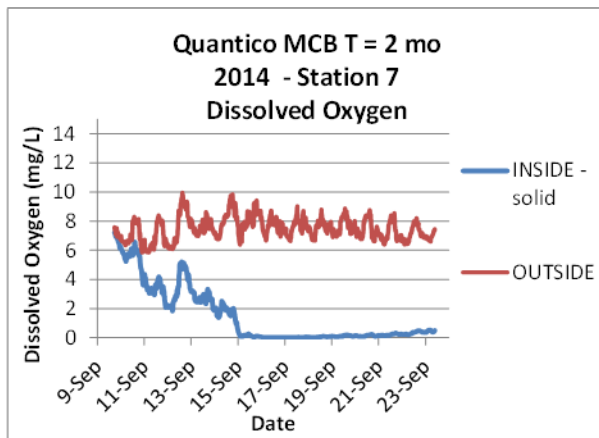
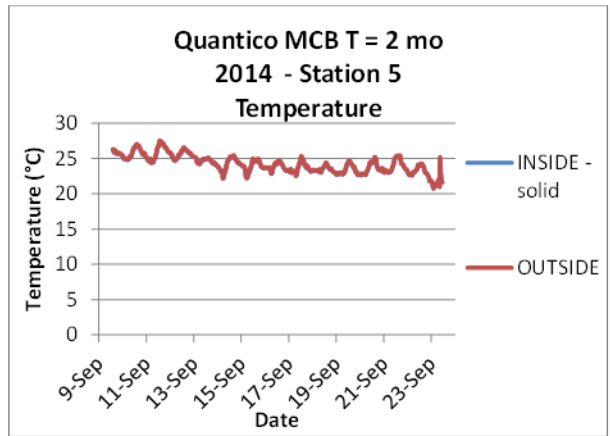
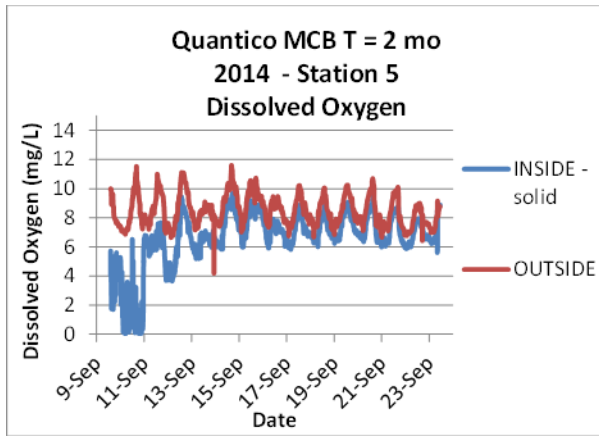

Figure D-2. For the 2014 (2-month post-remedy) monitoring, HOBO loggers were installed inside and outside SEA Rings at Stations 5 (on cap, coarse) and 7 (off cap, silt) during MCB Quantico 2-month post-remedy monitoring (2014) using Version 2 SEA Ring. Note: Worms were accidentally not released from syringes at Station 7, but it is expected that the decline in dissolved oxygen (DO) would have adversely impacted worm recovery at Station 7.

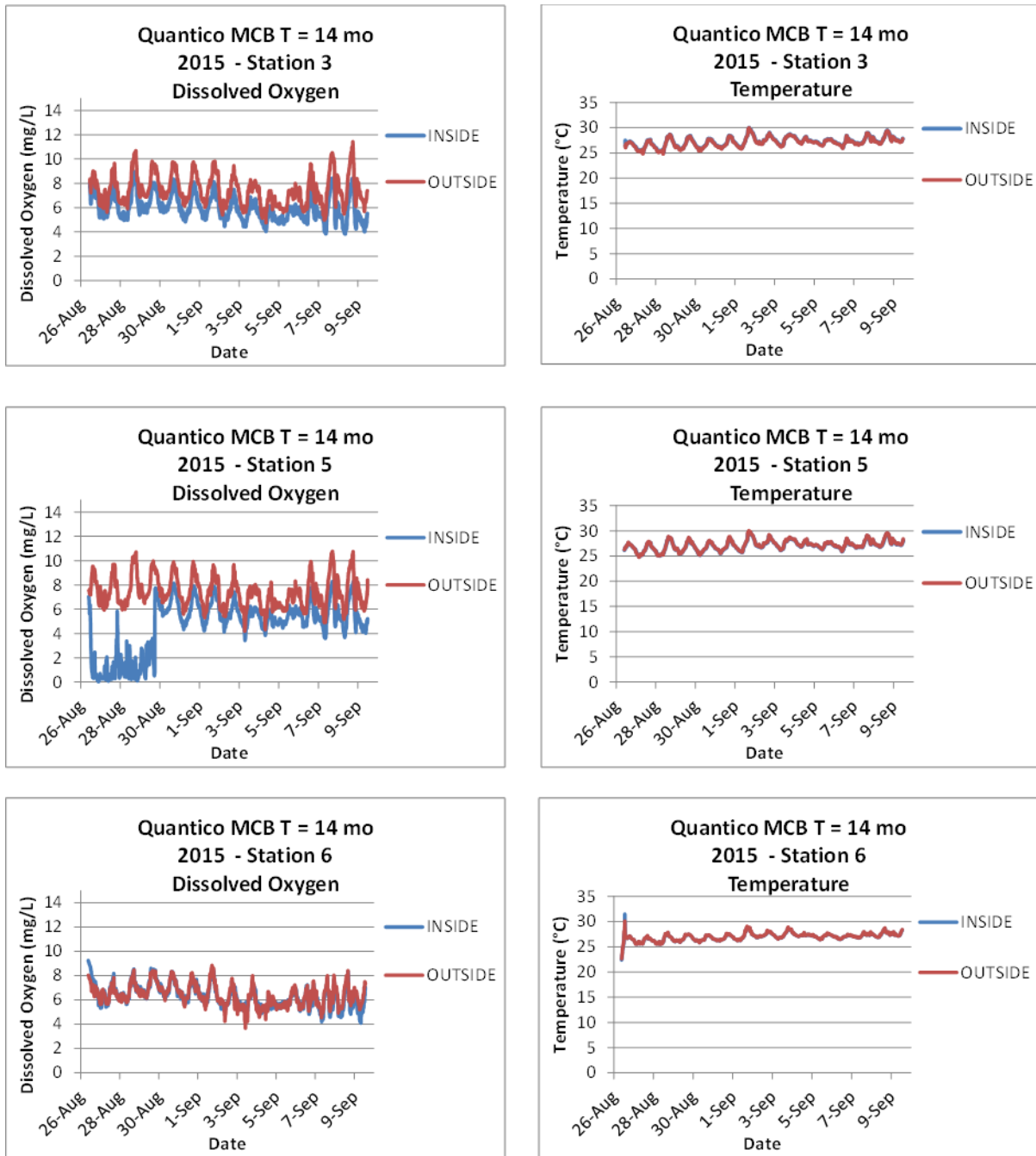

Figure D-3. For the 2015 (14-month post-remedy) event, HOBO loggers were placed inside and outside Version 3 SEA Rings at Stations 3 and 5 (on cap, coarse), and 6 (off cap, silt). The initial low DO readings at Station 5 inside the SEA Ring may have been associated with entrapment of the remainder of a blue-green algae (*Microcystis*) bloom that was observed at the site. All three Inside HOBOS were placed in clam chambers, all of which resulted in 100% clam recovery.

Table D-1. Sediment DDX concentrations and physical characteristics from top 7 cm of sediment at MCB Quantico for 2012 baseline event.

Quantico MCB 2012 Baseline - Sediment													
Station ID	4,4'-DDD (µg/Kg)	4,4'-DDE (µg/Kg)	4,4'-DDT (µg/Kg)	tDDX (µg/Kg)	TOC (mg/kg)	% TOC	tDDX (µg/Kg OC)	% Solids	% Gravel	% Sand	% Silt	% Clay	Sum Silt & Clay
Q1	527.0	27.0	9.4	563.4	12000	1.2	46953.3	75.7	0.1	92.5	7.7	-0.3	7.40
Q2	122.0	22.9	8.4	153.3	30000	3.0	5110.0	74.1	0.3	88.0	12.0	-0.3	11.70
Q3	216.0	48.3	6.5	270.8	67000	6.7	4041.0	69.5	0.1	77.8	20.3	1.8	22.10
Q4	134.0	30.1	3.6	167.7	82000	8.2	2044.8	41.0	0.1	33.2	56.2	10.5	66.70
Q5	124.0	37.3	4.4	165.7	73000	7.3	2269.6	38.4	0.0	23.6	65.9	10.5	76.40
Q6	9.8	3.1	0.9	13.8	8900	0.9	1550.6	50.4	6.8	44.8	39.6	8.8	48.40

Table D-2. Sediment DDX concentrations and physical characteristics from top 7 cm of sediment at MCB Quantico for 2014 event (T = 2-month post-remedy).

Quantico MCB 2014 - Sediment													
Station ID	4,4'-DDD (µg/Kg)	4,4'-DDE (µg/Kg)	4,4'-DDT (µg/Kg)	tDDX (µg/Kg)	TOC (mg/kg)	% TOC	tDDX (µg/Kg OC)	% Solids	% Gravel	% Sand	% Silt	% Clay	Sum Silt & Clay (0-7cm)
Q1	573.9	9.1	206.5	789.5	2900	0.3	272231.6	82.9	0.2	96.0	NR	NR	3.73
Q2	10.1	0.7	0.8	11.6	1667	0.2	6972.0	86.9	5.4	91.9	NR	NR	2.63
Q3	69.9	9.1	7.2	86.3	9333	0.9	9244.6	84.2	0.9	93.6	NR	NR	5.53
Q4	19.4	5.0	1.2	25.5	5533	0.6	4610.8	84.0	3.7	92.6	NR	NR	3.70
Q5	27.5	10.1	8.1	45.7	9200	0.9	4964.9	74.0	0.6	93.6	NR	NR	5.73
Q5-DUP	138.5	35.9	8.0	182.4	11167	1.1	16332.5	69.9	1.0	81.5	15.5	8.0	17.47
Q6	7.4	3.2	0.6	11.2	24000	2.4	467.1	75.6	2.2	51.5	38.0	8.3	46.30
Q7	10.4	6.41	1.35	18.2	35000	3.5	518.9	33.9	0	45.1	46.7	8.2	54.90

Table D-3. Sediment DDX concentrations and physical characteristics from top 7 cm of sediment at MCB Quantico for 2015 event (T = 14-moth post-remedy).

Quantico MCB 2015 - Sediment													
Station ID	4,4'-DDD (µg/Kg)	4,4'-DDE (µg/Kg)	4,4'-DDT (µg/Kg)	tDDX (µg/Kg)	TOC (mg/kg)	% TOC	tDDX (µg/Kg OC)	% Solids	% Gravel	% Sand	% Silt	% Clay	Sum Silt & Clay (0-7cm)
Q1	65.9	25.9	6.2	98.0	1020	0.1	96029.4	86.2	2.4	96.4	2.3	1.0	1.27
Q2	443.5	24.5	0.0	468.0	710	0.1	659169.0	86.1	1.7	96.8	1.2	0.3	1.50
Q3	521.0	87.5	0.0	608.5	5800	0.6	104913.8	78.4	1.0	88.6	12.2	1.7	10.40
Q4	14.5	3.8	0.0	18.3	3210	0.3	5713.4	85.8	3.3	95.5	1.1	0.5	1.20
Q5	4.9	2.1	0.0	7.0	2080	0.2	3346.2	84.3	0.9	97.8	1.4	0.4	1.37
Q5-DUP	9.8	3.3	0.0	13.1	2010	0.2	6512.4	85.1	0.2	98.1	1.7	0.4	1.70
Q6	9.0	5.7	ND	14.7	7500	0.8	1958.7	38.5	1.3	46.8	41.0	10.9	51.90
Q7	13.6	7.71	ND	21.3	8600	0.9	2477.9	36.7	0	16.5	81.1	2.4	83.50

*Sediment 0-7cm intervals are averaged

Table D-4. Composite and replicate DDX tissue concentration from laboratory bioassay with *Lumbriculus variegatus* for 2012 baseline study.

Quantico MCB 2012 Baseline - Lab Tissue Data - <i>Lumbriculus</i>																
Station ID	Composite Data						Station ID	Replicate Data								
	4,4'-DDD (µg/Kg)	4,4'-DDE (µg/Kg)	4,4'-DDT (µg/Kg)	tDDX (µg/Kg)	Lipids (% by weight)	tDDX/lipid (µg/Kg lipid)		4,4'-DDD (µg/Kg)	4,4'-DDE (µg/Kg)	4,4'-DDT (µg/Kg)	tDDX (µg/Kg)	Lipids (% by weight)	tDDX/lipid (µg/Kg lipid)	Mean DDX/lipid (µg/kg lipid)	StDev	CV
T0*	-	-	-	-	-	1519	T0-R1	35.00	1.66	ND	36.7	1.3	2820	-	-	-
							T0-R2	7.98	0.174	ND	8.2	1.8	453	-	-	-
							T0-R3	13.1	2.29	ND	15.4	1.2	1283	1519	1201	79.1
Q1	212.0	62.5	4.1	278.6	0.80	34829	Q1-R1	148	48.4	<0.036	196.4	0.8	24550	-	-	-
							Q1-R2	39.2	13.6	<0.041	52.8	0.9	5867	-	-	-
							Q1-R3	202	39.2	<0.042	241.2	1	24120	18179	10665	58.7
Q3	110.0	75.1	2.0	187.1	0.90	20793	Q3-R1	111	82.1	<0.044	193.1	0.7	27586	-	-	-
							Q3-R2	138	75.3	3.09	216.4	0.9	24043	-	-	-
							Q3-R3	37.5	25.5	0.745	63.7	1.0	6375	19335	11363	58.8
Q5	47.7	45.4	<0.022	93.1	0.80	11638	Q5-R1	45.9	44.4	2.17	92.5	0.7	13210	-	-	-
							Q5-R2	57	43.3	1.46	101.8	0.7	14537	-	-	-
							Q5-R3	47.9	54.9	1.97	104.8	1.1	9525	12424	2597	20.9
Q6	6.8	10.4	<0.022	17.2	0.60	2862	Q6-R1	6.35	10	<0.031	16.4	0.5	3270	-	-	-
							Q6-R2	6.61	10.7	<0.036	17.3	0.6	2885	-	-	-
							Q6-R3	6.39	10	<0.055	16.39	0.9	1821	2659	750	28.2

*Mean of Replicate data, composite sample not analyzed.

Table D-5. Composite and replicate DDX tissue concentration from laboratory bioassay with *Corbicula fluminea* for 2012 baseline study.

Quantico MCB 2012 Baseline - Lab Tissue Data - <i>Corbicula</i>																
Station ID	Composite Data						Station ID	Replicate Data								
	4,4'-DDD (µg/Kg)	4,4'-DDE (µg/Kg)	4,4'-DDT (µg/Kg)	tDDX (µg/Kg)	Lipids (% by weight)	tDDX/lipid (µg/Kg lipid)		4,4'-DDD (µg/Kg)	4,4'-DDE (µg/Kg)	4,4'-DDT (µg/Kg)	tDDX (µg/Kg)	Lipids (% by weight)	tDDX/lipid (µg/Kg lipid)	Mean DDX/lipid (µg/kg lipid)	StDev	CV
T0*	-	-	-	-	-	2439	T0-R1	22.30	0.71	ND	23.01	0.5	4601	-	-	-
							T0-R2	9.46	0.694	ND	10.15	0.4	2539	-	-	-
							T0-R3	1.14	0.103	ND	1.24	0.7	178	2439	2213	90.7
Q1	2.5	1.8	0.3	4.7	0.60	775	Q1-R1	4.98	2.62	0.501	8.10	0.8	1013	-	-	-
							Q1-R2	1.94	2.57	0.329	4.84	0.6	807	-	-	-
							Q1-R3	2.75	3.39	0.447	6.59	0.5	1317	1046	257	24.6
Q3	1.7	3.8	0.6	6.1	0.80	762	Q3-R1	2.44	6.27	0.721	9.43	0.6	1572	-	-	-
							Q3-R2	1.65	3.46	0.383	5.49	0.6	916	-	-	-
							Q3-R3	1.25	1.35	0.476	3.08	0.8	385	957	595	62.1
Q5	1.3	4.1	0.8	6.3	0.60	1043	Q5-R1	1.25	4.14	1.35	6.74	0.7	963	-	-	-
							Q5-R2	1.09	4.29	0.497	5.88	0.8	735	-	-	-
							Q5-R3	0.787	2.81	0.334	3.93	0.6	655	784	160	20.4
Q6	0.5	2.6	0.4	3.4	0.70	486	Q6-R1	0.771	4.94	0.64	6.35	0.8	794	-	-	-
							Q6-R2	0.643	3.94	0.579	5.16	0.6	860	-	-	-
							Q6-R3	0.809	4.2	0.572	5.58	0.50	1116	923	170	18.4

*Mean of Replicate data, composite sample not analyzed.

Table D-6. Composite and replicate DDX tissue concentration from SEA Ring (*in situ*) bioassay with *Lumbriculus variegatus* for 2012 baseline study.

Quantico MCB 2012 Baseline - Field Tissue Data - <i>Lumbriculus</i>																
Station ID	Composite Data						Station ID	Replicate Data								
	4,4'-DDD (µg/Kg)	4,4'-DDE (µg/Kg)	4,4'-DDT (µg/Kg)	tDDX (µg/Kg)	Lipids (% by weight)	tDDX/lipid (µg/Kg lipid)		4,4'-DDD (µg/Kg)	4,4'-DDE (µg/Kg)	4,4'-DDT (µg/Kg)	tDDX (µg/Kg)	Lipids (% by weight)	tDDX/lipid (µg/Kg lipid)	Mean DDx/lipid (µg/kg lipid)	StDev	CV
T0	-	-	-	-	-	-	T0-R1	35.00	1.66	ND	36.66	1.3	2820	-	-	-
							T0-R2	7.98	0.174	ND	8.15	1.8	453	-	-	-
							T0-R3	13.1	2.29	ND	15.39	1.2	1283	1519	1201	79.1
Q1*	-	-	-	78.24		22168	Q1-R1	42.7	15.6	0.375	58.68	0.5	11735	-	-	-
							Q1-R2	76.8	19.6	1.4	97.80	0.3	32600	22168	14754	66.6
Q2	20	10.5	<0.052	30.5	1	3050	Q2-R1	16.8	10.2	0.905	27.91	0.7	3986	-	-	-
							Q2-R2	29.5	11.5	0.999	42.00	0.6	7000	-	-	-
							Q2-R3	12.6	8.92	<0.150	21.52	1.0	2152	4379	2448	55.9
Q3	45.3	24.5	0.923	70.7	0.9	7858	Q3-R1	29.7	12.9	0.394	42.99	0.3	14331	-	-	-
							Q3-R2	28.5	19.6	0.735	48.84	1.0	4884	-	-	-
							Q3-R3	52.6	38.6	1.12	92.32	0.6	15387	11534	5783	50.1
Q4	13.9	16.8	0.44	31.1	0.8	3893	Q4-R1	14.2	17.5	0.623	32.32	1.1	2938	-	-	-
							Q4-R2	9.74	12.8	0.38	22.92	1.0	2292	-	-	-
							Q4-R3	9.4	13.1	0.415	22.92	0.8	2864	2698	354	13.1
Q5	16.7	14.9	0.466	32.1	0.5	6413	Q5-R1	23.2	20.1	0.893	44.19	0.9	4910	-	-	-
							Q5-R2	10.1	9.22	0.301	19.62	0.5	3924	4417	697	15.8
Q6	2.69	8.54	0.45	11.68	0.8	1460	Q6-R1	-	-	-	-	-	-	-	-	-

*Q1 mean replicate data used due to QC concerns

Table D-7. Composite and replicate DDX tissue concentration from SEA Ring (*in situ*) bioassay with *Corbicula fluminea* for 2012 baseline study.

Quantico MCB 2012 Baseline - Field Tissue Data - <i>Corbicula</i>																
Station ID	Composite Data						Station ID	Replicate Data								
	4,4'-DDD (µg/Kg)	4,4'-DDE (µg/Kg)	4,4'-DDT (µg/Kg)	tDDX (µg/Kg)	Lipids (% by weight)	tDDX/lipid (µg/Kg lipid)		4,4'-DDD (µg/Kg)	4,4'-DDE (µg/Kg)	4,4'-DDT (µg/Kg)	tDDX (µg/Kg)	Lipids (% by weight)	tDDX/lipid (µg/Kg lipid)	Mean DDX/lipid (µg/kg lipid)	StDev	CV
T0	-	-	-	-	-	-	T0-R1	22.30	0.71	ND	23.01	0.50	4601	-	-	-
							T0-R2	9.46	0.69	ND	10.15	0.40	2539	-	-	-
							T0-R3	1.14	0.10	ND	1.24	0.70	178	2439	2213	90.7
Q1*	-	-	-	20.62	-	2473	Q1-R1	14.60	7.30	1.57	23.47	0.70	3353	-	-	-
							Q1-R2	11.40	5.90	0.872	18.17	1.00	1817	-	-	-
							Q1-R3	12.50	6.65	1.08	20.23	0.90	2248	2473	792	32.0
Q2	16.50	11.60	2.25	30.35	1	3035	Q2-R1	14.30	10.30	2.43	27.03	1.00	2703	-	-	-
							Q2-R2	18.30	13.30	2.12	33.72	0.70	4817	-	-	-
							Q2-R3	14.10	10.40	1.57	26.07	0.80	3259	3593	1096	30.5
Q3	7.61	4.98	0.73	13.32	1	1332	Q3-R1	12.60	9.15	1.13	22.88	0.90	2542	-	-	-
							Q3-R2	12.60	9.22	1.19	23.01	0.80	2876	-	-	-
							Q3-R3	14.30	8.67	1.79	24.76	0.70	3537	2985	506	17.0
Q4	10.20	8.43	1.23	19.86	0.9	2207	Q4-R1	7.22	6.96	0.955	15.14	0.90	1682	-	-	-
							Q4-R2	4.65	4.27	3.48	12.40	0.80	1550	-	-	-
							Q4-R3	8.64	7.12	1.24	17.00	0.60	2833	2022	706	34.9
Q5	17.90	11.50	1.92	31.32	0.9	3480	Q5-R1	10.40	7.95	1.69	20.04	1.00	2004	-	-	-
							Q5-R2	6.91	5.30	0.786	13.00	1.20	1083	-	-	-
							Q5-R3	14.70	11.10	2.06	27.86	0.90	3096	2061	1007	48.9
Q6	5.36	6.99	1.51	13.86	1.1	1260	Q6-R1	5.48	7.18	1.46	14.12	0.90	1569	-	-	-
							Q6-R2	3.72	4.91	1.09	9.72	1.00	972	-	-	-
							Q6-R3	2.95	3.34	0.613	6.90	1.80	384	975	593	60.8

*Replicate data used for composite, error from ERDC, this sample not analyzed.

Table D-8. Composite DDX tissue concentrations from SEA Ring (*in situ*) bioassay with *Lumbriculus variegatus* for T = 2-month post-remedy (2014) monitoring.

Quantico MCB 2014 - Field Tissue Data - <i>Lumbriculus</i>										
Station ID		Composite Data								
		4,4'-DDD (µg/Kg)	4,4'-DDE (µg/Kg)	4,4'-DDT (µg/Kg)	tDDX (µg/Kg)	Lipids (% by weight)	tDDX/lipid (µg/Kg lipid)	Mean DDx/lipid (µg/kg lipid)	StDev	CV
Batch 1	T0-R1	0.17	0.47	<0.096	0.64	5.38	11.86	-	-	-
	T0-R2	0.14	0.58	0.26	0.98	3.79	25.73	-	-	-
	T0-R3	0.22	0.86	<0.098	1.08	2.82	38.19	25.26	13.17	52.15
Batch 2	T0-R1	0.24	1.20	<0.095	1.44	7.18	20.04	-	-	-
	T0-R2	0.17	0.90	<0.098	1.07	5.78	18.49	-	-	-
	T0-R3	<0.100	0.20	0.11	0.31	5.79	5.30	14.61	8.10	55.43
Q1		11.10	8.01	0.65	19.76	2.94	672.04	-	-	-
Q2		13.70	8.96	1.13	23.79	2.74	868.25	-	-	-
Q3		-	-	-	-	-	-	-	-	-
Q4		8.86	9.49	0.49	18.84	2.35	801.62	-	-	-
Q5		51.20	40.80	4.48	96.48	3.52	2740.91	-	-	-
Q5-DUP		54.60	40.00	3.33	97.93	3.29	2976.60	2858.75	166.66	5.83
Q6		8.82	10.40	1.78	21.00	2.62	801.53	-	-	-
Q7		6.51	8.94	0.55	16.00	2.34	683.89	-	-	-

Table D-9. Composite DDX tissue concentrations from SEA Ring (*in situ*) bioassay with *Corbicula fluminea* for T = 2-month post-remedy (2014) monitoring.

Quantico MCB 2014 - Field Tissue Data - Corbicula										
Station ID		Composite Data								
		4,4'-DDD (µg/Kg)	4,4'-DDE (µg/Kg)	4,4'-DDT (µg/Kg)	tDDX (µg/Kg)	Lipids (% by weight)	tDDX/lipi d (µg/Kg lipid)	Mean DDx/lipid (µg/kg lipid)	StDev	CV
Batch 1	T0-R1	0.34	0.23	0.37	0.94	2.05	45.76	-	-	-
	T0-R2	0.34	0.28	0.18	0.79	2.07	38.12	-	-	-
	T0-R3	0.18	0.34	0.39	0.91	1.86	48.66	44.18	5.44	12.33
Batch 2	T0-R1	0.17	0.39	0.20	0.75	1.45	51.72	-	-	-
	T0-R2	0.20	0.34	0.22	0.76	1.46	52.19	-	-	-
	T0-R3	0.17	0.31	<0.157	0.48	1.78	26.80	43.57	14.53	33.34
Q1		9.39	7.00	0.65	17.04	1.54	1106.23	-	-	-
Q2		8.51	6.68	0.58	15.77	1.46	1080.00	-	-	-
Q3		7.30	5.20	0.51	13.01	1.51	861.72	-	-	-
Q4		6.73	6.13	0.44	13.30	2.43	547.12	-	-	-
Q5		7.42	6.74	<0.094	14.16	1.35	1048.89	-	-	-
Q5-DUP		8.33	6.88	0.45	15.66	1.88	833.19	941.04	152.52	16.21
Q6		1.41	1.45	0.17	3.03	1.57	192.80	-	-	-
Q7		2.61	3.16	<0.100	5.77	1.44	400.69	-	-	-

Table D-10. Composite DDX tissue concentrations from SEA Ring (*in situ*) bioassay with *Lumbriculus variegatus* for T = 14-month post-remedy (2015) monitoring.

Quantico MCB 2015 - Field Tissue Data - <i>Lumbriculus</i>									
Station ID	Composite Data								
	4,4'-DDD (µg/Kg)	4,4'-DDE (µg/Kg)	4,4'-DDT (µg/Kg)	tDDX (µg/Kg)	Lipids (% by weight)	tDDX/lipi d (µg/Kg lipid)	Mean DDx/lipid (µg/kg lipid)	StDev	CV
T0-R1	<0.702	<0.702	<0.702	0.00	4.15	0.00	-	-	-
T0-R2	<0.666	<0.666	<0.666	0.00	4.11	0.00	-	-	-
T0-R3	<0.688	<0.688	<0.688	0.00	3.92	0.00	0.00	0.00	-
Q1	10.30	19.10	<1.07	29.40	1.74	1689.66	-	-	-
Q2	10.20	9.20	<1.17	19.40	1.43	1356.64	-	-	-
Q3	24.60	14.10	<0.699	38.70	2.62	1477.10	-	-	-
Q3-Dup	38.10	17.10	<0.705	55.20	1.11	4972.97	3225.04	2471.96	76.65
Q4	21.30	12.60	<0.692	33.90	2.06	1645.63	-	-	-
Q5	23.00	14.50	<0.702	37.50	1.97	1903.55	-	-	-
Q6	6.55	9.62	<0.599	16.17	1.87	864.71	-	-	-
Q7	2.59	6.86	<0.692	9.45	0.99	954.55	-	-	-

Table D-11. Composite DDX tissue concentrations from SEA Ring (*in situ*) bioassay with *Corbicula fluminea* for T = 14-month post-remedy (2015) monitoring.

Quantico MCB 2015 - Field Tissue Data - Corbicula									
Station ID	Composite Data								
	4,4'-DDD (µg/Kg)	4,4'-DDE (µg/Kg)	4,4'-DDT (µg/Kg)	tDDX (µg/Kg)	Lipids (% by weight)	tDDX/lipi d (µg/Kg lipid)	Mean DDx/lipid (µg/kg lipid)	StDev	CV
T0-R1	<0.692	5.31	<0.692	5.31	0.96	553.13	-	-	-
T0-R2	<0.575	<0.575	<0.575	0.00	0.96	0.00	-	-	-
T0-R3	<0.589	<0.589	<0.589	0.00	0.96	0.00	184.38	319.35	173.21
Q1	29.30	23.10	7.47	59.87	2.53	2366.40	-	-	-
Q2	6.26	7.75	1.82	15.83	3.30	479.70	-	-	-
Q3	38.40	18.90	9.57	66.87	2.94	2274.49	-	-	-
Q3-Dup	34.30	22.40	8.68	65.38	2.78	2351.80	2313.14	54.67	2.36
Q4	11.30	8.71	<0.672	20.01	2.63	760.84	-	-	-
Q5	29.80	24.10	5.00	58.90	2.93	2010.24	-	-	-
Q6	12.10	20.20	<0.669	32.30	2.38	1357.14	-	-	-
Q7	12.70	13.50	<0.645	26.20	2.70	970.37	-	-	-

METHOD SUMMARY FOR *IN SITU* SPME

APPROACH

Solid phase microextraction (SPME) fibers consist of a sorbent polymer layer (polydimethylsiloxane or PDMS) surrounding a glass core. SPMEs were deployed into the sediment inside perforated stainless steel PushPoint sampling devices. Rapid uptake of hydrophobic compounds in the PDMS of the SPME fiber occurs without interference of colloiddally bound compounds, and provides an improved measure of dissolved hydrophobic organic contaminant (HOC) concentrations, such as organochlorine pesticides, in the porewater. Porewater measurements provide a direct measure of bioavailable contaminants in sediment.

SPMEs were deployed in the sediment for 14 days for each deployment. This is not sufficient for contaminants to achieve steady-state concentrations between porewater and PDMS. Therefore, performance reference compounds (PRCs) were used to evaluate fiber uptake kinetics. Four deuterated polycyclic aromatic (PAHs) covering a range of hydrophobicities were selected as PRCs (fluoranthene-d10, benzo(b)fluoranthene-d12, and dibenz(a,h)anthracene-d14, and chrysene-d12). The deuterated PAHs were selected as PRCs based on their lack of interference with their non-deuterated counterparts during analysis and their hydrophobicities mirrored the range of hydrophobicities in the target compounds. Fibers were placed in contact with a spiking solution with final aqueous concentrations of 30- $\mu\text{g/L}$ fluoranthene-d10, 80- $\mu\text{g/L}$ chrysene-d12, 50- $\mu\text{g/L}$ benzo(b)fluoranthene-d12, and 25- $\mu\text{g/L}$ dibenz(a,h)anthracene-d14 for seven days.

For ease of insertion and protection from sand and gravel in the sediments by EPA divers, the fibers were secured in modified Henry samplers using a waterproof caulk. The samplers were washed with hot water and detergent, soaked sequentially in hexane and acetonitrile, flushed with deionized water, and dried at 180 °C overnight.

Upon removal from the sediment by EPA divers, the SPME PDMS fibers were wiped with a deionized water dampened lint-free tissue to remove any particulate matter. The fibers were shipped from the site to University of Texas at Austin, where the fibers were then sectioned into intervals and placed in an autosampler vial containing hexane for extraction.

PAH analysis was performed by University of Texas at Austin using Waters 2795 High Performance Liquid Chromatography (HPLC) with ultraviolet-diode array (UV) and fluorescence (FLD) detectors or using an Agilent Technologies 1260 Infinity (Santa Clara, CA, USA) High Performance Liquid Chromatography (HPLC) with an ultraviolet-diode array (1260 DAD VL+) and fluorescence detector (1260 FLD Spectra) according to EPA Method 8310 for PAH₁₆ analysis.

DDX analysis was performed at Engineer Research and Development Center (ERDC) by EPA 8081A (fused silica, open-tubular, capillary collar columns with electron capture detectors [ECD]). These results were corrected for non-equilibrium conditions based on the f_{ss} (the fraction of steady state achieved during the deployment period) for PAH PRCs. Concentrations in porewater were calculated with K_{PDMS} (PDMS polymer partition coefficients) based on Mayer et al. (2000).

BASELINE (2012)

In the baseline, October 2012, *in situ* SPME passive samplers (a 1000- μm glass core fiber coated with a 30.5- μm PDMS layer in a 1-foot PushPoint sampler) were diver-deployed in surface sediments at the MCB Quantico site. One SPME fiber with PAH PRCs and one SPME fiber without was deployed at six locations (co-located with SEA Rings). Space and Naval Warfare Systems Center Pacific (SSC Pacific) deployed and retrieved the samplers under the guidance of the Professor Danny Reible's lab at University of Texas at Austin. Courtney Thomas, University of Texas at Austin, received the samplers from SSC Pacific and processed the samplers into 4- to 6-cm intervals (in reference to cm below the sediment-water interface) and extracted in hexane. The hexane extracts were received by ERDC laboratory in Vicksburg, MS. Results were reported as the primary column results because ERDC mistakenly reported both the primary and secondary column results. Three analytes were reported: 4,4'DDD, 4,4'DDE, and 4,4'DDT. All other intervals of the SPME fiber were analyzed at the University of Texas at Austin for PAHs, PRCs, and priority 16 PAHs for all intervals with the exception of the 4–6 cm interval.

2- AND 14-MONTH EVENTS (2014 AND 2015)

Each 2-foot sampler contained a 486- μm glass core fiber coated with a 36.4- μm PDMS layer. In September 2014 and 2015, *in situ* SPME passive samplers were diver-deployed in surface sediments at the Quantico site. Two fibers were co-located with the SEA Rings at seven stations.

In 2014, nine 5-cm intervals were analyzed by ERDC for DDX (report dated March 17, 2015). The 5-cm segments were: 0–5, 10–15, 15–20, 25–30, 30–35, 35–40, 40–45, 50–55 cm, and 55 cm-end (approximately 60 cm; intervals are in reference to depth below sediment-water interface). All other intervals (5-10 cm, 20-25 cm, and 45-50c m) were analyzed at the University of Texas at Austin for PAH PRCs. After analysis for PAHs, these hexane extracts for all other intervals were analyzed by ERDC for DDX (report dated March 18, 2015).

In 2015, 5-cm intervals (in reference to depth below sediment-water interface) were sectioned based on the samples analyzed for *ex situ* passive sampling (sampling intervals were based on the cap depth). In 2015, the fraction to steady state was not provided and was assumed to be the same as 2014.

APPENDIX E
TEST CONDITIONS AND QA/QC FOR BIOASSAYS

Table E-1. *Lumbriculus variegatus* and *Corbicula fluminea* bioaccumulation test specifications.

Test period	10/15/2012 –10/29/2012
Test endpoints	14-day bioaccumulation
Test organisms	<i>Lumbriculus variegatus</i> (aquatic oligochaete) <i>Corbicula fluminea</i> (bent nosed clam)
Test organism sources	California Blackworm Co., CA (<i>Lumbriculus</i>) Dr. Harriette Phelps (<i>Corbicula</i>)
Test organism acclimation	All organisms to be held on Perrier®/DI mix (3:7 ratio Perrier:DI) at temperature of site water with aeration. Use hardness strips to test hardness of water, try to approximately 140 mg/L.
Test organism age at initiation	NA
Overlying water renewal	Daily
Feeding	None
Test chamber	1-L core tube
Test sediment volume	Approximately 400 mL (100g)
Test overlying water volume	500 mL
Test temperature	23 ±1 °C
Test aeration	Approximately 100 bubbles per minute
Overlying water for test exposure period	De-chlorinated Ann Arbor City water, passed through carbon filter
Number of organisms/chamber	<i>Lumbriculus</i> : At minimum 3.0-g wet weight <i>Corbicula</i> : 10 individuals
Number of replicates	<i>Lumbriculus</i> : 5 <i>Corbicula</i> : 4
Photoperiod	Ambient light, 16 hours light/8 hours dark
Test Protocol	ASTM, 2000; ASTM, 2010 (modified)

Table E-2. Bivalve embryo-larval development test specifications.

Test period	2/27/2014 – 3/1/2014 3/1/2014 – 3/3/2014
Test endpoints	Embryo development rate (proportion normal)
Test organism	<i>Mytilus galloprovincialis</i> (Mediterranean mussel)
Test organism source	Carlsbad Aquafarms, Carlsbad, CA
Test solution renewal	None
Feeding	None
Test chamber	20-mL scintillation vial
Test solution volume	10 mL
Test temperature	15 ±1 °C
Control/ Dilution water	Natural seawater (Source: San Diego Bay)
Additional control	Artificial salt (Crystal Sea Marine Mix [®])
Sample manipulation	Sample salinity was increased to 30 ±2 ppt by the addition of artificial salts (Crystal Sea Marine Mix [®])
Test concentrations (% of sample)	100%, plus lab and salt controls
Number of organisms/chamber	200 eggs, appropriate sperm density to provide > 95% fertilization success (determined in a pre-test trial)
Number of replicates	5
Photoperiod	16 hours light/8 hours dark
Test Protocol	EPA 600/R-95/136, USEPA (1995)
Test acceptability criteria for controls	≥ 50% survival, ≥ 90% normal shell development, < 25% Minimum Significant Difference (MSD)
Reference toxicant	Copper sulfate

Table E-3. Mysid shrimp acute survival toxicity test specifications.

Test period	3/1/2014 – 3/5/2014
Test endpoints	96-hour survival
Test organism	<i>Americamysis bahia</i> (mysid shrimp)
Test organism source	Aquatic BioSystems; Fort Collins, CO
Test organism age at initiation	6 days
Test solution renewal	Once at 48 hours
Feeding	<i>Artemia</i> nauplii during holding time and two times daily
Test chamber	400-mL plastic cup
Test solution volume	200 mL
Test temperature	20 ±1 °C
Control/ Dilution water	Natural seawater (source: San Diego Bay)
Additional control	Artificial salt (Crystal Sea Marine Mix [®])
Sample manipulation	Sample salinity was increased to 30 ±2 ppt by the addition of artificial salts (Crystal Sea Marine Mix [®])
Test concentrations (% of sample)	100%, plus lab and salt controls
Number of organisms/chamber	5
Number of replicates	4
Photoperiod	16 hours light/8 hours dark
Test Protocol	EPA 821/R-02/012
Test acceptability criteria for controls	≥ 90% survival
Reference toxicant	Copper sulfate

Table E-4. *Neanthes* acute survival toxicity test specifications.

Test period	3/1/2014 – 3/5/2014
Test endpoints	96-hour survival
Test organism	<i>Neanthes arenaceodentata</i>
Test organism source	Aquatic Toxicology Support, Bremerton, WA
Test organism age at initiation	6 weeks
Test solution renewal	None
Feeding	None
Test chamber	Sample exposure: 400-mL plastic cup Post exposure feeding: 20-mL scintillation vial
Test solution volume	Sample exposure: 200 mL Post-exposure feeding: 10 mL
Test temperature	20 ±1 °C
Control/ Dilution water	Natural seawater (source: San Diego Bay)
Additional control	Artificial salt (Crystal Sea Marine Mix®)
Sample manipulation	Sample salinity was increased to 30 ±2 ppt by the addition of artificial salts (Crystal Sea Marine Mix®)
Test concentrations (% of sample)	100%, plus lab and salt controls
Number of organisms/chamber	10
Number of replicates	2
Photoperiod	Sample exposure: 16 hours light/8 hours dark
Test Protocol	Modified from Rosen and Miller (2011)
Test acceptability criteria for controls	Sample exposure: ≥ 90% survival Post exposure feeding: 70 nauplii consumed in 1 hour in controls
Reference toxicant	Copper sulfate

Appendix E-5. Giant kelp germination and growth toxicity test specifications as tested at Nautilus Environmental, LLC.

Test period	3/1/2014 – 3/3/2014
Test endpoints	Kelp spore germination and growth
Test organism	<i>Macrocystis pyrifera</i> (giant kelp)
Test organism source	Field Collected, San Diego, CA
Test solution renewal	None
Feeding	None
Test chamber	50-mL glass Petri dish
Test solution volume	30 mL
Test temperature	15 ±1 °C
Control/ Dilution water	Natural seawater (Source: SIO, La Jolla; 0.2-µm filtered)
Test concentrations (% of sample)	100%, plus lab and salt controls
Number of organisms/chamber	225,000 spores
Number of replicates	5
Photoperiod	16 hours light/8 hours dark
Test Protocol	EPA 600/R-95/136, 1995 West Coast Manual
Test acceptability criteria for controls	≥ 70% germination, ≥ 10-µm tube length
Reference toxicant	Copper chloride

Table E-6. Summary of bioaccumulation test methodology and qa/qc requirements for psns bioaccumulation tests.

Test Conditions: <i>Nephtys caecoides</i> and <i>Macoma nasuta</i>	
Sample Identification	
Sample storage conditions	4 °C, dark
Recommended sediment holding time: 14 days	
Maximum sediment holding time: ≤8 weeks (56 days)	
Source of control sediment	Discovery Bay, WA
Polychaete Test Species	<i>Nephtys caecoides</i>
Supplier	John Brezina & Associates, Dillon Beach, CA
Age class	Adult
Mollusk Test Species	<i>Macoma nasuta</i>
Supplier	J & G Gustone, Discovery Bay, WA
Age class	Adult
Test Procedures	Inland Testing Manual, USEPA/USACE, 1998 (ITM)
Test location	NewFields, Port Gamble, WA
Test type/duration	14-Day/Flow-through
Control water	Sand-filtered, North Hood Canal seawater
Test dissolved oxygen	Recommended: > 5.1 mg/L 60% Sat. at 14 °C, 30 ppt
Test temperature	Recommended: 14 ±2 °C
Test salinity	Recommended: 30 ±2 ppt (Range: 25–35 ppt)
Test pH	Recommended: 7–9
Control performance standard	Recommended: ≥ 75% survival
Test Lighting	16 hours light: 8 hours dark
Test chamber	1-L core chamber (11" H x 2 5/8" ID)
Replicates/treatment	5
Concentration/treatment	Not applicable
Organisms/replicate	10 <i>N. caecoides</i> , 5 <i>M. nasuta</i>
Exposure volume	0.5 L sediment (4–5")/0.5L overlying seawater from Port Gamble, WA
Feeding	None
Water renewal (Flow-through)	Recommended: 6 volumes/day minimum 111 L/day

Notes:

≥ = greater than or equal to
ppt = parts per thousand
cm = centimeter

L/day = liters per day
mg/L = milligrams per liter
°C = degrees Celsius

**APPENDIX F
STANDARD OPERATING PROCEDURES
FOR DGTS IN SEAWATER**

F1. OBJECTIVE

Diffusive Gradients in Thin Films (DGTs) consist of a plastic molded base (2.5-cm diameter) and a plastic top with a 2-cm-diameter window that allows for exposure to a layered setup of a polyethersulphone filter membrane, 0.8-mm-thick polyacrylamide diffusive gel and Chelex[®] binding resin gel. When deployed, either in solution or into sediments, metal ions diffuse through the filter membrane and diffusive gel and bind to the resin gel, which will continue to accumulate ions over the course of a deployment. In water applications, the DGT measures the labile concentration (bioavailable fraction), whereas in sediment applications the DGT measures the mean flux of labile metals at the interface between the device and the sediment, or the labile porewater concentrations.

F2. METHODS

DGTs were stored in sealed, clean plastic bags at 4 °C prior to deployment. Each bag contained a few drops of 0.01M NaNO₃ solution and was maintained moist throughout storage periods. DGTs were transported to the field site in coolers with Blue Ice[®] to maintain temperature. Just prior to deployment, DGTs were removed from individual bags and placed within a specified exposure chamber on each SEA Ring. Exposure chambers were immediately secured to the SEA Ring unit and deployed to reduce exposure to ambient air. DGTs were deployed for 48 hours. The time of each individual DGT deployment and recover was recorded to the minute for future analysis. Additionally, temperature data loggers were deployed concurrently to measure average temperature during the DGT deployment.

Upon recovery of the DGTs, each DGT was rinsed thoroughly with deionized water from a wash-bottle and excess water was shaken off. Each DGT was placed in a labeled and clean plastic bag with minimal airspace and stored at 4 °C until processed for analysis. DGTs were disassembled and the Chelex resin gels were removed and placed in clean micro-centrifuge tubes and were acidified with 0.5 ml of 1M HNO₃. An aliquot of the solution was then diluted with pH 2 Milli-Q water and analyzed. Analysis was conducted at Space and naval Warfare Systems Center Pacific using USEPA method 1640 with a Perkin-Elmer SCIEX[™] ELAN DRC II inductively coupled plasma with detection by mass spectrometry (ICP-MS; USEPA, 1996).

F3. CALCULATION OF DGT MEASURED CONCENTRATION

The mass of the metal accumulated in the resin gel layer (*M*) is calculated using equation (1):

$$M = C_e (V_{\text{HNO}_3} + V_{\text{gel}}) / fe, \quad (1)$$

where *C_e* is the concentration of metals in the 1-M HNO₃ elution solution (in µg/l), *V_{HNO₃}* is the volume of HNO₃ added to the resin gel, *V_{gel}* is the volume of the resin gel, typically 0.15 ml, and *fe* is the elution factor for each metal, typically 0.8.

The concentration of metal measured by DGT (*C_{DGT}*) can be calculated using Equation (2).

$$C_{\text{DGT}} = M \Delta g / (D t A), \quad (2)$$

where *Δg* is the thickness of the diffusive gel (0.8 mm) plus the thickness of the filter membrane (typically 0.14 mm), *D* is the diffusion coefficient of metal in the gel (see Table 1), *t* is deployment time, and *A* is the exposure area (*A* = 3.14 cm²).

F4. QUALITY CONTROL/QUALITY ASSURANCE

To ensure quality assurance of samples being processed, quality controls samples should consist of the following:

1. **Bottle Blank** – Extraction fluid only, no DGT resin gel, run through the complete extraction process. Analyze once per batch of bottles used or at a frequency of 1 in 20 samples.
2. **Blank Spike** – Extraction fluid spiked to approximately 10 mg/L with reference metal solution (copper, lead or other metal), and run through the complete extraction process. Analyze at a frequency of 1 in 20 samples.
3. **Duplicate Sample** – Repeat a sample extraction every 10 samples.

REFERENCES

<http://www.dgtresearch.com/dgtresearch/dgtresearch.pdf>

USEPA. 1996. “Method 1640: Determination of Trace Metal Elements in Ambient Waters by On-Line Chelation Preconcentration and Inductive Coupled Plasma-Mass Spectrometry.” U.S. Environmental Protection Agency, Office of Water, Engineering and Analysis Division, Washington, D.C.

Table 1. Diffusion coefficients of metal ions in the DGT gel (15% acrylamide and 0.3% cross-linker) at different temperatures from 1 to 35 °C.

°C	As	Ag	Al	Cd	Cr	Cu	Fe	Mn	Ni	Pb	Zn
1		6.58	2.22	2.84	2.36	2.91	2.85	2.73	2.69	3.75	2.84
2		6.83	2.3	2.95	2.45	3.02	2.96	2.83	2.8	3.89	2.94
3		7.09	2.39	3.06	2.54	3.13	3.07	2.94	2.9	4.04	3.05
4		7.35	2.48	3.18	2.63	3.25	3.18	3.05	3.01	4.19	3.17
5		7.62	2.57	3.29	2.73	3.36	3.3	3.16	3.12	4.34	3.28
6		7.89	2.66	3.41	2.82	3.48	3.42	3.27	3.23	4.49	3.4
7		8.17	2.75	3.53	2.92	3.61	3.54	3.39	3.34	4.65	3.52
8		8.45	2.85	3.65	3.02	3.73	3.66	3.5	3.46	4.81	3.64
9		8.74	2.94	3.78	3.13	3.86	3.79	3.62	3.58	4.98	3.77
10		9.04	3.04	3.9	3.23	3.99	3.91	3.74	3.7	5.14	3.89
11		9.34	3.14	4.03	3.34	4.12	4.04	3.87	3.82	5.31	4.02
12		9.64	3.25	4.16	3.45	4.26	4.18	4	3.94	5.49	4.15
13		9.95	3.35	4.3	3.56	4.39	4.31	4.12	4.07	5.67	4.29
14		10.27	3.46	4.43	3.67	4.53	4.45	4.26	4.2	5.85	4.42
15		10.59	3.57	4.57	3.79	4.68	4.59	4.39	4.33	6.03	4.56
16		10.92	3.68	4.72	3.91	4.82	4.73	4.52	4.47	6.21	4.7
17		11.25	3.79	4.86	4.03	4.97	4.87	4.66	4.6	6.4	4.85
18		11.59	3.9	5.01	4.15	5.12	5.02	4.8	4.74	6.6	4.99
19		11.93	4.02	5.15	4.27	5.27	5.17	4.95	4.88	6.79	5.14
20		12.28	4.14	5.3	4.39	5.42	5.32	5.09	5.02	6.99	5.29
21		12.64	4.26	5.46	4.52	5.58	5.47	5.24	5.17	7.19	5.44
22		13	4.38	5.61	4.65	5.74	5.63	5.39	5.32	7.4	5.6
23		13.36	4.5	5.77	4.78	5.9	5.79	5.54	5.47	7.61	5.76
24		13.73	4.62	5.93	4.91	6.06	5.95	5.69	5.62	7.82	5.92

Table 1. Diffusion coefficients of metal ions in the DGT gel (15% acrylamide and 0.3% cross-linker) at different temperatures from 1 to 35 °C. (Continued)

25		14.11	4.75	6.09	5.05	6.23	6.11	5.85	5.77	8.03	6.08
26		14.49	4.88	6.26	5.19	6.4	6.28	6.01	5.93	8.25	6.24
27		14.88	5.01	6.43	5.32	6.57	6.45	6.17	6.09	8.47	6.41
28		15.27	5.14	6.6	5.47	6.74	6.62	6.33	6.25	8.69	6.58
29		15.67	5.28	6.77	5.61	6.92	6.79	6.5	6.41	8.92	6.75
30		16.08	5.41	6.94	5.75	7.1	6.96	6.66	6.58	9.15	6.92
31		16.49	5.55	7.12	5.9	7.28	7.14	6.83	6.74	9.39	7.1
32		16.9	5.69	7.3	6.05	7.46	7.32	7	6.91	9.62	7.28
33		17.32	5.83	7.48	6.2	7.65	7.5	7.18	7.09	9.86	7.46
34		17.75	5.98	7.67	6.35	7.84	7.69	7.36	7.26	10.1	7.64
35		18.18	6.12	7.85	6.51	8.03	7.87	7.53	7.44	10.35	7.83

**APPENDIX G.
NAVAL BASE SAN DIEGO DATA TABLES**

Table G-1. NBSD Stormwater grab sample collection dates and times for laboratory bioassays and chemistry.

Grab #	Site ID										
	CC1 – Top	CC1 – Bottom	CC2 – Top	CC2 – Bottom	OF13 – Near – Top	OF13 – Near – Bottom	OF13 – Mid – Top	OF13 – Far – Top	SPAWA R PIER	OF13 – Storm Water	OF14 – Storm Water
Pre-Storm	2/27/2014 11:25	NC	2/27/2014 13:30	NC	2/27/2014	NC	NC	NC	2/27/2014	NC	NC
1	2/28/2014 07:55	2/28/2014 08:20	2/28/2014 08:45	2/28/2014 08:45	2/28/2014 06:50	2/28/2014 06:58	2/28/2014 06:44	2/28/2014 07:40	2/28/2014 07:00	2/28/2014 17:30	2/28/2014 04:50
2	2/28/2014 10:45	2/28/2014 10:50	2/28/2014 11:00	2/28/2014 11:10	2/28/2014 10:00	2/28/2014 10:05	2/28/2014 10:07	2/28/2014 10:25	2/28/2014 09:00	NC	2/28/2014 14:00
3	2/28/2014 12:10	2/28/2014 12:15	2/28/2014 11:45	2/28/2014 11:50	2/28/2014 11:26	2/28/2014 11:30	2/28/2014 11:45	2/28/2014 11:55	2/28/2014 11:00	NC	NC
4	2/28/2014 14:45	2/28/2014 14:50	2/28/2014 15:05	2/28/2014 15:10	2/28/2014 14:00	2/28/2014 14:00	2/28/2014 14:20	2/28/2014 14:45	2/28/2014 13:10	NC	NC
5	2/28/2014 15:45	2/28/2014 15:50	2/28/2014 16:10	2/28/2014 16:15	2/28/2014 15:00	2/28/2014 15:00	2/28/2014 15:20	2/28/2014 15:40	2/28/2014 15:40	NC	NC
6	2/28/2014 16:25	2/28/2014 16:30	2/28/2014 16:45	2/28/2014 16:50	2/28/2014 15:50	2/28/2014 15:50	2/28/2014 16:10	2/28/2014 16:25	2/28/2014 17:00	NC	NC
7	3/1/2014 07:03	3/1/2014 07:03	3/1/2014 07:35	3/1/2014 07:35	3/1/2014 06:20	3/1/2014 06:25	3/1/2014 06:30	3/1/2014 06:35	3/1/2014 06:30	NC	NC
8	3/1/2014 08:30	3/1/2014 08:30	3/1/2014 09:00	3/1/2014 09:00	3/1/2014 07:55	3/1/2014 07:55	3/1/2014 08:05	3/1/2014 08:10	3/1/2014 08:00	NC	NC

NC – Not collected. NR – Not recorded.

Table G-2. Analytical results (Weck Labs) for discrete grab samples collected to support NBSD stormwater demonstration.

Sample ID	Dissolved Cu			Dissolved Zinc			TSS			DOC			PAHs		
	Result (ug/l)	MDL	MRL	Result (ug/l)	MDL	MRL	Result (mg/l)	MDL	MRL	Result (mg/l)	MDL	MRL	Result (ug/l)	MDL	MRL
CC1-T-Pre	4.4	0.0038	0.03	27	0.036	0.5	ND	5	5	2.4	0.016	0.1	ND	0.1	0.1
CC2-T-Pre	4.3	0.0038	0.03	21	0.036	0.5	5	5	5	1.5	0.016	0.1	ND	0.1	0.1
OF14N-T-Pre	4.8	0.0038	0.03	18	0.036	0.5	7	5	5	1.3	0.016	0.1	ND	0.1	0.1
REF-T-Pre	3.2	0.0038	0.03	14	0.036	0.5	7	5	5	1.1	0.016	0.1	ND	0.1	0.1
CC1-T-G1	11	0.0038	0.03	40	0.036	0.5	6	5	5	-	-	-	-	-	-
CC1-B-G1	5	0.0038	0.03	19	0.036	0.5	8	5	5	-	-	-	-	-	-
CC2-T-G1	4	0.0038	0.03	14	0.036	0.5	8	5	5	-	-	-	-	-	-
CC2-B-G1	3.9	0.0038	0.03	14	0.036	0.5	6	5	5	-	-	-	-	-	-
OF14-SW-S	2.1	0.0038	0.03	21	0.036	0.5	130	5	5	-	-	-	-	-	-
OF14N-T-G1	5.2	0.0038	0.03	18	0.036	0.5	18	5	5	-	-	-	-	-	-
OF14N-B-G1	4.7	0.0038	0.03	15	0.036	0.5	8	5	5	-	-	-	-	-	-
OF14M-T-G1	5.9	0.0038	0.03	21	0.036	0.5	7	5	5	-	-	-	-	-	-
OF14F-T-G1	3.8	0.0038	0.03	14	0.036	0.5	7	5	5	-	-	-	-	-	-
REF-T-G1	2	0.0038	0.03	7.6	0.036	0.5	7	5	5	-	-	-	-	-	-
CC1-T-Comp	5.1	0.0038	0.03	32	0.036	0.5	29	5	5	3.9	0.016	0.1	ND	0.1	0.1
CC1-B-Comp	3.8	0.0038	0.03	22	0.036	0.5	14	5	5	1.5	0.016	0.1	ND	0.1	0.1
CC2-T-Comp	4.1	0.0038	0.03	25	0.036	0.5	21	5	5	2.8	0.016	0.1	ND	0.1	0.1
CC2-B-Comp	3.7	0.0038	0.03	18	0.036	0.5	15	5	5	1.5	0.016	0.1	ND	0.1	0.1
OF14N-T-Comp	4.7	0.0038	0.03	19	0.036	0.5	14	5	5	1.4	0.016	0.1	ND	0.1	0.1
OF14N-B-Comp	4.3	0.0038	0.03	17	0.036	0.5	18	5	5	1.4	0.016	0.1	ND	0.1	0.1
OF14M Comp	5.4	0.0038	0.03	20	0.036	0.5	13	5	5	1.5	0.016	0.1	ND	0.1	0.1
OF14M Comp Dup	3.8	0.0038	0.03	16	0.036	0.5	10	5	5	1.3	0.016	0.1	ND	0.1	0.1
OF14F Comp	3.8	0.0038	0.03	15	0.036	0.5	7	5	5	1.3	0.016	0.1	ND	0.1	0.1
REF Comp	1.9	0.0038	0.03	10	0.036	0.5	9	5	5	1.2	0.016	0.1	ND	0.1	0.1

Pre = Pre-storm sample

G= Grab sample

Comp = Composite sample

Table G-3. Metals data from SEA Ring DGT exposures and dissolved concentrations from composite samples (8 grabs over 24-hourr period).

Station ID	Location	DGT data				WECK data - Dissolved			
		Cu (µg/L)	Zn (µg/L)	Ni (µg/L)	Pb (µg/L)	Cu (µg/L)	Zn (µg/L)	DOC (mg/L)	TSS (mg/L)
SSC Pier - Reference Site	Inside	0.80	6.31	0.32	0.05	1.9	10.0	1.2	9.0
	Outside	0.81	5.71	0.25	0.04				
CC1-T	Inside	1.33	27.38	1.02	0.35	5.1	32.0	3.9	29.0
	Outside	2.97	22.91	1.05	0.64				
CC1-B	Inside	1.29	17.20	0.94	0.22	3.8	22.0	1.5	14.0
	Outside	1.66	14.19	1.71	0.17				
CC2-T	Inside	1.63	15.13	1.04	0.17	4.1	25.0	2.8	21.0
	Outside	2.39	18.84	1.06	0.20				
CC2-B	Inside	1.54	8.74	0.72	0.15	3.7	18.0	1.5	15.0
	Outside	2.24	12.08	0.91	0.13				
OF13N-T	Inside	2.12	15.07	1.03	0.19	4.7	19.0	1.4	14.0
	Outside	2.74	16.78	1.11	0.23				
OF13N-B	Inside	2.08	10.81	0.97	0.16	4.3	17.0	1.4	18.0
	Outside	NR	NR	NR	NR				
OF13M-T	Inside	2.49	12.50	1.08	0.15	5.4	20.0	1.5	13.0
	Outside	3.28	14.87	1.27	0.14				
OF13F-T	Inside	2.69	13.92	1.03	0.10	3.8	15.0	1.3	7.0
	Outside	2.37	9.88	1.02	0.08				

Table G-4. Grab and composite sample laboratory derived DGT data and dissolved concentrations.

Station ID		DGT data				Dissolved			
		Cu (µg/L)	Zn (µg/L)	Ni (µg/L)	Pb (µg/L)	Cu (µg/L)	Zn (µg/L)	DOC (mg/L)	TSS (mg/L)
PRE-STORM	CC1-T	1.41	22.26	0.80	0.12	4.40	27.00	2.40	ND
	CC2-T	0.55	5.87	0.36	0.10	4.30	21.00	1.50	5.00
	OF13N-T	0.54	4.30	0.53	0.12	4.80	18.00	1.30	7.00
	SSC Pier - Reference Site	0.59	4.56	1.84	0.14	3.20	14.00	1.10	7.00
FIRST GRAB SAMPLES	CC1-T-G1	2.87	22.03	0.89	0.13	11.00	40.0	NM	6.00
	CC1-B-G1	1.45	13.29	0.87	0.13	5.00	19.0	NM	8.00
	CC2-T-G1	0.93	11.03	0.84	0.12	4.00	14.0	NM	8.00
	CC2-B-G1	1.08	13.29	0.83	0.11	3.90	14.0	NM	6.00
	OF13N-T-G1	1.39	11.88	0.93	0.13	5.20	18.0	NM	18.0
	OF13N-B-G1	1.25	12.87	0.93	0.11	4.70	15.0	NM	8.00
	OF13M-T-G1	0.59	5.00	0.52	0.10	5.90	21.0	NM	7.00
	OF13F-T-G1	0.75	6.58	0.70	0.11	3.80	14.0	NM	7.00
	REF-T-G1	0.55	5.65	0.56	0.11	2.00	7.60	NM	7.00
COMPOSITE SAMPLES	CC1-T-COMP	0.60	4.64	0.47	0.14	5.10	32.0	3.90	29.0
	CC1-B-COMP	0.94	12.98	0.81	0.14	3.80	22.0	1.50	14.0
	CC2-T-COMP	0.51	23.51	0.48	0.12	4.10	25.0	2.80	21.0
	CC2-B-COMP	0.39	3.68	0.43	0.10	3.70	18.0	1.50	15.0
	OF13N-T-COMP	0.73	20.88	0.62	0.12	4.70	19.0	1.40	14.0
	OF13N-B-COMP	0.97	10.08	0.65	0.12	4.30	17.0	1.40	18.0
	OF13M-T-COMP	1.03	14.06	0.79	0.12	5.40	20.0	1.50	13.0
	OF13F-T-COMP	0.42	3.17	0.40	0.12	3.80	15.0	1.30	7.0
	REF-T-COMP	0.38	4.86	0.41	0.11	1.90	10.0	1.20	9.00
ADDITIONAL GRAB SAMPLES	CC1-T-G2	1.47	4.27	0.40	0.17	NM	NM	NM	NM
	CC1-B-G2	1.52	7.17	0.73	0.06	NM	NM	NM	NM
	OF14-SW-G1	2.37	21.29	3.35	0.21	4.48	174.16	65.08	2.91
	OF14-SW-G2	4.60	49.78	4.55	0.27	87.35	150.51	253.25	10.96
	CC1-T-G4	1.98	16.31	1.53	0.12	NM	NM	NM	NM
	OF13-SW-G1	3.18	56.61	2.95	0.12	14.37	175.85	253.61	8.11

NM=not measured.

Table G-5. Laboratory reference toxicant test results associated with the stormwater deployment at NBSD.

Test Species	Endpoint	LC or EC ₅₀ Values (µg/L) This Study	Published Data or Historical Mean LC or EC ₅₀ (µg/L)	Source
<i>Americamysis bahia</i>	96-hour Acute Survival	314	125-283 (n=20)	Nautilus, internal control chart (ending June 2014)
			138-505 (n=34)	SSC Pacific internal control chart (ending Sept 2014)
			126-181 (n=4)	Lussier et al.(1985); Cripe (1994)
<i>Mytilus galloprovincialis</i>	48-hour Embryo Dev.	9.8	7.2-16.3 (n=21)	Nautilus, internal control chart (ending May 2014)
			4.3-10.3 (n=5)	SSC Pacific internal control chart (ending Feb 2014)
<i>Macrocystis pyrifera</i>	48-hr Spore Germ.	97 ^a 128 ^b	120-374 ^a (n=20)	Nautilus, internal control chart (ending April 2014)
	48-hr Spore Growth	234 ^a 359 ^b	23-120 ^a (n=20)	
<i>Neanthes arenaceodentata</i>	96-hr Survival	164	80 (n=1)	Rosen and Miller (2011)

^aStandard EPA laboratory method for kelp spore germination and growth – spores released and exposed to a copper dilution series for 48-hr (EPA 1995)

^bModified kelp method for in situ testing – sporophyll blades exposed in copper for 48-hr, then spores are released and exposed to clean laboratory control water for 48-hr (Stransky et al., in prep)

Ref tox = reference toxicant test with copper chloride

**APPENDIX H
PSNS DATA TABLES**

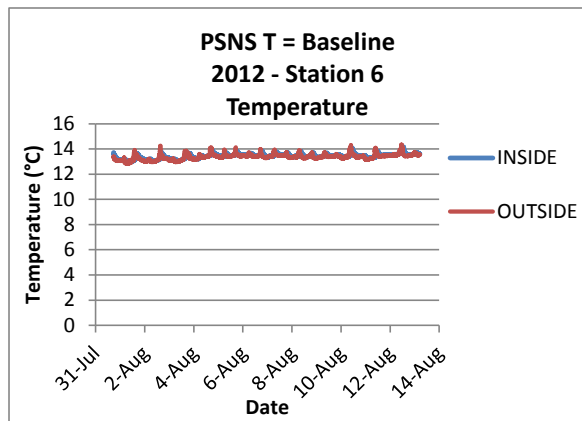
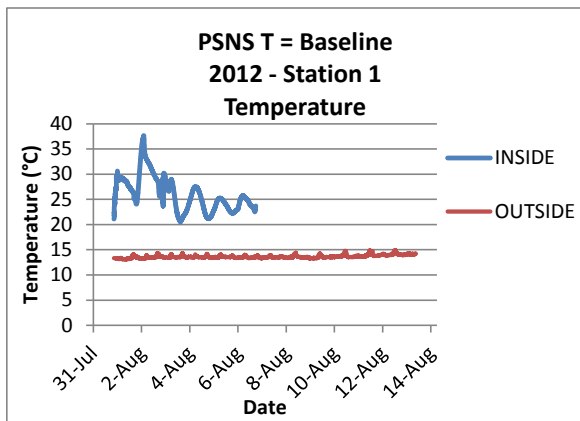
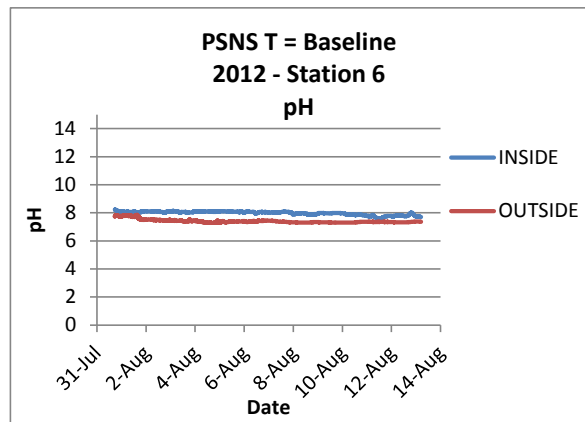
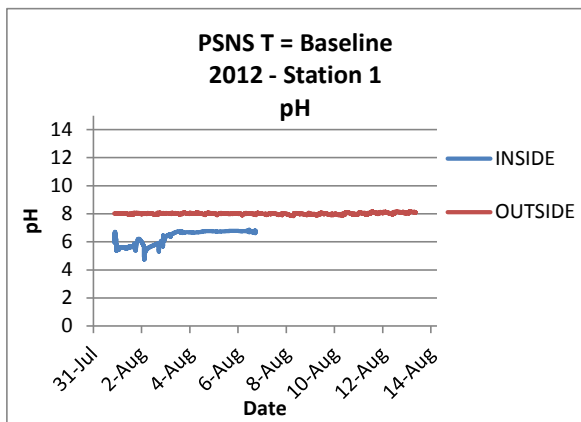
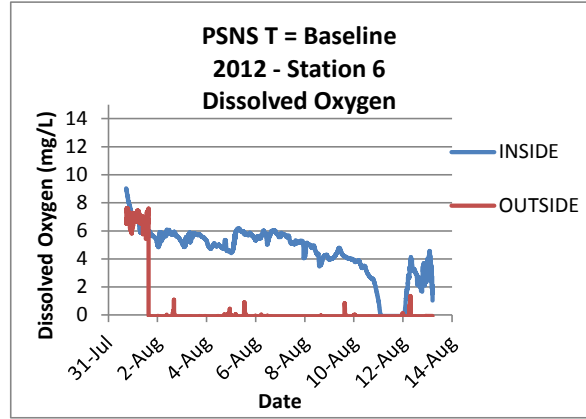
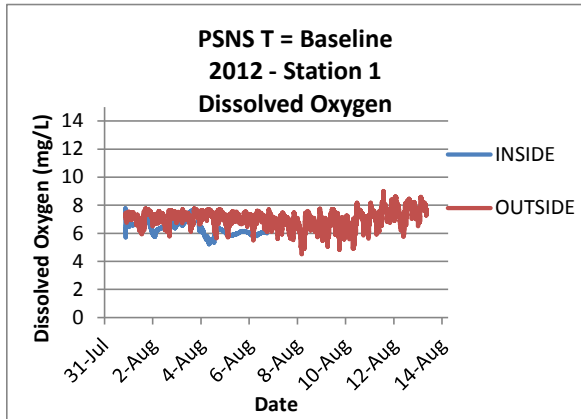

Figure H-1. For the 2012 Baseline study, Troll[®] 9500s were rented from In Situ, Inc. The Troll[®] placed inside a chamber at Station 1 stopped functioning midway through the exposure, so a full data set could not be collected. The dissolved oxygen (DO) data from the Troll[®] placed outside Station 6 are suspect, having gone to 0 shortly after the start of the exposure.

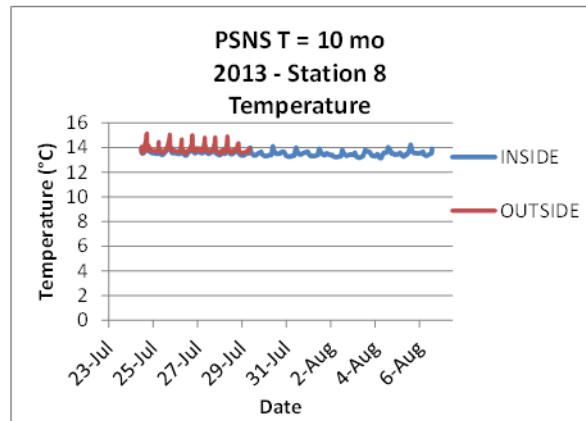
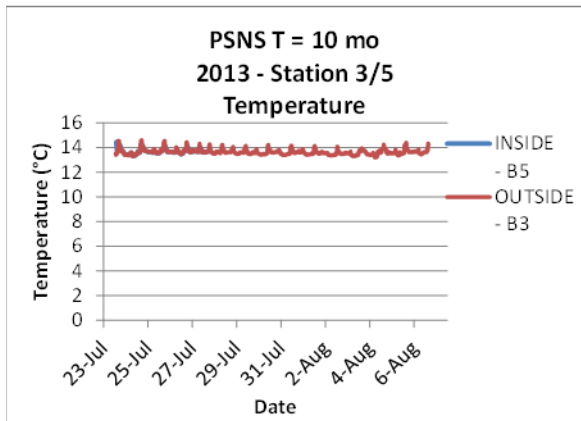
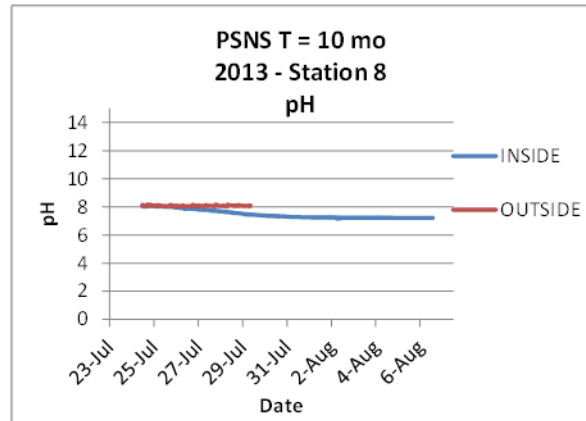
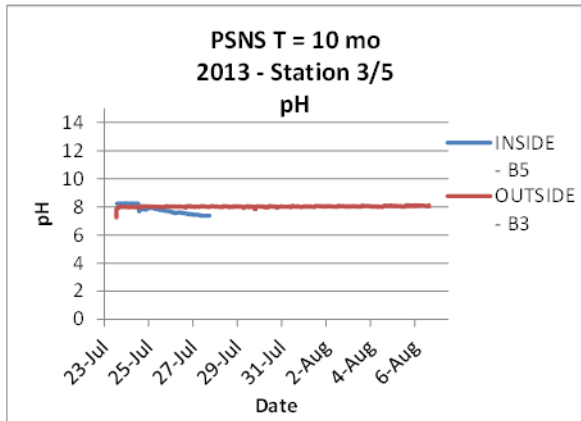
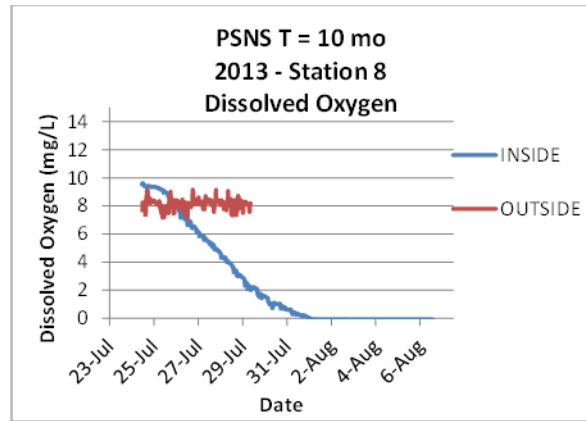
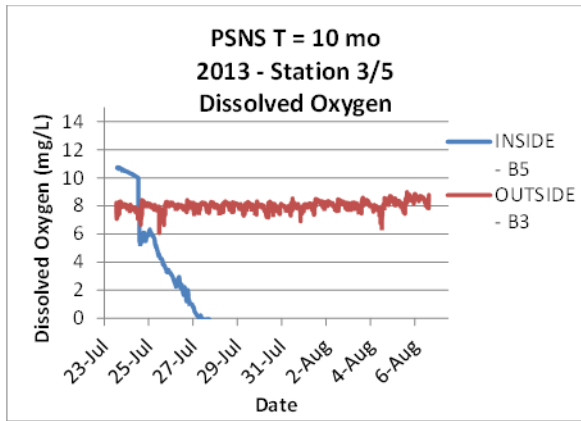

Figure H-2. For the 2013 (10 month post remedy) event, select rented Troll® 9500s stopped functioning early in the exposure, resulting in an incomplete dataset. The early flow cell design may have contributed to problems with the Troll data collection.

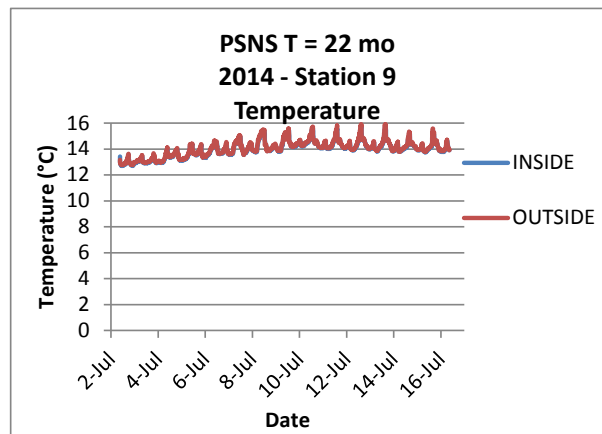
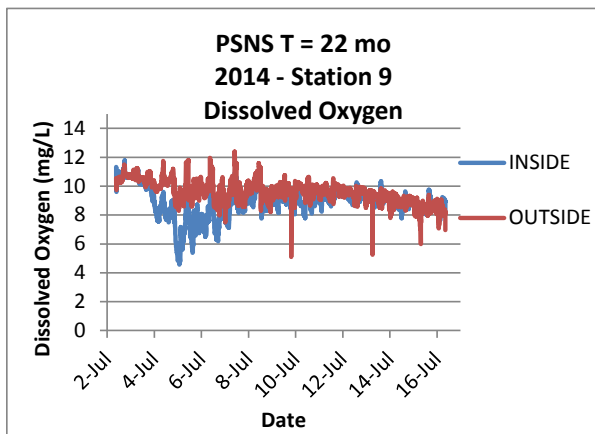
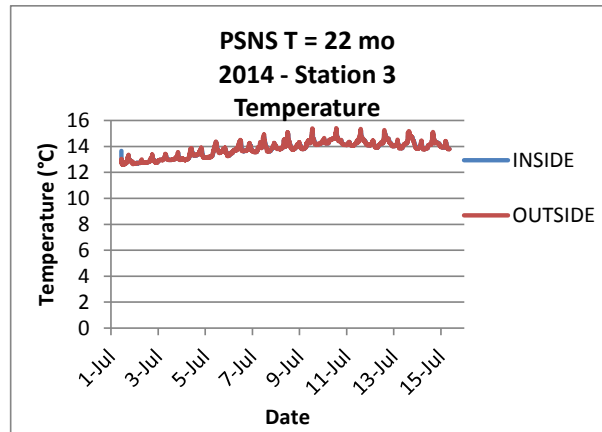
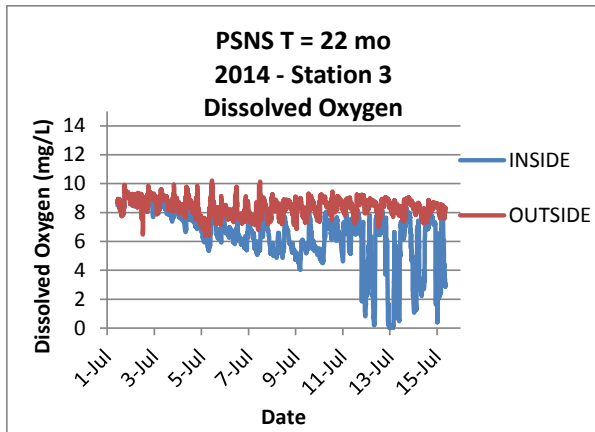

Figure H-3. For the 2014 event (22 mo post remedy), HOBO loggers (DO and temperature) were integrated into a SEA Ring chamber cap (inside) and attached to the exterior of the SEA Ring (outside).

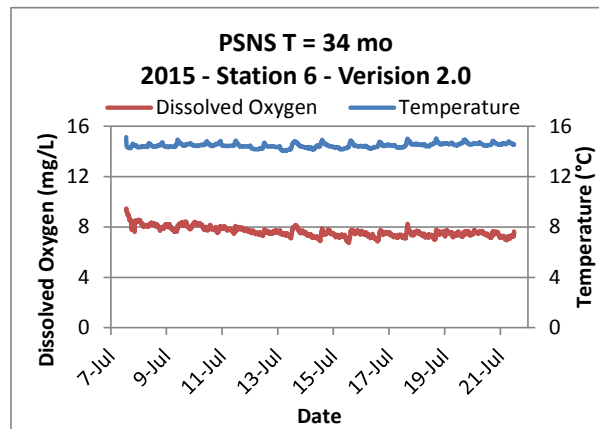
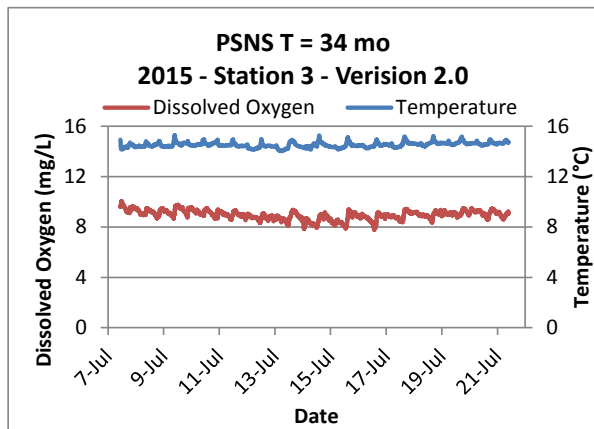
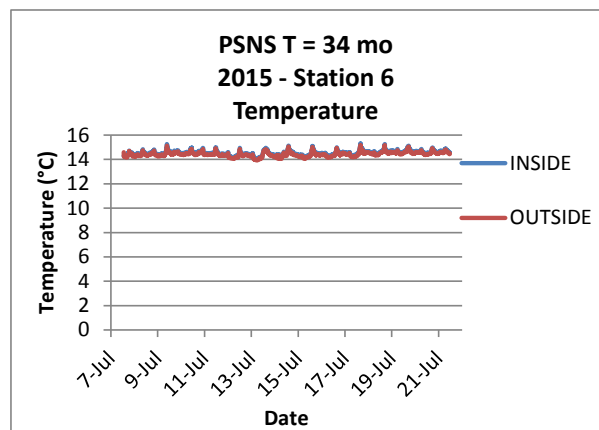
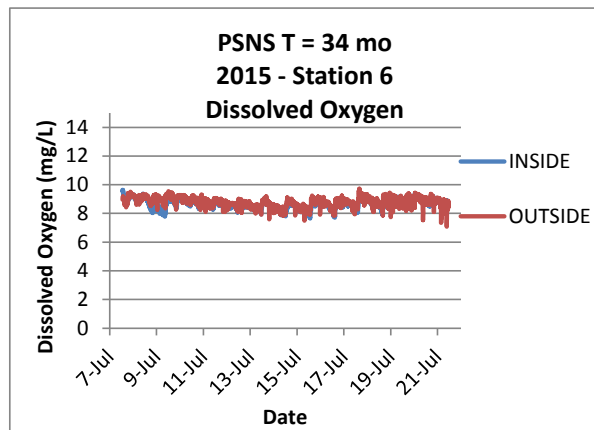
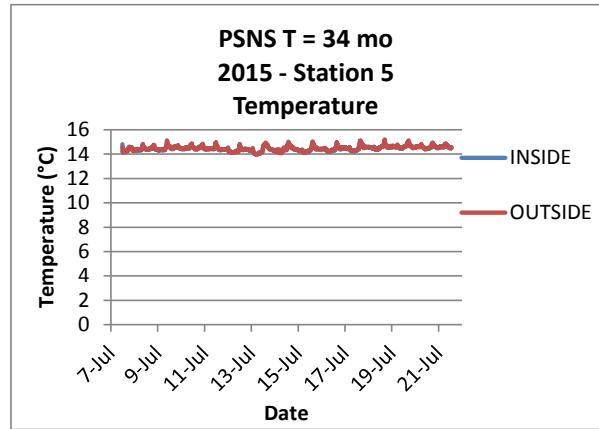
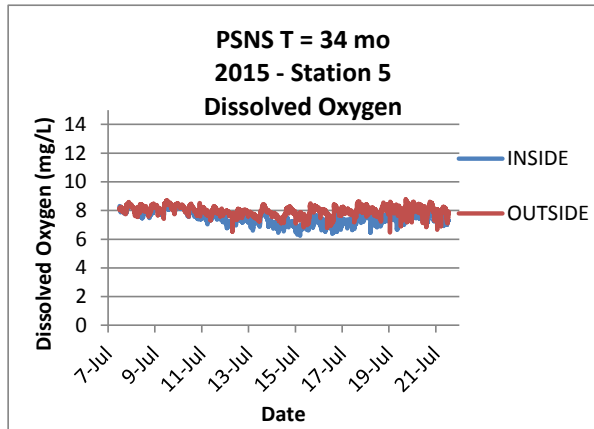

Figure H-4. For the 2015 (T = 34-month post-remedy) event, Version 2 and Version 3 SEA Rings were deployed. HOBO DO and temperature loggers were deployed inside and outside Version 3 SEA Rings at Stations 5 and 6, and inside Version 2 SEA Rings at Stations 3 and 6. All loggers performed well, and no water quality impairment was observed.

Table H-1. Summarized total PCB concentrations from *Macoma nasuta* and porewater over four sampling events.

Event	Station	Species	Total PCBs Tissue (ng/g, lw)	Total PCB in Porewater (Core)	Total PCB in Porewater (SEA Ring)	Duplicates	Average porewater [1]	Log Transform Tissue	Log Transform PW
Baseline	1	Macoma	12,850.80	0.05	0.1	< 0.1	0.075	4.11	-1.12
Baseline	2	Macoma	254.57	< 0.085	0.083		0.083	2.41	-1.08
Baseline	3	Macoma	646.81	< 0.082	0.17	< 0.15	0.170	2.81	-0.77
Baseline	4	Macoma	46.28	< 0.09	< 0.06		0.090	1.67	-1.05
Baseline	5	Macoma	1,685.98	3	0.52		1.760	3.23	0.25
Baseline	7	Macoma	481.42	0.051	0.065		0.150	2.68	-0.82
Baseline	8	Macoma	268.61	1.5	0.027		0.764	2.43	-0.12
Baseline	9	Macoma	354.72	0.04	0.043		0.042	2.55	-1.38
Baseline	10	Macoma	2,287.62	0.18	0.12		0.150	3.36	-0.82
10-month	1	Macoma	107.50	< 0.035	< 0.1		0.100	2.03	-1.00
10-month	2	Macoma	390.00	0.0055	< 0.063		0.006	2.59	-2.26
10-month	3	Macoma	566.00	< 0.052	0.052		0.052	2.75	-1.28
10-month	4	Macoma	375.00	< 0.029	0.021		0.021	2.57	-1.68
10-month	5	Macoma	474.20	< 0.13	0.022		0.022	2.68	-1.66
10-month	6	Macoma	716.50	< 0.052	< 0.027		0.052	2.86	-1.28
10-month	7	Macoma	232.43	< 0.032	< 0.035		0.035	2.37	-1.46
10-month	8	Macoma	149.20	< 0.028	< 0.036		0.036	2.17	-1.44
10-month	9	Macoma	50.18	< 0.032	< 0.026		0.032	1.70	-1.49
10-month	10	Macoma	233.18	< 0.044	0.064		0.064	2.37	-1.19
21-month	2	Macoma	39.82	0.043	0.055		0.049	1.60	-1.31
21-month	3	Macoma	328.91	0.027	0.01		0.019	2.52	-1.73
21-month	4	Macoma	78.73	0.0042	0.084		0.044	1.90	-1.36
21-month	5	Macoma	727.56	0.014	0.016		0.015	2.86	-1.82
21-month	6	Macoma	27.17	0.012	0.14		0.076	1.43	-1.12
21-month	7	Macoma	108.12	0.024	< 0.0038		0.024	2.03	-1.62
21-month	8	Macoma	456.67	0.011	0.014		0.013	2.66	-1.90
21-month	9	Macoma	56.23	0.048	0.021	0.04	0.036	1.75	-1.44
21-month	10	Macoma	527.12	0.014			0.014	2.72	-1.85
33-month	1	Macoma	6.29	0.063	0.011		0.037	0.80	-1.43
33-month	2	Macoma	373.10	0.045	0.014		0.030	2.57	-1.53
33-month	3	Macoma	265.77	0.026	<0.13		0.026	2.42	-1.59
33-month	4	Macoma	121.95	0.007	0.0044		0.006	2.09	-2.24
33-month	5	Macoma	2,769.48	0.021	0.013		0.017	3.44	-1.77
33-month	6	Macoma	8.97	0.0089	<0.075	<0.36	0.009	0.95	-2.05
33-month	8	Macoma	29.12	0.019	0.023		0.021	1.46	-1.68
33-month	9	Macoma	29.02	0.012	0.052		0.032	1.46	-1.49
33-month	10	Macoma	563.10	0.018	0.056		0.037	2.75	-1.43
[1] Average of detects only, if all samples ND, highest DL shown									

Table H-6. Summarized total PCB concentrations from *Nephtys caecoides* and porewater over 4 sampling events.

Event	Station	Species	Total PCBs (ng/g, lw)	Total PCB in Porewater (Core)	Total PCB in Porewater (SEA Ring)	Duplicates	Average Porwater [1]	Log Transform Tissue	Log Transform Porewater
Baseline	3	Nephtys	527.16	< 0.082	0.17	< 0.15	0.17	2.722	-0.770
Baseline	4	Nephtys	760.33	< 0.09	< 0.06		0.09	2.881	-1.046
Baseline	5	Nephtys	2,135.18	3	0.52		1.76	3.329	0.246
Baseline	6	Nephtys	2,912.87	5.2	3.4		4.3	3.464	0.633
Baseline	7	Nephtys	3,108.00	0.051	0.065		0.058	3.492	-1.237
Baseline	8	Nephtys	11,731.59	1.5	0.027		0.7635	4.069	-0.117
10-month	1	Nephtys	8.62	< 0.035	< 0.1		0.1	0.935	-1.000
10-month	4	Nephtys	183.33	< 0.029	0.021		0.021	2.263	-1.678
10-month	7	Nephtys	188.64	< 0.032	< 0.035		0.035	2.276	-1.456
10-month	9	Nephtys	366.00	< 0.032	< 0.026		0.032	2.563	-1.495
10-month	10	Nephtys	20,156.80	< 0.044	0.064		0.064	4.304	-1.194
21-month	4	Nephtys	134.13	0.0042	0.084		0.0441	2.128	-1.356
21-month	5	Nephtys	311.84	0.014	0.016		0.015	2.494	-1.824
21-month	7	Nephtys	301.32	0.024	< 0.0038		0.024	2.479	-1.620
21-month	8	Nephtys	225.37	0.011	0.014		0.0125	2.353	-1.903
21-month	9	Nephtys	258.51	0.048	0.021	0.04	0.0363333	2.412	-1.440
21-month	10	Nephtys	203.36	0.014			0.014	2.308	-1.854
33-month	1	Nephtys	134.49	0.063	0.011		0.037	2.129	-1.432
33-month	4	Nephtys	110.77	0.007	0.0044		0.0057	2.044	-2.244
33-month	5	Nephtys	205.19	0.021	0.013		0.017	2.312	-1.770
33-month	6	Nephtys	110.81	0.0089	<0.075	<0.36	0.0089	2.045	-2.051
33-month	8	Nephtys	44.21	0.019	0.023		0.021	1.646	-1.678
33-month	9	Nephtys	5.72	0.012	0.052		0.032	0.758	-1.495

[1] Average of detects only, if all samples ND, highest DL shown

REPORT DOCUMENTATION PAGE

*Form Approved
OMB No. 0704-01-0188*

The public reporting burden for this collection of information is estimated to average 1 hour per response, including the time for reviewing instructions, searching existing data sources, gathering and maintaining the data needed, and completing and reviewing the collection of information. Send comments regarding this burden estimate or any other aspect of this collection of information, including suggestions for reducing the burden to Department of Defense, Washington Headquarters Services Directorate for Information Operations and Reports (0704-0188), 1215 Jefferson Davis Highway, Suite 1204, Arlington VA 22202-4302. Respondents should be aware that notwithstanding any other provision of law, no person shall be subject to any penalty for failing to comply with a collection of information if it does not display a currently valid OMB control number.

PLEASE DO NOT RETURN YOUR FORM TO THE ABOVE ADDRESS.

1. REPORT DATE (DD-MM-YYYY) January 2017		2. REPORT TYPE Final		3. DATES COVERED (From - To)																									
4. TITLE AND SUBTITLE Demonstration and Commercialization of the Sediment Ecosystem Assessment Protocol Project ER-201130 Environmental Restoration Project				5a. CONTRACT NUMBER																									
				5b. GRANT NUMBER																									
				5c. PROGRAM ELEMENT NUMBER																									
6. AUTHORS <table border="0"> <tr> <td>Gunther Rosen</td> <td>Chris Stransky</td> <td>John Radford</td> <td>Melissa Grover</td> </tr> <tr> <td>D. Bart Chadwick</td> <td>Amec Foster Wheeler</td> <td>Zebra-Tech, Ltd.</td> <td>Geosyntec Environmental</td> </tr> <tr> <td>Marianne A. Colvin</td> <td></td> <td></td> <td></td> </tr> <tr> <td>SSC Pacific</td> <td>Allen Burton</td> <td>Howard Bailey</td> <td>Marc Greenberg</td> </tr> <tr> <td></td> <td>University of Michigan</td> <td>Adrienne Cibor</td> <td>USEPA ERT</td> </tr> <tr> <td></td> <td></td> <td>Nautilus Environmental</td> <td></td> </tr> </table>				Gunther Rosen	Chris Stransky	John Radford	Melissa Grover	D. Bart Chadwick	Amec Foster Wheeler	Zebra-Tech, Ltd.	Geosyntec Environmental	Marianne A. Colvin				SSC Pacific	Allen Burton	Howard Bailey	Marc Greenberg		University of Michigan	Adrienne Cibor	USEPA ERT			Nautilus Environmental		5d. PROJECT NUMBER	
				Gunther Rosen	Chris Stransky	John Radford	Melissa Grover																						
				D. Bart Chadwick	Amec Foster Wheeler	Zebra-Tech, Ltd.	Geosyntec Environmental																						
Marianne A. Colvin																													
SSC Pacific	Allen Burton	Howard Bailey	Marc Greenberg																										
	University of Michigan	Adrienne Cibor	USEPA ERT																										
		Nautilus Environmental																											
5e. TASK NUMBER																													
5f. WORK UNIT NUMBER																													
7. PERFORMING ORGANIZATION NAME(S) AND ADDRESS(ES) SSC Pacific 53560 Hull Street San Diego, CA 92152-5001				8. PERFORMING ORGANIZATION REPORT NUMBER TR 3052																									
9. SPONSORING/MONITORING AGENCY NAME(S) AND ADDRESS(ES) Environmental Security Technology Certification Program 4800 Mark Center Drive, Suite 17D08 Arlington, VA 22350-3605				10. SPONSOR/MONITOR'S ACRONYM(S)																									
				11. SPONSOR/MONITOR'S REPORT NUMBER(S)																									
12. DISTRIBUTION/AVAILABILITY STATEMENT Approved for public release.																													
13. SUPPLEMENTARY NOTES This is work of the United States Government and therefore is not copyrighted. This work may be copied and disseminated without restriction.																													
14. ABSTRACT This project completes the field demonstrations of the Sediment Ecosystem Assessment Protocol (SEAP) with a focus on the commercialization of the SEA Ring <i>in situ</i> toxicity testing technology. The SEA Rings have been found to meet laboratory-based quality assurance/quality control (QA/QC) criteria/objectives for various toxicity and bioaccumulation tests, have met additional performance objectives developed as a part of this program, and have thus been able to prove that this new technology can successfully better assess toxicological impacts and bioaccumulation in environments with dynamic processes or physical attributes that are not replicable in a laboratory setting. Furthermore, regulatory knowledge and acceptance has been gained through presentation of the technology at several conferences, one-on-one meetings with end users and regulators, and publication of magazine articles and white papers. Several journal articles are also now in progress. The demonstrations have also provided confidence that the technology can successfully be used cost effectively to support similar assessments at Department of Defense (DoD) facilities and elsewhere.																													
15. SUBJECT TERMS Sediment Ecosystem Assessment Protocol (SEAP); SEA Ring <i>in situ</i> toxicity testing technology; laboratory-based quality assurance/quality control criteria/objectives; toxicity and bioaccumulation tests																													
16. SECURITY CLASSIFICATION OF:			17. LIMITATION OF ABSTRACT	18. NUMBER OF PAGES	19a. NAME OF RESPONSIBLE PERSON																								
a. REPORT	b. ABSTRACT	c. THIS PAGE			Gunther Rosen																								
U	U	U	U	279	19b. TELEPHONE NUMBER (Include area code) (619) 553-0886																								

INITIAL DISTRIBUTION

84300	Library	(1)
71705	D. B. Chadwick	(1)
71760	G. Rosen	(1)
71760	M. A. Colvin	(1)
Defense Technical Information Center		
Fort Belvoir, VA 22060-6218		(1)

Approved for public release.



SSC Pacific
San Diego, CA 92152-5001