

Sediment Sampling Guide and Methodologies

(2nd Edition)

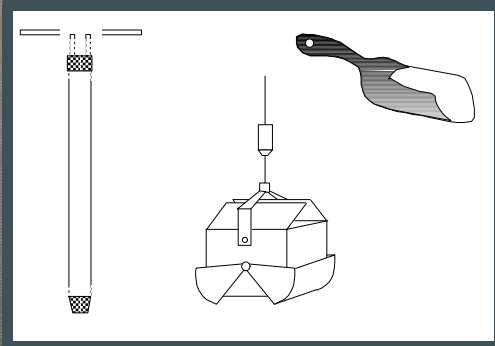
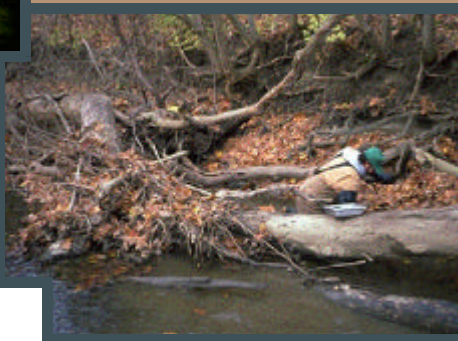

November
2001

Ohio Environmental Protection Agency
Lazarus Government Center
P.O. Box 1049
Columbus, Ohio 43216-1049

TABLE OF CONTENTS

DEFINITIONS	1
1.0 - SAMPLING PURPOSE	3
a. Bioassays	3
b. Biosurvey Sampling	3
c. Monitoring	3
d. Contaminant Source Identification	3
e. <i>In-Situ</i> Measurements	3
f. Dredging / Section 404-401 Decisions	3
g. Trends / Historical Contamination	4
h. Complaint Investigation	4
i. Sediment Collection Technique Evaluation	4
j. Nonpoint Pollution Assessment	4
k. Nutrient Cycling	4
l. Bedload / Sediment Dynamics	4
2.0 - SAFETY	5
3.0 - SAMPLING PLAN	6
a. Description of the Project	6
b. Data Quality Objectives	6
c. Previous Studies	6
d. Dates of Collection	6
e. Sample Site Selection	7
f. Estimating Particle Size Percentages	7
g. Sample Types	7
h. Field Screening	8
i. Parameter Selection	8
j. Site and Sample Description	8
k. Sample Preparation and Handling	9
l. Statistics	10
m. Station Replicate Samples	10
n. Blanks / Field Duplicate Samples	10
o. Reporting	10

4.0 METHODOLOGIES	11
a. Bathymetric Survey / Initial Reconnaissance	11
b. Pre-sample Collection	11
c. Changing Sampling Site Locations	11
d. Decontamination / Cleaning / Calibration	12
e. Suggested List of Supplies / Equipment for Sediment Collection	12
f. Preparation for Sampling / General Methodologies	12
g. Standard Surface Grab Collection with Scoops and Spoons	13
h. Standard Surface Grab Collection with Dredges	13
i. Standard Core Collection	14
j. Other Types of Collection	14
k. Compositing	15
l. Sample Preservation	15
m. Holding Times	15
n. Other Data Collection	15
o. Sample Labeling/ Shipping/ Paperwork / COC	16
5.0 DATA REPORTING AND STORAGE	17
a. Data Reporting	17
b. Data Storage and Retrieval	17
APPENDICES	
A. Collecting Sediment samples by Vibro-coring	18
B. Sediment Oxygen Demand	21
C. Sample Collection for Solid Phase Sediment Bioassay	23
D. Standard Sampling Form	26
E. Table of Sediment Sampling Equipment	27
F. Sediment Sample Volume and Container Type for Samples Submitted to Ohio EPA DES Laboratory	30
G. Sediment Sampling Locations	31
BIBLIOGRAPHY	35

DEFINITIONS AND ABBREVIATIONS

ACOE - United States Army Corps of Engineers

Aliquot - A portion or subset of a sample. An aliquot can be any size, but it must be representative of the parent sample.

Background - Refers to the concentration of a chemical at an upstream site or other location having similar physiochemical characteristics which can be compared to the concentration of the same chemical found at the site of interest.

BNA - Base Neutral Acid extractible compound

Cleaned - Equipment and supplies that have been washed with water and detergent and rinsed with local water or tap water followed by a rinse with deionized water to ensure there is no carryover of VOCs and metals from the tap water to the equipment.

COC - Chain of Custody

Composite Sample - A thoroughly homogenized set of two or more grab samples.

Contaminated Sediment - A sediment where the concentration of a chemical exceeds a level of toxicological concern.

Decontaminated - Equipment and supplies that have been cleaned and subjected to decontamination rinses using the procedures set forth in section 4.0(d) of this manual.

DERR - Ohio EPA Division of Emergency and Remedial Response

DES - Ohio EPA Division of Environmental Services

DQO - Data Quality Objectives

DSW - Ohio EPA Division of Surface Water

Field Duplicate - An aliquot of a sample collected to make an exact copy of the original sample. Often referred to as a split sample. Duplicate samples are used to check sample preparation

techniques, laboratory precision and comparison of different laboratory results.

GLNPO - Great Lake National Program Office

Grab Sample - A single, discrete sample collected from one location at one point in time.

Impacted Sediment - A contaminated sediment where an adverse biological impact is observed.

Local Water - Stream or lake water collected near the sediment sample.

Naturally Occurring Aquatic Substrate - Solid materials associated with surface waters and not of anthropogenic origin on or within which organisms can live.

PAH - Polycyclic Aromatic Hydrocarbons

PCDD - Polychlorodibenzodioxins

PCDF - Polychlorodibenzofurans

Project Manager - For the purposes of this document, a person that is responsible for the design, implementation and reporting of a sediment sampling project.

QA/QC - Quality Assurance/Quality Control

Reference Sediment - Refers to the concentration of a chemical at an Ohio EPA ecoregional reference site which represents conditions of least impact as a result of known human activity.

Sediment - Unconsolidated inorganic and organic material that is suspended in and being transported by surface water or has settled out and deposited under surface waters. Sediment includes: 1) materials below the water surface under bankfull conditions in streams, lakes, and ditches; 2) materials at normal pool elevation for reservoirs; 3) materials within the federal jurisdictional boundaries of wetlands; 4) materials at and below maximum capacity for ponds and lagoons; 5) for Lake Erie, materials found at or below high water conditions as defined by the

United States Geological Survey over a five year period.

SOP - Standard Operating Procedure

Station/ Field Replicate - Samples from a location that were taken in the same general area (e.g., 20 to 200 meters depending on waterbody), during the same time period, using the same sampling equipment (decontaminated between samples), and using the same sampling techniques as the original sample. Station replicates are usually used to determine sample variability at a given location at a given point in time.

Synoptic Survey - A general investigation of a large geographic area. Usually a basin wide study.

TCLP - Toxicity Characteristic Leaching Procedure

TPH - Total Petroleum Hydrocarbon

U.S. EPA SW-846 - A document containing test methods for evaluating solid waste. SW-846 provides test procedures & guidance which are recommended for use in conducting the evaluations and measurements needed to comply with the Resource Conservation and Recovery Act (RCRA).

USGS - United States Geological Survey

VOC - Volatile Organic Compound

40 CFR Parts 87 to 149 - The Code of Federal Regulations is a codification of the general and permanent rules published in the Federal Register by the Executive departments and agencies of the Federal Government.

1 - SAMPLING PURPOSE

Sediment samples are collected by the Ohio EPA for a variety of reasons including chemical, physical, toxicological and biological analysis. Due to the inherent variability of sediments, collection techniques should be evaluated and chosen for each sampling site and each sampling purpose. Choosing the most appropriate sampling device and technique depends on: 1) The purpose of the sampling; 2) the location of the sediment; and 3) the characteristics of the sediment. This document should be used only as a guide for selecting the sampling location and proper collection technique (Appendix E contains a table that can be used as an aid in selecting the most appropriate sediment collection device). Once the sampling site and collection technique have been selected, then the specific methodologies for the actual collection of the samples should be closely followed. The experience and judgement of the sample collector should be used as much as possible in order to obtain a representative sample of the sediment environment compatible with the objectives of the sampling. Whatever sampling technique and device is used, the specific rationale and collection methodologies should be stated in each evaluation and report of the data. Users are encouraged to review other references such as Plumb (1981), Burton and Landrum (1990), Mudroch and MacKnight (1994), and Mudroch and Azcue (1995) for background information and additional guidance.

The purpose of the sediment sampling should be well defined before any sediment sampling plan is developed. Below are brief descriptions of sediment sampling projects that have been used in environmental studies.

1a. Bioassays

Sediment bioassay samples are used to determine if there is toxicity to representative aquatic organisms from contaminated bulk sediments. Sediment bioassay samples are usually collected within the top 10 centimeters of the sediment surface with equipment that causes the least disturbance to the sediment surface during collection. Specific methodologies have

not been developed by Ohio EPA for collection of pore waters or elutriate tests for bioassay.

1b. Biosurvey Sampling

Macroinvertebrates are often collected for biosurveys from soft, fine grained sediments. Biosurvey sampling is addressed in Part V, Section A of the Manual of Ohio EPA Surveillance Methods and Quality Assurance Practices, Volume I (1991).

1c. Monitoring

Chemical and physical analysis of sediments can be used as a tool for the monitoring of pollutant discharges to a river or lake system. In order to be able to make valid comparisons among stations or reference sites, consistent sampling techniques should be maintained. Samples continue to be collected from the Ohio Stream Regionalization Project sites and other "reference" sites to improve the data base for background conditions within each established ecoregion. These data can then be applied as reference for evaluation of contaminated areas.

1d. Contaminant Source Identification

Sediments can be used to help locate nonpoint, historical, or intermittent discharges that may not be readily apparent using samples collected from the water column. Sediments are used to identify the location of these sources by upstream incremental collection of samples from a contaminated site.

1e. *In-situ* Measurements

Sediment oxygen demand (SOD) is an in-situ measure of the oxygen consumed by biochemical decomposition of organic matter in stream or lake sediment deposits. SOD can be used to evaluate pollutant source control performance or as a metric (input) for use in water quality models.

1f. Dredging / Section 404-401 Decisions

Sediment samples are often collected for use in dredging and dredge spoil management decisions. These samples should be collected within the vertical profile of the dredging project to

account for probable stratification. Discrete sampling is preferred and the use of composite samples for dredge management decisions should be made with caution. In known or suspected heavily contaminated areas, special analyses such as PCB tests and RCRA regulated compounds using the Toxicity Characteristic Leaching Procedure (TCLP) in U.S. EPA SW-846 should be performed to aid in disposal decisions. In addition, whole sediment toxicity tests have been developed to aid in disposal decisions and complement the TCLP test.

1g. Trends / Historical Contamination

Sediment sampling is also used as a tool in the evaluation of the effectiveness of pollution source controls. This can be accomplished with discrete vertical sampling (assuming the sediments have not been mixed or otherwise disturbed) or by reproducing earlier sampling efforts.

1h. Complaint Investigation

Sediment sampling to help address citizen complaints requires a great deal of assessment and judgement by the sample collector. The design of each complaint sampling investigation should be evaluated on a case by case basis. Because of cost and often long turn around times, sediment sampling for the sole purpose of resolving citizen complaints should be used judiciously.

1i. Sediment Collection Technique Evaluation

Comparison of samples using sediment collection techniques and devices can be made to determine the easiest and most effective sampling method. Evaluation of other techniques such as sediment traps can also be made to make sediment collection more reproducible.

1j. Nonpoint Pollution Assessment

Sediment samples can be collected for evaluation of nonpoint pollution. Selection of parameter coverage for analysis of the samples can sometimes be important in defining the source of sediments (e.g., high pesticide/herbicide contamination would indicate agricultural run-off).

1k. Nutrient Cycling

Sediment samples can be collected in lake or

river habitats to determine potential release of nutrients (e.g., phosphorus) back into the water column.

1l. Bedload / Sediment Dynamics

Prediction of sediment resuspension, both modeling and measurement procedures, are still experimental. The dynamics of the movement, transport and fate of contaminants adsorbed to sediment is not thoroughly understood and are beyond the scope of this document.

2 - SAFETY

Prior to the development of the sampling plan, Ohio EPA safety policies should be consulted. Everyone involved in the preparation, collection and analysis of the sediment samples should be familiar with the safety policies. Special attention should be given to physical dangers such as slip, trip and fall hazards when working around water. In general, it is recommended that the sample collector(s) avoid skin contact with all sediments and inhalation of odor should be avoided. Special precautions may have to be taken when working with contaminated sediments especially near potential or known contaminant sources such as unpermitted outfalls, NPDES permitted outfalls, landfills or hazardous waste sites. Specific site safety plans for sampling near unregulated hazardous waste (DERR) sites should be followed when sampling is done in conjunction with a DERR project or any other project where contaminated sediments may pose a risk to sampling personnel.

3 - SAMPLING PLAN

Sediment sampling usually entails relatively higher expense in personnel, collection effort and analytical costs per sample than the collection and analysis of water samples. A sampling plan should be developed, written and approved by the project manager prior to the collection of sediment samples to maximize resource allocation. The plan should incorporate a statement as to the purpose and the data quality objectives of the proposed sediment sampling.

Sample collection is often governed by logistic and resource constraints rather than specific project objectives. As a result, the data from such studies are often incomplete and the benefits from the collection of that data is reduced if not eliminated as a result of the constraints. If resources are unavailable to perform an adequate study to meet the data quality objectives, then the sampling project should be reevaluated.

3a. Description of the Project

A brief description of the sampling project should be included in the sampling plan. A description of how the sediment sampling will be integrated with other planned studies and an explanation of how the sediment sampling information will be used should be stated.

3b. Data Quality Objectives

This important section of the sampling plan should state what type of information needs to be collected in order to meet the objectives of the sampling project. This information should include:

- C Purpose of the sampling.
- C How the data from the sampling will be used.
- C What actions will be taken as a result of the sampling.
- C Identification of the laboratory performing the analyses.
- C The parameters for analysis including method detection limits (see Part VI of the Manual of Ohio EPA Surveillance Methods and Quality Assurance Practices if the Ohio EPA laboratory is being used).

- C Number and type of quality control samples such as field blanks, equipment rinses, field duplicates, station replicates, reference and background samples.
- C Statistical analysis and criteria (allowable errors) used to evaluate the data.
- C Standards, background or benchmark criteria used to compare the analytical results.
- C Number and location of samples to be collected to meet the purpose of the project.
- C How the information will be reported.
- C Whether the data will be entered into an electronic database and, if so, the structure and file type of the database.

3c. Previous Studies

A thorough review and assessment of existing data and information of the sampling area should be performed to assist in this portion of the planning process. A brief summary of that information and an assessment should be included in the written sampling plan. In reviewing existing information, attention should be given to the purpose of the collection of the historical data and what sampling techniques, analytical procedures and laboratories were used in performing the analyses. This information is important in order to determine the usefulness of the historical data for the proposed project.

3d. Dates of Collection

The general time of year when the samples will be collected should be considered during the planning of the sampling activities. In general, sediment sampling in the low flow conditions of summer and fall are the most practical. Seasonal variations of sediment deposits and quality can occur due to high flows and ice scour on rivers, leaf litter in the fall, land use practices (e.g., agricultural pesticide applications) or seasonal variations in benthic populations. Winter may be a convenient time to sample some inland lakes through the ice, while ice cover may be a severe safety concern in the collection of river sediment samples. The analytical laboratory should be contacted early in the planning process for proper coordination to ensure all needs are met.

3e. Sample Site Selection

Selection of the sampling locations and number of samples is one of the most important decisions to be made in the planning process. The selections should be made based upon the data quality objectives of the study and resources available to the project. Rationale for the selection of the sampling locations should be included in the plan. The chemical and physical nature of sediments is strongly influenced by the size of the individual particles of sediment. Sediments composed of sands (0.06-2.0 mm) and larger sized particles are often stable inorganic silicate minerals. These larger particles form non-consolidated deposits, have a relatively lower specific capacity (amount of interstitial water) and a more neutral surface electrical charge. These types of materials are usually not associated with contaminants and are not recommended for analysis. Fine grained silts and clays (<0.06 mm), however, have a much larger specific capacity, have unbalanced electrical charges and much larger surface area to volume ratio. These properties make the finer grained sediments much more chemically, physically and biologically interactive. These are the types of sediments that should be submitted for analysis and most of the sediment sampling locations should be biased towards collecting these types of sediments (see Appendix G).

3f. Estimating Particle Size Percentages

A goal of sediment collection is > 30% silt and clays in the sediment sample. If these sediment types are not found, then it should be noted on the laboratory submission sheets and field collection form. The percentage of silts and clays in a sample can be estimated in the field by marking a line on a clear jar and then marking 30% of the way up to that line on the jar with another line. Fill the jar to the top line with sediment and vigorously shake the jar and set aside to settle. A one inch headspace in the jar allows for easier mixing. After settling for 10 minutes, an estimate of the particle size distribution can be made with a visual inspection of the sediment stratification in the jar. If the fines stop below the 30% line, then the silt/clay fraction is likely to be <30%.

It's assumed that the finer grained sediments are located in still waters of the sample area in deep water, at stream margins, behind boulders and other obstructions, or at inside bends of river meanders. An initial reconnaissance of the sample area should be performed, if possible, prior to the completion of the sampling plan. This reconnaissance can often identify field limitations in the study design that can be addressed prior to sample collection. An initial reconnaissance should include a cursory bathymetric survey using a wading staff in shallow streams and rivers or an echosounding (sonar) depth finder for deeper waters. Local knowledge or recent navigation charts (USGS surveys or ACOE harbor/waterway soundings in navigable waters) can often provide similar information to an echosounding survey.

3g. Sample Types

A description and rationale for the types of samples to be collected should be included in the written plan.

Cores - Vertical discrete grab samples. Most appropriate for historical contamination information or dredging decisions at heavily contaminated areas.

Cores - Depth integrated composite samples. Most appropriate for reference and Section 404/401 issues.

Scoops and Dredges - Surface (top two to four centimeters) sediment grab samples. Most appropriate for benthic, sediment oxygen demand (in-situ), recent ambient conditions and recent contaminant investigation.

Scoops and Dredges - Surface sediment composite samples. May be used to reduce costs for specific conditions/situations such as some Section 404/401 issues or ambient or specific historical data. In general, however, discrete sampling is preferred if resources are available. An example of a discrete sample would be taking a section of one centimeter of sediment from a core sample that was originally one meter long.

3h. Field Screening

The use of field screening devices such as head space analysis with Photo Ionization Detectors (PID) and Flame Ionization Detectors (FID) is encouraged for intensive sampling programs. A preliminary screening program or “phased approach” can give a lot of direction as to where more intensive sampling is needed and can give insight as to the types of analyses which may or may not be needed for subsequent sampling phases. These field screening devices have different sensitivities to different compounds. In general, PIDs are more useful for detection of chlorinated and aromatic compounds while FIDs are more useful for aliphatic compounds.

To use this technique, an aliquot of sample is placed in a glass jar and covered with aluminum foil. After the atmosphere in the jar has reached equilibrium with the sediment, the PID or FID probe tip is inserted into the jar through the aluminum foil and the measurements recorded. Action level criteria for head space analysis results should be specified in the data quality objectives section of the sampling plan. Head space analysis tests must be performed only by personnel specifically trained in the use of these instruments.

3i. Parameter Selection

Selection of the chemical and physical analysis to be performed on each sample is based upon the purpose of the study, the data quality objectives and available resources. Each sediment sample should be analyzed, at a minimum, for Total Organic Carbon (TOC) and Particle size. All analyses should conform to SW-846, 40 CFR Part 136, Manual of Ohio EPA Surveillance Methods and Quality Assurance Practices, or Standard Methods as appropriate.

Possible analyses include:

CHEMICAL

- ☐ Total Organic Carbon (TOC)
- ☐ Metals (Pb, Ni, Cu, Zn, Cd, Cr, Fe, Mn, Hg, As and other metals as necessary)
- ☐ Nutrients (COD, Total Phosphorus, Total Kjeldahl Nitrogen (TKN), Ammonia)
- ☐ Cyanide
- ☐ Oil and Grease

- ☐ Persistent Organics (Pesticides, Insecticides, Herbicides, PCB's, BNA's, TPH's, PCDD, PAH's, and PCDF's in special circumstances)
- ☐ Volatile Organics (including trihalomethanes)
- ☐ Volatile Sulfides
- ☐ Oxidation Reduction Potential(ORP)/redox
- ☐ pH

PHYSICAL

- ☐ Particle size
- ☐ Appearance/Texture/Odor/Color
- ☐ Radiochemistry
- ☐ Shear strength and water content (for dredging purposes only)

BIOLOGICAL/BIOCHEMICAL

- ☐ Sediment Oxygen Demand (SOD)
- ☐ Bioassay
- ☐ Macroinvertebrate Survey

OTHER DATA COLLECTION

- ☐ Overlying water quality including: Water Temperature, Water Depth, Dissolved Oxygen, Conductivity, pH, Turbidity, Water Velocity.

3j. Site and Sample Description

Each sample station should have the following information recorded:

- ☐ Date and time of the sample collection.
- ☐ Latitude/Longitude of site.
- ☐ River Mile of site from PEMSO maps, if available.
- ☐ Location description with reference to visual landmarks.
- ☐ Sampling location marked on a 7.5 minute USGS Quadrangle map (to show exact location of grab sample). More detailed custom maps should be made as needed.
- ☐ Water Depth/Results of bathymetric survey.
- ☐ Description of current.
- ☐ Unusual conditions (weather, equipment malfunction, ship traffic, etc.).
- ☐ Photographs of samples (close up) and sample locations are recommended.
- ☐ Physical description of sample (color as determined by the Munsell® soil color chart, texture, odor, obvious materials such as coal fines, metallic chips, oil and grease, etc.

- C Collection device used.
- C Grab or composite sample (include detailed compositing information if not a grab).
- C Indicate collection of field duplicate or replicate.
- C Sediment depth used for sample (i.e., 1-3 cm; 10-15 cm etc.).
- C Sampling crew members.
- C Field measurements performed such as head space analyses and water temperature, pH, conductivity, dissolved oxygen and turbidity.
- C Any site codes used to I.D. the sample station.
- C The sediment collection form included in these methodologies (Appendix D) can be used to record the site and sample description information.

3k. Sample Preparation and Handling

This section of the sampling plan should detail the appropriate sample collection and handling procedures.

Compositing - A brief description of type of composite and compositing techniques.

Sample Volume and Container Type - The volume of sample and type of container should be listed in the plan for each sample collected. The sample container type(s) must be consistent with the container type(s) specified in the methodology. Sample size should conform to the request of the analytical laboratory receiving the sample. Sediment samples submitted to Ohio EPA's DES Laboratory for analysis should be collected into containers in accordance with Appendix F. Volatile organic samples should be collected as discrete grab samples and packed to exclude as much air space as possible. Surficial water from the sediment sample may be added to exclude all air. Because of field conditions, some samples may not yield enough material for analysis. These samples are to be handled on a case by case basis. When this or other special conditions occurs, contact the laboratory sample coordinator for advice. Proper communication between the sample collector and laboratory is essential to ensure all needs can be met.

Special Considerations - In special circumstances to meet specific data quality

objectives, sediment samples may be sieved in the field to a uniform screen or particle size. The samples should be screened to retain 0.060 mm or smaller particles. In order to calculate concentrations, the sediment volume screened and the specific gravity of the unscreened sediment must be known. Sediment samples for VOC analysis should not be screened. In addition, stream debris such as rocks, sticks and leaves should be removed from sediment samples.

Sample Labeling - All sample containers should be labeled with the site name as it appears on the laboratory submission form, the date and time of the sample collection and the name of the sample collector or other information specified by the laboratory.

Preservation - All sediment samples for chemical or bioassay analysis should be immediately chilled and stored at 4EC.

Equipment Decontamination - A description of equipment, supplies and decontamination procedures should be included. For efficiency and to reduce field decontamination activities, all sampling equipment should be cleaned and decontaminated at the laboratory or field office before going to a sample site. It is easier to clean and decontaminate as soon as possible after returning from the field. If possible, a separate set of cleaned and decontaminated equipment should be available for each sampling site.

Sample Handling and Shipment - Sample containers should be placed in clear plastic bags to minimize soiling of the shipping container and to protect laboratory personnel. Glass containers should be protected from breakage. All sediment samples should be chilled and stored in coolers or similar containers at 4EC. A description of how the samples were packed in the field, what preservatives were used and how they were shipped to the laboratory should be recorded. A chain of custody form must accompany each sample shipment.

3l. Statistics

Refer to Sediment Sampling Quality Assurance User's Guide (U.S.EPA 1985) for a more exhaustive discussion of statistical analysis of environmental sampling.

- C Determine number of samples.
- C Determine components of variance and difference of means that are significant.
- C Evaluate field duplicates/station replicates and criteria for acceptance of data.

3m. Station Replicate Samples

Station replicate samples are a complete separate collection of a sample at one site. Station replicate samples can be collected to determine the variability of the concentrations of contaminants in the sediment at a specific site and/or as an assessment of field sampling techniques.

3n. Blanks / Field Duplicate Samples

The number and type of quality control samples should be included in the sampling plan. Ten percent (10%) of the sediment samples should be collected as duplicates and 5% as blanks or equipment rinses. Field duplicate samples are collected to determine laboratory analytical variability and/or field compositing techniques and of sediment heterogeneity within a single collected sample. Duplicates are collected by "splitting" a sample that has already been collected into two identical samples for analysis. Equipment rinse samples for sediment samples are comprised of a distilled and deionized water rinse following equipment decontamination. Field blanks are samples of uncontaminated silica sand collected using the same sampling equipment and techniques as the sediment sample collections. The equipment rinse samples and field blank samples are used to demonstrate that significant amounts of contaminants are not introduced into the sediment samples from sampling equipment or sample handling.

3o. Reporting

A description of the format of the final report should be included in the sampling plan. At a minimum, the following data should be tabulated, including:

- C Calculation of mean, median, range and number of samples for large scale synoptic surveys.
- C QA/QC sample results.
- C Any deviations from the sampling plan.

Finally, the plan should be reviewed and the question answered: Will the implemented plan meet the stated sampling and data quality objectives?

4 - METHODOLOGIES

Once the sampling plan has been completed and approved, then the following methodologies should be used for the actual collection of the samples. Examples of sampling locations and sediment types are identified in Appendix G.

4a. Bathymetric Survey / Initial Reconnaissance

The starting point of the survey should be at a location that is readily identifiable in the field and that can be found and used at a later date to reproduce the sampling.

Echo sounding surveys for lakes and large rivers should be made from boats by moving slowly along parallel lines perpendicular to the river current and noting the reading on the depth finder. The proposed sampling area should be equally divided into 10 transects with depth readings taken continuously or at least every 10 feet along the transects.

Operation of the depth finder should be in accordance with the manufacturers instructions and resolution of the sounder should be set for the expected depth of the water. Sensitivity of the depth finder can be set to determine relative densities of the bottom.

The data from the survey should be recorded in field notes and the deepest area used for sample site selection.

In medium sized rivers, the river can be waded or a boat used to determine the deepest sites using a calibrated staff.

If bathymetric information is not available, samples from free flowing rivers or streams should be collected from:

- C Both banks of a relatively straight section of a stream or;
- C On the inside edges of a meander or;
- C In slack water or eddy current areas.
- C In navigation channels and the Ohio River and depending on the data quality objectives (DQOs), samples should be collected far from

the center of the dredged portion of the channel/river on alternating sides of the channel/river.

- C On medium sized and smaller rivers and streams, the use of hands, feet, fingers and toes with the "Wading Braille" technique (locating sediments by touch and feel) in conjunction with best professional judgement can be extremely effective in locating fine grained deposits. This sampling technique is the most commonly used technique by Ohio EPA for sediment sample collection.
- C Contaminant source investigations in lakes should be biased towards the down current (usually the eastern side for Lake Erie's Ohio shore) side of littoral drift.
- C Any contaminant source investigation should be biased towards sampling sediments in the most likely sink.

4b. Pre-Sample Collection

Collection of exploratory grab samples should be used to revise sampling location in the field due to unforeseen site conditions such as lack of suitable sediment for sampling.

The person collecting the samples should be open to revisions and able to adapt the sampling design to meet unforeseen site conditions while still meeting the data quality objectives of the study. The sample should contain, as a goal, more than 30% silt (<0.06 mm) or smaller particle size by volume for an acceptable sample.

Use the soil classification description on the sediment sampling form (Appendix D) to determine the sample composition.

4c. Changing Sampling Site Locations

If exploratory grab samples do not meet the criteria for the objectives of the study or the site contains more than 70 percent sand or larger particles, the location should be abandoned and another location chosen.

If no other suitable location meets the criteria, then a sample may be collected, but the results of the analysis should be annotated in the report

with a description of the sample.

The results of field screening techniques can be used to determine appropriate sampling locations.

4d. Decontamination / Cleaning / Calibration

All collection equipment and supplies such as dredges, corers, spoons, scoops and compositing trays that may come into contact with the sample should be cleaned prior to use as follows:

- 1 - Wash with Phosphate-Free Liquinox Soap
- 2 - Tap water rinse
- 3 - ASTM water (distilled water) rinse
- 4 - Methanol rinse
- 5 - Hexane rinse
- 6 - Allow to air dry
- 7 - Cleaned, decontaminated, and dried equipment should be wrapped in aluminum foil or sealed in reclosable plastic bags.

If field decontamination is necessary all Methanol and Hexane rinses are collected in appropriate containers for proper disposal at a later time.

All instruments must be calibrated before any samples are collected. All portable units must be calibrated with one or more calibration standards. A log book/record must be properly maintained to indicate which instrument or meter is calibrated, date of calibration, standard concentration, age of standards and field personnel. Good quality control requires a known standard be used to check the calibration before the sampling event. All field instruments should have a written standard operating procedure for each piece of equipment which insures consistent calibration requirements and proper maintenance.

4e. Suggested List of Supplies / Equipment for Sediment Collection

- C Sampler (Dredge, Corer, Scoop, SOD Chamber, etc.)/extra weights/extra corer inserts
- C Extra sample containers for sediment and water samples. Be prepared for unexpected additional sampling
- C Depth Finder/ Calibrated Wading Staff
- C Calibrated D.O./Temperature/Conductivity/pH Meters/Turbidity
- C Extra Rope
- C Distilled and Deionized Water Wash Bottle(s)

- C Distilled and Deionized Water for Field Blanks
- C Teflon Solvent Wash Bottle
- C Waste Solvent/Acid Collection Container
- C Towels/Cleanup Supplies
- C Plastic Trash Bags
- C Ice and Sample Cooler(s)
- C Sample Containers, Labels and Markers
- C Leather, Latex, Neoprene or Rubber Gloves
- C Rain Gear or Plastic Aprons
- C Appropriate Safety Supplies
- C Compositing Container/Bowl and Mixing Spoon
- C Rinse Bucket(s) and/or Water Pump and Hose
- C Self Sealing Plastic Bags
- C Clear tape for sealing container labels
- C Shoulder Length Neoprene Gloves
- C Chest Waders
- C Field Notebook, camera
- C PID/FID
- C Duct Tape/Electrical Tape
- C Sediment Collection forms
- C Chain of Custody Forms
- C GPS unit
- C Munsell color chart
- C Flow meter
- C Topo maps with sample locations marked
- C Copy of the sampling/ work plan

4f. Preparation for Sampling/General Methodologies

While wading in shallow water, the sediment collector should be standing on the downstream side of the collection site. Care should be taken to create the least disturbance to the sampling site as possible especially from wading or disturbance of the sediment from currents induced by wading.

When using a boat or other sampling platform, all engines should be turned off. The samples should be collected upstream from the engines or any other machinery that may release exhaust fumes/oils into the sample.

Sampling equipment and supplies that may come into contact with the sample should be cleaned and decontaminated in accordance with the decontamination procedures in the sampling plan.

In synoptic surveys, the most upstream or reference sediment site should be collected first to reduce chances of contamination between

sites. If the sediment sampling locations are located within a short distance of each other, then the most downstream sample should be collected first to avoid contamination from disturbance and resuspension of sediment due to sampling activities.

In general the finest grained sediments at each sampling location should be collected and the sample should contain, as a goal, more than 30% coarse silt (<0.06 mm) or smaller particle size by volume for an acceptable sample. Results of headspace analysis can also be used to help locate sampling sites.

Sampling in areas of aquatic vegetation where macrophyte roots or other vegetation may be collected should be avoided.

As much water as possible should be decanted from the sample prior to placement into the collection pan or bowl. Care should be taken however to avoid loss of extremely fine material from the sample during decanting.

A physical description and photograph, if possible, of the undisturbed sample should be made. The sediment collection form in Appendix D should be used to record the sample information.

For composite samples, the number of grab samples collected for the composite should be noted. The subsamples (grabs), of equal volumes, should be placed in a cleaned stainless steel or plastic basin. When all grab samples have been collected, the sample should be thoroughly mixed with an appropriate scoop or spoon. Once mixed, a physical description and photograph of the sample should be made. The sediment should then be placed into appropriate containers. Continuous mixing of the sample should occur to prevent stratification of the sample. The sediment collection form in Appendix D should be used to record the sample information.

All stones, shells, detritus, roots and other foreign matter should be removed from the sample.

Samples for analysis of VOCs should not be composited or homogenized and should be

collected first as discrete grabs. Containers should be filled according to the following sequence: Grab samples for VOC analysis first, followed by composite samples for BNA's, Pesticides/PCB's, nutrients, metals and particle size.

4g. Standard Surface Grab Collection With Scoops and Spoons

Scoops and spoons are inexpensive, widely available, non-mechanical, very portable, able to sample nearly every sediment type and easy to use.

Scoops are used to collect sediment samples primarily from shallow waters. Attaching the scoop to telescoping poles allows for collection of sediments in deeper waters.

Care should be taken when the scoop is raised through the water column or is passed through a river current during retrieval to minimize the loss of extremely fine material.

With very little experience, a sampler can “feel” the substrate with the scoop attached to a pole and quickly find appropriate material for sample collection.

Some disadvantages to using a scoop or spoon includes: limited sample volume; possible loss of very fine material during retrieval; not useable in waters greater than 4-5 feet deep.

4h. Standard Surface Grab Collection With Dredges

Surface sediment samplers (dredges) are relatively inexpensive, are widely used and available, are standard for some sampling purposes (benthos), often don't need expensive equipment to operate and come in a wide variety of sizes.

The sampler should be “set” according to the manufacturers instructions and lowered through the water column. Dredges should never be allowed to free fall into the substrate. The sampler should be carefully lowered the last few feet to minimize dispersal of fine material due to a sampler induced shock wave.

In shallow waters, some samplers can be pushed directly into the sediment. Five and ten foot extension handles can be attached to Eckman dredges for sampling in shallow waters to plunge the sampler into the sediment. These handles can minimize some of the limitations of the dredge.

The sampler is then tripped.

The sampler should be slowly raised through the water column and placed in an appropriate container (see the compositing section below). If an insufficient or improper sample is collected, additional weights should be added (if appropriate) to the sampler to allow deeper penetration into the sediment.

If additional weights do not help in the collection of a sample, then the sampling equipment and techniques should be reevaluated for the type of sediment encountered.

For compositing, a minimum of three to five grab samples (as near the same volume as possible) from a site should be taken and thoroughly mixed. An aliquot of that composite should be collected and submitted as the sample for the site.

Some disadvantages to the use of surface sediment samplers (dredges) include: shallow depth of penetration; possible shock wave and loss of very fine grained surface deposits; potential for water column contamination and nearby downcurrent sediment redeposition; loss of depth profile; not appropriate for waters with current (sampler drifts in current, "lies down" and can't be triggered); larger materials such as twigs and stones prevents jaw closure; probable loss of some water soluble and volatile organic compounds; and it is possible to dilute the toxic pore water with relatively clean surface water (which is important in conducting sediment bioassays).

4i. Standard Core Collection

Sediment corers are usually simple inexpensive sampling devices, are manufactured in a variety of materials, can collect samples at depth, can maintain a more representative vertical profile of the sediment stratigraphy, create less disturbance by shock waves and can collect more highly

consolidated deposits.

Sediment corers are slowly lowered to the substrate (gravity corers are released at the water surface and allowed to free fall) and simply allowed to penetrate the sediment under the samplers own weight or pushed or vibrated (vibro-core) into the sediments. Corers can be as simple as homemade tubes of steel, plastic or glass.

Commercial corers often contain core catcher inserts (also known as chinese fingers or eggshells) and one-way valves that allow the sample to enter the tube, but not exit and to hold it in place. Inserts should not be reused between sample locations unless decontaminated.

Inserts made of plastic should not be used when collecting samples for organic analysis. Upon retrieval, the corer can be disassembled (e.g., split spoons, some core tips unscrew) and the sample laid in a container or a prepared decontaminated surface for further processing.

Cores from simple tubes and most other corers often drop out or can be pushed out with a clean rod.

Plastic or thin walled metal corers (or core liners) can be cut, the ends capped, secured with tape and the entire segment sent to the lab. This process and the split spoon sampler reduces contamination from one segment to another in vertically stratified samples.

Detailed description of a vibro-core collection is included in Appendix A.

Some disadvantages to the use of sediment corers include: they do not work well with sandy sediments; they collect limited sample volume and very small surface area; they sometimes require expensive and bulky equipment to work in deeper waters and sediments.

4j. Other Types of Collection

In some cases, sediment can be collected directly from the substrate by a diver using SCUBA gear or supplied air.

C The sediment can be collected directly into the

sample container or placed into the container by the diver with a scoop and sealed and composited at the surface.

- C The diver should be downstream of the sample site and should use caution not to disturb the fine grained sediment at the substrate surface.

Coffer dams can be used in very small streams. Coffer dams are temporary barriers that allow a small segment of stream to be isolated from the main water body and the isolated stream segment de-watered. After de-watering, the sediment inside the coffer dam can be collected with a scoop similar to a soil sample.

- C The coffer dam can be made by placing a 6" diameter or larger pipe on the stream bottom parallel to the stream current. This reduces eddy currents and possible scour of the sediment when installing the pipe as a coffer dam.
- C Quickly tilt the pipe vertically so the top of the pipe is above the water surface.
- C Care should be taken to avoid washing fines from the sediment surface during installation of the pipe.
- C Once in place, the pipe should be pushed into the substrate with a circular back and forth motion.
- C Water inside the pipe is removed by a pump or by bailing.
- C The sediment inside the pipe can then be sampled with a simple scoop.
- C Sieve samples for special circumstances. Measure the volume sieved and the specific gravity of unsieved sample to calculate concentrations.

4k. Compositing

Preferred composition of the compositing container:

- C a plastic container for metals analyses
- C a glass container for all types of analyses
- C a stainless steel container for organics analyses
- C a solid Teflon container for all types of analyses (high costs usually prohibit its use)

Disposable aluminum trays are acceptable compositing containers provided blank samples or equipment rinses are collected from it prior to use.

After a description of the sample is made, the sediment is thoroughly homogenized with a spatula or similar device comprised of a material appropriate for the analysis performed. A thoroughly homogenized sample is uniform in color, consistency and water content. Care should be taken to avoid spilling fines and interstitial water during mixing.

Sampling equipment and supplies do not have to be cleaned between subsamples of a composite sample at a site. Equipment and supplies must be decontaminated and cleaned between station replicate sample collection and collections at different sites.

All composite samples should be identified as to the method of sample collection, depth and volume of each discrete sample and the number of samples per composite.

4l. Sample Preservation

All sediment samples for chemical, physical and bioassay analysis should be cooled to 4EC as soon as possible after collection.

4m. Holding Times

Samples for organic analysis should be extracted within 14 days. Samples for metals, except for mercury, must be analyzed within six months. Sediment samples for mercury and nutrients must be analyzed within 28 days.

4n. Other Data Collection

Field measurements for temperature, conductivity, pH and dissolved oxygen should be collected from the water column within one meter of the sediment prior to sediment sample collection. Depth profiles (at least surface, mid-depth, bottom) for these parameters should be made in waters that are too deep to wade.

The sampling location (with sufficient detail to allow a revisit to the same sample location) including latitude and longitude, river mile (if available), a brief description of the sampling site and information about unusual conditions should be recorded for each location. A hand drawn map of the sampling site showing landmarks and depicting the sample location (including

measurements from trees, etc.) can be very effective in re-locating the exact sampling spot.

4o. Sample Labeling / Shipping / Paperwork / COC

For samples submitted to the Ohio EPA laboratory, procedures are the same as described in Part III of the Manual of Ohio EPA Surveillance Methods and Quality Assurance Practices Volume I (1991). This manual should be used as guiding principles for the information needed. Specific procedures or forms should adhere to any Administrative Order, contract or sampling plan directive for samples submitted to non-Ohio EPA laboratories.

5 - DATA REPORTING AND STORAGE

5a. Data Reporting

The data should be reported by the lab on a dry weight (ug/g or mg/kg) basis.

Information to be included in any report of the data include: rationale for site, sampling equipment and analysis selection; a description of how the sample location was found and recorded; a map (preferably a 7.5 minute USGS Quad) of the study area showing the sampling locations (Latitude/Longitude and PEMS River Mile); sampling dates and type of sampling equipment and methodologies used; sample handling and preservation; sample COC; summary of QA/QC samples; applicable statistics as identified in the sampling plan. Analytical data reporting sheets should include the sampler's name, station, sample location, sample type, county, sample number, collection date and time, date the sample was received in the laboratory, date analyzed, analytical methodology, data qualifiers, Method Detection Limit (MDL) and Practical Quantitation Limit (PQL). In addition to a list of parameters for analysis, any comments need to be documented.

5b. Data Storage and Retrieval

Analytical data is to be entered into an electronic database and include River Code, River Mile, Location Description, Ohio EPA District, Latitude, Longitude, STORET number, Waterbody ID number, Ecoregion, if the location is a Reference Site and collection information such as sampler type, composite or grab, and depth of sample.

APPENDIX A - Collecting Sediment Samples by Vibro-coring (Pole or Submersible)

Either of two types of vibro-coring systems:

A Rossfelder designed, submersible vibro-coring system as used on the R/V Mudpuppy (see EPA/GLNPO SOP); or

A Pole vibro-coring system per AScl design, consisting of: electric vibrator motor (12 V DC) and mounting plate with socket for attachment of 2" diameter extension poles; two, 12 V DC storage batteries with charger; core tube adapter and clamp with check valve and retrieval lines attached; 2-10 ft. extension poles, 6.5 ft. (2 meter) lengths of 2" diameter core tube (CAB or cellulose acetate butyrate polymer) with CAB core catchers attached, 2" diameter PE (polyethylene) end caps; duct tape, marker pens, portable drill and 1/4" bit; tube cutter tool; glass or polypropylene sample bottles; field crew of at least 2.

A.1 Collecting the Core

1. Locate the sampling station with an appropriate field positioning system that provides suitable accuracy (± 6 to 15 ft.).
2. Measure the water depth using appropriate means, such as a sounding line, marked pole or fathometer.
3. Check for secure attachment of the retrieval lines to the core tube mounting clamp.
4. Insert a 6.5 ft. length of 2" diameter CAB core tube (core catcher end down) into the mounting clamp and tighten the four wing nuts securely by hand. Make sure clamp is tightened evenly.
5. Choose an extension pole of appropriate length (water depth or longer) and insert it into the mounting plate socket; secure it using a 1/4" bolt and locknut.
6. Slip the flared lower end of the extension tube over the check-valve end of the core

tube adapter, and hold it on by applying upward tension on the retrieval lines. Lower the system vertically (CAB tubing first) into the water to the bottom. Press and vibrate tube into the sediment until it is inserted 6 ft., or until refusal occurs. Note insertion length by markings on extension pole.

7. Disengage the extension pole and stow on board sampling vessel.
8. Retrieve the core tube containing the sample by pulling on the two retrieval lines, either manually, or by using a davit mounted hand winch.
9. With tube and barrel held vertically in the boat, drill hole in tube just above the top of the sediment column to drain off water.
10. Cut off the tube just above the sediment surface and cap both ends.
11. Label the tube lengths with sample station ID codes using a permanent marker; make sure the upper ends are marked as such.
12. Stow core within a cooler or enclosed box with bag ice. Transport ashore for processing as soon as possible.

A.2 Processing the Core

The sediment core is usually processed in a nearby field facility in order to describe its structure and create subsamples for chemical analysis. This is important to document the core content and to maintain sample quality. Both the 2" pole vibro-cores and the 4" submersible vibro-cores, contained and transported ashore in CAB plastic tubes after sampling, are processed in the same way. First, cut off, cap and tape the cores in sections no longer than 48", and preferably 40" (about 1 meter) in length. This

length fits onto a stainless steel tray on the core processing table, and can be photographed conveniently in only three frames of film. Make these core cuts with either a hacksaw or the vibrating cutter tool described below. When sub-sampling the core later on, take care not to include any sediment from this cut surface, or any plastic chips from the saw cut.

Next, cut the CAB core liner (filled with sediment) lengthwise along opposite sides of the 40" section (See Summary Diagram below, Step 1.). Note: cut through the liner wall without cutting significantly into the sediment core itself. Disturbed sediment adjacent to the liner wall should not be sampled anyway, but it is important not to contaminate the undisturbed interior of the core with plastic chips or other debris from the cutting process. If, before coring, the outer wall of the CAB liner (1/16" thick) is scored or pre-cut halfway through with a circular saw or other tool, then the final cut during processing can be made, with a razor knife. However, CAB plastic is very tough, and cutting with a razor knife can be dangerous and difficult to control without cutting into the core. The best hand tool available for cutting hard plastic liners is an electrical vibrating or "reciprocating" saw of the type used in industry to cut sheet metal or in medical practice to cut off plaster casts. When used with a blade guider the cut depth can be controlled so as to barely cut through the liner walls. The cuttings tend to form ribbons rather than chips, which helps in avoiding contamination of the sediment inside. Also, the vibrating blade is much safer to use than a conventional saw blade, since it does not readily cut soft material such as skin.

Once the liner wall is cut through along opposite sides (top and bottom of the horizontal core) , use a flat, thin blade of rectangular shape to cut the sediment core lengthwise into two half-cylinders, using a series of vertical cuts along the core's radial axis (Step 2, below). Vertical cutting in discrete steps, rather than "dragging" the blade through the core, insures that the layered structure of the core is not obscured, and that contaminants are not spread across layers. Between each vertical cut, wash and scrub all adhering sediment off of the blade in a bucket of clean tap water. Note: it is usually not practical to decontaminate the blade fully after each cut, but

any chance of contaminant carryover between zones can be minimized by cutting through the less oily parts of the core first, (it helps if the blade is wet when cutting through oily silt or stiff clay sediments, which tend to adhere). A cleanly cut surface is best for documenting core structure.

Arrange the two half-cylinders of the core section side-by-side, with the cut surfaces facing up (Step 3, below). Extend a tape measure along them, starting at the original top end of the core. Photograph the core in color with a track-mounted 35mm camera. With 160 watts (4, 4' lamps) of fluorescent light, 200 speed film is suitable for good results. Insure that the wet surface of the core does not reflect light directly into the camera lens. A polarizing filter helps to reduce reflectance off the wet core surface. Photograph the core section in overlapping frames; place a small label with core field ID number so that it appears in each frame. Advance the tape measure appropriately for any additional sections of the same core. While the core section is still intact record a general description of the core structure, noting zones of different color (consistent with the Munsell® color chart), texture, sediment type (silt, sand, clay, gravel, etc.), and apparent oiliness.

Collect each core interval, as pre-determined in the study plan, from the undisturbed core interior with a clean, stainless steel spoon or spatula. Place the sediment from an individual core interval into a clean stainless steel mixing bowl of appropriate size (bowls and spoons are precleaned according to Ohio EPA protocols). Mix the sediment with a clean stainless steel spoon thoroughly or until visually homogeneous. During this operation, remove any obviously "non-sediment" objects from the sample; bottle caps, broken glass, sticks, large rocks, etc.

Place approximately 150 ml of sediment collected from each core interval into a labeled 250 ml wide-mouth glass jar (precleaned according to Ohio EPA protocols), leaving space at the top of the bottle for later mixing (unless the samples are for volatile organics analysis, in which case the jar should be completely filled). Label each jar with a unique station identification number, with a suffix indicating the layer (X cm - Y cm) of the

sample. Record a description of the layers in each core on core Observation Log Sheets. Store the sample bottles on ice or in a refrigerator until transfer shipment to the analytical laboratories.

Summary Diagram of Core Processing Steps

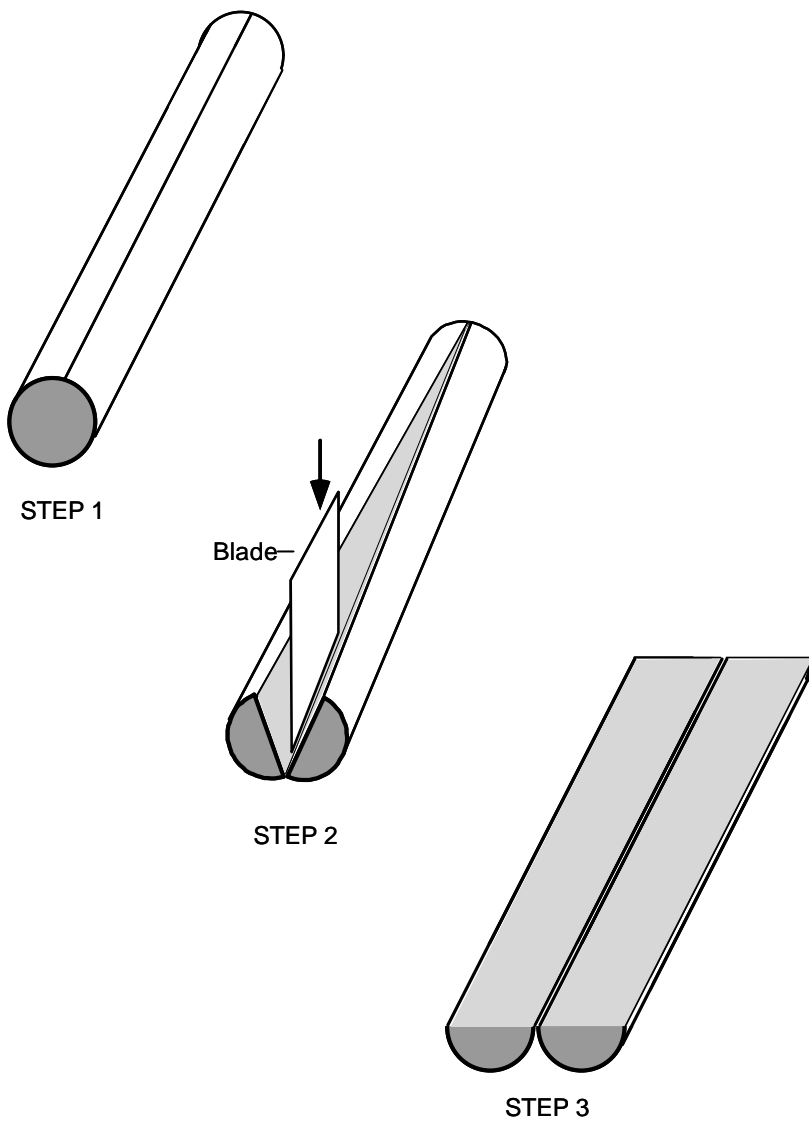

APPENDIX B - Sediment Oxygen Demand (SOD)

Sediment oxygen demand is a measure of the oxygen consumed by biochemical decomposition of organic matter in stream or lake deposits. Sediment can be divided into two broad categories, benthic and sludge according to Velz, 1970. Benthic deposits originate from runoff containing detrital matter. These deposits are characterized by Velz as "old compacted accumulations of partially stabilized organic residues and river muds". They are relatively inactive, decomposing at a very slow rate. Sludge deposits are described by Velz as "fresh organic deposits arising primarily from current municipal and industrial waste discharges". These deposits undergo "active decomposition of a semi-anaerobic character, with end products readily leaching into the overflowing stream and utilizing dissolved oxygen from that water."

Sludge deposition is a result of settling and therefore, a function of stream flow conditions and particle size. Following a period of high stream flow and accompanying scour, sediments should be allowed sufficient time to settle and accumulate prior to measuring their oxygen demand. According to Velz, sludge deposits resulting from a day or two of deposition following a storm will have a negligible effect on instream dissolved oxygen. It takes 40 to 50 days for deposition of accumulated sludge deposits to have a pronounced effect on the instream dissolved oxygen. SOD sampling locations should be in areas of extensive sludge deposits that have large (> 100%) diurnal D.O. swings.

Procedures for the Large SOD Chamber:

- C Measure and record the water velocity (2.4 inches) above the sediment surface.
 - C Calibrate the D.O. meter and measure and record the surface D.O.
 - C Record the SOD chamber number.
 - C Insert the D.O. probe into the SOD chamber.
 - C Raise the chamber top and lower the entire chamber into the water.
 - C Turn on the stirrer and verify proper operation.
 - C Adjust the rheostat to duplicate the measured stream velocity at the site.
- C Lower the respirometer to the bottom with the top extended.
 - C The ammeter (located to the left of the rheostat) displays the current in amperes which is converted to water velocity by using the graph in Figure 1. Lower the chamber top to seal the chamber. Record the water depth.
 - C Record the starting time and initial D.O. concentrations. If a D.O. meter chart is being used, the starting time should be marked directly on the chart paper.
 - C Manual readings should be taken every five minutes and adjusted as needed depending on the oxygen uptake of the sediment.
 - C The readings are complete after D.O. concentrations decrease by 2 mg/l or after two hours (which ever occurs first).

Procedures for the Small SOD Chamber:

- C Measure and record water velocity measurements (2.4 inches) above the sediment surface.
- C Calibrate the D.O. meter. Measure and record the surface D.O.
- C Record the SOD chamber number.
- C Place the chamber in sediments.
- C If the sediments are disturbed, wait several minutes for the sediments to re-settle, then insert the D.O. probe into the chamber.
- C Make sure that no air is trapped within the chamber.
- C Turn on the chamber motor and use the rheostat to regulate the velocity to the measured stream velocity. Water velocity within the chamber is shown directly on the rheostat's dial.
- C Install a second SOD chamber adjacent to the first one and seal the bottom with a plastic lid prior to placement to exclude sediments from entering the chamber. This chamber will be used to measure the oxygen demand of the water column. If only one SOD chamber is available, use the D.O. change in dark productivity bottles for water oxygen demand.

- C Record starting time and initial D.O. concentration. If a D.O. meter chart is being used, the starting time should be marked directly on the chart paper.
- C Manual readings should be taken every five minutes and adjusted as needed depending upon the oxygen uptake of the sediment.
- C The readings are complete after D.O. concentrations decrease by 2 mg/l or after two hours (which ever occurs first).

Additional Data:

- C surface incident light radiation using a pyranometer
- C light and dark bottle productivity
- C water temperature
- C surface and bottom water turbidity
- C light reaching sediments (using a photometer and submerged cell)
- C sediment description and sample location; (see data sheet)
- C bathymetric survey results
- C water samples for BOD₂₀, cBOD₂₀, COD and Chlorophyll a

Calculations

$$\text{SOD} = 1.44 (V/A)(b_1 b_2)$$

where:

SOD = Sediment Oxygen Demand in g/m²/day

1.44 = conversion factor to convert to g/m²/day

V = volume of chamber in liters

A = area of chamber in square meters ($A = \pi r^2$)

b₁ = rate of D.O. change inside the SOD chamber

b₂ = rate of D.O. change inside the "blank" SOD chamber or dark productivity bottles.

Results should be normalized to 20°C using the following equation:

$$\text{SOD}_T = \text{SOD}_{20} / (1.065^{T-20})$$

where:

SOD_T = SOD at original temperature in EC

SOD₂₀ = SOD at 20°C

T = Temp in EC

APPENDIX C - Sample Collection for Solid Phase Sediment Bioassays

Grab samples of sediment are collected using a stainless steel dredge, corer, or scoop. A transect or grid is established at each site and sediment is collected from a minimum of three subsites. The number of subsites/site will vary (e.g., depending upon width of the waterbody, water flow patterns, size and orientation of objects at the bottom, depth of sediment). Aliquots of the top 10 centimeters (cm) from each station replicate subsite are composited to form the site sample. These aliquots should be as near the same size as possible and thoroughly mixed prior to splitting between containers for toxicity testing and chemical analysis.

The mixing must produce a homogeneous sample (i.e., uniform in color, texture, and moisture content). Separate samples are collected from reference sediment and sediment of concern sites. One reference site may be used with more than one sediment of concern site. The concept of reference and sediment of concern sites is somewhat similar to the upstream and mixing zone samples, respectively, used in effluent bioassays. The reference sediment is similar (e.g., particle size, organic enrichment) to the sediment of concern when previous physical and chemical analyses are available to assist in site selection. If the data do not exist, the reference sediment and sediment of concern should be collected from sites where it appears that similar depositional patterns have occurred.

Location of the site selected for collection of the reference sediment and overlying water is dependent upon the purpose of the test and the possibility of a point source or nonpoint source affecting interpretation of results obtained with the sediment(s) of concern. These guidelines are based upon those contained in ASTM (1994).

Overlying Water Collection: Ohio EPA rearing unit water is routinely used in the sediment bioassay as the overlying water. The EPA rearing unit water is carbon-filtered and oyster shell-filtered Columbus city tap water that has been aged at least 48 hours. This water is of an acceptable

quality to support aquatic life as shown by its routine use in our rearing units. Water from the reference site collected for use as overlying water for the sediments used in the toxicity test may be used if it better suits the project objectives. Another source of high quality water (e.g., further upstream or from a nearby watershed) may be used if water from the reference site is not available in sufficient volume or is otherwise unsuitable for use in a test.

Volumes of Sample Required and Collection Containers:

Sediment should be collected from a depth that will represent expected exposure (U.S. EPA 1994). Aliquots of sediment at each subsite are composites in a stainless steel bucket and thoroughly homogenized using a stainless steel scoop. The sample is transferred to labeled wide mouth bottles. High density polyethylene (HDPE) bottles are routinely used, but glass bottles fitted with Teflon-lined caps should be used if organic chemicals are a concern. Two HDPE bottles each containing 540 milliliters (ml) of sediment are required for each site. Four 250 ml glass bottles are required.

Overlying Water Samples (if Rearing Unit Water is not Used):

Nine gallons of water are required to overlay the sediments (three gallons per each control, reference, and sediment of concern) during the 10 day test. The water is collected as grab samples and poured into labeled 1 gallon linear polyethylene cubitainers. The stainless steel bucket used to collect the site water is rinsed with site water prior to filling the cubitainers.

Additional Information:

Samples may be collected during a rainstorm but are not collected during flood conditions. Headspace in the sample containers is kept to a minimum. Bioassay sample

containers are labeled with the sample source, date and time of collection, and name(s) of the collectors. The samples are routinely packed on water ice in insulated containers for transport.

Samples for chemical analyses should be collected in accordance with this manual from an aliquot of the sediment sent to the lab.

All samples for solid phase sediment toxicity tests are transported to the Ohio EPA Division of Environmental Services in Columbus where they are stored at 4EC prior to use in a test. Sample storage time is kept to a minimum (≤ 2 weeks) prior to use in a toxicity test, and most tests are initiated within 4 days of sample arrival.

***Hyalella azteca* Maintenance:**

Culture Vessels - *Hyalella azteca* are cultured in rectangular polypropylene pans. The start of the Ohio EPA culture was obtained from Mark Smith at the U.S. EPA EMSL-Cincinnati, Newtown, Ohio facility in July 1992. U.S. EPA (1994), EMSL-Cincinnati (1991), and methods described by Brooke et al. (1993) are the basis of the Ohio EPA culture and test methods for *H. azteca*.

The 5 liter pans are 12 inches long, 7.75 inches wide and 5.125 inches in height. Pans are filled to approximately one-half capacity with 2-3.5 liters of rearing unit water. Aeration is supplied to each pan by a small bore glass pipette connected by plastic tubing to the oil-free lab air supply. Each culture pan contains a sheet of non-bleached paper toweling substrate for the *Hyalella*. The *Hyalella* may utilize toweling as an alternative food source. The toweling is replaced when it degrades, generally each week. The pans are not routinely covered. These culture vessels are on racks in our rearing lab and receive a 16-hour light 8-hour dark photoperiod. Luminescence averages 1256 lux (range is 800-1530 lux).

Culture water is changed in each pan on Monday, Wednesday, and Friday. When working with mature adults and intermediate-sized subadults, the water is changed by pouring old water through stacked number 30 (0.60 mm mesh) or 40 (0.425 mm mesh) and number 60 (0.25 mm mesh) stainless steel U.S.A. standard testing sieves meeting ASTM E-11 specification. The number

30 or 40 sieve retaining the larger organisms is then back washed with new water to flush these larger adult or subadult organisms into a clean culture pan. The number 60 sieve will retain any new young. These newly-hatched animals of a known age range are placed into their own culture by backwashing the number 60 sieve directly into a clean culture pan. The next time culture water is changed, the two to three day old animals are collected with a number 60 sieve and divided between two culture containers of 300 animals each to facilitate growth and diminish competition for food. When the *Hyalella* reach 15 days or older, too old for use in tests, young within seven days of age are combined and 300 animals are reserved for breeding purposes. If a reproductive count is desired, the young in the number 60 sieve are first rinsed into a large glass culture dish and counted on a lighted surface before being placed in the new culture pan. Culture pans are labeled with the age of organisms they contain. To culture the younger animals, number 50 (0.30 mm mesh) and/or 60 sieves are used when changing the water.

A glass pipette (3 mm bore size or greater) is used to facilitate counting and transfer of the juveniles. Any culture thinning or other handling of the older organisms (adults or intermediate subadults) requires a glass pipette of at least 5 to 6 mm bore size. Cultures are kept for approximately 90 days then are discarded unless needed for more production or initiating/supplementing a back-up culture.

Feeding - The *Hyalella* cultures are maintained on a diet of Cerophyl and Tetramin flake fish food. Five grams of each ingredient are added to one liter of deionized water. The amount of each solid ingredient is weighed on a Mettler AE 163 balance. The mixture is blended for approximately 4 minutes on a medium setting to mix and chop up the food. Solids content of this food is approximately 9.1 g/L \pm 10 % (range 8.2-10 g/L). Feeding rate is 2.5 ml food per liter of culture water. Typically, each culture pan receives 5 ml of food solution once per day on weekdays and for convenience, once per day on weekends when toxicity tests are being conducted. The stock food container is gently agitated prior to each use and as needed during feeding. The food container is stored in a

refrigerator at 4EC between uses. Food not used within a 30-day period is discarded.

The Ohio EPA Division of Environmental Services should be contacted for revisions or updates to the sediment bioassay procedures.

APPENDIX D - Standard Sampling Form

Ohio EPA Sediment Data Collection Sheet

Project: _____

Collection Date: _____ Collection Time: _____

Collector(s): _____

Weather Conditions: _____

Sample Location Description (Provide Diagram of Sampling Location(s) on opposite Side) :

Waterbody Name: _____ River Mile Location: _____

Latitude: _____ Longitude: _____

Sample Site Description: _____

Ambient Site Information (water):

Conductivity _____ Dissolved Oxygen _____ pH _____

Temperature _____ Current Velocity _____

Sediment Collection Information:

Water Depth Above Sample: _____ Sediment Sample Depth: _____

Collection Device: Scoop _____ Eckman Dredge _____ Corer _____ Other _____

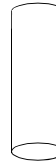

Sample Type: Grab _____ Composite: _____

Sample Replicate Collected? YES or NO Sample Duplicate Collected? YES or NO

Replicate ID/Name: _____ Duplicate ID/Name: _____

Sample Information:

Sediment pH (undisturbed) _____ Sediment pH (post-homogenization) _____

Color (Munsell Soil Color Chart Number): _____

Texture (particle size description): _____



Odor: _____

Additional Comments: _____

- Sand** - Particles 0.06-2.0 mm in diameter, possessing a gritty texture when rubbed between fingers. Loose materials (not cohesive) that often cannot be molded into shapes (non-plastic).
- Silt** - Particles 0.004-0.06 mm in diameter, generally fine material possessing a greasy or smooth, talc-like feel when rubbed between fingers. Non-plastic and not cohesive.
- Clay** - Particles less than 0.004 mm in diameter, which forms a dense, gummy surface that is difficult to penetrate with tools (hardpan). Clay is both plastic and cohesive.
- Marl** - Calcium carbonate, usually greyish-white, often containing fragments of mollusc shells.
- Detritus** - Dead, unconsolidated organic material including sticks, wood, leaves, and other partially decayed coarse plant material.
- Peat** - Partially decomposed plant materials characterized by an acidic pH; parts of plants such as Sphagnum moss sometimes visible.
- Muck** - Black, extremely fine, flocculant material composed of completely decomposed organic material (excluding sewage).
- Sludge** - Organic matter that is decidedly of human or animal origin.

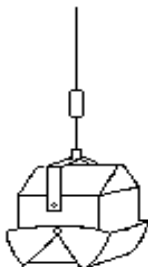
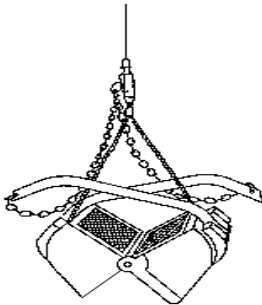
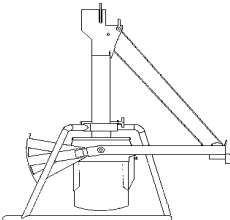
APPENDIX E - Table of Sediment Sampling Equipment

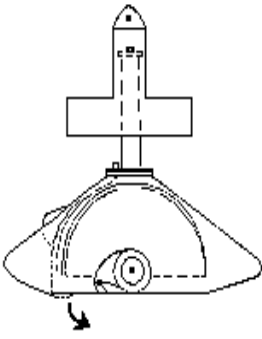
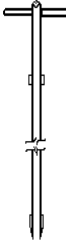
TYPE	MODEL	CURRENT	SUBSTRATE TYPE	REMARKS	ILLUSTRATION
GRAB	Spoon Scoop	Zero to Slight	All	<ul style="list-style-type: none"> C Use only in relatively calm and shallow water. C Relatively little sample disturbance. C Simple and inexpensive C Fines may washout when retrieved through water column 	
GRAB	Eckman (Birge)	Zero to Very Slight	Clay and Silt	<ul style="list-style-type: none"> C Use in relatively calm water. C Pebbles and branches may interfere with jaw closure C Excellent jaw shape and cut. C Relatively little sample disturbance. C Poor stability. Light weight allows for tendency to "swim" in a current. Sometimes causes miss triggers. C 0.02 m² sample area. C Weight with sample is 10 kg. 	
GRAB	Petite Ponar Peterson	Zero to Very Slight	Clay to fine gravel	<ul style="list-style-type: none"> C Need relatively calm/sheltered waters. C Good stability. C Poor jaw shape and cut. Sample disturbance. C Less washout if extra weights are used. C More cumbersome than an Eckman; requires a winch. C 0.1 - 0.2 m² sample area. C Weight with sample is 30 - 50 kg. 	
CORE	Box	Zero to moderate	Clay to sand	<ul style="list-style-type: none"> C Difficult to handle. C Large sample size. C Requires boat/barge with winch. C Rectangular shaped box. 	

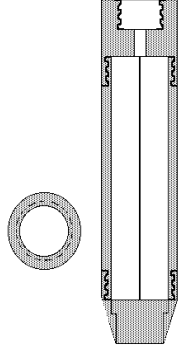
TYPE	MODEL	CURRENT	SUBSTRATE TYPE	REMARKS	ILLUSTRATION
GRAB	Shipek	Zero to strong	Clay to gravel	<ul style="list-style-type: none"> Ⓒ Requires boat/barge with winch (mini shipek can be used manually). Ⓒ One of the most reliable in terms of triggering, stability, washout, and leaching. Ⓒ Excellent jaw shape and cut. Extremely clean cutting action. Ⓒ 0.04 m² sample area. Ⓒ Weight with sample is 60 - 70 kg (mini shipek weight with sample is 20 - 30 kg). 	
CORE	Manual	Zero to strong	Clay to sand. Inserts needed for sandy samples.	<ul style="list-style-type: none"> Ⓒ Recommended for use in shallow water. Ⓒ Deployed by hand or by driver (hammer). Ⓒ Extension handles can be used for deeper waters. 	
CORE	Coring Tubes	Zero to moderate	Clay to sand. Inserts needed for sandy samples.	<ul style="list-style-type: none"> Ⓒ Quick and easy. Ⓒ Relatively undisturbed sample. Ⓒ Small sample volume. Ⓒ Samples sometimes compressed. 	
CORE	Split Spoon	Zero to moderate	Clay to sand. Inserts needed for sandy samples.	<ul style="list-style-type: none"> Ⓒ Recommended for use in shallow water. Ⓒ Deployed by hand or by driver (hammer). Ⓒ Vertical profile remains intact and is visible. Ⓒ Point design can reduce sample compaction. Ⓒ Stones can interfere with collection. Ⓒ Equipment is heavy. 	

TYPE	MODEL	CURRENT	SUBSTRATE TYPE	REMARKS	ILLUSTRATION
CORE	Gravity	Zero to moderate	Silts and clays	<ul style="list-style-type: none"> C Recommended for rivers. C Depths up to 10 meters 	<p>GRAVITY CORER VALVE OPEN ON DESCENT AND CLOSED BY A TRIGGER MECHANISM WHEN CORER PENETRATES THE SEDIMENT, GENERATING PARTIAL VACUUM WHICH RETAINS THE SEDIMENT IN THE CORE LINER</p>
CORE	Phleger	Zero to moderate	Silts	<ul style="list-style-type: none"> C Good for short cores in soft sediments. C Quick and easy. C Relatively undisturbed sample. C Small sample volume. C Samples sometimes 	
CORE	KB Core	Zero to moderate	Clay to sand. Inserts needed for sandy samples.	<ul style="list-style-type: none"> C Quick and easy. C Relatively undisturbed sample. C Small sample volume. C Samples sometimes compressed. 	
In-situ	SOD	Zero to moderate	Clay to gravel	<ul style="list-style-type: none"> C For determining sediment oxygen demand. C Not for collection of sediment samples. 	

Adapted from Environment Canada, 1987; Fay, 1987; Plumb, 1981

APPENDIX F - Sediment Sample Volume and Container Type for Samples Submitted to the Ohio EPA Division of Environmental Services Laboratory

<u>Parameter</u>	<u>Sample amount</u>	<u>No. Containers</u>	<u>Container Type</u>
VOC's	60 mls by volume	1	Septum vial or 60 ml wide mouth glass with Teflon lined lid - fill to eliminate head space
BNA's	100 g	1	500 ml wide mouth amber glass with Teflon lined lid
Pesticides/PCB's	100 g	1*	500 ml wide mouth amber glass with Teflon lined lid
Metals	250 g	1	500 ml wide mouth glass with Teflon lined lid or 500 ml HDPE
Nutrients			500 ml wide mouth glass with Teflon lined lid or 500 ml HDPE
Bioassay	540 mls by volume	2	500 ml wide mouth amber glass with Teflon lined lid. HDPE may be used if organics are not a concern.
Particle Size	500 g	1	Plastic "zip lock" bag or 500 ml HDPE
All other samples (TOC, CN, etc.)		1	125 ml glass jar with Teflon lined lid. One jar for all remaining parameters.

* The analysis can be performed on an aliquot from the BNA container. Therefore, a separate container for Pesticide/PCB analysis does not need to be submitted if a sample for BNA analysis is also submitted.

BIBLIOGRAPHY

- ASTM. 1994. Standard Guide for Collection, Storage, Characterization, and Manipulation of Sediments for Toxicological Testing. ASTM E1391-94. ASTM Annual Book of Standards, 11.04.
- Blomquist, S. 1985. Reliability of Core Sampling of Soft Bottom Sediment - an *in-situ* study. Hydrobiology.
- Brooke, L.T., D.J. Call, G.T. Ankley, D.A. Benoit, C.W. West, and R.A. Hoke. 1993. A Short-term Method for Estimating the Toxicity of Solid Phase Sediment to the Amphipod *Hyalella azteca*. March Draft.
- Burton, G. A., Jr. and Landrum, P. F. 1990. ASTM Standard Guide For Collection, Storage, Characterization, and Manipulation of Sediments for Toxicological Testing.
- EMSL Cincinnati. 1991. *Hyalella azteca* Culture Standard Operating Procedure. December 199 Draft.
- Environment Canada. 1987. Sampling for Water Quality. Water Quality Branch, Inland Waters Directorate, Environment Canada, Ottawa, Canada.
- Fay, L. A. 1987. Great Lakes Methods Manual, Field Procedures, prepared for International Joint Commission Surveillance Work Group. Center for Great Lakes Area Research, Columbus, Ohio.
- Flannagan, J. F. 1970. Efficiencies of Various Grabs and Cores in Sampling Freshwater Benthos. J. Fish. Res. Board Can. 27:11691-1700.
- Hatcher, K.J. 1986. Sediment Oxygen Demand: Processes Modeling and Measurement. Institute of Natural Resources, University of Georgia, Athens, Georgia.
- Howmiller, R.P. 1971. A Comparison of the Effectiveness of Eckman and Ponar Grabs. Trans. Amer. Fish. Soc. 100:560-563.
- Indiana State Board of Health. 1982. Field and Laboratory Procedures Manual. Division of Water Pollution Control, Indianapolis, Indiana.
- Koltun, G.F. and Helsel, D. R. 1986. Influence of Size Fractioning Techniques on Concentrations of Selected Trace Metals in Bottom Materials From Two Streams in Northeastern Ohio. U.S. Geological Survey. Water - Resources Investigations Report 86-4114.
- Mudroch, A. and MacKnight, S. D. 1994. Handbook of Techniques for Aquatic Sediment Sampling. Lewis Publishers, Chelsea, Michigan.
- Mudroch, A. and Azcue, J. 1995. Manual of Aquatic Sediment Sampling. Lewis Publishers, Boca Raton, Florida.
- New York State Department of Environmental Conservation. November 1993. Technical Guidance for Screening Contaminated Sediment.
- Ohio Environmental Protection Agency. 1991. Ohio EPA Manual of Surveillance Methods and Quality Assurance Practices. Division of Environmental Services, Columbus, Ohio.

- Plumb, Russell H. Jr. 1981. Procedure for the Handling and Chemical Analysis of Sediment and Water Samples, Technical Report EPA/CE-81-1, prepared by Great Lakes Laboratory, State University College at Buffalo, Buffalo, N.Y., for the U.S. EPA/U.S. Army Corps of Engineers Technical Committee on Criteria for Dredged and Fill Material. Published by the U.S. Engineer Waterways Experiment Station, CE, Vicksburg, Mississippi.
- Rochon, Renè and Chevalier, Michel. 1987. Sediment Sampling and Preservation Methods for Dredging Projects. Environment Canada, Québec Region, Montreal, Québec, Canada.
- U.S. Department of the Interior. 1977. National Handbook of Recommended Methods for Water-Data Acquisition. Office of Water Data Coordination, Geological Survey, U.S. DOI, Reston, Virginia.
- U.S. EPA. 1994. Methods for Measuring the Toxicity and Bioaccumulation of Sediment-associated Contaminants with Freshwater Invertebrates. C.G. Ingersoll, G.T. Ankley, G.A. Burton, F.J. Dwyer, R.A. Hoke, T.J. Norberg-King, P.V. Winger, D.A. Benoit, I.E. Greer, and E.L. Brunson. Office of Research and Development, U.S. Environmental Protection Agency, Duluth, MN. EPA 600/R-94/024, June 1994.
- U.S. EPA. SAB 1992. Review of Sediment Criteria Development Methodology for Non-Ionic Organic EPA-SAB-EPEC-93-002
- U.S. EPA. September 1992. Sediment Methods Classification Compendium. U.S. EPA Office of Water (WH-556) Sediment Oversight Technical Committee. EPA 823-R
- U.S. EPA. 1988. Interim Sediment Criteria Values for Nonpolar Hydrophobic Organic Contaminants. SCD #14. U.S. EPA Office of Water Regulations and Standards, Criteria and Standards Division, Washington, DC.
- U.S. EPA. April 1988. Guidance for the Design and Execution of Sediment Sampling and Testing Efforts Related to Navigational Maintenance Dredging in Region V. U.S. EPA Environmental Review Branch, Washington, DC.(PAGE 17)
- U.S. EPA. 1986. Polynuclear Aromatic Hydrocarbon Sediment Investigation, LTV Steel Corporation, Warren, Ohio NPDES Permit No. OH0011274. U.S. EPA Region V, Environmental Services Division, Eastern District Office, Westlake, Ohio.
- U.S. EPA. 1985. Sediment Sampling Quality Assurance User's Guide. Environmental Monitoring and Support Laboratory, EPA 600/4/85/048, Las Vegas, Nevada.
- U.S. EPA. 1980. Design Manual, Onsite Wastewater Treatment and Disposal Systems. Office of Water Program Operations, Office of Research and Development, Municipal Environmental Research Laboratory, EPA 625/1-80-012, Cincinnati, Ohio.
- U.S. EPA. 1977. Methods Manual for Bottom Sediment Sample Collection. U.S. EPA, Region V, Great Lakes Surveillance Branch, Chicago, Illinois.
- U.S. EPA. 1977. Research and Development. Interim Methods for the Sampling and Analysis of Priority Pollutants in Sediments and Fish Tissue. EPA 600/4-81-055. Physical and Chemical Methods Branch, Environmental Monitoring and Support Laboratory, Cincinnati, Ohio.
- Velz, Clarence. 1970. Applied Stream Sanitation. Wiley Interscience. New York, NY.