

FINAL REPORT

Assessment of the Natural Attenuation of NAPL Source Zones and Post-Treatment NAPL Source Zone Residuals

ESTCP Project ER-200705

November 2013

Paul Johnson
Ryan Ekre
Rosa Krajmalnik-Brown
Bruce Rittman
Arizona State University

Paul Lundegard
LundegardUSA

Rob Hincbee
IST

Distribution Statement A

This document has been cleared for public release



REPORT DOCUMENTATION PAGE

Form Approved
OMB No. 0704-0188

Public reporting burden for this collection of information is estimated to average 1 hour per response, including the time for reviewing instructions, searching existing data sources, gathering and maintaining the data needed, and completing and reviewing this collection of information. Send comments regarding this burden estimate or any other aspect of this collection of information, including suggestions for reducing this burden to Department of Defense, Washington Headquarters Services, Directorate for Information Operations and Reports (0704-0188), 1215 Jefferson Davis Highway, Suite 1204, Arlington, VA 22202-4302. Respondents should be aware that notwithstanding any other provision of law, no person shall be subject to any penalty for failing to comply with a collection of information if it does not display a currently valid OMB control number. **PLEASE DO NOT RETURN YOUR FORM TO THE ABOVE ADDRESS.**

1. REPORT DATE (DD-MM-YYYY) 11-15-2013		2. REPORT TYPE ESTCP Final Report		3. DATES COVERED (From - To) 9/1/2007 - 6/30/2013	
4. TITLE AND SUBTITLE Assessment of the Natural Attenuation of NAPL Source Zone and Post-Treatment NAPL Source Zone Residuals				5a. CONTRACT NUMBER	
				5b. GRANT NUMBER	
				5c. PROGRAM ELEMENT NUMBER	
6. AUTHOR(S) R. Ekre, P. Johnson, R. Krajmalnik-Brown, B. Rittmann, P. Dahlen, P. Lundegard, R. Hinchee				5d. PROJECT NUMBER ER-0705	
				5e. TASK NUMBER	
				5f. WORK UNIT NUMBER	
7. PERFORMING ORGANIZATION NAME(S) AND ADDRESS(ES) Arizona State University Tempe, AZ 85287				8. PERFORMING ORGANIZATION REPORT NUMBER	
9. SPONSORING / MONITORING AGENCY NAME(S) AND ADDRESS(ES) Environmental Security Technology Certification Program, Program Office				10. SPONSOR/MONITOR'S ACRONYM(S) ESTCP	
				11. SPONSOR/MONITOR'S REPORT NUMBER(S)	
12. DISTRIBUTION / AVAILABILITY STATEMENT Approved for public release; distribution is unlimited					
13. SUPPLEMENTARY NOTES					
14. ABSTRACT This project demonstrated a paradigm for assessing source zone natural attenuation (SZNA) at chlorinated aliphatic hydrocarbon (CAH) impacted sites. SZNA is often used as a basis for assessing the performance and relative benefits of engineered remediation and is also a component of the cleanup strategy at CAH-impacted sites. The data-driven method anticipates that decision makers will be interested in the questions: 1- <i>Is SZNA occurring and what processes contribute?</i> ; 2- <i>What are the current SZNA rates?</i> ; and 3- <i>What are the longer-term implications of SZNA?</i> The approach uses multiple lines-of-evidence and macroscopic mass balances, and these lead to confirmation of SZNA and quantification of the total mass loss rate resulting from degradation, dissolved phase transport, and volatilization. The approach was demonstrated at three CAH impacted sites through four events per site over about three years. The mass loss rates were relatively consistent over time for each site, but varied from site to site, ranging between about 1 - 10 kg/y at two sites and as high as about 600 kg/y at the third site.					
15. SUBJECT TERMS					
16. SECURITY CLASSIFICATION OF:			17. LIMITATION OF ABSTRACT	18. NUMBER OF PAGES	19a. NAME OF RESPONSIBLE PERSON Paul C. Johnson
a. REPORT	b. ABSTRACT	c. THIS PAGE			19b. TELEPHONE NUMBER (include area code) 480-965-9115

TABLE OF CONTENTS

Tables	v
Figures.....	vi
List of Acronyms	viii
Acknowledgements.....	x
Executive Summary	xi
1.0 INTRODUCTION	1
1.1 BACKGROUND	1
1.2 OBJECTIVE OF THE DEMONSTRATION.....	1
1.3 REGULATORY DRIVERS	1
2.0 TECHNOLOGY	2
2.1 TECHNOLOGY DESCRIPTION	2
2.1.1 SZNA Pre-assessment Data Needs: Site Conceptual Model	6
2.1.2 Group I Data Collection and Interpretation: Is SZNA Occurring?.....	6
2.1.3 Group II Data Collection and Interpretation: What is the SZNA mass loss rate?	6
2.1.4 Sustainability of SZNA, Source Longevity, and Uncertainty	10
2.2 TECHNOLOGY DEVELOPMENT.....	11
2.3 ADVANTAGES AND LIMITATIONS OF THE TECHNOLOGY	12
3.0 PERFORMANCE OBJECTIVES	12
4.0 SITE DESCRIPTION	14
4.1 SITE LOCATION AND HISTORY.....	15
4.1.1 Site 1 NAS Jacksonville	15
4.1.2 Site 2 Parris Island MCRD	15
4.1.3 Site 3 Hill Air Force Base Little Mountain Test Annex	16
4.2 SITE GEOLOGY/HYDROGEOLOGY	16
4.2.1 Site 1 NAS Jacksonville	16
4.2.2 Site 2 Parris Island MCRD	17
4.2.3 Site 3 Hill Air Force Base LMTA	18
4.3 CONTAMINANT DISTRIBUTION.....	19
4.3.1 Site 1 NAS Jacksonville	19

4.3.2	Site 2 Parris Island MCRD	20
4.3.3	Site 3 Hill Air Force Base LMTA	20
5.0	TEST DESIGN	20
5.1	CONCEPTUAL EXPERIMENTAL DESIGN.....	20
5.2	BASELINE CHARACTERIZATION.....	20
5.3	TREATABILITY OR LABORATORY STUDY RESULTS	20
5.4	DESIGN AND LAYOUT OF TECHNOLOGY COMPONENTS	21
5.5	FIELD TESTING	21
5.5.1	Site 1 - NAS Jacksonville.....	21
5.5.2	Site 2 - Parris Island MCRD.....	24
5.5.3	Site 3 - Hill Air Force Base LMTA	26
5.6	SAMPLING METHODS.....	28
5.7	SAMPLING RESULTS.....	29
5.8	DISTURBANCE TESTING.....	29
6.0	PERFORMANCE ASSESSMENT	30
6.1	PERFORMANCE OBJECTIVE: DEMONSTRATE THAT SZNA IS OCCURRING.....	30
6.2	PERFORMANCE OBJECTIVE: ESTIMATE RATE OF SZNA.....	30
6.2.1	Site 1 - NAS Jacksonville.....	30
6.2.2	Site 2 - Parris Island MCRD	33
6.2.3	Site 3 - Hill Air Force Base LMTA	36
6.2.4	Vapor Flux Assessment	39
6.2.5	SZNA Mass Loss Rates from the Three Demonstration Sites.....	42
6.2.6	Sample Density	45
7.0	COST ASSESSMENT.....	48
7.1	COST MODEL	48
7.2	COST DRIVERS	48
7.3	COST ANALYSIS	48
8.0	IMPLEMENTATION ISSUES	49
9.0	REFERENCES	50
	APPENDIX A: POINTS OF CONTACT.....	A-1
	APPENDIX B: SITE 1 NAS JACKSONVILLE.....	B-1
	APPENDIX C: SITE 2 PARRIS ISLAND MCRD	C-1
	APPENDIX D: SITE 3 HILL AIR FORCE BASE	D-1

APPENDIX E: DISTURBANCE TESTING.....	E-1
APPENDIX F: SAMPLING METHODS.....	F-1
APPENDIX G: HEURISTIC SAMPLING GUIDELINES.....	G-1

Tables

Table 2.1. Group I data – Evidence that source zone natural attenuation (SZNA) is occurring. . .	3
Table 2.2. Group II Data - Information needed in addition to the Group I measurements to estimate SZNA rates.	3
Table 2.3. Group III Data - Information needed to assess the longer-term (future) effects of source zone natural attenuation on dissolved and residual hydrocarbon concentrations and compositions.	4
Table 2.4. Adjustment Factors (ψ_{ip}).....	8
Table 4.1. Overview of Demonstration Sites.....	15
Table 5.1. Site 1 Groundwater Transect Sampling Changes	22
Table 5.2. Site 1 Vapor Sampling Changes.	23
Table 5.3. Site 2 Groundwater Transect Sampling Changes.	25
Table 5.4. Site 2 Vapor Sampling Changes.	26
Table 5.5. Site 3 Groundwater Transect Sampling Changes.	27
Table 5.6. Site 3 Vapor Sampling Changes.	27
Table 5.7. Numbers of Samples.....	28
Table 5.8. Sampling Methods and Analyses.....	29
Table 6.1. SZNA Mass Loss Rate Results.....	43
Table 7.1. Estimated Sampling Costs.	48

Figures

Figure 2.1. CAH source zone conceptualization showing SZNA mass loss rate control volume in cross section view.	4
Figure 2.2. CAH source zone conceptual model showing SZNA mass loss rate control volume and sampling locations in plan and cross-sectional view.	5
Figure 4.1. Site 1 plan view and simplified geologic cross-section.....	17
Figure 4.2. Site 2 plan view and simplified geologic cross-section.....	18
Figure 4.3. Site 3 plan view and simplified geologic cross-section.....	19
Figure 5.1. Evolution of Site 1 groundwater transect sampling locations.	22
Figure 5.2. Evolution of Site 1 vapor sampling locations.....	23
Figure 5.3. Evolution of Site 2 groundwater sampling transect locations.....	24
Figure 5.4. Evolution of Site 2 vapor sampling locations.....	25
Figure 5.5. Evolution of Site 3 vapor sampling locations.....	28
Figure 6.1. Site 1 event 1 groundwater transect contour plot with collocated values of concentration as PCE (upper values; $\mu\text{g/L}$) and hydraulic conductivity (lower values in scientific notation; cm/sec). Mass discharge of 2.8 kg/y as PCE.	31
Figure 6.2. Site 1 event 2 groundwater transect contour plot with collocated values of concentration as PCE (upper values; $\mu\text{g/L}$) and hydraulic conductivity (lower values in scientific notation; cm/sec). Mass discharge of 8.3 kg/y as PCE.	31
Figure 6.3. Site 1 event 3 groundwater transect contour plot with collocated values of concentration as PCE (upper values; $\mu\text{g/L}$) and hydraulic conductivity (lower values in scientific notation; cm/sec). Mass discharge of 4.9 kg/y as PCE.	32
Figure 6.4. Site 1 event 4 groundwater transect contour plot with collocated values of concentration as PCE (upper values; $\mu\text{g/L}$) and hydraulic conductivity (lower values in scientific notation; cm/sec). Mass discharge of 2.7 kg/y as PCE.	32
Figure 6.5. Site 1 event 4 CAH flux contour plot with values of PCE equivalent flux ($\text{kg/m}^2\text{-y}$) listed at each sample location. Flux contours are normalized to the maximum point specific flux from the fourth event.....	33
Figure 6.6. Site 2 event 1 groundwater transect contour plot with collocated values of concentration as PCE (upper values; $\mu\text{g/L}$) and hydraulic conductivity (lower values in scientific notation; cm/sec). Mass discharge of 0.87 kg/y as PCE.	34
Figure 6.7. Site 2 event 2 groundwater transect contour plot with collocated values of concentration as PCE (upper values; $\mu\text{g/L}$) and hydraulic conductivity (lower values in scientific notation; cm/sec). Mass discharge of 1.4 kg/y as PCE.	34
Figure 6.8. Site 2 event 3 groundwater transect contour plot with collocated values of concentration as PCE (upper values; $\mu\text{g/L}$) and hydraulic conductivity (lower values in scientific notation; cm/sec). Mass discharge of 1.1 kg/y as PCE.	35
Figure 6.9. Site 2 event 4 groundwater transect contour plot with collocated values of concentration as PCE (upper values; $\mu\text{g/L}$) and hydraulic conductivity (lower values in scientific notation; cm/sec). Depth-to-water dropped during this event so no samples were taken at 1.5 m bgs. Mass discharge of 0.96 kg/y as PCE.	35
Figure 6.10. Site 2 event 4 CAH mass flux contour plot with values of PCE equivalent flux ($\text{kg/m}^2\text{-y}$) listed at each sample location. Flux contours are normalized to the maximum point specific flux from the fourth event.	36

Figure 6.11. Site 3 event 1 groundwater transect contour plot with collocated values of concentration as TCE (upper values; $\mu\text{g/L}$) and hydraulic conductivity (lower values in scientific notation; cm/sec). Mass discharge of 570 kg/y as TCE. 37

Figure 6.12. Site 3 event 2 groundwater transect contour plot with collocated values of concentration as TCE (upper values; $\mu\text{g/L}$) and hydraulic conductivity (lower values in scientific notation; cm/sec). Mass discharge of 590 kg/y as TCE. 37

Figure 6.13. Site 3 event 3 groundwater transect contour plot with collocated values of concentration as TCE ($\mu\text{g/L}$) (upper values; $\mu\text{g/L}$) and hydraulic conductivity (lower values in scientific notation; cm/sec). Mass discharge of 250 kg/y as TCE. 38

Figure 6.14. Site 3 event 4 groundwater transect contour plot with collocated values of concentration as TCE ($\mu\text{g/L}$) (upper values; $\mu\text{g/L}$) and hydraulic conductivity (lower values in scientific notation; cm/sec). Mass discharge of 240 kg/y as TCE. 38

Figure 6.15. Site 3 event 4 CAH mass flux contours with values of TCE equivalent flux ($\text{kg/m}^2\text{-y}$) listed at each sample location. Flux contours are normalized to the maximum point specific flux from the fourth event. 39

Figure 6.16. Vapor transect plot: Site 1: event 4 % PCE equivalent flux contours (normalized to the maximum flux location) with collocated ΔC (PCE Equivalents $\mu\text{g/L}$) and effective diffusion coefficients (values in scientific notation; cm^2/s). Mass discharge of 0.079 kg/y as PCE. 40

Figure 6.17. Vapor transect plot: Site 2: event 4 % PCE equivalent flux contours (normalized to the maximum flux location) with collocated ΔC (PCE Equivalents $\mu\text{g/L}$) and effective diffusion coefficients (values in scientific notation; cm^2/s). Mass discharge of 0.13 kg/y as PCE. 41

Figure 6.18. Vapor transect plot: Site 3: event 2 with collocated ΔC (TCE equivalents $\mu\text{g/L}$) and effective diffusion coefficients (values in scientific notation; cm^2/s). Percentage of maximum flux for each location in listed on right. Mass discharge of 0.028 kg/y as TCE. 42

Figure 6.19. Averaged CAH dissolved contaminant discharge rates vs. time for three sites sampled. Note: Site 1 and 2 and displayed on the left y-axis and Site 3 on the right y-axis. 44

Figure 6.20. Iterative sampling guideline steps at a hypothetical $\sim 100\text{ m} \times 15\text{ m}$ thick CAH source. No water is recoverable from the clay layer, so during Step 3 no sample locations are place within that layer. It should be noted that the size of this hypothetical case matches that of Site 1. 47

List of Acronyms

amsl	Above mean sea level
bgs	Below ground Surface
btoc	Below top of casing
CAH	Chlorinated aliphatic hydrocarbon
COD	Chemical oxygen demand
DCA	Dichloroethane
DCE	Dichloroethylene
DELCD	Dry electrolytic conductivity detector
Dhc	Dehalococoides
DNAPL	Dense non-aqueous phase liquid
DO	Dissolved oxygen
DOC	Dissolved organic carbon
DTW	Depth to water
EC	Electrical conductivity
ERH	Electrical resistance heating
ESTCP	Environmental Security Technology Certification Program
FID	Flame-ionization detector
ft	Feet
GC	Gas chromatography
kg	Kilogram

LMTA	Little Mountain Test Annex
LNAPL	Light non-aqueous phase liquid
MCRD	Marine Corp Recruit Depot
NAS	Naval Air Station
ND	Non-detect
NQ	Not quantified
NW	No water available for analysis
ORP	Oxidation reduction potential
PCE	Perchloroethylene
PCR	Polymerase chain reaction
SZNA	Source Zone Natural Attenuation
sq ft	Square feet
TCA	Trichloroethane
TCE	Trichloroethylene
TOC	Top of casing
temp	Temperature
VC	Vinyl Chloride
VFA	Volatile fatty acid
VOA	Volatile organic analysis
y	Year

Acknowledgements

The authors would like to thank the following for their assistance in providing access and support for the work conducted at the three field demonstration sites: Charles Cook (NAVFAC SE), Tim Curtin (NAVFAC SE), Kyle Gorder (Hill AFB Environmental Restoration), Mitch Jensen (Parsons), Mike Singletary (NAVFAC SE), and Gene Wright (Parsons).

We also thank Bridget Cavanagh (ASU) and Sean Wilson (ASU) for their participation in the field sampling events.

And finally, the authors would also like to thank the Environmental Security Technology Certification Program (ESTCP) and its review panels, especially Dr. Andrea Leeson, for funding and providing input for this demonstration project.

Executive Summary

This project demonstrated a paradigm for assessing source zone natural attenuation (SZNA) at chlorinated aliphatic hydrocarbon (CAH) impacted sites. SZNA is often used as a basis for assessing the performance and relative benefits of engineered remediation and is also a component of the cleanup strategy at most CAH-impacted sites. Thus there is a need for a well-defined and accepted assessment approach. The data-driven method anticipates that decision makers will be interested in the following questions: 1-*Is SZNA occurring and what processes contribute?*; 2-*What are the current SZNA rates?*; and 3-*What are the longer-term implications of SZNA?* The approach uses multiple lines-of-evidence and macroscopic mass balances, and these lead to confirmation of SZNA and quantification of the total mass loss rate resulting from degradation, dissolved phase transport, and volatilization. Application of the approach was demonstrated at three CAH impacted sites through four events per site over about three years. The mass loss rates were relatively consistent over time for each site, but varied from site to site, ranging between about 1 – 10 kg/y at two sites and as high as about 600 kg/y at the third site.

When applying the generalized CAH-SZNA method, it is likely that different practitioners will choose the number and locations of samples in different ways. For example, this could happen at a site over different sampling events. This then raises the question: Is the calculated SZNA mass loss rate likely to be dependent on the sampling strategy?, and if so, how should sampling plans be designed to ensure consistency in results across practitioners? As a result, the high spatial-density data collected from the demonstration sites in this project were used to examine the effect of different sampling strategies on the quantification of mass loss rates at those sites. That experience, and lessons-learned from previously published studies on this topic, were used as the basis for new proposed heuristic sampling guidelines. The hope is that these can increase sampling efficiency and confidence in the quantification of SZNA rates.

During this project, an exploratory proof-of-concept bench-scale study was also conducted to assess if “disturbance testing” could be used to determine source zone architecture features, such as dense non-aqueous phase (DNAPL) ganglia and pools, and dissolved plume-only areas. Examples of “disturbances” are localized batch injections of clean water, air, chemical oxidants, or heat into the formation. A disturbance test involves monitoring the post-disturbance chemical response in the area of the disturbance. The disturbance tests were conducted in a two-dimensional physical model with idealized DNAPL architectures. Disturbances with water injections appeared to provide useful differentiation between DNAPL-impacted and dissolved-plume only areas.

1.0 INTRODUCTION

This ESTCP project demonstrated a generalized data-driven paradigm for the assessment of source zone natural attenuation (SZNA) at chlorinated aliphatic hydrocarbons (CAHs) cleanup sites. Application of the method was demonstrated at three field sites, with multiple events per site spread out over about three years.

1.1 BACKGROUND

The selection of corrective action options at most dense non-aqueous phase (DNAPL) and light non-aqueous phase (LNAPL)-impacted sites is a non-trivial exercise, involving decision-making based on uncertain projections of technology performance and cost. In these analyses, one end-member of the spectrum of remediation options is source zone natural attenuation (SZNA), which is sometimes also referred to as source zone natural depletion (ITRC 2009). SZNA relies on unassisted natural loss processes such as dissolution, biodegradation, advection and/or volatilization to achieve source zone remediation goals. SZNA is often used as a basis for assessing the performance and relative benefits of engineered remediation, and sometimes also to define remediation end-points. SZNA is also an implicit component of engineered remediation schemes as it is relied upon to provide the reduction of post-treatment residuals.

1.2 OBJECTIVE OF THE DEMONSTRATION

The objective of this project was to demonstrate and document the use of a proposed SZNA assessment approach at CAH-impacted sites. The data-driven approach is innovative because it builds on recommendations in NRC reports (1994, 2000) and the fundamental understanding of source zone natural attenuation mechanisms, and translates those into practicable site-specific guidance. Johnson et al. (2006) proposed guidance for petroleum LNAPL-impacted sites and its application was illustrated in Lundegard et al. (2006), Lenski (2004) and Liu (2004). That work was extended in this project for applicability to CAH-impacted sites.

1.3 REGULATORY DRIVERS

Based on the authors' experience, decision-makers (e.g. regulators, project managers, members of the public) are often interested in answers to the following critical questions:

- a) Is SZNA occurring, and if so, what natural processes are contributing to SZNA?
- b) What is the current rate of source zone mass reduction associated with SZNA, and how might this change in the future?
- c) What are the longer-term implications of SZNA for future groundwater and vapor migration impacts (compounds present, their concentrations and mass discharges) at the site?
- d) Are the SZNA processes and rates sustainable?

- e) What is the projected longevity of the source zone or post-treatment residual?

2.0 TECHNOLOGY

SZNA is the final component of most remediation projects because engineered processes typically do not result in complete cleanup; SZNA is then relied upon as a polishing step for the post-engineered treatment residuals (Kavanaugh and MacDonald 1994; NRC 1994; ITRC 2002; USEPA 2003; Stroo et al. 2012; NRC 2013). As a result, being able to validate that SZNA is occurring, quantify mass loss rates attributable to SZNA, and project longevity and source zone changes with time are of interest. The SZNA mass loss rate is an important benchmark when assessing the benefits of, and selecting, engineered source zone remediation schemes, and when deciding to terminate remediation (Brooks et al. 2008, Brusseau et al. 2011).

2.1 TECHNOLOGY DESCRIPTION

The CAH SZNA assessment paradigm presented here is built on the SZNA conceptualization and calculation approach described by Johnson et al. (2006) and is structured around three groups of data collection and analyses. In brief, Group I measurements provide evidence that SZNA is occurring, Group II measurements and analyses are focused on quantifying current SZNA mass loss rates, and Group III measurements and analyses are focused on answering longer-term questions concerning the longevity of source zone impacts. Tables 2.1, 2.2, and 2.3 summarize specific data requirements for each. This section discusses each, but focuses mainly on Group II measurements and analyses, as often the immediate question of greatest interest is “*what is the SZNA rate?*”

As a data-driven, macroscopic, multiple-lines-of-evidence approach, the paradigm is consistent with the NRC (2000) philosophy. Furthermore it is complementary to existing dissolved plume natural attenuation protocols and makes use of dissolved mass flux techniques (e.g., Guilbeault et al. 2005) and the source zone evolution with time modeling work discussed above. Lundegard and Johnson (2006) demonstrated the SZNA assessment approach at a multiple-source hydrocarbon spill site. Their paradigm was adopted by the Interstate Technology Research Council (ITRC) and reframed as “source zone natural depletion” in their guidance document (ITRC 2009).

Table 2.1. Group I data – Evidence that source zone natural attenuation (SZNA) is occurring.

Data Need	Explanation
Groundwater elevations in groundwater monitoring wells	Used to determine the hydraulic gradient and the groundwater flow direction
Dissolved CAH parent and daughter concentrations in groundwater up- and down-gradient of the source zone	Increases in dissolved concentrations between up- and down-gradient wells indicate that mass removal is occurring from the source zone with groundwater flow; daughter product presence indicates that degradation is a contributing mechanism
CAH parent and daughter soil gas concentration profiles	Decreasing concentrations in soil gas with distance away from the source zone is evidence that loss via volatilization and diffusive vapor transport is occurring
<i>Other data that are not required to answer the Group I question, but could be of interest to provide additional insight or corroborative evidence of SZNA</i>	
The presence of <i>Dehalococcoides</i> or other bacteria known to perform reductive dechlorination	Reductive dechlorination is carried out by a relatively restricted range of bacteria, such as <i>Dehalococcoides</i> . Detecting these microorganisms in water or soil samples is strong supporting evidence that reductive dechlorination can occur
Water quality parameters (pH, temperature, ORP)	To determine if the environment is conducive to reductive dechlorination
Soil concentrations with time	Could provide evidence of source zone mass loss, but may not be practicable; long-term monitoring and a large numbers of samples are likely necessary to reduce uncertainty in calculations to achieve statistically significant results.
Historical trends in dissolved groundwater concentrations.	Statistically significant decreases with time across all source zone monitoring wells could be indicative of source zone mass loss, if not attributable to other changes at the site (e.g., varying groundwater levels or recharge rates)

Table 2.2. Group II Data - Information needed in addition to the Group I measurements to estimate SZNA rates.

Data Need	Explanation
Collocated effective vapor diffusion coefficients and multi-level soil gas concentrations distributed above the source zone footprint	Used to estimate source zone mass removal due to vapor diffusion of CAH parent and daughter compounds
Collocated hydraulic conductivities and dissolved parent and daughter compound concentrations along transects oriented perpendicular to groundwater flow and located immediately up- and down-gradient	Used to estimate CAH source zone mass removal carried by groundwater flow

of the source zone	
--------------------	--

Table 2.3. Group III Data - Information needed to assess the longer-term (future) effects of source zone natural attenuation on dissolved and residual hydrocarbon concentrations and compositions.

Data Need	Explanation
Source zone architecture (mass and spatial distribution)	Recent research suggests that CAH source longevity and changes with time of groundwater and vapor impacts might be projected from knowledge of the source zone architecture
Quantification of limiting reactant supply or mass needed for degradation processes	Assessment of the extent to which degradation processes are sustainable, and change with time in parent and daughter compound concentrations emitted from source zone.

In this work, CAH “source zones” are DNAPL-containing soil zones in direct contact with, or in close proximity to, groundwater as shown in Figure 2.1. DNAPL-impacted source zone soils are continuously subjected to a combination of processes, including dissolution, volatilization, and biodegradation. This leads to a depletion, or “natural attenuation”, of the hydrocarbons from these soils with time.

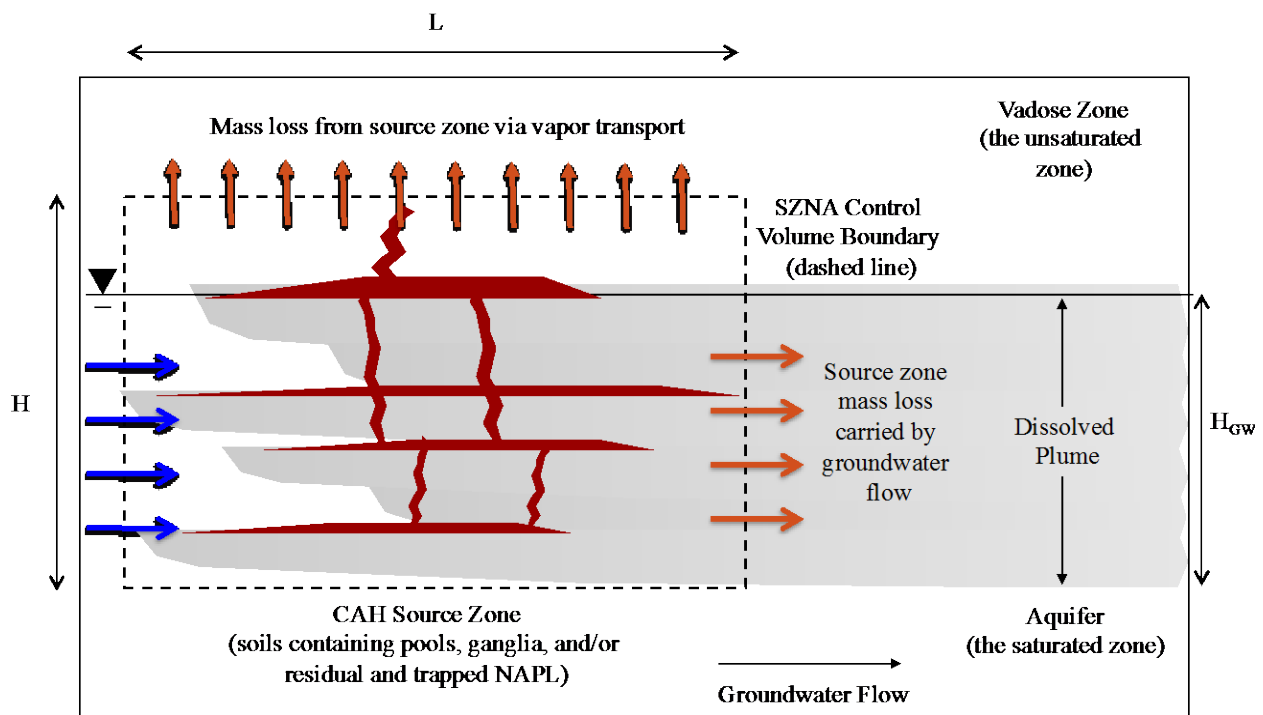

Figure 2.1. CAH source zone conceptualization showing SZNA mass loss rate control volume in cross section view.

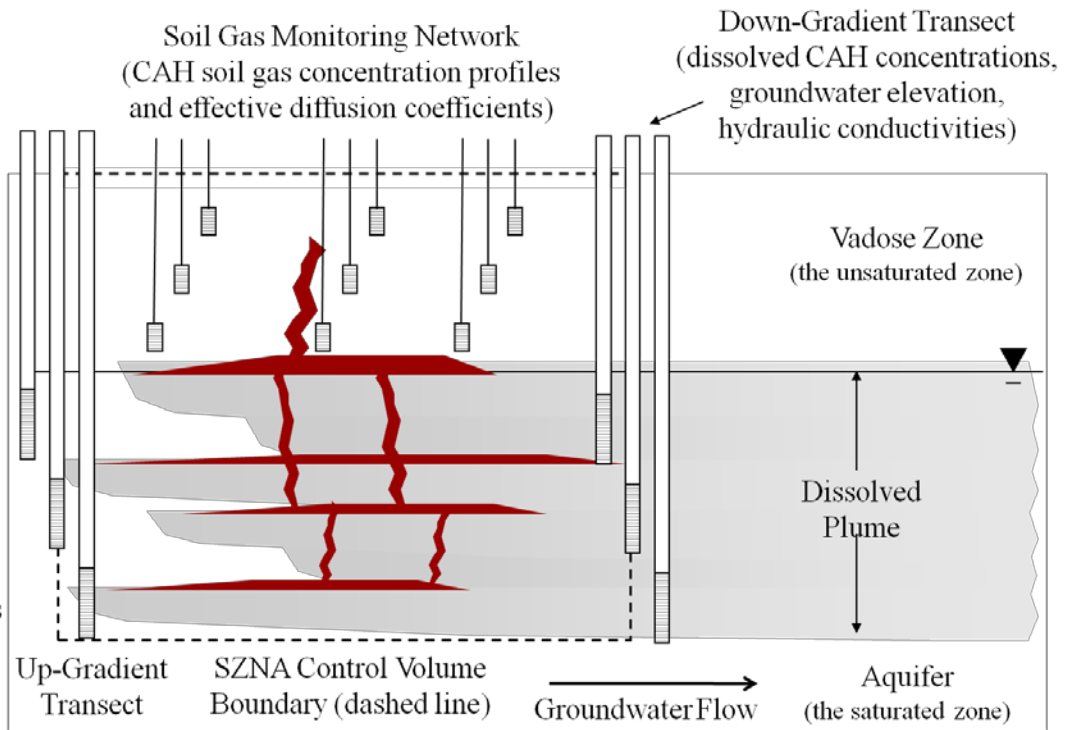
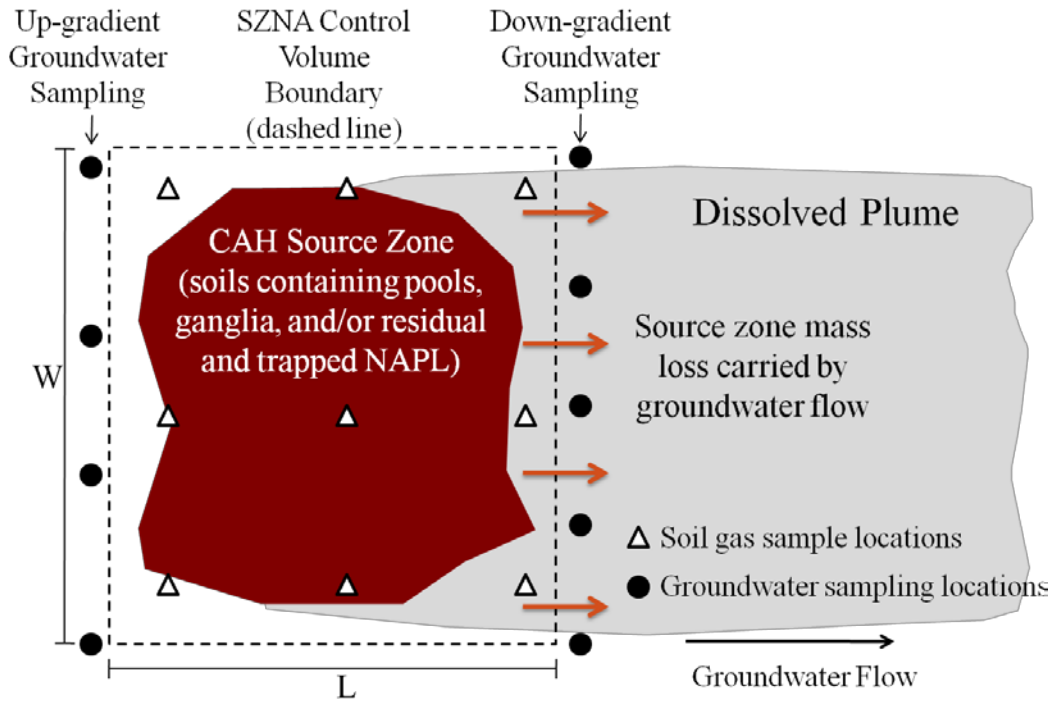

Figure 2.2. CAH source zone conceptual model showing SZNA mass loss rate control volume and sampling locations in plan and cross-sectional view.

2.1.1 SZNA Pre-assessment Data Needs: Site Conceptual Model

Prior to SZNA assessment, it is important to have formulated a site conceptual model from available site characterization data. The site conceptual model should include plan view and cross-sectional maps on which the following are depicted: (a) approximate extent of the source zone, (b) depth to groundwater, (c) direction of groundwater flow, (d) locations of all existing sampling points (including screen intervals), and (e) relevant geologic features (e.g., layers, soil type). Simplified examples are shown in Figures 2.1 and 2.2.

Delineating the location, length, width and depth of the source zone is well-accepted as being critical to treatment technology selection, design, operation and monitoring. Despite that, experience suggests that conventional sampling approaches and subsequent data reduction using randomly- or regularly-spaced sampling locations often lead to poor source zone delineation, even at the gross feature level of approximate source zone footprint and depth (Stroo et al. 2012).

A multi-depth groundwater sampling transect oriented perpendicular to groundwater flow and placed just down-gradient of the suspected source zone location is the approach recommended here for determining the width and depth of the source zone. Experiences from Guilbeault et al. (2005), Triplett-Kingston et al., (2010), and this work suggest that this approach can provide a faster, more reliable assessment of the source zone width and depth and provide valuable insight to the spatial variability (Stroo et al. 2012).

2.1.2 Group I Data Collection and Interpretation: Is SZNA Occurring?

The Group I data requirements listed in Table 2.1 include information that is typically available from routine site characterization activities and already incorporated in a site conceptual model

In most cases, a simple review of the dissolved and vapor concentration data is sufficient to answer the question “*Is SZNA occurring?*”. Higher-than-background CAH concentrations in groundwater immediately down-gradient and in soil gas immediately above the source zone are evidence of dissolution and volatilization, respectively, and CAH mass loss at some non-zero rate. Higher than background concentrations of daughter products in groundwater immediately down-gradient and in soil gas above the source, are evidence of SZNA by abiotic and/or biological processes.

2.1.3 Group II Data Collection and Interpretation: What is the SZNA mass loss rate?

A macroscopic mass balance analysis approach defines the Group II data requirements listed in Table 2.2. Following the Johnson and Lundegard (2006) approach, the SZNA rate is determined by quantifying mass transport across the faces of a control volume encompassing the source zone as shown in Figure 2.1.

The SZNA control volume is chosen in such a way that: a) it encompasses the source zone and b) the CAH mass transport across the lateral, up-gradient, and lower planes is negligible. The attractive features of this approach are:

- It is not necessary to identify or quantify individual loss mechanisms to assess the overall mass loss rate.
- It is not necessary to have detailed delineation of the source zone architecture or mass; this is known to be impracticable at most sites.
- The data needed are obtainable with conventional, and commonly used field tools (e.g., dissolved and vapor concentrations), and the analyses are not overly complex.

The control volume has a width W [m] perpendicular to groundwater flow, a thickness H [m] that encompasses the vertical extent of contamination, and a length L [m] in the direction of groundwater flow. In defining the control volume this way, one only needs to be able to quantify the mass discharges across two or three control volume boundaries: (a) the down-gradient edge of the source zone, (b) the ceiling of the control volume, and c) the up-gradient edge when there is up-gradient dissolved contamination.

2.1.3.1 Mass Loss Across Down-Gradient Edge of the SZNA Control Volume.

The net mass loss carried away from the source zone by groundwater flow, R_{GW} [g/s], is calculated from dissolved CAH parent and daughter compound concentrations and hydraulic conductivity data measured across up- and down-gradient transects of width W and height H_{GW} , and the local ground water gradient:

$$R_{GW} = \int_W \int_{H_{GW}} \sum_i \psi_i^p q_d C_d^i dydz - \int_W \int_{H_{GW}} \sum_i \psi_i^p q_u C_u^i dydz \quad (2.1)$$

Where:

- q_u, q_d = groundwater specific discharge at up-gradient and down-gradient source boundaries, respectively [$m^3/m^2 \cdot s$] = Ki
- K = hydraulic conductivity (ideally collocated with concentration values) [m/s]
- i = hydraulic gradient [m/m]
- C_d^i, C_u^i = concentration of CAH parent or daughter compound at up-gradient and down-gradient source boundaries, respectively [$g/m^3 \cdot H_2O$]
- ψ_i^p = adjustment factor for mass of daughter (i) in terms of parent compound (p) [g-parent CAH/g-daughter CAH]
- y, z = coordinates in directions perpendicular to groundwater flow (lateral and vertical, respectively) [m]

The adjustment factor ψ_i^p [g-parent(p)/g-daughter(i)] is included in equations (2.1) and (2.2) to account for Cl^- ions released to groundwater during dechlorination processes. In theory,

equations (2.1) and (2.2) could be written in terms of concentrations of all parent and daughter compounds, including Cl^- concentrations; then ψ_i^p would not be needed. Quantifying Cl^- concentration increases resulting from dechlorination, however, is often problematic in field settings because of natural background Cl^- concentrations in groundwater. Therefore, equations (2.1) and (2.2) utilize CAH concentration data only. This calculation of an “equivalent” parent compound mass loss rate was also used by Guilbeault et al. (2005) in assessing mass discharge rates from CAH source zones. Table 2.4 contains adjustment factors for the most common CAH contaminants and their daughter products. The adjustment factor is the ratio of the molecular weights of each CAH parent-daughter pair of interest.

Table 2.4. Adjustment Factors (ψ_i^p).

		Equivalent Parent Chemical (p) and its Molecular Weight [g/mole]					
		PCA (168)	PCE (166)	TCA (133)	TCE (131)	DCA (99)	DCE (97)
Measured Compound (i) and Its Molecular Weight [g/mole]	PCA (168)	1.000	NR	NR	NR	NR	NR
	PCE (166)	0.988	1.000	NR	NR	NR	NR
	TCA (133)	0.792	1.243	1.000	NR	NR	NR
	TCE (131)	0.780	1.262	1.015	1.000	NR	NR
	DCA (99)	0.589	1.676	1.348	1.328	1.000	NR
	DCE (97)	0.577	1.711	1.376	1.355	1.021	1.000
	Chloroethane (65)	0.387	2.570	2.068	2.037	1.534	1.503
	Vinyl Chloride (61)	0.363	2.653	2.135	2.102	1.583	1.551
	Ethane (30)	0.179	5.515	4.436	4.369	3.291	3.224
	Ethene (28)	0.167	5.912	4.756	4.684	3.528	3.456
Adjustment Factor (ψ_i^p) - used within the mass balance to account for chloride ions liberated and not tracked explicitly in the mass balance calculations. The adjustment factor is calculated by a ratio of the molecular weights of parent (p) to daughter (i) compound. NR = not relevant.							

Equation (2.1) allows for background contamination contributions from up-gradient sources, but often up-gradient background concentrations are negligible. Given the discrete nature of sampling data, equation (2.1) is usually approximated in practice as:

$$R_{GW}(\text{approx}) \approx \sum_n A_n \sum_i \psi_i^p i_d K_{d,n} C_{d,n}^i - \sum_n A_n \sum_i \psi_i^p i_u K_{u,n} C_{u,n}^i \quad (2.2)$$

Where the total transect area ($W \times L$) has been divided into n sub-regions with areas A_n [m^2], and:

$R_{GW}(\text{approx.}) =$ approximation of mass loss rate defined in equation (2.1) [g/s]

- $C_{u,n}^i, C_{d,n}^i$ = up and down-gradient sub-area averaged dissolved concentration for compound i for the sub-area A_n [$\text{g}/\text{m}^3\text{-H}_2\text{O}$]
- $K_{u,n}, K_{d,n}$ = up and down-gradient sub-area averaged hydraulic conductivity for the sub-area A_n [m/s]
- i_u, i_d = up and down-gradient sub-area averaged hydraulic gradient for the sub-area A_n [m/s]
- A_n = sub-area [m^2]; $\Sigma A_n = H_{\text{GW}}W$; area of transect is gridded for calculation of discharge using discrete data points

Mass discharge rates can be calculated by gridding sampling transects and applying Equation 2.2. Alternatively, the data can be entered into the Mass Flux Toolkit (GSI, 2011), which performs the calculation. It is an Excel-based tool that incorporates grid refinements with interpolation of data between grid points, using three interpolation methods (nearest neighbor, linear, logarithmic) and an uncertainty analysis that provides insight into regions that may require additional sampling.

2.1.3.2 Mass Loss Across the Upper Surface of the SZNA Control Volume.

CAH compounds can volatilize and diffuse away from source zones. The mass loss rates associated with these processes are calculated by examining vertical vapor fluxes across the upper horizontal plane of the SZNA assessment control volume.

The SZNA mass loss rate associated with vapor transport R_{vapor} [g/s] is calculated:

$$R_{\text{vapor}} = \iint_{\text{WL}} \sum_i \psi_i^p D_i^{\text{eff}} \frac{dC_{v,i}}{dz} dx dy \quad (2.3)$$

Where:

- D_i^{eff} = effective diffusion coefficient of compound i in soil vapor [m^2/s]
- $C_{v,i}$ = concentration of compound i in soil vapor [g/m^3]
- z = depth [m]
- W, L = width and length, respectively, of control volume [m]

Effective diffusion coefficients can be measured in situ as described in Johnson et al. (1998), or they can be estimated from empirical correlations, such as the Millington-Quirk expression (Millington and Quirk, 1961):

$$D_i^{\text{eff}} = D_{v,i}^{\text{eff}} + \frac{D_{m,i}^{\text{eff}}}{H_i}; D_{v,i}^{\text{eff}} = \left(\frac{\theta_v^{3.33}}{\theta_T^2}\right) D_i^{\text{air}}; D_{m,i}^{\text{eff}} = \left(\frac{\theta_m^{3.33}}{\theta_T^2}\right) D_i^{\text{H}_2\text{O}} \quad (2.4)$$

Where:

- D_i^{air} = molecular diffusion coefficient for i in air [m^2/s]
 $D_i^{\text{H}_2\text{O}}$ = molecular diffusion coefficient for i in water [m^2/s]
 θ_v = vapor-filled porosity [$\text{m}^3\text{-vapor}/\text{m}^3\text{-soil}$]
 θ_T = total porosity [$\text{m}^3\text{-voids}/\text{m}^3\text{-soil}$]
 θ_m = moisture-filled porosity [$\text{m}^3\text{-moisture}/\text{m}^3\text{-soil}$] = $\theta_T - \theta_v$
 H_i = “dimensionless” Henry’s Law Constant for compound i
 [(g-i/ $\text{m}^3\text{-vapor}$)/(g-i/ $\text{m}^3\text{-H}_2\text{O}$)]

Considering typical data availability, equation (2.4) can be approximated:

$$R_{\text{vapor}}(\text{approx}) \approx \sum_n A_n \sum_i \psi_i^p D_{i,n}^{\text{eff}} \left(\frac{\Delta C_i}{\Delta Z}\right)_n \quad (2.5)$$

Where the total surface area ($W \times L$) has been divided into n sub-regions with area A_n [m^2] and representative effective diffusion coefficients $D_{i,n}^{\text{eff}}$ [m^2/s] and vertical concentration gradients $(\Delta C_i/\Delta z)_n$ [(g/ m^3)/m]. The latter can be determined by collecting collocated but vertically off-set vapor samples and estimating or measuring the effective diffusion coefficient for that Δz_n thick interval.

2.1.4 Sustainability of SZNA, Source Longevity, and Uncertainty

The approach discussed above provides a point-in-time answer to the questions “*Is SZNA occurring?*” and “*What is the rate of SZNA?*”. It does not address the future-looking questions: “*Are the SZNA processes and rates sustainable?*” and “*What are the longer-term implications of SZNA for groundwater- and vapor migration-impacts?*” To address these questions there are additional data needs, as summarized in Table 2.3.

Some CAH SZNA processes, like dissolution and volatilization, will continue indefinitely as long as groundwater moves through the source zone and vapor concentrations in the source are greater than in the surrounding soil. Thus, the source zone mass will ultimately be depleted at some future time. This is different from petroleum hydrocarbon sites, where the long-term

progression is toward a relatively insoluble, nonvolatile, and recalcitrant residual source zone mass.

It is unknown if degradation processes will continue indefinitely as they depend on a number of factors that can change over the time frames of interest (decades to centuries). These factors include groundwater pH, temperature, reductive conditions, electron donor supply, and microbial population functionality.

Predicting the time to full depletion is challenging because the source zone mass is generally a highly uncertain quantity and the current SZNA rate is likely to decrease with increasing source mass depletion. Nevertheless, a time frame estimate can be calculated by dividing a source mass estimate by the most recently measured source zone mass loss rate. It can be argued that this estimate is very uncertain and biased low as long-term SZNA rates are likely to decline with time and the longevity estimate is only as accurate as the source zone mass estimate. Despite this, knowing whether the projected time frames are likely to be years, decades, or centuries is still useful for decision-makers to have estimated time-frames for complete natural depletion, even with high uncertainty in the estimates.

There has been significant interest and effort by researchers to link source zone architecture to longevity and future groundwater impacts through modeling (e.g., Anderson et al. 1992a,b, Lemke et al. 2004, Falta et al. 2005, Christ et al. 2006, Fure et al. 2006), as well as empirically projecting future trends using recent multi-year SZNA historical data. If those efforts prove successful in the future, then those tools would be valuable and could provide an additional line of evidence for SZNA assessment.

Finally, it should be noted that uncertainties inherent in the SZNA rate estimation are difficult to quantify. This reflects uncertainties in all of the measured quantities used in the discharge calculations, especially analytical error in concentration data (20%), errors in hydraulic conductivity estimation (2X to 10X), errors in measurement of hydraulic gradient (2X), differences in results for different data interpolation methods (log, linear, nearest neighbor) (2X to 5X), and uncertainty related to the spatial resolution (sampling density) of transect data. Some have suggested that uncertainty caused by the latter increases with decreasing spatial resolution of transect data and sampling densities of 1-7% may be required to achieve accurate discharge estimates, where sampling density is defined as the areal percentage of the transect sampled (e.g., Kubert et al. 2006, Li et al. 2007, Mackay et al. 2012). This issue is discussed in more detail in §6.2.6 and Appendix G.

2.2 TECHNOLOGY DEVELOPMENT

Discussion and study of SZNA is present in the literature, albeit to a lesser extent than for dissolved plume natural attenuation. Research has focused on field evaluation of loss mechanisms (e.g., Bekins et al. 2001, Cozzarelli et al. 2001, Sihota et al. 2011), aggregate mass loss rates (e.g., Guerin and Rhodes 2000, Lundegard and Johnson 2006, Basu et al. 2006, Beland-Pelletier et al. 2011, Brusseau et al. 2013), and source zone dissolved concentration vs.

time data to calculate empirical decay rates (e.g., Newell et al. 2006). Other research has focused on developing source zone depletion algorithms to predict dissolved plume behavior, and those are usually linked either to mechanistic modeling of the loss processes (e.g., Abranovic et al. 2001, Brauner and Widdowson 2001, Chapelle et al. 2003, Parker and Park, 2008) or source zone architecture (e.g., Falta et al. 2005, Fure et al. 2006).

This project seeks to demonstrate how to assess CAH source zone natural attenuation on a site-specific basis. As discussed above, it extends the Johnson et al. (2006) data driven, multiple lines of evidence approach for assessing SZNA for petroleum impacted LNAPL sites. It builds on the fundamental understanding of SZNA mechanisms and translates those into practicable site-specific guidance. There are two major areas where differences from the original Johnson et al. (2006) approach occur. The first is in the use of microbial degrader-specific analyses, as petroleum hydrocarbon degraders tend to be ubiquitous (and so their presence is not tested for in Johnson et al. 2006), whereas chloroethene/chloroethane degraders are not (and therefore should be tested for). The second is in the design of the Group III data collection. Group III measurements for petroleum-impacted sites rely on bench-scale weathering tests to project long-term weathering of residual hydrocarbon mixtures and the corresponding trends in groundwater quality. For chlorinated solvent-impacted sites, compositional shifts are of less interest because there are few components in chlorinated solvent-impacted sites and typically all are relatively soluble. Thus the concept of a long-term non-soluble/non-degrading residual is not applicable as it is in the petroleum hydrocarbon case, and therefore, bench-scale weathering tests likely have less relevance. Of more interest for chlorinated solvents is the sustainability of the processes (i.e., is there a sustainable electron donor supply) and how will the contaminant discharge measured in the near-term change in the long-term as dissolution progresses.

2.3 ADVANTAGES AND LIMITATIONS OF THE TECHNOLOGY

The method of SZNA assessment demonstrated in this study is applicable to a wide variety of field settings. As a data-driven approach, few assumptions are required, in contrast to modeling-only based approaches. If representative data are obtained, results of the assessment can be expected to reasonably represent actual SZNA mass loss rates in the field. It is not necessary to identify or quantify individual loss mechanisms to assess the overall mass loss rate. It is also not necessary to have detailed delineation of the source zone architecture or mass. The data needed are obtainable with conventional, and commonly used field tools (e.g., dissolved and vapor concentrations), and the analyses are not overly complex.

A disadvantage of the proposed method of SZNA assessment is that the source zone mass loss rate is specific to the point in time when the data are collected. It is not clear yet how to extrapolate the point-in-time results to future site conditions.

3.0 PERFORMANCE OBJECTIVES

Performance objectives for this study are conceptually different than those that would be established for the evaluation of an engineered remediation technology. There are no *a priori*

target end-point criteria. The objective of this project was to demonstrate and document the use of a proposed SZNA assessment approach at CAH-impacted sites. Thus the performance objects focus on preparation and application of the SZNA assessment guidance as discussed below in Table 3.1.

Table 3.1. Performance Objectives.

Qualitative Performance Objectives			
Performance Objective	Data Requirements	Success Criteria	Results
Revision of the SZNA approach for chlorinated solvent impacted sites	None	Revised guidance is prepared and published in peer-reviewed literature and the guidance is practicable for RPMs	Journal manuscript has been submitted and conditionally accepted, subject to revisions.
The application of the SZNA assessment approach is illustrated	Group I and II data as specified in the SZNA protocol	Group I and II data are collected, reduced, and used to answer the Group I and II questions	Site 1: success Site 2: success Site 3: success

Table 3.1 cont'd

Quantitative Performance Objectives			
Performance Objective	Data Requirements	Success Criteria	Results
Answer Group I Question at Field Site(s): Is SZNA occurring?	Group I Data as defined in Table 2.1	Data are sufficient to establish if SZNA is occurring	Site 1: success Site 2: success Site 3: success
Answer Group II Question at Field Site(s): What is the current rate of SZNA?	Group II data as defined in Table 2.2	Data are sufficient to calculate SZNA rate	Site 1: success Site 2: success Site 3: success

4.0 SITE DESCRIPTION

The CAH SZNA paradigm was applied to three field sites: Naval Air Station (NAS) Jacksonville PSC48, Parris Island Marine Corp Recruit Depot (MCRD) Site 45, and Hill AFB Little Mountain Test Annex (LMTA), herein referred to as Site 1, Site 2, and Site 3. Basic information for each is given in Table 4.1.

Table 4.1. Overview of Demonstration Sites.

	Site 1	Site 2	Site 3
Location	NAS Jacksonville PSC48 Building 106	Parris Island MCRD Site 45	Hill Air Force Base LMTA
Depth to Groundwater	~1.8 m bgs (~6 ft bgs)	~0.9 m bgs (~3 ft bgs)	24 - 45 m bgs (80 - 150 ft bgs) (large elevation changes with time)
Geologic Setting	Interbedded sands, silts, and clays	Interbedded sands, silts, and clays	Fractured Rock
Source of Contamination	Former dry cleaner facility	Former dry cleaner facility	Industrial water treatment sludge drying beds
Chemicals Present	PCE, TCE, DCE, VC	PCE, TCE, DCE, VC, weathered LNAPL	PCE, TCE, TCA, DCE, VC
Approximate Source Zone Width	105 m (350 ft)	46 m (150 ft)	400 m (1300 ft)
Depth of Contamination	0 – 18 m bgs (0 – 60 ft bgs)	0 – 5.5 m bgs (0 – 18 ft bgs)	0 – 91 m bgs (0 – 300 ft bgs)
SZNA Assessment Period	1.8 y	3 y	2.75 y
Sampling Events	4	4	4

NAS – Naval Air Station

MCRD – Marine Corp Recruit Depot

LMTA – Little Mountain Test Annex

PCE - perchloroethene

TCE - trichloroethene

DCE - dichloroethene

VC – vinyl chloride

TCA - trichloroethane

Bgs – below ground surface

4.1 SITE LOCATION AND HISTORY

The three field sites are described in sequence below. Detailed reports on the data collection and analysis at each site are included in Appendices B, C, and D.

4.1.1 Site 1 NAS Jacksonville

Site 1 is a former base dry cleaning facility that operated from 1962 to the 1980's. The facility used perchloroethylene (PCE), which was stored in a 150 gallon (570 L) above-ground storage tank. The common contaminants encountered on-site are PCE and typical PCE degradation daughter products (TCE, DCE, VC). A pilot scale air-sparging system was installed and operated for a short period on-site, but was discontinued due to poor performance. In late 2010 the site was paved over and it is currently an active parking lot.

4.1.2 Site 2 Parris Island MCRD

Previously a base dry cleaning facility, Site 2 is located along the southern coast of South Carolina on the lower coastal plain. In 1988, four above-ground PCE storage tanks were

installed following the removal of an underground storage tank in approximately the same location. In 2001, the main dry cleaning building on site, the four above-ground storage tanks, and related structures were removed. The site is currently a vacant lot covered with grass, isolated shrubs, and trees. Contaminants with the greatest frequency of detection and the highest concentrations in groundwater include PCE and PCE daughter products. Petroleum liquid was observed in some water samples.

Site 2 has been used for several pilot-scale research remediation studies, including air sparging (AS) and soil vapor extraction (SVE), emulsified zero-valent nano-scale iron (EZVI), and a hydrogen peroxide application to a secondary plume associated with the site.

4.1.3 Site 3 Hill Air Force Base Little Mountain Test Annex

Site 3 was constructed in the late 1950's as a government research facility. The facility included a water treatment plant and two sludge drying beds (SDBs) to dry water treatment clarifier sludges. The SDBs consisted of two unlined pits (18 m x 18 m x 1.2 m deep) divided by a soil berm, built atop a flat-lying saddle on a west-northwest trending bedrock ridge. The drying beds were used through 1980 for potable/industrial water treatment processes. Sometime in 1975-1976 unknown quantities of phenolic paint strippers, chlorinated solvents, and other unknown wastes were disposed of in the SDBs, which are currently unused. The primary contaminants of concern on-site are TCE and its daughter products.

4.2 SITE GEOLOGY/HYDROGEOLOGY

4.2.1 Site 1 NAS Jacksonville

Site 1 geology, as shown in Figure 4.1, consists primarily of fine sands and silty sands to a depth of approximately 5.5-6 m bgs (18-20 ft bgs), followed by a clay unit approximately 1.8-2.4 m (6-8 ft) thick. While clay units often act as a barrier to downward chemical migration, contaminants are present in the unconsolidated deposits beneath. These include sand, clayey sand, sandy clay, and clay with traces of shell fragments to a depth of approximately 18 m bgs (60 ft bgs), where a limestone confining unit is encountered.

Depth to groundwater on-site is approximately 1.8 m (6 ft) with seasonal variations that are generally about 0.3 m (1.0 ft) or less. Groundwater flow on-site is to the east, with an approximate gradient of 0.005 m/m.

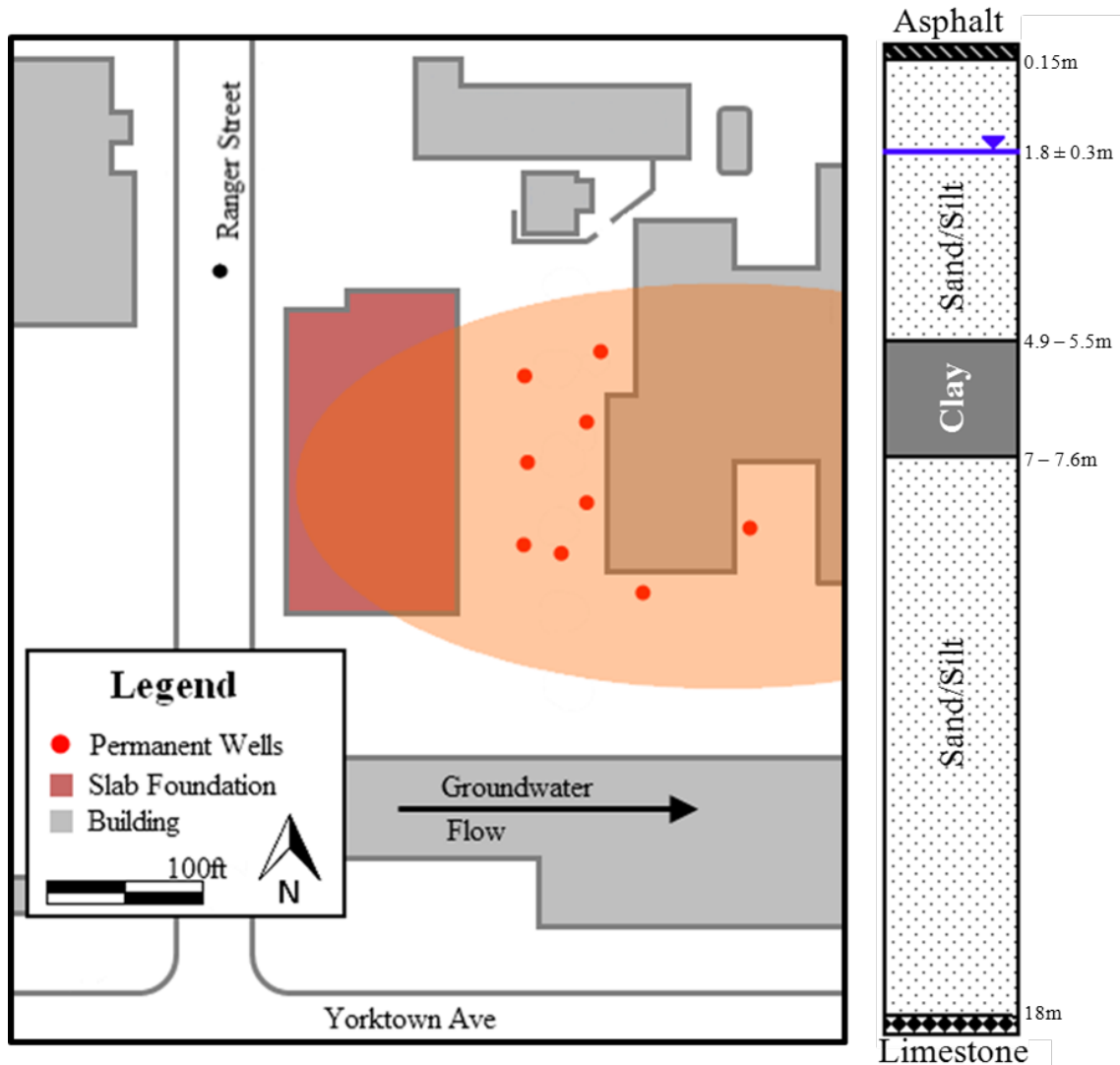

Figure 4.1. Site 1 plan view and simplified geologic cross-section.

4.2.2 Site 2 Parris Island MCRD

The surficial aquifer extends down to approximately 5.2-5.5 m bgs (17-18 ft bgs) and consists primarily of fine sands and silty sands with a few discontinuous lenses of finer-grained silty clay and clayey sand. A thin peat unit (0.3-1 m thick) below the surficial aquifer is followed by a clay layer (1-2 m thick) at depths from approximately 5.5 to 8.2 m bgs (17-27 ft bgs). A simplified geological profile is provided in Figure 4.2.

The interval from approximately 2.4 to 3.4 m bgs (8-11 ft bgs) is the dominant groundwater flow zone. Two distinct hydraulic gradients are present above and below this layer (0.005 and 0.006

m/m respectively). Flow is generally towards the southeast; however, groundwater movement is locally impacted by storm sewers present on the eastern and southern boundaries of the site (Vroblesky et al., 2009).

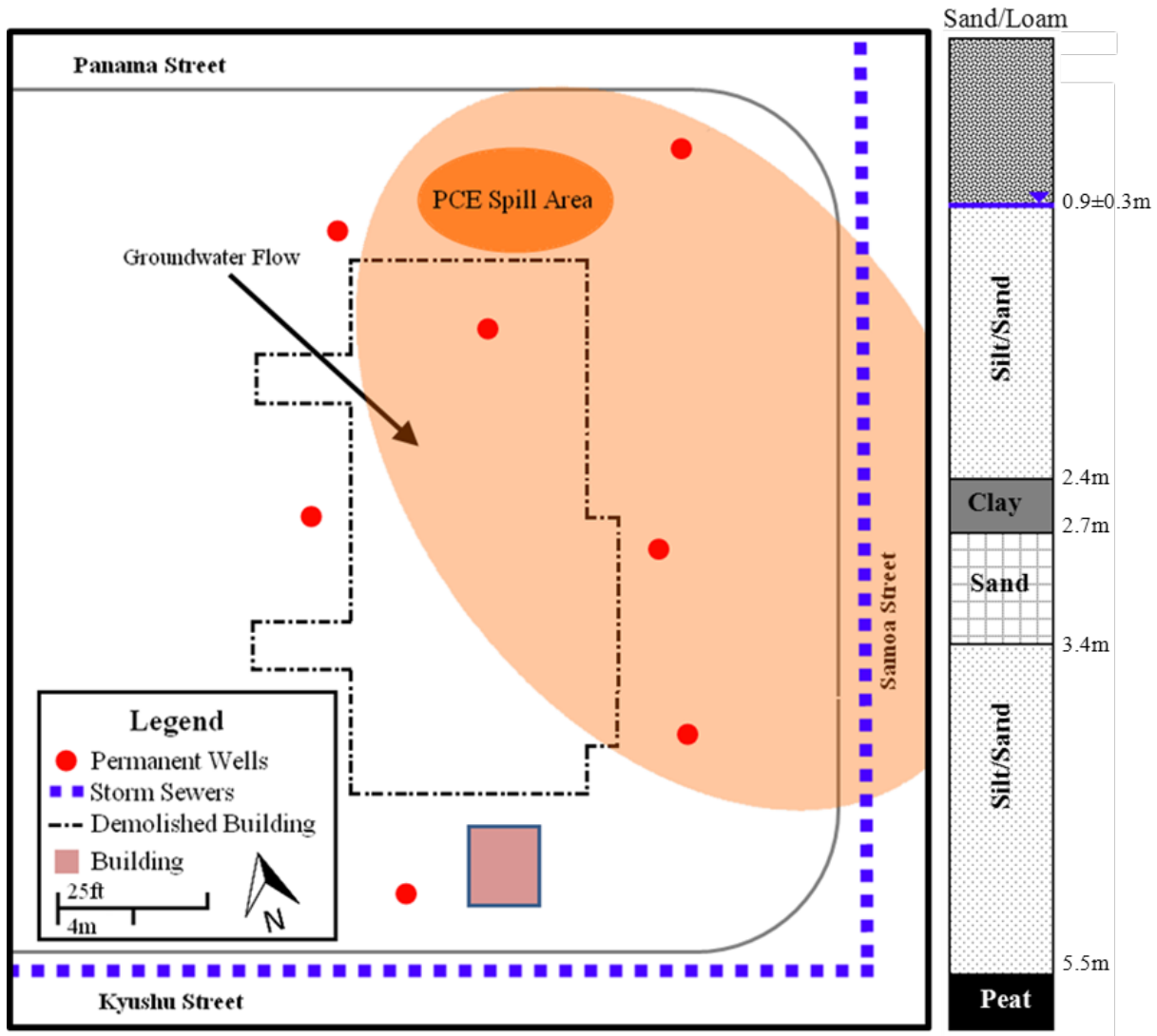

Figure 4.2. Site 2 plan view and simplified geologic cross-section.

4.2.3 Site 3 Hill Air Force Base LMTA

Site 3 is located on a bedrock outcropping approximately 0.4 km from the edge of salt flats of the Great Salt Lake. The site conceptual model consists of a thin surficial veneer of colluvium followed by a bedrock stratigraphic sequence: tillite (up-gradient), greenstone, calcareous phyllite, and slate (Figure 4.3). Site investigations have identified the phyllite as the dominant hydrogeologic unit with respect to CAH fate and transport. The unit is slightly metamorphosed,

highly fractured, and displays a significant numbers of voids and folds. Hydraulic testing of each unit has been performed and the resulting range of conductivities clearly demonstrate the dominance of the phyllite.

The bedrock units have a 20 to 25 degree dip towards the west and there are steep changes in elevation down towards the salt flats. Atop the bedrock ridge near the SDB's, groundwater is approximately 46 m bgs (150 ft bgs), whereas at the base of the mountain near the salt flats groundwater is encountered at approximately 3 m bgs (10 ft bgs).

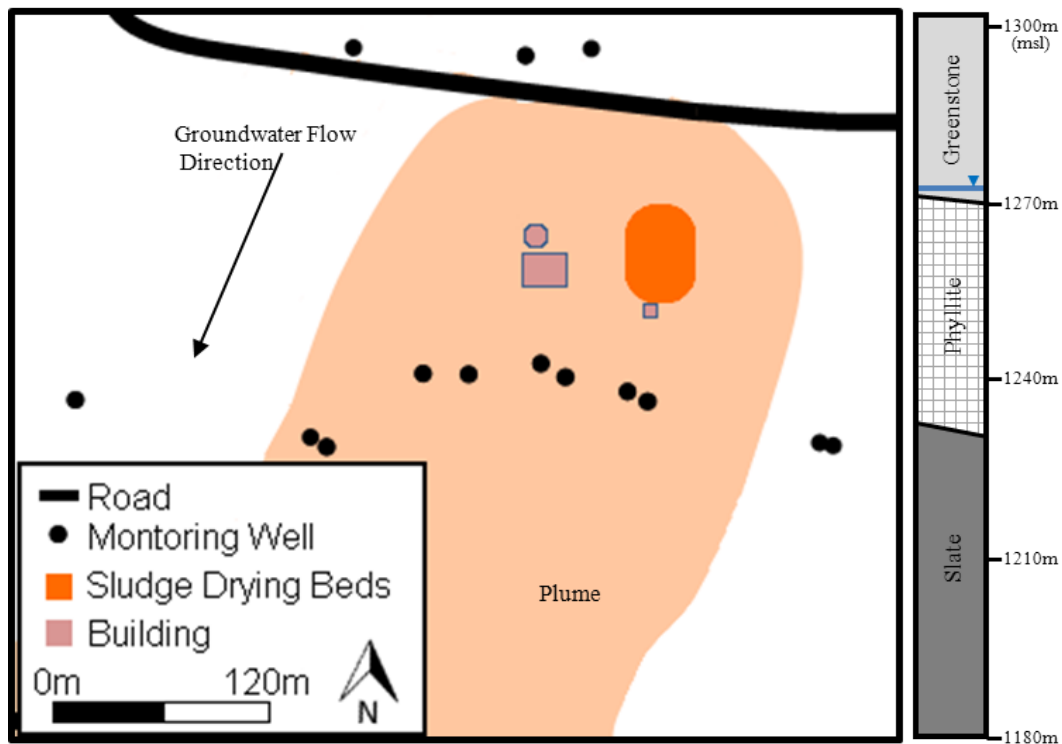

Figure 4.3. Site 3 plan view and simplified geologic cross-section.

4.3 CONTAMINANT DISTRIBUTION

4.3.1 Site 1 NAS Jacksonville

CAHs are present in the groundwater above and below the clay unit to a depth of approximately 18 m bgs (60 ft bgs). A plan view conceptual model built from pre-SZNA assessment information is found in Figure 4.1.

4.3.2 Site 2 Parris Island MCRD

CAH contaminants are present in the surficial aquifer to approximately 5.5 m bgs (18 ft bgs). Available data suggest that the peat and clay, with a hydraulic conductivity of less than 10^{-6} cm/s, appear to act as a barrier to downward migration. Several wells penetrate the peat and clay layer beneath the surficial aquifer, and no evidence of CAH contamination has been found beneath the clay/peat layer in these wells to date.

From the point of release, the primary dissolved contaminant plume extends southeast approximately 61 m (200 ft), where it is partially captured by the storm sewer system (Figure 4.2). The core of the plume is located within the 2.4 to 3.4 m bgs (8-11 ft bgs) interval.

4.3.3 Site 3 Hill Air Force Base LMTA

CAHs have infiltrated through the thin veneer of unconsolidated sediments and have migrated throughout the fractured bedrock to groundwater 46 m (150 ft) below the ground surface. Contamination is primarily found within the phyllite layer, likely due to both the depth to water below the SDBs and that unit's favorable hydraulic properties; however CAHs have been shown to extend to depths greater than 61 m (200 ft) below the water table and into the slate unit. The contaminant plume is transported from the site in a generally southwest direction (Figure 4.3).

5.0 TEST DESIGN

5.1 CONCEPTUAL EXPERIMENTAL DESIGN

The experimental design consisted of a strategy for sampling and testing groundwater and soil gas. The basis for the design is a conceptual site model of the source zone developed from standard site assessment data. Delineating the location, length, width and depth of the source zone is well-accepted as being critical to treatment technology selection, design, operation and monitoring. A multi-depth groundwater sampling transect oriented perpendicular to groundwater flow and placed just down-gradient of the suspected source zone location is the approach recommended here for determining the width and depth of the source zone. Experiences from Guilbeault et al. (2005), Triplett-Kingston et al. (2010), and this work suggest that this approach can provide a faster, more reliable assessment of the source zone width and depth and provide valuable insight to the spatial variability (Stroo et al. 2012). Once the footprint of the source zone is established, a groundwater and soil gas sampling plan is developed to meet the required uncertainty limits.

5.2 BASELINE CHARACTERIZATION

No baseline characterization was required for this project.

5.3 TREATABILITY OR LABORATORY STUDY RESULTS

No treatability studies were required for the assessment of source zone natural attenuation

5.4 DESIGN AND LAYOUT OF TECHNOLOGY COMPONENTS

Since no technology components exist in the assessment of source zone natural attenuation, this section does not apply.

5.5 FIELD TESTING

5.5.1 Site 1 - NAS Jacksonville

Four field events occurred at Site 1: August 6-15, 2009; January 9-22, 2011; June 4-13, 2011; and September 20-30, 2011. Based on available data and access restrictions, a groundwater transect was located approximately 21 m (70 ft) down-gradient of the Building 106 suspected spill location. The up-gradient sampling points were located on the opposite side of a north-south street due to access issues. Additionally, a soil core was collected in the expected plume core to verify site geology shown in Figure 4.1. Visual inspection notes and the complete summary of all site events, data, and analyses are provided in Appendix B.

Groundwater sampling was conducted in all hydrologic layers. The sampling density was chosen based on time considerations in addition to physical access restrictions; the goal was to conduct the field work, including in-field analysis of samples within a week. The sampling depths chosen (3, 4.5, 6.7, 9, 10.7, 13.7, 18.3 m bgs = 10, 15, 22, 30, 35, 45, 60 ft bgs) also reflect the historical data suggesting elevated concentrations above the clay, with diminishing levels near the limestone layer.

Vapor sampling locations for the first event were limited by access restrictions. The area immediately down-gradient of the suspected spill location was initially sampled as shown in Figure 5.2.

5.5.1.1 Site 1 Sampling Refinement – Groundwater Transect

Figure 5.1 displays the Site 1 groundwater transect sampling locations through four events and Table 5.1 summarizes the reasons for changes.

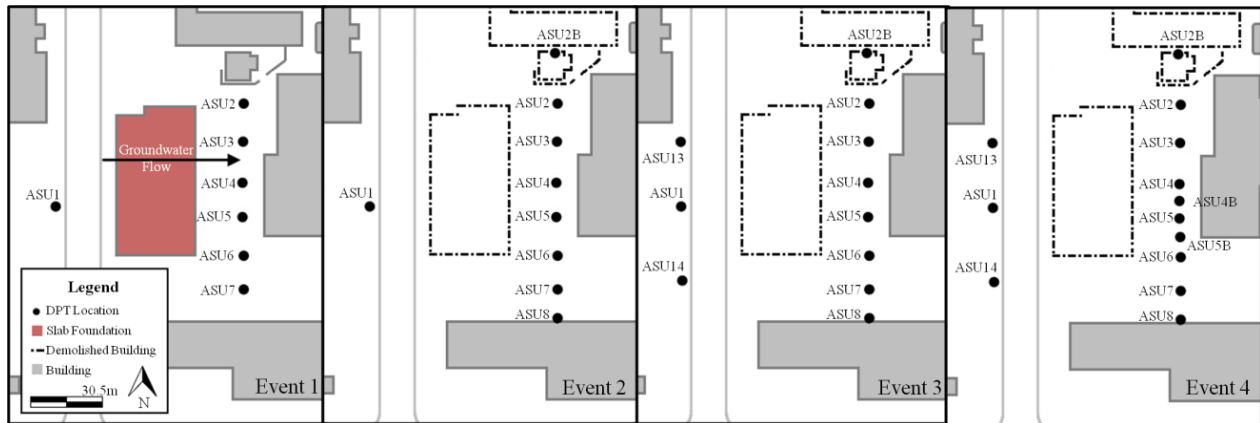

Figure 5.1. Evolution of Site 1 groundwater transect sampling locations.

Table 5.1. Site 1 Groundwater Transect Sampling Changes

Event	Changes	Rationale	Number of Samples
1	NA	NA	39 ^a (39 ^b)
2	Added sampling locations (ASU 2B, ASU8)	To better define the lateral boundaries of the source zone and dissolved plume; the extent not fully delineated in Event 1	61 ^a (82 ^b)
	Adjusted sampling depth intervals (previous depths 4.5, 6.7 m bgs = 15, 22 ft bgs)	To better align sampling depths with site geology and vertical distribution of dissolved contaminants: new depths (5.2, 7.6 m bgs = 17, 25 ft bgs)	
3	Additional up-gradient sampling locations added (ASU13, ASU14)	To better define the mass input from up-gradient sources	61 ^a (61 ^b)
	Adjusted and reduced up-gradient sampling depth intervals	To reduce time spent sampling up-gradient	
4	Increased lateral resolution and added offset vertical intervals in core of dissolved plume (ASU4B, ASU5B)	Better resolution in core of dissolved contaminant discharge: Depths at new wells (4, 7, 8.2, 12.2 m bgs = 13, 23, 27, 40 ft bgs)	73 ^a (94 ^b)

a – transect sampling locations

b – total sampling locations

5.5.1.2 Site 1 Sampling Refinement – Vapor Sampling

During the first field event, vapor sampling locations were limited by access restrictions. Although the former building had been demolished, the slab foundation was still in place and was unstable. For safety reasons it was not possible to sample through it. Prior to the second field event, the unstable slab foundation was removed and the area paved with asphalt, thereby allowing safe access above the source zone. Changes in vapor sampling locations are depicted graphically in Figure 5.2 and outlined in Table 5.2.

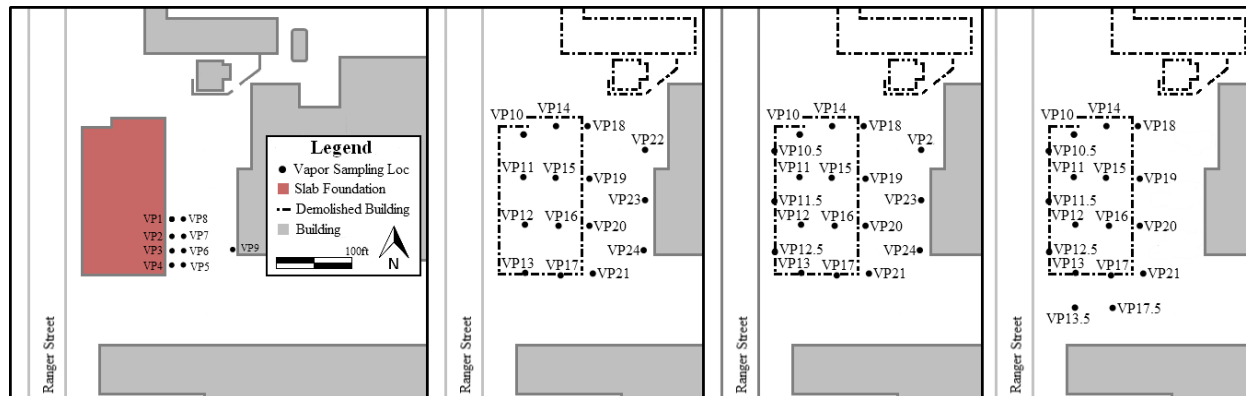

Figure 5.2. Evolution of Site 1 vapor sampling locations.

Table 5.2. Site 1 Vapor Sampling Changes.

Event	Changes	Rationale	Number of Samples
1	NA	NA	17
2	Increased number of locations (VP10 – VP24)	Former building foundation removed and area paved, increasing access	29
	Increased sampling footprint	To better define boundaries of soil gas plume	
3	Additional sampling locations (VP10.5, VP11.5, VP12.5)	To better define boundaries of soil gas plume	30
4	Additional sampling locations (VP13.5, VP17.5)	Increase resolution within soil gas plume	30
	Removal of sampling locations (VP22, VP23, VP24)	Upward vapor flux not detected at these locations.	

5.5.2 Site 2 - Parris Island MCRD

Four field events were conducted at Site 2; October 16-26, 2008; August 15-22, 2009; July 5-19, 2010; and June 14-25, 2011. The initial plan for placement of the groundwater plume transect was based upon historical groundwater concentration data. Once on-site, the transect location was altered to better reflect the impact of storm sewers on the local groundwater flow as shown in Figure 5.3. A soil core was collected in-line with the center of the transect to verify site geology. Visual inspection notes and the complete summary of all site events, data, and analyses are provided in Appendix C.

Sampling depths (1.5, 2.4, 3.4, 4.3, 5.2 m bgs = 5, 8, 11, 14, and 17 ft bgs) were chosen at roughly 0.9 m (3 ft) intervals based on the site geology observed during the first field event.

Vapor sampling during the first field event was constrained by time limits. Initial vapor sampling locations were placed up-gradient of the groundwater sampling transect and spaced in a grid directly above the suspected spill location as shown in Figure 5.4.

5.5.2.1 Site 2 sampling Refinement – Groundwater Transect

Figure 5.3 displays the evolution of groundwater sampling transect locations across the four Site 2 field events, and the rationale is summarized in Table 5.3.

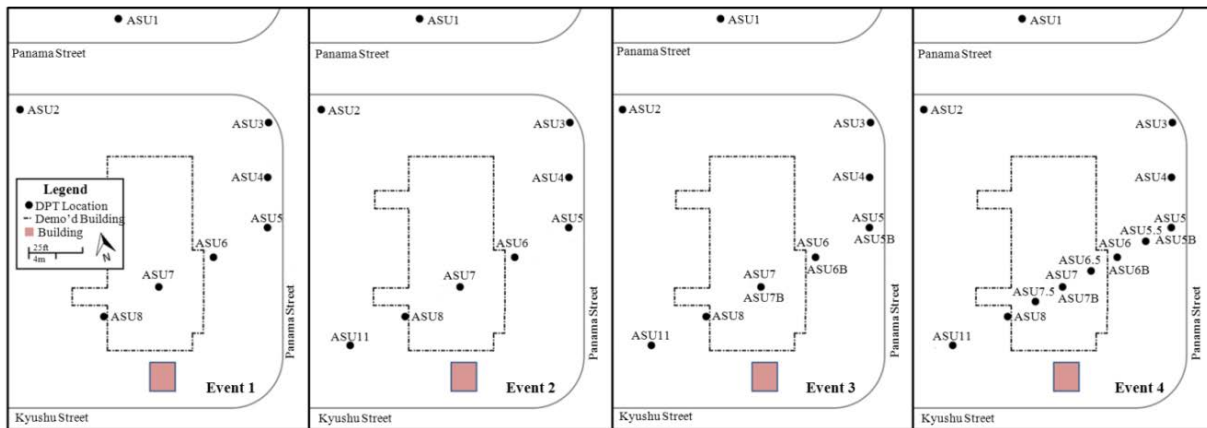

Figure 5.3. Evolution of Site 2 groundwater sampling transect locations.

Table 5.3. Site 2 Groundwater Transect Sampling Changes.

Event	Changes	Rationale	Number of Samples
1	Angled the transect orientation from initial north-south orientation	In-field groundwater flow determination; reflected influence of storm sewers on the southern boundary	48 ^a (92 ^b)
2	Additional lateral sampling point (ASU11)	To better define southwestern boundary of dissolved plume	48 ^a (81 ^b)
3	Increased vertical resolution in core of contamination (ASU5B, ASU6B, ASU7B)	To better define mass discharge in high K region (new depths: 2, 2.9, 3.8, 4.7 m bgs = 6.5, 9.5, 12.5, 15.5 ft bgs)	43 ^a (130 ^b)
4	Increased horizontal resolution in core of contamination (ASU5.5, ASU6.5, ASU7.5)	To better define mass discharge in high concentration region	55 ^a (79 ^b)

a – transect sampling locations

b – total sampling locations

5.5.2.2 Site 2 Sampling Refinement – Vapor Sampling

For the first and second field event the number of vapor sampling locations was limited by the available time. For subsequent events, additional vapor sampling locations were added and the footprint was enlarged to better assess vapor mass discharge above the source. Site 2 depths were limited by the shallow (about 1 m, or 3 ft) depth to groundwater. The evolution of the vapor sampling locations and rationale are summarized in Table 5.4 and Figure 5.4.

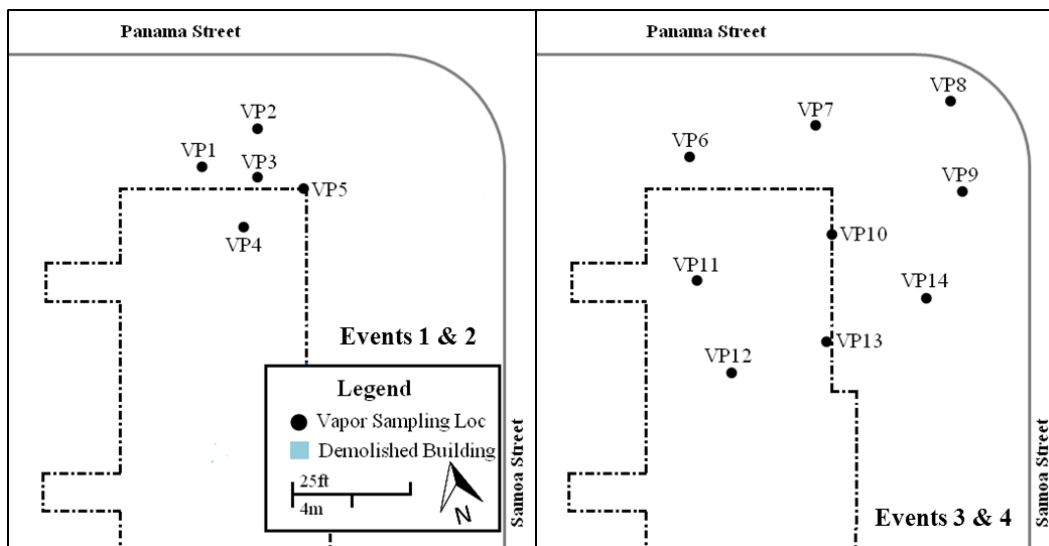

Figure 5.4. Evolution of Site 2 vapor sampling locations.

Table 5.4. Site 2 Vapor Sampling Changes.

Event	Changes	Rationale	Number of Samples
1	NA	NA	5
2,3,4	Increased sampling footprint	Better define regions with vapor emissions from source	9

a – transect sampling locations

b – total sampling locations

5.5.3 Site 3 - Hill Air Force Base LMTA

Four field sampling events were conducted at Site 3; August 2008, May 2009, September 2010, and August 2011. Visual inspection notes and the complete summary of all site events, data, and analyses are provided in Appendix D. Site characteristics at Site 3 are challenging as the depth to groundwater is in excess of 46 m (150 ft), well constructions necessitate large purge volumes, and the terrain is steep with rock outcrops. As a result, the existing groundwater well network was used. The first two events at this site were timed to coincide with sampling by the site contractor in order to leverage their activities for collection of designated transect samples. Those first two events involved traditional well purging with the sample collection. An alternative less-labor intensive selective-interval bailer sampling method employing Hydrasleeves® (GeoInsight) was used in subsequent events. This no-purge sampling method has the advantages of minimal waste disposal and shorter sampling times.

A subset of existing wells was selected based on groundwater flow and need for a transect perpendicular to the groundwater flow path as shown in Figure 4.3. Depth intervals sampled on-site were limited to those available; all layers were sampled, with an emphasis on the phyllite layer.

Vapor sampling at Site 3 was also challenging due to the hillside terrain and shallow bedrock contact. The contaminant release occurred in sludge drying beds that were subsequently excavated leaving only a very thin layer of unconsolidated sediment overlying bedrock. Vapor sampling locations are shown in Figure 5.5.

5.5.3.1 Site 3 Sampling Refinement – Groundwater Transect

Figure 3.3 displays the groundwater sampling transect locations for the four Site 3 events. No changes in sampling location or density were made due to prohibitive drilling and installation costs (bedrock in excess of 61 m bgs or 200 ft bgs). However, the groundwater sampling procedures did change as discussed above and noted in Table 5.5.

Table 5.5. Site 3 Groundwater Transect Sampling Changes.

Event	Changes	Rationale	Number of Samples
1	NA	NA	16 ^a (34 ^b)
2	NA	NA	16 ^a (35 ^b)
3	Sampling method changed from traditional well-volume purging to a no-purge selective bailer method	Sampling method requiring less waste disposal needed	16 ^a (16 ^b)
4			

a – transect sampling locations

b – total sampling locations

5.5.3.2 Site 3 Sampling Refinement – Vapor Sampling

Between the third and fourth sampling events, the vapor sampling wells were removed and abandoned by the site contractor. As a result vapor sampling was not possible during the fourth field event. Table 5.6 and Figure 5.5 outline the changes to vapor sampling on-site and the reasoning behind them.

Table 5.6. Site 3 Vapor Sampling Changes.

Event	Changes	Reasoning	Number of Samples
1	NA	NA	4
2	Increased sampling footprint	Better define regions with vapor discharge	8
3			

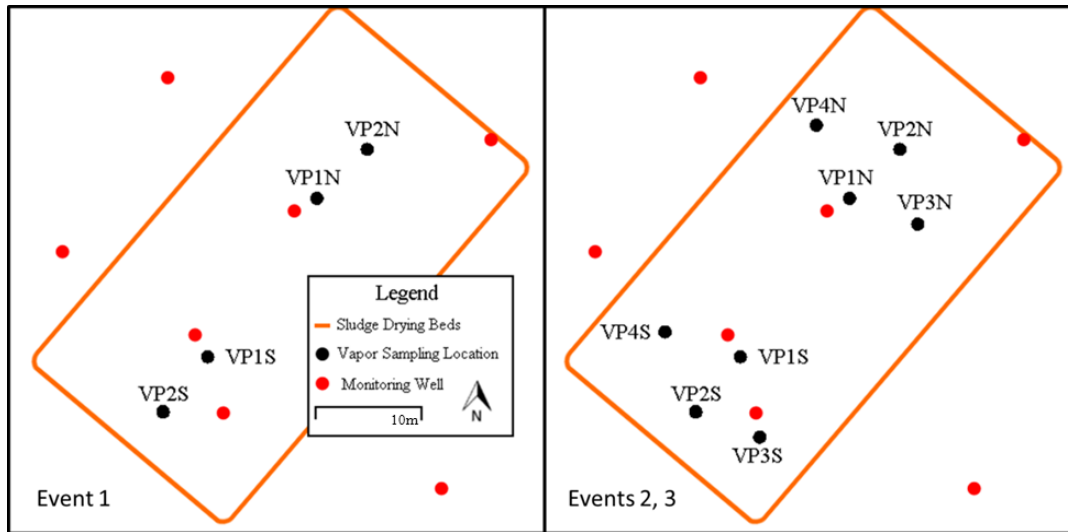

Figure 5.5. Evolution of Site 3 vapor sampling locations.

5.6 SAMPLING METHODS

Numbers of groundwater and soil gas samples collected during each sampling event are summarized in Table 5.7. Sampling methods, analyses, and holding times employed during implementation of the CAH SZNA assessment paradigm are summarized in Table 5.8. Appendix E contains additional information on quality assurance and quality control protocols.

Table 5.7. Numbers of Samples.

Site/Event	Number of Groundwater Samples	Number of Vapor Samples
Site 1		
Event 1	39	17
Event 2	82	29
Event 3	61	30
Event 4	94	30
Site 2		
Event 1	92	5
Event 2	81	9
Event 3	130	9
Event 4	79	9
Site 3		
Event 1	34	4
Event 2	35	8
Event 3	16	8
Event 4	16	0

Table 5.8. Sampling Methods and Analyses.

Analyte	Collection Method		Analysis Method	Maximum Holding Time
Ground Water VOC	DPT	Low purge Volume	EPA 8260B (USEPA 2012)	14 d (most analyzed on-site during sampling)
	Permanent Well	Conventionally Purged		
	Permanent Well	No Purge		
Hydraulic Gradient	Water Level Indicator		Devlin et al., (2003)	NA
Hydraulic Conductivity	Pump Tests		Cho et al., (2000)	NA
Soil Gas	Purged Lung sampler		8260B modified (USEPA 2012)	24 h
Effective Diffusion Coefficients	Tracer test		Johnson et al., (1998)	NA

DPT – Direct Push Technology

5.7 SAMPLING RESULTS

Full data reports containing the sampling results from all events at each site are contained in the appendices of this report (Appendices B, C, and D). Their use and significance to the assessment of source zone natural attenuation rates is discussed in detail in section 6.0 (Performance Assessment) of this report

5.8 DISTURBANCE TESTING

The local assessment of DNAPL architectural features was explored using four *in-situ* disturbance tests through proof-of-concept testing in a two-dimensional laboratory physical model. The disturbance tests were applied to the following conditions: dissolved source only, DNAPL ganglia and associated dissolved plume, and a DNAPL pool and its associated dissolved plume. The four different disturbance tests were water injections, in situ chemical oxidation (ISCO), heating, and air sparging. These disturbances were chosen as two are components of remedial technology pilot-testing field activities at some sites (air sparging and ISCO), one would be relatively simple to implement (clean water injection), and the fourth could possibly be implemented with modification of direct-push characterization tools (heating).

Of the four disturbances tested, the clean water and ISCO solution injections appear to be the most useful for determining the presence or absence of DNAPL. The utility of the ISCO solution will be dependent on its reaction rate and mass oxidant relative to DNAPL mass in ganglia; a slowly-reacting oxidant would provide results similar to a clean water injection, while a rapidly-reacting high-strength oxidant might produce similar results for ganglia and dissolved sources (as the ganglia could be fully treated by the injection in that case). The air sparging disturbance might also have similar behavior, depending on the duration and flow rate of air injection (as it could volatilize the DNAPL in the test zone), so more test combinations of flow rate and disturbance duration need to be investigated. It is unknown whether or not the heating test could help identify DNAPL pools, because that condition was not tested.

The data suggest that tests resulting in DNAPL mass depletion (ISCO, air sparging) might be designed to differentiate regions with ganglia and pools; these could be applied after regions containing DNAPL are identified by a first disturbance test. For example, a clean water injection might be used to determine the presence of DNAPL and that might be followed by an air sparging test to determine if the DNAPL is distributed as ganglia or a pool. Knowledge of subsurface geology will be critical in this determination as DNAPL pools tend to form at permeability contrasts.

Details of the testing are included in Appendix E.

6.0 PERFORMANCE ASSESSMENT

In this section the results of the source zone natural attenuation assessment for each site is provided. Sample data from the groundwater transects and vapor probes are presented below for the three sites previously introduced. For each site event a groundwater transect with CAH concentration contours is presented.

6.1 PERFORMANCE OBJECTIVE: DEMONSTRATE THAT SZNA IS OCCURRING

For each of the three sites there is strong evidence that SZNA is occurring in the form of dissolved and vapor phase mass discharges. That evidence is discussed in detail below in the sections addressing the performance objective of using the SZNA paradigm to estimate the rates of mass loss.

6.2 PERFORMANCE OBJECTIVE: ESTIMATE RATE OF SZNA

6.2.1 Site 1 - NAS Jacksonville

Due to access restrictions at Site 1, it was not possible to completely bound the discharge from the source, which can be seen in Figures 6.1 through 6.4. However, the mass discharge on the edges of the plume was low relative to the core. To highlight this, Figure 6.5 presents the point specific PCE equivalent mass flux [$\text{kg}/\text{m}^2\text{-y}$] for the fourth field event at Site 1. As can be seen a majority of the mass flux occurs within the center of the transect. When comparing figures

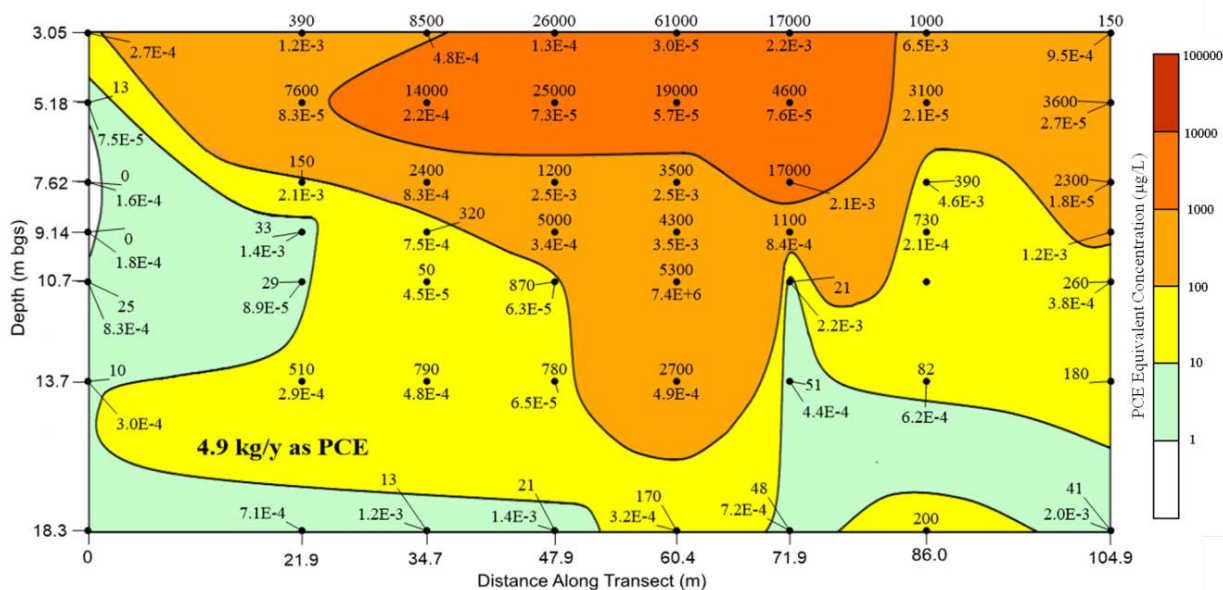

Figure 6.3. Site 1 event 3 groundwater transect contour plot with collocated values of concentration as PCE (upper values; $\mu\text{g/L}$) and hydraulic conductivity (lower values in scientific notation; cm/sec). Mass discharge of 4.9 kg/y as PCE.

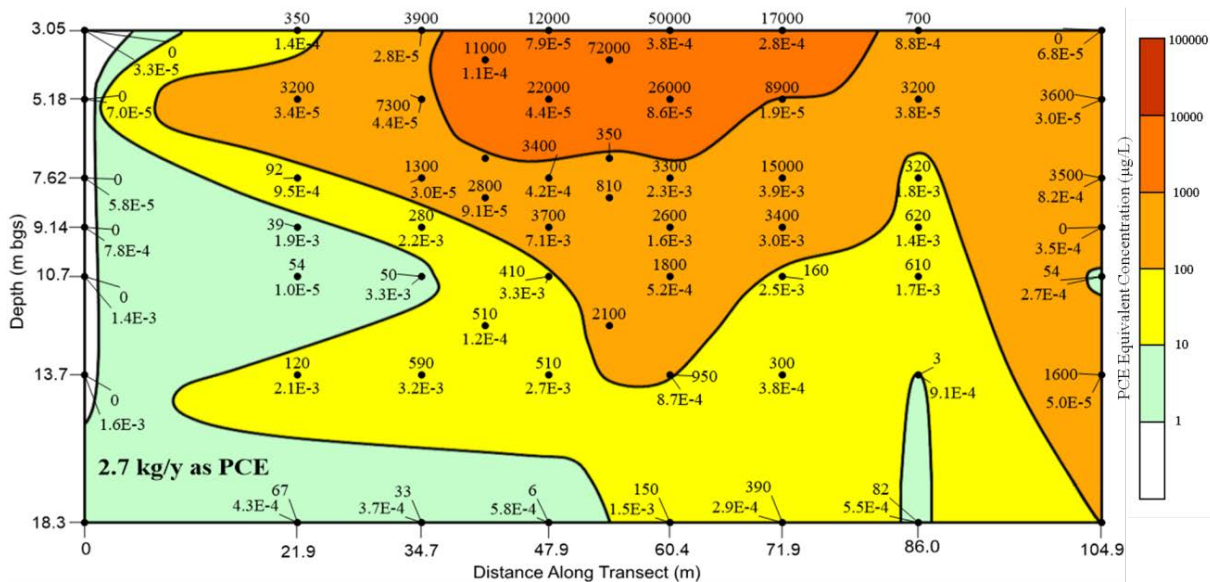

Figure 6.4. Site 1 event 4 groundwater transect contour plot with collocated values of concentration as PCE (upper values; $\mu\text{g/L}$) and hydraulic conductivity (lower values in scientific notation; cm/sec). Mass discharge of 2.7 kg/y as PCE.

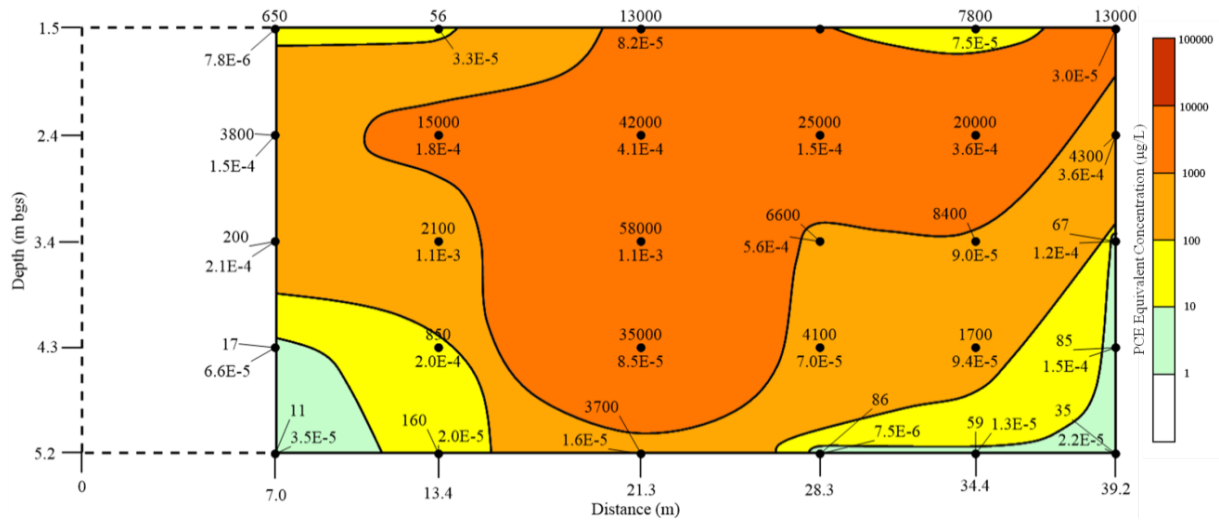

Figure 6.6. Site 2 event 1 groundwater transect contour plot with collocated values of concentration as PCE (upper values; $\mu\text{g/L}$) and hydraulic conductivity (lower values in scientific notation; cm/sec). Mass discharge of 0.87 kg/y as PCE.

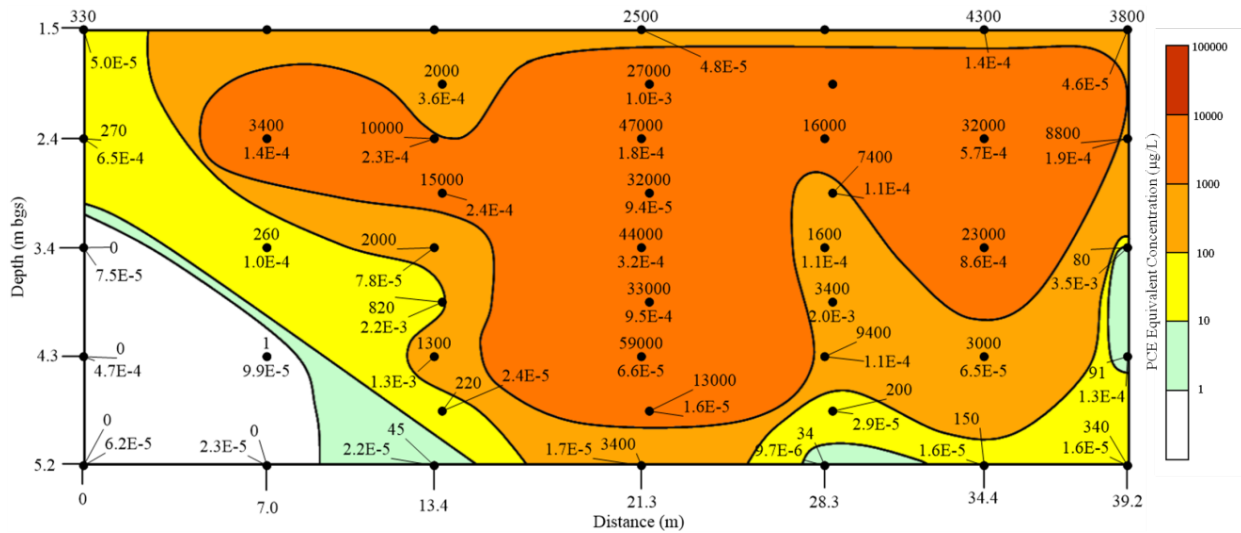

Figure 6.7. Site 2 event 2 groundwater transect contour plot with collocated values of concentration as PCE (upper values; $\mu\text{g/L}$) and hydraulic conductivity (lower values in scientific notation; cm/sec). Mass discharge of 1.4 kg/y as PCE.

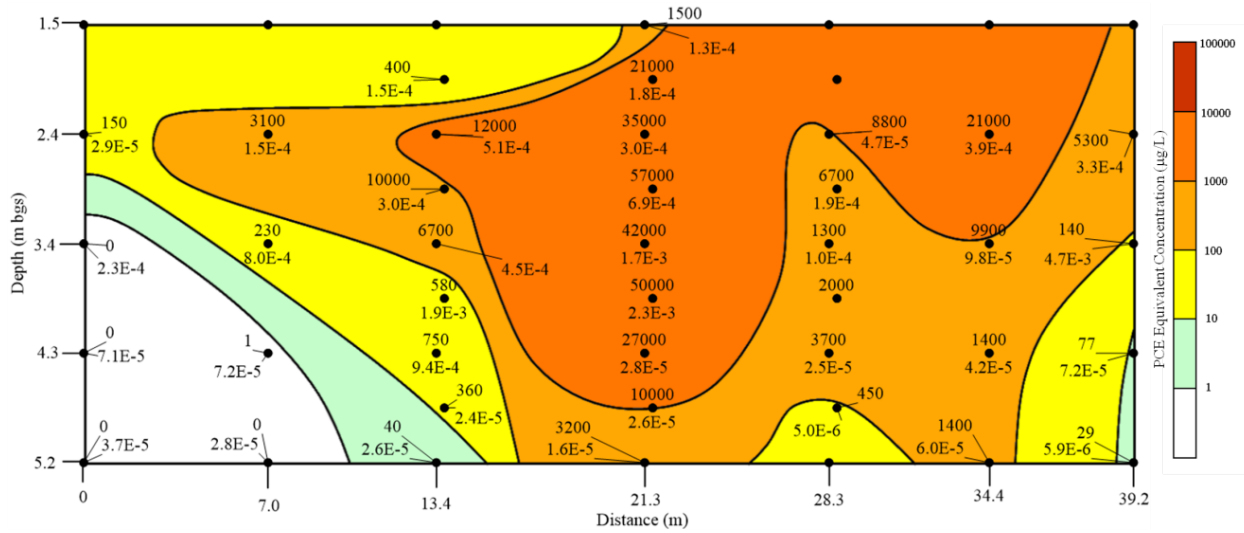

Figure 6.8. Site 2 event 3 groundwater transect contour plot with collocated values of concentration as PCE (upper values; µg/L) and hydraulic conductivity (lower values in scientific notation; cm/sec). Mass discharge of 1.1 kg/y as PCE.

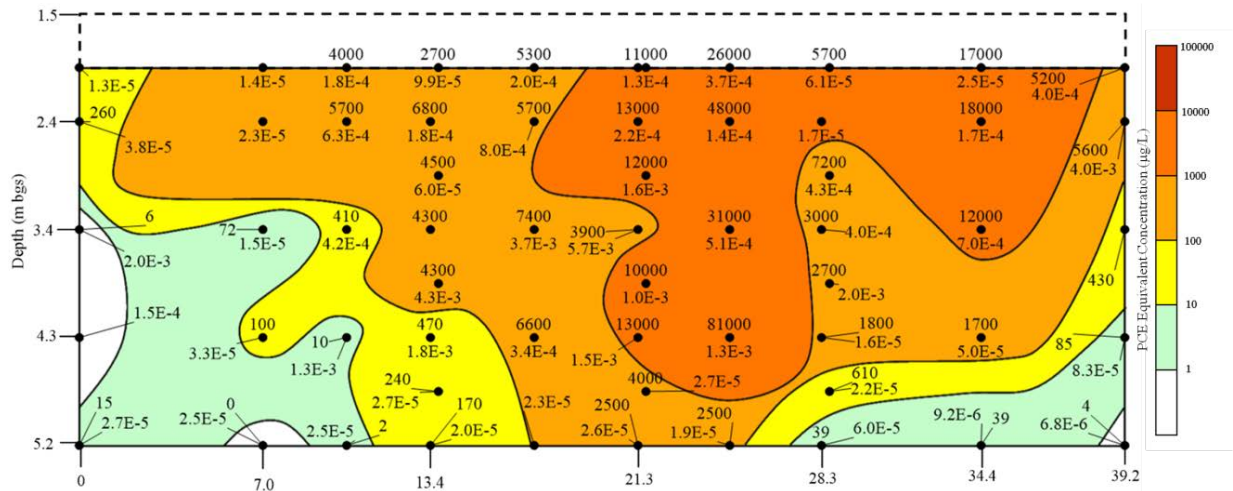

Figure 6.9. Site 2 event 4 groundwater transect contour plot with collocated values of concentration as PCE (upper values; µg/L) and hydraulic conductivity (lower values in scientific notation; cm/sec). Depth-to-water dropped during this event so no samples were taken at 1.5 m bgs. Mass discharge of 0.96 kg/y as PCE.

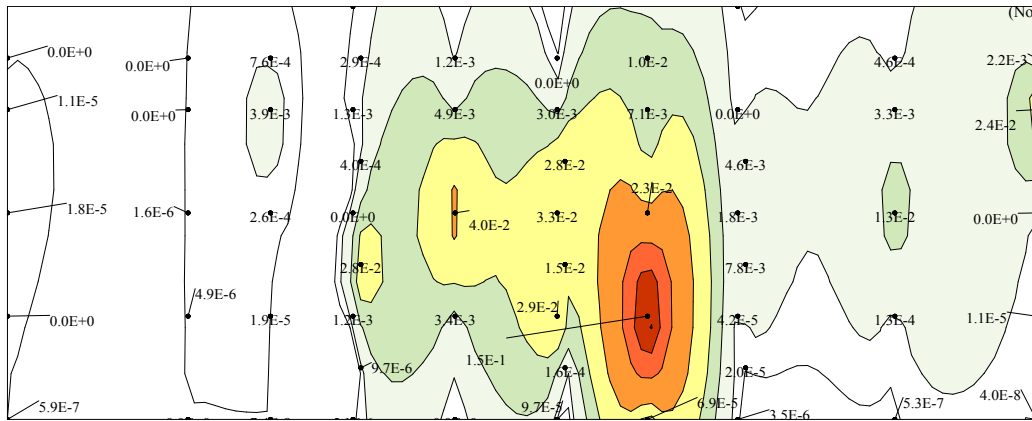

Figure 6.10. Site 2 event 4 CAH mass flux contour plot with values of PCE equivalent flux ($\text{kg}/\text{m}^2\text{-y}$) listed at each sample location. Flux contours are normalized to the maximum point specific flux from the fourth event.

6.2.3 Site 3 - Hill Air Force Base LMTA

Due to site settings, Site 3 was the most challenging to sample and has the lowest data density. However, unlike the previous sites, it was possible to bound the entire plume, which can be seen in Figures 6.11 through 6.14 for each sampling event. As with the other sites, a small region dominates the mass flux through the transect (Figure 3.23), very little variation is seen in the gross structure of the concentration contours between events, and the mass discharge between events is relatively stable ($\leq 2X$ difference). These observations suggest that no significant changes to source structure of mass decay occurred during the sampling time frames (~ 3 y).

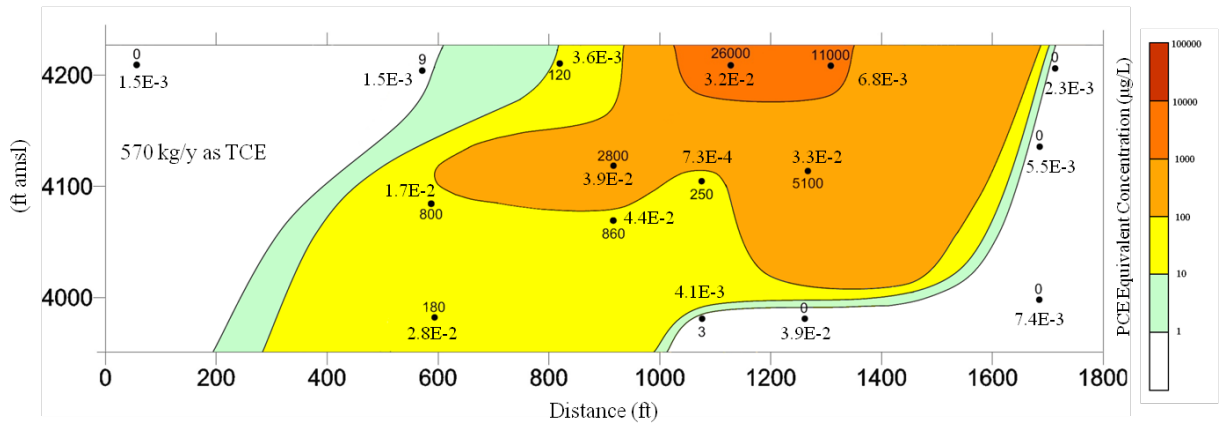

Figure 6.11. Site 3 event 1 groundwater transect contour plot with collocated values of concentration as TCE (upper values; µg/L) and hydraulic conductivity (lower values in scientific notation; cm/sec). Mass discharge of 570 kg/y as TCE.

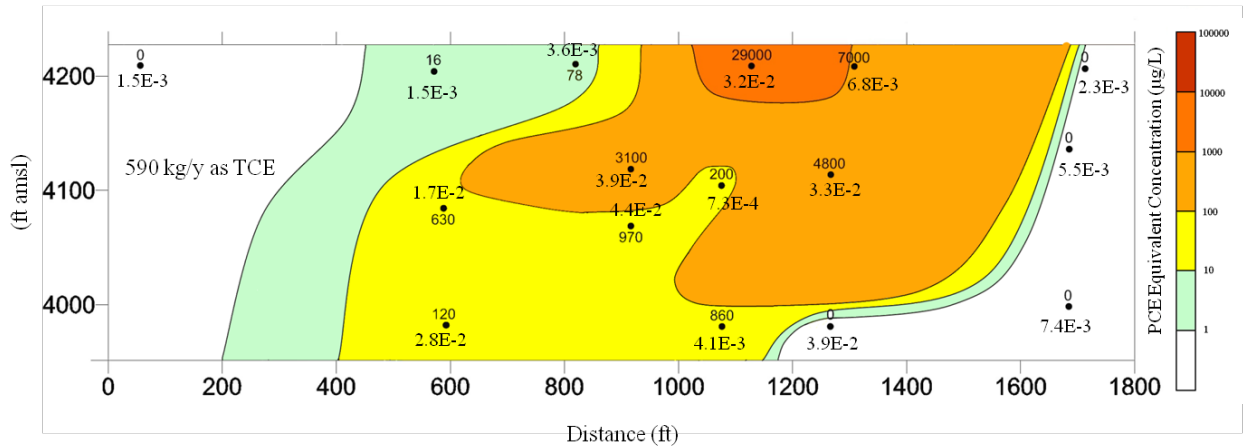

Figure 6.12. Site 3 event 2 groundwater transect contour plot with collocated values of concentration as TCE (upper values; µg/L) and hydraulic conductivity (lower values in scientific notation; cm/sec). Mass discharge of 590 kg/y as TCE.

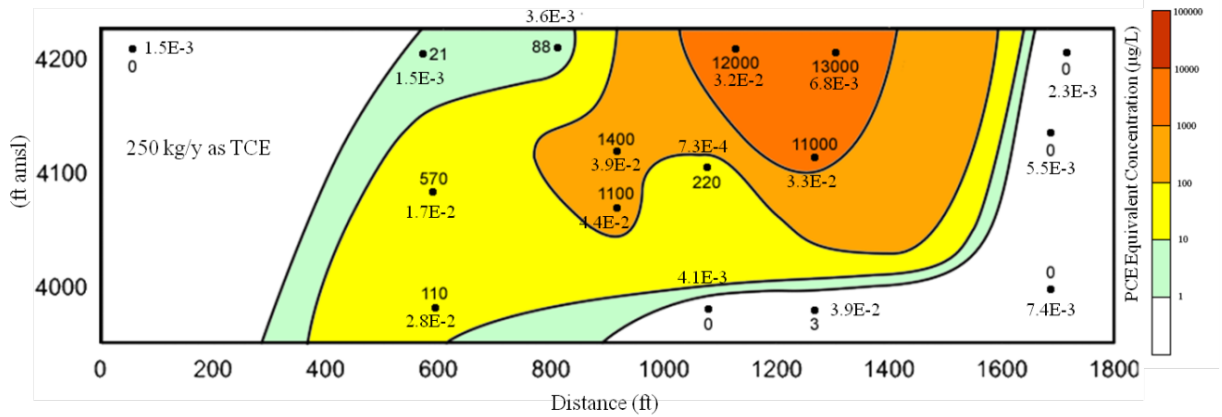

Figure 6.13. Site 3 event 3 groundwater transect contour plot with collocated values of concentration as TCE ($\mu\text{g/L}$) (upper values; $\mu\text{g/L}$) and hydraulic conductivity (lower values in scientific notation; cm/sec). Mass discharge of 250 kg/y as TCE.

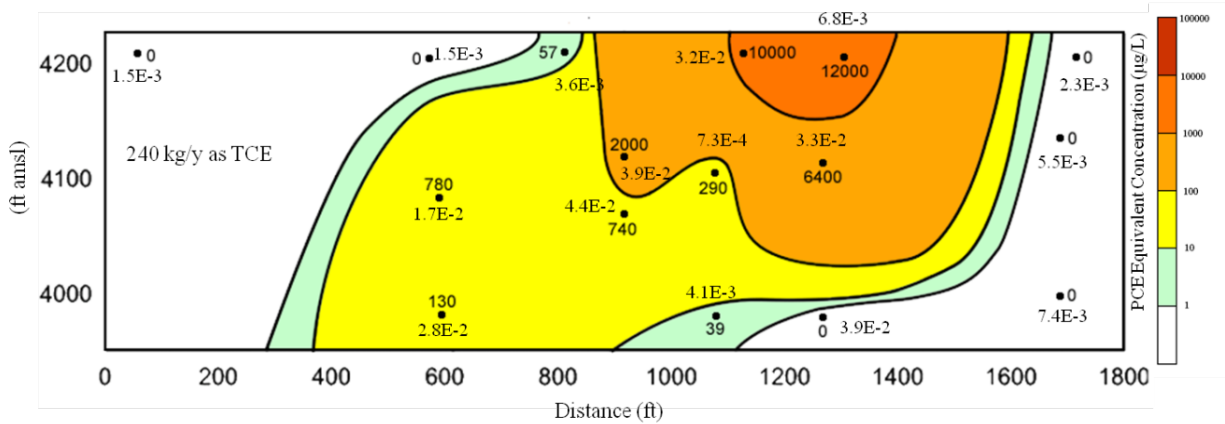

Figure 6.14. Site 3 event 4 groundwater transect contour plot with collocated values of concentration as TCE ($\mu\text{g/L}$) (upper values; $\mu\text{g/L}$) and hydraulic conductivity (lower values in scientific notation; cm/sec). Mass discharge of 240 kg/y as TCE.

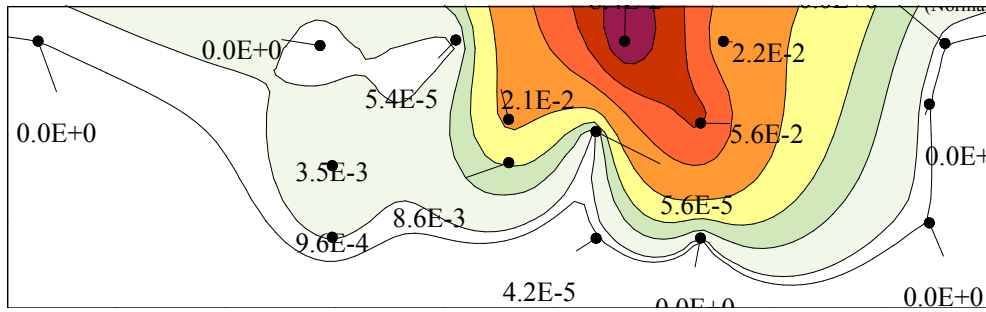

Figure 6.15. Site 3 event 4 CAH mass flux contours with values of TCE equivalent flux ($\text{kg}/\text{m}^2\text{-y}$) listed at each sample location. Flux contours are normalized to the maximum point specific flux from the fourth event.

6.2.4 Vapor Flux Assessment

Vapor flux contours are presented for a single sampling event at each demonstration site. Similar to the dissolved mass discharge, a majority of the vapor discharge occurs in a relatively small region as can be seen in Figures 6.16, 6.17, and 6.18. Using information from the vapor assessment it may be possible to identify regions containing high levels of contamination within the vadose zone. This region may potentially have been the release point for the site contaminant, which is the most likely region to have CAH DNAPL within the vadose zone.

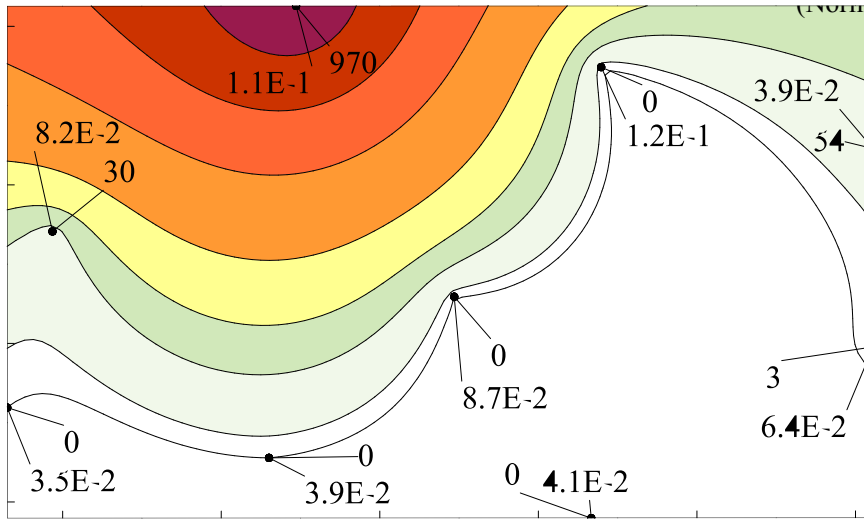

Figure 6.17. Vapor transect plot: Site 2: event 4 % PCE equivalent flux contours (normalized to the maximum flux location) with collocated ΔC (PCE Equivalents $\mu\text{g/L}$) and effective diffusion coefficients (values in scientific notation; cm^2/s). Mass discharge of 0.13 kg/y as PCE.

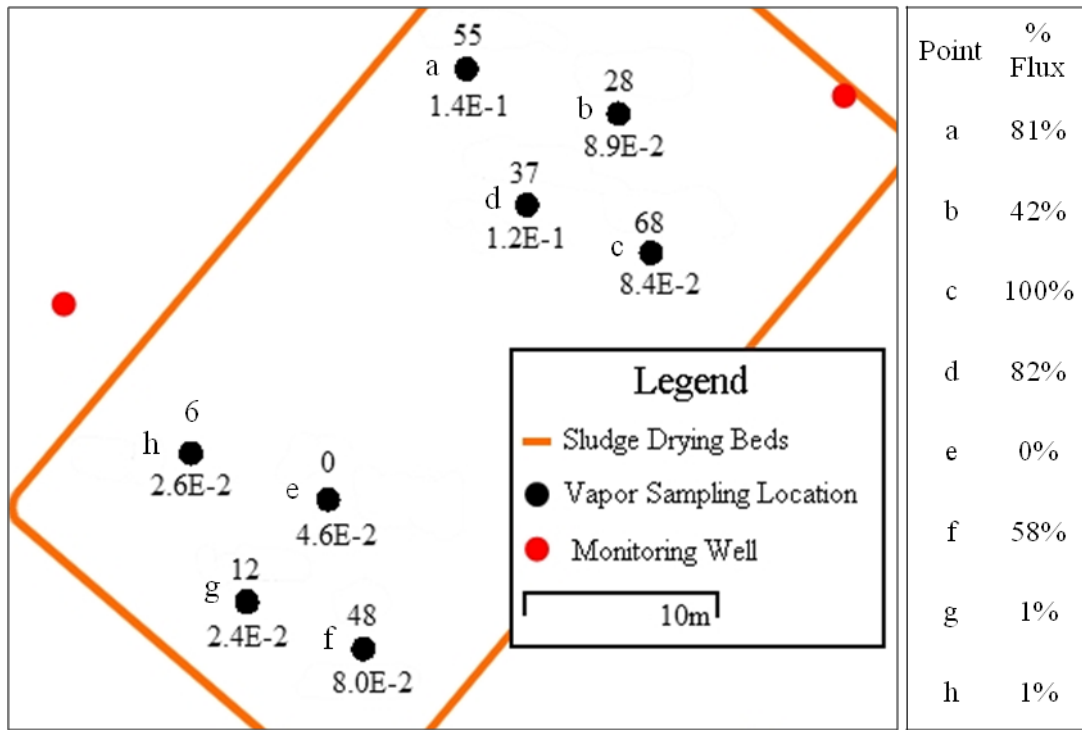

Figure 6.18. Vapor transect plot: Site 3: event 2 with collocated ΔC (TCE equivalents $\mu\text{g/L}$) and effective diffusion coefficients (values in scientific notation; cm^2/s). Percentage of maximum flux for each location in listed on right. Mass discharge of 0.028 kg/y as TCE.

6.2.5 SZNA Mass Loss Rates from the Three Demonstration Sites

SZNA mass loss rates determined from demonstration site data are presented in Table 6.1. The “Range” reported for dissolved mass discharge spans the minimum and maximum GSI Mass Flux Toolkit output for three different interpolation combinations (linear, logarithmic, nearest neighbor); the “average” value is the averaged result from all interpolation combinations.

Table 6.1. SZNA Mass Loss Rate Results.

	K ^a	D _{eff} ^a	Event	Date of Sampling	Hydraulic Gradient		Dissolved Mass Discharge As PCE (Sites 1, 2) As TCE (Site 3)		Vapor Discharge As PCE (1,2) As TCE (3)		Total SZNA Mass Loss Rate (kg/y)	
	(cm/s)	(cm ² /s)			(m/m)		(kg/y)	# ^b	(kg/y)	# ^b		
Site 2	8.8 x 10 ⁻⁶ – 1.8 x 10 ⁻²	1.0 x 10 ⁻² – 3.5 x 10 ⁻²			Upper	Lower	Range ¹	Avg.				
			1	10/16-26/08	0.004	0.005	0.8 – 0.97 ¹	0.87	48	0.68	5	1.6
			2	8/15-22/09	0.005	0.006	1.1 – 1.6 ¹	1.4	48	0.76	9	2.2
			3	7/5-19/10	0.004	0.005	0.92 – 1.2 ¹	1.1	43	0.57	9	1.7
4	6/14-25/11	0.0034	0.0047	0.70 – 1.2 ¹	0.96	55	0.13	9	1.1			
Site 1	1.1 x 10 ⁻⁵ – 5.1 x 10 ⁻³	1.5 x 10 ⁻³ – 8.9 x 10 ⁻³	1	8/6-15/09	0.006		1.8 – 3.4 ¹	2.8	39	0.64	17	2.9
			2	1/9-22/11	0.005		6.2 – 9.9 ¹	8.3 ^e	61	0.95	29	8.4
			3	6/4-13/11	0.0049		2.9 – 6.5 ¹	4.9 ^e	61	0.21	30	4.9
			4	10/20-30/11	0.0034		1.8 – 3.4 ¹	2.7	73	0.79	30	2.8
Site 3	1 x 10 ⁻³ – 5 x 10 ⁻²	9.0 x 10 ⁻⁴ – 6.3 x 10 ⁻³	1	7/08-8/08	8.4 x 10 ⁻⁴		570-730 ^c	670	16	0.028	4	570
			2	4/09-5/09	8.4 x 10 ⁻⁴		590-760 ^c	700	16	0.028	8	590
			3	10/16-17/10	8.4 x 10 ⁻⁴		250-410 ^d	350	16	0.039	8	250
			4	8/23-24/11	8.4 x 10 ⁻⁴		240-370 ^d	320	16	NS		240

a – range of values

b – Number of samples

c – conventional purge sampling method

d – No purge method

e – prior to the second event the building covering the site was demolished and paved with asphalt, during which time the ground surface was open allowing elevated infiltration of water locally at a time when the water table was dropping due to drought. It is believed this flushing of the vadose zone may account for the elevated discharge during events 2 and 3

¹ – range is result of multiple iteration methods for calculating mass discharge in Mass Flux Toolkit (log, linear, nearest neighbor)

D_{eff} – Effective vapor diffusion coefficient measured in-situ

K – Hydraulic conductivity measured in-situ

NS – Not sampled

In comparing discharge rates from the different interpolation combinations it can be seen that there is approximately a factor of two difference between the high and low values. Given the several order-of-magnitude range of concentrations and hydraulic conductivities, this difference is not large and within the normal uncertainty of data from remediation sites.

In addition to interpolation variation in the discharge estimates there are also temporal changes in the SZNA rates. Figure 6.19 plots the discharge rates vs. time to examine if there were significant temporal changes in the mass discharges for each site over the sampling period (~2 - 3 y across all sites). It can be seen in Figure 6.19 that the rates from event to event are relatively similar (≤3X difference). Given the possible opportunities for discrepancy between rate estimates, and in particular the nature of direct push technology sampling (never the same exact X,Y,Z but generally within ~0.3 m), this range of values is remarkably consistent. Examining

the variation in further detail shows that only a single event displays this level of change (Site 1, Event 1 to Event 2), all others are $\leq 2X$ difference. This, in the context of how the rates are likely be used, the temporal variability over the study period might be considered inconsequential.

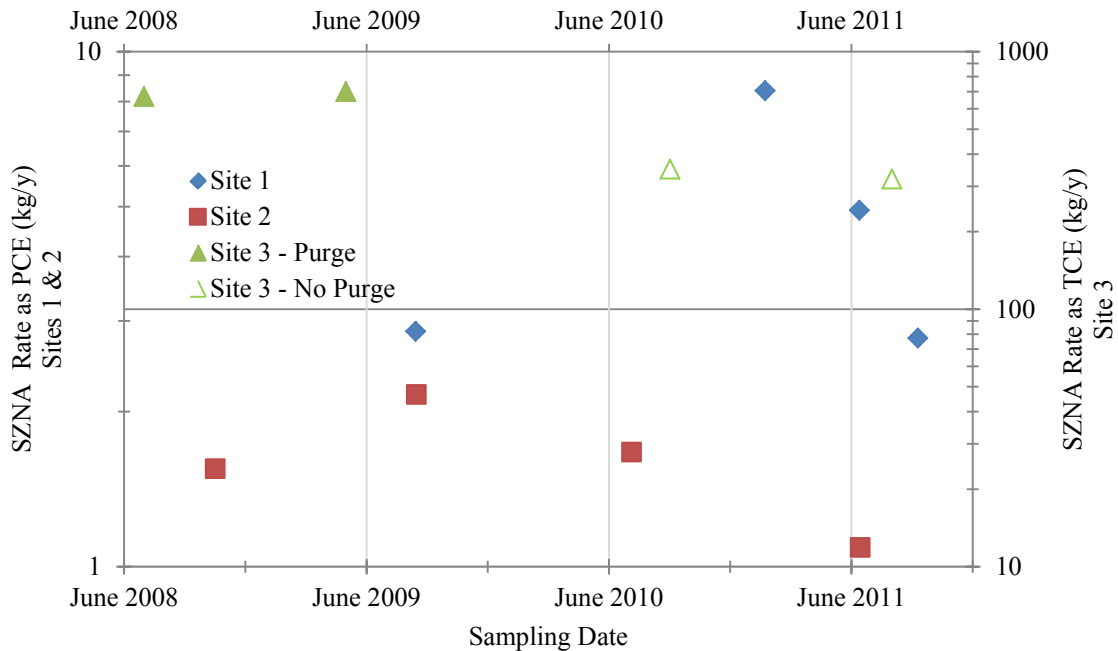

Figure 6.19. Averaged CAH dissolved contaminant discharge rates vs. time for three sites sampled. Note: Site 1 and 2 and displayed on the left y-axis and Site 3 on the right y-axis.

At Site 1, which was the only site to exhibit a $>2X$ change in SZNA rate, the mass loss rate increased by a factor of three from the first to the second event (Table 6.1 and Figure 6.19). It then gradually decreased back to the initial loss rate over the next two sampling events spanning about a year. This is likely reflective of real changes in the mass loss rate, rather than errors and uncertainties in determination of the mass loss rate. The change seen between these events (Site 1, Event 1 to Event 2) is likely to have resulted from changes to site conditions between the site sampling events.

Preceding the second event the building foundation above the source zone and the asphalt surrounding it were removed and the ground surface was left open for roughly four to five months. Prior to slab removal, infiltration of rainfall in the source region was negligible, due to the concrete and asphalt cap. While the ground surface was uncovered approximately 13 cm (~5 in) of rainfall occurred, and was likely able to infiltrate from above the source where the slab had been removed. This amount of rainfall is equivalent to about 0.2-0.35 pore volumes depending on porosity ($0.25-0.45 \text{ cm}^3\text{-pores/cm}^3\text{-soil}$), although it could have been larger as the exposed ground surface is a low point on site and could act as a drainage point for rainfall surface runoff. Prior to the precipitation, while ground surface was exposed, the water table across the site

dropped from previous levels. Figure 6.2 shows the groundwater sampling transect for Event 2, relative to the other events, elevated CAH concentrations are seen near the top of the sampling transect in the core of the plume (Figure 6.2) suggesting that infiltration may have had an effect on the mass discharge from the site.

The SZNA mass loss rates for Site 3 appear to be consistent between the first and second events and then again for the third and fourth events, with a step change in rates between the two pairs of sampling events. This is most likely the result of changes in the groundwater sampling methods. The first and second events involved traditional well purging prior to sampling, while the third and fourth involved no-purge sampling using a discrete-depth selective interval bailer.

The difference in mass discharge estimates between events reflects all sources of variability and error, including changes in groundwater elevation and infiltration, sampling density, analytical error, interpolation methods, and pump test error. Given this, it is remarkable that the discharge estimates over approximately three years are at most a factor of three different from event to event.

6.2.6 Sample Density

When using point-based groundwater sampling transect approaches, site-specific decisions regarding transect placement and lateral and vertical sampling point spacing must be made. Increasing the number of sample locations is expected by many to correspond to increases in cost and confidence; therefore, there is interest in gaining a better understanding of the trade-offs between sampling density and uncertainty in mass discharge estimates. The issue of heuristic sampling and guidelines is discussed in detail in Appendix G. Here the basic guidelines and a simple illustration of their use are given.

Based on experience gained from this project, the following sampling guidelines using practical and commonplace sampling tools are suggested for larger CAH source zones:

- Collect a soil core and visually observe to identify distinctive geologic layers.
- Use an initial coarse sampling approach to quickly delineate the boundaries of the plume (~30 m horizontal spacings, ~7.5 m vertical spacings, with a minimum of one sample in each unit); use on-site chemical analysis screening tools to ensure the transect spans the full width of the dissolved contamination.
- Using initial site data for plume boundaries, resample the plume at a higher density
- Use lateral spacings of no more than the width of contamination divided by 6 across the full width of the plume.
- Collect a minimum of one sample in each distinct hydraulic unit; constrain the largest vertical separation between samples at the same location to the plume thickness divided by 6; consider not exceeding about 7.5 m between points.
- Use highest resolution sampling in the suspected core of the plume (<3m vertical intervals)

An example of the iterative sampling strategy is depicted in Figure 6.20 for a ~100 m wide x 15 m thick plume in a three-layer system, this would correspond to a minimum of ~8 locations x 3 depths.

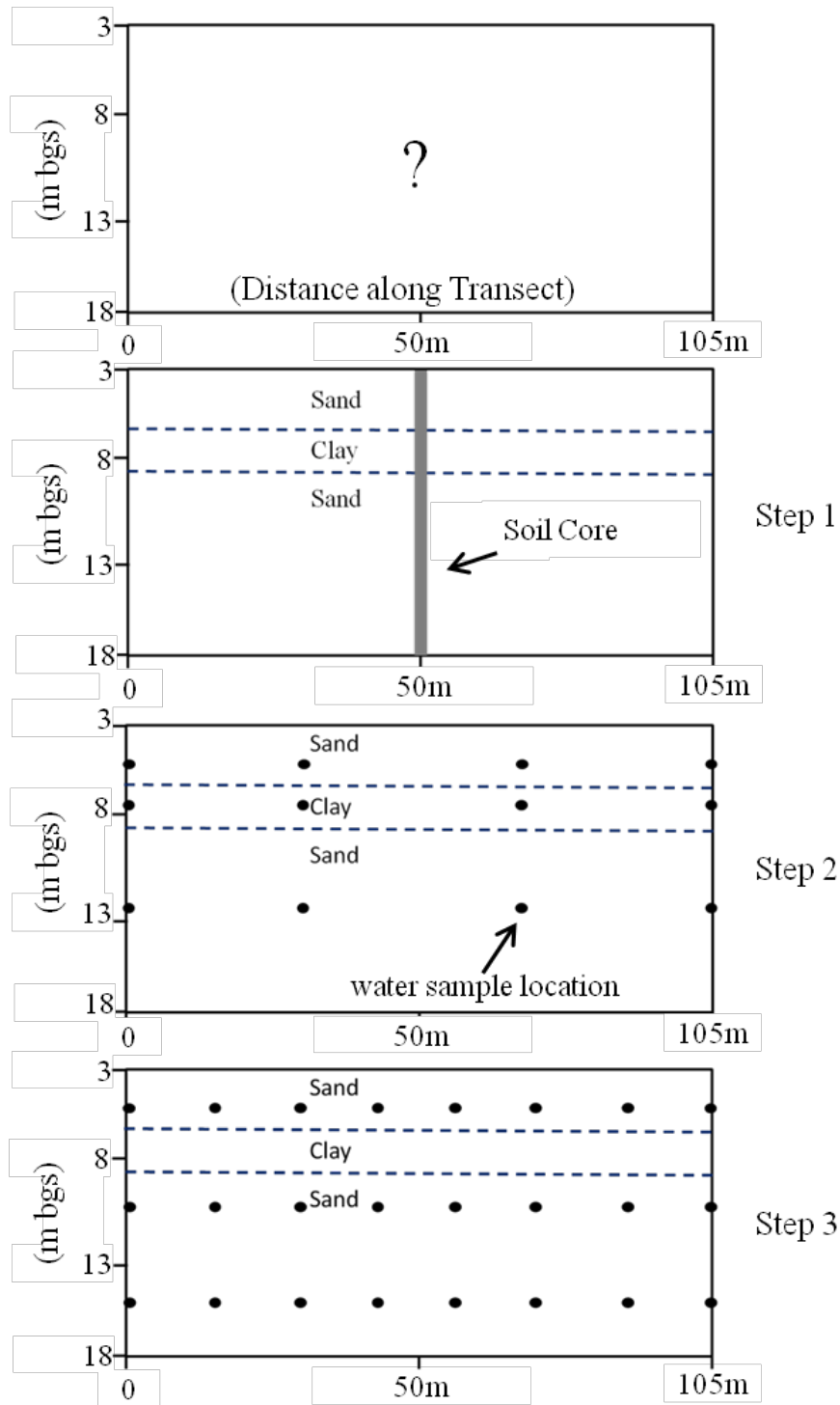

Figure 6.20. Iterative sampling guideline steps at a hypothetical ~100 m x 15 m thick CAH source. No water is recoverable from the clay layer, so during Step 3 no sample locations are place within that layer. It should be noted that the size of this hypothetical case matches that of Site 1.

7.0 COST ASSESSMENT

The primary goal of this project was to develop a framework for the assessment of the natural attenuation of CAH source zones, with an emphasis on a data-driven approach to the estimation of rates of source zone attenuation. The main costs associated with this approach are associated with the acquisition of the necessary samples and data.

7.1 COST MODEL

The elements of the cost model considered are:

1. Drilling
2. Sampling
3. Sample analysis
4. Data analysis and reporting (including estimation of source zone attenuation rates)

7.2 COST DRIVERS

The primary cost drivers for the assessment of SZNA are the costs associated with the installation of sampling equipment, the collection of samples, and the analysis of samples. The size and complexity of the source zone, depth to ground water, and type of subsurface material (e.g. soft soil versus hard lithified rock) will affect drilling and sampling costs on a site specific basis.

7.3 COST ANALYSIS

Approximate site costs associated with the sampling efforts of this work, which included about 10 – 14 days on-site per event, are presented in Table 7.1. While not trivial, the cost per event (~\$68,000) is not prohibitive for many sites. Sampling density decisions are largely driven by balancing the need for confidence in SZNA rate estimates vs. cost. However, sampling density is one of the key options for reducing uncertainty in SZNA rates.

Table 7.1. Estimated Sampling Costs.

Activity		Amount	Unit Cost	Total Cost
Drilling	Mobilization	-	\$500	\$500
	On-Site	6d	\$2000/d	\$12,000
Consultant	Prep	80 h	\$150/h	\$12,000
	On-site	192 h	\$100/h	\$19,200
	Reporting	80 h	\$150/h	\$12,000
Analytical	GW Samples	50	\$150/sample	\$7,500
	Vapor Samples	20	\$150/sample	\$3,000
Misc	Waste Disposal	-	-	\$1,000
	Consumables	-	-	\$1,000
Totals				\$68,200

8.0 IMPLEMENTATION ISSUES

The approach used in this project for the assessment of SZNA at CAH sites uses fairly standard and readily available sampling and analytical tools. No barriers to the collection of the necessary data are anticipated other than those presented by unique site conditions. Many of the data needs/lines-of-evidence are similar to those appearing in dissolved plume natural attenuation guidance, with the exception of the assessment of effective vadose zone diffusion coefficients in Group II (to characterize gas transport processes) and the use of “bench-scale weathering tests” to provide Group III data. No special permits are required for implementation of the approach.

SZNA can be used as a baseline assessment for comparing the expected performance and relative benefits of engineered remedial options. Previous work by Lundegard and Johnson (2006) developed a method for assessment of SZNA at petroleum hydrocarbon impacted sites (Johnson et al., 2006). The work demonstrated a practical, multiple lines of evidence approach for assessing the SZNA processes for LNAPLs and will be useful background for investigators looking to assess SZNA at CAH DNAPL sites. The work anticipates common questions that impact the site decision making process including:

1. Is SZNA occurring, and if so, what processes contribute?
2. What are the current rates of mass depletion?
3. What are the longer term impacts for groundwater and vapor related impacts?
4. Are the rates sustainable?

The approach provided a basic framework for site specific SZNA assessment at LNAPL sites and was subsequently adopted by the Interstate Technology Research Council (ITRC, 2009). The basic framework developed in that work was utilized here as a foundation from which to develop specific guidance for SZNA assessment at CAH DNAPL sites.

9.0 REFERENCES

- Abranovic, D., Johnson, P., Charbeneau, R., & Hemstreet, T., 2001, A graphical approach for determining dilution-attenuation factors: Basic theory and approach for submerged sources: *Ground Water Monitoring & Remediation*, 21(1), 115-124.
- Anderson, M., Johnson, R., & Pankow, J., 1992a, Dissolution of dense chlorinated solvents into groundwater: 1. dissolution from a well-defined residual source: *Ground Water*, 30(2), 250-256.
- Anderson, M., Johnson, R., & Pankow, J., 1992b, Dissolution of dense chlorinated solvents in groundwater. 3 - modeling contaminant plumes from fingers and pools of solvent: *Environmental Science & Technology*, 26(5), 901-908.
- Basu, N.B., Rao, P.S.C., Poyer, I.C. , Annable, M.D. , and Hatfield, K., 2006, Flux-based assessment at a manufacturing site contaminated with trichloroethylene: *Journal of Contaminant Hydrology*, 86, 105-113.
- Bekins, B., Cozzarelli, I., Godsy, E., Warren, E., Essaid, H., & Tucillo, M. (2001). Progression of natural attenuation processes at a crude oil spill site: II. controls on spatial distribution of microbial populations. *Journal of Contaminant Hydrology*, 15(53), 387-406.
- Beland-Pelletier, C., Fraser M., Barker, J., and Ptak, T., 2011, Estimating contaminant mass discharge: A field comparison of the multilevel point measurement and the integral pumping investigation approaches and their uncertainties: *Journal of Contaminant Hydrology*, 122, 63-75.
- Brauner, J., & Widdowson, M. (2001). Numerical simulation of a natural attenuation experiment with a petroleum hydrocarbon NAPL source. *Ground Water*, 39(6), 939-952.
- Brooks, M., Wood, L., Annable, M., Hatfield, K., Cho, J., Holbert, C., . . . Smith, R., 2008, Changes in contaminant mass discharge from DNAPL source mass depletion: Evaluation at two field sites: *Journal of Contaminant Hydrology*, 102, 140-153.
- Brusseau, M.L., Hatton, J., and DiGuseppi, W., 2011, Assessing the impact of source-zone remediation efforts at the contaminant-plume scale through analysis of contaminant mass discharge: *Journal of Contaminant Hydrology*, 126, 130-139.
- Brusseau, M.L., Matthieu III, D. E., Carroll, K. C., Mainhagu, J., Morrison, C., McMillan, A., Russo, A., and Plaschke, M., 2013, Characterizing long-term contaminant mass discharge and the relationship between reductions in discharge and reductions in mass for DNAPL source areas: *Journal of Contaminant Hydrology*, 149, 1-12.

- Chapelle, F., Widdowson, M., Brauner, J., Mendez III, E., and Casey, C. C., 2003, Methodology for estimating times of remediation associated with monitored natural attenuation: Water Resources Investigations Report 03-4057, U.S. Geological Survey, 51p.
- Cho, J. S., Wilson, J. T., and Beck, F. J., 2000, Measuring vertical profiles of hydraulic conductivity with in situ direct-push methods: *Journal of Environmental Engineering*, 126(8), 775-777.
- Christ, JA, Ramsburg, C. A., Pennell, K. D., and Abriola, L. M., 2006, Estimating mass discharge from dense nonaqueous phase liquid source zones using upscaled mass transfer coefficients: An evaluation using multiphase numerical simulations: *Water Resources Research* 42, (11):
- Cozzarelli, I., Bekins, B., Baedecker, M., Aiken, G., Eganhouse, R., and Tucillo, M., 2001, Progression of natural attenuation processes at a crude-oil spill site: I. geochemical evolution of the plume: *Journal of Contaminant Hydrology*, 53(3-4), 369-385.
- Devlin, J. F., 2003, A spreadsheet method of estimating best-fit hydraulic gradients using head data from multiple wells: *Groundwater*, 41(3), 316-320.
- Falta, R. W., Suresh Rao, P., and Basu, N., 2005, Assessing the impacts of partial mass depletion in DNAPL source zones: I. analytical modeling of source strength functions and plume response: *Journal of Contaminant Hydrology*, 78(4), 259-280.
- Fure, A., Jawitz, J., and Annable, M., 2006, DNAPL source depletion: Linking architecture and flux response: *Journal of Contaminant Hydrology*, 85, 118-140.
- GSI Environmental, 2011, In Farhat, S. (Ed.), *Mass flux toolkit* (v. 2.0 ed.)
- Guerin, T., and Rhodes, S., 2000, Natural bioremediation of NZAS diesel spill: *Rio Tinto* Technical Services Report.
- Guilbeault, M., Parker, B., and Cherry, J., 2005, Mass and flux distributions from DNAPL zones in sandy aquifers: *Ground Water*, 43(1), 70-86.
- ITRC, 2002, DNAPL source reduction: Facing the challenge: Interstate Technology Regulatory Council, Washington D.C..
- ITRC, 2009, Evaluating natural source zone depletion at sites with LNAPL: Interstate Technology and Research Council, Washington, D.C..
- Johnson, P., Bruce, C., Johnson, R., and Kemblowski, M., 1998, *In situ* measurement of effective vapor-phase porous media diffusion coefficients: *Environmental Science & Technology*, 32, 3405-3409.

- Johnson, P., Lundegard, P., and Liu, Z., 2006, Source zone natural attenuation at petroleum hydrocarbon spill sites - I: Site specific assessment approach: *Ground Water Monitoring and Remediation*, 26(4), 82-92.
- Kavanaugh, M., and MacDonald, J., 1994, Restoring contaminated groundwater: An achievable goal?: *Environmental Science & Technology*, 28, 362-368.
- Krajmalnik-Brown, R., Holscher, T., Thomson, I., Saunders, M., and Loeffler, F., 2004, Genetic identification of a putative vinyl chloride reductase in *Dehalococcoides* sp. strain BAV1: *Applied and Environmental Microbiology*, 70(10), 6347-6351.
- Kubert, M., and Finkel, M., 2006, Contaminant mass discharge estimation in groundwater based on multi-level point measurements: A numerical evaluation of expected errors: *Journal of Contaminant Hydrology*, 84: 55-80.
- Lemke, L., Abriola, L., and Lang, J., 2004, Influence of hydraulic property correlation on predicted dense nonaqueous phase liquid source zone architecture, mass recovery and contaminant flux: *Water Resources Research*, 40, W12417.
- Lenski, R.A., 2004, Assessment of Source Zone Longevity at the Former Williams Air Force Base, Arizona: Masters Thesis, Arizona State University.
- Li, K., Goovaerts, P., and Abriola, L., 2007, A geostatistical approach for quantification of contaminant mass discharge uncertainty using multilevel sampler measurements. *Water Resources Research*, 43, W06436.
- Liu, Z., 2004, A study of bench-scale accelerated weathering tests: Ph.D. Dissertation, Arizona State University.
- Löffler, F.E., Ritalahti, K.M. and Tiedje, J.M., 1997, Dechlorination of chloroethenes is inhibited by 2-bromoethanesulfonate in the absence of methanogens: *Applied and Environmental Microbiology*, 63, 4982-4985.
- Lundegard, P., and Johnson, P., 2006, Source zone natural attenuation at petroleum hydrocarbon spill sites - II: Application to a former oil field: *Ground Water Monitoring and Remediation*, 26(4), 93-106.
- Mackay, D. M., Einarson, M. D., Kaiser, P. M., Nozawa-Inoue, M., Goyal, S., Chakraborty, I., Rasa, E., Scow, K. M., 2012, Mass discharge in a tracer plume: Evaluation of the theissen polygon method: *Ground Water*, 50(6), 895-907.
- Millington, R., and Quirk, J., 1961, Permeability of porous solids: *Transaction of the Faraday Society*, 57(0), 1200-1207.

- Newell, C., Cowie, I., McGuire, T., & McNab, W., 2006, Multiyear temporal changes in chlorinated solvent concentrations at 23 monitored natural attenuation sites: *Journal of Environmental Engineering*, 132(6), 653-663.
- NRC, 1994, *Alternatives for ground water cleanup*: The National Academies Press.
- NRC, 2000, *Natural attenuation for groundwater remediation*: The National Academies Press, Washington, D.C..
- NRC, 2013, *Alternatives for managing the nation's complex contaminated groundwater sites*, The National Academies Press, Washington, D.C..
- Parker, J., and Park, E., Tang, G., 2008, Dissolved plume attenuation with DNAPL source remediation, aqueous decay and volatilization--analytical solution, model calibration and prediction uncertainty: *Journal of Contaminant Hydrology*, 102(1-2), 61-71.
- Sihota, N., Singurindy, O., and Mayer, K., 2011, CO₂ efflux measurements for evaluation source zone natural attenuation rates in a petroleum hydrocarbon contaminated aquifer: *Environmental Science and Technology*, 45, 482-488.
- Stroo, H.F., Leeson, A., Marqusee, J.A., Johnson, P. C., Ward, C. H., Kavanaugh, M.C., Sale, T. C., Newell, C.J., Pennell, K. D., Lebron, C. A., and Unger, M., 2012, Chlorinated ethene source remediation: Lessons learned: *Environmental Science and Technology* 46, 6438-6447.
- Triplett Kingston, J.T., Dahlen, P. R., Johnson, P. C., 2012, Assessment of groundwater quality improvements and mass discharge reductions at five *in situ* electrical resistance heating remediation sites: *Ground Water Monitoring and Remediation*, 32 (3). 41-51.
- U.S. EPA., 2003, *The DNAPL remediation challenge: Is there a case for source depletion?*: EPA-600-R-03-143, Cincinnati, Ohio.
- U.S. EPA., 2012, *Test methods for evaluating solid waste (SW-846)*: Retrieved, 2012, from <http://www.epa.gov/osw/hazard/testmethods/sw846/online/>
- Vroblecky, D., Petkewich, M., Landmeyer, J., & Lowery, M., 2009, *Source, transport, and fate of groundwater contamination at site 45, marine corps recruit depot, Parris Island, South Carolina*: US Geological Survey Scientific Investigations Report 2009-5161.

APPENDIX A: POINTS OF CONTACT

POINT OF CONTACT Name	ORGANIZATION Name Address	Phone Fax E-mail	Role in Project
Paul C. Johnson	Arizona State University, Tempe, AZ, 85287	(480) 965-9115; paul.c.johnson@asu.edu	Principal Investigator
Ryan Ekre	Arizona State University, Tempe, AZ, 85287	ryan.ekre@asu.edu	Field sampling, data processing, reporting
Bruce Rittman	Arizona State University, Tempe, AZ, 85287	rittman@asu.edu; (480) 727-0434	Co-investigator
Rosa Krajmalnik-Brown	Arizona State University, Tempe, AZ, 85287	Dr.rosy@asu.edu	Co-investigator
Paul D. Lundegard	LundegardUSA, 950 Carya Court, Great Falls, VA, 22066	(714) 323-1058; paul@lundegardusa.com	Technical advisor
Rob Hinchee	IST, 1509 Coastal Highway, Panacea, FL, 32346	(850) 984-4460 rob@hinchee.org	Technical advisor

APPENDIX B – SITE 1 NAS JACKSONVILLE



Data Analysis Report

Field Event 4: NAS Jacksonville

Operable Unit 3, Building 106, PSC48
Naval Air Station Jacksonville (NAS JAX)
Jacksonville, Florida

ESTCP Project ER-0705:
Assessment of the Natural Attenuation of NAPL Source
Zones and Post-Treatment NAPL Source Zones

May, 2012

Tables

Table 1	Geologic Description of NAS Jacksonville Based on Continuous Direct-Push Soil Core: Event 1 - August 6-15, 2009
Table 2	Depth-to Water Measurements and Calculated Groundwater Elevations for Permanent Monitoring Wells: Events 1, 2, 3, and 4
Table 3	Hydraulic Conductivity Estimates ¹ for Depth-Discrete Aquifer Specific-Capacity Testing: Events 1, 2, 3, and 4
Table 4A	Water Quality Data for Depth-Discrete, Direct Push Groundwater Samples: Event 1 – August 6-15, 2009
Table 4B	Water Quality Data for Depth-Discrete, Direct Push Groundwater Samples: Event 2 – January 9-22, 2011
Table 4C	Water Quality Data for Depth-Discrete, Direct Push Groundwater Samples: Event 3 – June 4-13, 2011
Table 4D	Water Quality Data for Depth-Discrete, Direct Push Groundwater Samples: Event 4 – September 20-30, 2011
Table 5A	Ion Concentration Data for Depth-Discrete, Direct Push Groundwater Samples: Event 1 – August 6-15, 2009
Table 5B	Ion Concentration Data for Depth-Discrete, Direct Push Groundwater Samples: Event 2 – January 9-22, 2011
Table 5C	Ion Concentration Data for Depth-Discrete, Direct Push Groundwater Samples: Event 3 – June 4-13, 2011
Table 5D	Ion Concentration Data for Depth-Discrete, Direct Push Groundwater Samples: Event 4 – September 20-30, 2011
Table 6	DOC Concentration Data for Depth-Discrete, Direct Push Groundwater Samples: Events 1, 2, 3, and 4.
Table 7	COD Data for Depth-Discrete, Direct Push Groundwater Samples: Events 1, 2, 3, and 4.
Table 8	Alkalinity Data for Depth-Discrete Direct Push Groundwater Samples: Events 1, 2, 3, and 4.
Table 9A	VOC Concentration Data for Depth-Discrete Groundwater Samples:

Event 1 – August 6-15, 2009

Table 9B VOC Concentration Data for Depth-Discrete Groundwater Samples:

Event 2 – January 9-22, 2011

Table 10	VOC Soil Extractions: Event 2 – January 9-22, 2011
Table 11A	Dehalococcoides Testing: Event 1 – August 6-15, 2009
Table 11B	Dehalococcoides Testing: Event 2 – January 9-22, 2011
Table 11C	Dehalococcoides Testing: Event 4 – September 20-30, 2011
Table 12A	Soil Gas Concentration Data: Event 1 – August 6-15, 2009
Table 12B	Soil Gas Concentration Data: Event 2 – January 9-22, 2011
Table 12C	Soil Gas Concentration Data: Event 3 – June 4-13, 2011
Table 12D	Soil Gas Concentration Data: Event 4 – September 20-30, 2011
Table 13A	Diffusion Coefficients: Event 1 – August 6-15, 2009
Table 13B	Diffusion Coefficients: Event 2 – January 9-22, 2011
Table 13C	Diffusion Coefficients: Event 3 – June 4-13, 2011
Table 13D	Diffusion Coefficients: Event 4 – September 20-30, 2011
Table 14	Vapor Flux and Mass Loss Calculations: Events 1, 2, 3, and 4.

Figures

Figure 1	Site Map – Naval Air Station Jacksonville
Figure 2	Operable Unit 3, PSC 48 (Building 106) Site Map
Figure 3	Direct Push Water/Soil Sampling Locations: Event 1 – August 6-15, 2009
Figure 4A	Groundwater Contour Map: Event 1 – August 14, 2009
Figure 4B	Groundwater Contour Map: Event 2 – January 22, 2011
Figure 5A	Vapor Sampling Locations: Event 1 – August 6-15, 2009
Figure 5B	Vapor Sampling Locations: Event 2 – January 9-22, 2011
Figure 6A	Groundwater Concentration Vertical Transect Contour Plot:

Event 1 – August 6-15, 2009

Figure 6B Groundwater Concentration Vertical Transect Contour Plot:

Event 2 – January 9-22, 2011

Figure 7 Mass Flux Calculation Example - Inputs

Figure 8 Mass Flux Calculation – Interpolated Concentration Profile Example

Figure 9 Hydraulic Conductivity Profile Example

Figure 10 Mass Flux Calculation – Output Example

Figure 11A Transect A-A' Flux Calculations – Event 1: August 6-15, 2009

Figure 11B Transect A-A' Calculations – Event 2: January 9-22, 2011

Figure 11C Up-gradient Flux Input Calculations – Event 2: January 9-22,2011

Figure 12C Uncertainty Analysis – Example

Acronyms and Abbreviations

amsl	Above mean sea level
bgs	Below ground Surface
btoc	Below top of casing
CAH	Chlorinated aliphatic hydrocarbon
COD	Chemical oxygen demand
DCA	Dichloroethane
DCE	Dichloroethylene
DELCD	Dry electrolytic conductivity detector
Dhc	Dehalococcoides
DO	Dissolved oxygen
DOC	Dissolved organic carbon
DTW	Depth to water
EC	Electrical conductivity
ERH	Electrical resistance heating
ESTCP	Environmental Security Technology Certification Program
FID	Flame-ionization detector
ft	Feet
GC	Gas chromatography
kg	Kilogram
ND	Non-detect
NQ	Not quantified
NW	No water available for analysis
ORP	Oxidation reduction potential
PCE	Perchloroethylene
PCR	Polymerase chain reaction
sq ft	Square feet
TCA	Trichloroethane
TCE	Trichloroethylene
TOC	Top of casing
temp	Temperature
VC	Vinyl Chloride
VFA	Volatile fatty acid
VOA	Volatile organic analysis
y	Year

1.0 Introduction

Four field investigations of Operable Unit 3, Building 106, PSC-48, Naval Air Station (NAS) Jacksonville, Jacksonville, Florida under the Environmental Security Technology Certification Program (ESTCP) project ER-0705, *Assessment of the Natural Attenuation of NAPL Source Zones and Post-Treatment NAPL Source Zones*, were performed during the course of this investigation. The field investigations were performed on August 6-15, 2009; January 9-22, 2011, June 4-13, 2011 and September 20-30, 2011 for the first through fourth event respectively. Figures 1 and 2 provide a site map that identifies the specific area of interest for this field investigation.

Consistent with the objectives set forth under the ER-0705 Demonstration Plan, the field investigation at this site included the following:

- Verification of the site geological/hydro-geological conceptual model;
- Collection of samples to determine groundwater concentrations down-gradient of the source zone, and soil gas concentrations above the source zone;
- Testing to determine aquifer properties and in situ effective diffusion coefficients;
- Collection of soil and groundwater samples for identification of dehalococoides organisms.

2.0 Field Investigation

In accordance with the approved generic demonstration plan for this project, field investigations were performed to complete the objectives mentioned above. The non-site specific demonstration plan outlines the types of sampling/testing performed, the locations for which are shown in Figure 3. Site activities are as follows:

2.1 Verification of the site hydro-geological conceptual model:

- a. Basic Geologic Profile: A continuous soil core was collected for visual geologic evaluation and VOC analyses during the second field event. Using a Geoprobe Macro Core sampler, soil core sections were collected to a total depth of 30 ft bgs at the locations shown in Figure 3. The basic geologic profile constructed from this soil core is presented in Table 1.
- b. Depth-to-water: Depth-to-water (DTW) was measured in select permanent monitoring wells to determine groundwater elevation, flow direction, and hydraulic gradient. Table 2 contains DTW data for selected sampling locations. Based on data collected, the dominant groundwater flow direction is to the southeast with an average gradient of 0.005 ft/ft. Event specific calculated hydraulic gradient data may be found in Figures 4A-4D.

- c. Hydraulic Conductivity Testing – Aquifer Specific-Capacity Tests: Depth-discrete, aquifer specific-capacity tests were conducted at direct push locations ASU-1 through ASU-8, 12 and 13 (see Figure 3). Aquifer specific-capacity tests involve the measurement of the steady-state flowrate achieved under a fixed drawdown, and the hydraulic conductivity is estimated using those data and the Moye equation. Aquifer specific-capacity tests are described in further detail in the non-site-specific version of the Demonstration Plan and in Cho et al (2000). Hydraulic conductivity results from the aquifer specific-capacity testing are shown in Table 3.

2.2 Collection and analysis of groundwater samples to determine groundwater concentrations and the presence of dehalococcoides microorganisms:

- a. Depth-Discrete Groundwater Sampling: Depth-discrete groundwater sampling was performed at direct push locations ASU-1 through ASU-8, 12 and 13 shown in Figure 3. Groundwater samples were collected using a Geoprobe Screen point Sampler and a peristaltic pump. Groundwater samples were collected and preserved as outlined in the non-site-specific Demonstration Plan.
- b. Depth Discrete Groundwater Sample Analysis: At the time of groundwater sample collection, field water quality parameters including pH, electrical conductivity (EC), temperature (T), dissolved oxygen (DO), and oxidation reduction potential (ORP) were measured. Field water quality data are shown in Table 4.

General water chemistry analyses including anions (Cl^- , NO_3^{2-} , SO_4^{2-}), cations (Fe^{2+} , Mn^{2+}) dissolved organic carbon (DOC), chemical oxygen demand (COD), and alkalinity were performed as possible on all direct push samples collected. General water chemistry analyses were performed as outlined in the non-site-specific Demonstration Plan. General water chemistry data are found in Tables 5, 6, 7, and 8.

Volatile organic hydrocarbon (VOC) analyses were performed on-site by heated-headspace analysis and gas chromatography (GC) using a dry electrolytic conductivity detector (DELCD) and/or a flame-ionization detector (FID); the details of these analyses are provided in the non-site-specific demonstration plan. Data for VOC analyses are found in Table 9.

- c. Dehalococcoides Analysis: Water Samples were collected to look for the presence of Dehalococcoides chlorinated hydrocarbon biodegrader populations. One-liter (1 L) samples were collected during the first and second field events at the depth-discrete, direct push locations shown in Table 1. Samples were extracted using a Mobio Water DNA Extraction Kit and amplified using nested PCR (polymerase chain reaction). Results for general bacterial and dehalococcoides testing are found in Table 11.

2.3 Collection of samples necessary to determine soil gas concentrations above the source zone:

Soil Gas Sampling and Analysis: Soil gas samples were collected from temporary soil gas sampling installations within the source zone area, as shown in Figure 5. Using a Geoprobe slide hammer, a 1-inch drive rod, and disposable stainless steel drive tips, 6” Geoprobe soil gas sampling implants were installed at approximately 1.0 ft and 2.5 ft bgs. Soil gas sampling implants were installed with a sand-pack and cement-bentonite seal to prevent surface leakage. Vapor samples were collected in tedlar bags using a lung sampler and were analyzed on-site at the time of collection by gas chromatography (GC) using a dry electrolytic conductivity detector (DELCD) and/or a flame-ionization detector (FID). Soil gas sampling results are summarized in Table 12. To verify the integrity of the soil gas implants helium was used as a tracer to determine if ambient air leakage was diluting the samples. To do this, a helium halo was used as is described by Banikowski et al. (2009). Helium was not detected above any of the vapor sampling locations during the integrity testing

- a. Effective Soil Diffusion Coefficient Testing: In situ diffusion tests were performed at all soil gas sampling locations. After installation of the sampling point and collection of a soil gas sample, 1 L of a mix of up to 10% v/v helium in soil gas was injected into the sample interval. After waiting a predetermined amount of time, 1 L of soil gas was withdrawn for helium analysis. The measured effective soil gas diffusion coefficients are presented in Table 13. Further description of diffusion testing may be found in Johnson et al (1998).
- b. During the first field sampling event at NAS Jax the concrete slab and foundation from the demolished building 106 was still intact. Due to the stability of the slab it was not possible to sample directly beneath the slab. However prior to the second sampling event the slab was removed, the site graded and paved with asphalt. Slightly different construction methods were used on asphalt overlaying the now removed building. Under the new asphalt there was no underlayment and the asphalt is in direct contact with the soil; however under the older asphalt directly adjacent to the former building an underlayment of crushed shell was used. This difference is believed to result in a significant variation between vapor flux in the new asphalt vs. the older.
- c. Data reduction activities included first converting all dissolved and soil gas concentrations to “equivalent PCE” concentrations, as this is needed to account for the unmeasured constituents that are also part of the source zone mass loss (i.e., Cl⁻ ions lost when dechlorination occurs) when successive dechlorination steps occur. For NAS Jacksonville reporting, all CAH constituents were converted to PCE equivalents using adjustment factors based on the molar equivalence of each compound to PCE. Adjustment factors are shown as a secondary table under Table 15. Details concerning the use of PCE equivalents and calculation of adjustment factors are discussed in the updated source zone natural attenuation guidance submitted to ESTCTP under this ESTCP project.
- d. Figure 6 shows a chemical concentration (PCE equivalents) contour plot along for the vertical transect A-A’ shown in Figure 3, using dissolved CAH concentration data from direct push locations ASU2 through ASU8. Transect A-A’ is drawn

roughly perpendicular to the dominant groundwater flow direction and data from the sampling locations are projected onto this transect.

Using the converted PCE equivalents groundwater concentration data, depth-discrete hydraulic conductivity measurements (see Table 3), and the event specific hydraulic gradients, a groundwater mass discharge calculation was performed using the Mass Flux Toolkit, Version 1.0. The Mass Flux Toolkit is a freeware program developed by Groundwater Services, Inc. and others under a contract funded by ESTCP. Figure 7 presents a snapshot of the input screen for the mass flux analysis. There are three interpolation schemes available for analysis within the Mass Flux Toolkit, and all possible combinations of interpolation schemes were tested in order to assess the sensitivity of the results to the interpolation scheme used. An example of the interpolated hydraulic conductivity and concentration profiles generated by various interpolation schemes are displayed in Figures 8 and 9. Figure 10 shows as an example the output of the linear interpolation scheme for the mass flux result for all chlorinated aliphatic hydrocarbons expressed consistently as PCE equivalents. During the second field event (Jan 2011) concentrations of chlorinated solvents were detected in up-gradient wells (ASU1). To better define the flux input into the source zone, two additional locations were sampled on the up-gradient edge of the source. The resulting VOC profiles were used to estimate the flux input from up-gradient contamination. This resulting input flux was subtracted from the flux through transect A-A'. The input flux to the source zone can be found in Figure (12). ASU Mass flux results from nine possible interpolation combinations are summarized in Figure 11. The results are similar for all methods, with the difference between the lowest and highest value being only about a factor of two.

The Mass Flux Toolkit contains an uncertainty analysis that allows users to identify specific data points that most influence the calculated results. Use of this option with several interpolation options indicated that the calculated mass flux was most sensitive to changes in the hydraulic conductivity profile, especially in the vicinity of ASU5 (see results in Figure 12). Thus, these results suggest that uncertainty in the mass flux estimate might be decreased by increasing the sampling resolution near ASU5, as a large contribution to the overall mass flux comes through this section of the transect.

To accomplish this during subsequent sampling events, additional samples were collected on either side of ASU5 at depths vertically off-set from those at ASU5. This approach was used rather than increased vertical resolution in a single borehole because it is felt that the additional horizontal resolution will provide additional bounds to the contour profile. This also had the benefit of allowing us to retain the same sampling point and depths at ASU5 for the benefit of data continuity, while adding more resolution and allowing us to better define the bounds of the highly conductive zone.

Using CAH soil gas concentration data (also converted to PCE equivalents), measured in situ effective diffusion coefficients, and an estimated source zone area footprint of 2800 m², the source zone mass loss rate associated with vapor transport was calculated. Vapor mass discharge estimates for each well, and adjustment factors are located in Table 12. Event specific vapor mass discharge rates may be found in Table 14.

3.0 References

- Banikowski, Jeffrey, Swiatoslav Kaczmar, and John Hunt. "Field Validation of Helium as a Tracer Gas During Soil Vapor Sample Collection." *Soil & Sediment Contamination*. 18. (2009): 243-263. Print
- Bechtel Environmental, Inc. 1996. *Remedial Work Plan for Interim Removal Action, Buildings 106 and 780 at OU 3, NAS Jacksonville, Jacksonville, Florida*. Prepared for SOUTHNAVFACENGCOM, North Charleston, SC (August 1996).
- CH2MHILL Inc. June 2003. *Annual Operations and Maintenance Status Report - Air Sparge and Soil Vapor Extraction System - Building 106 Naval Air Station Jacksonville, Jacksonville, Florida* (Contract No. N62467-98-D-0995)
- Cho, Jon Soo, J.T.Wilson, F.P Beck Jr. "Measuring Vertical Profiles of Hydraulic Conductivity with In Situ Direct-Push Methods." *Journal of Environmental Engineering*. (2000): 775-777. Print
- Fetter, C.W. 2000. *Applied Hydrogeology*. 4th ed. Upper Saddle River, New Jersey: Prentice-Hall. pp.197-200.
- Harding Lawson Associates, 2000. *Remedial Investigation and Feasibility Study (RIFS) OU3, NAS Jacksonville, Jacksonville, Fl*. Report (April 2000) to NavFac, North Charleston, SC (Contract No. N62467-89-D-0317/146)
- Johnson,P.C., Cristin Bruce, Richard Johnson and Mariush Kembrowski. "In Situ Measurement of Effective Vapor-Phase Porouse Media Diffusion Coefficients". *Environmental Science and Technology* 32. (1998)) 2405-2409. Print
- Mass Flux Toolkit. GSI Environmental. V1.0. Toolkit located at http://www.gsi-net.com/Software/massflx_dl/main_massflx.asp

Tables

Table 1:

Geologic Description of NAS Jacksonville Based on Continuous Direct-Push Soil Core:

Event 1 - August 6-15, 2009

Depth (ft bgs)	Description
0 – 0.5	Asphalt
0.5 – 1.5	Fine sand with gravel
1.5 – 5	Fine sand with silt/clay
5 – 6	Clay with trace sand and organic matter
6 – 7.5	Clay/silt with fine sand and organic matter
7.5 – 13	Fine sand/silt
13 – 16.5	Fine sand with silt/clay
16.5 – 18.5	Clay/silt with trace fine sand
18.5 – 20	Clay with 1” fine sand lens at ~18.75ft bgs
20 – 21.25	Clay with trace fine sand
21.25 – 25	Clay with 1” fine sand lens at ~23ft bgs
25 – 27.5	Fine sand with silt/clay
27.5 – 30	Fine sand with trace silt/clay

Table 2

Depth-to Water Measurements and Calculated Groundwater

Elevations for Permanent Monitoring Wells: Events 1, 2, 3, and 4

Location	Elev TOC	DTW				GW Elevation			
	(ft amsl)	(ft btoc)				(ft amsl)			
		Evt 1	Evt 2	Evt 3	Evt 4	Evt 1	Evt 2	Evt 3	Evt 4
PZ-1061	11.78	2.97	4.71	4.98	4.75	8.81	7.07	6.80	7.03
PZ-1062	11.73	2.99	4.68	4.95	4.70	8.74	7.05	6.78	7.03
PZ-1063	11.98	3.28	4.85	5.12	5.25	8.7	7.13	6.86	6.73
PZ-1064	11.41	3.43	---	5.00	4.65	7.98	---	6.41	6.76
PZ-1065	11.48	3.53	4.70	5.00	4.70	7.95	6.78	6.48	6.78
PZ-1066	11.78	3.88	5.05	5.50	5.10	7.9	6.73	6.28	6.68
PZ-1067	12.17	4.48	5.70	5.90	5.80	7.69	6.47	6.27	6.37
PZ-1068	11.48	3.85	---	---	5.10	7.63	---	---	6.38
MW028	---	3.58	5.0	5.20	---	---	---	---	---

--- -- No Data

Event 1: Aug 14, 2009

Event 2: Jan 22, 2011

Evt -- Event

Event 3: June 13, 2011

Event 4: Sept 30, 2011

Table 3:

Hydraulic Conductivity Estimates¹ for Depth-Discrete Aquifer Specific-Capacity Testing: Events 1, 2, 3, and 4

K (cm/sec)								
Depth (ft bgs)	ASU 1				ASU 2			
	<u>Evt 1</u>	<u>Evt 2</u>	<u>Evt 3</u>	<u>Evt 4</u>	<u>Evt 1</u>	<u>Evt 2</u>	<u>Evt 3</u>	<u>Evt 4</u>
10	1.9 x 10 ⁻³	8.2 x 10 ⁻⁴	1.5 x 10 ⁻³	2.5 x 10 ⁻⁴	1.3 x 10 ⁻⁵	1.2 x 10 ⁻⁵	6.5 x 10 ⁻³	8.8 x 10 ⁻⁴
15	---	X	X	X	6.4 x 10 ⁻⁵	X	X	X
17	X	1.1 x 10 ⁻⁴	---	3.7 x 10 ⁻⁵	X	3.7 x 10 ⁻⁵	2.1 x 10 ⁻⁵	3.8 x 10 ⁻⁵
22	---	X	X	X	1.4 x 10 ⁻⁴	X	X	X
25	X	7.2 x 10 ⁻⁵	6.4 x 10 ⁻⁴	4.0x10 ⁻⁶	X	5.3 x 10 ⁻⁴	4.6 x 10 ⁻³	1.8 x 10 ⁻³
30	2.1 x 10 ⁻⁵	3.4 x 10 ⁻⁵	---	7.8 x 10 ⁻⁵	7.0 x 10 ⁻⁴	9.1 x 10 ⁻⁴	2.1 x 10 ⁻⁴	1.4 x 10 ⁻³
35	2.6 x 10 ⁻⁵	6.0 x 10 ⁻⁵	---	1.1 x 10 ⁻³	3.2 x 10 ⁻⁵	2.7 x 10 ⁻⁵	---	1.7 x 10 ⁻³
45	2.0 x 10 ⁻⁴	3.5 x 10 ⁻⁴	4.0 x 10 ⁻⁴	4.6 x 10 ⁻⁴	5.4 x 10 ⁻⁴	5.0 x 10 ⁻⁴	6.2 x 10 ⁻⁴	9.1 x 10 ⁻⁴
60	---	1.1 x 10 ⁻⁴	---	1.9 x 10 ⁻⁴	---	2.4 x 10 ⁻⁴	---	5.5 x 10 ⁻⁴
K (cm/sec)								
Depth (ft bgs)	ASU 2B				ASU 3			
	<u>Evt 1</u>	<u>Evt 2</u>	<u>Evt 3</u>	<u>Evt 4</u>	<u>Evt 1</u>	<u>Evt 2</u>	<u>Evt 3</u>	<u>Evt 4</u>
10	X	1.9 x 10 ⁻⁴	9.5 x 10 ⁻⁴	6.8 x 10 ⁻⁵	1.4 x 10 ⁻⁵	9.3 x 10 ⁻⁴	2.2 x 10 ⁻³	2.8 x 10 ⁻⁴
15	X	X	X	X	6.9 x 10 ⁻⁵	X	X	X
17	X	1.9 x 10 ⁻⁴	2.7 x 10 ⁻⁵	3.0 x 10 ⁻⁵	X	9.1 x 10 ⁻⁵	7.6 x 10 ⁻⁵	1.9 x 10 ⁻⁵
22	X	X	X	X	---	X	X	X
25	X	---	1.8 x 10 ⁻⁵	8.0 x 10 ⁻⁴	X	1.3 x 10 ⁻³	2.1 x 10 ⁻³	3.9 x 10 ⁻³
30	X	3.2 x 10 ⁻⁴	1.2 x 10 ⁻³	3.5 x 10 ⁻⁴	9.5 x 10 ⁻⁴	1.2 x 10 ⁻³	8.4 x 10 ⁻⁴	3.0 x 10 ⁻³
35	X	4.0 x 10 ⁻⁵	3.8 x 10 ⁻⁴	2.6 x 10 ⁻⁴	5.7 x 10 ⁻⁴	4.9 x 10 ⁻⁴	2.2 x 10 ⁻³	2.5 x 10 ⁻³
45	X	---	---	5.0 x 10 ⁻⁵	1.2 x 10 ⁻⁴	2.2 x 10 ⁻⁴	4.4 x 10 ⁻⁴	3.8 x 10 ⁻⁴
60	X	9.3 x 10 ⁻⁵	2.0 x 10 ⁻³	---	---	2.9 x 10 ⁻⁴	7.0 x 10 ⁻⁴	7.2 x 10 ⁻⁴

		K (cm/sec)							
Depth (ft bgs)	ASU 4				ASU 5				
	<u>Evt 1</u>	<u>Evt 2</u>	<u>Evt 3</u>	<u>Evt 4</u>	<u>Evt 1</u>	<u>Evt 2</u>	<u>Evt 3</u>	<u>Evt 4</u>	
10	9.2×10^{-4}	1.1×10^{-3}	3.0×10^{-5}	3.8×10^{-4}	1.3×10^{-5}	3.3×10^{-4}	1.3×10^{-4}	7.9×10^{-5}	
15	1.3×10^{-4}	X	X	X	2.0×10^{-4}	X	X	X	
17	X	5.1×10^{-5}	5.7×10^{-5}	8.6×10^{-5}	X	8.6×10^{-5}	7.3×10^{-5}	4.4×10^{-5}	
22	---	X	X	X	---	X	X	X	
25	X	4.4×10^{-4}	2.5×10^{-3}	2.3×10^{-3}	X	1.9×10^{-3}	2.5×10^{-3}	4.2×10^{-4}	
30	6.6×10^{-5}	4.2×10^{-4}	3.5×10^{-3}	1.6×10^{-3}	7.5×10^{-6}	3.6×10^{-4}	3.4×10^{-4}	7.2×10^{-3}	
35	3.4×10^{-5}	8.6×10^{-4}	7.4×10^{-6}	5.2×10^{-4}	4.3×10^{-5}	4.2×10^{-5}	6.3×10^{-5}	3.3×10^{-3}	
45	5.6×10^{-4}	4.2×10^{-4}	4.9×10^{-4}	8.7×10^{-4}	1.2×10^{-3}	1.3×10^{-3}	6.5×10^{-5}	2.7×10^{-3}	
60	---	2.1×10^{-3}	3.2×10^{-4}	1.5×10^{-3}	---	1.2×10^{-4}	1.4×10^{-3}	5.8×10^{-4}	

Evt - Event

Event 1: Aug 6-15, 2009

X – No Sample for Analysis

Event 2: Jan 9-22, 2011

1 – Moye Method (Cho et al 2000)

Event 3: June 4-13, 2011

--- – Not enough water for analysis

Event 4: Sept 20-30, 2011

(Table 3 Continues)

(Table 3 Continued)

K (cm/sec)								
Depth (ft bgs)	ASU 6				ASU 7			
	<u>Evt 1</u>	<u>Evt 2</u>	<u>Evt 3</u>	<u>Evt 4</u>	<u>Evt 1</u>	<u>Evt 2</u>	<u>Evt 3</u>	<u>Evt 4</u>
10	6.5 x 10 ⁻⁴	2.2 x 10 ⁻³	4.8 x 10 ⁻⁴	2.8 x 10 ⁻⁵	1.6 x 10 ⁻⁴	6.6 x 10 ⁻⁵	1.2 x 10 ⁻³	1.4 x 10 ⁻⁴
15	8.8 x 10 ⁻⁵	X	X	X	8.4 x 10 ⁻⁵	X	X	X
17	X	1.2 x 10 ⁻⁴	2.2 x 10 ⁻⁴	4.4 x 10 ⁻⁵	X	4.9 x 10 ⁻⁵	8.3 x 10 ⁻⁵	3.4 x 10 ⁻⁵
22	---	X	X	X	---	X	X	X
25	X	5.7 x 10 ⁻⁴	8.3 x 10 ⁻⁴	3.0 x 10 ⁻⁵	X	5.6 x 10 ⁻⁴	2.1 x 10 ⁻³	9.5 x 10 ⁻⁴
30	9.2 x 10 ⁻⁴	7.0 x 10 ⁻⁴	7.5 x 10 ⁻⁴	2.1 x 10 ⁻³	6.7 x 10 ⁻⁵	1.7 x 10 ⁻³	1.4 x 10 ⁻³	1.9 x 10 ⁻³
35	7.2 x 10 ⁻⁵	4.4 x 10 ⁻⁴	4.5 x 10 ⁻⁵	3.2 x 10 ⁻³	4.1 x 10 ⁻⁵	---	8.9 x 10 ⁻⁵	1.0 x 10 ⁻⁵
45	1.3 x 10 ⁻³	2.4 x 10 ⁻⁴	4.8 x 10 ⁻⁴	3.2 x 10 ⁻³	2.4 x 10 ⁻⁵	3.0 x 10 ⁻⁵	2.9 x 10 ⁻⁴	2.1 x 10 ⁻³
60	---	1.9 x 10 ⁻⁵	1.2 x 10 ⁻³	3.7 x 10 ⁻⁴	---	---	7.0 x 10 ⁻⁴	4.3 x 10 ⁻⁴
K (cm/sec)								
Depth (ft bgs)	ASU 8				ASU 9			
	<u>Evt 1</u>	<u>Evt 2</u>	<u>Evt 3</u>	<u>Evt 4</u>	<u>Evt 1</u>	<u>Evt 2</u>	<u>Evt 3</u>	<u>Evt 4</u>
10	X	8.8 x 10 ⁻⁴	2.7 x 10 ⁻⁴	3.3 x 10 ⁻⁵	X	1.7 x 10 ⁻³	X	2.1 x 10 ⁻⁴
15	X	X	X	X	X	X	X	X
17	X	1.1 x 10 ⁻⁴	7.8 x 10 ⁻⁵	7.0 x 10 ⁻⁵	X	5.1 x 10 ⁻⁵	X	8.1 x 10 ⁻⁵
22	X	X	X	X	X	X	X	X
25	X	6.9 x 10 ⁻⁵	1.6 x 10 ⁻⁴	5.8 x 10 ⁻⁵	X	5.4 x 10 ⁻⁴	X	---
30	X	5.1 x 10 ⁻⁴	1.8 x 10 ⁻⁴	7.8 x 10 ⁻⁴	X	8.7 x 10 ⁻⁴	X	4.1 x 10 ⁻³
35	X	9.3 x 10 ⁻⁵	8.3 x 10 ⁻⁴	1.4 x 10 ⁻³	X	8.7 x 10 ⁻⁵	X	2.7 x 10 ⁻⁴
45	X	2.4 x 10 ⁻⁴	3.0 x 10 ⁻⁴	1.5 x 10 ⁻⁴	X	2.4 x 10 ⁻⁵	X	1.0 x 10 ⁻³
60	X	3.3 x 10 ⁻⁴	---	---	X	2.2 x 10 ⁻³	X	1.3 x 10 ⁻³
K (cm/sec)								

Depth (ft bgs)	ASU 10				ASU 11			
	<u>Evt 1</u>	<u>Evt 2</u>	<u>Evt 3</u>	<u>Evt 4</u>	<u>Evt 1</u>	<u>Evt 2</u>	<u>Evt 3</u>	<u>Evt 4</u>
10	X	2.2×10^{-4}	X	7.2×10^{-5}	X	1.7×10^{-3}	X	4.5×10^{-4}
15	X	X	X	X	X	X	X	X
17	X	7.1×10^{-5}	X	2.1×10^{-3}	X	1.1×10^{-4}	X	4.8×10^{-5}
22	X	X	X	X	X	X	X	X
25	X	4.8×10^{-4}	X	1.6×10^{-3}	X	5.0×10^{-4}	X	1.1×10^{-3}
30	X	5.1×10^{-5}	X	6.0×10^{-4}	X	1.5×10^{-3}	X	1.7×10^{-4}
35	X	1.0×10^{-4}	X	1.8×10^{-3}	X	1.2×10^{-3}	X	1.7×10^{-3}
45	X	3.4×10^{-4}	X	4.9×10^{-4}	X	---	X	3.3×10^{-4}
60	X	3.9×10^{-4}	X	1.0×10^{-3}	X	5.1×10^{-4}	X	5.7×10^{-5}

Evt - Event

Event 1: Aug 6-15, 2009

X – No Sample for Analysis

Event 2: Jan 9-22, 2011

1 – Moye Method (Cho et al 2000)

Event 3: June 4-13, 2011

--- – Not enough water for analysis

Event 4: Sept 20-30, 2011

(Table 3 Continues)

(Table 3 Continued)

K (cm/sec)								
Depth (ft bgs)	ASU 13				ASU 14			
	<u>Evt 1</u>	<u>Evt 2</u>	<u>Evt 3</u>	<u>Evt 4</u>	<u>Evt 1</u>	<u>Evt 2</u>	<u>Evt 3</u>	<u>Evt 4</u>
10	X	X	6.1 x 10 ⁻⁴	1.0 x 10 ⁻³	X	X	---	2.5 x 10 ⁻⁵
15	X	X	X	X	X	X	X	X
17	X	X	---	---	X	X	---	---
22	X	X	X	X	X	X	X	X
25	X	X	8.0 x 10 ⁻⁴	4.1 x 10 ⁻⁴	X	X	1.5 x 10 ⁻⁴	9.3 x 10 ⁻⁵
30	X	X	X	X	X	X	X	X
35	X	X	X	X	X	X	X	X
45	X	X	2.7 x 10 ⁻⁵	1.9 x 10 ⁻⁴	X	X	---	8.5 x 10 ⁻⁴
60	X	X	---	---	X	X	3.0 x 10 ⁻⁵	---

K (cm/sec)								
Depth (ft bgs)	ASU 4B				ASU 5B			
	<u>Evt 1</u>	<u>Evt 2</u>	<u>Evt 3</u>	<u>Evt 4</u>	<u>Evt 1</u>	<u>Evt 2</u>	<u>Evt 3</u>	<u>Evt 4</u>
13	X	X	X	7.5 x 10 ⁻⁵	X	X	X	1.1 x 10 ⁻⁴
23	X	X	X	8.6 x 10 ⁻⁶	X	X	X	---
27	X	X	X	4.7 x 10 ⁻³	X	X	X	9.1 x 10 ⁻⁵
40	X	X	X	2.3 x 10 ⁻³	X	X	X	1.3 x 10 ⁻⁴

Evt - Event

Event 1: Aug 6-15, 2009

X – No Sample for Analysis

Event 2: Jan 9-22, 2011

1 – Moye Method (Cho et al 2000)

Event 3: June 4-13, 2011

--- – Not enough water for analysis

Event 4: Sept 20-30, 2011

Table 4A

Water Quality Data for Depth-Discrete, Direct Push Groundwater Samples:

Event 1 – August 6-15, 2009

	Depth (ft bgs)	pH	EC (μ S)	T ($^{\circ}$ C)	DO (mg/L)	ORP (mV)
A S U 1	10	6.3	240	28.8	<1	36
	15	---	---	---	---	---
	22	---	---	---	---	---
	30	5.8	160	28.5	<1	7
	35	5.7	160	28.8	<1	11
	45	6.1	300	31.1	<1	-51
	60	---	---	---	---	---
A S U 2	10	---	---	---	---	---
	15	5.1	43000	27.9	<1	410
	22	5.5	13000	28.5	<1	41
	30	5.6	32000	29.0	<1	-8
	35	---	---	---	---	---
	45	6.4	2300	29.4	<1	-43
	60	---	---	---	---	---
A S U 3	10	6.0	420	30.2	<1	-24
	15	5.2	26000	30.6	<1	87
	22	---	---	---	---	---
	30	5.4	13000	31.2	<1	47
	35	5.9	18000	28.7	<1	-61
	45	5.8	7700	28.4	<1	-17
	---	---	---	---	---	---
A S U 5	10	---	---	---	---	---
	15	5.6	7400	29.3	<1	18
	22	---	---	---	---	---
	30	---	---	---	---	---
	35	6.2	690	28.1	<1	170
	45	6.1	1100	30.6	1.7	-27
	60	---	---	---	---	---
A S U 6	10	6.1	680	30.2	<1	37
	15	5.5	10000	31	<1	39
	22	---	---	---	---	---
	30	5.9	1100	30.3	<1	10
	35	6.0	500	30.0	<1	-18
	45	5.9	210	30.2	<1	7
	60	---	---	---	---	---
A S U 7	10	5.9	950	31.1	<1	17
	15	5.5	10000	30.0	<1	37
	22	---	---	---	---	---
	30	5.8	390	27.0	<1	-43
	35	5.9	200	27.1	<1	-24
	45	6.1	280	27.8	<1	-48
	---	---	---	---	---	---

	60	---	---	---	---	---
A S U 4	10	5.8	1400	29.7	<1	6
	15	5.4	16000	32.1	<1	38
	22	---	---	---	---	---
	30	6.0	1400	27.9	<1	45
	35	6.2	1500	27.9	<1	-64
	45	5.8	9300	28.0	<1	-34
	60	6.2	380	27.5	<1	-59

	60	---	---	---	---	---
--	----	-----	-----	-----	-----	-----

--- Not enough water available for analysis

<1- Dissolved oxygen values <1 mg/L are simply shown as <1

Table 4B

Water Quality Data for Depth-Discrete, Direct Push Groundwater Samples: Event 2

	Depth (ft bgs)	pH	EC (μ S)	T ($^{\circ}$ C)	DO (mg/L)	ORP (mV)		Depth (ft bgs)	pH	EC (μ S)	T ($^{\circ}$ C)	DO (mg/L)	ORP (mV)
A S U 1	10	6.2	250	20.9	1.9	59	A S U 6	10	6.3	82	23.9	<1	17
	17	5.9	5500	22.8	<1	10		17	5.5	11000	24.7	<1	62
	25	5.9	4900	24.7	<1	3		25	6.1	1100	24.9	<1	-2
	30	6.1	260	24.3	<1	-32		30	5.9	1200	23.9	<1	-19
	35	5.7	150	23.7	<1	-17		35	5.8	500	23.9	<1	-35
	45	5.6	140	24.9	<1	8		45	6.1	350	23.9	<1	-74
	60	5.9	140	23.0	<1	-1		60	---	---	---	---	---
A S U 2	10	---	---	---	---	---	A S U 7	10	---	---	---	---	---
	17	5.5	3400	18.1	---	2		17	5.6	9700	21.7	<1	-61
	25	5.7	1800	20.4	<1	7		25	6.2	780	24.4	<1	-10
	30	5.7	2600	24.4	<1	-16		30	6.1	400	24.7	<1	-22
	35	5.9	1700	19.7	<1	-25		35	---	---	---	---	---
	45	6.4	3600	24.2	<1	-120		45	6.4	230	24.0	<1	-68
	60	6.9	390	23.4	<1	-200		60	---	---	---	---	---
A S U 2 B	10	8	1600	18.9	<1	-120	A S U 8	10	5.7	440	20.8	<1	14
	17	---	---	---	---	---		17	5.7	2000	19.4	<1	14
	25	5.7	36000	23.1	<1	-38		25	5.8	370	20.7	<1	34
	30	5.7	20000	22.2	<1	-39		30	5.9	330	23.6	<1	-21
	35	6.0	4800	19.7	1.0	-35		35	5.9	200	23.1	<1	-24
	45	---	---	---	---	---		45	6.0	240	23.3	<1	-53
	60	6.3	410	21.6	<1	-70		60	5.7	130	24.0	<1	16
A S U	10	6.4	5	22.3	<1	-48	A S U	10	6.3	290	22.5	<1	-41
	17	5.3	2000	23.2	<1	52		17	5.9	16000	23.0	<1	1

3	25	5.7	4000	23.2	<1	-15
	30	5.8	4000	24	<1	-16
	35	6.0	1700	20.4	<1	-37
	45	5.9	6600	22.1	<1	-32
	60	6.3	480	22.8	<1	-100
A S U 4	10	6.3	400	22.7	<1	-30
	17	---	---	---	---	---
	25	6.0	2300	23.0	<1	-7
	30	6.0	2100	24.0	<1	-14
	35	6.2	2900	23.2	<1	-41
	45	5.9	1000	24.4	<1	-14
	60	6.5	410	24	<1	-85
A S U 5	10	6.1	240	22.5	1.51	-17
	17	5.2	11000	19.9	<1	20
	25	5.9	1800	22.9	<1	-10
	30	6.1	1400	24.7	<1	-64
	25.0	0	28	23.0	<1	-60
	45	6.1	600	22.2	<1	-56
	60	6.2	410	24.5	<1	-79

--- Not enough water available for analysis

9	25	5.5	17000	21.9	<1	27
	30	5.6	20000	24.6	<1	13
	35	5.6	15000	23.5	<1	8
	45	6.2	5	20.4	<1	-31
	60	6.2	320	25.0	<1	-44
A S U 10	10	6.2	270	23.2	<1	-2
	17	5.5	22000	23.5	<1	67
	25	5.9	2000	24.5	<1	3.0
	30	6.0	1700	21.3	<1	-16
	35	6.0	2100	25.0	<1	-23
	45	6.2	1400	22.3	<1	-25
	60	6.2	380	25.5	<1	-63
A S U 11	10	6.3	230	22.5	<1	22
	17	5.5	11000	23.2	<1	72
	25	5.6	1700	23.0	<1	-12
	30	5.7	1300	25.2	<1	0.8
	35	5.5	260	25.0	<1	28
	45	---	---	---	---	---
	60	6.6	330	22.3	<1	-170

<1- Dissolved oxygen <1 mg/L

Table 4C

Water Quality Data for Depth-Discrete, Direct Push Groundwater Samples: Event 3

	Depth (ft bgs)	pH	EC (μ S)	T ($^{\circ}$ C)	DO (mg/L)	ORP (mV)
A S U 1	10	6.0	200	25.1	<1	80
	17	NS	NS	NS	NS	NS
	25	5.8	4500	25.5	<1	52
	30	NS	NS	NS	NS	NS
	35	NS	NS	NS	NS	NS
	45	6.2	220	25.9	<1	110
	60	---	---	---	---	---
A S U 2	10	6.9	440	28.0	<1	-130
	17	---	---	---	---	---
	25	---	---	---	---	---
	30	5.5	18000	26.1	<1	-74
	35	5.8	3500	24.6	<1	-96
	45	---	---	---	---	---
	60	6.1	350	25.2	<1	-55
A S U 2 B	10	6.4	1700	29.5	<1	-86
	17	---	---	---	---	---
	25	5.3	1700	26.4	<1	31
	30	5.6	9200	27.1	<1	-3
	35	---	---	---	---	---
	45	5.8	1500	29.4	<1	-170
	60	6.7	1300	27.7	<1	-490
A S U	10	6.7	500	29.4	<1	-96
	17	5.3	15000	27.8	<1	62
A S U 6	10	6.3	510	29.2	<1	-78
	17	5.4	8100	26.2	<1	29
	25	5.4	870	26.1	<1	-23
	30	5.5	1000	26.0	<1	-18
	35	---	---	---	---	---
	45	6.0	230	27.3	<1	-110
	60	6.0	370	27.1	<1	-69
A S U 7	10	---	---	---	---	---
	17	---	---	---	---	---
	25	6.0	1300	28.1	<1	-92
	30	5.9	7100	28.1	<1	-32
	35	5.8	900	27.3	<1	1
	45	0.7	420	27.3	<1	-7
	60	5.9	180	27.9	<1	-61
A S U 8	10	6.1	230	28.5	<1	-110
	17	6.2	180	27.6	<1	-130
	25	---	---	---	---	---
	30	---	---	---	---	---
	35	5.4	350	24.4	<1	-10
	45	---	---	---	---	---
	60	5.6	300	24.6	<1	-4
A S U	10	5.9	---	38.0	<1	-56
	17	NS	NS	NS	NS	NS

3	25	5.8	3200	27.9	<1	-69
	30	5.7	11000	30.5	<1	-67
	35	5.8	13000	29.6	<1	-84
	45	5.9	5000	29.6	<1	-79
	60	6.2	340	28.1	<1	-100
A S U 4	10	---	---	---	---	---
	17	---	---	---	---	---
	25	5.9	1700	28.0	<1	-85
	30	5.4	1600	27.1	<1	-9
	35	---	---	---	---	---
	45	5.8	6400	26.5	<1	-120
	60	6.3	3700	27.2	<1	-500
A S U 5	10	---	---	---	---	---
	17	---	---	---	---	---
	25	5.8	1100	28.8	<1	-70.0
	30	5.9	1400	28.5	<1	-87
	25.0	---	---	---	---	---
	45	6.5	1400	30.8	<1	-210
	60	6.5	1430	28.6	<1	-410

1 3	25	5.9	2600	26.4	<1	-100
	30	NS	NS	NS	NS	NS
	35	NS	NS	NS	NS	NS
	45	6.3	430	28.0	<1	-170
	60	---	---	---	---	---
A S U 1 4	10	---	---	---	---	---
	17	NS	NS	NS	NS	NS
	25	5.4	2900	24.6	<1	20
	30	NS	NS	NS	NS	NS
	35	NS	NS	NS	NS	NS
	45	---	---	---	---	---
	60	6.3	2900	27.1	<1	-390

--- Not enough water available for analysis

<1- Dissolved oxygen values <1 mg/L

NS – Not Sampled

Table 4D

Water Quality Data for Depth-Discrete, Direct Push Groundwater Samples: Event 4

	Depth (ft bgs)	pH	EC (μ S)	T ($^{\circ}$ C)	DO (mg/L)	ORP (mV)		Depth (ft bgs)	pH	EC (μ S)	T ($^{\circ}$ C)	DO (mg/L)	ORP (mV)
A S U 1	10	6.3	160	28.5	<1	51	A S U 6	10	---	---	---	---	---
	17	---	---	---	---	---		17	---	---	---	---	---
	25	---	---	---	---	---		25	---	---	---	---	---
	30	---	---	---	---	---		30	5.9	1200	27.9	<1	-50
	35	5	95	26.7	<1	22		35	5.7	700	27.5	<1	-29
	45	5.2	110	25.3	<1	20		45	6.0	220	28.4	<1	-69
	60	6.2	210	26.0	<1	-95		60	6.3	340	28.5	<1	-120
A S U 2	10	6.4	2300	33.0	<1	-77	A S U 7	10	---	---	---	---	---
	17	---	---	---	---	---		17	---	---	---	---	---
	25	6.3	14000	30.7	<1	140		25	5.9	730	27.4	<1	-60
	30	6.0	1500	29.2	<1	-75		30	5.6	570	26.7	<1	-28
	35	5.9	18000	28.2	<1	-62		35	5.6	4500	26.0	<1	---
	45	6.0	1600	27.9	<1	-31		45	5.0	140	5.6	<1	51
	60	5.9	430	26.9	<1	-95		60	6.0	280	26.1	<1	-85
A S U 2 B	10	---	---	---	---	---	A S U 8	10	6.1	490	27.4	<1	18
	17	---	---	---	---	---		17	5.6	2100	27.2	<1	39
	25	6.3	26000	26.0	<1	-22		25	---	---	---	---	---
	30	5.5	15000	25.6	<1	-21		30	6.0	290	25.9	<1	35
	35	6.0	3000	26.9	<1	-50		35	6.0	270	25.6	<1	-43
	45	---	---	---	---	---		45	5.9	250	26.1	<1	-41
	60	---	---	---	---	---		60	---	---	---	---	---
A S U	10	---	---	---	---	---	A S U	10	---	---	---	---	---
	17	---	---	---	---	---		17	6.4	19000	29.7	<1	2

3	25	6.0	4200	28.9	<1	-100	9	25	---	---	---	---	---
	30	5.7	12000	28.9	<1	-61		30	5.4	19000	29.0	<1	15
	35	5.9	17000	30.2	<1	-70		35	5.5	18000	27.4	<1	-9
	45	---	---	---	---	---		45	5.8	1100	27.0	<1	10
	60	6.7	1200	27.3	<1	-170		60	6.0	1200	27.1	<1	-27
ASU 4	10	6.8	1800	30.2	---	-120	ASU 10	10	---	---	---	---	---
	17	---	---	---	---	---		17	5.8	2400	28.6	<1	28
	25	6.5	2400	27.4	<1	-140		25	5.4	2900	28.0	<1	-23
	30	6.0	2200	25.4	<1	-65		30	6.1	1800	30.4	<1	-72
	35	6.0	1800	27.1	<1	-59		35	6.0	2500	29.2	<1	-76
	45	6.0	9100	27.5	---	-99		45	6.0	1700	29.2	<1	-42
	60	6.3	650	27.0	<1	-160		60	6.2	1600	28.6	<1	-85
ASU 5	10	---	---	---	---	---	ASU 11	10	---	---	---	---	---
	17	---	---	---	---	---		17	---	---	---	---	---
	25	5.6	1900	27.6	<1	-29		25	6.1	1600	30.6	<1	-63
	30	5.6	930	26.6	<1	-3		30	5.9	1300	30.7	<1	-63
	35	5.7	170	26.5	<1	5		35	6.1	360	29.7	<1	-77
	45	5.8	1100	27.1	<1	-11		45	6.1	230	29.1	<1	-83
	60	6.1	3500	27.2	<1	-83		60	6.3	270	28.3	<1	-120

--- Not enough water available for analysis

<1- Dissolved oxygen values <1 mg/L

Table 4D - Continued

Water Quality Data for Depth-Discrete, Direct Push Groundwater Samples:

Event 4 – Sept 20-30, 2011

	Depth (ft bgs)	pH	EC (μ S)	T ($^{\circ}$ C)	DO (mg/L)	ORP (mV)
ASU	10	5.5	280	27.6	<1	120
	17	NS	NS	NS	NS	NS

	Depth (ft bgs)	pH	EC (μ S)	T ($^{\circ}$ C)	DO (mg/L)	ORP (mV)
ASU	10	---	---	---	---	---
	17	NS	NS	NS	NS	NS

1 3	25	5.	1600	27.1	<1	-41
	30	NS	NS	NS	NS	NS
	35	NS	NS	NS	NS	NS
	45	6.6	360	26.7	<1	-190
	60	---	---	---	---	---
A S U 4 B	13	---	---	---	---	---
	23	---	---	---	---	---
	27	5.7	1300	27.6	<1	-28
	40	3.8	1400	28.2	<1	-94

--- Not enough water available for analysis

1 4	25	---	---	---	---	---
	30	NS	NS	NS	NS	NS
	35	NS	NS	NS	NS	NS
	45	4.8	110	24.5	<1	61
	60	---	---	---	---	---
A S U 5 B	13	---	---	---	---	---
	23	---	---	---	---	---
	27	5.6	1200	27.8	<1	15
	40	6.3	610	28.1	<1	-100

<1- Dissolved oxygen values <1 mg/L

NS – Not Sampled

Table 5A

Ion Concentration Data for Depth-Discrete, Direct Push Groundwater Samples:

Event 1 – August 6-15, 2009

	Depth	(mg/L)				
	(ft bgs)	Cl ⁻	NO ₃ ⁻²	SO ₄ ⁻²	Fe ²⁺	Mn ²⁺
ASU1	10	100	ND	57	---	---
	15	---	---	---	---	---
	22	---	---	---	---	---
	30	76	1	21	20	ND
	35	130	1	3	15	ND
	45	35	ND	53	15	ND
	60	---	---	---	---	---
ASU2	10	---	---	---	---	---
	15	55	1	140	480	3
	22	62	ND	100	300	3
	30	31	1	50	380	1
	35	---	---	---	42	1
	45	61	ND	50	---	---
	60	---	---	---	---	---
ASU3	10	62	ND	130	---	---
	15	100	1	30	230	2
	22	---	---	---	---	---
	30	32	ND	54	290	1
	35	57	1	99	77	1
	45	53	5	170	---	---
	60	---	---	---	---	---
ASU5	10	49	1	51	---	---
	15	---	---	---	97	1
	22	---	---	---	---	---
	30	52	5	170	---	---
	35	---	---	---	45	ND
	45	39	ND	93	45	ND
	65	---	---	---	---	---
ASU6	10	600	11	70	---	---
	15	100	ND	17	180	2
	22	---	---	---	---	---
	30	34	ND	98	97	ND
	35	530	ND	16	46	ND
	45	170	ND	130	25	ND
	59	---	---	---	---	---
ASU7	10	470	1	39	5	ND
	15	40	ND	53	200	3
	22	---	---	---	---	---
	30	62	ND	96	32	ND
	35	2200	1	33	24	ND
	45	94	ND	54	21	ND
	60	---	---	---	---	---

ASU4	10	490	ND	100	---	---
	15	28	ND	34	---	---
	22	---	---	---	---	---
	30	2100	ND	33	66	1
	35	140	1	25	61	1
	45	25	ND	96	190	1
	59	28	ND	35	50	ND

--- – No water available for analysis

ND – Non-detect

<1 – Indicates analyte was detected, but was below practical quantitation limit of 1 mg/L

Table 5B

Ion Concentration Data for Depth-Discrete, Direct Push Groundwater Samples: Event 2

	Depth	(mg/L)				
	(ft bgs)	Cl ⁻	NO ₃ ⁻²	SO ₄ ⁻²	Fe ²⁺	Mn ²⁺
A S U 1	10	4	ND	16	<1	ND
	17	2000	ND	62	17	ND
	25	ND	ND	19	200	1
	30	9	1	14	17	ND
	35	4	ND	12	17	ND
	45	6	ND	15	24	ND
	60	5	ND	9	14	ND
A S U 2	10	---	---	---	2	ND
	17	2100	ND	130	660	3
	25	1100	ND	57	440	3
	30	900	ND	150	410	3
	35	1000	ND	21	500	3
	45	1000	ND	9	75	1
	60	37	ND	6	24	ND
A S U 2 B	10	260	ND	120	ND	ND
	17	---	---	---	74	ND
	25	2600		170	940	3
	30	570		38	880	2
	35	1400	ND	4	150	2
	45	---	---	---	---	---
	60	---	---	---	42	ND
A S U	10	66	ND	23	1	ND
	17	---	---	---	440	3
A S U 6	10	420	ND	63	6	ND
	17	3700	ND	53	260	3
	25	260	ND	11	34	ND
	30	330	ND	15	130	1
	35	110	ND	15	54	ND
	45	39	ND	10	20	ND
	60	19	ND	7	33	ND
A S U 7	10	---	---	---	8	ND
	17	---	---	---	190	1
	25	180	ND	44	21	ND
	30	80	ND	14	42	ND
	35	3800	ND	ND	---	---
	45	6	ND	8	19	ND
	60	---	---	---	---	---
A S U 8	10	30	ND	2	4	ND
	17	540	ND	31	62	ND
	25	70	ND	5	4	ND
	30	62	ND	14	12	ND
	35	7	ND	17	27	ND
	45	---	---	---	---	---
	60	39	ND	5	16	ND
A S U	10	4	ND	14	5	ND
	17	510	ND	93	88	1

3	25	1300	ND	17	140	2
	30	1300	ND	15	170	1
	35	---	---	---	290	2
	45	2200	ND	9	93	ND
	60	66	ND	7	42	ND
A S U 4	10	360	ND	24	7	ND
	17	505	ND	32	330	3
	25	680	ND	14	100	1
	30	620	ND	15	140	2
	35	840	ND	14	92	ND
	45	3500	ND	10	220	2
	60	64	ND	4	41	ND
A S U 5	10	20	ND	7	10	ND
	17	1	ND	38	220	2
	25	490	ND	21	54	ND
	30	370	ND	19	120	1
	35	13	ND	10	39	ND
	45	670	ND	4	98	ND
	60	60	ND	12	46	ND

--- – No water available for analysis

9	25	1000	ND	48	460	3
	30	ND	ND	66	190	2
	35	680	ND	27	530	2
	45	85	ND	2	34	ND
	60	55	ND	4	23	ND
A S U 1 0	10	14	ND	13	3	ND
	17	ND	ND	10	200	2
	25	530	ND	15	56	ND
	30	470	ND	17	66	ND
	35	590	ND	14	92	1
	45	360	ND	5	27	ND
	60	50	ND	3	43	ND
A S U 1 1	10	---	---	---	1	ND
	17	ND	ND	76	160	2
	25	450	ND	13	50	ND
	30	360	ND	14	110	1
	35	47	ND	11	24	ND
	45	---	---	---	---	---
	60	17	ND	6	---	---

ND – Non-detect

Table 5C

Ion Concentration Data for Depth-Discrete, Direct Push Groundwater Samples: Event 3

	Depth	(mg/L)				
	(ft bgs)	Cl ⁻	NO ₃ ⁻²	SO ₄ ⁻²	Fe ²⁺	Mn ²⁺
A S U 1	10	---	---	---	0	ND
	17	---	---	---	---	---
	25	35	ND	ND	58	ND
	30	---	---	---	---	---
	35	---	---	---	---	---
	45	---	---	---	---	---
	60	---	---	---	---	---
A S U 2	10	370	<1	9	2	ND
	17	---	---	---	---	---
	25	2600	ND	50	250	3
	30	1500	ND	66	220	1
	35	---	---	---	---	---
	45	---	---	---	74	ND
	60	---	---	---	31	ND
A S U 2 B	10	---	---	---	ND	ND
	17	---	---	---	---	---
	25	---	---	---	---	---
	30	2500	ND	36	490	1
	35	1300	2	21	91	1
	45	---	---	---	---	---
	60	63	<1	6	17	ND
A S U	10	9	ND	ND	1	1
	17	13	ND	ND	190	3
A S U 6	10	110	ND	25	3	ND
	17	30	ND	ND	180	1
	25	290	ND	14	50	ND
	30	410	ND	22	98	1
	35	110	10	36	51	ND
	45	33	3	11	20	ND
	60	100	12	8	24	ND
A S U 7	10	340	ND	24	13	ND
	17	2700	ND	50	170	1
	25	150	ND	8	21	ND
	30	93	ND	16	49	ND
	35	5	ND	12	27	ND
	45	7	ND	7	22	ND
	60	---	---	---	12	ND
A S U 8	10	10	ND	71	3	ND
	17	---	---	---	55	ND
	25	66	3	12	3	ND
	30	---	---	---	---	---
	35	2	ND	<1	36	ND
	45	34	30	60	43	ND
	60	---	---	---	---	---
A S U	10	8	19	28	1	ND
	17	---	---	---	---	---

3	25	9	ND	ND	100	3	13	25	790	ND	14	50	ND
	30	350	ND	ND	150	3		30	---	---	---	---	---
	35	690	ND	ND	180	2		35	---	---	---	---	---
	45	---	---	---	79	ND		45	34	30	60	9	ND
	60	6	ND	ND	19	ND		60	---	---	---	---	---
ASU4	10	---	---	---	---	---	ASU14	10	---	---	---	---	---
	17	18	2	13	150	3		17	---	---	---	---	---
	25	710	ND	24	69	1		25	---	---	---	43	ND
	30	620	ND	22	97	2		30	---	---	---	---	---
	35	---	---	---	---	---		35	---	---	---	---	---
	45	---	---	---	---	---		45	---	---	---	---	---
	60	---	---	---	95	1		60	7	2	22	39	ND
ASU5	10	18	2	14	8	ND	<p>--- - No Water available for analysis</p> <p>ND – Non-detect</p> <p>NS – Not sampled</p> <p><1 – Indicates analyte was detected, but was below practical quantitation limit of 1 mg/L</p>						
	17	36	ND	ND	140	1							
	25	1	ND	ND	60	ND							
	30	---	---	---	110	2							
	35	---	---	---	33	ND							
	45	---	---	---	87	ND							
	60	500	ND	ND	65	ND							

Table 6D

Ion Concentration Data for Depth-Discrete, Direct Push Groundwater Samples: Event 4

	Depth	(mg/L)				
	(ft bgs)	Cl ⁻	NO ₃ ⁻²	SO ₄ ⁻²	Fe ²⁺	Mn ²⁺
A S U 1	10	3	ND	12	31	ND
	17	1600	1	99	11	ND
	25	---	---	---	---	---
	30	39	ND	16	18	ND
	35	4	ND	12	10	ND
	45	5	ND	11	13	ND
	60	---	---	---	---	---
A S U 2	10	890	ND	14	6	ND
	17	---	ND	65	210	ND
	25	460	ND	18	90	ND
	30	1100	1	10	84	ND
	35	1100	1	9	120	ND
	45	660	ND	ND	---	---
	60	51	ND	ND	11	ND
A S U 2 B	10	---	16	ND	2	ND
	17	---	ND	290	29	ND
	25	---	ND	57	150	ND
	30	830	1	2	120	ND
	35	1200	1	ND	100	ND
	45	340	ND	39	16	ND
	60	---	---	---	---	---
A S U	10	83	ND	13	6	ND
A S U	17	730	2	10	53	2

	Depth	(mg/L)				
	(ft bgs)	Cl ⁻	NO ₃ ⁻²	SO ₄ ⁻²	Fe ²⁺	Mn ²⁺
A S U 6	10	---	---	---	---	---
	17	---	---	---	---	---
	25	260	ND	ND	---	---
	30	370	ND	ND	65	ND
	35	170	ND	16	40	ND
	45	8	1	17	15	ND
	60	18	ND	4	---	---
A S U 7	10	290	ND	29	8	ND
	17	---	---	---	---	---
	25	170	ND	9	12	ND
	30	240	ND	ND	---	---
	35	16	ND	10	14	ND
	45	4	ND	22	21	ND
	60	12	ND	3	13	ND
A S U 8	10	38	ND	53	6	ND
	17	---	---	---	---	---
	25	67	ND	22	<1	ND
	30	45	ND	12	12	ND
	35	7	ND	21	---	---
	45	5	ND	28	29	ND
	60	---	---	---	---	---
A S U	10	4	ND	3	2	ND
A S U	17	---	---	---	---	---

3	25	---	---	---	---	---
	30	---	---	---	---	---
	35	---	1	10	63	1
	45	260	ND	ND	---	---
	60	200	ND	7	---	---
A S U 4	10	450	ND	24	4	ND
	17	---	1	27	69	ND
	25	520	ND	29	29	ND
	30	---	1	ND	53	ND
	35	470	ND	16	41	ND
	45	---	---	---	---	---
	60	120	ND	6	---	---

--- – No water available for analysis

9	25	0	1	1	320	ND
	30	0	1	63	53	ND
	35	0	1	1	390	ND
	45	190	1	ND	29	ND
	60	130	ND	1	20	ND
A S U 1 0	10	21	ND	47	6	ND
	17	680	ND	16	32	ND
	25	0	ND	0	53	ND
	30	460	ND	19	28	ND
	35	8	1	9	48	ND
	45	440	ND	3	29	ND
	60	430	ND	2	28	ND

ND – Non-detect

(Table 6D Continues)

(Table 6D Continued)

	Depth (ft bgs)	Cl ⁻	NO ₃ ⁻²	SO ₄ ⁻²	Fe ²⁺	Mn ²⁺
A S U 5	10	---	---	---	---	---
	17	---	---	---	---	---
	25	660	ND	1	68	ND
	30	---	---	---	---	---
	35	12	ND	ND	14	ND
	45	132	ND	14	29	ND
	60	1000	1	11	46	ND
A S U 1 3	10	7	ND	36	<1	ND
	17	---	---	---	---	---
	25	520	ND	11	23	ND
	30	---	---	---	---	---
	35	---	---	---	---	---
	45	16	1	4	8	ND
	60	---	---	---	---	---
A S U 4 B	13	1500	1	42	44	ND
	23	---	---	---	---	---
	27	350	ND	ND	38	ND
	40	310	ND	14	32	ND

--- Not enough water available for analysis

	Depth (ft bgs)	Cl ⁻	NO ₃ ⁻²	SO ₄ ⁻²	Fe ²⁺	Mn ²⁺
A S U 1 1	10	---	---	---	---	---
	17	---	---	---	---	---
	25	---	---	---	---	---
	30	320	ND	19	50	ND
	35	44	1	ND	23	ND
	45	690	ND	12	18	ND
	60	27	1	ND	---	---
A S U 1 4	10	---	---	---	---	---
	17	---	---	---	---	---
	25	1000	1	24	34	ND
	30	---	---	---	---	---
	35	---	---	---	---	---
	45	6	ND	28	14	ND
	60	---	---	---	---	---
A S U 5 B	13	---	---	---	---	---
	23	300	ND	12	53	ND
	27	---	---	---	---	---
	40	78	ND	24	31	ND

<1- Indicates analyte was detected, but was below practical quantitation limit of 1 mg/L

Table 7

DOC Concentration Data for Depth-Discrete, Direct Push Groundwater Samples: Events 1, 2, 3, and 4

DOC (mg/L)								
Depth (ft bgs)	ASU 1				ASU 2			
	<u>Evt 1</u>	<u>Evt 2</u>	<u>Evt 3</u>	<u>Evt 4</u>	<u>Evt 1</u>	<u>Evt 2</u>	<u>Evt 3</u>	<u>Evt 4</u>
10	---	23	5	8	---	---	25	---
15	---	X	X	X	13	X	X	X
17	X	4	X	6	X	34	---	---
22	---	X	X	X	3	X	X	X
25	X	---	20	---	X	14	21	6
30	3	10	X	3	9	21	5	---
35	7	30	X	5	2	<1	---	5
45	4	4	---	4	---	19	9	29
60	---	---	---	---	---	7	7	---

DOC (mg/L)								
Depth (ft bgs)	ASU 2B				ASU 3			
	<u>Evt 1</u>	<u>Evt 2</u>	<u>Evt 3</u>	<u>Evt 4</u>	<u>Evt 1</u>	<u>Evt 2</u>	<u>Evt 3</u>	<u>Evt 4</u>
10	X	---	36	11	X	---	36	11
15	X	X	X	X	X	X	X	X
17	X	1	---	32	X	1	---	32
22	X	X	X	X	X	X	X	X
25	X	---	---	30	X	---	---	30
30	X	---	9	---	X	---	9	---
35	X	14	32	10	X	14	32	10
45	X	---	---	4	X	---	---	4
60	X	---	8	---	X	---	8	---

		DOC (mg/L)							
Depth (ft bgs)	ASU 4				ASU 5				
	<u>Evt 1</u>	<u>Evt 2</u>	<u>Evt 3</u>	<u>Evt 4</u>	<u>Evt 1</u>	<u>Evt 2</u>	<u>Evt 3</u>	<u>Evt 4</u>	
10	---	2	5	25	---	---	7	---	
15	8	X	X	X	7	X	X	X	
17	X	---	33	28	X	8	7	---	
22	---	X	X	X	---	X	X	X	
25	X	10	5	6	X	---	10	3	
30	3	11	8	---	10	9	19	7	
35	5	20	---	4	7	8	35	29	
45	6	4	4	6	4	15	7	4	
60	3	11	1	5	---	5	8	3	

--- – No water for analysis

Event 1: Aug 6-15, 2009

X – Not sampled

Event 2: Jan 9-22, 2011

Event 3: June 4-13, 2011

Event 4: Sept 20-30, 2011

(Table 7 Continues)

(Table 7 Continued)

		DOC (mg/L)							
Depth (ft bgs)	ASU 6				ASU 7				
	<u>Evt 1</u>	<u>Evt 2</u>	<u>Evt 3</u>	<u>Evt 4</u>	<u>Evt 1</u>	<u>Evt 2</u>	<u>Evt 3</u>	<u>Evt 4</u>	
10	---	2	9	---	---	---	6	15	
15	6	X	X	X	---	X	X	X	
17	X	<1	13	5	X	---	10	---	
22	---	X	X	X	---	X	X	X	

25	X	4	8	---	X	<1	4	3
30	---	18	<1	24	---	---	5	20
35	---	3	11	---	---	---	4	31
45	---	10	8	4	---	6	<1	30
60	---	14	4	35	---	32	---	7

DOC (mg/L)

Depth (ft bgs)	ASU 8				ASU 9			
	<u>Evt 1</u>	<u>Evt 2</u>	<u>Evt 3</u>	<u>Evt 4</u>	<u>Evt 1</u>	<u>Evt 2</u>	<u>Evt 3</u>	<u>Evt 4</u>
10	X	<1	22	13	X	21	X	---
15	X	X	X	X	X	X	X	X
17	X	5	5	---	X	11	X	---
22	X	X	X	X	X	X	X	X
25	X	2	7	29	X	9	X	7
30	X	9	6	17	X	6	X	6
35	X	21	4	31	X	12	X	27
45	X	18	9	---	X	---	X	5
60	X	6	---	---	X	15	X	4

DOC (mg/L)

Depth (ft bgs)	ASU 10				ASU 11			
	<u>Evt 1</u>	<u>Evt 2</u>	<u>Evt 3</u>	<u>Evt 4</u>	<u>Evt 1</u>	<u>Evt 2</u>	<u>Evt 3</u>	<u>Evt 4</u>
10	X	---	X	47	X	19	X	34
15	X	X	X	X	X	X	X	X
17	X	1	X	5	X	18	X	---
22	X	X	X	X	X	X	X	X
25	X	4	X	3	X	5	X	4
30	X	<1	X	7	X	---	X	31
35	X	<1	X	5	X	8	X	7

45	X	23	X	8	X	19	X	30
60	X	27	X	25	X	24	X	---

--- -- No water for analysis

Event 1: Aug 6-15, 2009

X – Not sampled

Event 2: Jan 9-22, 2011

Event 3: June 4-13, 2011

Event 4: Sept 20-30, 2011

(Table 7 Continues)

(Table 7 Continued)

DOC (mg/L)								
Depth (ft bgs)	ASU 13				ASU 14			
	<u>Evt 1</u>	<u>Evt 2</u>	<u>Evt 3</u>	<u>Evt 4</u>	<u>Evt 1</u>	<u>Evt 2</u>	<u>Evt 3</u>	<u>Evt 4</u>
10	X	X	13	10	X	X	---	---
15	X	X	X	X	X	X	X	X
17	X	X	X	X	X	X	X	X
22	X	X	X	X	X	X	X	X
25	X	X	<1	7	X	X	<1	4
30	X	X	X	X	X	X	X	X
35	X	X	X	X	X	X	X	X
45	X	X	4	---	X	X	---	7
60	X	X	X	26	X	X	8	---

DOC (mg/L)								
Depth (ft bgs)	ASU 4B				ASU 5B			
	<u>Evt 1</u>	<u>Evt 2</u>	<u>Evt 3</u>	<u>Evt 4</u>	<u>Evt 1</u>	<u>Evt 2</u>	<u>Evt 3</u>	<u>Evt 4</u>
13	X	X	X	---	X	X	X	---
23	X	X	X	---	X	X	X	---

27	X	X	X	---	X	X	X	---
40	X	X	X	---	X	X	X	---

--- – No water for analysis

Event 1: Aug 6-15, 2009

X – Not sampled

Event 2: Jan 9-22, 2011

Event 3: June 4-13, 2011

Event 4: Sept 20-30, 2011

Table 8

COD Data for Depth-Discrete, Direct Push Groundwater Samples: Events 1, 2, 3, and 4

COD (mg/L)								
Depth (ft bgs)	ASU 1				ASU 2			
	<u>Evt 1</u>	<u>Evt 2</u>	<u>Evt 3</u>	<u>Evt 4</u>	<u>Evt 1</u>	<u>Evt 2</u>	<u>Evt 3</u>	<u>Evt 4</u>
10	---	---	100	---	---	110	130	---
15	---	X	X	---	34	X	X	---
17	X	210	---	860	X	810	---	1100
22	---	X	X	---	14	X	X	---
25	X	280	320	---	X	530	220	620
30	3	39	X	---	52	920	1100	---
35	26	19	X	---	38	460	---	690
45	17	8	32	---	---	69	85	---
60	---	67	---	---	---	21	27	---

COD (mg/L)								
Depth (ft bgs)	ASU 2B				ASU 3			
	<u>Evt 1</u>	<u>Evt 2</u>	<u>Evt 3</u>	<u>Evt 4</u>	<u>Evt 1</u>	<u>Evt 2</u>	<u>Evt 3</u>	<u>Evt 4</u>
10	X	---	40	1400	35	96	78	---
15	X	X	X	---	41	X	X	---
17	X	---	39	---	X	610	800	740
22	X	X	X	---	---	X	X	---
25	X	---	---	570	X	---	350	---
30	X	450	1200	480	30	147	410	1400
35	X	80	160	---	---	---	620	1300
45	X	---	---	---	47	145	440	---
60	X	10	100	---	---	40	48	---

		COD (mg/L)							
Depth (ft bgs)	ASU 4				ASU 5				
	<u>Evt 1</u>	<u>Evt 2</u>	<u>Evt 3</u>	<u>Evt 4</u>	<u>Evt 1</u>	<u>Evt 2</u>	<u>Evt 3</u>	<u>Evt 4</u>	
10	---	96	---	---	---	---	43	---	
15	150	X	X	---	290	X	X	---	
17	X	230	460	960	X	285	36	---	
22	---	X	X	---	---	X	X	---	
25	X	59	150	---	X	27	170	---	
30	42	---	110	---	130	36	18	---	
35	25	66	---	---	89	---	210	---	
45	130	220	230	280	58	84	93	---	
60	89	16	300	---	---	18	43	---	

--- – No water for analysis

Event 1: Aug 6-15, 2009

X – Not sampled

Event 2: Jan 9-22, 2011

Event 3: June 4-13, 2011

Event 4: Sept 20-30, 2011

(Table 8 Continues)

(Table 8 Continued)

		COD (mg/L)							
Depth (ft bgs)	ASU 6				ASU 7				
	<u>Evt 1</u>	<u>Evt 2</u>	<u>Evt 3</u>	<u>Evt 4</u>	<u>Evt 1</u>	<u>Evt 2</u>	<u>Evt 3</u>	<u>Evt 4</u>	
10	---	34	100	---	---	27	82	---	
15	190	X	X	---	---	X	X	---	
17	X	160	380	---	X	---	300	---	
22	---	X	X	---	---	X	X	---	

25	X	32	41	---	X	---	94	---
30	140	36	32	---	---	360	100	---
35	120	36	76	---	---	---	39	---
45	---	35	33	---	---	6	23	---
60	---	---	38	110	---	24	---	---

COD (mg/L)

Depth (ft bgs)	ASU 8				ASU 9			
	<u>Evt 1</u>	<u>Evt 2</u>	<u>Evt 3</u>	<u>Evt 4</u>	<u>Evt 1</u>	<u>Evt 2</u>	<u>Evt 3</u>	<u>Evt 4</u>
10	X	6	34	---	X	15	X	32
15	X	X	X	---	X	X	X	---
17	X	45	110	---	X	610	X	---
22	X	X	X	---	X	X	X	---
25	X	---	24	---	X	670	X	1100
30	X	7	110	---	X	680	X	470
35	X	24	33	---	X	220	X	---
45	X	36	100	---	X	64	X	---
60	X	42	---	---	X	12	X	---

COD (mg/L)

Depth (ft bgs)	ASU 10				ASU 11			
	<u>Evt 1</u>	<u>Evt 2</u>	<u>Evt 3</u>	<u>Evt 4</u>	<u>Evt 1</u>	<u>Evt 2</u>	<u>Evt 3</u>	<u>Evt 4</u>
10	X	110	X	170	X	---	X	150
15	X	X	X	---	X	X	X	---
17	X	390	X	---	X	120	X	---
22	X	X	X	81	X	X	X	---
25	X	40	X	---	X	51	X	---
30	X	50	X	---	X	45	X	---
35	X	39	X	---	X	17	X	---

45	X	26	X	---	X	---	X	---
60	X	11	X	---	X	34	X	---

--- -- No water for analysis

Event 1: Aug 6-15, 2009

X – Not sampled

Event 2: Jan 9-22, 2011

Event 3: June 4-13, 2011

Event 4: Sept 20-30, 2011

(Table 8 Continues)

(Table 8 Continued)

COD (mg/L)								
Depth (ft bgs)	ASU 13				ASU 14			
	<u>Evt 1</u>	<u>Evt 2</u>	<u>Evt 3</u>	<u>Evt 4</u>	<u>Evt 1</u>	<u>Evt 2</u>	<u>Evt 3</u>	<u>Evt 4</u>
10	X	X	100	---	X	X	X	---
15	X	X	X	---	X	X	X	---
17	X	X	X	---	X	X	---	---
22	X	X	X	---	X	X	X	---
25	X	X	180	---	X	X	110	---
30	X	X	X	---	X	X	X	---
35	X	X	X	---	X	X	X	---
45	X	X	96	18	X	X	---	---
60	X	X	---	---	X	X	360	---

COD (mg/L)								
Depth (ft bgs)	ASU 4B				ASU 5B			
	<u>Evt 1</u>	<u>Evt 2</u>	<u>Evt 3</u>	<u>Evt 4</u>	<u>Evt 1</u>	<u>Evt 2</u>	<u>Evt 3</u>	<u>Evt 4</u>
13	X	X	X	---	X	X	X	---
23	X	X	X	---	X	X	X	---
27	X	X	X	---	X	X	X	---

40	X	X	X	---	X	X	X	---
----	---	---	---	-----	---	---	---	-----

--- – No water for analysis

Event 1: Aug 6-15, 2009

X – Not sampled

Event 2: Jan 9-22, 2011

Event 3: June 4-13, 2011

Event 4: Sept 20-30, 2011

Table 9

Alkalinity Data for Depth-Discrete, Direct Push Groundwater Samples: Events 1, 2, 3, and 4

Alkalinity (mg/L as CaCO ₃)								
Depth (ft bgs)	ASU 1				ASU 2			
	<u>Evt 1</u>	<u>Evt 2</u>	<u>Evt 3</u>	<u>Evt 4</u>	<u>Evt 1</u>	<u>Evt 2</u>	<u>Evt 3</u>	<u>Evt 4</u>
10	---	80	60	80	---	120	60	---
15	200	X	X	X	20	X	X	X
17	X	---	---	---	X	20	---	---
22	---	X	X	X	40	X	X	X
25	X	20	20	20	X	60	---	---
30	40	100	---	---	20	40	40	40
35	60	60	---	---	---	40	---	---
45	20	40	60	40	40	---	60	60
60	---	40	---	40	---	60	60	60

Alkalinity (mg/L as CaCO ₃)								
Depth (ft bgs)	ASU 2B				ASU 3			
	<u>Evt 1</u>	<u>Evt 2</u>	<u>Evt 3</u>	<u>Evt 4</u>	<u>Evt 1</u>	<u>Evt 2</u>	<u>Evt 3</u>	<u>Evt 4</u>
10	X	240	140	160	80	120	80	100
15	X	X	X	X	20	X	X	X
17	X	60	---	60	X	20	0	20
22	X	X	X	X	---	X	X	X
25	X	20	---	20	X	---	20	20
30	X	60	---	40	40	40	20	40
35	X	---	100	100	20	---	0	20
45	X	---	---	---	40	20	20	20
60	X	---	120	100	---	80	40	60

		Alkalinity (mg/L as CaCO ₃)							
Depth (ft bgs)	ASU 4				ASU 5				
	<u>Evt 1</u>	<u>Evt 2</u>	<u>Evt 3</u>	<u>Evt 4</u>	<u>Evt 1</u>	<u>Evt 2</u>	<u>Evt 3</u>	<u>Evt 4</u>	
10	100	80	---	100	---	40	80	60	
15	---	X	X	X	40	X	X	X	
17	X	40	20	40	X	---	20	---	
22	---	X	X	X	---	X	X	X	
25	X	40	20	40	X	40	20	40	
30	40	40	20	40	20	40	20	20	
35	60	40	20	40	20	---	220	20	
45	20	40	100	60	100	280	320	260	
60	20	40	20	40	---	40	0	40	

--- -- No water for analysis

Event 1: Aug 6-15, 2009

X – Not sampled

Event 2: Jan 9-22, 2011

Event 3: June 4-13, 2011

Event 4: Sept 20-30, 2011

(Table 9 Continues)

(Table 9 Continued)

		Alkalinity (mg/L as CaCO ₃)							
Depth (ft bgs)	ASU 6				ASU 7				
	<u>Evt 1</u>	<u>Evt 2</u>	<u>Evt 3</u>	<u>Evt 4</u>	<u>Evt 1</u>	<u>Evt 2</u>	<u>Evt 3</u>	<u>Evt 4</u>	
10	120	60	100	80	100	40	80	---	
15	60	X	X	X	40	X	X	X	
17	X	40	40	---	X	---	20	---	
22	---	X	X	X	---	X	X	X	

25	X	---	20	---	X	40	40	---
30	20	40	20	---	40	20	20	20
35	20	40	20	40	120	---	80	---
45	40	---	20	40	100	40	100	---
60	---	140	20	---	---	160	60	---

Alkalinity (mg/L as CaCO₃)

Depth (ft bgs)	ASU 8				ASU 9			
	<u>Evt 1</u>	<u>Evt 2</u>	<u>Evt 3</u>	<u>Evt 4</u>	<u>Evt 1</u>	<u>Evt 2</u>	<u>Evt 3</u>	<u>Evt 4</u>
10	X	100	80	100	X	120	X	100
15	X	X	X	X	X	X	X	X
17	X	40	0	---	X	120	X	100
22	X	X	X	X	X	X	X	X
25	X	60	60	---	X	20	X	---
30	X	40	0	20	X	40	X	---
35	X	40	40	---	X	20	X	20
45	X	40	0	40	X	60	X	---
60	X	40	---	---	X	---	X	---

Alkalinity (mg/L as CaCO₃)

Depth (ft bgs)	ASU 10				ASU 11			
	<u>Evt 1</u>	<u>Evt 2</u>	<u>Evt 3</u>	<u>Evt 4</u>	<u>Evt 1</u>	<u>Evt 2</u>	<u>Evt 3</u>	<u>Evt 4</u>
10	X	100	X	80	X	80	X	---
15	X	X	X	X	X	X	X	X
17	X	40	X	60	X	20	X	---
22	X	X	X	X	X	X	X	X
25	X	40	X	40	X	20	X	40
30	X	60	X	40	X	20	X	40
35	X	---	X	---	X	40	X	40

45	X	60	X	40	X	---	X	---
60	X	40	X	40	X	60	X	40

--- – No water for analysis

Event 1: Aug 6-15, 2009

X – Not sampled

Event 2: Jan 9-22, 2011

Event 3: June 4-13, 2011

Event 4: Sept 20-30, 2011

(Table 9 Continues)

(Table 9 Continued)

Alkalinity (mg/L as CaCO ₃)								
Depth (ft bgs)	ASU 13				ASU 14			
	<u>Evt 1</u>	<u>Evt 2</u>	<u>Evt 3</u>	<u>Evt 4</u>	<u>Evt 1</u>	<u>Evt 2</u>	<u>Evt 3</u>	<u>Evt 4</u>
10	X	X	80	60	X	X	---	
15	X	X	X	X	X	X	X	X
17	X	X	X	---	X	X	X	---
22	X	X	X	X	X	X	X	X
25	X	X	20	20	X	X	0	---
30	X	X	X	---	X	X	X	---
35	X	X	X	---	X	X	X	---
45	X	X	160	120	X	X	---	---
60	X	X	---	---	X	X	160	---

Alkalinity (mg/L as CaCO ₃)								
Depth (ft bgs)	ASU 4B				ASU 5B			
	<u>Evt 1</u>	<u>Evt 2</u>	<u>Evt 3</u>	<u>Evt 4</u>	<u>Evt 1</u>	<u>Evt 2</u>	<u>Evt 3</u>	<u>Evt 4</u>
13	X	X	X	---	X	X	X	---
23	X	X	X	---	X	X	X	---
27	X	X	X	---	X	X	X	---
40	X	X	X	---	X	X	X	---

--- -- No water for analysis

Event 1: Aug 6-15, 2009

X – Not sampled

Event 2: Jan 9-22, 2011

Event 3: June 4-13, 2011

Event 4: Sept 20-30, 2011

Table 10A

VOC Concentration Data for Depth-Discrete Groundwater Samples: Event 1

	Depth (ft bgs)	VOC Concentrations (µg/L)								
		VC	11 DCE	t - DCE	c-DCE	TCE	PCE	Ethene	Ethane	PCE Equivalents ¹
ASU1	10	-	-	-	-	-	-	-	-	-
	15	-	-	-	-	-	-	<1	2	9
	22	NW	NW	NW	NW	NW	NW	NW	NW	NW
	30	-	-	-	<1	<1	-	<1	<1	1
	35	-	-	-	-	-	-	<1	<1	-
	45	<1	<1	16	49	64	-	3	6	240
ASU2	60	NW	NW	NW	NW	NW	NW	NW	NW	NW
	10	210	-	45	100	-	-	2	<1	830
	15	74	2	<1	300	500	8000	<1	-	9300
	22	<1	7	-	34	210	10	-	-	350
	30	-	<1	<1	20	150	240	<1	<1	460
	35	-	-	-	-	-	3	-	-	3
ASU3	45	-	-	-	-	-	<1	<1	<1	-
	60	NW	NW	NW	NW	NW	NW	NW	NW	NW
	10	1100	73	3500	16000	2400	-	10	-	39000
	15	1300	47	99	2700	550	9100	27	2	18000
	22	NW	NW	NW	NW	NW	NW	NW	NW	NW
	30	58	130	18	760	540	1300	<1	-	3700
ASU4	35	51	7	6	200	34	120	<1	<1	660
	45	<1	-	<1	6	<1	<1	<1	<1	10
	60	NW	NW	NW	NW	NW	NW	NW	NW	NW
	10	1100	99	11000	18000	6000	9200	17	<1	71000
	15	630	50	2200	5300	7800	38000	5	<1	62000
	22	NW	NW	NW	NW	NW	NW	NW	NW	NW
ASU5	30	260	-	12	170	42	120	<1	<1	1200
	35	58	7	350	1100	1200	1800	<1	<1	6000
	45	3	7	3	690	200	64	<1	<1	1500
	59	-	-	2	14	2	14	-	-	45
	10	490	19	650	2700	-	1	4	<1	7200
	15	2700	41	350	5600	150	750	470	-	21000
ASU6	22	NW	NW	NW	NW	NW	NW	NW	NW	NW
	30	6	3	13	470	20	130	2	2	1000
	35	<1	<1	3	28	7	9	<1	<1	75
	45	5	2	34	130	<1	<1	-	-	470
	65	<1	-	<1	3	<1	<1	6	12	100
	10	310	19	110	6100	1600	750	<1	<1	14000
ASU7	15	120	24	75	1700	1900	19000	<1	<1	25000
	22	NW	NW	NW	NW	NW	NW	NW	NW	NW
	30	<1	<1	<1	9	140	460	-	-	650
	35	-	-	-	-	4	<1	<1	<1	6
	45	<1	4	17	120	520	11	<1	<1	900
	59	2	<1	15	58	5	14	-	-	150
ASU7	10	340	30	88	6400	2500	1000	2	<1	16000
	15	65	2	72	520	290	8800	<1	-	10000
	22	NW	NW	NW	NW	NW	NW	NW	NW	NW
	30	-	-	-	-	5	-	<1	<1	6
	35	<1	<1	<1	<1	1	<1	<1	<1	3
	45	<1	2	12	110	65	<1	2	3	320
60	NW	NW	NW	NW	NW	NW	NW	NW	NW	

1) PCE equivalents based on adjustment factors in Table 16.

NW - No water available for analysis

- - Non-detect

<1 - Indicates analyte was detected, but below the practical quantitation limit of 1 µg/L

Table 10B

VOC Concentration Data for Depth-Discrete Groundwater Samples: Event 2

	Depth (ft bgs)	VOC Concentrations (µg/L)								
		VC	11 DCE	t - DCE	c-DCE	TCE	PCE	Ethene	Ethane	PCE Equivalents ¹
ASU1	10	-	-	-	-	-	-	-	-	-
	17	-	-	-	-	-	-	<1	<1	-
	25	<1	<1	<1	23	61	<1	<1	<1	120
	30	-	-	-	-	4	-	<1	3	21
	35	-	-	-	<1	<1	<1	<1	2	13
	45	2	-	14	43	120	-	<1	<1	250
	60	3	-	29	140	580	-	NW	NW	1000
ASU2	10	200	-	6	180	-	-	3	2	880
	17	20	-	-	250	690	10000	<1	<1	11000
	25	11	5	-	41	130	260	<1	<1	530
	30	3	4	-	140	200	260	-	<1	760
	35	-	-	-	3	2	2	-	<1	10
	45	1	<1	-	5	7	14	<1	<1	34
	60	-	2	10	71	2	<1	<1	<1	150
ASU2B	10	10	-	-	-	-	-	<1	-	27
	17	270	21	160	1200	950	3900	2	<1	8200
	25	31	24	10	480	1400	2200	<1	<1	5000
	30	<1	<1	-	-	-	<1	-	<1	1
	35	2	-	<1	40	24	2	<1	<1	110
	45	NW	NW	NW	NW	NW	NW	NW	NW	NW
	60	<1	3	13	140	<1	<1	NW	NW	270
ASU3	10	1700	110	2600	12000	-	-	18	<1	30000
	17	570	46	51	2000	1100	18000	15	<1	25000
	25	34	240	-	540	2800	30000	11	<1	35000
	30	40	220	18	480	2500	31000	6	<1	36000
	35	<1	1	2	180	46	1	-	<1	380
	45	1	<1	-	27	11	85	<1	<1	150
	60	<1	1	12	170	1	2	<1	<1	320
ASU4	10	580	500	11000	26000	25000	39000	10	-	140000
	17	210	44	820	2500	4400	34000	25	<1	46000
	25	50	28	-	140	330	4600	4	<1	5500
	30	8	17	-	804	1000	2900	<1	<1	5600
	35	3	22	-	890	2000	5200	<1	<1	9300
	45	-	-	-	-	-	-	2	<1	935
	60	<1	<1	2	56	<1	1	<1	<1	100
ASU5	10	1000	290	11000	20000	4600	1700	11	<1	62000
	17	2000	170	370	14000	2300	17000	460	-	53000
	25	86	22	23	890	370	700	19	<1	3100
	30	9	29	73	1800	76	23	2	<1	3400
	35	2	<1	9	100	21	-	<1	<1	220
	45	260	-	2	9	<1	<1	23	20	960
	60	<1	-	<1	<1	<1	<1	3	6	52

1) PCE equivalents based on adjustment factors in Table 16. - - Non-detect

NW - No water available for analysis

<1 - Indicates analyte was detected, but below the practical quantitation limit of 1 µg/L

(Table 10B Continues)

(Table 10B Continued)

	Depth (ft bgs)	VOC Concentrations (µg/L)								
		VC	11 DCE	t - DCE	c-DCE	TCE	PCE	Ethene	Ethane	PCE Equivalents ¹
ASU6	10	210	70	160	7000	2400	1000	3	3	17000
	17	34	27	51	950	2300	23000	<1	<1	28000
	25	-	33	-	18	380	2500	-	2	3100
	30	-	1	<1	6	230	7	<1	<1	320
	35	3	<1	<1	2	26	1	<1	<1	210
	45	12	40	22	170	1100	-	4	12	1800
	60	-	-	8	24	4	3	NW	NW	62
ASU7	10	<1	-	3	310	<1	<1	<1	<1	530
	17	23	-	67	500	470	13000	<1	<1	15000
	25	-	<1	-	12	160	<1	-	<1	230
	30	-	<1	-	1	17	<1	<1	<1	25
	35	NW	NW	NW	NW	NW	NW	NW	NW	NW
	45	<1	<1	21	230	120	-	<1	2	570
60	-	<1	41	110	100	<1	NW	NW	400	
ASU8	10	<1	-	-	<1	<1	<1	NW	NW	2
	17	<1	<1	<1	<1	<1	<1	<1	<1	4
	25	-	-	-	<1	<1	<1	<1	<1	18
	30	-	-	-	-	<1	<1	<1	3	49
	35	-	-	-	-	-	<1	2	7	27
	45	<1	<1	-	1	2	1	2	3	6
	60	-	-	<1	<1	5	-	<1	<1	8
ASU9	10	64	<1	7	490	-	-	<1	<1	1100
	17	124	-	-	170	67	1400	3	7	2100
	25	<1	2	<1	21	68	13	-	<1	140
	30	<1	2	<1	28	59	17	-	<1	150
	35	-	-	-	<1	<1	-	<1	<1	50
	45	-	-	-	9	-	-	3	5	48
	60	-	<1	18	170	<1	<1	2	3	350
ASU10	10	370	137	18000	14000	9400	7800	2	<1	75000
	17	300	82	1800	4000	6100	150000	3	<1	170000
	25	2	-	7	33	100	5300	<1	<1	5500
	30	<1	3	7	38	39	210	<1	<1	350
	35	-	16	-	75	160	4800	<1	<1	5100
	45	<1	14	4	96	51	150	<1	<1	410
	60	<1	4	12	160	4	42	<1	<1	350
ASU11	10	25	26	23	2000	1400	180	<1	<1	5400
	17	49	25	19	1200	2500	44000	2	<1	50000
	25	-	15	-	23	200	1500	<1	<1	1800
	30	-	<1	-	4	48	<1	<1	<1	68
	35	-	-	-	1	6	44	-	<1	54
	45	<1	<1	<1	14	1	<1	<1	<1	38
	60	<1	-	3	310	<1	<1	2	5	26

1) PCE equivalents based on adjustment factors in Table 16.

NW - No water available for analysis

- - Non-detect

<1 - Indicates analyte was detected, but below the practical quantitation limit of 1 µg/L

Table 10C

VOC Concentration Data for Depth-Discrete Groundwater Samples: Event 3

Location	Depth (ft bgs)	VOC Concentrations (µg/L)								
		VC	11 DCE	t - DCE	c-DCE	TCE	PCE	Ethene	Ethane	PCE Equivalents ¹
ASU1	10	-	-	-	-	-	-	-	-	-
	17	NS	NS	NS	NS	NS	NS	NS	NS	NS
	25	1	1	-	9	50	-	-	-	91
	30	NS	NS	NS	NS	NS	NS	NS	NS	NS
	35	NS	NS	NS	NS	NS	NS	NS	NS	NS
	45	-	-	11	21	37	-	-	<1	130
ASU2	60	-	-	7	59	92	-	NW	NW	290
	10	320	-	6	51	-	-	<1	-	1000
	17	27	-	-	280	180	2000	-	-	3100
	25	-	-	-	26	88	210	-	-	390
	30	-	-	-	180	110	130	-	-	730
	35	NW	NW	NW	NW	NW	NW	NW	NW	NW
ASU2B	45	1	-	<1	3	3	16	3	7	82
	60	1	1	9	58	2	7	<1	3	200
	10	49	-	2	3	<1	1	<1	<1	150
	17	580	11	87	500	140	320	-	-	3600
	25	72	8	8	280	420	810	<1	<1	2300
	30	NW	NW	NW	NW	NW	NW	NW	NW	NW
ASU3	35	16	-	-	80	11	-	-	<1	260
	45	NW	NW	NW	NW	NW	NW	NW	NW	NW
	60	-	<1	<1	15	<1	<1	-	-	41
	10	1800	17	1000	3500	7	13	77	-	17000
	17	140	-	-	290	220	3200	3	<1	4600
	25	110	79	11	600	1600	13000	-	-	17000
ASU4	30	11	11	3	170	73	500	-	<1	1100
	35	-	-	8	-	-	-	-	-	21
	45	3	-	-	5	3	26	-	<1	51
	60	10	-	2	-	2	14	-	<1	48
	10	1200	110	4200	17000	2000	1000	5	3	61000
	17	320	22	540	3000	2000	6600	2	-	19000
ASU5	25	140	15	9	530	350	1300	<1	-	3500
	30	49	13	9	1345	273	330	-	<1	4300
	35	56	12	13	680	1000	2000	-	<1	5300
	45	350	-	63	430	140	320	-	-	2700
	60	17	-	12	17	5	17	-	4	170
	10	430	45	3000	6000	1600	570	-	<1	26000
ASU5	17	1700	30	190	3500	990	8000	315	-	25000
	25	51	5	11	330	83	63	-	-	1200
	30	57	11	82	1800	13	-	-	-	5000
	35	18	2	47	180	19	79	4	18	870
	45	130	1	33	120	27	29	NW	NW	780
	60	1	-	1	5	1	4	<1	<1	21

NW – No water for analysis

<1 – Indicates analyte was detected, but below PQL of 1 µg/L

- - Non-detect

1) – PCE equivalents based on adjustment factors in Table 16.

NS – Not sampled

(Table 10C Continues)

(Table 10c Continued)

Location	Depth (ft bgs)	VOC Concentrations (µg/L)								
		VC	11 DCE	t - DCE	c-DCE	TCE	PCE	Ethene	Ethane	PCE Equivalents ¹
ASU6	10	260	13	67	2900	27	17	<1	<1	8500
	17	80	8	33	620	1400	11000	-	2	14000
	25	7	-	-	12	270	2000	-	-	2400
	30	-	4	1	8	180	56	<1	<1	320
	35	-	-	-	-	13	34	<1	<1	50
	45	-	1	-	68	480	13	NW	NW	790
	60	-	-	<1	5	<1	<1	-	<1	13
ASU7	10	-	-	-	150	-	-	-	-	390
	17	52	-	46	260	180	6400	<1	<1	7600
	25	-	1	<1	10	90	5	<1	-	150
	30	<1	2	<1	2	16	-	-	-	33
	35	1	<1	<1	4	7	5	-	-	29
	45	7	9	17	110	60	40	2	4	510
	60	NW	NW	NW	NW	NW	NW	NW	NW	NW
ASU8	10	NW	NW	NW	NW	NW	NW	NW	NW	NW
	17	1	<1	<1	3	<1	2	-	-	13
	25	-	-	-	-	-	-	-	-	-
	30	-	-	-	-	-	-	<1	<1	-
	35	<1	-	-	<1	<1	<1	-	4	25
	45	-	-	-	2	2	4	-	-	10
	60	NW	NW	NW	NW	NW	NW	NW	NW	NW
ASU13	10	-	-	-	-	-	-	-	-	-
	17	NS	NS	NS	NS	NS	NS	NS	NS	NS
	25	13	-	-	9	23	-	-	<1	90
	30	NS	NS	NS	NS	NS	NS	NS	NS	NS
	35	NS	NS	NS	NS	NS	NS	NS	NS	NS
	45	1	2	3	73	<1	<1	2	7	250
	60	NW	NW	NW	NW	NW	NW	NW	NW	NW
ASU14	10	<1	-	-	<1	<1	-	NW	NW	<1
	17	NS	NS	NS	NS	NS	NS	NS	NS	NS
	25	-	<1	-	<1	2	<1	-	-	4
	30	NS	NS	NS	NS	NS	NS	NS	NS	NS
	35	NS	NS	NS	NS	NS	NS	NS	NS	NS
	45	NW	NW	NW	NW	NW	NW	-	-	NW
	60	-	-	6	37	91	-	NW	NW	220

1) PCE equivalents based on adjustment factors in Table 16.

NW - No water available for analysis

NS - Not Sampled

--- - Non-detect

<1 - Indicates analyte was detected, but below the practical quantitation limit of 1 µg/L

Table 10D

VOC Concentration Data for Depth-Discrete Groundwater Samples: Event 4

Location	Depth (ft bgs)	VOC Concentrations (µg/L)								
		VC	11 DCE	t - DCE	c-DCE	TCE	PCE	Ethene	Ethane	PCE Equivalents ¹
ASU1	10	-	-	-	-	-	-	-	-	-
	17	-	-	-	-	-	-	-	-	-
	25	NW	NW	NW	NW	NW	NW	NW	NW	NW
	30	-	-	-	-	9	-	-	-	11
	35	-	-	-	-	-	-	-	-	-
	45	-	-	5	15	32	-	-	-	75
ASU2	60	-	-	43	150	340	-	-	2	770
	10	200	-	-	95	-	-	-	-	700
	17	-	-	-	180	240	2600	-	-	3200
	25	-	4	-	46	73	150	-	-	320
	30	-	9	-	200	120	120	-	-	620
	35	-	-	-	190	125	130	-	-	610
ASU2B	45	-	-	-	-	-	3	-	-	3
	60	-	9	4	5	13	29	-	1	82
	10	-	-	-	-	-	-	-	-	-
	17	350	4	83	570	340	1100	14	-	3600
	25	78	9	19	340	950	1500	-	-	3500
	30	-	-	-	-	-	-	-	-	-
ASU3	35	-	1	-	21	12	-	-	-	54
	45	16	-	1	4	2	9	57	220	1600
	60	NW	NW	NW	NW	NW	NW	NW	NW	NW
	10	1400	30	1700	6200	-	21	14	-	17000
	17	1100	26	40	2100	324	1800	8	-	8900
	25	78	60	15	1600	1100	11000	3	-	15000
ASU4	30	20	48	5	1100	540	750	-	-	3400
	35	6	7	4	41	15	37	-	-	160
	45	6	4	9	58	-	88	4	10	300
	60	9	-	9	60	50	91	6	10	390
	10	3300	170	2100	20000	1300	430	8	-	50000
	17	430	-	690	4500	3300	12000	9	-	26000
ASU5	25	230	-	28	1300	110	250	1	-	3300
	30	40	9	3	1400	21	12	-	-	2600
	35	-	-	-	780	180	280	-	-	1800
	45	50	20	29	360	20	22	4	8	950
	60	4	-	4	23	8	18	3	8	150
	10	430	29	1500	4500	-	21	-	-	12000
ASU5	17	1800	28	140	4600	810	6900	210	-	22000
	25	34	8	88	1800	38	11	-	-	3400
	30	37	9	91	2000	40	9	-	-	3700
	35	-	-	-	240	-	-	-	-	410
	45	120	-	-	100	-	29	1	-	510
	60	-	-	-	-	-	-	-	1	6

NW – No water for analysis

<1 – Indicates analyte was detected, but below PQL of 1 µg/L

- - Non-detect

1) – PCE equivalents based on adjustment factors in Table 16.

NS – Not sampled

(Table 10D Continues)

(Table 10D Continued)

Location	Depth (ft bgs)	VOC Concentrations (µg/L)								
		VC	11 DCE	t - DCE	c-DCE	TCE	PCE	Ethene	Ethane	PCE Equivalents ¹
ASU6	10	75	12	130	1800	270	25	-	-	3900
	17	41	-	34	860	680	4800	-	-	7300
	25	16	5	10	200	110	760	-	-	1300
	30	42	3	1	9	110	8	-	-	280
	35	1	3	1	4	25	4	-	-	50
	45	4	6	18	83	280	38	-	1	590
	60	-	-	-	6	10	10	6	15	33
ASU7	10	13	-	6	170	3	9	-	-	350
	17	8	15	23	500	220	2000	1	1	3200
	25	1	2	-	7	57	3	-	-	92
	30	0	1	1	2	23	1	NW	NW	39
	35	1	2	1	-	7	38	-	-	54
	45	2	-	6	18	52	5	-	-	120
	60	-	-	-	5	3	4	3	6	67
ASU8	10	-	-	-	-	-	-	-	-	-
	17	-	-	-	-	-	-	-	-	-
	25	-	-	-	-	-	-	-	-	-
	30	-	-	-	-	-	-	-	-	-
	35	-	-	-	-	-	-	-	-	-
	45	-	-	-	-	-	-	-	-	-
	60	NW	NW	NW	NW	NW	NW	NW	NW	NW
ASU9	10	270	-	6	87	-	17	8	-	940
	17	210	-	5	94	46	1000	-	-	1800
	25	10	5	-	24	32	26	-	-	140
	30	-	4	-	21	32	66	-	-	150
	35	-	3	-	9	29	2	-	-	60
	45	-	-	-	12	-	1	-	-	22
	60	-	-	-	13	-	6	-	-	29
ASU10	10	4800	120	4000	8900	2300	1000	70	-	39000
	17	70	9	130	540	1900	3400	-	-	7100
	25	120	22	200	820	2400	6200	-	-	11000
	30	35	4	41	160	110	480	-	-	1100
	35	3	5	4	65	110	4100	-	-	4400
	45	35	4	24	140	81	300	-	-	780
	60	6	-	9	15	12	84	2	4	190
ASU11	10	120	15	47	4500	220	38	-	-	8500
	17	21	-	5	410	180	1600	-	-	2600
	25	4	22	-	87	160	600	-	-	1000
	30	-	-	-	12	40	67	-	-	140
	35	-	-	0	5	8	10	-	1	34
	45	2	4	15	50	85	15	NW	NW	300
	60	-	-	-	11	9	7	3	7	37

1) PCE equivalents based on adjustment factors in Table 16.

NW - No water available for analysis

NS - Not Sampled

- - Non-detect

<1 - Indicates analyte was detected, but below the practical quantitation limit of 1 µg/L

(Table 10D Continues)

(Table 10D Continued)

Location	Depth (ft bgs)	VOC Concentrations (µg/L)								
		VC	11 DCE	t - DCE	c-DCE	TCE	PCE	Ethene	Ethane	PCE Equivalents ¹
A S U 13	10	-	-	-	-	-	-	-	-	-
	17	NS	NS	NS	NS	NS	NS	NS	NS	NS
	25	-	-	-	12	19	-	-	-	45
	30	NS	NS	NS	NS	NS	NS	NS	NS	NS
	35	NS	NS	NS	NS	NS	NS	NS	NS	NS
	45	-	-	-	61	-	-	16	36	400
	60	NW	NW	NW	NW	NW	NW	NW	NW	NW
A S U 14	10	-	-	-	-	-	-	-	-	-
	17	NS	NS	NS	NS	NS	NS	NS	NS	NS
	25	-	2	2	4	12	6	-	-	35
	30	NS	NS	NS	NS	NS	NS	NS	NS	NS
	35	NS	NS	NS	NS	NS	NS	NS	NS	NS
	45	-	-	1	16	4	2	-	-	36
A S U 4B	13	1100	160	2800	9200	11000	34000	120	-	72000
	23	-	4	5	47	130	88	-	-	350
	27	-	6	-	310	71	190	-	-	810
	40	-	-	120	440	580	430	NW	NW	2100
A S U 5B	13	170	17	770	4800	800	-	-	-	11000
	23	NW	NW	NW	NW	NW	NW	NW	NW	NW
	27	1	-	-	6	26	30	-	-	2800
	40	-	30	47	49	55	220	150	330	510

1) PCE equivalents based on adjustment factors in Table 16.

NW - No water available for analysis

NS - Not Sampled

- - Non-detect

<1 - Indicates analyte was detected, but below the practical quantitation limit of 1 µg/L

Table 11

VOC Soil Extractions: Event 2 – January 9-22, 2011

Location	Depth (ft bgs)	VOC Concentrations (mg/kg)						
		VC	1,1-DCE	t-DCE	c-DCE	TCE	PCE	PCE Equivalents ¹
A S U 2B	16	NS	NS	NS	NS	NS	NS	NS
	17	NS	NS	NS	NS	NS	NS	NS
	19	NS	NS	NS	NS	NS	NS	NS
	21	-	-	-	-	-	7.2	7.2
	25	NS	NS	NS	NS	NS	NS	NS
A S U 10	16.5	NS	NS	NS	NS	NS	NS	NS
	18	NS	NS	NS	NS	NS	NS	NS
	19	NS	NS	NS	NS	NS	NS	NS
	21	NS	NS	NS	NS	NS	NS	NS
	24	NS	NS	NS	NS	NS	NS	NS
	25	-	-	-	-	-	2.1	2.1
	27	-	-	-	-	-	-	-

1) PCE equivalents based on adjustment factors in Table 16.

- - Non-detect

NS - No sample for analysis: Sample loss occurred during shipping

Table 12A

Dehalococcoides Testing: Event 1 – August 6-15, 2009

Location	Depth (ft bgs)	General Bacteria	Dehalococcoides
ASU 3	10	---	---
	15	---	---
	35	X	X
ASU 4	10	---	---
ASU 5	15	X	X
	35	---	---
	45	X	---
ASU 7	30	X	X
	45	---	---

X – Indicates positive --- indicates non-detect

Table 12B

Dehalococcoides Testing: Event 2 – January 9-22, 2011

Location	Depth (ft bgs)	General Bacteria	Dehalococcoides
ASU 2	45	X	--
ASU 2B	25	--	--
ASU 3	17	--	--
	25	X	X
ASU 4	25	--	--
ASU 5	17	X	X
	25	X	X
	35	X	--
ASU 10	17	--	--
ASU 11	25	--	--

X – Indicates positive -- -- indicates non-detect

Table 12C

Dehalococcoides Testing: Event 4 – Sept 20-30, 2011

Location	Depth (ft bgs)	General Bacteria	Dehalococcoides
ASU 2	45	X	--
ASU 4	25	X	--
ASU5	25	X	X
	45	--	--
ASU 7	25	X	X
ASU 9	17	X	--
	30	X	X
	35	--	--

X – Indicates positive --- – indicates non-detect

Table 13A

Soil Gas Concentration Data: Event 1 – August 6-15, 2009

Vapor Point	Depth (cm bgs)	Soil Gas Concentration (µg/L)				
		t - DCE	c - DCE	TCE	PCE	PCE Equivalents
1A	30	-	-	5	120	130
1B	76	4	-	6	140	150
2A	30	1	-	7	190	200
2B	76	3	-	15	230	260
3A	30	6	-	23	260	300
3B	76	NS	NS	NS	NS	NS
4A	30	3	2	16	170	200
4B	76	4	-	15	210	240
5A	30	2	-	17	140	260
5B	76	1	-	16	140	170
6A	30	18	2	37	270	350
6B	76	20	2	31	300	370
7A	30	13	1	37	300	370
7B	76	13	1	47	340	430
8A	30	3	-	33	260	300
8B	76	NS	NS	NS	NS	NS

NS – No sample collected due to submerged sampling screen

- - Non-detect: Less than detection limit of 1ug/L

Table 13B

Soil Gas Concentration Data: Event 2 – January 9-22, 2011

Vapor Point	Depth (cm bgs)	Soil Gas Concentration ($\mu\text{g/L}$)				
		t - DCE	c - DCE	TCE	PCE	PCE Equivalents
10A	34	-	-	-	29	29
10B	81	-	-	-	20	20
11A	32		-		171	170
11B	80	<0.5	-	8	260	270
12A	30	-	-	-	65	65
12B	81	-	-	-	93	93
13A	30	-	-	<0.5	31	31
13B	65	-	-	-	30	30
14A	36	-	-	-	46	46
14B	81	<0.5	<0.5	<0.5	21	21
15A	34	72	15	20	97	270
15B	83	68	16	16	130	300
16A	38	-	-	7	81	89
16B	86	-	-	5	140	150
17A	19	2	10	5	39	66
17B	85	3	12	6	52	85
18A	38	<0.5	-	0.8	23	24
18B	83	-	-	0.5	21	22
19A	36	0.7	<0.5	3	40	44
19B	80	<0.5	<0.5	2	43	46
20A	37		-	5	80	86
20B	83	<0.5	-	7	65	74

21A	22	-	-	-	33	33
21B	84	-	-	-	34	34
22A	36	1	-	11	44	60
22B	80	2	-	9	39	54
23A	28	140	120	30	70	550
23B	81	140	120	27	52	540
24	33	-	-	0.8	6	7

<0.5 - Indicates analyte was detected, but below the practical quantitation limit of 0.5 µg/L

- - Non-detect:

Table 13C

Soil Gas Concentration Data: Event 3 – June 4-13, 2011

Vapor Point	Depth (cm bgs)	Soil Gas Concentration ($\mu\text{g/L}$)				
		t - DCE	c - DCE	TCE	PCE	PCE Equivalents
10A	27	-	-	-	52	52
10B	71	-	-	-	57	57
11A	28	-	-	15	450	470
11B	70	5	-	26	800	840
12A	25	-	-	3	160	160
12B	75	-	-	7	340	350
13A	25	-	-	-	62	62
13B	76	-	-	-	29	29
14A	28	-	-	-	45	45
14B	77	-	-	-	83	83
15A	30	110	32	110	280	680
15B	74	180	62	190	420	1100
16A	23	-	-	9	130	140
16B	74	4	-	11	300	320
17A	25	-	8	11	79	110
17B	75	9	17	15	120	180
18A	13	-	-	2	66	69
18B	74	-	-	6	62	70
19A	29	2	-	10	170	186
19B	74	4	-	11	160	185
20A	29	-	-	14	220	240
20B	75	-	-	26	344	380

21A	18	-	-	-	100	100
21B	70	-	-	-	90	90
10.5A	27	-	-	-	160	160
10.5B	74	-	-	-	220	220
11.5A	28	-	8	74	1200	1300
11.5B	74	-	10	92	1400	1600
12.5A	32	-	13	92	2100	2300
12.5B	74	-	14	110	2500	2600

- - Non-detect:

Table 13D

Soil Gas Concentration Data: Event 4 – September 20-30, 2011

Vapor Point	Depth (cm bgs)	Soil Gas Concentration (µg/L)				
		t - DCE	c - DCE	TCE	PCE	PCE Equivalents
10.5A	18	-	-	-	64	64
10.5B	31	-	-	-	96	96
11A	15	-	-	6	100	110
11B	33	7	8	24	600	660
11.5A	23	-	-	36	530	570
11.5B	46	-	-	71	1500	1600
12A	27	8	31	120	1500	1700
12B	38	25	70	300	5300	5800
12.5A	18	-	6	74	1400	1500
12.5B	41	-	14	97	2400	2600
13A	23	-	-	-	9	9
13B	36	-	-	-	16	16
13.5A	34	-	-	-	-	-
13.5B	41	-	-	-	-	-
14A	18	-	-	-	24	24
14B	46	-	-	-	37	37
15A	25	-	-	-	51	51
15B	47	-	3	21	510	540
16A	15	-	-	-	100	100
16B	33	-	-	-	240	240
17A	20	-	-	-	33	33
17B	46	-	-	-	49	49

17.5A	23	-	-	-	4	4
17.5B	NS	NS	NS	NS	NS	NS
18A	22	-	-	-	21	21
18B	46	-	-	-	39	39
20A	15	-	-	-	58	58
20B	28	5	-	4	120	140
21A	22	-	-	-	8	8
21B	33	9	14	12	96	150

- - Non-detect:

Table 14A

Diffusion Coefficients: Event 1 – August 6-15, 2009

Location	Depth (cm)	Effective Helium Diffusion Coefficient (cm ² /s)	$D_{He}^{eff} / D_{He}^{Air}$ (cm ² /s)	Location Overall Effective Diffusion Coefficient (Dt)
1A	30	1.4 x 10 ⁻²	2.1 x 10 ⁻²	2.9 x 10 ⁻²
1B	76	3.3 x 10 ⁻²	4.9 x 10 ⁻²	
2A	30	1.9 x 10 ⁻²	2.8 x 10 ⁻²	3.5 x 10 ⁻²
2B	76	3.0 x 10 ⁻²	4.5 x 10 ⁻²	
3A	30	1.4 x 10 ⁻²	2.1 x 10 ⁻²	2.1 x 10 ⁻²
3B	76	NS	NS	
4A	30	2.2 x 10 ⁻²	3.2 x 10 ⁻²	3.9 x 10 ⁻²
4B	76	3.4 x 10 ⁻²	5.0 x 10 ⁻²	
5A	30	4.3 x 10 ⁻²	6.4 x 10 ⁻²	7.8 x 10 ⁻²
5B	76	6.6 x 10 ⁻²	9.9 x 10 ⁻²	
6A	30	2.3 x 10 ⁻²	3.4 x 10 ⁻²	4.4 x 10 ⁻²
6B	76	4.1 x 10 ⁻²	6.2 x 10 ⁻²	
7A	30	3.2 x 10 ⁻²	4.8 x 10 ⁻²	5.6 x 10 ⁻²
7B	76	4.6 x 10 ⁻²	6.9 x 10 ⁻²	
8A	30	3.6 x 10 ⁻²	5.4 x 10 ⁻²	5.4 x 10 ⁻²
8B	76	NS	NS	
Site Average	NA	3.2 x 10 ⁻²	4.8 x 10 ⁻²	4.4 x 10 ⁻²

NS – No sample collected due to submerged sampling screen

$$D_t = \frac{L_t}{L_t/2D_1 + L_t/2D_2 + \dots + L_t/2D_i}$$

Where:

L_t = Total length between sampling locations (cm)

D_i = $D_{eff}^{He} / D_{He_i}^{air}$ at sample location i (cm²/s)

D_t = Overall effective diffusion coefficient for interval (cm²/s)

Table 14B

Diffusion Coefficients: Event 2 – January 9-22, 2011

Location	Depth (cm)	Effective Helium Diffusion Coefficient (cm ² /s)	$D_{He}^{eff} / D_{He}^{Air}$ (cm ² /s)	Location Overall Effective Diffusion Coefficient (Dt) (cm ² /s)
10A	34	1.4×10^{-2}	2.1×10^{-1}	1.4×10^{-1}
10B	81	6.8×10^{-2}	1.0×10^{-1}	
11A	32	5.6×10^{-2}	8.4×10^{-2}	1.0×10^{-1}
11B	80	8.5×10^{-2}	1.3×10^{-1}	
12A	30	3.2×10^{-2}	4.8×10^{-2}	6.2×10^{-2}
12B	81	5.9×10^{-2}	8.8×10^{-2}	
13A	30	6.5×10^{-2}	9.7×10^{-2}	9.8×10^{-2}
13B	65	6.7×10^{-2}	1.0×10^{-1}	
14A	36	6.0×10^{-2}	9.0×10^{-2}	7.8×10^{-2}
14B	81	4.7×10^{-2}	7.0×10^{-2}	
15A	34	5.6×10^{-2}	8.32×10^{-2}	8.0×10^{-2}
15B	83	5.2×10^{-2}	7.8×10^{-2}	
16A	38	5.5×10^{-2}	8.2×10^{-2}	1.1×10^{-1}
16B	86	9.8×10^{-2}	1.5×10^{-1}	
17A	19	3.2×10^{-2}	4.8×10^{-2}	6.0×10^{-2}
17B	85	5.3×10^{-2}	8.0×10^{-2}	
18A	38	4.0×10^{-2}	6.0×10^{-2}	6.4×10^{-2}
18B	83	4.6×10^{-2}	6.8×10^{-2}	
19A	36	2.2×10^{-2}	3.3×10^{-2}	4.7×10^{-2}
19B	80	5.5×10^{-2}	8.7×10^{-2}	
20A	37	3.1×10^{-2}	4.6×10^{-2}	5.8×10^{-2}

20B	83	5.4×10^{-2}	8.0×10^{-2}	
21A	22	4.8×10^{-2}	7.1×10^{-2}	7.1×10^{-2}
21B	84	4.7×10^{-2}	7.0×10^{-2}	
22A	36	2.1×10^{-2}	3.2×10^{-2}	5.0×10^{-2}
22B	80	2.2×10^{-2}	1.1×10^{-1}	
23A	28	7.4×10^{-2}	5.4×10^{-2}	9.3×10^{-2}
23B	81	3.6×10^{-2}	3.4×10^{-1}	
24	33	6.8×10^{-2}	1.0×10^{-1}	1.0×10^{-1}
Site Average	NA	6.2×10^{-2}	9.2×10^{-2}	8.0×10^{-2}

Dt: Calculation of Dt is explained beneath Table 15A

Table 14C

Diffusion Coefficients: Event 3 – June 4-13, 2011

Location	Depth (cm)	Effective Helium Diffusion Coefficient (cm ² /s)	$D_{He}^{eff} / D_{He}^{Air}$ (cm ² /s)	Location Overall Effective Diffusion Coefficient (Dt) (cm ² /s)
10A	27	3.0×10^{-2}	4.5×10^{-2}	4.9×10^{-2}
10B	71	3.6×10^{-2}	5.3×10^{-2}	
11A	28	7.9×10^{-3}	1.2×10^{-2}	1.9×10^{-2}
11B	70	3.6×10^{-2}	5.3×10^{-2}	
12A	25	1.8×10^{-2}	2.7×10^{-2}	4.2×10^{-2}
12B	75	6.0×10^{-2}	9.0×10^{-2}	
13A	25	5.4×10^{-2}	8.0×10^{-2}	7.9×10^{-2}
13B	76	5.2×10^{-2}	7.7×10^{-2}	
14A	28	3.5×10^{-2}	5.3×10^{-2}	4.1×10^{-2}
14B	77	2.2×10^{-2}	3.3×10^{-2}	
15A	30	3.5×10^{-2}	5.2×10^{-2}	6.4×10^{-2}
15B	74	5.6×10^{-2}	8.3×10^{-2}	
16A	23	3.2×10^{-2}	4.8×10^{-2}	5.5×10^{-2}
16B	74	4.3×10^{-2}	6.5×10^{-2}	
17A	25	2.1×10^{-2}	3.2×10^{-2}	3.1×10^{-2}
17B	75	2.1×10^{-2}	3.1×10^{-2}	
18A	13	6.1×10^{-2}	9.1×10^{-2}	9.2×10^{-2}
18B	74	6.2×10^{-2}	9.3×10^{-2}	
19A	29	3.4×10^{-2}	5.1×10^{-2}	6.3×10^{-2}
19B	74	5.4×10^{-2}	8.1×10^{-2}	
20A	29	3.4×10^{-2}	5.0×10^{-2}	6.1×10^{-2}

20B	75	5.1×10^{-2}	7.6×10^{-2}	
21A	18	4.8×10^{-2}	7.1×10^{-2}	8.5×10^{-2}
21B	70	7.0×10^{-2}	1.0×10^{-1}	
10.5A	27	2.8×10^{-2}	4.2×10^{-2}	6.6×10^{-2}
10.5B	74	9.9×10^{-2}	1.5×10^{-1}	
11.5A	28	4.7×10^{-2}	6.9×10^{-2}	8.9×10^{-2}
11.5B	74	8.2×10^{-2}	1.2×10^{-1}	
12.5A	32	6.4×10^{-2}	9.5×10^{-2}	1.0×10^{-2}
12.5B	74	7.4×10^{-2}	1.1×10^{-1}	
Site Average	NA	4.6×10^{-2}	6.8×10^{-2}	6.2×10^{-2}

Dt: Calculation of Dt is explained beneath Table 15A

Table 14C

Diffusion Coefficients: Event 4 – Sept 20-30, 2011

Location	Depth (cm)	Effective Helium Diffusion Coefficient (cm ² /s)	$D_{He}^{eff} / D_{He}^{Air}$	Location Overall Effective Diffusion Coefficient (Dt)
10.5A	18	1.6×10^{-2}	2.4×10^{-2}	3.0×10^{-2}
10.5B	31	3.2×10^{-2}	4.8×10^{-2}	
11A	15	9.0×10^{-3}	1.3×10^{-2}	2.0×10^{-2}
11B	33	2.6×10^{-2}	3.9×10^{-2}	
11.5A	23	1.5×10^{-2}	2.2×10^{-2}	3.0×10^{-2}
11.5B	46	5.1×10^{-2}	7.7×10^{-2}	
12A	15	2.1×10^{-2}	3.1×10^{-2}	4.0×10^{-2}
12B	38	3.8×10^{-2}	5.6×10^{-2}	
12.5A	18	1.1×10^{-2}	1.6×10^{-2}	3.0×10^{-2}
12.5B	41	4.0×10^{-2}	6.0×10^{-2}	
13A	23	1.3×10^{-2}	2.0×10^{-2}	2.0×10^{-2}
13B	36	2.3×10^{-2}	3.4×10^{-2}	
13.5A	34	1.3×10^{-2}	2.0×10^{-2}	3.3×10^{-2}
13.5B	41	3.3×10^{-2}	4.9×10^{-2}	
14A	18	1.8×10^{-2}	2.6×10^{-2}	3.0×10^{-2}
14B	46	2.4×10^{-2}	3.6×10^{-2}	
15A	25	1.6×10^{-2}	2.3×10^{-2}	3.0×10^{-2}
15B	47	2.5×10^{-2}	3.7×10^{-2}	
16A	15	1.1×10^{-2}	1.6×10^{-2}	2.0×10^{-2}
16B	33	2.0×10^{-2}	3.1×10^{-2}	
17A	20	3.9×10^{-2}	5.8×10^{-2}	7.0×10^{-2}

17B	46	5.3×10^{-2}	7.9×10^{-2}	
17.5A	23	1.4×10^{-2}	2.1×10^{-2}	2.1×10^{-2}
17.5B	NS	NS	NS	
18A	22	2.5×10^{-2}	3.7×10^{-2}	4.0×10^{-2}
18B	46	2.8×10^{-2}	4.2×10^{-2}	
20A	15	2.0×10^{-2}	2.9×10^{-2}	3.0×10^{-2}
20B	28	2.5×10^{-2}	3.8×10^{-2}	
21A	22	3.3×10^{-2}	4.9×10^{-2}	5.0×10^{-2}
21B	33	2.9×10^{-2}	4.3×10^{-2}	
Site Average	NA	4.0×10^{-2}	5.0×10^{-2}	3.0×10^{-2}

Dt: Calculation of Dt is explained beneath Table 15A

Table 15A

Vapor Flux and Mass Loss Calculations: Events 1, 2, 3, and 4

Event	Site Average Diffusion Coefficient (cm ² /s)	PCE Equivalents Flux (kg/m ² -y)	Estimated Source Zone Area Footprint (m ²)	Mass Loss of PCE Equivalents by Vapor Emission (kg/y)
1	4.4 x 10 ⁻²	6.4 x 10 ⁻⁴	100 ^A	6.4 x 10 ⁻²
2	8.0 x 10 ⁻²	9.5 x 10 ⁻⁴	100 ^A	9.5 x 10 ⁻²
3	6.2 x 10 ⁻²	7.7 x 10 ⁻⁵	2800	2.1 x 10 ⁻¹
4	3.0 x 10 ⁻²	2.8 x 10 ⁻⁴	2800	7.9 x 10 ⁻¹

Event 1 – Aug 6-15, 2009

Event 3 – June 4-13, 2011

Event 2 – Jan 9-22, 2011

Event 4 – Sept 20-30, 2011

Vapor Flux Calculation

$$Flux_{vapor} = \sum_i D_i^{air} A_i(D_t) \left(\frac{\Delta C_{v,i}}{\Delta Z} \right) \psi_i^j$$

Where:

- D_i^{air} – Diffusion coefficient of compound i in air (cm²/s)
- D_t – Effective Diffusion coefficient at location
- $C_{v,i}$ – Concentration of compound i in vapor (µg/L)
- Z – Depth of sample (cm)
- ψ_i^j – Adjustment Factor for measured chemical i in terms of chemical j
- A_i – Impacted Area (cm²)

Diffusion Coefficients in Air (cm²/s)

He	VC	11 DCE	t-DCE	11 DCA	c - DCE	TCE	PCE
6.71E-1	1.06E-01	9.00E-02	7.07E-02	7.42E-02	7.36E-02	7.90E-02	7.20E-02

Adjustment Factors (ψ_i^j)

		PCE Equivalent (adjustment factor)					
		PCA	PCE	TCA	TCE	DCA	DCE
Measured	PCA	1.000	0.700	0.564	0.555	0.418	0.409
	PCE	1.428	1.000	0.804	0.792	0.597	0.585
	TCA	1.775	1.243	1.000	0.985	0.742	0.727
	TCE	1.802	1.262	1.015	1.000	0.753	0.738
	DCA	2.392	1.676	1.348	1.328	1.000	0.980
	DCE	2.442	1.711	1.376	1.355	1.021	1.000
	Chloroethane	3.670	2.570	2.068	2.037	1.534	1.503
	VC	3.788	2.653	2.135	2.102	1.583	1.551
	Ethane	7.873	5.515	4.436	4.369	3.291	3.224
	Ethene	8.440	5.912	4.756	4.684	3.528	3.456

Figures

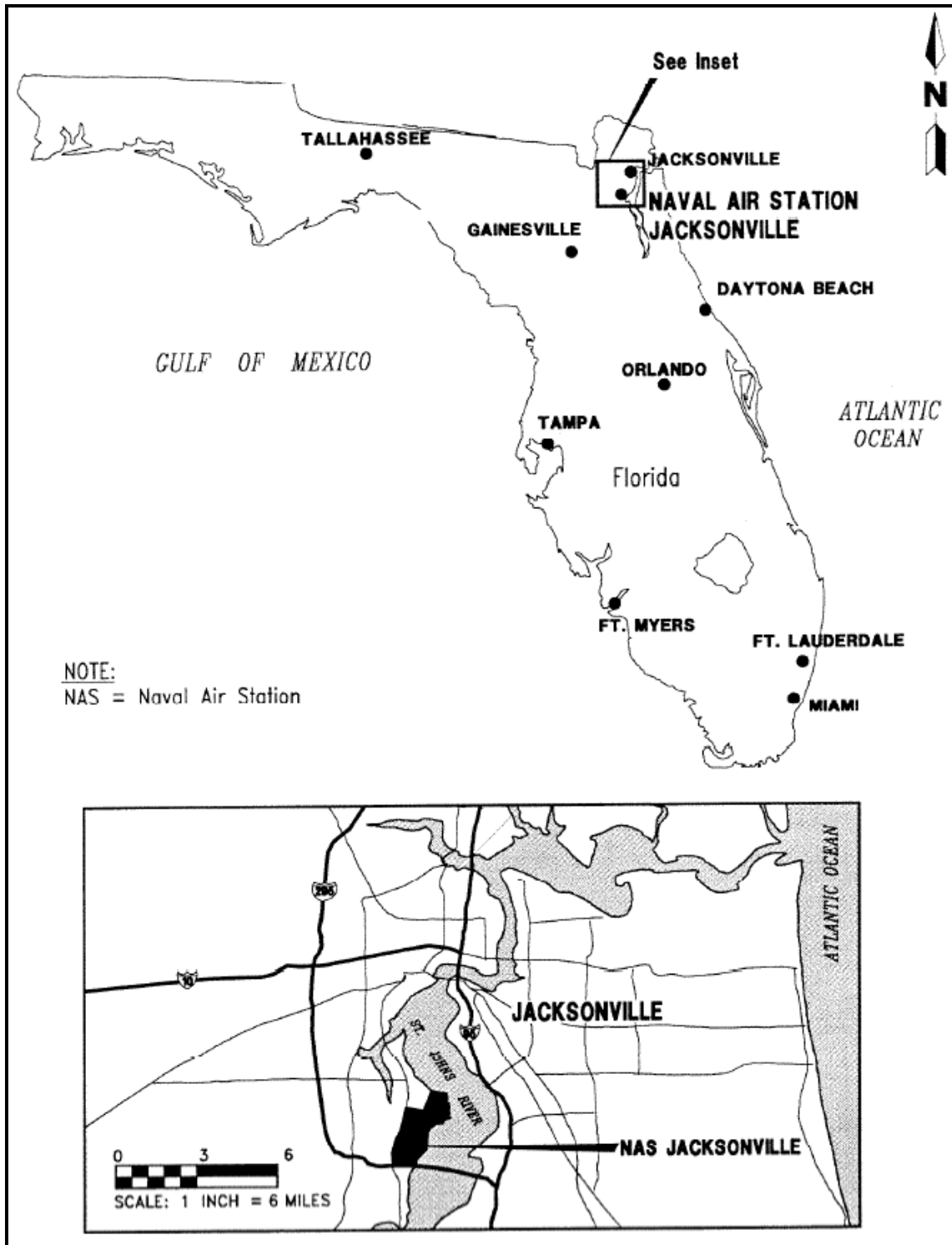
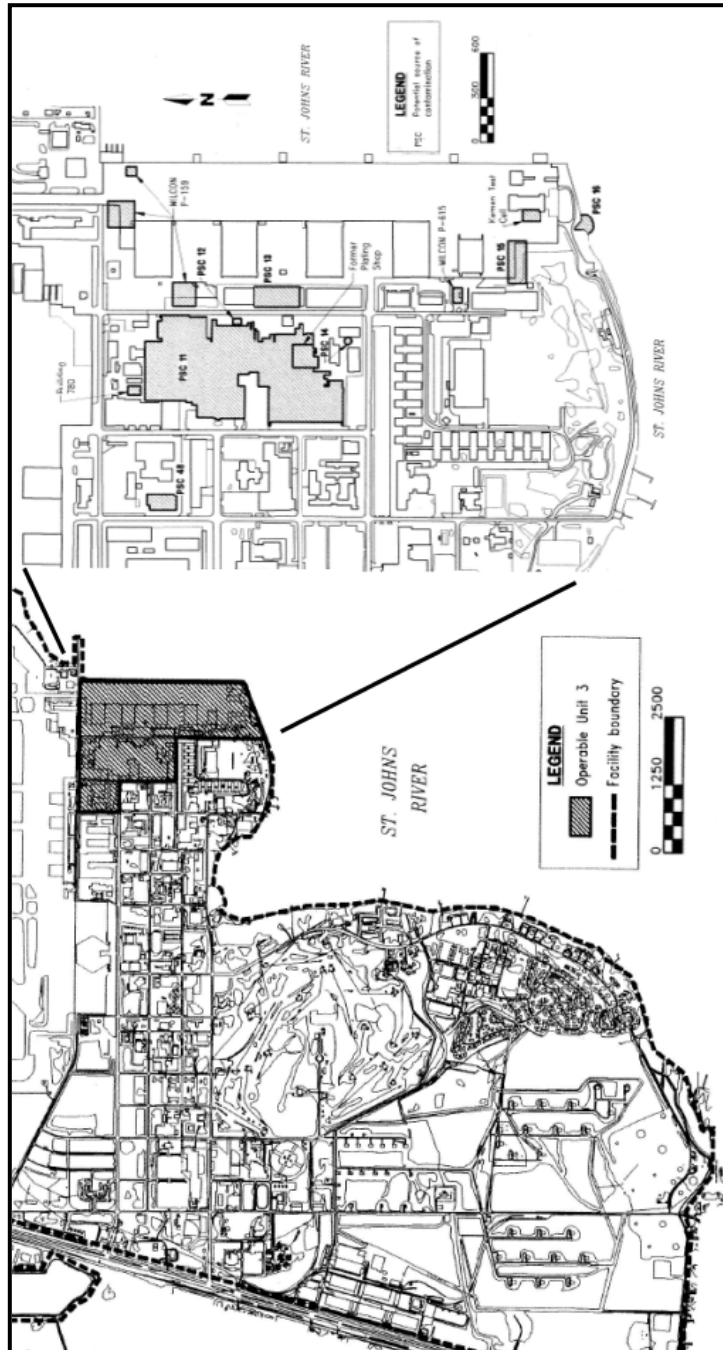

Figure 1: Site Map – Naval Air Station Jacksonville



Source: OU3 RIFS April 2000

Figure 2: Operable Unit 3, PSC 48 (Building 106) Site Map

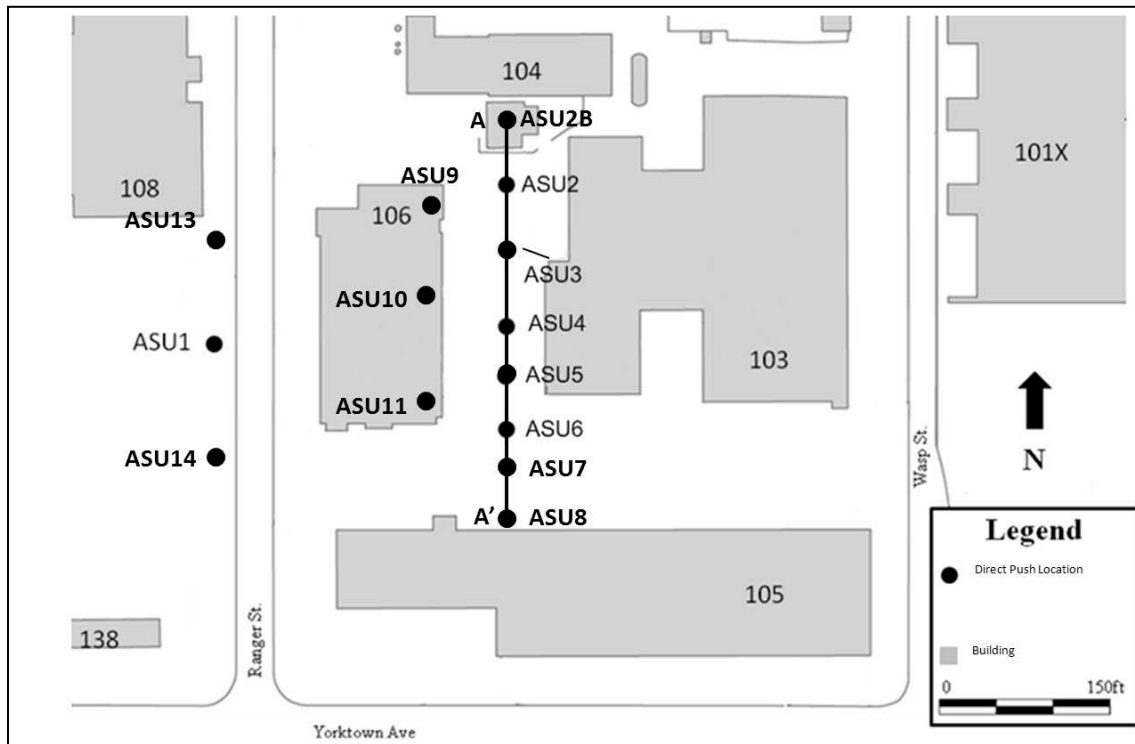
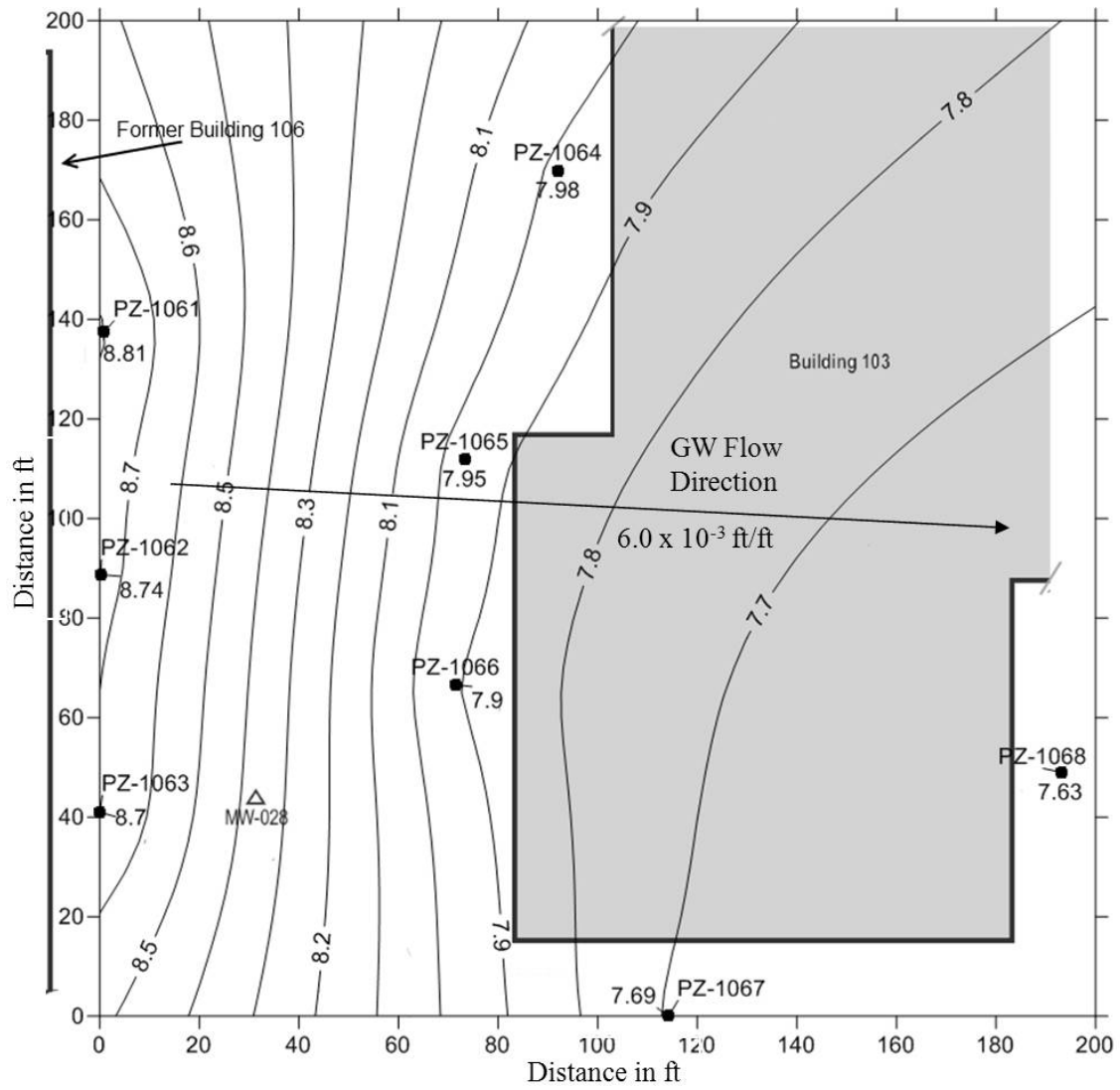

Figure 3: Direct Push Water/Soil Sampling Locations:



Note: Contour elevations are listed in ft amsl

Figure 4A: Groundwater Contour Map: Event 1 – August 14, 2009

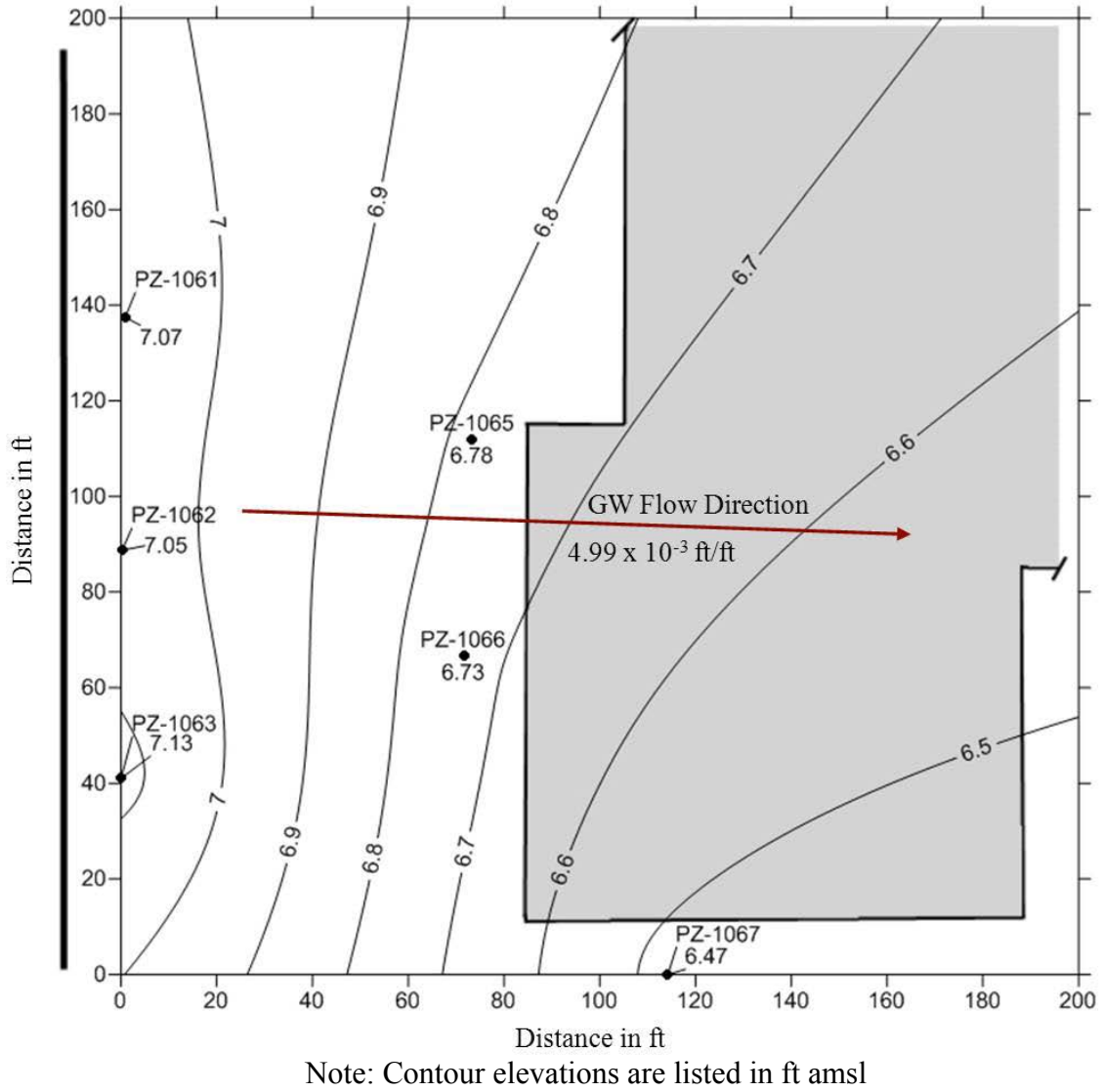
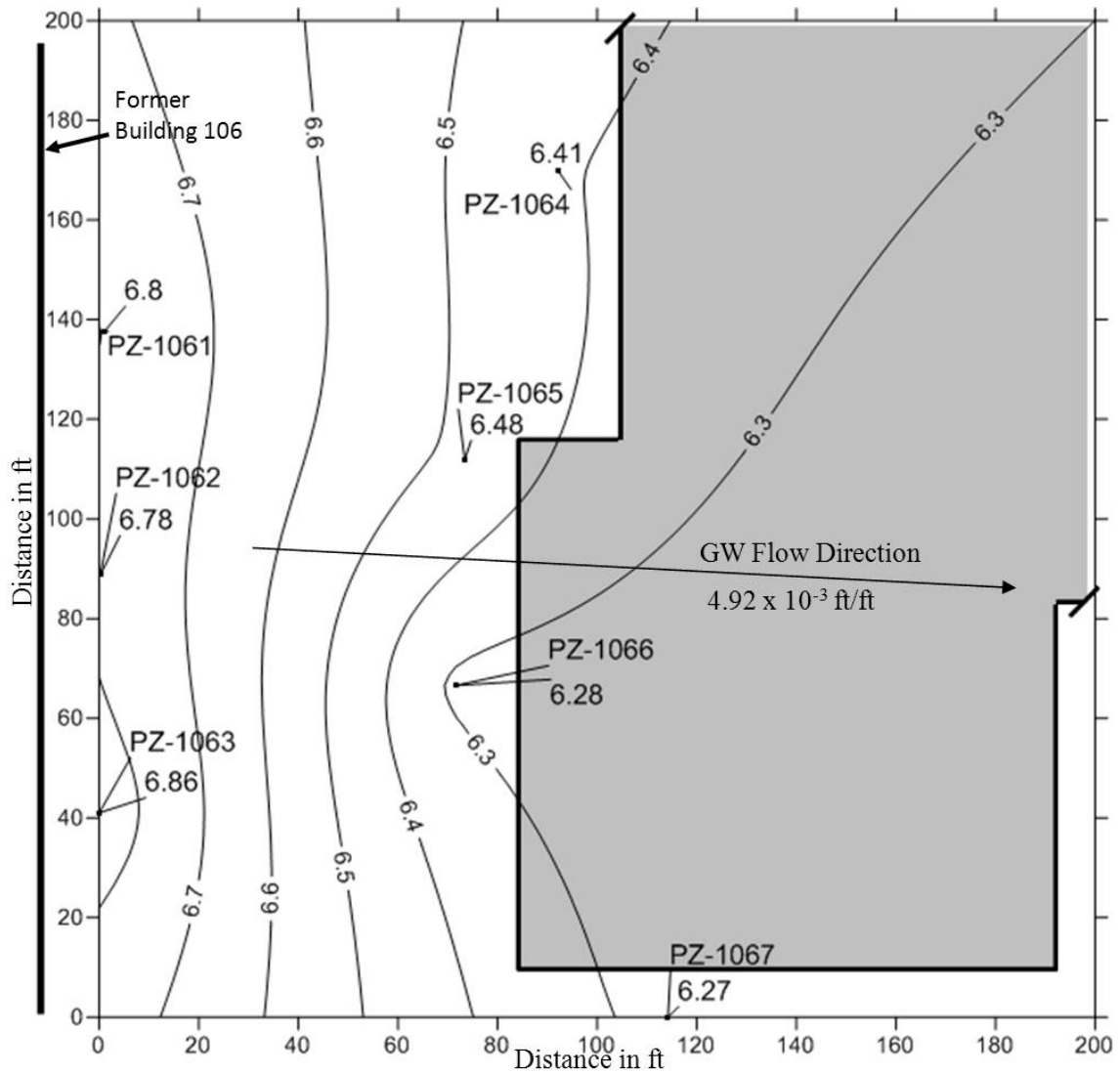
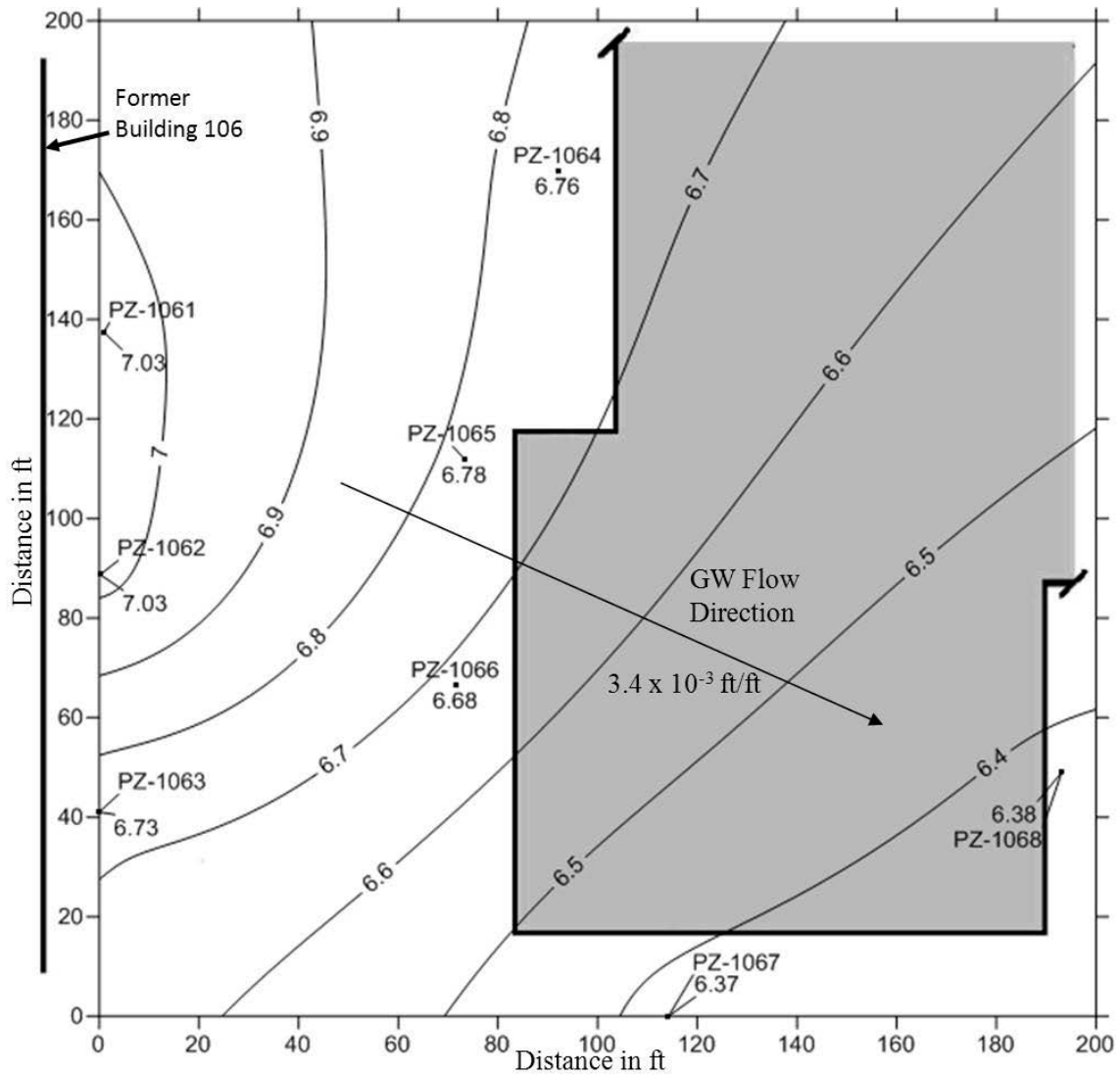

Figure 4B: Groundwater Contour Map: Event 2 – January 22, 2011



Note: Contour elevations are listed in ft amsl

Figure 4C: Groundwater Contour Map: Event 3 – June 11, 2011



Note: Contour elevations are listed in ft amsl

Figure 4D: Groundwater Contour Map: Event 4 – Sept 30, 2011



Figure 5A: Vapor Sampling Locations: Event 1 – August 6-15, 2009

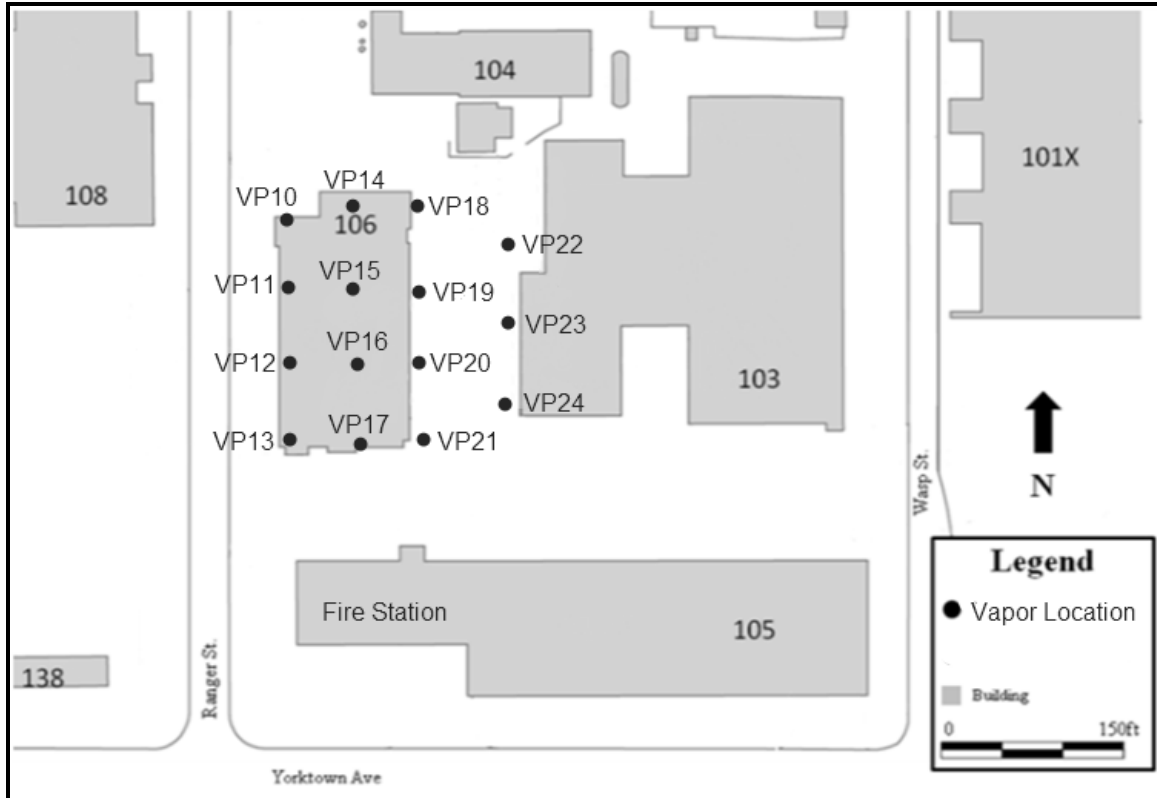

Figure 5B: Vapor Sampling Locations: Event 2 – January 9-22, 2011

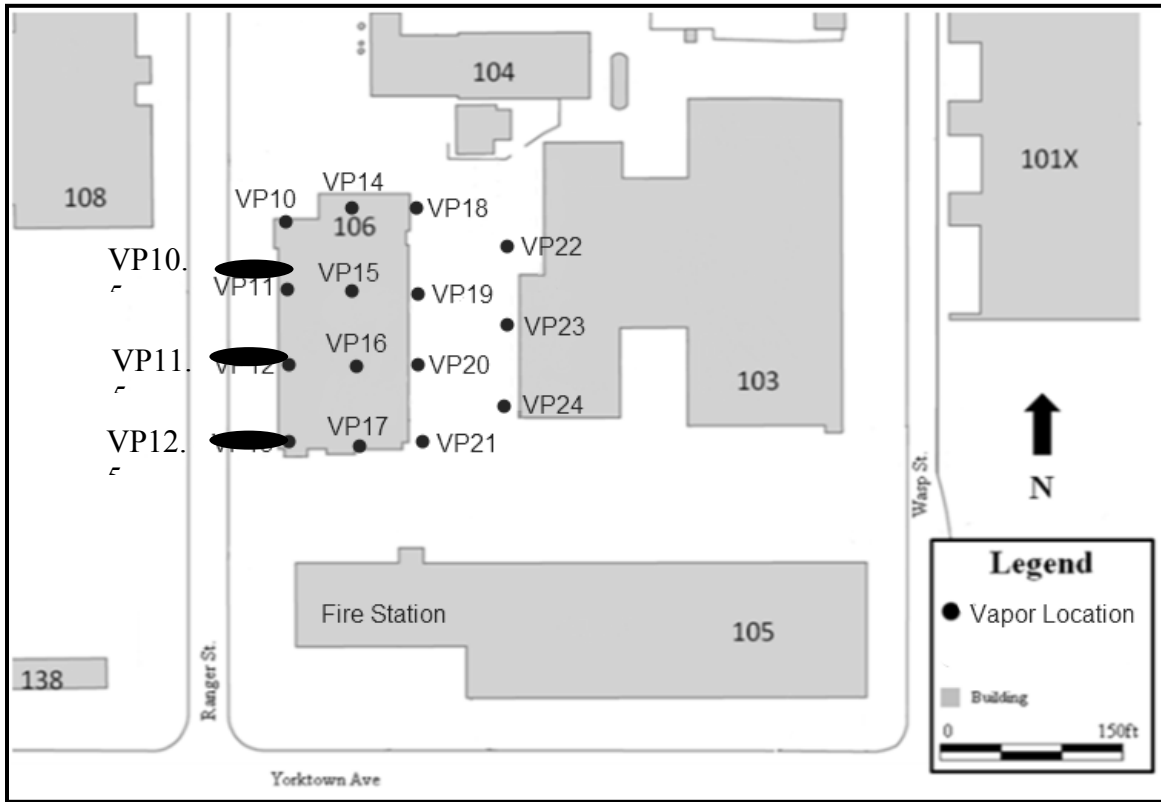

Figure 5C: Vapor Sampling Locations: Event 3 – June 4-13, 2011

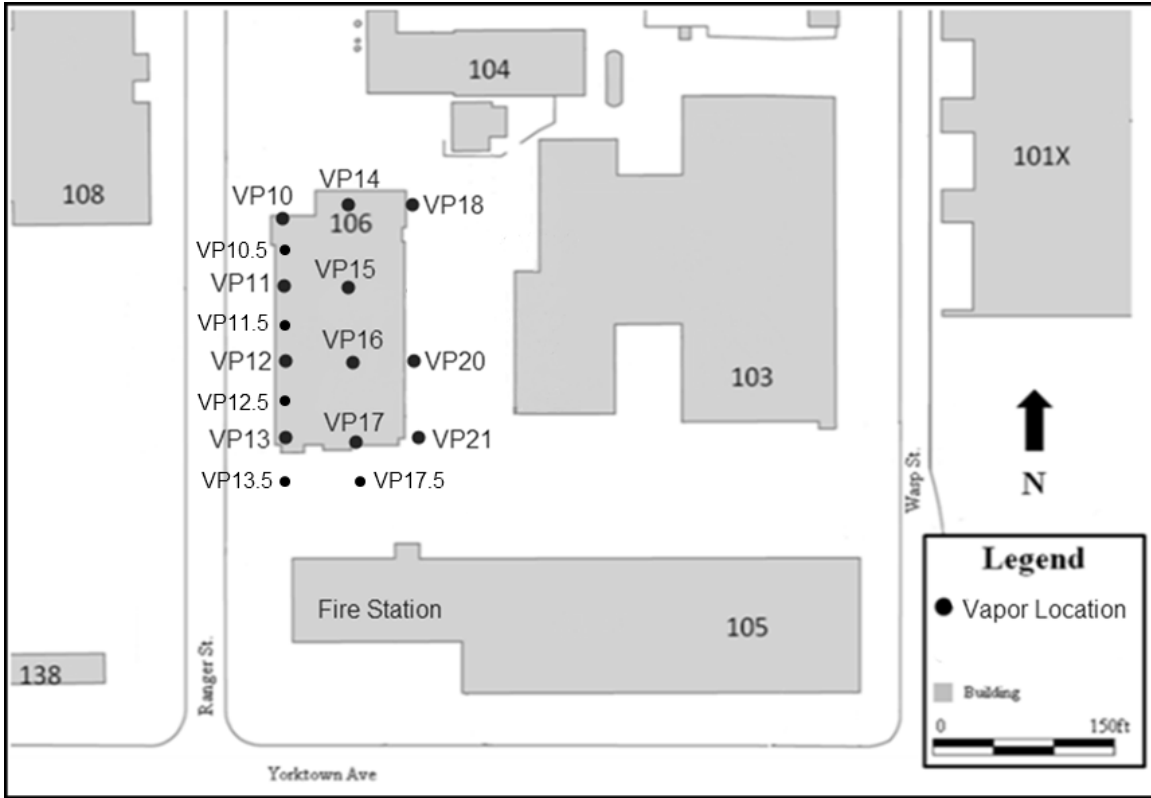

Figure 5D: Vapor Sampling Locations: Event 4 – Sept 20-30, 2011

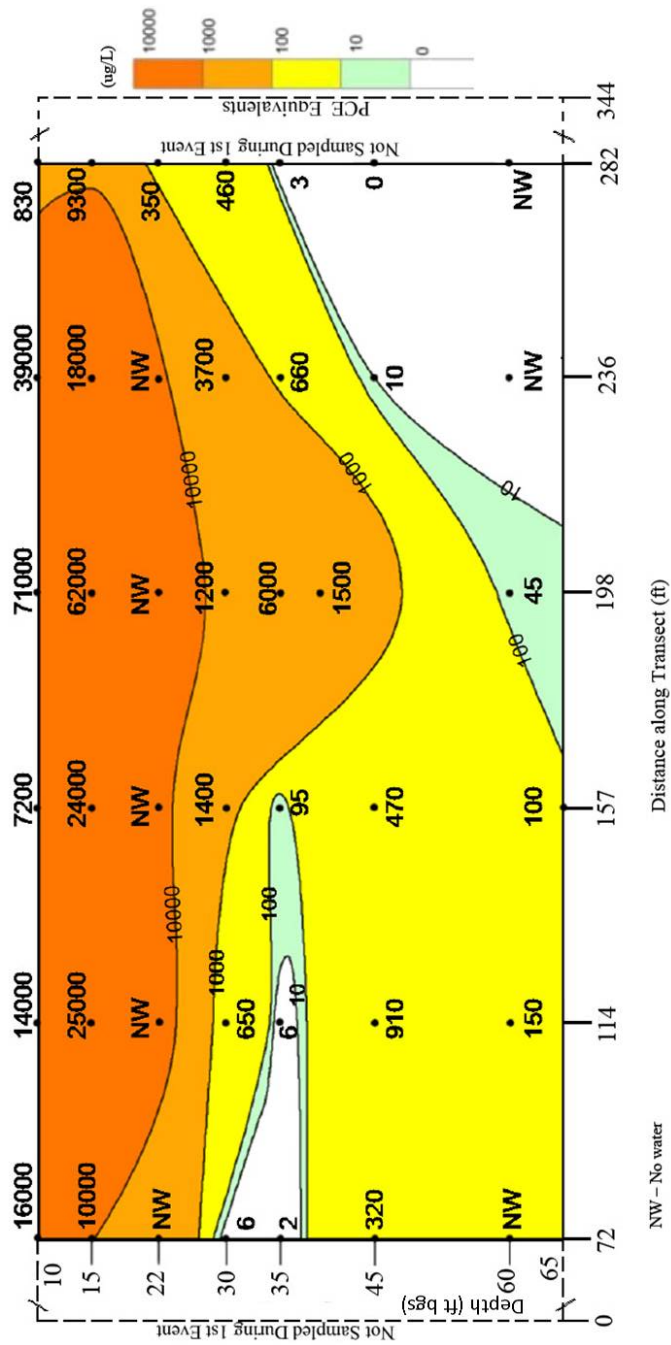

Figure 6A: Groundwater Concentration Vertical Transect Contour Plot: Event 1

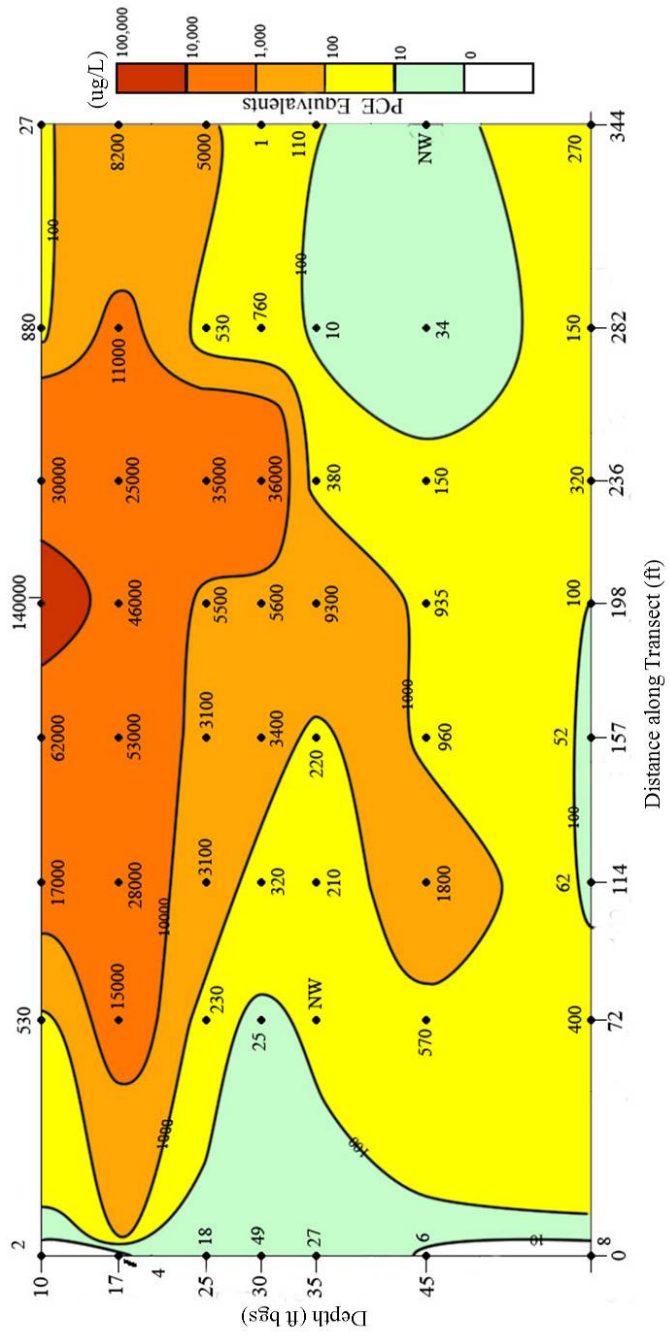

Figure 6B: Groundwater Concentration Vertical Transect Contour Plot: Event 2

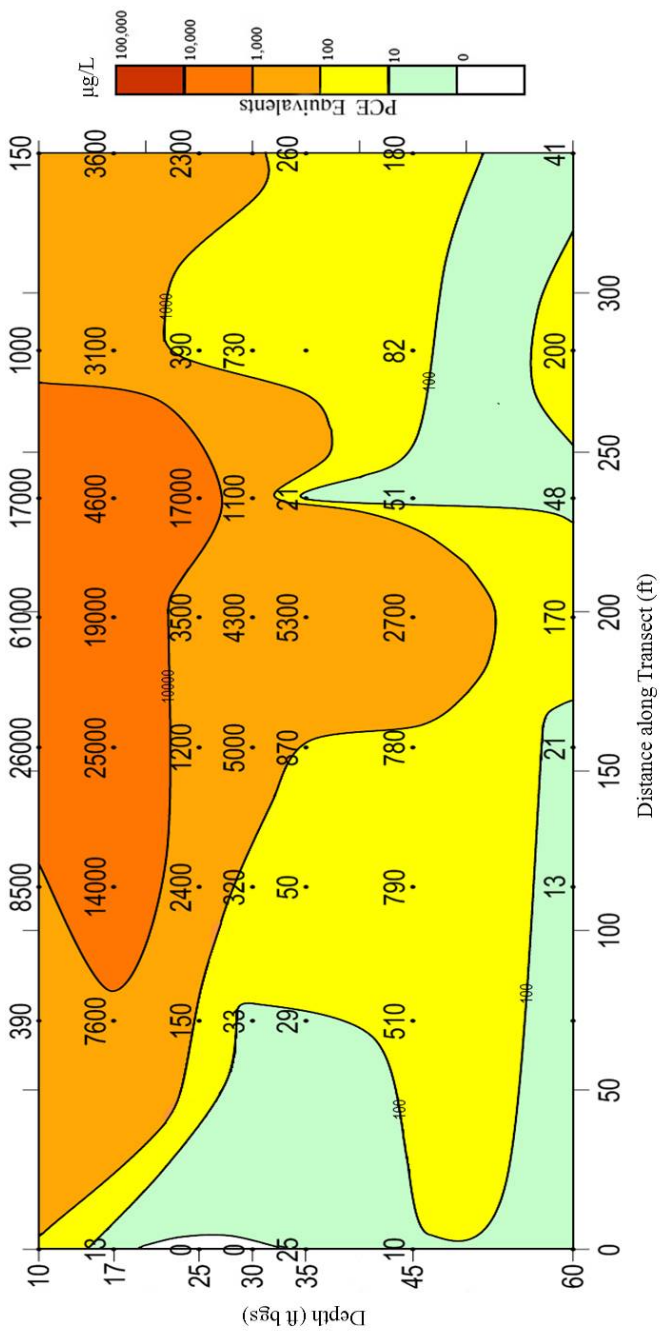

Figure 6C: Groundwater Concentration Vertical Transect Contour Plot: Event 3

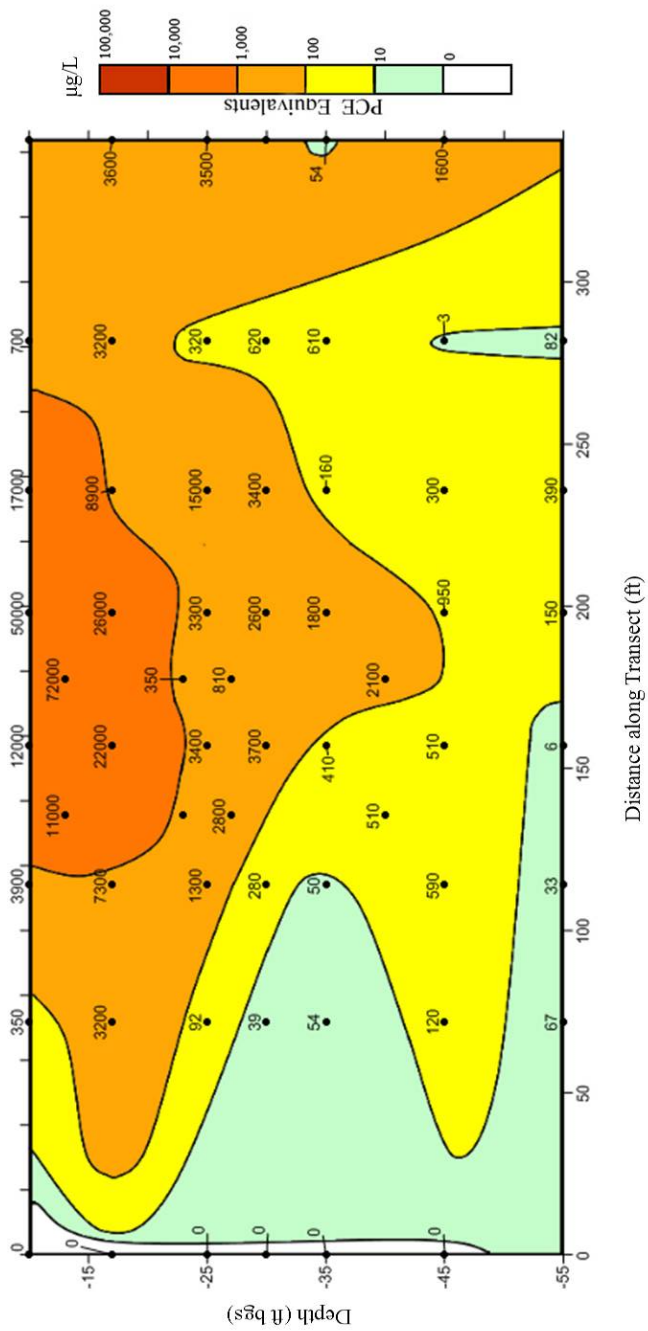

Figure 6D: Groundwater Concentration Vertical Transect Contour Plot: Event 4

Input Data and Grid

Site Location and I.D.: **NAS Jacksonville**
 Description: **Transect 1**

4. CHOOSE TRANSECT Transect 1 **5. CHOOSE TIME PERIOD** 1

6. ENTER TRANSECT DATA
 6.1 Distance of Transect 1 from Source
 6.2 Darcy Velocity Hydraulic Conductivity **6.6** Sampling Interval Mid Point of Sampling Interval
 6.3 Hydraulic Conductivity Units cm/sec No Yes
 6.4 Uniform Hydraulic Conductivity?
 6.5 Uniform Hydraulic Gradient?

Data Input Instructions
 Enter value directly.
 Value calculated by model
 (Don't enter any data)

Monitoring Point	Distance of Monitoring Point from Start of Transect (ft)	Mid Point of Sampling Interval (ft bgs)	Plume Top (ft bgs)	Plume Bottom (ft bgs)	Hydraulic Conductivity (cm/sec)	Concentration (ug/L)	
						Constituent A	Constituent B
1	0					PCE Equivalents	
2	212.5						0
3	211.5	10	10	65	5.35E-05		830
4	211.5	15	10	65	2.53E-04		9300
5	211.5	22	10	65	5.71E-04		350
6	211.5	30	10	65	2.78E-03		480
7	211.5	35	10	65	1.90E-05		3
8	211.5	45	10	65	2.14E-03		0
9	162	10	10	65	2.72E-04		39000
10	162	15	10	65	2.72E-04		18000
11	162	30	10	65	3.77E-03		3700
12	162	35	10	65	2.28E-03		660
13	162	45	10	65	4.71E-04		10
14	123	10	10	65	3.64E-03		71000
15	123	15	10	65	4.99E-04		62000

7. CHOOSE GRID (OPTIONAL)
 Number of rows
 Number of columns
 Refine Grid By: Refined Grid Constituent B

8. SELECT CONSTITUENT FOR CALCULATIONS
 PCE Equivalents Constituent B

Next Step:
Continue Data Input

Back to Transect Calculator Screen Import MW Data Export MW Data See Conc/Flux Grids
 Clear Screen Paste Example Restore Table Formatting Print **HELP**

Figure 7: Mass Flux Calculation Example

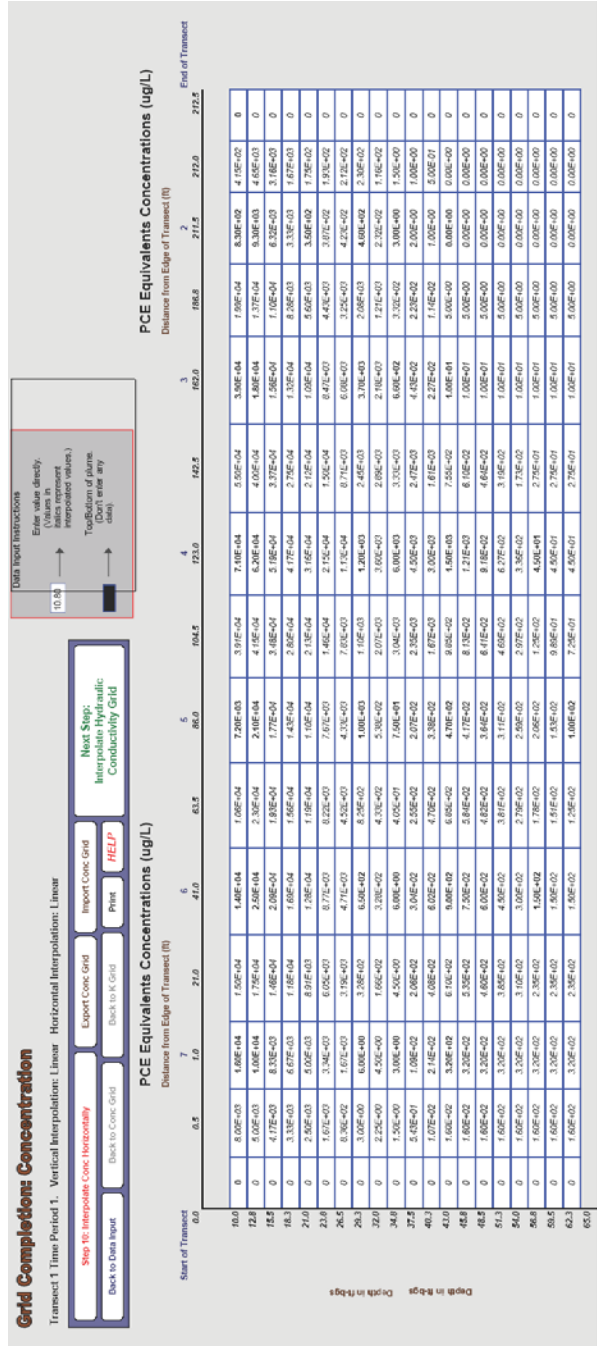

Figure 8: Mass Flux Calculation – Interpolated Concentration Profile Example

		Concentration			Mass Loss Rate
		Linear	Log	NN	PCE Equivalence (kg/y)
Conductivity	Linear	X			3.6
			X		2.5
				X	3.4
	Log	X			2.4
			X		1.8
				X	2.3
	NN	X			3.4
			X		2.5
				X	3.2
	Site Average				

Note: Transect from Event 1 is not as wide as subsequent events

Figure 11A: Transect A-A' Flux Calculations – Event 1: August 6-15, 2009

		Concentration			Mass Loss Rate
		Linear	Log	NN	PCE Equivalence (kg/y)
Conductivity	Linear	X			9.9
			X		7.6
				X	9.6
	Log	X			7.7
			X		6.2
				X	7.5
	NN	X			9.6
			X		7.4
				X	9.0
	Site Average				

Figure 11B: Transect A-A' Flux Calculations – Event 2: January 9-22, 2011

		Concentration			Mass Loss Rate
		Linear	Log	NN	PCE Equivalence (kg/y)
Conductivity	Linear	X			6.5
			X		4.0
				X	6.3
	Log	X			4.5
			X		2.9
				X	4.4
	NN	X			6.3
			X		3.9
				X	5.7
	Site Average				

Figure 11C: Transect A-A' Flux Calculations – Event 3: June 4-13, 2011

		Concentration			Mass Loss Rate
		Linear	Log	NN	PCE Equivalence (kg/y)
Conductivity	Linear	X			3.3
			X		2.4
				X	3.1
	Log	X			2.4
			X		1.8
				X	2.3
	NN	X			3.2
			X		2.4
				X	3.1
Site Average					2.7

Figure 11D: Transect A-A' Flux Calculations – Event 4: Sept 20-30, 2011

		Concentration			Mass Loss Rate
		Linear	Log	NN	PCE Equivalence (kg/y)
Conductivity	Linear	X			7.4×10^{-2}
			X		1.6×10^{-2}
				X	1.3×10^{-2}
	Log	X			5.1×10^{-2}
			X		1.6×10^{-2}
				X	8.7×10^{-2}
	NN	X			3.7×10^{-2}
			X		1.3×10^{-2}
				X	5.8×10^{-2}
	Site Average				

Figure 12A: Up-gradient Flux Input Calculations – Event 2: January 9-22, 2011

		Concentration			Mass Loss Rate
		Linear	Log	NN	PCE Equivalence (kg/y)
Conductivity	Linear	X			1.2×10^{-1}
			X		3.6×10^{-2}
				X	1.9×10^{-1}
	Log	X			9.2×10^{-2}
			X		3.3×10^{-2}
				X	1.4×10^{-1}
	NN	X			8.1×10^{-2}
			X		3.5×10^{-2}
				X	1.0×10^{-1}
	Site Average				9.3×10^{-2}

Figure 12B: Up-gradient Flux Input Calculations – Event 2: January 9-22, 2011

		Concentration			Mass Loss Rate
		Linear	Log	NN	PCE Equivalence (kg/y)
Conductivity	Linear	X			7.7×10^{-2}
			X		5.0×10^{-2}
				X	9.2×10^{-3}
	Log	X			6.9×10^{-2}
			X		4.6×10^{-2}
				X	8.0×10^{-2}
	NN	X			7.4×10^{-2}
			X		4.7×10^{-2}
				X	8.2×10^{-2}
Site Average					5.9×10^{-2}

Figure 12C: Up-gradient Flux Input Calculations – Event 3: June 4-13, 2011

		Concentration			Mass Loss Rate
		Linear	Log	NN	PCE Equivalence (kg/y)
Conductivity	Linear	X			1.2×10^{-1}
			X		9.0×10^{-2}
				X	1.5×10^{-1}
	Log	X			1.0×10^{-1}
			X		7.9×10^{-2}
				X	1.2×10^{-1}
	NN	X			1.2×10^{-1}
			X		8.0×10^{-2}
				X	1.5×10^{-1}
Site Average					1.1×10^{-1}

Figure 12D: Up-gradient Flux Input Calculations – Event 4: Sept 20-30, 2011

Interpolation Error Results

INSTRUCTIONS

- The table below shows all concentration and, if applicable, non-uniform conductivity/Darcy velocity and gradient input data.
- During the uncertainty analysis, each of the points in the table are removed one at a time and the mass flux calculated without that point using the interpolation scheme specified in the Data Input section (note that

Site Location and I.D.: [REDACTED]
 Description: [REDACTED]

[Next Step: Mass Flux Summary](#)
[Back to Mass Flux Result](#)
[Print](#)
[Back to Data Input](#)
[HELP](#)

SELECT TRANSECT TO VIEW Transect 1 ▾
 SELECT TIME PERIOD TO VIEW 2 ▾

PCE Equiv Interpolation Methods
 Hydraulic Conductivity: 1) Vertical: Linear 2) Horizontal: Linear
 Concentration: 1) Vertical: Linear 2) Horizontal: Linear
 Hydraulic Gradient: Uniform

Total Mass Flux Including All Points 1.11E+02 (g/day)

					RESULTS	
End of Transect	Midpoint of Sampling Interval	Parameter Examined	Parameter Value Removed For Analysis	Parameter Units	Total Mass Flux Excluding Selected Point and Interpolating (g/day)	Contribution of Selected Point to Total Mass Flux (%)
1	Start of Transect	Conductivity	3.50E-03	cm/sec	1.11E+02	0.0
2	2B	Conductivity	3.50E-03	cm/sec	1.11E+02	0.1
3	2B	Conductivity	4.30E-04	cm/sec	1.11E+02	-0.4
4	2B	Conductivity	2.80E-04	cm/sec	1.11E+02	-0.1
5	2B	Conductivity	2.00E-03	cm/sec	1.11E+02	0.0
6	2B	Conductivity	3.70E-04	cm/sec	1.11E+02	0.0
7	2B	Conductivity	9.30E-04	cm/sec	1.11E+02	0.0
8	2B	Conductivity	1.30E-03	cm/sec	1.11E+02	0.0
9	2.00E+00	Conductivity	2.60E-04	cm/sec	1.11E+02	0.0
10	2.00E+00	Conductivity	1.90E-04	cm/sec	1.12E+02	-1.2
11	2.00E+00	Conductivity	2.20E-03	cm/sec	1.12E+02	-0.8
12	2.00E+00	Conductivity	6.90E-03	cm/sec	1.11E+02	0.2
13	2.00E+00	Conductivity		cm/sec	1.11E+02	0.0
14	2.00E+00	Conductivity	1.20E-04	cm/sec	1.13E+02	-1.6
15	2.00E+00	Conductivity		cm/sec	1.11E+02	0.0
16	3.00E+00	Conductivity	8.80E-03	cm/sec	9.80E+01	11.7
17	3.00E+00	Conductivity	4.60E-04	cm/sec	1.27E+02	-14.4
18	3.00E+00	Conductivity	2.20E-03	cm/sec	1.11E+02	0.3
19	3.00E+00	Conductivity	2.80E-03	cm/sec	1.11E+02	0.1
20	3.00E+00	Conductivity	1.70E-03	cm/sec	1.11E+02	0.0
21	3.00E+00	Conductivity	9.50E-04	cm/sec	1.11E+02	0.0
22	3.00E+00	Conductivity	7.50E-05	cm/sec	1.11E+02	-0.1
23	4.00E+00	Conductivity	1.30E-03	cm/sec	1.07E+02	3.8
24	4.00E+00	Conductivity	3.40E-04	cm/sec	1.28E+02	-15.6
25	4.00E+00	Conductivity	7.70E-03	cm/sec	1.01E+02	9.0
26	4.00E+00	Conductivity	1.40E-04	cm/sec	1.12E+02	-1.0
27	4.00E+00	Conductivity	1.70E-04	cm/sec	1.11E+02	-0.3
28	4	Conductivity	5.10E-03	cm/sec	1.10E+02	0.8
29	4	Conductivity	4.80E-04	cm/sec	1.11E+02	-0.2
30	5	Conductivity	4.50E-03	cm/sec	8.16E+01	26.5
31	5	Conductivity	2.00E-04	cm/sec	1.27E+02	-14.1
32	5	Conductivity	1.70E-03	cm/sec	1.10E+02	0.9
33	5	Conductivity	1.70E-03	cm/sec	1.12E+02	-0.6
34	5	Conductivity	3.40E-03	cm/sec	1.10E+02	1.0
35	5	Conductivity	1.60E-03	cm/sec	1.12E+02	-0.8
36	5	Conductivity	8.20E-03	cm/sec	1.11E+02	0.3
37	6	Conductivity	3.00E-07	cm/sec	1.12E+02	-0.8
38	6	Conductivity	3.60E-04	cm/sec	1.16E+02	-4.7
39	6	Conductivity	5.10E-03	cm/sec	1.05E+02	5.6
40	6	Conductivity	4.90E-03	cm/sec	1.08E+02	2.7
41	6	Conductivity	2.00E-03	cm/sec	1.11E+02	-0.5
42	6	Conductivity	8.90E-04	cm/sec	1.11E+02	-0.1
43	6	Conductivity	2.80E-03	cm/sec	1.11E+02	0.1
44	7	Conductivity	4.80E-05	cm/sec	1.11E+02	0.0
45	7	Conductivity	1.50E-04	cm/sec	1.12E+02	-1.0
46	7	Conductivity	2.10E-03	cm/sec	1.11E+02	-0.1
47	7	Conductivity	3.60E-03	cm/sec	1.10E+02	1.0
48	7	Conductivity	1.10E-04	cm/sec	1.11E+02	-0.2
49	7	Conductivity	2.00E-03	cm/sec	1.11E+02	0.0
50	7	Conductivity	9.30E-04	cm/sec	1.11E+02	0.0
51	8	Conductivity	7.70E-04	cm/sec	1.11E+02	0.0
52	8	Conductivity	7.70E-04	cm/sec	1.11E+02	-0.1
53	8	Conductivity		cm/sec	1.11E+02	0.0
54	8	Conductivity	1.30E-03	cm/sec	1.11E+02	0.2
55	8	Conductivity	1.60E-04	cm/sec	1.11E+02	0.0
56	8	Conductivity		cm/sec	1.11E+02	0.0
57	8	Conductivity	3.70E-04	cm/sec	1.11E+02	0.0
58	End of Transect	Conductivity	3.70E-04	cm/sec	1.11E+02	0.0

Figure 13: Uncertainty Analysis – Example

APPENDIX C: SITE 2 PARRIS ISLAND MCRD



Data Analysis Report

Parris Island MCRD

Former MWR Dry Cleaning Facility, Site SWMU-45
Marine Corps Recruit Depot (MCRD)
Parris Island, South Carolina

ESTCP Project ER-0705:

May, 2012

Tables

Table 1A	Geologic Description of Parris Island Soil Core ASU9: Event 1
Table 1B	Geologic Description of Parris Island Soil Core ASU9: Event 2
Table 2	Depth-to-Water Measurements and Calculated Groundwater Elevations for Permanent Monitoring Wells: Events 1, 2, 3, and 4.
Table 3A	Slug Test Data: Event 1, Oct 16-26, 2008
Table 3B	Slug Test Data: Event 3, July 5-19, 2010
Table 4	Hydraulic Conductivity Estimates for Depth-Discrete Aquifer Specific-Capacity Testing: Events 1, 2, 3, and 4.
Table 5A	Water Quality Data for Depth-Discrete, Direct Push Groundwater Samples: Event 1: Oct 16-26, 2008
Table 5B	Water Quality Data for Depth-Discrete, Direct Push Groundwater Samples: Event 2: Aug 15-22, 2009
Table 5C	Water Quality Data for Depth-Discrete, Direct Push Groundwater Samples: Event 3: July 5-19, 2010
Table 5D	Water Quality Data for Depth-Discrete, Direct Push Groundwater Samples: Event 4: June 14-25, 2011
Table 6A	Ion Concentration Data for Depth-Discrete, Direct Push Groundwater Samples: Event1: Oct 16-26, 2008
Table 6B	Ion Concentration Data for Depth-Discrete, Direct Push Groundwater Samples: Event 2: Aug 15-22, 2009
Table 6C	Ion Concentration Data for Depth-Discrete, Direct Push Groundwater Samples: Event 3: July 5-19, 2010
Table 6D	Ion Concentration Data for Depth-Discrete, Direct Push Groundwater Samples: Event 4: June 14-25, 2011

Table 7	DOC Concentration Data for Depth-Discrete, Direct Push Groundwater Samples: Event 1, 2, 3, and 4.
Table 8	COD Concentration Data for Depth-Discrete, Direct Push Groundwater Samples: Event 1, 2, 3, and 4.
Table 9	Alkalinity Data for Depth-Discrete, Direct Push Groundwater Samples: Events 1, 2, 3, and 4.
Table 10A	VOC Concentration Data for Depth-Discrete Groundwater Samples: Event 1: Oct 16-26, 2008
Table 10B	VOC Concentration Data for Depth-Discrete Groundwater Samples: Event 2: Aug 15-22, 2009
Table 10C	VOC Concentration Data for Depth-Discrete Groundwater Samples: Event 3: July 5-19, 2010
Table 10D	VOC Concentration Data for Depth-Discrete Groundwater Samples: Event 4: June 14-25, 2011
Table 11A	VOC Concentration Data for Permanent Monitoring Wells: Event 1: Oct 16-26, 2008
Table 13B	VOC Concentration Data for Permanent Monitoring Wells: Event 2: Aug 15-22, 2009
Table 13C	VOC Concentration Data for Permanent Monitoring Wells: Event 3: July 5-19, 2010
Table 11D	VOC Concentration Data for Permanent Monitoring Wells: Event 4: June 14-25, 2011
Table 12A	Fatty Acid Analysis Results: Event 1: Oct 16-26, 2008
Table 12B	Fatty Acid Analysis Results: Event 2: Aug 15-22, 2009
Table 13A	Dehalococcoides Testing: Event 2: Aug 15-22, 2009
Table 13B	Dehalococcoides Testing: Event 3: July 5-19, 2010

Table 14	Stable Isotope Analysis: Event 3: July 15, 2010
Table 15A	Soil Gas Concentration Data: Event 1: Oct 16-26, 2008
Table 15B	Soil Gas Concentration Data: Event 2: Aug 15-22, 2009
Table 15C	Soil Gas Concentration Data: Event 3: July 5-19, 2010
Table 15D	Soil Gas Concentration Data: Event 4: June 14-25, 2011
Table 16A	Diffusion Coefficient Results: Event 1: Oct 16-26, 2008
Table 16B	Diffusion Coefficient Results: Event 3: July 5-19, 2010
Table 16C	Diffusion Coefficient Results: Event 4: June 14-25, 2011
Table 17	Vapor Flux Calculation Results: Events 1, 2 ,3 and 4.
Table 18	ML6-9 ft bgs – LNAPL Carbon Range Distribution: Event 1

Figures

- Figure 1 Site Map - MCRD Parris Island SWMU45
- Figure 2 Direct Push Water/Soil Sampling Locations
- Figure 3A Groundwater Contour Map: Upper Aquifer: Event 1: Oct 16-26, 2008
- Figure 3B Groundwater Contour Map: Lower Aquifer: Event 1: Oct 16-26, 2008
- Figure 3C Groundwater Contour Map: Upper Aquifer: Event 2: Aug 15-22, 2009
- Figure 3D Groundwater Contour Map: Lower Aquifer: Event 2: Aug 15-22, 2009
- Figure 3E Groundwater Contour Map: Upper Aquifer: Event 3: July 5-19, 2010
- Figure 3F Groundwater Contour Map: Lower Aquifer: Event 3: July 5-19, 2010
- Figure 3G Groundwater Contour Map: Lower Aquifer: Event 4: June 14-25, 2011
- Figure 3H Groundwater Contour Map: Lower Aquifer: Event 4: June 14-25, 2011
- Figure 4A Vapor Sampling Locations – Events 1 & 2
- Figure 4B Vapor Sampling Locations – Events 3 & 4
- Figure 5A Groundwater Concentration Vertical Contour Plot: Transect A-A'
Event 1: Oct 16-26, 2008
- Figure 5B Groundwater Concentration Vertical Contour Plot: Transect A-A'
Event 2: Aug 15-22, 2009
- Figure 5C Groundwater Concentration Vertical Contour Plot: Transect A-A'
Event 3: July 5-19, 2010
- Figure 5D Groundwater Concentration Vertical Contour Plot: Transect A-A'
Event 4: June 14-25, 2011
- Figure 6 Groundwater Concentration Vertical Contour Plot: Transect B-B'
Event 3: July 5-19, 2010
- Figure 7 Groundwater Concentration Vertical Contour Plot: Transect C-C'

Event 3: July 5-19, 2010

- Figure 8 Mass Flux Calculation – Input Example: Transect A-A’ Event 3
- Figure 9 Mass Flux Calculation – Output Example: Linear Interpolated Concentration Profile Transect A-A’: Event 3 – July 5-19, 2010
- Figure 10 Mass Flux Calculation – Output Example: Linear Interpolated Hydraulic Conductivity Profile Transect A-A’: Event 3 – July 5-19, 2010
- Figure 11 Mass Flux Calculation – Output Example: Linear-Linear Interpolated Mass Flux Transect A-A’ – Event 3: July 5-19, 2010
- Figure 12A Mass Flux Calculation Transect A-A’ – Interpolation Combinations:
Event 1: Oct 16-26, 2008
- Figure 12B Mass Flux Calculation Transect A-A’ – Interpolation Combinations:
Event 2: Aug 15-22, 2009
- Figure 12C Mass Flux Calculation Transect A-A’ – Interpolation Combinations:
Event 3: July 5-19, 2010
- Figure 12D Mass Flux Calculation Transect B-B’ – Interpolation Combinations:
Event 3: July 5-19, 2010
- Figure 12E Mass Flux Calculation Transect C-C’ – Interpolation Combinations:
Event 3: July 5-19, 2010
- Figure 12F Mass Flux Calculation Transect A-A’ – Interpolation Combinations:
Event 4, June 14-25, 2011
- Figure 13 Uncertainty Analysis Output Example: Transect A-A’: Event 3: Linear-Linear Interpolation Combination

Acronyms and Abbreviations

amsl	Above mean sea level
bgs	Below ground Surface
btoc	Below top of casing
CAH	Chlorinated aliphatic hydrocarbon
COD	Chemical oxygen demand
DCA	Dichloroethane
DCE	Dichloroethylene
DELCD	Dry electrolytic conductivity detector
Dhc	Dehalococcoides
DO	Dissolved oxygen
DOC	Dissolved organic carbon
DTW	Depth to water
EC	Electrical conductivity
ERH	Electrical resistance heating
ESTCP	Environmental Security Technology Certification Program
FID	Flame-ionization detector
ft	Feet
GC	Gas chromatography
kg	Kilogram
ND	Non-detect
NQ	Not quantified
NW	No water available for analysis
ORP	Oxidation reduction potential
PCE	Perchloroethylene

PCR	Polymerase chain reaction
sq ft	Square feet
TCA	Trichloroethane
TCE	Trichloroethylene
TOC	Top of casing
temp	Temperature
VC	Vinyl Chloride
VFA	Volatile fatty acid
VOA	Volatile organic analysis
VOC	Volatile organic compound
yr	Year

1.0 Introduction

Four field sampling events occurred at the Former MWR Dry Cleaning Facility, Site SWMU-45, Marine Corp Recruit Depot (MCRD), Parris Island, South Carolina under the Environmental Security Technology Certification Program (ESTCP) project ER-0705, *Assessment of the Natural Attenuation of NAPL Source Zones and Post-Treatment NAPL Source Zones*. The events were performed on October 16-26th, 2008, August 15-22nd, 2011; July 5-19th, 2010; and June 14-20th, 2011 for the first through fourth events respectively. Figures 1 and 2 identify the specific area of interest for this field investigation.

Consistent with the objectives set forth under the ER-0705 Demonstration Plan, the field investigation at this site included the following:

- Verification of the site geological/hydro-geological conceptual model;
- Collection of data necessary to determine if source zone natural attenuation is occurring (i.e., dissolved groundwater concentrations up- and down-gradient of the source zone and vapor concentrations above the source zone)
- Collection of data necessary to determine the rate of source zone natural attenuation (i.e., dissolved groundwater concentrations up- and down-gradient of the source zone, vapor concentrations above the source zone, hydraulic gradient and hydraulic conductivities, effective diffusion coefficients); and,
- Collection of soil and groundwater samples for assessment of the presence of known chlorinated hydrocarbon biodegrading organisms.

2.0 Field Investigation

Field investigations were performed in accordance with the approved ER-0705 Demonstration Plan and the site-specific demonstration plan. The non-site specific demonstration plan outlines the types of sampling/testing performed, the locations for which are shown in Figure 2. These included:

2.1 Verification of the site hydro-geological conceptual model:

- d. Basic Geologic Profile: A continuous soil core was collected for geologic evaluation. Using the Geoprobe Macro Core sampler, soil cores were collected to a total depth of 18 ft below ground surface (bgs) at the two locations shown in Figure 2. The basic geologic profile found in Table 3 was prepared based on visual observation of these soil cores.
- e. Depth-to-water: Depth-to-water (DTW) was measured in selected permanent monitoring wells to determine groundwater elevation, flow direction, and hydraulic gradient. Based on data collected and presented in Table 4, the groundwater flow direction is to the southeast with an average gradient of 0.004 ft/ft in the upper aquifer and a gradient of 0.005 ft/ft in the lower aquifer. Event specific hydraulic gradient data may be found in Figure 3.

- f. Aquifer Characterization: Hydraulic Conductivity Testing – Slug Tests: Slug tests were performed in selected permanent monitoring wells during the first and third field event (October 16 – 26, 2008; July 5-19, 2010). Slug tests were performed as described in the ER-0705 Demonstration Plan and were analyzed using both the Hvorslev and Bouwer and Rice methods. Slug testing results are shown in Table 5.
- g. Aquifer Characterization: Hydraulic Conductivity Testing – Aquifer Specific-Capacity Tests:
Depth-discrete, aquifer specific-capacity tests were conducted at direct push locations shown in Figure 2. Data from depth-discrete aquifer-specific capacity testing provide increased spatial resolution of hydraulic characteristics and they are used in mass flux calculations discussed below. Aquifer specific-capacity tests involve the measurement of the flow-rate achieved under a fixed drawdown, and those data are used with the Moye equation to estimate the hydraulic conductivity at each location and depth. Aquifer specific-capacity tests are described in further detail in the non-site-specific ER-0705 Demonstration Plan and in Cho et al (2000). Event and location specific results are shown in Table 6.

2.2 Collection and analysis of groundwater samples necessary to determine groundwater concentrations, dissolved phase contaminant flux, and biodegradation activity:

- d. Depth-Discrete Groundwater Sampling: Depth-discrete groundwater sampling was performed at direct push locations shown in Figure 2. Groundwater samples were collected using a Geoprobe Screen point Sampler and a peristaltic pump. Groundwater samples were collected and preserved as outlined in the non-site-specific ER-0705 Demonstration Plan.
- e. Depth Discrete Groundwater Sample Analysis: At the time of groundwater sample collection, field water quality parameters including pH, electrical conductivity (EC), temperature (T), dissolved oxygen (DO), and oxidation reduction potential (ORP) were measured. Field water quality parameter results are summarized in Table 7.

General water chemistry analyses including anions (Cl^- , NO_3^{2-} , SO_4^{2-}), cations (Fe^{2+} , Mn^{2+}) dissolved organic carbon (DOC), chemical oxygen demand (COD), and alkalinity were performed as possible on all direct push samples collected. General water chemistry analyses were performed as outlined in the non-site-specific ER-0705 Demonstration Plan. General water chemistry data are summarized in Tables 8, 9, and 10.

Dissolved volatile organic compound (VOC) analyses were performed on-site by heated-headspace analysis and gas chromatography (GC) using a dry electrolytic

conductivity detector (DELCD) and/or a flame-ionization detector (FID). The details of these analyses methods are provided in the non-site-specific ER-0705 Demonstration Plan. Dissolved VOC concentrations are presented in Table 11.

- f. Permanent Monitoring Well Groundwater Sampling and Analysis: To aid in the delineation of source zone extent, groundwater samples were also collected from a selected group of permanent, single completion and multi-level monitoring wells for VOC analysis. Monitoring wells sampled and types of analyses conducted on the samples are shown in Table 2. Dissolved volatile organic compound analyses were performed on site as described above. The results are presented in Table 12.
- g. Volatile Fatty Acid Analysis: To determine if oil breakdown products continue to be available to contribute to DNAPL degradation, a subset of seven samples were collected from permanent, single completion and multi-level monitoring wells directly down-gradient of the zero-valent iron (ZVI) injections performed by Geosyntec under ESTCP Project ER-0431. Sample locations included multilevel wells ML6-9, ML6-14, and ML6-19. Samples were collected in 40 ml VOA bottles, preserved with benzalkonium chloride, and were shipped via FedEx overnight to Microseeps, Inc., Pittsburgh, PA for analysis. Results for volatile fatty acid analyses are presented in Table 13.
- h. Dehalococoides Analysis: Water Samples were collected to evaluate the presence and numbers of Dehalococoides biodegrading organisms. One-liter (1 L) samples were collected at the 11 depth-discrete, direct push locations identified in Table 1. Samples were extracted using a Mobio Water DNA Extraction Kit and amplified using nested PCR (polymerase chain reaction). Results are presented in Table 14.
- i. Stable Isotope Analysis: Water samples were collected to examine the potential benefits of isotope analysis data in relation to source zone natural attenuation. Samples were collected in 40mL VOA bottles at sampling locations ASU3 to ASU8 and ASU11 at the eleven foot interval. Samples were preserved with hydrochloric acid to below pH 2. Preserved samples were shipped via FedEx overnight to Microseeps, Inc., Pittsburgh, PA for analyses. Results are presented in Table 16.

2.3 Collection of data necessary to determine soil gas concentrations above the source zone and the vapor phase contaminant flux

- e. Soil Gas Sampling and Analysis: Soil gas samples were collected from temporary soil gas sampling installations above the source zone area, at the locations shown in Figure 5. Using a 3 inch hand auger, Geoprobe slide hammer, a 1-inch drive rod, and disposable stainless steel drive tips, vapor implants were installed to approximately 2 to 2.5 ft below ground surface, a depth estimated to be 1 ft above the water table. Soil gas sampling implants were installed with a sand-pack and cement-bentonite seal to minimize potential short-circuiting from ground surface.

Vapor samples were collected in tedlar bags using a lung sampler and were analyzed on-site at the time of collection by gas chromatography (GC) using a dry electrolytic conductivity detector (DELCD) and a flame-ionization detector (FID). Soil gas sampling results are summarized in Table 15.

To verify the integrity of the soil gas implants helium was used as a tracer to determine if ambient air leakage was diluting the samples. To do this, a helium halo was used as is described by Banikowski et al. (2009). Helium was not detected above any of the vapor sampling locations during the integrity testing.

- f. Soil Diffusion Coefficient Measurement: In situ diffusion coefficient tests were performed using a method described in Johnson et al (1998). After installation of the sampling point and collection of a soil gas sample, 1 L of a mix of up to 10% helium in soil gas was injected into the sample implant. After waiting a predetermined amount of time, 1 L of soil gas was withdrawn for helium analysis. The helium mass recovery, time for the test, and volumes injected and extracted are used to calculate the effective diffusion coefficients. Results from all sampling events are given in Table 16.

Prior to calculating source zone loss rates, all dissolved and vapor concentrations were converted to equivalent PCE mass concentrations assuming that PCE was the parent compound for this source zone. This is necessary to account for the unmeasured mass of Cl⁻ ions generated with each dechlorination step. For MCRD Parris Island reporting, VOC concentrations were converted to “PCE equivalents” using adjustment factors based on the molar equivalence of each compound. Adjustment factors are shown as a secondary table under Table 17. The dissolved concentration data were also summarized in lateral transect contour plots as discussed below. Further discussion of mass equivalency can be found in the DNAPL SZNA Method provided to ESTCP.

Figures 6A-6E shows a vertical dissolved chemical concentration (PCE equivalents) contour plot along transect A-A', B-B' and C-C' (see Figure 2) using data from direct push locations ASU3 through ASU8 and ASU11 through ASU24. The transects are drawn roughly perpendicular to the groundwater flow direction and data from the sampling locations are projected onto this transect before preparing the contour plot.

Using the VOC groundwater concentration data converted to equivalent PCE concentrations, depth-discrete hydraulic conductivity estimates (see Table 6), and the calculated event specific upper- and lower-level hydraulic gradients (see Figures 3A-3F), a mass flux calculation was performed using the Mass Flux Toolkit, Version 1.0. The Mass Flux Toolkit is a freeware program developed by Groundwater Services, Inc. and others under a contract funded by ESTCP. Figure 7 presents a snapshot of the input screen for the mass flux analysis. There are three interpolation schemes available for analysis within the Mass Flux Toolkit, and all possible combinations of interpolation schemes were tested in order to assess the sensitivity of the results to the interpolation scheme used. The resulting hydraulic conductivity and concentration profiles generated by various interpolation schemes are displayed in Figures 8 and 9. Figure 10 shows as an example the output of the linear interpolation scheme for the mass flux result for all

chlorinated aliphatic hydrocarbons expressed consistently as PCE equivalents. Mass flux results from nine possible interpolation combinations are summarized in Figure 11. The results are similar for all methods, with the difference between the lowest and highest value being only about a factor of two

The Mass Flux Toolkit contains an uncertainty analysis that allows users to identify specific data points that most influence the calculated results. Use of this option on Event 1 data with several interpolation options indicated that the calculated mass flux was most sensitive to changes in the hydraulic conductivity profile, especially in the vicinity of ASU5. Thus, those results suggested that uncertainty in the mass flux estimate might be decreased by increasing the vertical sampling resolution through the highly conductive zone surrounding ASU5 and ASU6, as a large contribution to the overall mass flux comes through this section of the transect.

To accomplish this during the subsequent field sampling events, additional samples were collected on either side of ASU5 and ASU6 at depths vertically off-set from those at ASU5 and ASU6. This approach was used rather than increased vertical resolution in a single borehole because it was felt that the latter goes beyond the vertical resolution possible in a single borehole with the direct push sampling tools and methods being used. This also allowed us to retain the same sampling point and depths at ASU5 and ASU6 for the benefit of data continuity, while adding more vertical resolution and allowing us to better define the bounds of the highly conductive zone.

Using VOC vapor concentration data converted to equivalent PCE concentrations, VOC diffusion coefficient estimates, and an estimated area of impact (550m² total), source zone mass loss associated with vapor transport was calculated. Vapor flux estimates at each measurement location, and concentration adjustment factors are located in Table 17. Event specific vapor emission estimates may be found in Table 17.

Of interest from the first field event was the light, non-aqueous phase liquid (LNAPL) with a petroleum hydrocarbon odor produced while purging multi-level monitoring well ML6-9 (9 ft bgs). Analysis of the relative mass of product with respect to carbon range was evaluated using gas chromatography (direct injection technique). A table showing the relative mass of product within each carbon range and a chromatogram for the NAPL direct injection are shown in Table 18. No quantification, speciation, or further analysis was performed on the product collected. LNAPL was not observed in the second phase of field sampling, presumable because of the elevated water table.

3.0 References

- Banikowski, Jeffrey, Swiatoslav Kaczmar, and John Hunt. "Field Validation of Helium as a Tracer Gas During Soil Vapor Sample Collection." *Soil & Sediment Contamination*. 18. (2009): 243-263. Print
- Cho, Jon Soo, J.T.Wilson, F.P Beck Jr. "Measuring Vertical Profiles of Hydraulic Conductivity with In Situ Direct-Push Methods." *Journal of Environmental Engineering*. (2000): 775-777. Print
- Fetter, C.W. 2000. *Applied Hydrogeology*. 4th ed. Upper Saddle River, New Jersey: Prentice-Hall. pp.197-200. Print.
- Johnon, P.C., Cristin Bruce, Richard Johnson and Mariush Kemplowski. "In Situ Measurement of Effective Vapor-Phase Porose Media Diffusion Coefficients". *Environmental Science and Technology* 32. (1998) 2405-2409. Print
- Mass Flux Toolkit. GSI Environmental. V1.0. Toolkit located at http://www.gsi-net.com/Software/massflx_dl/main_massflx.asp
- Technology Demonstration Plan For: (ER-0431) Emulsified Zero-Valent Nano-Scale Iron Treatment of Chlorinated Solvent DNAPL Source Areas: June 15, 2006. Print.

Tables

Table 1A

Geologic Description of Parris Island Soil Core ASU9: Event 1: October 16 – 26, 2008

Depth (ft bgs)	Description
0 – 2	Very fine sand with trace silt/clay, and substantial organic matter
2 – 3	Fine sand with silt/clay, trace gravel
3 – 4	Clay with abundant fine sand
4 – 5	Fine sand with some silt/clay
5 – 6	Clayey/silty fine sand
6 – 8	Clay/silt with some fine sand
8 - 10	Clay with trace fine sand
10 – 11	Fine sand with trace silt/clay
11 – 13	Fine sand
13 – 16	Fine sand with trace silt/clay
16 - 17	Clay
17 – 18	Peat

Table 1B

Geologic Description of Parris Island Soil Core near ASU6: Event 2: Aug 15-22, 2009

Depth (ft bgs)	Description
0 – 3	Sandy loam with substantial organic matter and some gravel
3 – 5	Fine sand with silt/clay
5 – 8	Fine sand with increased silt/clay content
8 – 10	Clay with trace silt/sand
10 – 11	Fine sand with trace silt/clay
11 – 13	Fine sand with silt/clay
13 – 15	Fine sand with increased silt/clay content
15 – 16	Fine sand with substantial silt/clay
16 – 17	Clay with trace sand and substantial organic matter
17 – 18	Peat

Table 2

*Depth-to Water Measurements and Calculated Groundwater**Elevations for Permanent Monitoring Wells: Events 1, 2, 3, and 4*

Location	Depth (interval)	Elev TOC (ft amsl)	DTW (ft btoc)				Groundwater Elevation (ft amsl)			
			Event 1	Event 2	Event 3	Event 4	Event 1	Event 2	Event 3	Event 4
AMW2		Unk	--	--	4.04	3.7	--	--	Unk	Unk
MW01	SU	7.6	0.47	--	--	--	7.13	--	--	--
	SL	7.57	1.19	--	--	--	6.38	--	--	--
MW03	SU	Unk	--	2.29	4.08	4.2	--	Unk	Unk	Unk
	SL	Unk	--	--	4.08	3.7	--	--	Unk	Unk
MW05	SU	7.98	3.69	--	4.17	--	4.29	--	3.81	--
	SL	7.66	3.35	--	--	--	4.31	--	--	--
MW06	SU	6.82	2.88	2.53	4.07	3.8	3.94	4.29	2.75	3.02
	SL	6.69	1.94	2.34	4.05	3.65	4.75	4.35	2.64	3.04
MW07	SU	6.79	1.62	2.42	4.17	---	5.17	4.37	2.62	---
	SL	Unk	1.93	2.38	--	3.85	Unk	Unk	--	Unk
MW08	SU	6.7	1.58	2.22	3.94	3.25	5.12	4.48	2.76	3.45
	SL	Unk	1.60	2.13	3.90	3.65	Unk	Unk	Unk	Unk
MW10	SU	6.28	1.42	1.79	--	--	4.86	4.49	--	--
	SL	6.23	1.36	1.73	--	--	4.87	4.5	--	--
MW13	SU	6.8	2.19	2.47	--	--	4.61	4.33	--	--
	SL	6.75	2.20	2.37	--	--	4.55	4.38	--	--
MW14	SU	6.24	1.86	1.61	--	--	4.38	4.63	--	--

	SL	6.19	1.70	1.53	--	--	4.49	4.66	--	--
MW15	SU	8.61	3.94	3.85	--	--	4.67	4.76	--	--
	SL	8.47	3.72	3.6	--	--	4.75	4.87	--	--
MW16	SU	9.58	5.24	4.63	--	--	4.34	4.95	--	--
	SL	9.63	5.19	4.72	--	--	4.44	4.91	--	--
MW19	SU	6.01	--	1.8	--	--	--	4.21	--	--
	SL	6.05	--	1.58	--	--	--	4.47	--	--
MW21	SU	6.81	1.42	--	3.84	3.45	5.39	--	1.42	3.36
	SL	6.73	1.31	--	3.71	3.50	5.42	--	3.02	3.23
MW22	SU	6.9	1.40	2.02	3.88	3.525	5.50	4.88	3.02	3.375
	SL	6.89	1.24	1.92	--	3.40	5.65	4.97	--	3.49
MW23	SU	6.78	2.34	2.29	--	--	4.44	4.49	--	--
	SL	6.78	2.28	2.28	--	--	4.50	4.5	--	--
MW24	SU	7.06	1.63	2.22	4.07	3.8	5.43	4.84	2.99	3.26

Event 1: October 16-26, 2008

toc – Top of casing

Event 2: August 15-22, 2009

btoc – Below top of casing

Event 3: July 5-19, 2010

bgs – Below ground surface

Event 4: June 14-20, 2011
DTW – Depth to water

amsl – Above mean sea level

-- – Not sampled

Table 3A

Slug Test Data: Event 1: October 16 – 26, 2008

	Bouwer & Rice
Well	cm/s
MW007-SU	2.3×10^{-4}
MW007-SL	1.5×10^{-4}
MW008-SU	2.0×10^{-4}
MW008-SL	2.1×10^{-4}
MW022-SU	1.8×10^{-5}
MW022-SL	7.5×10^{-5}

Table 3B

Slug Test Data: Event 3: July 5-19, 2010

	Bouwer & Rice
Well	cm/s
MW006-SL	9.6×10^{-4}
MW007-SL	1.4×10^{-4}
MW022-SL	8.2×10^{-4}

Table 4

Hydraulic Conductivity Estimates for Aquifer Specific-Capacity Testing Events 1, 2, 3, 4^a

	Depth (ft bgs)	(cm/sec)					Depth (ft bgs)	(cm/sec)			
		Event 1	Event 2	Event 3	Event 4			Event 1	Event 2	Event 3	Event 4
A S U 1	5	4.6 x 10 ⁻⁵	X	X	X	A S U 6B	6.5	X	1.0 x 10 ⁻³	1.8 x 10 ⁻⁴	1.3 x 10 ⁻⁴
	8	7.7 x 10 ⁻⁵	X	X	X		9.5	X	9.4 x 10 ⁻⁵	6.9 x 10 ⁻⁴	1.6 x 10 ⁻³
	11	3.5 x 10 ⁻⁴	X	X	X		12.5	X	9.5 x 10 ⁻⁴	2.3 x 10 ⁻³	1.0 x 10 ⁻³
	14	3.5 x 10 ⁻⁵	X	X	X		15.5	X	1.6 x 10 ⁻⁵	2.6 x 10 ⁻⁵	2.7 x 10 ⁻⁵
	17	2.5 x 10 ⁻⁴	X	X	X						
A S U 2	5	3.7 x 10 ⁻⁵	1.8 x 10 ⁻⁴	4.0 x 10 ⁻⁵	3.4 x 10 ⁻⁴	A S U 7	5	3.3 x 10 ⁻⁵	2.3 x 10 ⁻⁴	---	9.0 x 10 ⁻⁶
	8	6.3 x 10 ⁻⁵	3.6 x 10 ⁻⁵	6.8 x 10 ⁻⁴	1.8 x 10 ⁻⁴		8	1.8 x 10 ⁻⁴	7.8 x 10 ⁻⁵	5.1 x 10 ⁻⁴	2.4 x 10 ⁻⁴
	11	---	1.8 x 10 ⁻⁴	1.1 x 10 ⁻⁴	5.5 x 10 ⁻⁵		11	1.1 x 10 ⁻³	1.3 x 10 ⁻³	4.5 x 10 ⁻⁴	1.9 x 10 ⁻³
	14	3.2 x 10 ⁻⁵	3.8 x 10 ⁻⁵	2.0 x 10 ⁻⁵	3.3 x 10 ⁻⁵		14	2.0 x 10 ⁻⁴	2.2 x 10 ⁻⁵	9.4 x 10 ⁻⁴	1.8 x 10 ⁻³
	17	2.1 x 10 ⁻⁵	2.4 x 10 ⁻⁵	3.1 x 10 ⁻⁵	2.3 x 10 ⁻⁵		17	2.0 x 10 ⁻⁵	2.3 x 10 ⁻⁴	2.6 x 10 ⁻⁵	2.0 x 10 ⁻⁵
A S U 3	5	3.0 x 10 ⁻⁵	4.6 x 10 ⁻⁵	---	2.7 x 10 ⁻⁴	A S U 7.5	6.5	X	X	X	1.8 x 10 ⁻⁴
	8	3.6 x 10 ⁻⁴	1.9 x 10 ⁻⁴	3.3 x 10 ⁻⁴	4.0 x 10 ⁻⁴		8	X	X	X	6.3 x 10 ⁻⁴
	11	1.2 x 10 ⁻⁴	3.5 x 10 ⁻³	4.7 x 10 ⁻³	4.0 x 10 ⁻³		11	X	X	X	4.2 x 10 ⁻⁴
	14	1.5 x 10 ⁻⁴	1.3 x 10 ⁻⁴	7.2 x 10 ⁻⁵	8.3 x 10 ⁻⁵		14	X	X	X	1.3 x 10 ⁻³
	17	2.2 x 10 ⁻⁵	1.6 x 10 ⁻⁵	5.9 x 10 ⁻⁶	6. x 10 ⁻⁶		17	X	X	X	2.5 x 10 ⁻⁵
A S U 4	5	7.5 x 10 ⁻⁵	1.4 x 10 ⁻⁴	---	2.5 x 10 ⁻⁵	A S U 7B	6.5	X	3.6 x 10 ⁻⁴	1.5 x 10 ⁻⁴	9.9 x 10 ⁻⁵
	8	3.6 x 10 ⁻⁴	5.7 x 10 ⁻⁴	3.9 x 10 ⁻⁴	1.7 x 10 ⁻⁴		9.5	X	2.4 x 10 ⁻⁴	3.0 x 10 ⁻⁴	6.0 x 10 ⁻⁵
	11	9.0 x 10 ⁻⁵	8.6 x 10 ⁻⁴	9.8 x 10 ⁻⁵	7.0 x 10 ⁻⁴		12.5	X	2.2 x 10 ⁻³	1.9 x 10 ⁻³	4.3 x 10 ⁻³
	14	9.4 x 10 ⁻⁵	6.5 x 10 ⁻⁵	4.2 x 10 ⁻⁵	7.1 x 10 ⁻⁴		15.5	X	2.4 x 10 ⁻⁵	2.4 x 10 ⁻⁵	2.7 x 10 ⁻⁵
	17	1.3 x 10 ⁻⁵	1.6 x 10 ⁻⁵	6.0 x 10 ⁻⁵	5.0 x 10 ⁻⁵						
A	5	---	---	---	---	A S U 8	5	7.8 x 10 ⁻⁶	1.4 x 10 ⁻⁴	---	1.4 x 10 ⁻⁵
	8	1.5 x 10 ⁻⁴	---	4.7 x 10 ⁻⁵	1.7 x 10 ⁻⁵		8	1.5 x 10 ⁻⁴	1.0 x 10 ⁻⁴	1.5 x 10 ⁻⁴	2.3 x 10 ⁻⁵
							11	2.1 x 10 ⁻⁴	9.9 x 10 ⁻⁵	8.0 x 10 ⁻⁴	1.5 x 10 ⁻⁵
							14	6.6 x 10 ⁻⁵	2.3 x 10 ⁻⁵	7.2 x 10 ⁻⁵	3.3 x 10 ⁻⁵

S	11	5.6×10^{-4}	1.1×10^{-4}	1.0×10^{-4}	4.0×10^{-4}
U	14	7.0×10^{-5}	1.1×10^{-4}	2.5×10^{-5}	1.6×10^{-5}
5	17	7.6×10^{-5}	9.7×10^{-6}	9.7×10^{-6}	6.0×10^{-5}
A	6.5	X	X	X	3.7×10^{-4}
	8	X	X	X	1.4×10^{-4}
S	11	X	X	X	5.1×10^{-4}
U 5.5	14	X	X	X	1.3×10^{-3}
	17	X	X	X	1.9×10^{-5}
A	6.5	X	---	---	6.1×10^{-5}
S	9.5	X	1.1×10^{-4}	1.9×10^{-4}	4.3×10^{-4}
U	12.5	X	2.0×10^{-3}	2.0×10^{-3}	2.0×10^{-3}
5B	15.5	X	2.9×10^{-5}	5.0×10^{-6}	2.2×10^{-5}
A	5	8.2×10^{-5}	4.8×10^{-5}	1.3×10^{-4}	---
	8	4.1×10^{-4}	1.8×10^{-4}	3.0×10^{-4}	2.2×10^{-4}
S	11	1.1×10^{-3}	3.2×10^{-4}	1.7×10^{-3}	5.8×10^{-3}
	14	8.5×10^{-5}	6.6×10^{-5}	2.8×10^{-5}	1.5×10^{-3}
U 6	17	1.6×10^{-5}	1.7×10^{-5}	1.6×10^{-5}	2.6×10^{-5}
	6.5	X	X	X	2.0×10^{-4}
A	8	X	X	X	8.0×10^{-4}
S	11	X	X	X	3.5×10^{-3}
U 6.5	14	X	X	X	3.4×10^{-4}
	17	X	X	X	2.3×10^{-5}
	17	3.5×10^{-5}	1.4×10^{-4}	2.8×10^{-5}	2.5×10^{-5}
A	5	---	X	X	X
	8	1.7×10^{-4}	X	X	X
S	11	4.1×10^{-4}	X	X	X
	14	8.2×10^{-5}	X	X	X
U 9	17	3.9×10^{-5}	X	X	X
	5	1.6×10^{-5}	X	X	X
A	8	4.9×10^{-5}	X	X	X
S	11	9.8×10^{-4}	X	X	X
	14	1.0×10^{-4}	X	X	X
U 10	17	2.5×10^{-5}	X	X	X
	5	X	5.0×10^{-5}	5.0×10^{-5}	1.3×10^{-5}
A	8	X	6.5×10^{-4}	2.9×10^{-5}	3.8×10^{-5}
S	11	X	7.5×10^{-5}	2.3×10^{-4}	2.0×10^{-5}
	14	X	4.7×10^{-4}	7.1×10^{-5}	1.5×10^{-4}
U 11	17	X	6.2×10^{-5}	3.7×10^{-5}	2.7×10^{-5}

--- – No water available for analysis

X – location not sampled

Event 1: Oct. 16-26, 2008

Event 2: August 15-22, 2009

Event 3: July 5-19, 2010

Event 4: June 14-25, 2011

(Table 4 Continues)

(Table 4 Continued)

	Depth	(cm/sec)			
	(ft bgs)	Event 1	Event 2	Event 3	Event 4
A S U 1 2	5	X	X	8.6×10^{-5}	X
	8	X	X	2.3×10^{-4}	X
	11	X	X	6.7×10^{-5}	X
	14	X	X	6.6×10^{-5}	X
	17	X	X	1.1×10^{-5}	X
A S U 1 3	5	X	X	2.9×10^{-4}	X
	8	X	X	2.2×10^{-4}	X
	11	X	X	1.6×10^{-3}	X
	14	X	X	4.9×10^{-5}	X
	17	X	X	1.5×10^{-5}	X
A S U 1 4	5	X	X	---	X
	8	X	X	2.2×10^{-4}	X
	11	X	X	9.6×10^{-5}	X
	14	X	X	3.7×10^{-5}	X
	17	X	X	2.0×10^{-5}	X
A S U 1 5	5	X	X	---	X
	8	X	X	4.3×10^{-4}	X
	11	X	X	7.8×10^{-5}	X
	14	X	X	5.9×10^{-5}	X
	17	X	X	1.4×10^{-6}	X
A S U 1 6	5	X	X	---	X
	8	X	X	5.3×10^{-5}	X
	11	X	X	4.5×10^{-5}	X
	14	X	X	2.6×10^{-4}	X
	17	X	X	2.2×10^{-5}	X

	Depth	(cm/sec)			
	(ft bgs)	Event 1	Event 2	Event 3	Event 4
A S U 1 9	5	X	X	---	X
	8	X	X	1.2×10^{-4}	X
	11	X	X	4.1×10^{-5}	X
	14	X	X	3.6×10^{-5}	X
	17	X	X	2.4×10^{-5}	X
A S U 2 0	5	X	X	---	X
	8	X	X	1.6×10^{-4}	X
	11	X	X	7.6×10^{-5}	X
	14	X	X	5.2×10^{-5}	X
	17	X	X	1.7×10^{-5}	X
A S U 2 1	5	X	X	1.8×10^{-4}	X
	8	X	X	9.3×10^{-5}	X
	11	X	X	8.6×10^{-4}	X
	14	X	X	3.5×10^{-5}	X
	17	X	X	2.3×10^{-5}	X
A S U 2 2	5	X	X	---	X
	8	X	X	2.2×10^{-4}	X
	11	X	X	81×10^{-5}	X
	14	X	X	1.4×10^{-4}	X
	17	X	X	2.5×10^{-5}	X
A S U 2 3	5	X	X	---	X
	8	X	X	1.0×10^{-3}	X
	11	X	X	2.1×10^{-4}	X
	14	X	X	4.1×10^{-5}	X
	17	X	X	4.3×10^{-5}	X

A S U 1 7	5	X	X	---	X
	8	X	X	1.3×10^{-4}	X
	11	X	X	1.3×10^{-4}	X
	14	X	X	3.4×10^{-5}	X
	17	X	X	3.1×10^{-5}	X
A S U 1 8	5	X	X	---	X
	8	X	X	1.9×10^{-4}	X
	11	X	X	1.5×10^{-4}	X
	14	X	X	4.4×10^{-5}	X
	17	X	X	2.5×10^{-5}	X

A S U 2 4	5	X	X	---	X
	8	X	X	3.6×10^{-5}	X
	11	X	X	3.2×10^{-3}	X
	14	X	X	5.6×10^{-5}	X
	17	X	X	1.9×10^{-5}	X

--- -- No water available for analysis

X – location not sampled

Event 1: Oct. 16-26, 2008

Event 2: August 15-22, 2009

Event 3: July 5-19, 2010

Event 4: June 14-25, 2011

Moye Method: (Cho et al. 2000)

$$K = \frac{1}{b} \times \frac{Q}{2\pi(H)} \times \left(1 + \ln\left(\frac{b}{2r_w}\right) \right)$$

Where Q = pumping rate (L³/T)

H = Drawdown (ft)

K = hydraulic conductivity (L/T)

b = length of sampler or screen section (L)

r_w = radius of well

Table 5A

Water Quality Data for Depth-Discrete, DPT Samples: Event 1: October 16 – 26, 2008

	Depth (ft bgs)	pH	EC (μ S)	T (deg C)	DO (mg/L)	ORP (mV)
A S U 1	5	5	---	---	---	---
	8	8	5.8	320	25.5	1.2
	11	11	6.0	340	26.5	<1
	14	14	6.5	720	25.4	---
	17	17	6.8	1100	25.4	<1
A S U 2	5	5	---	---	---	---
	8	8	6.1	350	27.5	Unk
	11	11	6.2	390	27.3	1.2
	14	14	---	---	---	---
	17	17	---	---	---	---
A S U 3	5	5	---	---	---	---
	8	8	5.4	540	24.9	<1
	11	11	6.2	320	26.0	<1
	14	14	6.0	1200	26.2	1.7
	17	17	---	---	---	---
A S U 4	5	5	---	---	---	---
	8	8	5.4	520	25.1	<1
	11	11	6.1	430	24.8	<1
	14	14	6.3	710	25.4	<1
	17	17	---	---	---	---
A S	5	5	---	---	---	---
A S U 6	5	---	---	---	---	---
	8	6.1	570	22.2	<1	-36
	11	5.8	410	22.5	<1	3.4
	14	6.0	480	21.2	<1	22
	17	---	---	---	---	---
A S U 7	5	---	---	---	---	---
	8	6.3	560	24.2	<1	-48
	11	5.8	390	24.4	<1	-3.5
	14	5.9	610	23.8	<1	19
	17	---	---	---	---	---
A S U 8	5	---	---	---	---	---
	8	5.5	570	22.5	<1	78
	11	5.7	550	23.5	<1	-17
	14	5.9	1800	23.2	<1	38
	17	6.0	6200	21.7	1.2	21
A S U 9	5	---	---	---	---	---
	8	---	---	---	---	---
	11	6.0	370	24.7	<1	-0.7
	14	6.0	740	24.5	<1	-29
	17	6.1	690	24.2	<1	15
A S	5	---	---	---	---	---

U 5	8	8	6.1	700	25.5	<1
	11	11	6.3	440	25.9	<1
	14	14	6.2	550	25.6	<1
	17	17	---	---	---	---

U 1 0	8	6.3	1500	21.8	<1	-100
	11	5.6	450	22.4	<1	-41
	14	5.7	780	21.2	<1	24
	17	---	---	---	---	---

--- Not enough water available for analysis

<1- Dissolved oxygen values <1 mg/L are simply shown as <1

Table 5B

Water Quality Data for Depth-Discrete, DPT Samples: Event 2 Aug 15-22, 2009

	Depth (ft bgs)	pH	EC (μ S)	T (deg C)	DO (mg/L)	ORP (mV)		Depth (ft bgs)	pH	EC (μ S)	T (deg C)	DO (mg/L)	ORP (mV)
A S U 2	5	---	---	---	---	---	A S U 6B	6.5	6.1	1100	27.6	<1	-44
	8	---	---	---	---	---		9.5	---	---	---	---	---
	11	6.1	360	29.0	<1	0.5		12.5	6.1	410	24.9	<1	31
	14	6.4	600	29.3	Unk	-38		15.5	---	---	---	---	---
	17	6.6	900	29.3	Unk	-66		A S U 7	5	---	---	---	---
A S U 3	5	---	---	---	---	---	8		6.1	550	28.9	<1	5.1
	8	5.9	500	27.3	<1	-58	11		5.8	360	29.1	<1	30
	11	5.9	320	26.3	<1	-2.2	14		5.9	560	29.1	<1	34
	14	5.5	480	26.1	<1	-29	17		---	---	---	---	---
	17	---	---	---	---	---	A S U 7B	6.5	6.1	730	28.0	<1	-46
A S U 4	5	---	---	---	---	---		9.5	5.7	340	27.2	1.31	92
	8	5.2	470	27.4	1.8	84		12.5	5.8	540	26.9	<1	21
	11	5.5	370	26.4	<1	-57		15.5	---	---	---	---	---
	14	5.7	620	26.7	<1	-44		A S U 8	5	---	---	---	---
	17	---	---	---	---	---	8		5.8	600	29.4	Unk	73
A S U 5	5	---	---	---	---	---	11		5.6	500	26.6	<1	44
	8	5.9	780	26.8	<1	-1.5	14		6.1	1900	25.3	<1	42
	11	6.0	460	26.8	<1	-12	17		6.1	5900	26.5	Unk	23
	14	6.1	510	26.0	<1	49	A S U	5	---	---	---	---	---
	17	---	---	---	---	---		8	6.3	780	26.2	<1	-33
A	6.5	---	---	---	---	---		11	6.1	610	26.3	<1	11
	9.5	5.9	510	25.9	<1	9.3		14	6.0	820	25.3	<1	-7.0

S	12.5	6.0	470	26.6	<1	21
U	15.5	6.2	690	26.9	<1	17
5B						
A	5	---	---	---	---	---
S	8	6.5	620	27.2	<1	-50
U	11	6.4	460	26.0	<1	-18
6	14	6.7	470	24.1	<1	4.3
	17	---	---	---	---	---

11	17	5.9	2000	24.6	<1	33
----	----	-----	------	------	----	----

--- Not enough water available for analysis

<1- Dissolved oxygen values <1 mg/L are simply shown as <1

Unk – not enough water for accurate reading

Table 5C

Water Quality Data for Depth-Discrete, DPT Samples: Event 3: July 5-19, 2010

	Depth (ft bgs)	pH	EC (μ S)	T (deg C)	DO (mg/L)	ORP (mV)
A S U 2	5	---	---	---	---	---
	8	6.4	320	28.1	<1	130
	11	6.2	290	26.8	<1	40
	14	6.3	580	26.9	Unk	40
	17	---	---	---	---	---
A S U 3	5	---	---	---	---	---
	8	5.9	430	28.2	<1	55
	11	6.0	320	28.6	<1	21
	14	5.7	500	26.1	<1	19
	17	---	---	---	---	---
A S U 4	5	---	---	---	---	---
	8	5.3	530	26.8	<1	87
	11	5.9	440	27.8	Unk	-0.2
	14	---	---	---	---	---
	17	5.8	510	26.4	<1	48
A S U 5	5	---	---	---	---	---
	8	---	---	---	---	---
	11	6.0	570	24.5	<1	22
	14	---	---	---	---	---
	17	---	---	---	---	---
A S	6.5	---	---	---	---	---
	9.5	5.8	490	25.1	1.3	340
A S U 7B	6.5	---	---	---	---	---
	9.5	5.5	330	25.3	Unk	110
	12.5	5.8	410	23.7	Unk	29
	15.5	---	---	---	---	---
A S U 8	5	---	---	---	---	---
	8	---	---	---	---	---
	11	5.1	520	25.7	Unk	12
	14	6.1	1600	25.0	Unk	52
	17	5.9	5800	32.0	Unk	38
A S U 11	5	---	---	---	---	---
	8	---	---	---	---	---
	11	6.0	6000	25.6	Unk	11
	14	5.9	990	25.6	Unk	42
	17	6.2	1000	30.8	Unk	-4
A S U 12	5	---	---	---	---	---
	8	5.7	330	26.5	<1	40
	11	6.0	320	25.9	<1	-3
	14	6.0	510	25.4	<1	52
	17	---	---	---	---	---
A S U	5	---	---	---	---	---
	8	5.8	480	25.0	Unk	30
	11	5.8	390	25.2	<1	-1.5

U	12.5	5.9	430	24.1	<1	55
5B	15.5	---	---	---	---	---
A	5	---	---	---	---	---
S	8	6.1	570	25.4	Unk	-17
U	11	5.7	390	24.3	<1	74
6	14	10.8	730	27.1	Unk	-24
	17	---	---	---	---	---
A	6.5	---	---	---	---	---
S	9.5	7.1	500	26.0	<1	-140
U	12.5	6.0	440	25.9	<1	-8.3
6B	15.5	---	---	---	---	---
A	5	---	---	---	---	---
S	8	5.8	480	25.6	Unk	37
U	11	5.6	330	24.1	Unk	65
7	14	5.0	490	23.6	Unk	54
	17	5.8	1900	26.7	Unk	56

--- Not enough water available for analysis

<1- Dissolved oxygen values <1 mg/L

13	14	5.8	470	25.1	<1	53
	17	---	---	---	---	---
A	5	---	---	---	---	---
S	8	6.2	1600	26.6	<1	-50
U	11	6.0	580	26.0	<1	-15
14	14	---	---	---	---	---
	17	---	---	---	---	---
A	5	---	---	---	---	---
S	8	5.8	470	25.1	<1	140
U	11	5.7	360	24.9	1.09	30
15	14	---	---	---	---	---
	17	6.0	660	25.5	<1	60
A	5	---	---	---	---	---
S	8	---	---	---	---	---
U	11	5.8	330	28.5	Unk	10
16	14	5.9	520	25.0	<1	50
	17	---	---	---	---	---

(Table 5C Continues)

(Table 5C Continued)

	Depth (ft bgs)	pH	EC (μ S)	T (deg C)	DO (mg/L)	ORP (mV)
A S U 1 7	5	---	---	---	---	---
	8	5.9	530	29.0	Unk	Unk
	11	5.8	440	27.7	<1	26
	14	---	---	---	---	---
	17	6.0	3300	27.0	<1	40
A S U 1 8	5	---	---	---	---	---
	8	6.5	660	32.4	Unk	-5.9
	11	5.6	550	24.5	Unk	35
	14	---	---	---	---	---
	17	---	---	---	---	---
A S U 1 9	5	---	---	---	---	---
	8	5.9	570	28.9	Unk	50
	11	---	---	---	---	---
	14	---	---	---	---	---
	17	6.0	710	26.4	Unk	Unk
A S U 2 0	5	---	---	---	---	---
	8	6.2	770	28.5	<1	-37
	11	6.1	460	27.5	Unk	-4.8
	14	6.0	460	29.8	<1	30
	17	---	---	---	---	---
A S U 2 1	5	---	---	---	---	---
	8	---	---	---	---	---
	11	5.9	780	26.6	<1	15
	14	5.7	700	25.9	Unk	52
	17	---	---	---	---	---
A S U 2 2	5.0	---	---	---	---	---
	8.0	5.9	590	26.4	<1	19
	11.0	5.1	340	26.2	<1	25
	14.0	5.9	440	25.4	<1	53
	17.0	---	---	---	---	---
A S U 2 3	5.0	---	---	---	---	---
	8.0	5.1	370	27	<1	98
	11.0	5.7	390	26.7	1.23	33
	14.0	---	---	---	---	---
	17.0	6	1500	30.3	<1	23
A S U 2 4	5.0	---	---	---	---	---
	8.0	---	---	---	---	---
	11.0	5.6	550	24.0	Unk	26
	14.0	6.1	730	25.3	Unk	35
	17.0	6.5	1100	32.3	Unk	-26

--- Not enough water available for analysis

<1- Dissolved oxygen values <1 mg/L are simply shown as <1

Table 5D

Water Quality Data for Depth-Discrete, DPT Samples: Event 4: June 14-25, 2010

	Depth (ft bgs)	pH	EC (μ S)	T (deg C)	DO (mg/L)	ORP (mV)		Depth (ft bgs)	pH	EC (μ S)	T (deg C)	DO (mg/L)	ORP (mV)
A S U 2	6.5	---	---	---	---	---	A S U 6.5	6.5	---	---	---	---	---
	8	---	---	---	---	---		8	6.2	1200	26.4	<1	-51.7
	11	---	---	---	---	---		11	5.5	490	23.5	<1	30.2
	14	---	---	---	---	---		14	5.4	600	24.5	<1	37.3
	17	---	---	---	---	---		17	---	---	---	---	---
A S U 3	6.5	---	---	---	---	---	A	6.5	---	---	---	---	---
	8	5.6	360	26.5	<1	29.4	S	9.5	5.1	240	23.2	0	120
	11	5.6	250	24.3	<1	25.3	U	12.5	5.6	320	23.2	0	29
	14	5.6	730	24.8	Unk	3.67	6B	15.5	---	---	---	---	---
	17	---	---	---	---	---	A	6.5	---	---	---	---	---
A S U 4	6.5	---	---	---	---	---	S	8	---	---	---	---	---
	8	---	---	---	---	---	U	11	5.4	270	22.7	<1	27.2
	11	5.6	300	23.1	<1	14.9	7	14	5.6	370	21.4	<1	2.3
	14	---	---	---	---	---	17	---	---	---	---	---	---
	17	---	---	---	---	---	A	6.5	---	---	---	---	---
A S U 5	6.5	---	---	---	---	---	S	8	---	---	---	---	---
	8	---	---	---	---	---	U	11	5.56	340	22.8	<1	58.3
	11	6.1	46	23.9	<1	-39.1	7.5	14	5.66	610	21.3	<1	35.3
	14	---	---	---	---	---	17	---	---	---	---	---	---
	17	---	---	---	---	---	A	6.5	---	---	---	---	---
A	6.5	---	---	---	---	S	9.5	---	---	---	---	---	

S	8	---	---	---	---	---
	U	11	5.5	260	24.8	<1
5.5	14	5.6	330	24.7	<1	30.2
	17	---	---	---	---	---
A	6.5	---	---	---	---	---
S	9.5	6.0	430	12.6	<1	-21.7
U	12.5	6.1	380	3.0	<1	-36.7
5B	15.5	---	---	---	---	---
A S U 6	6.5	---	---	---	---	---
	8	---	---	---	---	---
	11	5.5	280	23.2	<1	44.4
	14	---	---	---	---	---
	17	---	---	---	---	---

U 7B	12.5	5.5	290	22.5	<1	28
	15.5	---	---	---	---	---
A	6.5	---	---	---	---	---
	8	---	---	---	---	---
S U 8	11	---	---	---	---	---
	14	---	---	---	---	---
	17	---	---	---	---	---
A S U 11	6.5	---	---	---	---	---
	8	---	---	---	---	---
	11	5.7	420	25.1	<1	13.4
	14	5.6	580	24.8	<1	25.5
	17	---	---	---	---	---

--- Not enough water available for analysis

<1- Dissolved oxygen values <1 mg/L are simply shown as <1

Unk – not enough water for accurate reading

Table 6A

Ion Concentration Data for Depth-Discrete, DPT Samples: Event 1: Oct. 16 – 26, 2008

Location	Depth (ft bgs)	(mg/L)				
		Cl ⁻	NO ₃ ⁻²	SO ₄ ⁻²	Fe ²⁺	Mn ²⁺
ASU1	5	---	---	---	---	---
	8	11	ND	38	5	ND
	11	15	ND	26	4	ND
	14	110	ND	23	4	ND
	17	200	ND	ND	7	ND
ASU2	5	---	---	---	13	ND
	8	16	ND	38	3	ND
	11	25	1	20	3	ND
	14	74	ND	22	5	ND
	17	130	ND	1	7	ND
ASU3	5	---	---	---	60	ND
	8	79	ND	65	7	ND
	11	13	ND	28	5	ND
	14	130	ND	450	82	1
	17	250	1	180	32	1
ASU4	5	---	---	---	---	---
	8	39	ND	150	24	ND
	11	23	ND	51	13	ND
	14	72	ND	130	13	ND
	17	150	ND	9	2	ND
ASU6	5	140	2	5	74	ND
	8	77	1	17	29	ND
	11	42	ND	23	6	ND
	14	56	2	31	4	ND
	17	130	ND	5	3	ND
	---	---	---	---	---	---
ASU7	5	---	---	---	---	---
	8	29	ND	41	10	ND
	11	25	ND	33	7	ND
	14	84	1	37	5	ND
	17	610	ND	19	10	ND
ASU8	5	---	---	---	---	---
	8	61	1	90	2	ND
	11	57	ND	84	11	ND
	14	430	ND	83	2	ND
	17	2200	ND	15	14	ND
ASU9	5	---	---	---	---	---
	8	220	2	5	77	ND
	11	19	ND	36	4	ND
	14	72	ND	10	42	14
	17	120	1	ND	4	ND

ASU5	5	---	---	---	---	---
	8	110	1	29	20	ND
	11	31	ND	14	4	ND
	14	80	ND	22	3	ND
	17	80	ND	21	3	ND

ASU10	5	---	---	---	---	---
	8	310	1	1	110	ND
	11	56	ND	ND	6	ND
	14	170	ND	11	9	ND
	17	130	ND	20	4	ND

--- – No water available for analysis

ND – Non-detect; less than detection limit of 1 mg/L

Table 6B

Ion Concentration Data for Depth-Discrete, DPT Samples: Event 2: Aug 15-22, 2009

Location	Depth (ft bgs)	(mg/L)				
		Cl ⁻	NO ₃ ⁻²	SO ₄ ⁻²	Fe ²⁺	Mn ²⁺
ASU2	5	25	ND	96	2	ND
	8	---	---	---	---	---
	11	28	ND	35	3	ND
	14	90	ND	28	4	ND
	17	180	ND	1	6	ND
ASU3	5	---	---	---	---	---
	8	45	ND	69	26	ND
	11	28	ND	62	5	ND
	14	62	ND	100	30	ND
	17	---	---	---	---	---
ASU4	5	---	---	---	---	---
	8	52	5	170	---	---
	11	39	ND	93	14	ND
	14	---	---	---	---	---
	17	55	1	140	8	ND
ASU5	5	150	1	29	3	ND
	8	---	---	---	---	---
	11	140	1	25	34	ND
	14	40	ND	42	8	ND
	17	94	ND	35	---	---
ASU6 B	6.5	210	ND	26	93	ND
	9.5	---	---	---	---	---
	12.5	40	ND	53	5	ND
	15.5	---	---	---	---	---
ASU7	5	---	---	---	---	---
	8	34	1	98	19	ND
	11	31	1	50	9	ND
	14	100	ND	57	6	ND
	17	530	ND	16	9	ND
ASU7 B	6.5	32	ND	170	45	ND
	9.5	35	ND	53	2	ND
	12.5	61	ND	50	8	ND
	15.5	470	1	39	10	ND
ASU8	5	---	---	---	---	---
	8	62	ND	96	2	ND
	11	57	1	99	7	ND
	14	490	ND	100	---	---
ASU11	17	2200	1	33	13	ND
	5	---	---	---	---	---
ASU11	8	47	ND	15	47	ND

ASU5	6.5	---	---	---	---	---
	9.5	---	---	---	---	---
B	12.5	100	1	30	14	ND
	15.5	49	1	51	5	ND
ASU6	5	130	1	3	8	ND
	8	---	---	---	---	---
	11	110	ND	19	12	ND
	14	56	ND	45	6	ND
	17	76	1	21	1	ND

	11	62	ND	130	13	ND
	14	170	ND	130	6	ND
	17	600	11	70	---	---

--- – No water available for analysis

ND – Non-detect; less than detection limit of 1 mg/L

Table 6C

Ion Concentration Data for Depth-Discrete, DPT Samples: Event 3: July 5-19, 2010

	Depth	(mg/L)				
	(ft bgs)	Cl ⁻	NO ₃ ⁻²	SO ₄ ⁻²	Fe ²⁺	Mn ²⁺
A S U 2	5	---	---	---	---	---
	8	16	ND	45	2	ND
	11	21	1	25	1	ND
	14	60	ND	15	ND	ND
	17	---	---	---	5	ND
A S U 3	5	---	---	---	---	---
	8	31	ND	57	5	ND
	11	31	ND	24	4	ND
	14	59	ND	79	17	ND
	17	---	---	---	---	---
A S U 4	5	---	---	---	---	---
	8	57	ND	100	22	ND
	11	33	ND	45	19	ND
	14	73	ND	67	---	---
	17	---	---	---	4	ND
A S U 5	5	---	---	---	---	---
	8	180	ND	60	---	---
	11	50	ND	10	ND	ND
	14	---	---	---	---	---
	17	---	---	---	---	---
A S U 7	5	---	---	---	---	---
	8	1	1	1	14	ND
	11	21	ND	32	4	ND
	14	53	ND	30	4	ND
	17	48	ND	160	8	ND
A S U 7 B	6.5	---	---	---	---	---
	9.5	27	ND	38	2	ND
	12.5	42	ND	20	9	ND
	15.5	180	ND	20	5	ND
A S U 8	5	---	---	---	---	---
	8	41	ND	66	1	ND
	11	38	ND	45	5	ND
	14	---	---	---	1	ND
	17	---	---	---	12	ND
A S U 1 1	5	---	---	---	---	---
	8	---	---	---	---	---
	11	38	ND	82	14	ND
	14	190	ND	82	3	ND
	17	550	ND	21	4	ND
A	5	---	---	---	---	---

A	6.5	---	---	---	---	---
S	9.5	ND	ND	ND	13	ND
U	12.5	62	ND	15	3	ND
5B	15.5	---	---	---	---	---
A	5	61	ND	16	---	---
S	8	42	ND	41	22	ND
U	11	110	ND	15	5	ND
6	14	---	---	---	---	---
	17	220	ND	5	---	---
A	6.5	62	ND	26	50	ND
S	9.5	33	ND	32	7	ND
U	12.5	90	ND	6	1	ND
6B	15.5	---	---	---	5	ND

--- – No water available for analysis

ND – Non-detect; less than detection limit of 1 mg/L

S	8	35	ND	43	7	ND
U	11	21	ND	34	---	ND
1	14	59	ND	33	3	ND
2	17	---	---	---	---	---
A	5	44	1	64	64	ND
S	8	43	ND	71	17	ND
U	11	34	ND	36	10	ND
1	14	60	ND	25	3	ND
3	17	---	---	---	---	---
A	5	---	---	---	---	---
S	8	250	1	3	---	---
U	11	78	ND	4	18	ND
1	14	---	---	---	---	---
4	17	---	---	---	---	---

(Table 6C Continues)

(Table 6C Continued)

Location	Depth (ft bgs)	(mg/L)				
		Cl ⁻	NO ₃ ⁻²	SO ₄ ⁻²	Fe ²⁺	Mn ²⁺
ASU15	5	---	---	---	---	---
	8	64	ND	27	33	ND
	11	130	ND	7	6	ND
	14	130	ND	21	3	ND
	17	16	1	32	4	ND
ASU16	5	---	---	---	---	---
	8	190	ND	ND	18	ND
	11	47	ND	53	11	ND
	14	---	---	---	---	---
	17	38	ND	43	7	ND
ASU17	5	---	---	---	---	---
	8	280	ND	73	1	ND
	11	1100	6	15	9	ND
	14	38	ND	70	2	ND
	17	51	ND	98	6	ND
ASU18	5	---	---	---	---	---

Location	Depth (ft bgs)	(mg/L)				
		Cl ⁻	NO ₃ ⁻	SO ₄ ⁻	Fe ²⁺	Mn ²⁺
ASU 20	5	---	---	---	---	---
	8	52	ND	1	87	ND
	11	---	---	---	13	ND
	14	48	ND	25	3	ND
	17	---	---	---	---	---
ASU 21	5	---	---	---	---	---
	8	32	ND	52	---	---
	11	84	ND	1	24	ND
	14	150	1	5	6	ND
	17	---	---	---	3	ND
ASU 22	5	---	---	---	---	---
	8	49	ND	40	29	ND
	11	18	ND	33	9	ND
	14	---	---	---	3	ND
	17	63	ND	23	3	ND
ASU2	5	---	---	---	---	---

	8	---	---	---	4	N D
	11	---	---	---	12	N D
	14	65	ND	49	8	N D
	17	19	ND	40	9	N D
ASU19	5	---	---	---	---	---
	8	16	ND	30	17	N D
	11	93	ND	31	16	N D
	14	64	ND	27	9	N D
	17	130	ND	7	2	N D
3	8	45	ND	62	2	ND
	11	32	ND	39	10	ND
	14	99	ND	40	4	ND
	17	44 0	3	1	---	---
ASU2 4	5	---	---	---	---	---
	8	---	---	---	---	---
	11	13 0	ND	21	7	ND
	14	10 0	ND	53	5	ND
	17	27 0	ND	9	4	ND

--- – No water available for analysis

ND – Non-detect; less than detection limit of 1 mg/L

Table 6D

Ion Concentration Data for Depth-Discrete, DPT Samples: Event 4: June 14-25, 2011

	Depth (ft bgs)	(mg/L)				
		Cl ⁻	NO ₃ ⁻²	SO ₄ ⁻²	Fe ²⁺	Mn ²⁺
A S U 2	6.5	14	ND	55	1	ND
	8	110	ND	38	2	ND
	11	---	---	---	---	---
	14	14	ND	55	4	ND
	17	110	ND	38	6	ND
A S U 3	6.5	14	ND	55	14	ND
	8	---	---	---	---	---
	11	110	ND	38	7	ND
	14	13	ND	ND	60	ND
	17	---	---	---	---	---
A S U 4	6.5	60	ND	120	23	ND
	8	---	---	---	---	---
	11	22	ND	39	17	ND
	14	---	ND	---	4	ND
	17	18	2	13	---	---
A S U 5	6.5	---	---	---	---	---
	8	---	---	---	---	---
	11	42	1	25	11	ND
	14	---	---	---	---	---
	17	25	ND	ND	2	ND

	Depth (ft bgs)	(mg/L)				
		Cl ⁻	NO ₃ ⁻²	SO ₄ ⁻²	Fe ²⁺	Mn ²⁺
A S U 6.5	6.5	28	ND	59	10	ND
	8	---	---	---	---	---
	11	14	ND	24	9	ND
	14	32	ND	30	7	ND
	17	---	---	---	---	---
A S U 6 B	6.5	49	ND	35	42	ND
	9.5	39	ND	28	4	ND
	12.5	28	ND	42	6	ND
	15.5	---	---	---	---	---
	6.5	---	---	---	---	---
A S U 7	6.5	---	---	---	---	---
	8	16	ND	40	36	ND
	11	15	ND	27	10	ND
	14	41	ND	29	6	ND
	17	2700	ND	50	---	---
A S U 7.5	6.5	---	---	---	60	ND
	8	---	---	---	31	ND
	11	---	---	---	---	---
	14	100	ND	38	8	ND
	17	820	<1	39	ND	ND
A	6.5	---	---	---	---	---

A S	6.5	49	<1	15	---	---
	9.5	26	ND	18	15	ND
U 5B	12.5	43	ND	60	6	ND
	15.5	49	<1	15	3	ND
A S U 5.5	6.5	570	<1	46	47	ND
	8	---	---	---	---	---
	11	100	ND	1	22	ND
	14	---	---	---	---	---
	17	130	ND	3	4	ND
A S U 6	6.5	---	---	---	---	---
	8	---	---	---	---	---
	11	18	ND	27	7	ND
	14	110	ND	38	5	ND
	17	38	ND	ND	5	ND

S U 7 B	9.5	20	ND	30	5	ND
	12.5	---	---	---	---	---
A S U 8	15.5	---	---	---	---	---
	6.5	---	---	---	---	---
A S U 8	8	---	---	---	---	---
	11	61	ND	65	ND	ND
	14	250	<1	20	2	ND
	17	100	ND	1	14	ND
	6.5	---	---	---	---	---
A S U 11	8	---	---	---	---	---
	11	29	ND	53	12	ND
	14	100	ND	63	ND	ND
	17	---	---	---	---	---
	6.5	---	---	---	---	---

--- -- No water available for analysis

ND -- Non-detect; less than detection limit of 1 mg/L

Table 7

DOC Concentration Data for Depth-Discrete, DPT Samples Event 1, 2, 3, and 4^a

	Depth (ft bgs)	(mg/L)			
		Event 1	Event 2	Event 3	Event 4
A S U 1	5	---	X	X	X
	8	23	X	X	X
	11	14	X	X	X
	14	5	X	X	X
	17	---	X	X	X
A S U 2	5	18	---	---	9
	8	11	11	10	12
	11	6	8	9	36
	14	5	9	4	30
	17	5	40	6	---
A S U 3	5	32	---	---	24
	8	11	31	---	4
	11	5	7	120	11
	14	4	6	11	11
	17	6	---	---	---
A S U 4	5	---	---	---	5
	8	14	14	---	28
	11	6	10	---	24
	14	6	6	13	---
	17	11	9	5	---
A S	5	---	27	---	---
	Depth (ft bgs)	(mg/L)			
		Event 1	Event 2	Event 3	Event 4
A S U 6B	6.5	X	42	48	20
	9.5	X	---	20	8
	12.5	X	16	15	25
	15.5	X	---	10	---
A S U 7	5	---	---	---	---
	8	33	34	24	36
	11	27	26	---	33
	14	19	20	24	38
	17	6	9	12	---
A S U 7.5	6.5	X	X	X	31
	8	X	X	X	13
	11	X	X	X	22
	14	X	X	X	14
	17	X	X	X	10
A S U 7B	6.5	X	24	---	---
	9.5	X	33	50	16
	12.5	X	21	---	6
	15.5	X	9	15	---
A S U 8	5	---	---	---	---
	8	43	100	30	---
	11	17	77	26	---

U 5	8	31	11	21	---
	11	17	---	28	27
	14	6	---	9	---
	17	---	---	---	2
A S U 5.5	6.5	X	X	X	43
	8	X	X	X	23
	11	X	X	X	12
	14	X	X	X	---
	17	X	X	X	37
A S U 5B	6.5	X	---	---	26
	9.5	X	39	---	52
	12.5	X	10	13	18
	15.5	X	8	9	1
A S U 6	5	50	---	---	---
	8	43	40	---	---
	11	25	20	8	42
	14	13	13	3	32
	17	7	---	5	39
A S U 6.5	6.5	X	X	X	39
	8	X	X	X	21
	11	X	X	X	20
	14	X	X	X	---
	17	X	X	X	---

	14	21	51	16	41
	17	11	40	43	19
A S U 9	5	---	X	X	X
	8	45	X	X	X
	11	---	X	X	X
	14	150	X	X	X
A S U 10	17	51	X	X	X
	5	---	X	X	X
	8	110	X	X	X
	11	14	X	X	X
A S U 11	14	71	X	X	X
	17	7	X	X	X
	5	X	---	---	---
A S U 11	8	X	44	---	---
	11	X	22	18	17
	14	X	20	21	44
	17	X	13	<1	---

--- -- No water available for analysis

X -- location not sampled

Event 1: Oct. 16-26, 2008

Event 2: August 15-22, 2009

Event 3: July 5-19, 2010

Event 4: June 14-25, 2011

(Table 7 Continued)

(Table 7 Continued)

	Depth (ft bgs)	(mg/L)			
		Event 1	Event 2	Event 3	Event 4
A S U 1 2	5	X	X	---	X
	8	X	X	60	X
	11	X	X	10	X
	14	X	X	9	X
	17	X	X	---	X
A S U 1 3	5	X	X	35	X
	8	X	X	24	X
	11	X	X	10	X
	14	X	X	4	X
	17	X	X	---	X
A S U 1 4	5	X	X	---	X
	8	X	X	59	X
	11	X	X	25	X
	14	X	X	---	X
	17	X	X	---	X
A S 1 5	5	X	X	---	X
	8	X	X	27	X
	11	X	X	12	X
	14	X	X	11	X
	17	X	X	<1	X
A S U 1 6	5	X	X	---	X
	8	X	X	47	X
	11	X	X	29	X
	14	X	X	---	X
	17	X	X	---	X
A S 1 7	5	X	X	---	X
	8	X	X	27	X
	11	X	X	18	X
	14	X	X	---	X
	17	X	X	<1	X
A S	5	X	X	---	X
A S U 1 9	5	X	X	---	X
	8	X	X	13	X
	11	X	X	9	X
	14	X	X	---	X
	17	X	X	15	X
A S U 2 0	5	X	X	---	X
	8	X	X	62	X
	11	X	X	58	X
	14	X	X	10	X
	17	X	X	---	X
A S U 2 1	5	X	X	---	X
	8	X	X	230	X
	11	X	X	115	X
	14	X	X	---	X
	17	X	X	10	X
A S U 2 2	5	X	X	---	X
	8	X	X	28	X
	11	X	X	14	X
	14	X	X	9	X
	17	X	X	8	X
A S U 2 3	5	X	X	---	X
	8	X	X	6	X
	11	X	X	<1	X
	14	X	X	17	X
	17	X	X	<1	X
A S U 2 4	5	X	X	---	X
	8	X	X	---	X
	11	X	X	---	X
	14	X	X	25	X
	17	X	X	<1	X

--- -- No water available for analysis

U 1 8	8	X	X	<1	X
	11	X	X	16	X
	14	X	X	7	X
	17	X	X	3	X

X – location not sampled

Event 1: Oct. 16-26, 2008

Event 2: August 15-22, 2009

Event 3: July 5-19, 2010

Event 4: June 14-25, 2011

Table 8

COD Concentration Data for Depth-Discrete, DPT Samples: Event 1, 2, 3, and 4^a

	Depth (ft bgs)	(mg/L)			
		Event 1	Event 2	Event 3	Event 4
A S U 1	5	---	X	X	X
	8	58	X	X	X
	11	77	X	X	X
	14	32	X	X	X
	17	18	X	X	X
A S U 2	5	---	---	---	170
	8	490	---	33	58
	11	3	3	15	44
	14	25	26	12	150
	17	15	17	7	120
A S U 3	5	---	---	---	160
	8	39	34	31	53
	11	11	14	6	140
	14	41	52	14	120
	17	29	38	72	---
A S U 4	5	---	---	---	32
	8	44	35	ND	84
	11	35	41	21	77
	14	29	30	31	67
	17	42	47	5	---
A S U 5	5	---	---	---	---
	8	120	150	97	---
	11	44	42	29	88
	14	23	25	---	---
	17	---	---	41	149
A S U 5.5	6.5	X	X	X	160
	8	X	X	X	150
	11	X	X	X	300
	14	X	X	X	330
	17	X	X	X	59
A S U 6B	6.5	X	140	120	250
	9.5	X	---	76	210
	12.5	X	74	42	110
	15.5	X	---	4	---
	A S U 7	5	---	---	---
8		120	130	160	260
11		75	99	59	93
14		42	28	32	150
17		84	99	48	65
A S U 7.5	6.5	X	X	X	32
	8	X	X	X	740
	11	X	X	X	180
	14	X	X	X	220
	17	X	X	X	130
A S U 8	6.5	X	64	37	---
	9.5	X	120	46	140
	12.5	X	69	53	58
	15.5	X	61	12	---
A S U 9	5	---	---	---	---
	8	120	130	80	---
	11	67	86	60	---
	14	53	48	40	69
A S U 9	5	---	X	X	X
	8	510	X	X	X
	11	---	X	X	X
	14	650	X	X	X
	17	241	X	X	X
A S	5	---	X	X	X
	8	460	X	X	X

A S U 5B	6.5	X	---	---	---
	9.5	X	89	110	560
	12.5	X	33	28	190
	15.5	X	29	17	140
A S U 6	5	200	290	180	---
	8	110	130	110	120
	11	79	89	40	100
	14	71	58	56	140
	17	140	190	---	1100
A S U 6.5	6.5	X	X	X	120
	8	X	X	X	62
	11	X	X	X	72
	14	X	X	X	210
	17	X	X	X	---

U 10	11	230	X	X	X
	14	260	X	X	X
	17	43	X	X	X
A S U 11	5	X	---	---	---
	8	X	74	---	---
	11	X	14	7	150
	14	X	37	ND	90
	17	X	29	25	---

--- -- No water available for analysis

X -- location not sampled

Event 1: Oct. 16-26, 2008

Event 2: August 15-22, 2009

Event 3: July 5-19, 2010

Event 4: June 14-25, 2011

(Table 8 Continues)

(Table 8 Continued)

	Depth (ft bgs)	(mg/L)					Depth (ft bgs)	(mg/L)			
		Event 1	Event 2	Event 3	Event 4			Event 1	Event 2	Event 3	Event 4
A S U 1 2	5	X	X	---	X	A S U 1 9	5	X	X	---	X
	8	X	X	ND	X		8	X	X	50	X
	11	X	X	21	X		11	X	X	11	X
	14	X	X	31	X		14	X	X	170	X
	17	X	X	---	X		17	X	X	---	X
A S U 1 3	5	X	X	90	X	A S U 2 0	5	X	X	---	X
	8	X	X	66	X		8	X	X	45	X
	11	X	X	44	X		11	X	X	---	X
	14	X	X	25	X		14	X	X	32	X
	17	X	X	36	X		17	X	X	---	X
A S U 1 4	5	X	X	---	X	A S U 2 1	5	X	X	630	X
	8	X	X	280	X		8	X	X	450	X
	11	X	X	160	X		11	X	X	150	X
	14	X	X	35	X		14	X	X	30	X
	17	X	X	24	X		17	X	X	---	X
A S 1 5	5	X	X	---	X	A S U 2 2	5	X	X	---	X
	8	X	X	96	X		8	X	X	120	X
	11	X	X	25	X		11	X	X	48	X
	14	X	X	39	X		14	X	X	51	X
	17	X	X	31	X		17	X	X	23	X
A S U 1 6	5	X	X	---	X	A S U 2 3	5	X	X	---	X
	8	X	X	120	X		8	X	X	47	X
	11	X	X	55	X		11	X	X	41	X
	14	X	X	28	X		14	X	X	32	X
	17	X	X	41	X		17	X	X	---	X
A S 1 7	5	X	X	---	X	A S U 2 4	5	X	X	---	X
	8	X	X	100	X		8	X	X	ND	X
	11	X	X	65	X		11	X	X	---	X
	14	X	X	51	X		14	X	X	28	X
	17	X	X	59	X		17	X	X	---	X
A S	5	X	X	---	X	---					

--- -- No water available for analysis

U 1 8	8	X	X	77	X
	11	X	X	27	X
	14	X	X	---	X
	17	X	X	30	X

X – location not sampled

Event 1: Oct. 16-26, 2008

Event 2: August 15-22, 2009

Event 3: July 5-19, 2010

Event 4: June 14-25, 2011

Table 9

Alkalinity Data for Depth-Discrete, Direct Push Groundwater Samples: Events 1, 2, 3, 4^a

	Depth (ft bgs)	(mg/L as CaCO ₃)			
		Event 1	Event 2	Event 3	Event 4
A S U 1	5	---	X	X	X
	8	100	X	X	X
	11	120	X	X	X
	14	180	X	X	X
	17	---	X	X	X
A S U 2	5	---	---	---	20
	8	---	---	80	100
	11	120	120	80	140
	14	160	160	160	140
	17	200	200	200	220
A S U 3	5	---	---	---	---
	8	80	80	40	---
	11	120	100	80	80
	14	80	80	40	20
	17	200	180	60	100
A S U 4	5	---	---	---	---
	8	40	40	20	---
	11	100	100	80	80
	14	---	40	80	60
	17	100	100	80	---
A S U 5	5	---	---	---	---
	8	80	100	100	---
	11	140	140	200	160
	14	120	---	80	80
	17	---	160	---	---
A S U 5.5	6.5	X	X	X	---
	8	X	X	X	320
	11	X	X	X	100
	14	X	X	X	---
	17	X	X	X	80
A S U 6B	X	---	180	80	250
	X	---	120	60	210
	X	160	80	80	110
	X	---	100	---	---
A S U 7	---	---	---	---	---
	---	---	80	140	260
	140	120	100	80	93
	100	100	100	100	150
	80	80	60	80	65
A S U 7.5	X	X	X	270	32
	X	X	X	80	740
	X	X	X	80	180
	X	X	X	110	220
A S U 7B	X	160	190	200	---
	X	---	80	100	140
	X	40	80	80	58
	X	40	100	100	---
A S U 8	---	---	---	---	---
	100	100	60	---	---
	100	100	80	140	---
	140	160	120	200	69
A S U 9	---	---	120	120	290
	---	X	X	X	X
	260	X	X	X	X
	120	X	X	X	X
A S	240	X	X	X	X
	160	X	X	X	X
	---	X	X	X	X
	200	X	X	X	X

A S U 5B	6.5	X	---	---	100
	9.5	X	80	70	180
	12.5	X	100	100	160
	15.5	X	---	80	---
A S U 6	5	200	220	60	---
	8	160	160	100	---
	11	120	120	100	80
	14	120	120	100	100
	17	100	40	---	---
A S U 6.5	6.5	X	X	X	40
	8	X	X	X	40
	11	X	X	X	100
	14	X	X	X	---
	17	X	X	X	110

U 10	140	X	X	X	X
	120	X	X	X	X
	120	X	X	X	X
A S U 11	X	---	---	---	---
	X	160	---	220	---
	X	140	80	160	150
	X	---	100	100	90
	X	---	120	100	---

--- – No water available for analysis

X – location not sampled

Event 1: Oct. 16-26, 2008

Event 2: August 15-22, 2009

Event 3: July 5-19, 2010

Event 4: June 14-25, 2011

(Table 9 Continues)

(Table 9 Continued)

	Depth (ft bgs)	(mg/L as CaCO ₃)			
		Event 1	Event 2	Event 3	Event 4
A S U 1 2	5	X	X	---	X
	8	X	X	100	X
	11	X	X	80	X
	14	X	X	120	X
	17	X	X	---	X
A S U 1 3	5	X	X	---	X
	8	X	X	60	X
	11	X	X	80	X
	14	X	X	100	X
	17	X	X	120	X
A S U 1 4	5	X	X	---	X
	8	X	X	180	X
	11	X	X	130	X
	14	X	X	120	X
	17	X	X	100	X
A S 1 5	5	X	X	40	X
	8	X	X	100	X
	11	X	X	100	X
	14	X	X	120	X
	17	X	X	100	X
A S U 1 6	5	X	X	---	X
	8	X	X	140	X
	11	X	X	90	X
	14	X	X	80	X
	17	X	X	80	X
A S 1 7	5	X	X	---	X
	8	X	X	100	X
	11	X	X	100	X
	14	X	X	100	X
	17	X	X	100	X
A S	5	X	X	---	X
A S U 1 9	5	X	X	---	X
	8	X	X	100	X
	11	X	X	60	X
	14	X	X	80	X
	17	X	X	120	X
A S U 2 0	5	X	X	---	X
	8	X	X	160	X
	11	X	X	120	X
	14	X	X	80	X
	17	X	X	---	X
A S U 2 1	5	X	X	200	X
	8	X	X	140	X
	11	X	X	100	X
	14	X	X	---	X
	17	X	X	80	X
A S U 2 2	5	X	X	---	X
	8	X	X	100	X
	11	X	X	80	X
	14	X	X	---	X
	17	X	X	40	X
A S U 2 3	5	X	X	---	X
	8	X	X	120	X
	11	X	X	80	X
	14	X	X	---	X
	17	X	X	---	X
A S U 2 4	5	X	X	---	X
	8	X	X	100	X
	11	X	X	150	X
	14	X	X	120	X
	17	X	X	100	X

--- -- No water available for analysis

U 1 8	8	X	X	180	X
	11	X	X	80	X
	14	X	X	120	X
	17	X	X	80	X

X – location not sampled

Event 1: Oct. 16-26, 2008

Event 2: August 15-22, 2009

Event 3: July 5-19, 2010

Event 4: June 14-25, 2011

Table 10A

VOC Concentration Data for Depth-Discrete Groundwater Samples: Event 1

	Depth (ft bgs)	VOC Concentration (µg/L)									
		VC	11 DCE	t - DCE	11 DCA	c-DCE	TCE	PCE	Ethene	Ethane	PCE Equiv ¹
ASU1	5	1	-	-	-	22	6	47	NW	NW	96
	8	-	-	-	-	3	-	3	-	-	8
	11	-	-	-	-	3	1	8	-	-	14
	14	1	-	-	-	4	1	11	NW	NW	21
	17	-	-	-	-	1	-	2	-	-	3
ASU2	5	-	-	-	-	-	-	2	-	-	2
	8	-	-	-	-	-	-	-	-	-	ND
	11	-	-	-	-	-	-	1	-	-	1
	14	-	-	-	-	-	-	3	6	-	37
	17	-	-	-	-	-	-	-	-	-	ND
ASU3	5	550	24	96	-	6300	470	190	3	-	13000
	8	180	5	35	-	1600	390	530	<1	-	4300
	11	7	-	-	-	24	1	7	-	-	67
	14	2	-	1	-	39	9	1	-	-	85
	17	7	-	1	-	4	1	6	-	-	35
ASU4	5	210	8	60	-	2900	1100	790	NW	NW	7800
	8	300	7	62	-	3200	4800	7300	-	-	20000
	11	190	6	42	-	1700	1100	3500	1	-	8400
	14	14	3	9	-	830	180	49	-	-	1700
	17	7	-	-	-	7	10	18	-	-	59
ASU5	5	NW	NW	NW	NW	NW	NW	NW	NW	NW	NW
	8	4700	9	180	5	4900	54	33	580	-	25000
	11	1700	1	59	-	860	4	13	77	-	6600
	14	98	4	29	-	330	2500	83	1	-	4100
	17	13	-	-	-	14	19	3	-	-	86
ASU6	5	3400	3	98	1	1300	3	1	180	-	13000
	8	3400	31	450	-	15000	3300	800	310	7	42000
	11	190	47	350	4	16000	10300	16000	15	3	58000
	14	1400	21	17	3	2800	15000	7300	7	-	35000
	17	310	3	2	-	610	920	660	-	-	3700
ASU7	5	2	-	-	-	21	1	11	-	-	56
	8	350	30	80	-	3200	5000	1800	2	-	15000

	11	12	2	8	-	280	1200	42	-	-	2100
	14		1	-	-	11	654	5	-	-	850
	17	1	1	-	-	7	93	27	-	-	160
ASU8	5	29	4	3	-	180	110	110	-	-	650
	8	2	3	4	-	310	1600	1200	-	-	3800
	11	-	-	-	-	24	99	40	-	-	200
	14	-	-	-	-	1	4	11	-	-	17
	17	-	-	-	-	1	2	7	-	-	11
ASU9	5	NW	NW	NW	NW	NW	NW	NW	NW	NW	NW
	8	18000	200	2100	-	96000	26000	66000	1700	87	32000
	11	270	4	48	-	1300	2100	2800	7	-	8500
	14	340	42	48	-	19000	1500	32000	250	320	70000
	17	4	1	1	-	370	31	280	12	21	1200
ASU10	1	4700	24	72	-	16000	2	5	ND	-	41000
	5	15000	18	750	8	29000	-	190	3000	-	110000
	8	23000	25	19000	14	25000	-	22	4000	66	130000
	11	48000	24	57	-	-	7	67	1000	440	46000
	14	4500	100	290	7	5700	2200	8600	530	250	38000
	17	180	8	3	4	310	514	2200	4	-	4000

1) PCE equivalents based on adjustment factors in Table 16. <1 - Indicates analyte was detected below the PQL of 1 ug/L
 NW - No water available for analysis

- - Non-detect

Table 10B

VOC Concentration Data for Depth-Discrete Groundwater Samples: Event 2

	Depth (ft bgs)	VOC Concentration (µg/L)									
		VC	11 DCE	t - DCE	11 DCA	c-DCE	TCE	PCE	Ethene	Ethane	PCE Equiv ¹
ASU-2	5	-	-	-	-	-	<1	<1	-	-	<1
	8	-	-	-	-	-	<1	<1	-	-	<1
	11	-	-	-	-	-	<1	<1	-	-	<1
	14	-	-	-	-	-	<1	<1	-	-	<1
	17	-	-	-	-	<1	<1	<1	-	-	<1
ASU-3	5	270	6	32	-	1800	-	-	-	-	3800
	8	260	13	50	-	4200	400	290	3	-	8800
	11	7	<1	1	-	35	<1	<1	-	-	80
	14	1	1	2	-	36	16	1	-	-	91
	17	24	1	6	-	150	9	4	<1	-	340
ASU-4	5	73	3	22	-	1900	450	160	-	-	4300
	8	670	26	130	-	6100	6900	11000	10	-	32000
	11	310	-	69	-	3100	5900	9000	3	-	23000
	14	8	-	15	-	1300	500	50	<1	-	3000
	17	12	<1	1	-	26	27	40	<1	-	150
ASU-5	5	NW	NW	NW	NW	NW	NW	NW	NW	NW	NW
	8	2700	12	170	-	390	34	18	290	<1	16000
	11	310	<1	18	-	230	14	<1	58	<1	1600
	14	180	9	35	-	1300	5200	53	6	-	9400
	17	1	-	<1	-	15	4	1	-	-	34
ASU-5B	6.5	NW	NW	NW	NW	NW	NW	NW	NW	NW	NW
	9.5	1100	2	90	-	1000	8	3	430	2	7400
	12.5	250	3	29	-	1000	630	<1	12	<1	3400
	15.5	5	<1	6	-	64	52	<1	-	-	200
ASU-6	5	850	<1	22	-	97	9	<1	-	-	2500
	8	6400	46	480	-	15000	26	-	450	10	47000
	11	5800	-	380	-	12000	4000	1300	320	7	44000
	14	6400	65	140	-	16000	6800	5600	130	3	59000
	17	1000	<1	2	1	110	6	7	96	<1	3400
ASU-6B	6.5	2400	35	470	-	9900	2300	130			27000
	9.5	800	28	280	-	12000	5500	1500	28	<1	32000
	12.5	45	10	45	-	603	6016	24653	<1	<1	33000

	15.5	2000	16	23	-	2400	1900	540	71	<1	13000
ASU7	5	NW	NW	NW	NW	NW	NW	NW	NW	NW	NW
	8	300	15	58	-	2300	3400	1300	5	<1	10000
	11	18	1	4	-	340	1100	5	<1	<1	2000
	14	<1	1	1	<1	15	1000	23	-	-	1300
	17	<1	<1	-	-	2	24	11	-	-	45
ASU-7B	6.5	57	<1	25	-	740	360	100	<1	-	2000
	9.5	270	24	89	-	3100	5500	1400	5	-	15000
	12.5	<1	1	1	<1	10	600	39	<1	<1	820
	15.5	3	1	<1	-	4	120	46	-	-	220
ASU-8	5	NW	NW	NW	NW	NW	NW	NW	NW	NW	NW
	8	5	9	11	-	280	1600	870	-	-	3400
	11	1	1	3	-	41	110	40	-	-	260
	14	-	-	-	-	<1	1	<1	-	-	1
	17	-	-	-	-	<1	<1	<1	-	-	<1
ASU-11	5	39	-	<1	<1	<1	1	1	38	<1	330
	8	42	<1	1	-	<1	<1	<1	26		270
	11	-	-	-	-	-	<1	<1	<1	<1	<1
	14	-	-	-	-	-	-	<1	-	-	<1
	17	-	-	-	-	<1	<1	<1	-	-	<1

1) PCE equivalents based on adjustment factors in Table 16. Adjustment factors and their calculation will be detailed in a document to ESTCP at a later date.

NW - No water available for analysis

- - Non-detect; less than detection limit of 1 ug/L

<1 - Indicates analyte was detected, but below the practical quantitation limit of 1 ug/L

Table 10C

VOC Concentration Data for Depth-Discrete Groundwater Samples: Event 3

	Depth (ft bgs)	VOC Concentration (µg/L)									
		VC	11 DCE	t - DCE	11 DCA	c-DCE	TCE	PCE	Ethene	Ethane	PCE Equiv ¹
ASU2	5	NW	NW	NW	NW	NW	NW	NW	NW	NW	NW
	8	-	-	-	-	-	-	-	-	-	-
	11	-	-	-	-	-	-	-	-	-	-
	14	-	-	-	-	-	-	-	-	-	-
	17	-	-	-	-	-	-	-	-	-	-
ASU3	5	NW	NW	NW	NW	NW	NW	NW	NW	NW	NW
	8	135	9	33	-	1900	600	870	2	<1	5300
	11	7	<1	<1	-	56	8	14	-	-	140
	14	<1	<1	<1	-	40	7	-	<1	-	77
	17	1	-	-	-	7	<1	<1	<1	3	29
ASU4	5	NW	NW	NW	NW	NW	NW	NW	NW	NW	NW
	8	390	17	99	-	4200	5100	6200	<1	-	21000
	11	160	8	53	-	2500	1900	2700	<1	<1	9900
	14	-	1	1	-	700	120	20	<1	<1	1400
	17	56	-	12	-	690	4	-	<1	-	1400
ASU5	5	NW	NW	NW	NW	NW	NW	NW	NW	NW	NW
	8	1400	2	110	12	1500	13	-	380	<1	8800
	11	270	-	29	-	200	-	-	40	<1	1300
	14	110	8	31	-	1800	160	22	5	<1	3700
	17	NW	NW	NW	NW	NW	NW	NW	NW	NW	NW
ASU5B	6.5	NW	NW	NW	NW	NW	NW	NW	NW	NW	NW
	9.5	550	2	67	-	640	8	3	680	3	6700
	12.5	200	3	24	-	730	49	-	21	<1	2000
	15.5	9	4	6	-	170	94	-	<1	<1	450
ASU6	5	390	-	23	-	130	9	-	40	-	1500
	8	2300	38	440	-	15000	470	160	190	7	35000
	11	340	33	410	-	7100	15000	9700	9	-	42000
	14	1800	56	92	-	10000	2300	1800	25	-	27000
	17	330	6	3	-	1300	21	8	-	-	3200
ASU6B	6.5	1800	21	290	-	7600	6	-	500	9	21000
	9.5	1900	53	750	-	23000	8000	760	120	4	57000
	12.5	240	54	390	-	13000	13000	9400	8	4	50000

	15.5	280	17	24	-	3200	1500	2200	5	<1	10000
ASU7	5	NW	NW	NW	NW	NW	NW	NW	NW	NW	NW
	8	290	20	80	-	2600	4100	1500	11	<1	12000
	11	56	7	35	-	960	3600	310	2	2	6700
	14	-	6	-	-	17	560	2	<1	<1	750
	17	-	-	-	-	1	24	8	<1	<1	40
ASU7B	6.5	13	1	3	-	210	1	-	<1	-	400
	9.5	120	16	97	-	3200	3200	270	2	<1	10000
	12.5	<1	<1	<1	-	12	440	<1	<1	<1	580
	15.5	-	<1	-	-	9	230	50	-	-	360
ASU8	5	NW	NW	NW	NW	NW	NW	NW	NW	NW	NW
	8	5	6	10	-	270	1300	980	<1	<1	3100
	11	3	<1	1	-	63	78	14	<1	<1	230
	14	-	-	-	-	-	<1	1	<1	<1	1
	17	-	-	-	-	-	-	-	-	-	-
ASU11	5	NW	NW	NW	NW	NW	NW	NW	NW	NW	NW
	8	57	-	<1	-	-	-	-	-	-	150
	11	-	-	-	-	-	-	-	-	-	-
	14	-	-	-	-	-	-	-	-	-	-
	17	-	-	-	-	-	-	-	-	-	-

1) PCE equivalents based on adjustment factors in Table 16. Adjustment factors and their calculation will be detailed in a document to ESTCP at a later date.

NW - No water available for analysis

- - Non-detect; less than detection limit of 1 ug/L

<1 - Indicates analyte was detected, but below the practical quantitation limit of 1 ug/L

(Table 10C Continues)

(Table 10C Continued)

	Depth (ft bgs)	VOC Concentration (µg/L)									
		VC	11 DCE	t - DCE	11 DCA	c-DCE	TCE	PCE	Ethene	Ethane	PCE Equiv ¹
ASU12	5	NW	NW	NW	NW	NW	NW	NW	NW	NW	NW
	8	230	6	32	-	1400	1600	5200	10	<1	10000
	11	18	1	2	-	470	2	5	<1	<1	860
	14	12	3	7	-	620	720	70	<1	<1	2100
	17	NW	NW	NW	NW	NW	NW	NW	NW	NW	NW
ASU13	5	290		26	-	1200	16	13	12	<1	3000
	8	580	14	120	-	5700	2700	910	-	-	16000
	11	610	27	130	-	6400	4000	4400	53	<1	23000
	14	5	3	3	-	670	340	18	<1	<1	1600
	17	<1	<1	<1	-	10	10	1	<1	<1	30
ASU14	5	NW	NW	NW	NW	NW	NW	NW	NW	NW	NW
	8	150	-	42	23	1	<1	1	4500	58	27000
	11	3200	37	97	-	2000	91	140	2100	64	25000
	14	11000	32	150	-	9100	1600	850	630	50	52000
	17	60	1	<1	<1	46	410	150	25	<1	1100
ASU15	5	NW	NW	NW	NW	NW	NW	NW	NW	NW	NW
	8	600	24	350	-	7600	350	8	46	<1	16000
	11	60	5	55	-	970	1800	27	2	<1	4200
	14	-	23	12	-	200	7500	39	<1	<1	9900
	17	-	5	1	-	50	970	150	<1	<1	1500
ASU16	5	NW	NW	NW	NW	NW	NW	NW	NW	NW	NW
	8	690	26	120	-	4400	3600	820	48	<1	15000
	11	2	<1	2	-	59	240	14	<1	<1	430
	14	-	4	2	-	13	940	190	<1	<1	1400

	17	-	-	-	-	10	48	33	<1	<1	110
ASU17	5	NW	NW	NW	NW	NW	NW	NW	NW	NW	NW
	8	9	12	46	-	470	470	280	<1	-	1800
	11	<1	-	<1	-	11	11	7	<1	<1	40
	14	-	-	-	-	<1	<1	<1	-	-	-
	17	-	-	-	-	-	-	-	<1	<1	-
ASU18	5	NW	NW	NW	NW	NW	NW	NW	NW	NW	NW
	8	<1	-	-	<1	6	<1	-	-	-	10
	11	-	-	-	-	-	-	-	-	-	-
	14	-	-	-	-	-	-	-	-	-	-
	17	-	-	-	-	-	-	-	NW	NW	-

1) PCE equivalents based on adjustment factors in Table 16. Adjustment factors and their calculation will be detailed in a document to ESTCP at a later date.

NW - No water available for analysis

- - Non-detect; less than detection limit of 1 ug/L

<1 - Indicates analyte was detected, but below the practical quantitation limit of 1 ug/L

(Table 10C Continues)

(Table 10C Continued)

	Depth (ft bgs)	VOC Concentration (µg/L)									
		VC	11 DCE	t - DCE	11 DCA	c-DCE	TCE	PCE	Ethene	Ethane	PCE Equiv ¹
ASU19	5	650	30	120	-	7100	1800	2500	-	-	19000
	8	690	30	100	-	4900	4300	17000	17	<1	33000
	11	13	-	9	-	610	230	370	<1	<1	1800
	14	10	4	3	-	350	330	1400	-	-	2500
	17	4	-	-	-	9	9	13	<1	<1	50
ASU20	5	NW	NW	NW	NW	NW	NW	NW	NW	NW	NW
	8	27	-	11	35	7	-	-	440	3	2800
	11	460	-	48	-	610	-	190	79	2	3000
	14	110	2	9	2	120	62	180	18	<1	880
	17	<1	-	-	-	5	90	100	<1	<1	220
ASU21	5	850	-	69	49	170	1	6	2200	41	16000
	8	2900	12	580	-	2600	34	170	5300	170	46000
	11	6500	47	330	-	23000	190	350	1000	260	65000
	14								110	62	990
	17	47	14	3	10	260	490	1500	<1	<1	2700
ASU22	5	NW	NW	NW	NW	NW	NW	NW	NW	NW	NW
	8	1300	51	670	-	1400	14000	25000	33	<1	50000
	11	20	3	13	-	330	2300	510	<1	<1	4100
	14	11	-	18	-	250	2300	1700	<1	<1	5100
	17	<1	-	-	-	5	120	110	<1	<1	270
ASU23	5	NW	NW	NW	NW	NW	NW	NW	NW	NW	NW
	8	6	7	12	-	200	370	260	-	-	1100
	11	-	-	-	-	9	11	48	<1	<1	77
	14	-	-	-	-	-	-	-	-	-	-

	17	-	-	7	-	-	2	2	-	-	16
ASU24	5	NW	NW	NW	NW	NW	NW	NW	NW	NW	NW
	8	4	<1	<1	1	1	2	6	<1	<1	23
	11	-	-	-	-	-	-	-	-	-	-
	14	4	-	-	-	-	<1	<1	<1	<1	11
	17	-	-	-	-	-	-	-	-	-	-

1) PCE equivalents based on adjustment factors in Table 16. Adjustment factors and their calculation will be detailed in a document to ESTCP at a later date.

NW - No water available for analysis

- - Non-detect; less than detection limit of 1 ug/L

<1 - Indicates analyte was detected, but below the practical quantitation limit of 1 ug/L

Table 10D

VOC Concentration Data for Depth-Discrete Groundwater Samples: Event 4

	Depth (ft bgs)	VOC Concentration (µg/L)									
		VC	11 DCE	t - DCE	11 DCA	c-DCE	TCE	PCE	Ethene	Ethane	PCE Equiv ¹
ASU2	6.5	-	-	-	-	-	-	-	-	-	-
	8	NW	NW	NW	NW	NW	NW	NW	NW	NW	NW
	11	NW	NW	NW	NW	NW	NW	NW	NW	NW	NW
	14	-	-	-	-	-	-	-	-	-	-
	17	NW	NW	NW	NW	NW	NW	NW	NW	NW	NW
ASU3	6.5	400	9	34	-	2000	180	350	12	-	5200
	8	260	-	31	-	1600	730	1100	7	-	5600
	11	28	-	-	-	160	64	-	-	-	430
	14	-	-	-	-	39	15	1	-	-	85
	17	-	-	-	-	1	<1	1	-	-	4
ASU4	6.5	460	26	140	-	5264	2600	3300	18	-	17000
	8	450	20	73	-	5200	2900	4100	7	-	18000
	11	270	-	57	-	3200	3000	2200	8	-	12000
	14	7	-	18	-	910	36	-	-	-	1700
	17	1	-	-	-	16	4	5	-	-	39
ASU5	6.5	NW	NW	NW	NW	NW	NW	NW	NW	NW	NW
	8	NW	NW	NW	NW	NW	NW	NW	NW	NW	NW
	11	410	-	52	-	180	69	-	250	3	3000
	14	58	-	200	-	750	-	-	<1ppb	-	1800
	17	12	-	-	-	2	-	2	-	-	39
ASU5.5	6.5	4300	-	110	-	520	-	-	2300	100	26000
	8	11000	-	180	-	1500	820	-	2400	90	48000

	11	1700	-	400	-	10000	650	-	1100	110	31000
	14	13000	45	180	-	17000	110	-	2200	420	81000
	17	370	-	-	-	230	770	110	7	<1	2500
ASU5B	6.5	1200	-	75	-	1200		-	69	<1	5700
	9.5	800	-	88	-	530	340	-	640	2	7200
	12.5	410	-	26	-	710	57	-	42	4	2700
	15.5	33	-	14	-	180	140	-	-	-	610
ASU6	5	NW	NW	NW	NW	NW	NW	NW	NW	NW	NW
	8	180	11	1200	-	4300	2400	380	5	-	13000
	11	64	8	31	-	460	1700	760	-	-	3900
	14	16	-	-	-	180	7000	4200	-	-	13000
	17	29	-	-	-	140	1400	430	-	-	2500

1) PCE equivalents based on adjustment factors in Table 16. Adjustment factors and their calculation will be detailed in a document to ESTCP at a later date.

NW - No water available for analysis

- - Non-detect; less than detection limit of 1 ug/L

<1 - Indicates analyte was detected, but below the practical quantitation limit of 1 ug/L

(Table 10D Continues)

(Table 10D Continued)

	Depth (ft bgs)	VOC Concentration (µg/L)									
		VC	11 DCE	t - DCE	11 DCA	c-DCE	TCE	PCE	Ethene	Ethane	PCE Equiv ¹
ASU6.5	6.5	350	-	410	-	1500	740	53	5	-	5300
	8	240	15	430	-	1600	1200	77	7	-	5700
	11	75	28	300	-	1100	3700	140	3	-	7400
	14	-	8	16	-	22	3300	2300	-	-	6600
	17	NW	NW	NW	NW	NW	NW	NW	NW	NW	NW
ASU6B	6.5	380	14	820	-	3900	1200	49	9	-	11000
	9.5	300	24	220	-	3100	4300	480	2	-	12000
	12.5	9	-	18	-	140	7000	930	-	-	10000
	15.5	-	-	-	-	94	2900	140	-	-	4000
ASU7	6.5	NW	NW	NW	NW	NW	NW	NW	NW	NW	NW
	8	170	-	64	-	1800	1800	620	6	-	6800
	11	61	-	25	-	510	2500	87	-	-	4300
	14	-	-	-	-	-	370	-	-	-	470
	17	-	-	-	-	2	94	44	-	-	170
ASU7.5	6.5	22	26	91	-	2000	340	-	-	-	4000
	8	20	22	61	-	1400	2200	390	-	-	5700
	11	-	-	-	-	93	170	37	-	-	410
	14	-	-	-	-	-	2	7	-	-	10
	17	-	-	-	-	<1	<1	1	-	-	2
ASU7B	6.5	280	-	15	-	380	970	26	2	-	2700
	9.5	66	7	53	-	550	2200	520	<1	-	4500
	12.5	56	-	16	-	340	2500	470	NW	NW	4300
	15.5	8	-	-	-	-	140	42	-	-	240
ASU8	6.5	NW	NW	NW	NW	NW	NW	NW	NW	NW	NW

	8	NW	NW	NW	NW	NW	NW	NW	NW	NW	NW
	11	-	-	10	-	26	5	4	-	-	72
	14	3	12	22	-	13	8	3	-	-	100
	17	-	-	-	-	-	-	-	-	<1	<1
ASU11	6.5	NW	NW	NW	NW	NW	NW	NW	NW	NW	NW
	8	32	14	28	-	7	3	-	16	-	260
	11	-	2	1	-	1	-	-	-	-	6
	14	NW	NW	NW	NW	NW	NW	NW	NW	NW	NW
	17	-	4	3	-	1	1	1	-	-	15

1) PCE equivalents based on adjustment factors in Table 16. Adjustment factors and their calculation will be detailed in a document to ESTCP at a later date.

NW - No water available for analysis

- - Non-detect; less than detection limit of 1 ug/L

<1 - Indicates analyte was detected, but below the practical quantitation limit of 1 ug/L

Table 11A

VOC Concentration Data for Permanent Monitoring Wells: Event 1

Well	Depth (ft bgs)	VOC Concentration (µg/L)									
		VC	11 DCE	t-DCE	11 DCA	c - DCE	TCE	PCE	Ethene	Ethane	PCE Equiv ¹
ML3	4	740	3	19	11	380	14	13	NQ	NQ	2700
	6.5	15	-	3	3	1	1	2	NQ	NQ	55
	9	78	-	26	12	12	-	-	NQ	NQ	290
	11.5	65	-	6	-	9	4	3	NQ	NQ	210
	14	5	-	-	-	2	-	-	NQ	NQ	17
	16.5	18	-	-	-	5	-	-	NQ	NQ	56
	19	820	-	27	-	810	470	600	NQ	NQ	4800
ML4	4	6500	7	140	13	9400	4	5	NQ	NQ	34000
	6.5	725	-	62	240	260	-	2	NQ	NQ	2900
	9	12000	8	460	15	9100	-	-	NQ	NQ	48000
	11.5	690	3	250	7	630	-	4	NQ	NQ	3300
	14	1500	8	59	18	460	70	-	NQ	NQ	5000
	16.5	1900	-	51	11	440	4	5	NQ	NQ	5900
	19	73	-	5	1	11	-	-	NQ	NQ	220
ML5	4	5200	-	280	230	790	-	98	NQ	NQ	16000
	6.5	12000	-	57	77	51	-	-	NQ	NQ	32000
	11.5	5000	180	690	-	11000	-	-	NQ	NQ	34000
	14	11000	130	440	-	8900	26	46	NQ	NQ	45000
	16.5	4900	-	22	5	81	1	8	NQ	NQ	13000
	19	8100	200	270	-	3600	1570	3700	NQ	NQ	34000
ML6	4	9100	9	120	43	5000	5	7	NQ	NQ	33000
	6.5	4500	-	380	250	870	4	-	NQ	NQ	15000

	9	40000	-	1100	33	5000	-	-	NQ	NQ	120000
	11.5	13000	11000	220	24	2700	-	-	NQ	NQ	58000
	14	13000	93	200	-	4300	30	-	NQ	NQ	42000
	16.5	33000	67	60	-	270	120	-	NQ	NQ	88000
	19	24000	33	95	8	9700	541	2600	NQ	NQ	84000
ML7	3.5	930	-	11	2	150	6	5	NQ	NQ	2700
	6.5	11000	-	210	130	520	27	19	NQ	NQ	31000
	8.5	12000	28	1200	81	4800	-	-	NQ	NQ	42000
	11	23000	24	110	-	14000	1	-	NQ	NQ	85000
	13.5	17000	520	1200	-	46000	-	-	NQ	NQ	130000
	16	8000	-	230	140	770	180	46	NQ	NQ	23000
	18.5	810	-	280	-	89	-	6	NQ	NQ	2800
MW2	SL (9-14ft)	4	-	-	-	-	1	3	NQ	NQ	15
MW3	SU (3-7ft)	3	-	-	-	-	1	5	NQ	NQ	14
MW21	SL (9-14ft)	3	-	0	-	14	23	6	NQ	NQ	67
	SU (3-7ft)	83	8	49	-	1800	1500	250	NQ	NQ	5500
MW6	SL (9-14ft)	11	4	14	-	590	56	5	NQ	NQ	1100
	SU (3-7ft)	46	1	2	-	82	22	23	NQ	NQ	320
MW7	SU (12ft)	340	20	170	-	2800	7700	6400	NQ	NQ	22000
	SL (5ft)	280	21	190	-	5500	8300	7500	NQ	NQ	28000
PMW1		220	-	11	<1	120	14	9	NQ	NQ	840

NQ – Not quantified

<1 – Indicates analyte was detected, but below practical quantitation limit of 1 ug/L

- – Non-detect; less than detection limit of 1ug/L

Table 11B

VOC Concentration Data for Permanent Monitoring Wells: Event 2

Well	Depth (ft bgs)	VOC Concentration (µg/L)									
		VC	11 DCE	t-DCE	11 DCA	c - DCE	TCE	PCE	Ethene	Ethane	PCE Equiv ¹
ML3	4	300	66	45	77	160	100	180	-	300	1700
	6.5	NW	NW	NW	NW	NW	NW	NW	NW	NW	NW
	9	16	0	5	1	20	11	39	3	<1	140
	11.5	16	0	2	-	22	2	27	3	<1	110
	14	16	-	-	-	13	1	10	-	-	76
	16.5	NW	NW	NW	NW	NW	NW	NW	NW	NW	NW
	19	2700	46	72		12000	4200	35000	96	7	68000
ML4	4	4700	58	460	16	16000	-	1200	350	4	42000
	6.5	310	29	17	-	160	29	43	2500	34	1300
	9	5100	17	-	-	890	-	5	12000	130	15000
	11.5	2400	-	120	-	400	12	36	180	11	7300
	14	2100	35	66	-	1100	0	16	210	18	7600
	16.5	1700	4	29	-	1000	110	23	1900	380	6400
	19	250	13	25	3	200	16	27	13	110	1100
ML5	4	4600	18	120	69	3000	-	55	3600	48	18000
	6.5	4600	24	38	120	140	41	440	6300	120	13000
	11.5	4700	20	470	56	750	38	4	6000	150	15000
	14	5100	9	91	-	3700	17	52	310	55	20000
	16.5	27000	36	230	-	14000	130	-	2100	88	96000
	19	3800	-	22	23	58	38	3	2100	45	10000
ML6	4	7700	97	250	22	6200	150	250	1200	76	32000
	6.5	1900	-	69	62	160	160	94	6800	360	5800

	9	5400	110	1100	-	1600	220	95	8000	340	20000
	11.5	5800	32	130	-	2800	67	28	1200	110	21000
	14	13000	460	610	-	82000	1100	220	2600	910	180000
	16.5	33000	140	190	-	2700	410	32	3800	380	93000
	19	21000	28	220	-	15000	1700	2700	2500	130	87000
ML7	3.5	6800	39	44	30	310	250	30	1800	270	19000
	6.5	4800	120	370	20	8000	310	-	3000	510	28000
	8.5	8200	20	130	-	9600	84	-	2400	370	39000
	11	8400	170	160	-	42000	620	-	1900	600	95000
	13.5	6100	160	26	-	830	310	85	1700	41	18000
	16	700	27	6	-	140	79	540	380	<1	2800
	18.5	6800	39	44	30	310	250	30	1800	270	19000

NQ – Not quantified

<1 – Indicates analyte was detected, but below practical quantitation limit of 1 ug/L

- – Non-detect; less than detection limit of 1ug/L

Table 11C

VOC Concentration Data for Permanent Monitoring Wells: Event 3

Well	Depth (ft bgs)	VOC Concentration (µg/L)									
		VC	11 DCE	t-DCE	11 DCA	c - DCE	TCE	PCE	Ethene	Ethane	PCE Equiv ¹
ML3	4	NW	NW	NW	NW	NW	NW	NW	NW	NW	NW
	6.5	NW	NW	NW	NW	NW	NW	NW	NW	NW	NW
	9	6	3	<1	-	1	1	2	-	-	26
	11.5	4	-	1	-	<1	<1	-	<1	<1	12
	14	2	-	-	-	-	-	-	<1	<1	5
	16.5	29	-	-	-	-	-	-	13	<1	150
	19	2500	91	210	-	26000	9400	34000	53	3	100000
ML4	4	NW	NW	NW	NW	NW	NW	NW	NW	NW	NW
	6.5	37	-	14	46	40	13	-	300	9	2100
	9	1700	-	130	-	24	19	-	1200	30	12000
	11.5	1900	-	130	-	990	15	52	200	13	8300
	14	1600	21	40	-	1400	76	-	155	42	8000
	16.5	2100	11	42	-	1400	8	-	180	33	9300
	19	35	-	3	<1	1	-	-	56	160	1300
ML5	4	NW	NW	NW	NW	NW	NW	NW	NW	NW	NW
	6.5	68	-	20	63	-	-	-	5100	110	31000
	11.5	1800	6	330	-	280	120	-	7400	210	51000
	14	6200	12	160	-	6300	33	12	750	58	32000
	16.5	7300	-	64	-	2400	130	-	2500	82	39000
	19	2100	-	8	-	5	92	58	2400	59	20000
ML6	4	2300	35	44	-	2900	1500	3900	1300	26	25000
	6.5	NW	NW	NW	NW	NW	NW	NW	NW	NW	NW

	9	360	24	37	44	110	97	-	8300	340	52000
	11.5	-	15	500	-	770	170	15	-	-	2400
	14	3900	-	64	-	500	87	-	11	-	11000
	16.5	7800	81	300	-	35000	710	29	1900	740	97000
	19	19000	-	120	-	1800	320	-	3800	490	80000
ML7	3.5	6700	73	200	-	18000	2800	1600	1800	81	65000
	6.5	NW	NW	NW	NW	NW	NW	NW	NW	NW	NW
	8.5	1100	12	12	13	80	170	-	-	-	3300
	11	2400	22	230	15	4000	260	-	3000	530	35000
	13.5	5700	15	93	-	6500	100	-	1800	430	40000
	16	4900	66	150	-	32000	720	-	2200	650	86000
	18.5	210	3	6	-	10	280	-	650	31	5000

NQ – Not quantified

<1 – Indicates analyte was detected, but below practical quantitation limit of 1 ug/L

- – Non-detect; less than detection limit of 1ug/L

Table 11D

VOC Concentration Data for Permanent Monitoring Wells: Event 4

Well	Depth (ft bgs)	VOC Concentration (µg/L)									
		VC	11 DCE	t-DCE	11 DCA	c - DCE	TCE	PCE	Ethene	Ethane	PCE Equiv ¹
ML3	4	NW	NW	NW	NW	NW	NW	NW	NW	NW	NW
	6.5	NW	NW	NW	NW	NW	NW	NW	NW	NW	NW
	9	NW	NW	NW	NW	NW	NW	NW	NW	NW	NW
	11.5	-	-	-	-	-	-	-	2	2	23
	14	NW	NW	NW	NW	NW	NW	NW	NW	NW	NW
	16.5	NW	NW	NW	NW	NW	NW	NW	NW	NW	NW
	19	1600	46	630	-	9000	6700	14000	54	3	43000
ML4	4	NW	NW	NW	NW	NW	NW	NW	NW	NW	NW
	6.5	NW	NW	NW	NW	NW	NW	NW	NW	NW	NW
	9	300	-	41	26	16	-	-	970	37	6900
	11.5	1800	-	150	-	2900	160	460	1600	120	21000
	14	2700	26	940	-	8900	500	-	<1	<1	25000
	16.5	1500	9	670	-	3100	46	33	<1	-	10000
	19	260			-	49	-	180	35	52	1500
ML5	4	NW	NW	NW	NW	NW	NW	NW	NW	NW	NW
	6.5	79	-	32	-	13	-	-	1300	-	8000
	11.5	80	-	83	-	-	64	-	1400	-	8600
	14	6400	-	120	-	2400	-	-	-	-	21000
	16.5	1700	-	9	-	110	32	-	1600	36	15000
	19	NW	NW	NW	NW	NW	NW	NW	NW	NW	NW
ML6	4	1700	28	550		2400	1800	4900	1400	26	25000
	6.5	NW	NW	NW	NW	NW	NW	NW	NW	NW	NW

	9	650	28	26	-	160	45	-	1700	-	12000
	11.5	620	74	160	-	120	70	-	1700	49	13000
	14	6200	-	74	-	1100	-	50	930	59	24000
	16.5	10000	100	540	-	49000	140	-	2900	840	130000
	19	7500	-	36	-	440	-	-	2300	-	35000
	3.5	8500	30	370	-	7600	10	25	1500	26	45000
	6.5	NW	NW	NW	NW	NW	NW	NW	NW	NW	NW
	8.5	1100	120	22	-	650	180	26	4400	280	32000
ML7	11	2600	170	94	-	4700	120	-	2400	250	31000
	13.5	5800	45	130	-	6100	-	-	1600	170	37000
	16	5000	81	140	-	17000	150	-	1800	230	56000
	18.5	400	-	6	-	65	16	22	670	3	5200

NQ – Not quantified

<1 – Indicates analyte was detected, but below practical quantitation limit of 1 ug/L

- – Non-detect; less than detection limit of 1ug/L

Table 12A

Fatty Acid Analysis Results^a: Event 1: October 16 – 26, 2008

Fatty Acid	Well	ML4	ML6	
	Depth (ft bgs)	11.5	6.5	11.5
	PQL (mg/L)	Concentration (mg/L)		
N Acetic Acid	0.07	ND	330	57
N Butyric Acid	0.07	ND	28	3.1
N Hexanoic Acid	0.1	ND	2.4	ND
N i-Hexanoic Acid	0.1	ND	0.2	ND
N i-Pentanoic Acid	0.07	ND	1.3	0.26
N Lactic Acid and HIBA	0.1	0.25	13	1.4
N Pentanoic Acid	0.07	ND	25	2.2
N Propionic Acid	0.07	ND	150	8.7
N Pyruvic Acid	0.07	ND	15	1.7

PQL – Practical quantitation limit

ND – Non-detect

a – Samples were immediately submitted, but exceeded holding time at the lab due to inability of lab to analyze the samples in time as a result of instrument malfunction.

Table 12B

Fatty Acid Analysis Results: Event 2: August 15-22, 2009

Fatty Acid	Well	ML6		
	Depth (ft bgs)	9	14	19
	PQL (mg/L)	Concentration (mg/L)		
N Acetic Acid	0.07	580	140	75
N Butyric Acid	0.07	80	22	1.5
N Hexanoic Acid	0.1	ND	ND	ND
N i-Hexanoic Acid	0.1	0.45	ND	ND
N i-Pentanoic Acid	0.07	ND	0.98	0.33
N Lactic Acid and HIBA	0.1	ND	0.46	ND
N Pentanoic Acid	0.07	64	19	0.73
N Propionic Acid	0.07	270	140	20
N Pyruvic Acid	0.07	75	9.2	2.2

PQL – Practical quantitation limit

ND – Non-detect

Table 13A

Dehalococcoides Testing: Event 2: August 15-22, 2009

Location	Depth (ft bgs)	General Bacteria	Dehalococcoides
ASU 3	11	X	---
	14	---	---
ASU 4	8	---	---
	11	---	---
	14	---	---
ASU 7	8	---	---
	11	X	---
	14	X	---
ASU 11	8	X	X
	11	X	X
	14	---	---

X – Indicates positive

--- – indicates non-detect

Table 13B

Dehalococcoides Testing: Event 3: July 5-19, 2010

Location	Depth (ft bgs)	General Bacteria	Dehalococcoides
ASU 2	8	X	---
ASU 4	11	---	---
ASU 5	11	X	---
ASU 5B	12.5	---	---
ASU 6	11	X	---
ASU 7	14	X	---
ASU 11	11	X	X
ASU 12	14	---	---
ASU 13	8	---	---
ASU 15	14	X	X
ASU 16	14	---	---
ASU 18	11	X	---
ASU 19	11	---	---
ASU 20	14	---	---
ASU 22	8	X	X
ASU 23	14	---	---
ASU 24	11	X	---

X – Indicates positive

--- – indicates non-detect

Table 14

Stable Isotope Analysis – Event 3: July 15, 2010

Location ¹	Depth (ft bgs)	VC		c-DCE		TCE		PCE	
		<u>Conc</u>	<u>Del</u>	<u>Conc</u>	<u>Del</u>	<u>Conc</u>	<u>Del</u>	<u>Conc</u>	<u>Del</u>
		(µg/L)	(‰)	(µg/L)	(‰)	(µg/L)	(‰)	(µg/L)	(‰)
ASU3	11	4 (J)	-	43	-23.11	4 (J)	-10.58	1 (J)	-18.96
ASU4	11	600	-27.00	3000	.25.88	3000	-27.76	3000	-19.19
ASU5	11	1000	-23.13	300	-17.82	<50	-	<50	-
ASU6	11	10000	-41.87	20000	-26.32	2000	-21.12	200 (J)	-14.28
ASU7	11	20 (J)	-28.29	1000	-31.12	100	-23.39	<50 (U)	-
ASU8	11	2	-	60	-29.83	100	-26.89	4 (J)	-3.16
ASU11	11	2 (J)	-	0.3 (J)	-	2 (J)	-	<5 (U)	-

1 – A second direct push sampling location was used to collect CSIA samples; location was within 1ft of existing sampling locations

J – The number is an estimated concentration because something in the sample interfered with the analysis.

U – The contaminant was not detected at a concentration greater than the detection limit.

Conc - Concentration

Table 15A

Soil Gas Concentration Data: Event 1: October 16 – 26, 2008

Vapor Point	Soil Gas Concentration (µg/L)							
	VC	11 DCE	t-DCE	11 DCA	c - DCE	TCE	PCE	PCE Equivalents
VP1	24	2	25	1	1200	890	10000	13000
VP2	---	---	---	---	---	---	---	---
VP3	5	ND	ND	ND	6	1	4	29
VP4	9	ND	<1	ND	4	<1	<1	30
VP5	180	ND	ND	ND	35	ND	1	540

ND – Non-detect; less than detection limit of 1ug/L

<1 – Analyte was detected, but concentration below practical quantitation limit

--- No sample collected due to submerged screen

Table 15B

Soil Gas Concentration Data: Event 2: August 15-22, 2009

Vapor Point	Soil Gas Concentration (µg/L)							
	VC	11 DCE	t-DCE	11 DCA	c - DCE	TCE	PCE	PCE Equivalents
VP1	14	1	11	2	830	620	7900	10000
VP2	37	<1	ND	ND	10	<1	4	120
VP3	---	---	---	---	---	---	---	---
VP4	---	---	---	---	---	---	---	---
VP5	---	---	---	---	---	---	---	---

ND – Non-detect; less than detection limit of 1µg/L

<1 – Analyte was detected, but concentration below practical quantitation limit

--- No sample collected due to submerged screen

Table 15C

Soil Gas Concentration Data: Event 3: July 5-19, 2010

Vapor Point	Soil Gas Concentration (µg/L)							
	VC	11 DCE	t-DCE	11 DCA	c - DCE	TCE	PCE	PCE Equivalents
VP6	21	ND	130	ND	410	112	470	1600
VP7	1	ND	<1	<1	<1	<1	6	9
VP8	<1	ND	ND	ND	ND	ND	4	4
VP9	<1	<1	<1	ND	<1	2	ND	2
VP10	<1	ND	ND	ND	ND	ND	ND	ND
VP11	<1	ND	<1	ND	<1	1	2	4
VP12	<1	ND	ND	ND	ND	ND	ND	ND
VP13	<1	ND	ND	ND	ND	<1	6	6
VP14	<1	ND	ND	ND	ND	ND	ND	ND

ND – Non-detect; less than detection limit of 1µg/L

<1 – Analyte was detected, but concentration below practical quantitation limit

--- No sample collected due to submerged screen

Table 15D

Soil Gas Concentration Data: Event 4: June 14-25, 2011

Vapor Point	Soil Gas Concentration (µg/L)							
	VC	11 DCE	t-DCE	11 DCA	c - DCE	TCE	PCE	PCE Equiv
VP6	ND	ND	70	ND	230	78	360	970
VP7	ND	ND	ND	ND	ND	ND	ND	ND
VP8	ND	ND	ND	ND	ND	ND	54	54
VP9	ND	ND	ND	ND	2	ND	ND	3
VP10	ND	ND	ND	ND	ND	ND	ND	ND
VP11	ND	ND	ND	ND	6	ND	19	30
VP12	ND	ND	ND	ND	ND	ND	ND	ND
VP13	ND	ND	ND	ND	ND	ND	ND	ND
VP14	ND	ND	ND	ND	ND	ND	ND	ND

ND – Non-detect; less than detection limit of 1ug/L

<1 – Analyte was detected, but concentration below practical quantitation limit

--- No sample collected due to submerged screen

Table 16A

Diffusion Coefficients: Event 1: October 16 – 26, 2008

Location	Test	Depth (cm)	Effective Helium Diffusion Coefficient (cm ² /s)	$\frac{D_{He}^{eff}}{D_{He}^{Air}}$ (cm ² /s)
VP1	1	46	1.4×10^{-2}	2.3×10^{-2}
VP1	2	46	1.2×10^{-2}	1.9×10^{-2}
VP2	1	46	NS	NS
VP2	2	46	NS	NS
VP3	1	46	8.9×10^{-3}	1.4×10^{-2}
VP3	2	46	1.0×10^{-2}	1.7×10^{-2}
VP4	1	46	8.5×10^{-3}	1.4×10^{-2}
VP4	2	46	1.3×10^{-2}	2.1×10^{-2}
VP5	1	46	6.7×10^{-3}	1.1×10^{-2}
VP5	2	46	1.1×10^{-2}	1.7×10^{-2}
Site Average	NA	NA	1.1×10^{-2}	1.7×10^{-2}

NS – No sample collected due to submerged sampling screen

Table 16B

Diffusion Coefficients: Event 3: July 5 – 19, 2010

Location	Depth (cm)	Effective Helium Diffusion Coefficient (cm ² /s)	$D_{He}^{eff} / D_{He}^{Air}$ (cm ² /s)
VP6	61	7.4×10^{-2}	1.1×10^{-1}
VP7	58	8.2×10^{-2}	1.2×10^{-1}
VP8	67	2.6×10^{-2}	3.9×10^{-2}
VP9	43	4.3×10^{-2}	6.4×10^{-2}
VP10	59	5.9×10^{-2}	8.7×10^{-2}
VP11	62	5.5×10^{-2}	8.2×10^{-2}
VP12	63	2.4×10^{-2}	3.5×10^{-2}
VP13	60	2.6×10^{-2}	3.9×10^{-2}
VP14	43	2.7×10^{-2}	4.1×10^{-2}
Site Average	NA	4.6×10^{-2}	6.9×10^{-2}

Table 16C

Diffusion Coefficients: Event 4: June 14 – 25, 2011

Location	Depth (cm)	Effective Helium Diffusion Coefficient (cm ² /s)	$D_{He}^{eff} / D_{He}^{Air}$ (cm ² /s)
VP6	61	7.4×10^{-2}	1.1×10^{-1}
VP7	58	8.2×10^{-2}	1.2×10^{-1}
VP8	67	2.6×10^{-2}	3.9×10^{-2}
VP9	43	4.3×10^{-2}	6.4×10^{-2}
VP10	59	5.9×10^{-2}	8.7×10^{-2}
VP11	62	5.5×10^{-2}	8.2×10^{-2}
VP12	63	2.4×10^{-2}	3.5×10^{-2}
VP13	60	2.6×10^{-2}	3.9×10^{-2}
VP14	43	2.7×10^{-2}	4.1×10^{-2}
Site Average	NA	4.6×10^{-2}	6.9×10^{-2}

Table 17

Vapor Flux Calculation: Event 1, 2, 3 and 4

Event	PCE Equiv Vapor Emission (kg/y)
1	7.0×10^{-1}
2	1.2 ^a
3	5.7×10^{-2}
4	1.3×10^{-1}
Average	5.2×10^{-1}

a: For calculation of second event diffusion coefficients were used from the first field event. This was due to the site experiencing heavy rainfall follow sampling that did not allow for diffusion testing

Vapor Flux Calculation

$$Flux_{Vapor} = \sum_i D_i^{air} A_i \left(\frac{D_{He}^{eff}}{D_{He}^{air}} \right) \left(\frac{\Delta C_{v,i}}{\Delta z} \right) \psi_i^j$$

Where:

- D_i^{air} – Diffusion coefficient of compound i in air (cm²/s)
- D_{He}^{eff} – Measured effective helium diffusion coefficient (cm²/s)
- D_{He}^{air} – Diffusion coefficient of helium in air (cm²/s)
- $C_{v,i}$ – Concentration of compound i in vapor (µg/L)
- Z – Depth of sample (cm)
- ψ_i^j – Adjustment Factor for measured chemical i in terms of chemical j
- A_i - Impacted Area (cm²)

Diffusion Coefficients in Air (cm²/s)

He	VC	11 DCE	t-DCE	11 DCA	c - DCE	TCE	PCE
6.71E-1	1.06E-01	9.00E-02	7.07E-02	7.42E-02	7.36E-02	7.90E-02	7.20E-02

Adjustment Factors (ψ_i^j)

		PCE Equivalent (adjustment factor)					
		PCA	PCE	TCA	TCE	DCA	DCE
Measured	PCA	1.000	0.700	0.564	0.555	0.418	0.409
	PCE	1.428	1.000	0.804	0.792	0.597	0.585
	TCA	1.775	1.243	1.000	0.985	0.742	0.727
	TCE	1.802	1.262	1.015	1.000	0.753	0.738
	DCA	2.392	1.676	1.348	1.328	1.000	0.980
	DCE	2.442	1.711	1.376	1.355	1.021	1.000
	Chloroethane	3.670	2.570	2.068	2.037	1.534	1.503
	VC	3.788	2.653	2.135	2.102	1.583	1.551
	Ethane	7.873	5.515	4.436	4.369	3.291	3.224
	Ethene	8.440	5.912	4.756	4.684	3.528	3.456

Table 18

ML6 – 9ftbgs - LNAPL Carbon Range Distribution: Event 1: October 16-26, 2008

Range	Percentage	Cumulative Percentage
C1-C8	0.00%	0.00%
C8-C9	0.05%	0.05%
C9-C10	44.86%	44.92%
C10+	55.08%	100.00%

Chromatogram for direct injection of LNAPL from ML6 – 9ftbgs: Event 1: October 16-26, 2008

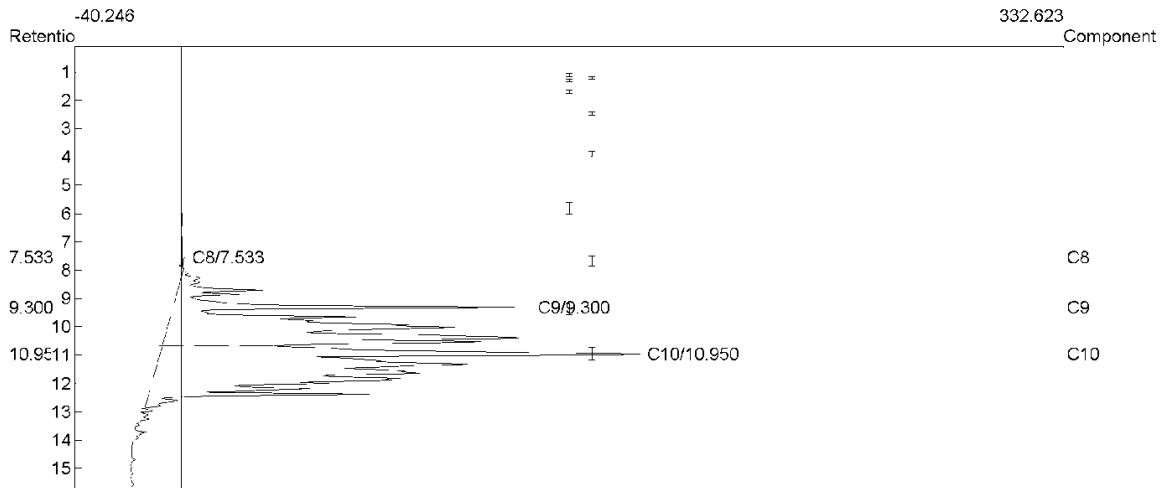

Component	Retention	Area	Height
C8	7.533	8.1540	1.010
C9	9.300	6874.5270	134.970
C10	10.950	8440.4940	180.940
		15323.1750	

Figures



Figure 1: Site Map - MCRD Parris Island SWMU45

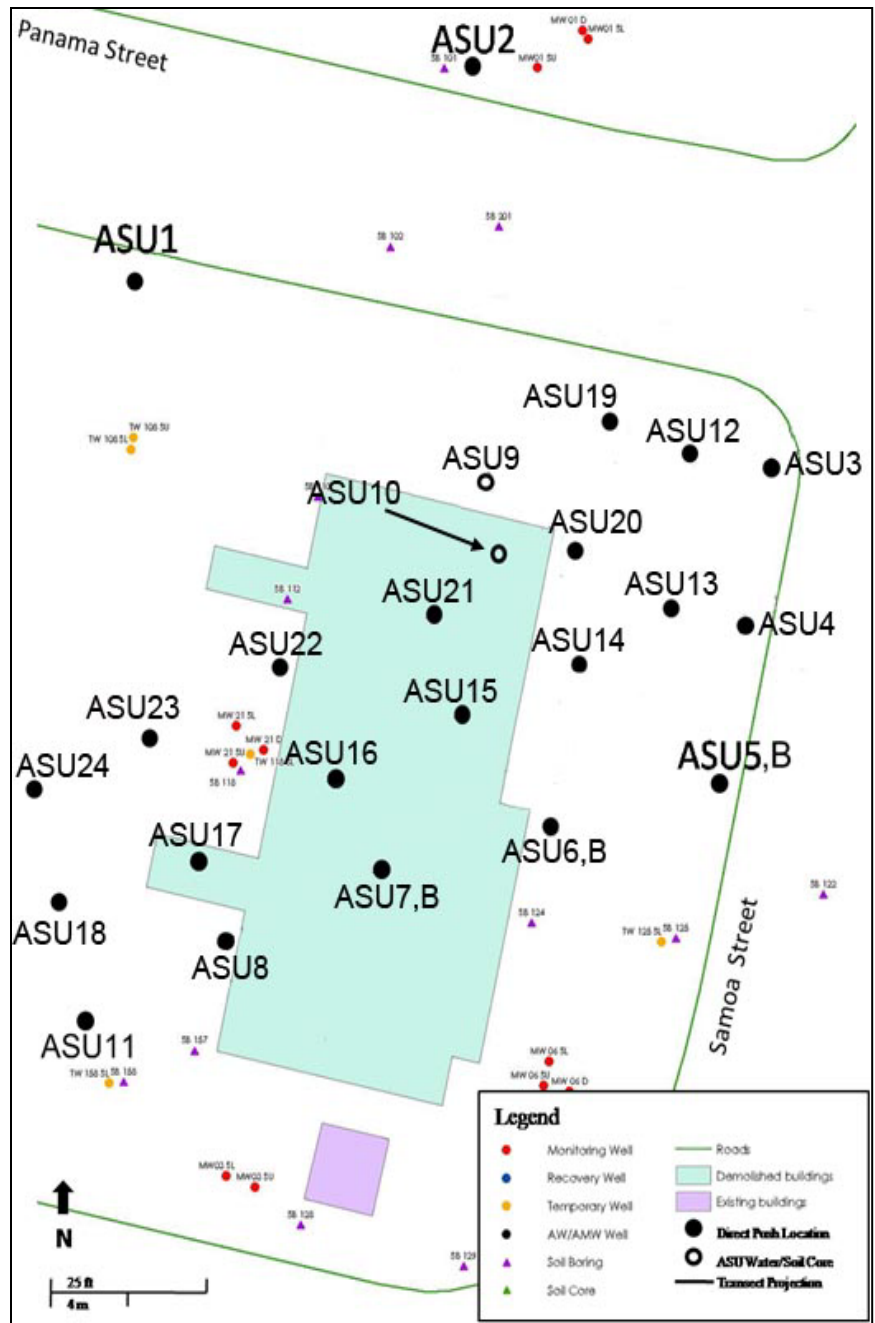

Figure 2: Direct Push Water/Soil Sampling Locations

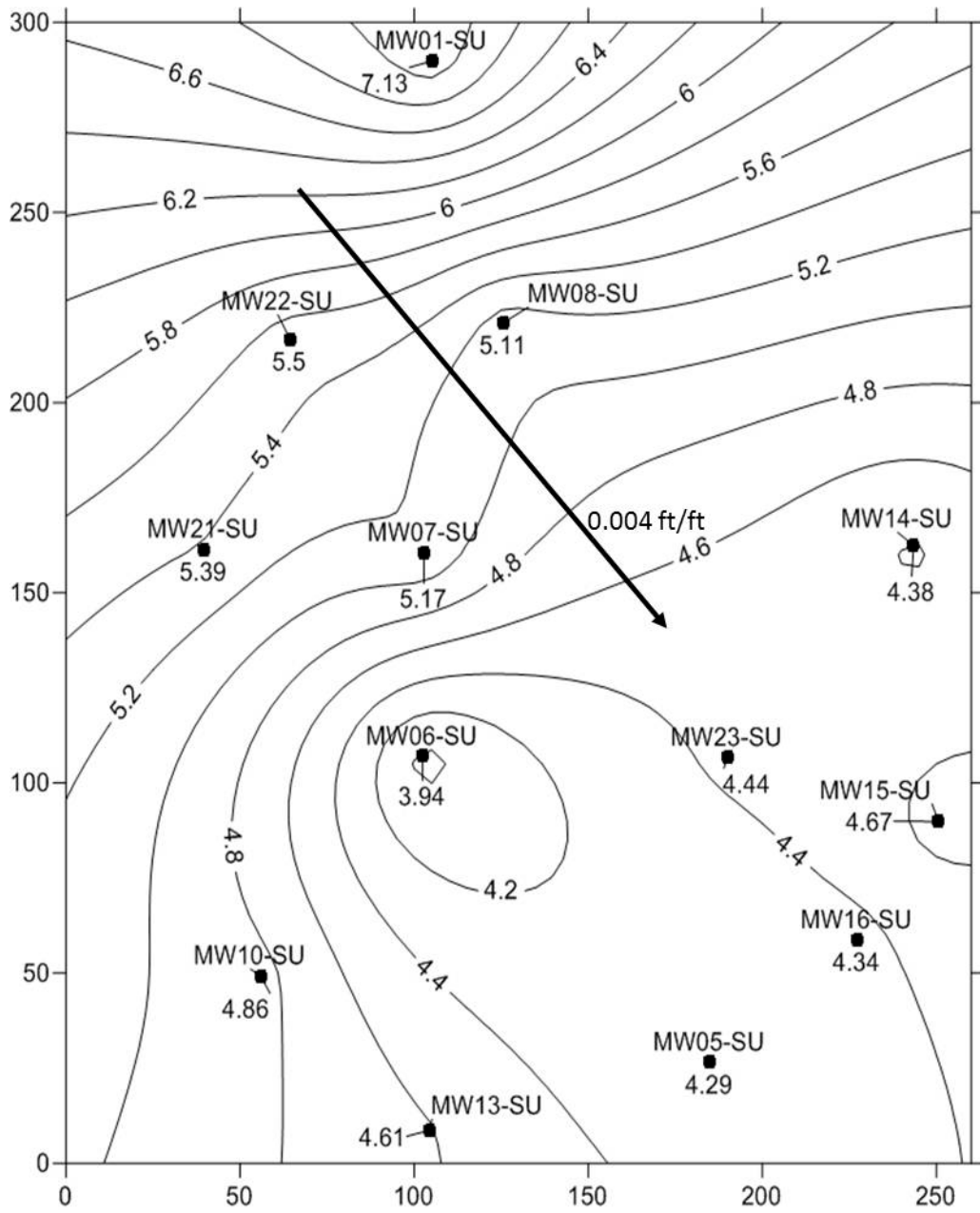

Figure 3A: Groundwater Contour Map: Upper Surficial Aquifer: Event 1

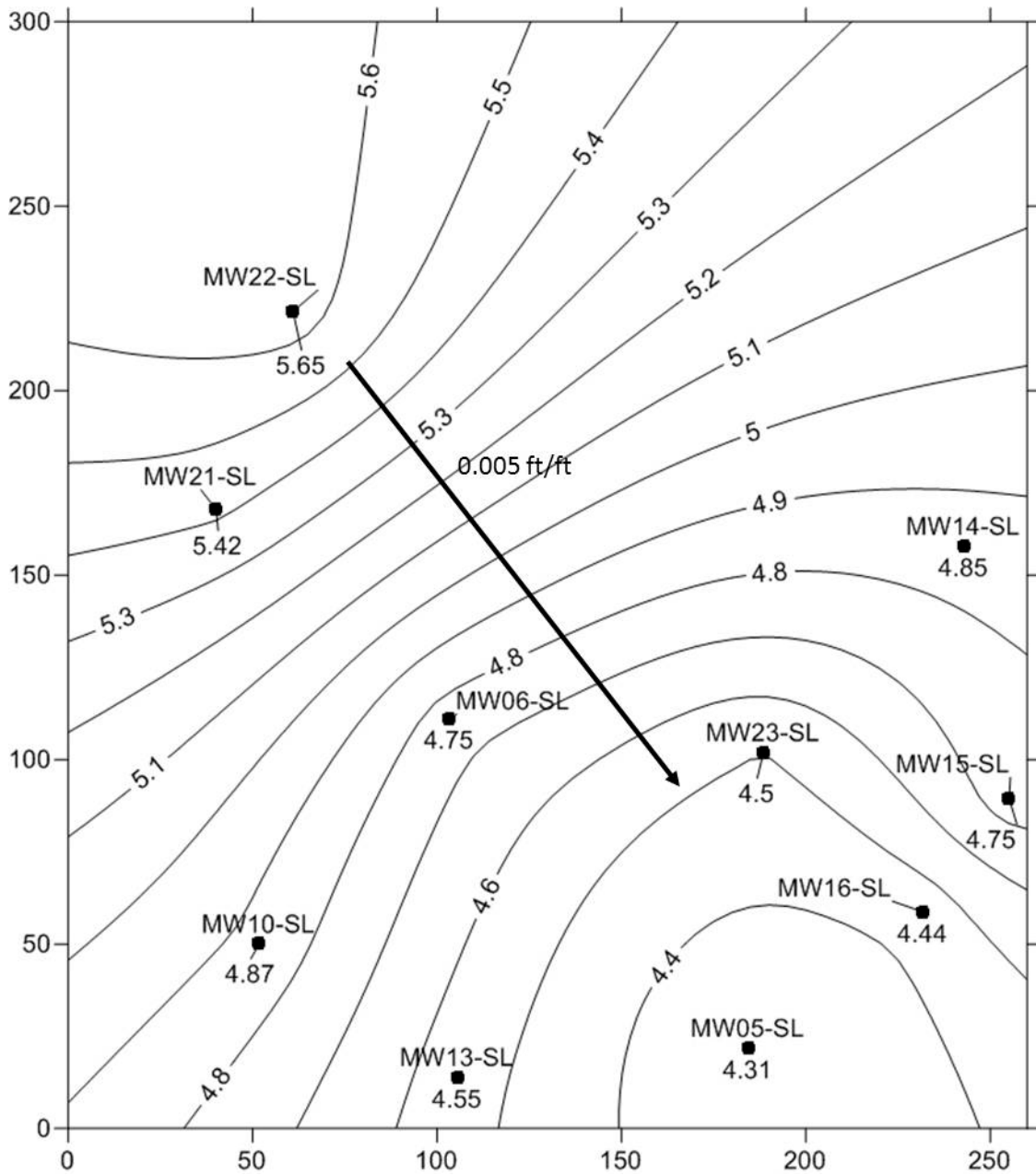

Figure 3B: Groundwater Contour Map: Lower Surficial Aquifer: Event 1

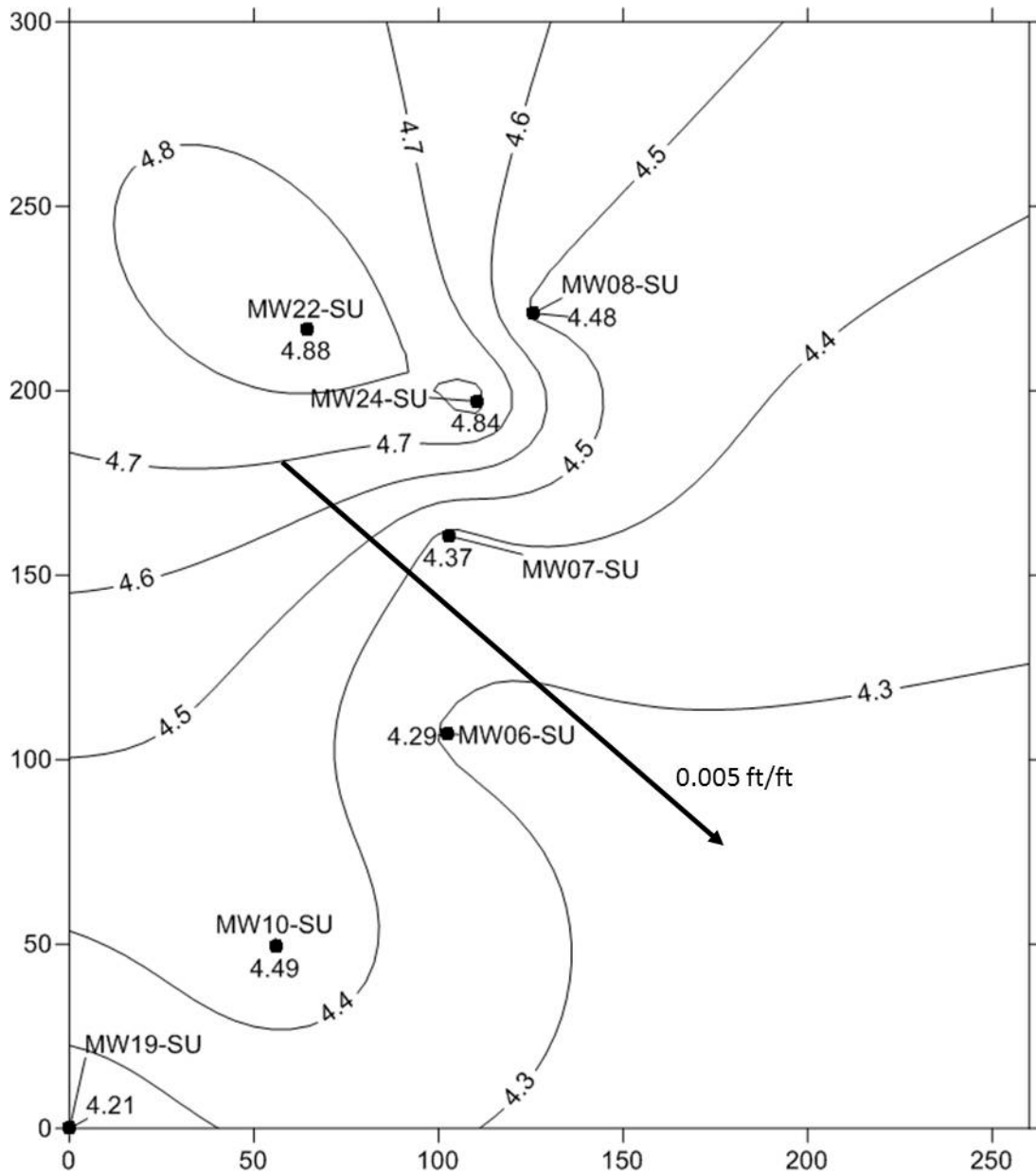

Figure 3C: Groundwater Contour Map: Upper Surficial Aquifer: Event 2

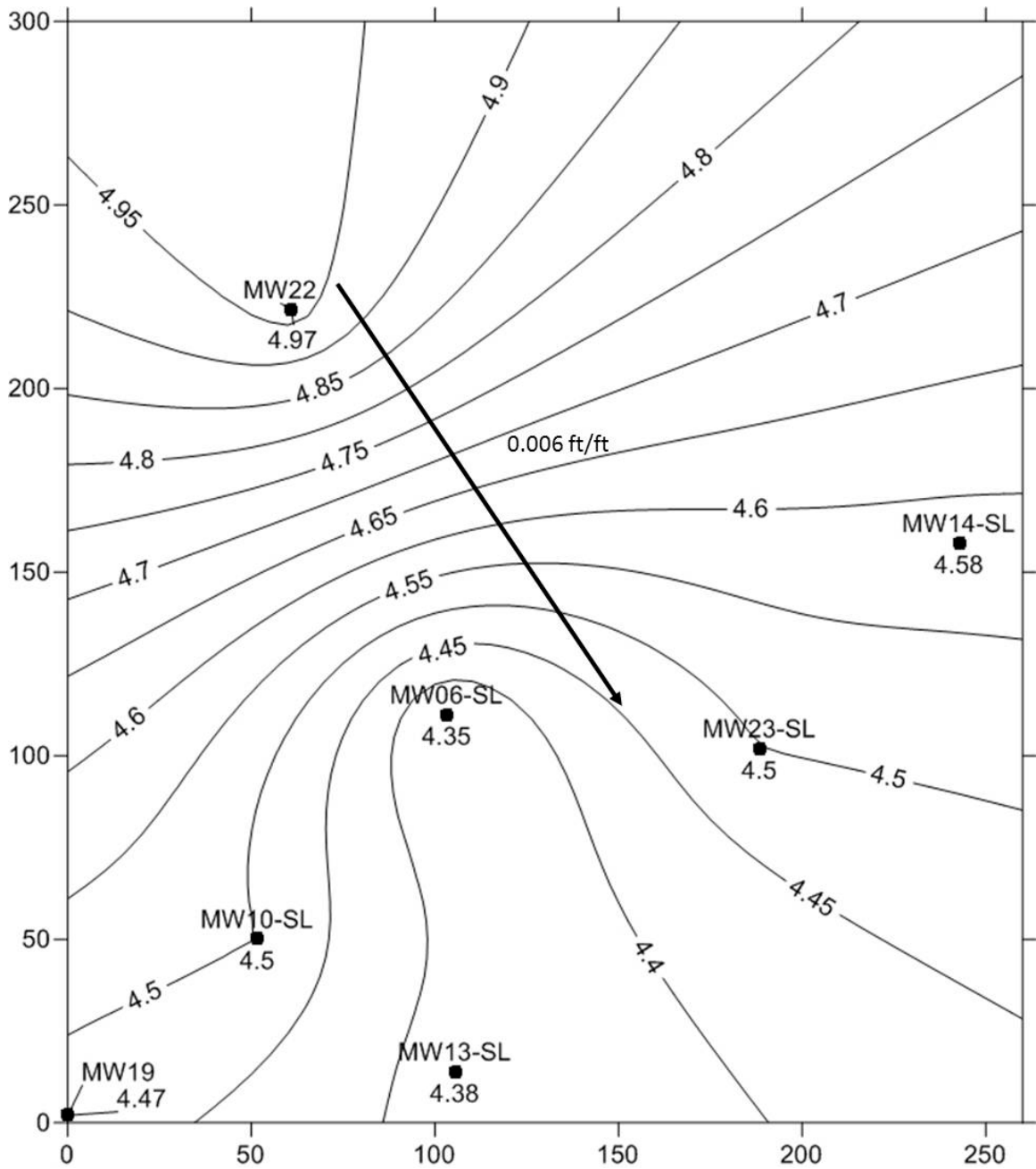

Figure 3D: Groundwater Contour Map: Lower Surficial Aquifer: Event 2

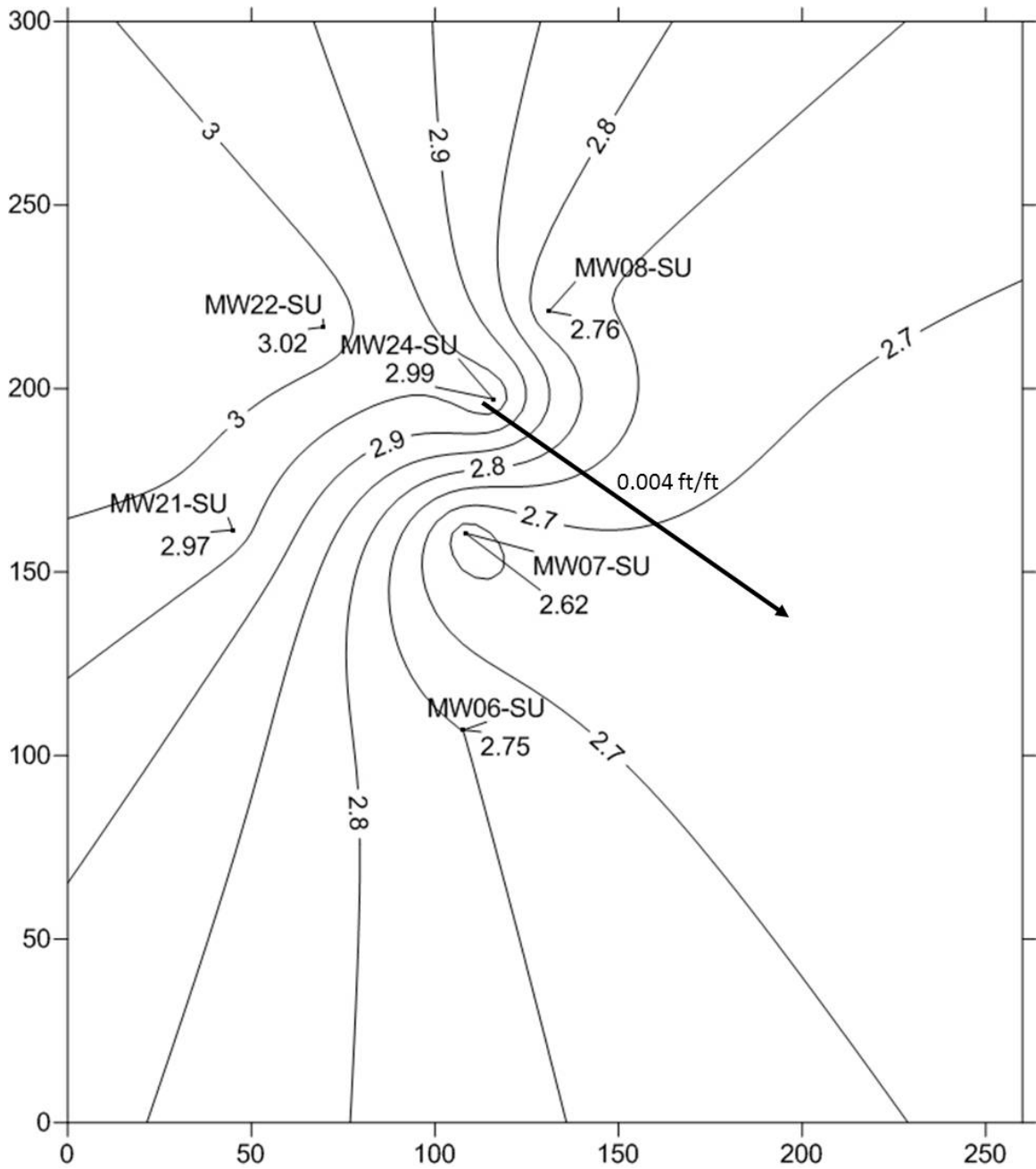

Figure 3E: Groundwater Contour Map: Upper Surficial Aquifer: Event 3

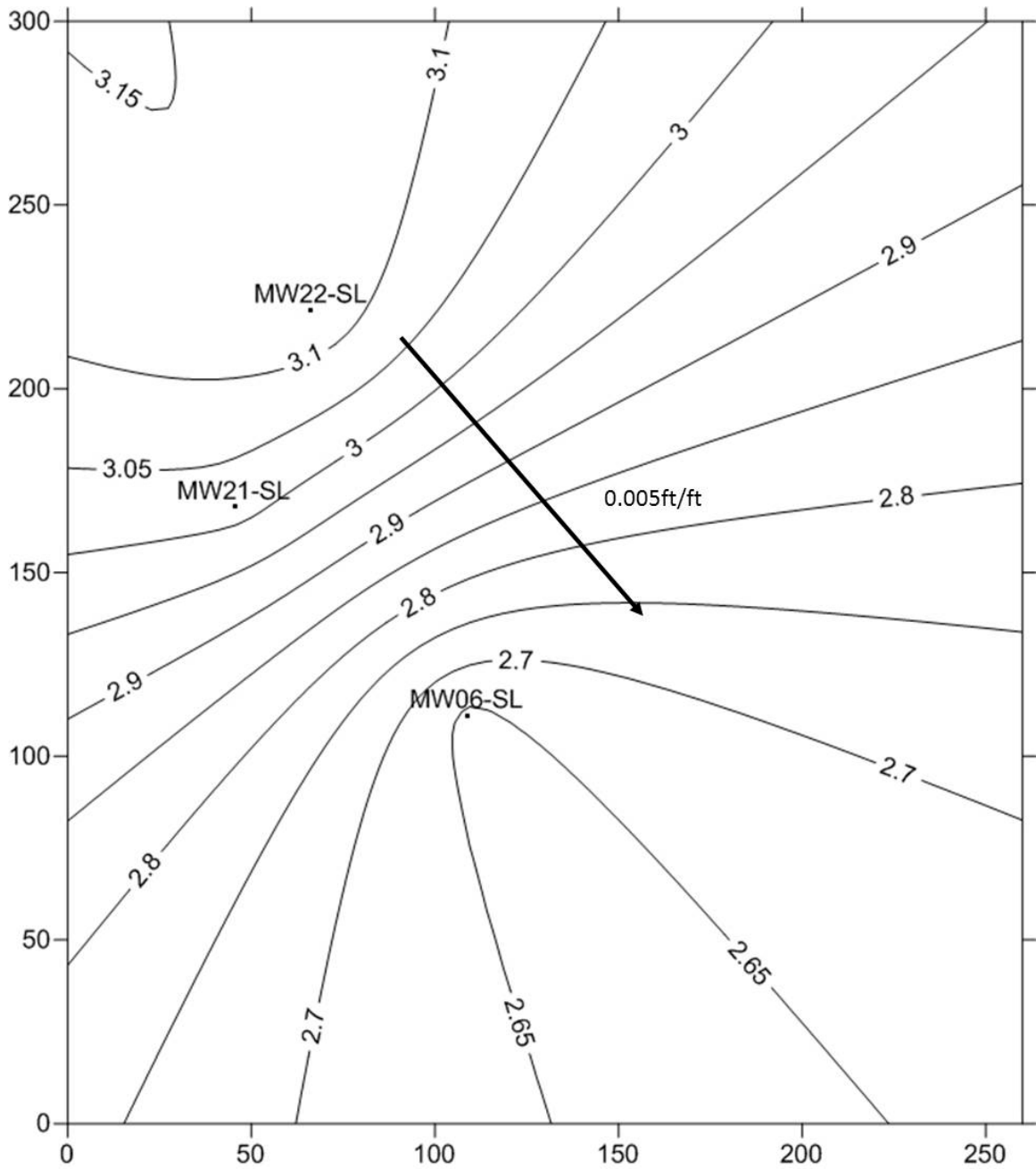

Figure 3F: Groundwater Contour Map: Lower Surficial Aquifer: Event 3

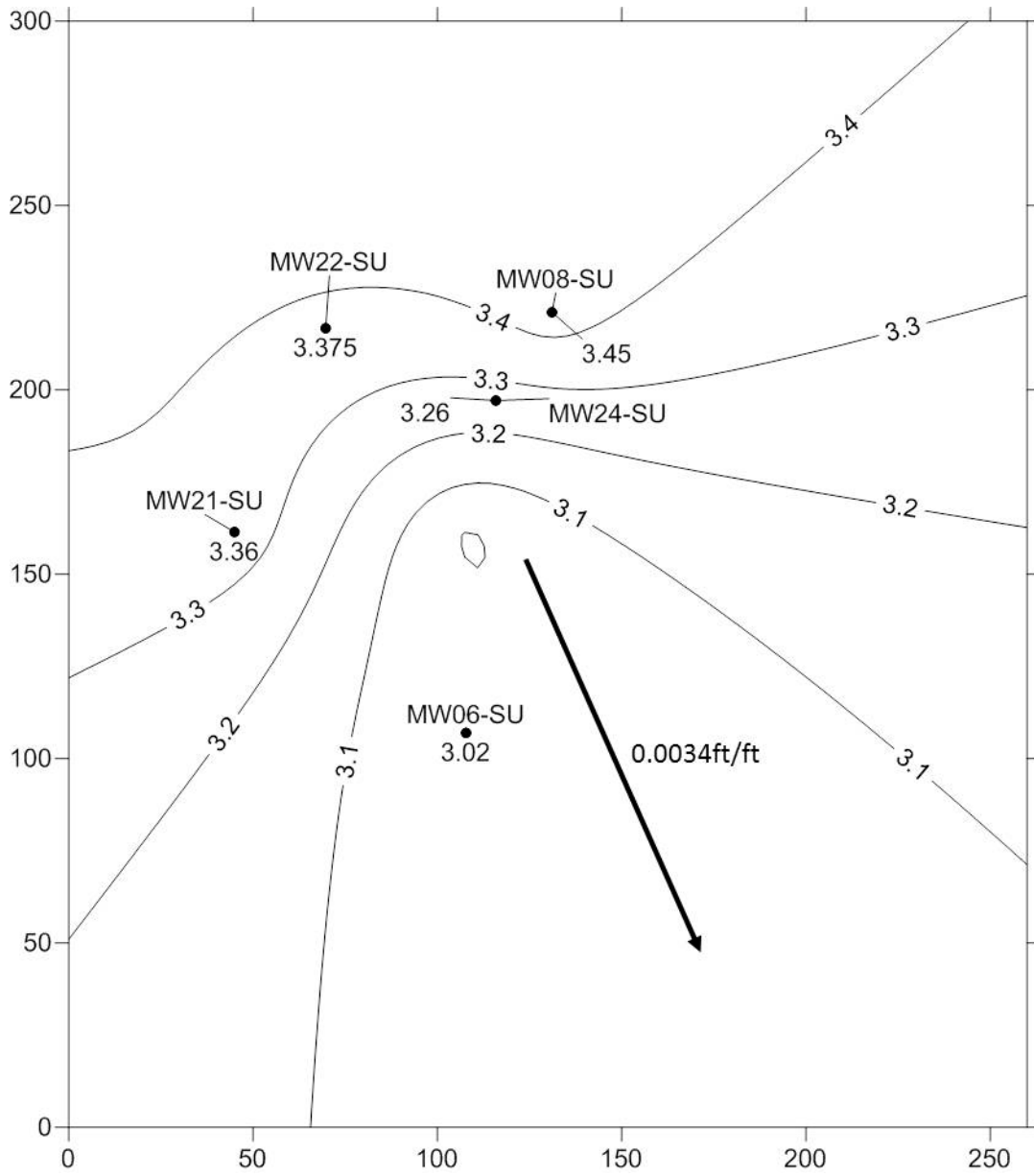

Figure 3G: Groundwater Contour Map: Upper Surficial Aquifer: Event 4

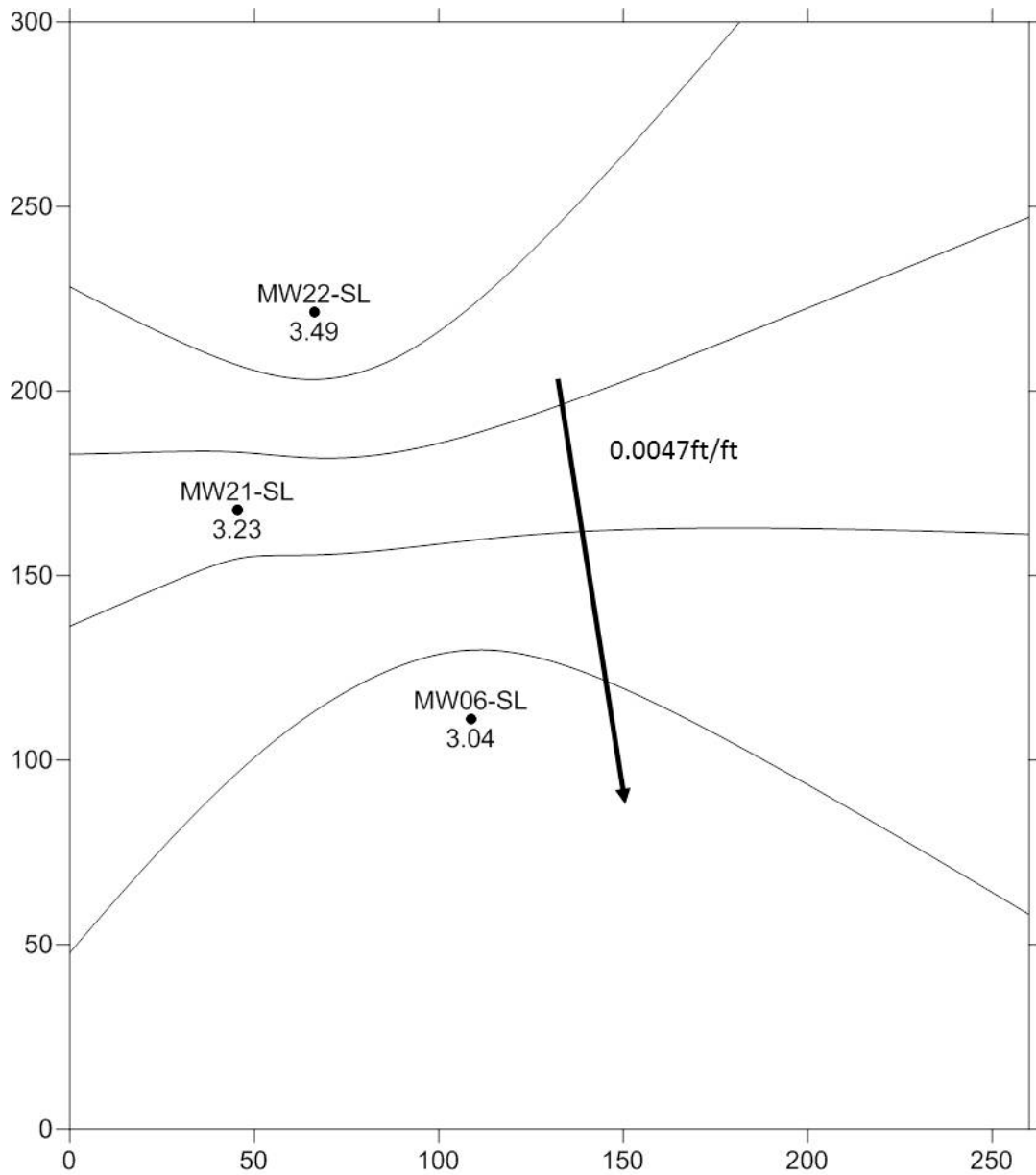

Figure 3H: Groundwater Contour Map: Lower Surficial Aquifer: Event 4

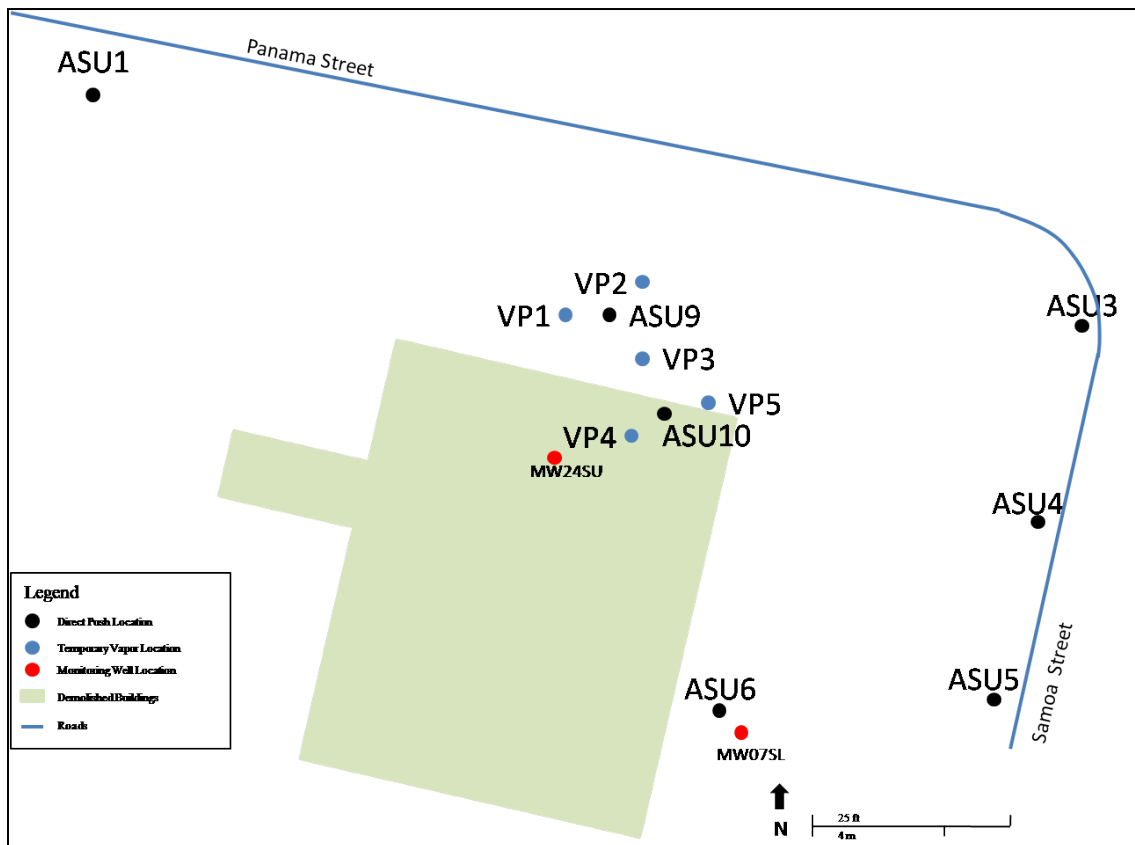

Figure 4A: Vapor Sampling Locations – Event 1 & 2

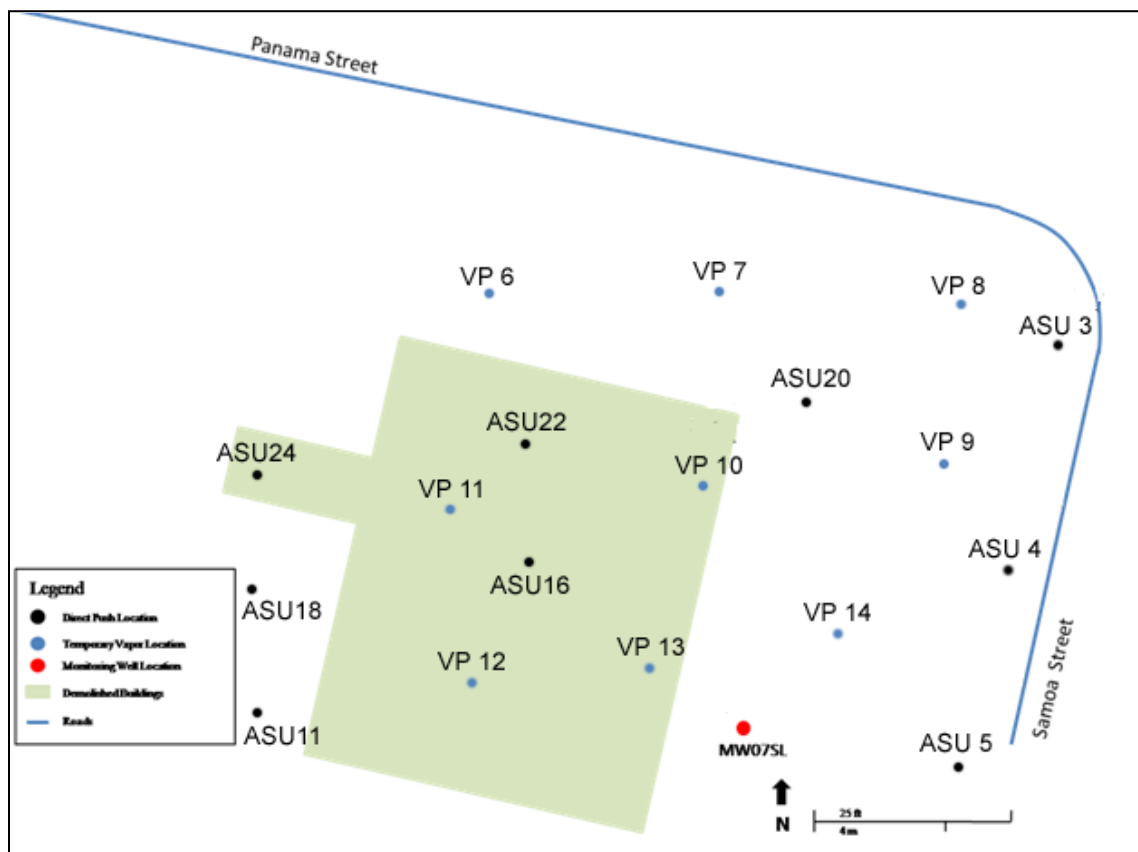

Figure 4B: Vapor Sampling Locations – Event 3

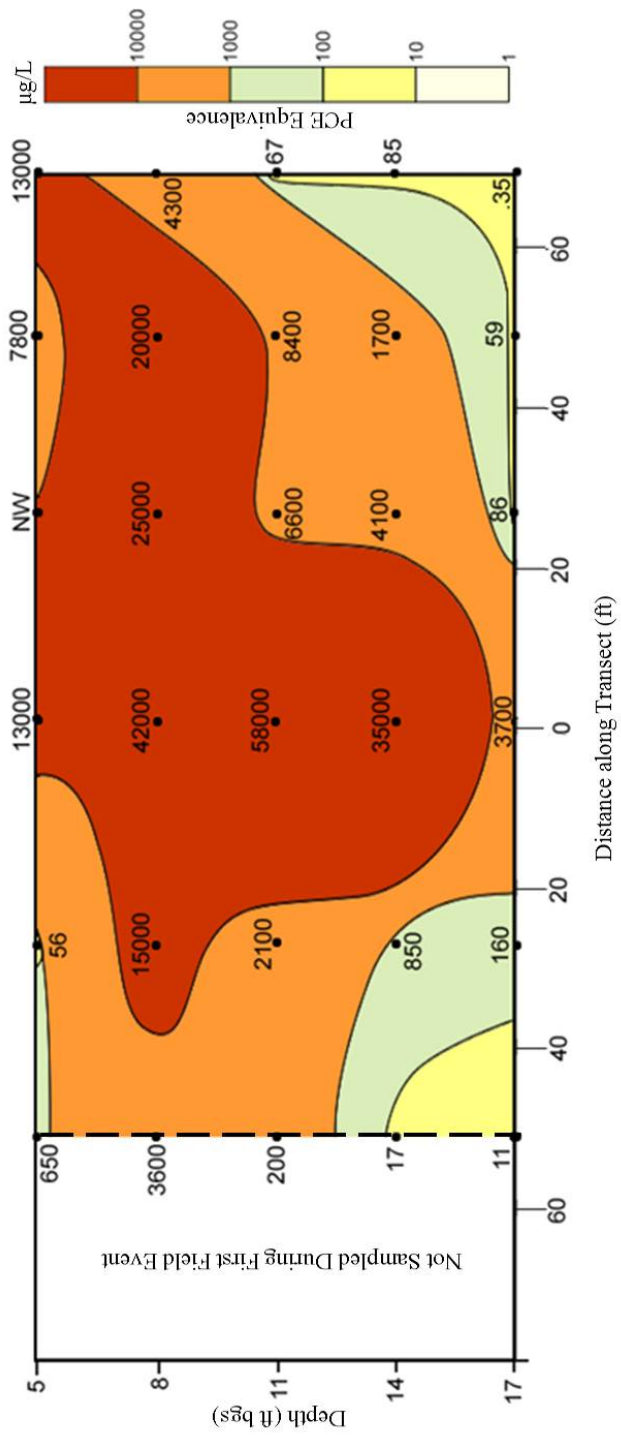

Figure 5A: Groundwater Concentration Vertical Contour Plot Transect A-A': Event 1: October 16–26, 2008

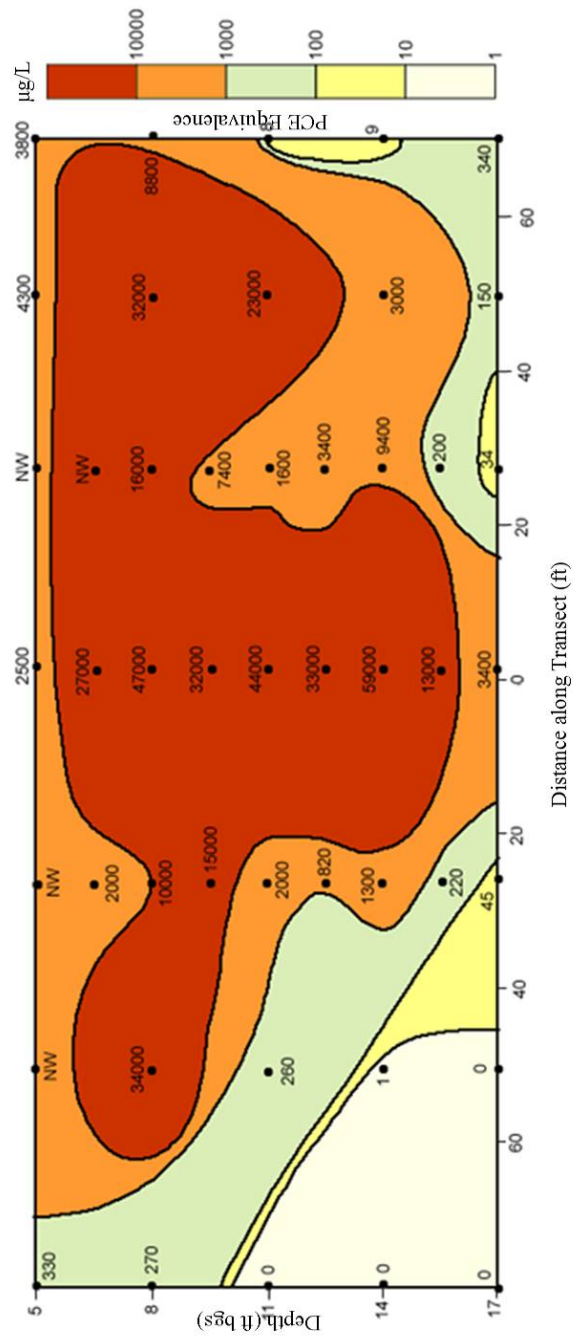

Figure 5B: Groundwater Concentration Vertical Contour Plot Transect A-A': Event 2: August 15-22, 2009

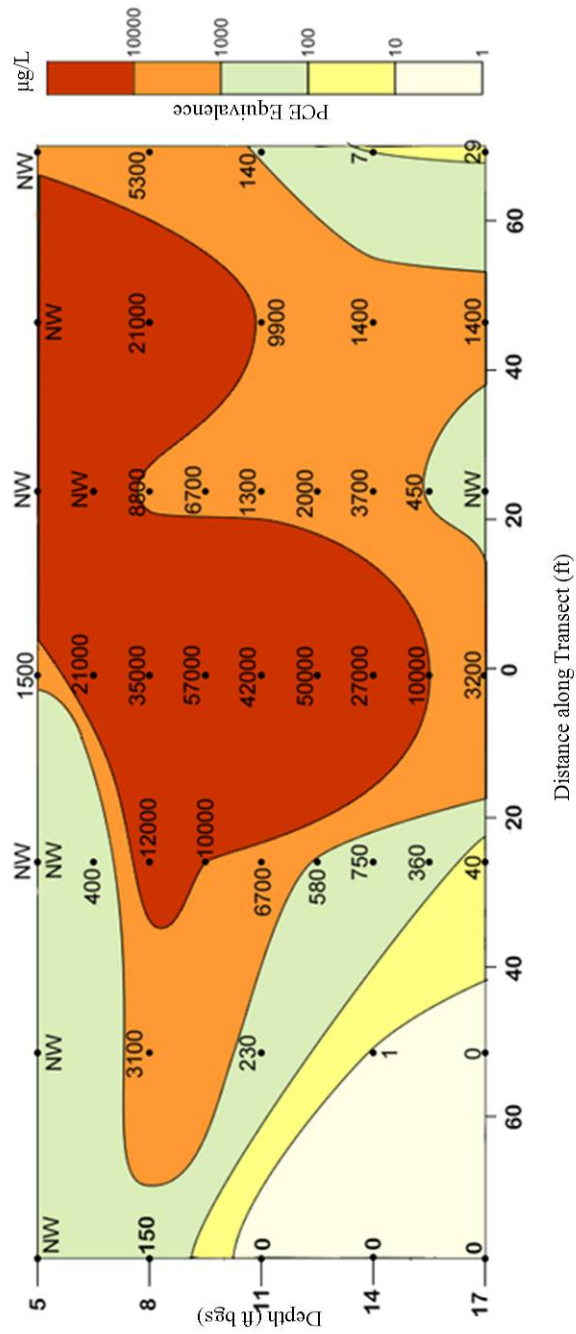

Figure 5C: Groundwater Concentration Vertical Contour Plot Transect A-A': Event 3: July 5-19, 2010

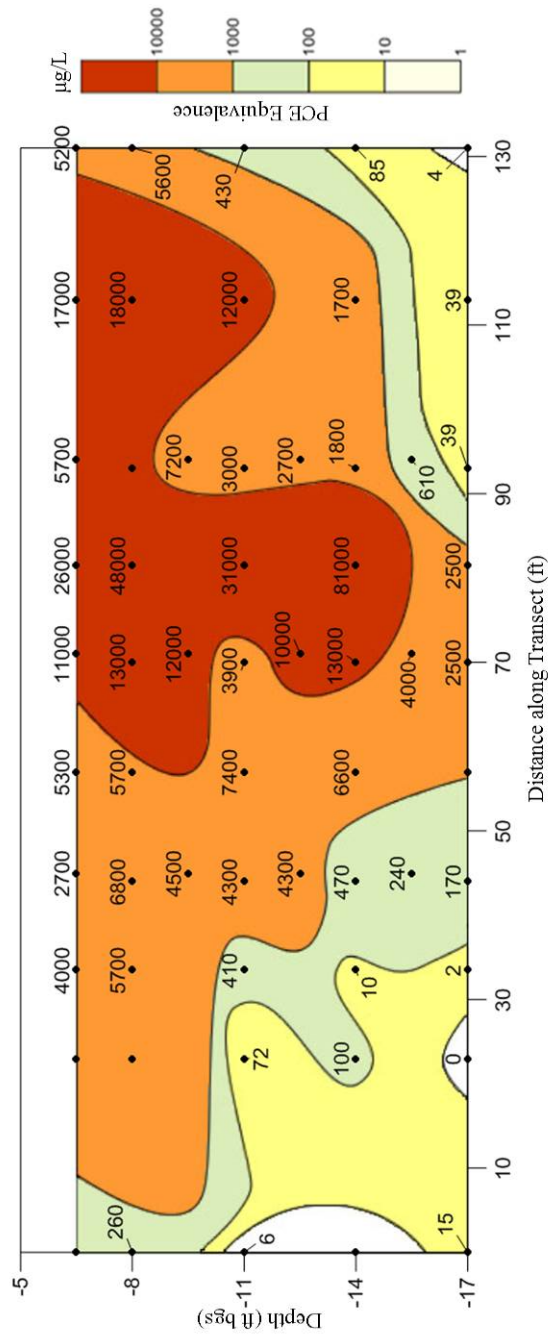

Figure 5D: Groundwater Concentration Vertical Contour Plot Transect A-A': Event 4: June 14-25, 2011

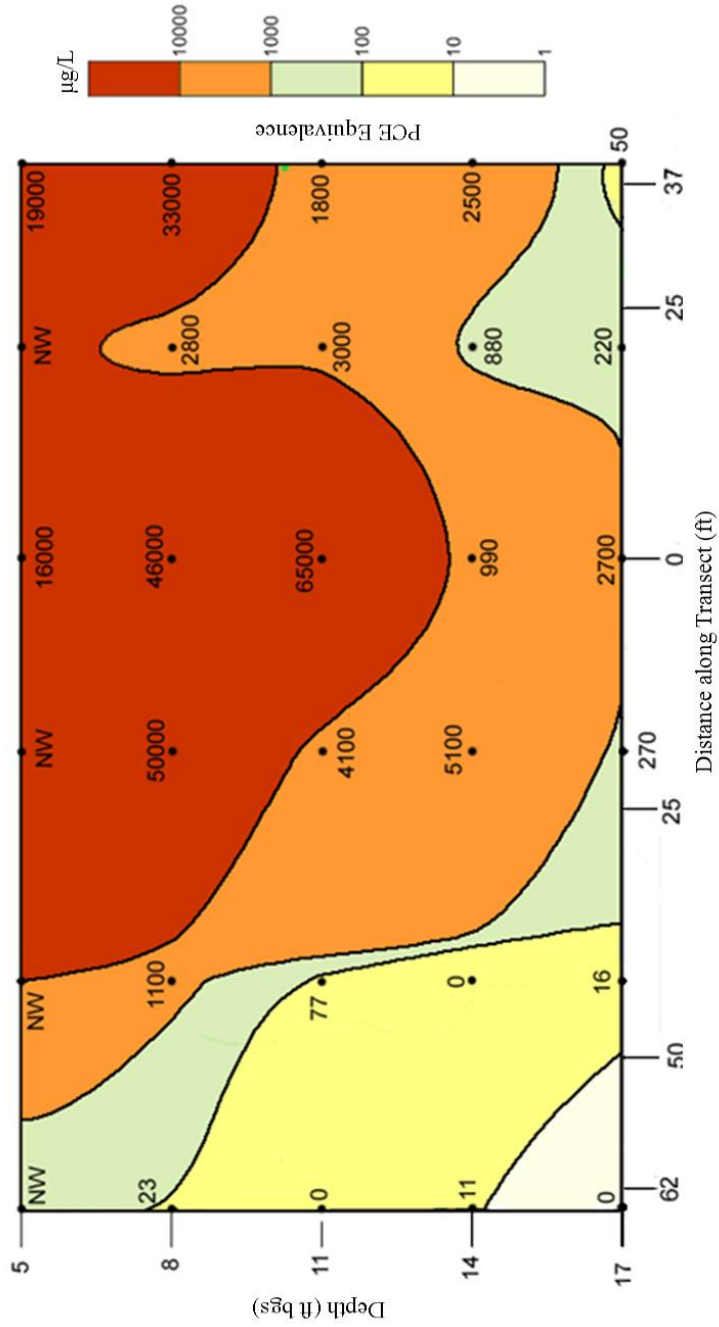

Figure 7: Groundwater Concentration Vertical Contour Plot Transect C-C': Event 3: July 5-19, 2010

Input Data and Grid

Site Location and I.D.: Parris Island
Description:

4. CHOOSE TRANSECT Transect 1 3

5. CHOOSE TIME PERIOD 3

6. ENTER TRANSECT DATA
 6.1 Distance of Transect 1 from Source 40 (ft)
 6.2 Darcy Velocity Hydraulic Conductivity
 6.3 Hydraulic Conductivity Units cm/sec
 6.4 Uniform Hydraulic Conductivity? No
 6.5 Uniform Hydraulic Gradient? No

Data Input Instructions
 Enter value directly.
 Value calculated by model
 (Don't enter any data)

Monitoring Point	Distance of Monitoring Point from Start of Transect (ft)	Mid Point of Sampling Interval (ft bgs)	Plume Top (ft bgs)	Plume Bottom (ft bgs)	Hydraulic Conductivity (cm/sec)	Hydraulic Gradient (cm/cm)	Concentration (ug/L)	
							Constituent A	Constituent B
1	0						Equivalence	
2	150						0	0
3	149.2765	5	5	18	0.0037	0.0037	0	0
4	149.2765	8	5	18	0.0013	0.0037	5300	
5	149.2765	11	5	18	0.019	0.0045	140	
6	149.2765	14	5	18	0.00029	0.0045	77	
7	149.2765	17	5	18	0.000023	0.0045	29	
8	126.4262	5	5	18	0.0037	0.0037		
9	126.4262	8	5	18	0.0016	0.0037	21000	
10	126.4262	11	5	18	0.00039	0.0045	9900	
11	126.4262	14	5	18	0.00017	0.0045	1400	
12	126.4262	17	5	18	0.00024	0.0045	1400	
13	103.73	5	5	18	0.0037	0.0037		
14	103.73	8	5	18	0.00019	0.0037	8800	
15	103.73	11	5	18	0.00041	0.0045	1300	

7. CHOOSE GRID (OPTIONAL) Current Grid: 10 Refined Grid: 20
 Number of rows: 8 Number of columns: 15

8. SELECT CONSTITUENT FOR CALCULATIONS
 Equivalence Constituent B

Next Step: Continue Data Input

Back to Transect Calculator Screen

Clear Screen

Export MW Data

Import MW Data

See Conci/Flux Grids

Paste Example

Restore Table Formatting

Print

HELP

Figure 8: Mass Flux Calculation – Input Example: Transect A-A’ Event 3: July 5-19, 2010

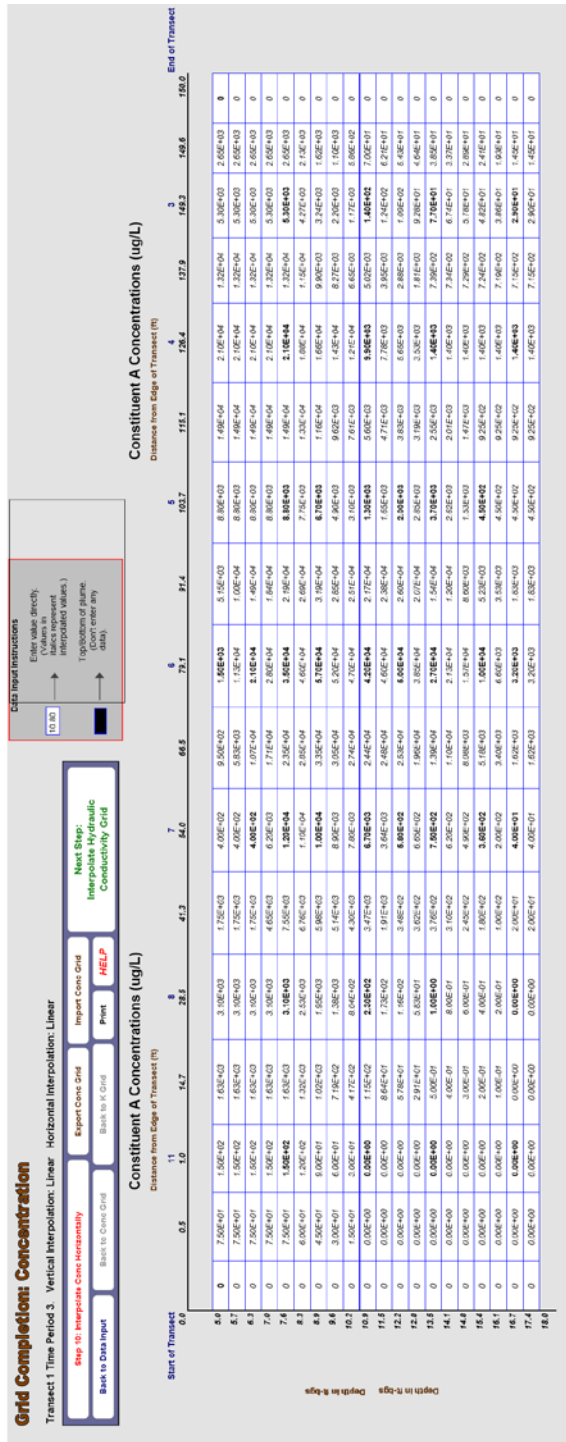

Figure 9: Mass Flux Calculation – Output Example: Linear Interpolated Concentration Profile Transect A-A’: Event 3 – July 5-19, 2010

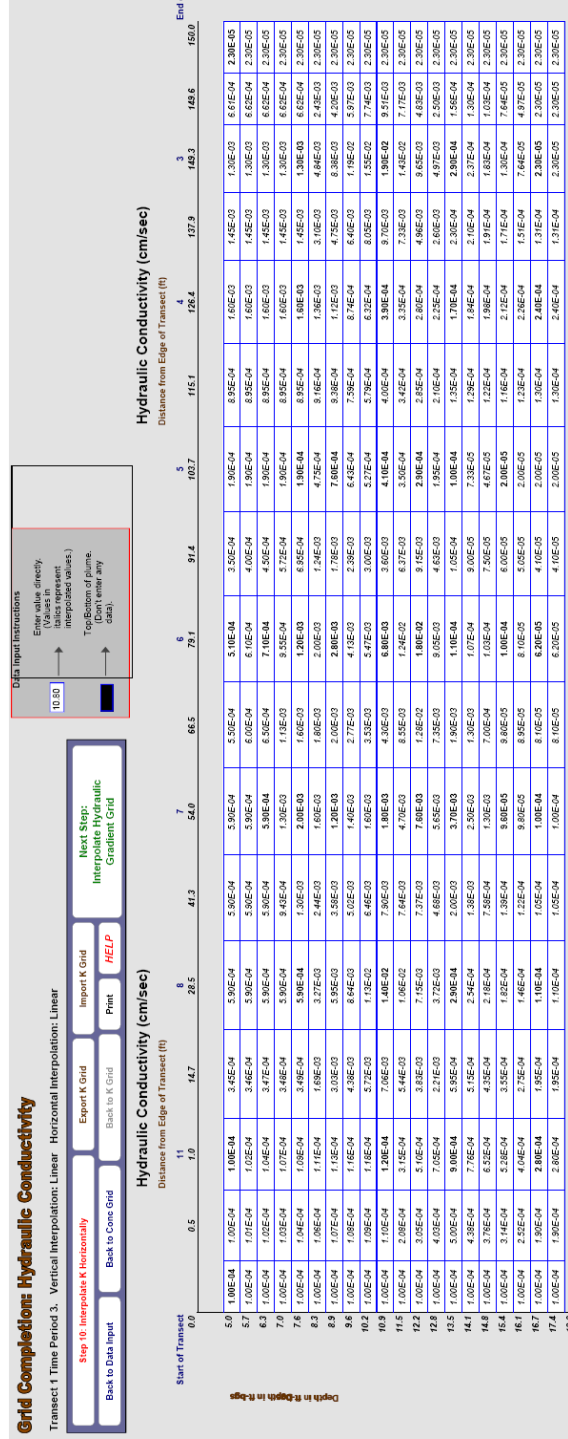

Figure 10: Mass Flux Calculation – Output Example: Linear Interpolated Hydraulic Conductivity Profile Transect A-A’: Event 3 – July 5-19, 2010

		Concentration			Mass Flux
		Linear	Log	NN	PCE Equivalents (kg/y)
Conductivity	Linear	x			9.7×10^{-1}
			x		7.7×10^{-1}
				x	9.7×10^{-1}
	Log	x			8.8×10^{-1}
			x		7.0×10^{-1}
				x	8.7×10^{-1}
	NN	x			9.7×10^{-1}
			x		7.7×10^{-1}
				x	9.7×10^{-1}
	Average				8.7×10^{-1}

Figure 12A: Mass Flux Calculation Transect A-A'– Interpolation Combinations: Event 1: October 16 – 26, 2008

		Concentration			Mass Flux	
		Linear	Log	NN	PCE Equivalents (kg/y)	
Conductivity	Linear	x			1.6	
			x		1.2	
				x	1.6	
	Log	x			1.4	
			x		1.1	
				x	1.4	
	NN	x			1.6	
			x		1.2	
				x	1.6	
	Average					1.4

Figure 12B: Mass Flux Calculation Transect A-A' – Interpolation Combinations: Event 2: Aug 15-22, 2009

		Concentration			Mass Flux
		Linear	Log	NN	PCE Equivalents (kg/y)
Conductivity	Linear	x			1.2
			x		9.2×10^{-1}
				x	1.2
	Log	x			1.2
			x		9.2×10^{-1}
				x	1.2
	NN	x			1.2
			x		9.2×10^{-1}
				x	1.2
	Average				1.1

Figure 12C: Mass Flux Calculation Transect A-A' – Interpolation Combinations: Event 3: July - 19, 2010

		Concentration			Mass Flux
		Linear	Log	NN	PCE Equivalents (kg/y)
Conductivity	Linear	x			5.2×10^{-1}
			x		3.7×10^{-1}
				x	5.4×10^{-1}
	Log	x			4.3×10^{-1}
			x		3.2×10^{-1}
				x	4.4×10^{-1}
	NN	x			5.4×10^{-1}
			x		4.4×10^{-1}
				x	5.6×10^{-1}
	Average				4.6×10^{-1}

Figure 12D: Mass Flux Calculation Transect B-B' – Interpolation Combinations: Event 3: July - 19, 2010

		Concentration			Mass Flux
		Linear	Log	NN	PCE Equivalents (kg/y)
Conductivity	Linear	x			5.1×10^{-1}
			x		3.2×10^{-1}
				x	5.0×10^{-1}
	Log	x			3.5×10^{-1}
			x		2.4×10^{-1}
				x	3.4×10^{-1}
	NN	x			4.9×10^{-1}
			x		3.1×10^{-1}
				x	4.4×10^{-1}
	Average				3.9×10^{-1}

Figure 12E: Mass Flux Calculation Transect C-C' – Interpolation Combinations: Event 3: July 5-19, 2010

		Concentration			Mass Flux
		Linear	Log	NN	PCE Equivalents (kg/y)
Conductivity	Linear	x			1.1
			x		8.9×10^{-1}
				x	1.1
	Log	x			8.4×10^{-1}
			x		7.0×10^{-1}
				x	7.9×10^{-1}
	NN	x			1.2
			x		9.1×10^{-1}
				x	1.1
	Average				9.6×10^{-1}

Figure 12F: Mass Flux Calculation Transect A-A' – Interpolation Combinations: Event 4: June 14-20, 2011

APPENDIX D: SITE 3 LMTA HILL AIR FORCE BASE



Final Data Analysis Report LMTA Hill AFB

**Sludge Drying Beds Site, Operable Unit A
Little Mountain Test Annex, Hill Air Force Base, Utah**

**ESTCP Project ER-0705:
Assessment of the Natural Attenuation of NAPL Source
Zones and Post-Treatment NAPL Source Zones**

May 2012

Tables

Table 1	Sampling Locations and Analyses Performed: Event 4 – August 23, 2011
Table 2A	Depth-to-Groundwater, Groundwater Elevation, and Field Water Quality Parameters: Event 1 – July-Aug 2008
Table 2B	Depth-to-Groundwater, Groundwater Elevation, and Field Water Quality Parameters: Event 2 – April – May 2009
Table 2C	Depth-to-Groundwater, Groundwater Elevation, and Field Water Quality Parameters: Event 3 – September 2010
Table 2D	Depth-to-Groundwater, Groundwater Elevation, and Field Water Quality Parameters: Event 4 – August 23, 2011
Table 3A	Hydraulic Conductivity – Slug Test Results: Event 2 – May 11-14, 2009
Table 3B	Hydraulic Conductivity – Slug Test Results: Event 3– September 2010
Table 4A	General Water Chemistry Data: Event 1 – July-Aug 2008
Table 4B	General Water Chemistry Data: Event 2 – Apr-May 2009
Table 4C	General Water Chemistry Data: Event 3 –September 2010
Table 4D	General Water Chemistry Data: Event 4 – August 23, 2011
Table 5A	VOC Groundwater Concentration Data: Event 1 – July-Aug 2008
Table 5B	VOC Groundwater Concentration Data: Event 2 – Apr-May 2009
Table 5C	VOC Groundwater Concentration Data: Event 3 – September 2010
Table 5D	VOC Groundwater Concentration Data: Event 4 – August 23, 2011
Table 6A	CAH Vapor Concentration Data: Event 1 – July 30, 2008
Table 6B	CAH Vapor Concentration Data: Event 2 – Apr-May 2009
Table 6C	CAH Vapor Concentration Data: Event 3 – September 2010
Table 7A	In Situ Effective Diffusion Coefficient Measurement Results: Event 1 – July

30, 2008

Table 7B In Situ Effective Diffusion Coefficient Measurement Results: Event 2 –
May 14, 2009

Table 7C In Situ Effective Diffusion Coefficient Measurement Results: Event 2 –
September 2010

Table 8A Calculated Vapor Emission Mass Loss Rates: Event 1 – July 30, 2009

Table 8B Calculated Vapor Emission Mass Loss Rates: Event 2 – May 14, 2009

Table 8C Calculated Vapor Emission Mass Loss Rates: Event 3 – September 2010

Table 9 Dehalococcoides Testing: Event 2 Apr – May 2009

Figures

Figure 1	Little Mountain Location
Figure 2	Monitoring Well Locations
Figure 3	Groundwater Contour Map – April 10, 2009
Figure 4	Vapor Sampling Locations - Sludge Drying Beds
Figure 5A	Vertical Groundwater Concentration Contour Plot Along Transect A-A': Event 1 – July-Aug 2008
Figure 5B	Vertical Groundwater Concentration Contour Plot Along Transect A-A': Event 2 – Apr-May 2009
Figure 5C	Vertical Groundwater Concentration Contour Plot Along Transect A-A': Event 3 – September 2010
Figure 5D	Vertical Groundwater Concentration Contour Plot Along Transect A-A': Event 4 – August 23, 2011
Figure 6	Mass Flux Input Example: Event 1 – July-Aug 2008
Figure 7	Mass Flux Nearest-Neighbor Interpolated Concentration Profile Example: Event 1 – July-Aug 2008
Figure 8	Nearest-Neighbor Interpolated Hydraulic Conductivity Profile Example
Figure 9	Mass Flux Calculation: Event 1 – July-Aug 2008
Figure 10A	Uncertainty Analysis: Event 1 – July-Aug 2008
Figure 10B	Uncertainty Analysis: Event 2 – Apr-May 2009
Figure 10C	Uncertainty Analysis: Event 3 – September 2010
Figure 10D	Uncertainty Analysis: Event 4 – August 23, 2011

Acronyms and Abbreviations

amsl	Above mean sea level
bgs	Below ground Surface
btoc	Below top of casing
CAH	Chlorinated aliphatic hydrocarbons
COD	Chemical oxygen demand
DCA	Dichloroethane
DCE	Dichloroethylene
DELCD	Dry electrolytic conductivity detector
Dhc	Dehalococcoides
DO	Dissolved oxygen
DOC	Dissolved organic carbon
DTW	Depth to water
EC	Electrical conductivity
ERH	Electrical resistance heating
ESTCP	Environmental Security Technology Certification Program
FID	Flame-ionization detector
ft	Feet
GC	Gas chromatograph
kg	Kilogram
ND	Non-detect
ORP	Oxidation reduction potential
PCE	Perchloroethylene
PCR	Polymerase chain reaction

PQL	Practical quantitation limit
sqft	Square feet
TCA	Trichloroethane
TCE	Trichloroethylene
TOC	Top of casing
temp	Temperature
VC	Vinyl chloride
VOA	Volatile organic analysis
y	Year

1. Introduction

Four field sampling investigations for the Sludge Drying Beds Site, Operable Unit A, Little Mountain Test Annex, Hill Air Force Base, Utah (herein referred to as the LMTA Site) under Environmental Security Technology Certification Program (ESTCP) project ER-0705, *Assessment of the Natural Attenuation of NAPL Source Zones and Post-Treatment NAPL Source Zones*, have been performed. The first two events leveraged the work of on-site consultants and utilized conventionally purged sampling wells. These two events took place on July-August 2008, and April-May 2009. The final two events were performed by the ASU team using no-purge sampling methods detailed in the Field Investigations section. These two events were performed on September 12-17, 2010 and August 23, 2011. Figures 1 and 2 provide site maps that identify the specific area of interest for this field investigation.

Consistent with the objectives set forth under the ER-0705 Demonstration Plan, the field investigation at this site focused on collection of groundwater samples, vapor samples, and other site characterization data needed to assess the mass loss rate from the source zone at this site.

2. Field Investigations

Site characteristics for the Hill AFB Sludge Drying Bed Site (SDB) are atypical in comparison to most sites. Depths to water in excess of 150 ft, well constructions requiring large purge volumes, and steep terrain with rock outcrops are some of the features that make this site challenging for field investigations. As a result, the first two field events at this site were timed to coincide with scheduled sampling by Parsons (the site contractor), leveraging their activities for collection of designated transect samples. Regular sampling activities at the site by Parsons have, however, stopped following the second field event detailed in this report. As a result an alternative less-costly sampling method was used by ASU to sample the site; this a no-purge sampling method (Hydrasleeve) has the advantages of minimal waste disposal and shorter sampling times.

The new sampling procedure involves a Hydrasleeve® sampler (a special bailer design) that is weighted and placed into the screened interval of the well at a desired depth. Approximately 24 h are allowed for sampler deployment to allow the water column to re-equilibrate and then the sampler is opened and extracted from the well. A more thorough description of the sampling method can be found in Appendix A.

In accordance with the approved generic demonstration plan for this project, the following site-specific activities were conducted:

2.1 Collection of site hydrogeological information:

- a. Depth-to-water: Depth-to-water (DTW) measurements were collected by ASU during all site events. Table 1 identifies those monitoring wells utilized in this study and their locations are shown in Figure 2. Table 2 provides DTW measurements and corresponding groundwater elevations at the time of sample collection for monitoring wells listed in Table 1.

Information regarding flow direction and gradient were initially obtained from the 2008 remedial investigation report (Parsons 2008), but were updated with the data collected during this previous sampling events. Figure 3 provides a groundwater contour plot from DTW water data collected throughout the course of this investigation. This map indicates that the flow direction is consistent with the dissolved phase contaminant distribution. The hydraulic gradient in the vicinity of the source zone within the calcareous phyllite layer is estimated from the data in Figure 3 to be about 8.4×10^{-4} ft/ft.

- b. Hydraulic Conductivity: Slug testing was performed by the ASU team in each down gradient transect well, and the results are presented in Table 3. Several wells tested displayed an oscillatory water level response and are marked as such in Table 3. An alternative analytical method (Butler Method 2003) was utilized to process the data for the oscillatory water level response data sets. The values range from about 10^{-3} to 10^{-2} cm/s.
- c. Geologic Profile: Drilling for confirmation of the geologic conceptual model was not possible. However, in existing site documentation the conceptual subsurface model consists of a thin surficial veneer of colluviums (0-10ft thick) followed by the following bedrock stratigraphic sequence: Greenstone (100-200ft thick), Calcareous Phyllite (~75ft thick) and Slate. Bedrock units have a 20 to 25 degree dip to the west-northwest, and as such, their stratigraphic presence varies by location across the site. Additional information regarding the geology of this site can be found in the site-specific demonstration plan or the remedial investigation report for this site (Parsons 2008).

2.2 Collection and analyses of samples necessary to characterize groundwater quality and dissolved chemical concentrations, and biodegradation activity:

- a. Groundwater Sampling: Sampling of wells was performed by the site consultant using conventional well purge methods for the first two events and then by ASU for the third and fourth events using Hydrasleeve® samplers. Sampling method details are located in Appendix A. The groundwater samples were collected, preserved as outlined in the Demonstration Plan, and shipped to ASU via FedEx overnight. Selected wells are identified in Table 1 and their locations are shown in Figure 2.
- b. Groundwater Sample Analyses:
 - i. Field Water Quality Parameters: Field water quality parameters for the first two events were provided by the site consultant. However, due to the sampling method used by ASU for the 3rd and 4th events, only small volumes of water were recovered and water quality parameters including pH, electrical conductivity (EC), temperature (T), dissolved oxygen (DO), and oxidation reduction potential (ORP) were not measured. Field water quality data from previous events are summarized in Table 2A and 2B.
 - ii. General Water Chemistry: General water chemistry analyses, including nitrate (NO_3^-), sulfate (SO_4^{2-}), chloride (Cl^-), manganese (Mn^{2+}), iron (Fe^{2+}), dissolved organic carbon (DOC), chemical oxygen demand (COD),

and alkalinity were performed on the groundwater samples indicated in Table 1. These data were collected to provide general site information and possible insight into biodegradation processes and are summarized in Tables 4A-4D, for the four sampling events conducted to date.

- iii. Volatile Organic Hydrocarbons: Volatile organic hydrocarbon (VOC) analyses were performed on groundwater samples collected from locations indicated in Table 1. Groundwater samples were analyzed using a heated headspace method and gas chromatography using a dry electrolytic conductivity detector (DELCD) and/or a flame-ionization detector (FID). Volatile organic hydrocarbon analyses results are presented in Table 5.
- iv. Dehalococoides Measurement: Water samples were to look for the presence of Dehalococoides chlorinated hydrocarbon degrader populations. One-liter samples were collected during the second sampling event results and locations of testing are shown in Table 9. However due to the change in the sampling method employed during the 3rd and 4th events, no groundwater samples were able to be collected to determine if dehalococoides dechlorinating organisms were present.

2.3 Collection and analyses of vapor samples needed to calculate source zone mass loss rates:

- a. Soil Gas Sampling: Soil gas samples were collected from temporary soil gas sampling installations within the sludge drying bed area at the locations shown in Figure 4. Soil gas sampling and diffusion testing (discussed below) were facilitated using Geoprobe tooling to drive and set stainless steel soil gas sampling screens. Sampling screens were set with glass beads through the sampling interval and sealed above this with a hydrated bentonite seal. Due to the shallow and irregular alluvial-bedrock contact, locations were based on the ability to locate areas of sufficient alluvial cover thickness suitable for sampling. Table 6 summarizes the sampling depths. Soil gas samples were collected in Tedlar bags using a lung sampler, shipped to ASU, and were analyzed within 24 hours of collection by gas chromatography (GC) using a dry electrolytic conductivity detector (DELCD) and/or a flame-ionization detector (FID). Soil gas sampling results are summarized in Table 6.
- b. Effective Diffusion Coefficient Characterization: Following the collection of soil gas samples, in situ diffusion tests were performed at all soil gas sampling locations in order to measure effective diffusion coefficients needed to calculate source zone volatilization losses. After soil gas sample collection, one liter of a 10% v/v helium mix in air was injected into the sampling interval. Then one liter of soil gas was withdrawn for helium concentration analysis after a specified in situ hold time of up to 10 minutes. Diffusion test results are shown in Table 7. Further discussion of the diffusion testing method maybe found in Johnson et al (1998)

With respect to estimating the mass loss rates of chlorinated solvents using the data discussed above, it is important to recognize that while concentrations (mass/volume) of parent and daughter compounds are being quantified, the mass of free chloride ions liberated during

degradation is not explicitly monitored. Thus, the concentration of each chlorinated species leaving the source zone as dissolved or vapor phase is converted to an “equivalent” initial parent concentration so that the total mass loss can be accounted for. For this site TCE was chosen as the parent compound. For the Hill AFB Little Mountain site calculations, all VOC concentrations were converted to “TCE equivalents” using an adjustment factor based on the molar equivalence of each compound. Adjustment factors are presented in a secondary table under Table 7C. Details concerning the use of TCE equivalents and calculation of adjustment factors are explained in the source zone natural attenuation method, which has been submitted to ESTCP under this project.

Figure 2 identifies transect A-A', which is oriented approximately perpendicular to groundwater flow. The data from this transect are used for contouring chemical concentrations and calculating source zone mass loss rates across the saturated zone boundary of the source. Monitoring wells of interest along Transect A-A' include LM-030, LM-014, LM-067A, LM-067B, LM-007, LM-065A, LM-065B, LM-038B, LM-038C, LM-038A, LM-004C, LM-004B, LM-004, LM-006C, LM-006B, and LM-006.

Figure 5 show vertical contour plots for VOC chemical concentrations expressed as TCE equivalents in groundwater along transect A-A' for sampling events 1, 2, 3, and 4 conducted July-Aug 2008, Apr-May 2009, September 12-17, 2010, and August 23, 2011, respectively.

Using the measured VOC groundwater concentrations, hydraulic conductivities, and hydraulic gradients, mass loss rate calculations were performed using the Mass Flux Toolkit, Version 1.0 (freeware program developed by Groundwater Services, Inc. and others under a contract funded by ESTCP). Hydraulic conductivity inputs (3 - 140 ft/d; depending on lithologic unit) were based on ASU slug test results and a calculated hydraulic gradient of 8.36×10^{-4} ft/ft. Figures 6-10 are snap shot examples of the input screens for analyses of the data from sampling events conducted July-Aug 2008 (Event 1). Figure 7 shows the corresponding interpolated concentration grids and Figure 8 displays an example of the interpolated hydraulic conductivity grids.

The Mass Flux Toolkit allows a choice from various data interpolation schemes (Linear, Log, Nearest Neighbor). For this report, nearest neighbor interpolation was applied to produce both the concentration and hydraulic conductivity profile; hydraulic gradient was held constant for use in the calculation. Only the nearest neighbor approach produced interpolated concentration profiles that were reasonably consistent with what would be expected for this type of fractured subsurface system. In this approach, interpolation first occurs vertically. In cases where there is only a single data point at a given sampling location, this point is applied to the entire vertical interval for which the mass loss rate is being calculated. This is then followed by horizontal interpolation utilizing the interpolated vertical profiles generated previously.

Figure 5 presents the source zone mass loss rate estimates. Values of 570, 590 and 250, and 240 kg-TCE/y were calculated for July-Aug 2008, Apr-May 2009, September 12-17, 2010, and August 23, 2001 respectively.

The Mass Flux Toolkit also includes an “uncertainty analysis” that helps users identify the data points that most significantly influence the calculated mass flux. The uncertainty analysis for field events 1 and 2 are provided in Figures 10A, 10B and 10C, respectively. Examination of the results shows that the information from Wells LM -038A, LM -038B, LM -038C and LM-007 are critical to the mass flux calculation. Thus, additional data (sample splits and additional slug testing) could help to increase the confidence in the data from these locations and the overall mass flux calculations.

The mass loss attributable to vapor transport from the top of the source zone was calculated using the CAH vapor concentration data, measured effective diffusion coefficient values, and an estimated representative sample area of 50 ft² for each soil gas sample location. This contribution to the source zone mass loss rate was estimated to be about 2.6 x 10⁻² kg-TCE/y, which is a value much lower than the source zone mass loss contribution calculated above using groundwater data.

A combined extraction method using MoBio and Qiagen DNA extraction kits was utilized for dehalococoides testing. The combined method significantly improves DNA recovery rates. Testing for Dehalococoides was performed using this newly developed method in combination with nested PCR. Each sample was first analyzed using general bacterial primers (16s rRNA). All samples, except the blank, returned a positive result for the presence of bacteria. The resultant PCR products were then diluted and reanalyzed for the presence of dehalococoides. Of the seven samples analyzed, four tested positive for the presence of dehalococoides (LM-003, LM -022A, LM-035, LM-038A). The results are tabulated in Table 9.

3. References

Butler, James J, and Elizabeth J. Garnett. "Analysis of Slug Tests in Formations of High Hydraulic Conductivity." *Ground Water* 41:5(2003): 620-631. DOI:10.1111/j.1745-6584.2003.tb02400.x Print. Available Online: <http://dx.doi.org/10.1111/j.1745-6584.2003.tb02400.x>

Fetter, C.W. 2000. *Applied Hydrogeology*. 4th ed. Upper Saddle River, New Jersey: Prentice-Hall. pp.197-200.

Johnson, P.C., Cristin Bruce, Richard Johnson and Mariush Kemblowski. “In Situ Measurement of Effective Vapor-Phase Porouse Media Diffusion Coefficients”. *Environmental Science and Technology* 32. (1998)) 2405-2409. Print

Mass Flux Toolkit. GSI Environnemental. V1.0. Located at http://www.gsi-net.com/Software/massflx_dl/main_massflx.as

Parsons Infrastructure & Technology Group Inc., 2008. Remedial Investigation Report For Sludge Drying Beds Site, Operable Unit A, Little Mountain Test Annex, Hill Air Force Base, Utah. October 2008.

Tables

Table 1

Sampling Locations and Analyses Performed: Event 4 August 23, 2011

Well	DTW	Field Parameters	Anions	Cations	Alkalinity	COD	DOC	CAH	Dhc
LM004-B	X	---	X	X	X	X	X	X	---
LM004-C	X	---	X	X	X	X	X	X	---
LM004	X	---	X	X	X	X	X	X	---
LM006-B	X	---	X	X	X	X	X	X	---
LM006-C	X	---	X	X	X	X	X	X	---
LM006	X	---	X	X	X	X	X	X	---
LM007	X	---	X	X	X	X	X	X	---
LM014	X	---	X	X	X	X	X	X	---
LM030	X	---	X	X	X	X	X	X	---
LM038-A	X	---	X	X	---	X	X	X	---
LM038-B	X	---	X	X	X	X	X	X	---
LM038-C	X	---	X	X	X	X	X	X	---
LM065-A	X	---	X	X	X	X	X	X	---
LM065-B	X	---	X	X	X	X	X	X	---
LM067-A	X	---	X	X	X	X	X	X	---
LM067-B	X	---	X	X	X	X	X	X	---

Table 2A

Depth-to-Groundwater, Groundwater Elevation, and Field Water Quality Parameters:

Event 1 – July-Aug 2008

Well	DTW (ft btoc)	Groundwater Elevation (ft amsl)	Temp (°C)	pH	Conductivity (mS/cm)	DO (mg/L)	Turbidity (NTU)	ORP (mV)
LM-002	158.51	4208.74	20	7.5	4.7	7.2	85	7
LM-003	148.02	4209.01	23	6.9	4.7	<1	1.6	10
LM-004B	100.5	4207.68	19.9	7.0	8.4	<1	1.2	38
LM-004C	100.52	4207.60	22.1	6.7	25	<1	<1	-52
LM-004	97.60	4208.16	19.3	7.3	5.3	<1	<1	44
LM-006	85.61	4208.41	19.1	6.9	1.2	6.9	11	-44
LM-006B	86.02	4208.61	20.2	7.2	8.8	<1	4.5	8
LM-006C	86.02	4208.62	22	6.7	13	<1	<1	3
LM-007	88.14	4208.78	19.3	7.8	3.3	6.4	32	-9
LM-008	128.66	4209.46	19.3	7.8	5.5	7.9	8.9	-1
LM-009	118.11	4209.04	19.6	7.8	3.3	8.8	40	-33
LM-010	131.38	4210.02	19.2	7.6	3.4	9.1	11	-29
LM-014	57.94	4208.83	18.7	7.5	5.5	6.6	6.4	-10
LM-016	103.35	4208.51	19.3	7.0	2.5	4.5	21	-51
LM-022A	158.46	4209.02	22.6	7.8	8.0	<1	4.4	-180
LM-022B	157.35	4210.11	20.6	6.2	9.4	<1	260	-220
LM-022C	158.73	4208.72	20.4	7.8	8.0	1.8	51	28
LM-030	54.05	4211.91	18.7	6.9	3.8	7.1	13	45

LM-032	107.07	4212.13	18.1	7.3	1.2	6.9	75	34
LM-033A	156.74	4208.97	20.2	6.6	4.6	<1	3.1	-130
LM-033B	157.08	4208.65	21.0	7.7	7.6	<1	<1	-170
LM-033C	157.73	4207.97	22.2	6.8	26	<1	12	-78
LM-035	151.62	4208.97	21.4	6.4	7.0	<1	3.1	-130
LM-038A	105.85	4208.92	18.8	7.5	6.0	<1	5.7	-190
LM-038B	109.75	4208.26	20.5	7.6	19	<1	<1	-20
LM-038C	110.94	4207.03	22.3	6.8	35	<1	<1	34
LM-065A	93.15	4208.51	19.8	7.5	16	<1	<1	-42
LM-065B	93.24	4208.38	20.2	7.4	20	<1	<1	-39
LM-067A	56.84	4208.29	19.7	7.3	18	<1	<1	-160
LM-067B	57.00	4208.15	20.3	7.5	28	<1	<1	-280
LM-075A	119.85	4208.74	22.4	7.3	21	1.3	12	42
LM-075B	121.38	4207.22	23.2	7.0	29	<1	<1	-120
LM-088A	57.55	4206.47	22.6	7.2	31	<1	<1	-17
LM-088B	58.00	4206.50	23.0	7.1	37	<1	9.8	-103

Note – Data displayed in table was collected at the time of groundwater sample collection by Parsons during a 7 week sampling event beginning the last week of July 2008.

Table 2B

Depth-to-Groundwater, Groundwater Elevation, and Field Water Quality Parameters:

Event 2 April – May 2009

Well	Bailed ?	DTW (ft btoc)	GW Elevation (ft amsl)	Temp (°C)	pH	EC (mS/cm)	DO (mg/L)	Turbidity (NTU)	ORP (mV)
LM-002	No	157.77	4209.48	19.6	7.5	4.3	8.2	46	36
LM-003	No	147.29	4209.74	20.6	6.8	4.3	<1	0	50
LM-004	No	96.96	4208.8	18.3	7.5	6.0	<1	0.3	84
LM-004B	No	98.92	4209.26	19.3	7.2	8.1	<1	2.6	72
LM-004C	No	99.92	4208.2	21.8	7.6	33	<1	0.2	-190
LM-006	Yes	85	4209.02	---	---	---	---	---	---
LM-006B	Yes	85.38	4209.25	---	---	---	---	---	---
LM-006C	Yes	85.39	4209.25	---	---	---	---	---	---
LM-007	No	87.52	4209.4	18.4	7.8	3.1	5.9	19	51
LM-008	No	127.95	4210.17	19.5	7.5	4.6	8.1	15	45
LM-009	No	117.38	4209.77	19.4	7.6	3.1	7.4	8.4	-11
LM-010	No	130.76	4210.64	19.5	7.5	3.0	9.3	0	36
LM-014	No	57.3	4209.47	18.0	8.1	3.6	7.4	8.3	14
LM-016	Yes	102.65	4209.21	---	---	---	---	---	---
LM-022A	No	157.86	4209.62	22.3	7.5	8.2	<1	180	-180
LM-022B	No	154.64	4209.41	20.7	6.2	8.9	<1	1.8	-200
LM-022C	No	157.96	4209.49	21.2	7.9	7.4	<1	0	5
LM-030	No	53	4212.96	17.9	7.3	3.4	8.7	15	68

LM-032	Yes	103.92	4215.28	---	---	---	---	---	---
LM-033A	No	155.95	4209.76	22.0	6.9	4.5	<1	5.0	-130
LM-033B	No	156.2	4209.53	20.5	8.0	11	<1	0	-150
LM-033C	No	156.92	4208.78	21.1	7.0	33	<1	10	-64
LM-035	No	150.82	4209.77	23.8	6.3	8.5	<1	49	-120
LM-038A	No	105.35	4209.42	18.8	8.0	5.3	<1	5.6	-170
LM-038B	No	109.07	4208.94	20.1	7.5	24	<1	0	-67
LM-038C	No	110.37	4207.6	21.6	6.7	42	<1	0	42
LM-065A	No	92.48	4209.18	20.6	7.4	16	<1	0.8	-26
LM-065B	No	92.86	4208.76	20.9	7.3	22	<1	0.7	-65
LM-067A	No	56.2	4208.93	18.9	7.6	22	<1	0.8	-220
LM-067B	No	56.55	4208.6	20.4	7.5	41	<1	0	-210
LM-075A	No	119.46	4209.13	22.4	7.2	24	<1	2.4	44
LM-075B	No	120.68	4207.92	23.4	7.0	37	<1	0.9	-240
LM-088A	No	57.21	4207.28	22.2	7.8	44	<1	0.3	-200
LM-088B	No	57.11	4207.39	22.7	7.8	48	<1	0.7	-170

Note – Data displayed in table was collected at the time of groundwater sample collection by Parsons during a 6 week sampling event beginning the second week of April 2009: DTW data is from a synoptic sampling event on April 10,2009: Bailer samples were collected during the ASU field event May 11-14, 2009.
--- – Indicates no sample collected

Table 2C

Depth-to-Groundwater, Groundwater Elevation, and Field Water Quality Parameters:

Event 3: September 2010

Well	DTW (ft btoc)	Temp (°C)	pH	Conductivity (mS/cm)	DO (mg/L)	Turbidity (NTU)	ORP (mV)
LM-004	98.02	---	---	---	---	---	---
LM-004B	99.94	---	---	---	---	---	---
LM-004C	100.91	---	---	---	---	---	---
LM-006	86.10	---	---	---	---	---	---
LM-006B	86.48	---	---	---	---	---	---
LM-006C	86.45	---	---	---	---	---	---
LM-007	88.57	---	---	---	---	---	---
LM-014	58.33	---	---	---	---	---	---
LM-030	55.97	---	---	---	---	---	---
LM-038A	106.41	---	---	---	---	---	---
LM-038B	110.06	---	---	---	---	---	---
LM-038C	111.36	---	---	---	---	---	---
LM-065A	93.48	---	---	---	---	---	---
LM-065B	93.88	---	---	---	---	---	---
LM-067A	57.19	---	---	---	---	---	---
LM-067B	57.46	---	---	---	---	---	---

Note: Field water quality parameters were not measure during this field event due to the use of a no purge sampling method

Table 2D

Depth-to-Groundwater, Groundwater Elevation, and Field Water Quality Parameters:

Event 4: August 23, 2011

Well	DTW (ft btoc)	Temp (°C)	pH	Conductivity (mS/cm)	DO (mg/L)	Turbidity (NTU)	ORP (mV)
LM-004	94.33	---	---	---	---	---	---
LM-004B	97.09	---	---	---	---	---	---
LM-004C	98.20	---	---	---	---	---	---
LM-006	83.22	---	---	---	---	---	---
LM-006B	83.72	---	---	---	---	---	---
LM-006C	83.62	---	---	---	---	---	---
LM-007	85.73	---	---	---	---	---	---
LM-014	55.53	---	---	---	---	---	---
LM-030	48.70	---	---	---	---	---	---
LM-038A	103.45	---	---	---	---	---	---
LM-038B	107.31	---	---	---	---	---	---
LM-038C	108.89	---	---	---	---	---	---
LM-065A	83.07	---	---	---	---	---	---
LM-065B	54.55	---	---	---	---	---	---
LM-067A	54.82	---	---	---	---	---	---
LM-067B	94.33	---	---	---	---	---	---

Note: Field water quality parameters were not measure during this field event due to the use of a no purge sampling method

Table 3A

Hydraulic Conductivity – Slug Test Results: Event 2 May 11-14, 2009

Well	Oscillatory Response?	Bouwer & Rice		Butler	
		(ft/d)	(cm/s)	(ft/d)	(cm/s)
LM004	No	18	6.2×10^{-3}	-	-
LM004B	Yes	-	-	110	3.9×10^{-2}
LM004C	Yes	-	-	110	4.0×10^{-2}
LM006	No	6.6	2.3×10^{-3}	-	-
LM006B	No	16	5.5×10^{-3}	-	-
LM006C	No	14	5.0×10^{-3}	17	6.0×10^{-3}
LM007	No	10	3.6×10^{-3}	-	-
LM014	No	3.6	1.3×10^{-3}	-	-
LM030	No	3.7	1.3×10^{-3}	-	-
LM038A*	Yes	---	---	---	---
LM038B	No	2.2	$7. \times 10^{-4}$	-	-
LM038C	Yes	-	-	110	3.9×10^{-2}
LM065A	Yes	-	-	130	4.0×10^{-2}
LM065B	Yes	-	-	140	4.9×10^{-2}
LM067A	Yes	-	-	63	2.2×10^{-2}
LM067B	Yes	-	-	74	2.6×10^{-2}

--- – Insufficient sampling rate (60Hz) did not allow for analysis of well

- – No analysis conducted due to oscillatory response

Table 3B

Hydraulic Conductivity – Slug Test Results: Event 3 September 16-17, 2010

Well	Oscillatory Response?	Bouwer & Rice		Butler	
		(ft/d)	(cm/s)	(ft/d)	(cm/s)
LM004	No	20	7.2×10^{-3}	-	-
LM004-B	Yes	-	-	75	2.7×10^{-2}
LM004-C	Yes	-	-	110	3.7×10^{-2}
LM006	No	-	-	-	-
LM006-B	No	-	-	-	-
LM006-C	No	26	9.2×10^{-3}	-	-
LM007	Yes	-	-	90	3.2×10^{-2}
LM014	No	4.4	1.6×10^{-3}	-	-
LM030	No	4.6	1.6×10^{-3}	-	-
LM038A	Yes	-	-	89	3.2×10^{-2}
LM038B	No	2.1	7.5×10^{-4}	-	-
LM038C	No	12	4.2×10^{-3}	-	-
LM065A	Yes	-	-	110	3.8×10^{-2}
LM065B	Yes	-	-	33	1.2×10^{-2}
LM067A	Yes	-	-	84	3.0×10^{-2}
LM067B	Yes	-	-	80	2.8×10^{-2}

- - No analysis conducted due to oscillatory response

Table 4A

General Water Chemistry Data: Event 1 – July-Aug 2008

Well	(mg/L)							mg/L as CaCO ₃
	Cl ⁻	SO ₄ ²⁻	NO ₃ ⁻	Fe ²⁺	Mn ²⁺	COD	DOC	Alkalinity
LM002	1100	NQ	NQ	1	ND	42	3	240
LM003	1100	NQ	NQ	ND	1	82	4	300
LM004-B	2200	NQ	NQ	ND	ND	56	4	320
LM004-C	9100	NQ	NQ	ND	2	380	2	280
LM004	1500	NQ	NQ	ND	ND	36	3	220
LM006-B	1000	NQ	NQ	ND	ND	30	1	280
LM006-C	3600	NQ	NQ	ND	ND	76	2	280
LM006	37	NQ	NQ	ND	ND	18	2	200
LM007	500	NQ	NQ	ND	ND	32	16	400
LM008	970	NQ	NQ	ND	ND	21	2	320
LM009	520	NQ	NQ	ND	ND	15	2	420
LM010	520	NQ	NQ	ND	ND	9	3	380
LM014	1200	NQ	NQ	ND	ND	48	3	320
LM016	120	NQ	NQ	ND	ND	12	3	260
LM022-A	1900	NQ	NQ	3	8	222000	3600	32000
LM022-B	2600	NQ	NQ	34	9	1900	600	---
LM022-C	2100	NQ	NQ	ND	ND	62	7	260
LM030	750	NQ	NQ	ND	ND	48	6	360
LM032	45	NQ	NQ	ND	ND	90	2	260
LM033-A	1100	NQ	NQ	12	3	530	86	320
LM033-B	2000	NQ	NQ	ND	ND	102	8	320

LM033-C	8000	NQ	NQ	ND	ND	400	6	320
LM035	2200	NQ	NQ	70	9	2600	520	16000
LM038-A	1600	NQ	NQ	1	1	140	12	---
LM038-B	5900	NQ	NQ	ND	ND	230	4	280
LM038-C	12000	NQ	NQ	ND	1	570	6	300
LM065-A	4800	NQ	NQ	ND	ND	110	7	300
LM065-B	6800	NQ	NQ	ND	ND	240	3	320
LM067-A	5400	NQ	NQ	1	ND	140	8	300
LM067-B	11000	NQ	NQ	1	1	940	2	240
LM075-B	---	---	---	ND	ND	270	3	420
LM075-B	12000	NQ	NQ	ND	1	1000	3	300
LM088-A	14000	NQ	NQ	1	1	84	25	---
LM088-B	13000	NQ	NQ	ND	1	690	9	280

NQ – Not quantified due to interference of chloride peak at these chloride concentrations
 --- – No water available for analysis

PQL – 1 mg/L

ND – Non-detect

Table 4B

General Water Chemistry Data: Event 2 - Apr-May 2009

Well	(mg/L)							mg/L as CaCO ₃
	Cl ⁻	SO ₄ ²⁻	NO ₃ ⁻	Fe ²⁺	Mn ²⁺	COD	DOC	Alkalinity
LM002	1100	190	42	1	ND	34	1	260
LM003	1000	160	15	ND	ND	68	---	340
LM004	1600	250	20	ND	ND	61	4	260
LM004-B	2100	290	21	1	ND	76	---	340
LM004-C	6000	230	24	ND	ND	170	9	280
LM006	170	70	18	1	ND	16	----	140
LM006-B	860	160	17	ND	ND	38	8	320
LM006-C	280	3500	4	ND	ND	120	13	280
LM007	560	180	34	1	ND	14	3	420
LM008	950	372	110	ND	ND	30	13	320
LM009	550	170	58	ND	ND	21	3	460
LM010	510	200	100	ND	ND	22	---	400
LM014	600	90	10	ND	ND	20	13	400
LM016	400	150	23	ND	ND	16	8	240
LM022-A	1800	12	2	ND	10	190000	4500	820
LM022-B	2600	14	ND	14	9	1000	530	460
LM022-C	1900	150	14	ND	ND	69	1	300
LM030	670	200	23	ND	ND	19	5	320
LM032	100	73	20	ND	ND	14	8	140
LM033-A	1200	ND	ND	3	ND	260	120	580
LM033-B	2000	150	1	ND	ND	99	7	340

LM033-C	4500	460	2	ND	ND	420	6	340
LM035	2200	1	ND	62	10	1800	69	740
LM038-A	1600	41	2	1	ND	110	830	320
LM038-B	5300	340	3	ND	ND	14	18	320
LM038-C	6300	350	4	1	ND	960	16	320
LM065-A	2700	150	4	ND	ND	150	0	380
LM065-B	3700	190	6	ND	ND	250	2	320
LM067-A	3600	270	ND	ND	ND	620	3	320
LM067-B	6100	260	ND	2	ND	440	1	260
LM075-A	5000	450	5	1	ND	190	14	360
LM075-B	5700	270	ND	ND	ND	320	2	260
LM088-A	6600	290	4	ND	ND	350	1	240
LM088-B	7300	340	3	ND	ND	610	16	300

Note – Data displayed in table was collected at the time of groundwater sample collection by Parsons during a 6 week sampling event beginning the second week of April 2009; DTW data is from a synoptic sampling event on April 10,2009; Bailer samples were collected during the ASU field event May 11-14, 2009.

--- – No water available for analysis

PQL – 1mg/L

Table 4C

General Water Chemistry Data: Event 3 – September 12-17, 2010

Well	(mg/L)							mg/L as CaCO ₃
	Cl ⁻	SO ₄ ²⁻	NO ₃ ⁻	Fe ²⁺	Mn ²⁺	COD	DOC	Alkalinity
LM-004	1400	270	21	ND	ND	54	16	220
LM-004B	2100	260	21	ND	ND	100	7.9	300
LM-004C	5500	190	21	ND	ND	200	1.0	260
LM-006	200	65	17	ND	ND	7	1.0	180
LM-006B	900	150	15	ND	ND	150	5.2	340
LM-006C	270	3600	4	ND	ND	160	1.0	240
LM-007	650	180	28	ND	ND	19	1.0	380
LM-014	560	77	9	ND	ND	84	4.9	300
LM-030	640	210	19	ND	ND	120	3.0	320
LM-038A	1600	33	2	1	ND	77	14	300
LM-038B	4500	310	3	ND	ND	390	1.0	280
LM-038C	5400	300	4	1	ND	250	7.6	300
LM-065A	2800	170	4	ND	ND	250	14	340
LM-065B	4100	220	7	ND	ND	180	1.0	320
LM-067A	2900	280	ND	ND	ND	130	11	300
LM-067B	5400	260	ND	1	ND	180	8.8	260

Note – Data displayed in table was collected at the time of groundwater sample collection by Parsons during a 6 week sampling event beginning the second week of April 2009: DTW data is from a synoptic sampling event on April 10,2009: Bailer samples were collected during the ASU field event May 11-14, 2009.

--- – No water available for analysis

PQL – 1mg/L

Table 4D

General Water Chemistry Data: Event 4 – August 23, 2011

Well	(mg/L)							mg/L as CaCO ₃
	Cl ⁻	SO ₄ ²⁻	NO ₃ ⁻	Fe ²⁺	Mn ²⁺	COD	DOC	Alkalinity
LM-004	1500	260	20	ND	ND	50	18	240
LM-004B	2100	280	21	ND	ND	50	11	320
LM-004C	6000	200	20	ND	ND	180	2	280
LM-006	180	65	18	ND	ND	10	2	180
LM-006B	940	150	18	ND	ND	50	4	320
LM-006C	300	3400	5	ND	ND	150	1	260
LM-007	580	180	30	ND	ND	16	4	400
LM-014	600	70	8	ND	ND	20	6	340
LM-030	680	200	15	ND	ND	15	3	340
LM-038A	1600	26	1	1	ND	50	10	300
LM-038B	5100	320	4	ND	ND	320	2	300
LM-038C	5600	340	3	ND	ND	260	9	320
LM-065A	2800	180	4	ND	ND	220	10	360
LM-065B	4000	210	7	ND	ND	160	1	320
LM-067A	2700	280	ND	1	ND	150	14	300
LM-067B	5000	260	ND	ND	ND	200	12	260

Note – Data displayed in table was collected at the time of groundwater sample collection by Parsons during a 6 week sampling event beginning the second week of April 2009: DTW data is from a synoptic sampling event on April 10, 2009: Bailer samples were collected during the ASU field event May 11-14, 2009.

--- – No water available for analysis

PQL – 1mg/L

Table 5A

VOC Groundwater Concentration Data: Event 1 – July-Aug 2008

Well	CAH Concentration in Groundwater (µg/L)											
	VC	11 DCE	11 DCA	tDCE	cDCE	12 DCA	111 TCA	TCE	112 TCA	PCE	Ethene	TCE Equiv ¹
LM002	-	4	2	<1	10	<1	<1	98	-	1	NQ	120
LM003	76	860	990	230	34000		130	40000	-	300	NQ	90000
LM004	5	120	180	40	4000	5	15	5000	-	70	NQ	11000
LM004B	13	57	120	110	3000	13	2	660	-	2	NQ	5100
LM004C	-	-	-	-	<1	-	-	<1	-	-	NQ	0
LM006	-	-	-	-	-	-	-	-	-	-	NQ	0
LM006B	-	-	-	-	-	-	-	-	-	-	NQ	0
LM006C	-	-	-	-	-	-	-	-	-	-	NQ	0
LM007	-	-	<1	-	35	-	-	73	-	-	NQ	120
LM008	-	-	-	-	-	-	-	2	-	-	NQ	2
LM009	-	-	-	-	-	-	-	3	-	<1	NQ	3
LM010	-	-	-	-	9	-	-	31	-	-	NQ	43
LM014	-	-	-	-	2	-	-	6	-	-	NQ	9
LM016	-	-	-	-	-	-	-	-	-	-	NQ	0
LM022A	60	720	50	-	31000	170	7	73000	-	36	NQ	120000
LM022B	780	1500	1200	1200	89000	1700	310	9400	-	330	NQ	140000
LM022C	32	59	67	43	7100	3	3	6800	-	59	NQ	17000
LM030	-	-	-	-	-	-	-	-	-	-	NQ	0
LM032	-	-	-	-	-	-	-	-	-	-	NQ	0
LM033A	140	31	19	220	18000	6	-	2	-	-	NQ	25000
LM033B	31	150	180	1500	19000	47	8	9900	-	32	NQ	38000

LM033C	9	<1	5	<1	72	-	-	4	-	4	NQ	130
LM035	200	440	670	430	130000	2000	-	12000	-	6700	NQ	200000
LM038A	430	-	-	56	18000	130	-	180	-	-	NQ	26000
LM038B	2	2	4	1	140	2	-	40	-	-	NQ	250
LM038C	-	-	-	-	-	-	-	3	-	-	NQ	3
LM065A	31	42	85	50	1700	-	13	150	24	-	NQ	2800
LM065B	10	21	22	9	520	-	9	49	-	8	NQ	860
LM067A	6	12	4	10	520	14	-	32	-	-	NQ	800
LM067B	9	4	1	0	110	-	1	5	-	1	NQ	180
LM075A	-	3	-	16	8	-	-	8	-	33	NQ	70
LM075B	-	-	-	-	3	-	-	1	-	-	NQ	5
LM088A	-	4	2	2	170	8	-	28	-	11	NQ	290
LM088B	-	-	-	-	1	-	-	1	-	-	NQ	2

NW – Indicates no water available for analysis

PQL – 1ug/L

<1 – Indicates analyte was detected, but was below PQL

Table 5B

VOC Groundwater Concentration Data: Event 2 – April-May 2009

Well	Bailer?	VOC Concentration in Groundwater (µg/L)											
		VC	11 DCE	11 DCA	tDCE	c-DCE	12 DCA	111 TCA	TCE	112 TCA	PCE	Ethene	TCE Equiv ¹
LM002	N	3	6	1	2	15	1	-	82	-	<1	-	120
LM003	N	31	530	1500	150	39000	150	-	35000	-	510	3	9200
LM004	N	9	60	110	14	2700	34	-	3100	-	54	-	7000
LM004B	N	17	35	80	8	2700	32	4	790	-	15	1	4800
LM004C	N	-	-	-	-	-	-	-	-	-	-	-	0
LM006	Y	-	-	-	-	-	-	-	-	-	-	-	0
LM006B	Y	-	-	-	-	-	-	-	-	-	-	-	0
LM006C	Y	-	-	-	-	-	-	-	-	-	-	-	0
LM007	N	-	-	-	-	28	-	-	40	-	-	-	78
LM008	N	5	-	-	-	-	-	-	1	<1	<1	-	11
LM009	N	6	<1	-	-	<1	-	2	12	-	<1	-	29
LM010	N	3	-	-	-	-	-	-	-	-	<1	-	7
LM014	N	5	-	-	-	<1	-	-	4	-	-	-	16
LM016	Y	-	-	-	-	-	-	-	-	-	-	-	0
LM022A	N	95	260	3400	350	39000	8000	120	48000	-	410	48	120000
LM022B	N	220	210	2900	1600	110000	1100	180	21000	-	630	65	170000
LM022C	N	14	100	210	110	67000	64	-	4800	-	100	NW	15000
LM030	N	-	-	-	-	-	-	-	-	-	-	-	0
LM032	Y	-	-	-	-	-	-	-	-	-	-	-	0
LM033A	N	130	34	-	390	22000	-	5		-	-	3	31000
LM033B	N	73	160	370	1100	19000	200	23	7400	-	73	6	36000

LM033C	N	-	-	2	-	27	-	-	6	-	-	-	45
LM035	N	300	500	300	3400	200000	2300	-	15000	-	270	78	290000
LM038A	N	120	50	110	610	20000	180	-	270	-	-	5	29000
LM038B	N	2	<1	2	<1	120	-	1	32	-	-	-	200
LM038C	N	-	28	-	40	-	250	-	300	-	170	-	860
LM065A	N	29	22	18	60	2100	-	16	78	-	4	<1	3100
LM065B	N	14	15	4	16	620	-	10	42	-	3	-	970
LM067A	N	7	122	3	10	370	21	-	52	-	-	<1	630
LM067B	N	3	2	<1	<1	70	-	5	4	-	-	-	120
LM075A	N	-	5	-	-	-	-	-	-	-	<1	-	7
LM075B	N	-	-	-	-	-	-	-	-	-	-	-	0
LM088A	N	8	1	<1	<1	19	-	<1	9	<1	<1	-	55
LM088B	N	4	-	-	-	<1	-	-	-	-	-	-	9

NW – Indicates no water available for analysis
PQL – 1ug/L

<1 – Indicates analyte was detected, but was below PQL

Table 5C

VOC Groundwater Concentration Data^A: Event 3 – September 2010

Well	VOC Concentration in Groundwater (µg/L) ^A											
	VC	11 DCE	11 DCA	tDCE	cDCE	12 DCA	111 TCA	TCE	PCE	Ethene	Ethane	TCE Equiv ¹
LM-004	-	110	180	72	5300	-	-	5000		-	-	13000
LM-004B	14	63	-	210	6400	64	3	1800		<1	-	11000
LM-004C	-	-	-	<1	1	-	<1	2		-	-	4
LM-006	-	-	-	-	-	-	-	-	-	-	-	0
LM-006B	-	-	-	-	-	-	-	-	-	-	-	0
LM-006C	-	-	-	-	-	-	-	-	-	-	-	0
LM-007	-	-	-	17	26	-	-	30	<1	-	-	88
LM-014	-	-	<1	<1	6	-	-	12	<1	-	-	21
LM-030	-	-	-	<1	<1	-	-	-	-	-	-	1
LM-038A	32	27	-	380	8400	120	-	72	-	6	7	12000
LM-038B	2	2	-	3	130	9	-	26	<1	<1	-	220
LM-038C	-	-	-	<1	<1	-	-	-	-	<1	-	<1
LM-065A	5	14	10	24	930	-	-	56	-	-	-	1400
LM-065B	5	12	-	15	710	37	-	29	-	-	-	1100
LM-067A	14	12	-	10	330	18	-	40	-	<1	<1	560
LM-067B	1	<1	<1	1	65	3	-	11	-	<1	-	110

A – Samples were collected using Hydrasleeve
 NW – Indicates no water available for analysis
 PQL – 1ug/L

<1 – Indicates analyte was detected, below PQL
 - – Indicates non-detect for contaminant of concern

Table 5D

VOC Groundwater Concentration Data^A: Event 4 – August 2011

Well	VOC Concentration in Groundwater (µg/L) ^A											
	VC	11 DCE	11 DCA	tDCE	cDCE	12 DCA	111 TCA	TCE	PCE	Ethene	Ethane	TCE Equiv ¹
LM-004	16	63	186	180	5400	-	-	4300	73	-	-	12000
LM-004B	23	59	91	130	3600	-	15	1000	-	<1	-	6400
LM-004C	-	-	-	-	-	-	-	-	-	-	-	0
LM-006	-	-	-	-	-	-	-	-	-	-	-	0
LM-006B	-	-	-	-	-	-	-	-	-	-	-	0
LM-006C	-	-	-	-	-	-	-	-	-	-	-	0
LM-007	-	-	-	5	22	-	-	21	-	-	-	57
LM-014	-	-	-	-	-	-	-	-	-	<1	<1	0
LM-030	-	-	-	-	-	-	-	-	-	-	-	0
LM-038A	38	22	73	140	7100	-	33	54	-	<1	-	10000
LM-038B	<1	3	-	11	175	-	-	36	-	-	-	290
LM-038C	18	-	-	-	-	-	-	-	-	-	-	39
LM-065A	14	9	59	-	1300	-	-	45	-	-	-	2000
LM-065B	3	11	-	20	500	-	-	25	-	-	-	740
LM-067A	6	15	-	10	518	-	-	27	7	-	-	780
LM-067B	3	-	-	1	87	-	-	3	-	-	-	130

A – Samples were collected using Hydrasleeve no purge sampler
 NW – Indicates no water available for analysis
 PQL – 1ug/L
 <1 – Indicates analyte was detected, below PQL
 1) – TCE equivalents based on adjustment factors in Table 7.
 - - - Indicates non-detect for contaminant of concern

Table 6A

CAH Vapor Concentration Data: Event 1 – July 30, 2008

Location	Depth (ft bgs)	CAH Concentration in Vapor (µg/L)										
		VC	11 DCE	11 DCA	t-DCE	c-DCE	12 DCA	111 TCA	TCE	112 TCA	PCE	TCE Equiv
VP 1N	1.5	-	1	-	-	-	-	-	140	64	2	210
VP 2N	2.75	-	-	-	-	-	-	14	260	-	6	280
VP 1S	3	1	-	-	-	-	-	43	-	-	-	45
VP 2S	5	1	-	-	-	-	-	15	29	-	-	46

PQL – 1ug/L

Note: Vapor Locations for Events 2 & 3 were the same installation, whereas Event 1 was a separate install located within 1ft

- - Indicates non-detect

Table 6B

CAH Vapor Concentration Data: Event 2 - May 14, 2009

Location	Depth (in bgs)	CAH Concentration in Vapor (µg/L)										
		VC	11 DCE	11 DCA	t-DCE	c-DCE	12 DCA	111 TCA	TCE	112 TCA	PCE	TCE Equiv
VP 1N	18.5"	-	-	-	-	-	-	-	24	-	5	28
VP 2N	17"	-	-	-	-	-	-	-	31	-	8	37
VP 3N	18"	-	-	-	-	-	-	-	62	-	7	68
VP 4N	30"	-	-	-	-	-	-	-	43	-	15	55
VP 1S	20"	-	-	-	-	-	-	-	-	-	-	0
VP 2S	62"	-	-	-	<1	4	-	-	7	-	<1	12
VP 3S	21"	-	-	-	-	-	-	-	44	-	5	48
VP 4S	34"	-	-	-	-	-	-	-	6	-	<1	6

Note: Vapor Locations for Events 2 & 3 were the same installation, whereas Event 1 was a separate install located within 1ft

PQL – 1ug/L

- - indicates non-detect

Table 6C

CAH Vapor Concentration Data: Event 3 – September 15, 2010

Location	Depth (in bgs)	CAH Concentration in Vapor (µg/L)								
		VC	11 DCE	11 DCA	t-DCE	c-DCE	12 DCA	TCE	PCE	TCE Equiv
VP 1N	18.5"	-	-	-	-	-	-	-	-	-
VP 2N	17"	-	-	<1	-	-	-	62	9	69
VP 3N	18"	-	-	<1	-	2	-	250	10	260
VP 4N	30"	-	-	-	-	240	-	100	29	450
VP 1S	20"	-	-	-	-	-	-	-	-	-
VP 2S	62"	-	-	-	-	15	-	7	1	27
VP 3S	21"	-	-	-	-	<1	-	150	6	150
VP 4S	34"	-	-	-	-	1	-	130	12	140

Note: Vapor Locations for Events 2 & 3 were the same installation, whereas Event 1 was a separate install located within 1ft

PQL – 1ug/L

- - indicates non-detect

Table 7A

In Situ Effective Diffusion Coefficient Measurement Results: Event 1 – July 30, 2008

Location	Depth (in bgs)	Effective Helium Diffusion Coefficient (cm ² /s)	$D_{He}^{eff} / D_{He}^{Air}$ (cm ² /s)
VP 1N	18"	1.8 x 10 ⁻²	3.0 x 10 ⁻²
VP 1N	18"	1.6 x 10 ⁻²	2.6 x 10 ⁻²
VP 2N	33"	3.3 x 10 ⁻²	5.4 x 10 ⁻²
VP 1S	36"	1.7 x 10 ⁻²	2.7 x 10 ⁻²
VP 2S	60"	6.6 x 10 ⁻²	1.1 x 10 ⁻²

Table 7B

In Situ Effective Diffusion Coefficient Measurement Results: Event 2 - May 14, 2009

Location	Depth (in bgs)	Effective Helium Diffusion Coefficient (cm ² /s)	$D_{He}^{eff} / D_{He}^{Air}$ (cm ² /s)
VP 1N	18.5"	1.2 x 10 ⁻¹	1.7 x 10 ⁻¹
VP 2N	17"	8.9 x 10 ⁻²	1.3 x 10 ⁻¹
VP 3N	18"	8.4 x 10 ⁻²	1.3 x 10 ⁻¹
VP 4N	30"	1.4 x 10 ⁻¹	2.1 x 10 ⁻¹
VP 1S	20"	4.6 x 10 ⁻²	6.9 x 10 ⁻²
VP 2S	62"	2.4 x 10 ⁻²	3.6 x 10 ⁻²
VP 3S	21"	8.0 x 10 ⁻²	1.2 x 10 ⁻²
VP 4S	34"	2.6 x 10 ⁻²	3.8 x 10 ⁻²

Note: Vapor Locations for Events 2 & 3 were the same installation, whereas Event 1 was a separate install located within 1ft

Table 7C

In Situ Effective Diffusion Coefficient Measurement Results: Event 3 - Sept 15, 2010

Location	Depth (in bgs)	Effective Helium Diffusion Coefficient (cm ² /s)	$D_{He}^{eff} / D_{He}^{Air}$ (cm ² /s)
VP 1N	18.5"	9.0 x 10 ⁻²	1.3 x 10 ⁻¹
VP 2N	17"	8.3 x 10 ⁻²	1.2 x 10 ⁻¹
VP 3N	18"	8.2 x 10 ⁻²	1.2 x 10 ⁻¹
VP 4N	30"	1.4 x 10 ⁻²	2.1 x 10 ⁻²
VP 1S	20"	4.5 x 10 ⁻²	6.6 x 10 ⁻²
VP 2S	62"	8.3 x 10 ⁻²	1.2 x 10 ⁻¹
VP 3S	21"	7.8 x 10 ⁻²	1.2 x 10 ⁻¹
VP 4S	34"	6.9 x 10 ⁻²	1.0 x 10 ⁻¹

Note: Vapor Locations for Events 2 & 3 were the same installation, whereas Event 1 was a separate install located within 1ft

Table 8A

Calculated Vapor Emission Mass Loss Rates: Event 1 – July 30, 2009

Vapor Point	Vapor Flux (kg/yr)						
	VC	11 DCE	111 TCA	112 TCA	TCE	PCE	TCE Equivalents
VP 1N	6.3E-05	5.3E-05	3.5E-04	2.8E-03	6.5E-03	8.5E-05	9.9E-03
VP 2N	ND	ND	6.1E-04	3.9E-04	1.2E-02	2.5E-04	1.3E-02
VP 1S	2.8E-05	ND	8.5E-04	ND	ND	ND	9.0E-04
VP 2S	1.1E-04	ND	7.5E-04	1.2E-03	1.5E-03	ND	3.7E-03

- - Indicates non-detect of CAH's resulting in no flux

Table 8B

Calculated Vapor Emission Mass Loss Rates: Event 2 - May 14, 2009

Vapor Point	Vapor Flux (kg/yr)			
	c-DCE	TCE	PCE	Total TCE Equivalents
VP 1N	-	1.0E-02	1.9E-03	1.2E-02
VP 2N	-	1.1E-02	2.5E-03	1.3E-02
VP 3N	-	2.0E-02	2.1E-03	2.2E-02
VP 4N	-	1.4E-02	4.4E-03	1.7E-02
VP 1S	-	-	-	-
VP 2S	9.9E-05	1.9E-04	-	3.2E-04
VP 3S	-	1.1E-03	1.2E-04	1.2E-03
VP 4S	-	3.1E-04	-	3.1E-04

- - Indicates non-detect of CAH's resulting in no flux

Table 8C

Calculated Vapor Emission Mass Loss Rates: Event 3–September 15, 2010

Vapor Point	Vapor Flux (kg/yr)			
	c-DCE	TCE	PCE	TCE Equivalents
VP 1N	-	-	-	-
VP 2N	-	2.2E-02	2.9E-03	2.4E-02
VP 3N	6.1E-04	8.2E-02	3.0E-03	8.5E-02
VP 4N	7.1E-02	3.2E-02	8.4E-03	1.4E-01
VP 1S	-	-	-	-
VP 2S	3.7E-04	1.9E-04	2.4E-05	7.1E-04
VP 3S	-	3.9E-03	1.4E-04	4.0E-03
VP 4S	4.7E-05	6.6E-03	5.6E-04	7.1E-03

- - Indicates non-detect of CAH's resulting in no flux

Vapor Flux Calculation

$$Flux_{vapor} = \sum_i D_i^{air} A \left(\frac{D_{He}^{eff}}{D_{He}^{air}} \right) \left(\frac{\Delta C_{v,i}}{\Delta Z} \right) \psi_i^j$$

Where:

- D_i^{air} – Diffusion coefficient of compound i in air (cm²/s)
- D_{He}^{eff} – Measured effective helium diffusion coefficient (cm²/s)
- D_{He}^{air} – Diffusion coefficient of helium in air (cm²/s)
- $C_{v,i}$ – Concentration of compound i in vapor (µg/L)
- Z – Depth of sample (cm)

ψ_i^j – Adjustment Factor for measured chemical i in terms of chemical j (mass j/ mass i)

Diffusion Coefficients in Air (cm²/s)

He	VC	11 DCE	t-DCE	11 DCA	c - DCE	TCE	PCE
6.71E-1	1.06E-01	9.00E-02	7.07E-02	7.42E-02	7.36E-02	7.90E-02	7.20E-02

Adjustment Factors (ψ_i^j)

		Equivalent					
		PCA	PCE	TCA	TCE	DCA	DCE
Measured	PCA	1.000	0.700	0.564	0.555	0.418	0.409
	PCE	1.428	1.000	0.804	0.792	0.597	0.585
	TCA	1.775	1.243	1.000	0.985	0.742	0.727
	TCE	1.802	1.262	1.015	1.000	0.753	0.738
	DCA	2.392	1.676	1.348	1.328	1.000	0.980
	DCE	2.442	1.711	1.376	1.355	1.021	1.000
	VC	3.788	2.653	2.135	2.102	1.583	1.551
	Ethane	7.873	5.515	4.436	4.369	3.291	3.224
	Ethene	8.440	5.912	4.756	4.684	3.528	3.456

Adjustment Factors determined via molar equivalence by the ASU team. A reference document for these calculations will be provided at a future date.

Table 9

Dehalococcoides Testing: Event 2 Apr – May 2009

Sample Location	General Bacteria	Dehalococcoides
LM-003	X	X
LM-004	X	--
LM-004B	X	--
LM-010	X	--
LM-022A	X	X
LM-035	X	X
LM-038A	X	X

X – indicates presence

-- - indicates non-detect

--

Figures

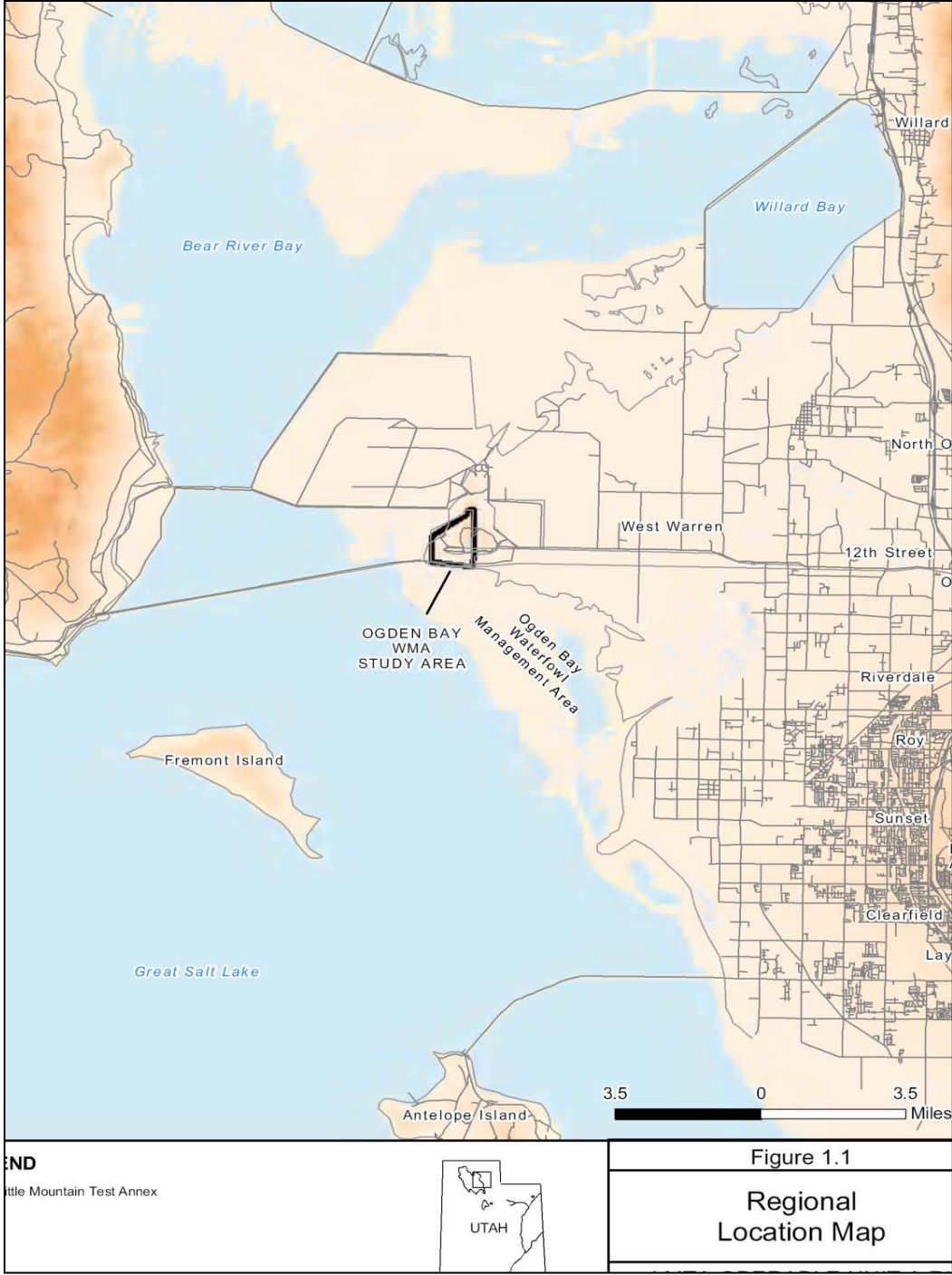

LMTA RI 2008 (Parsons)

Figure 1: Little Mountain Location

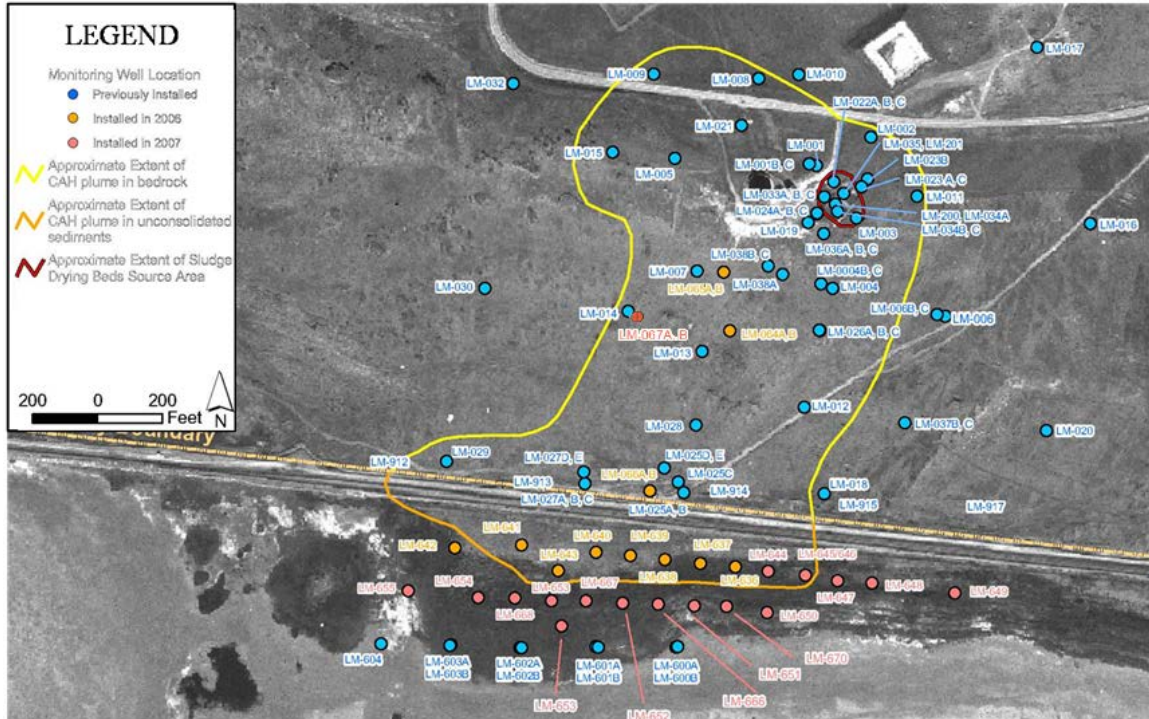

Transect

A-A' wells include (from left to right):
 LM-030, LM-014, LM-067A, LM-067B, LM-007, LM-065A, LM-065B, LM-038B, LM-038C, LM-038A, LM-004C, LM-004B, LM-004, LM-006C, LM-006B, LM-006

Figure 2: Monitoring Well Locations

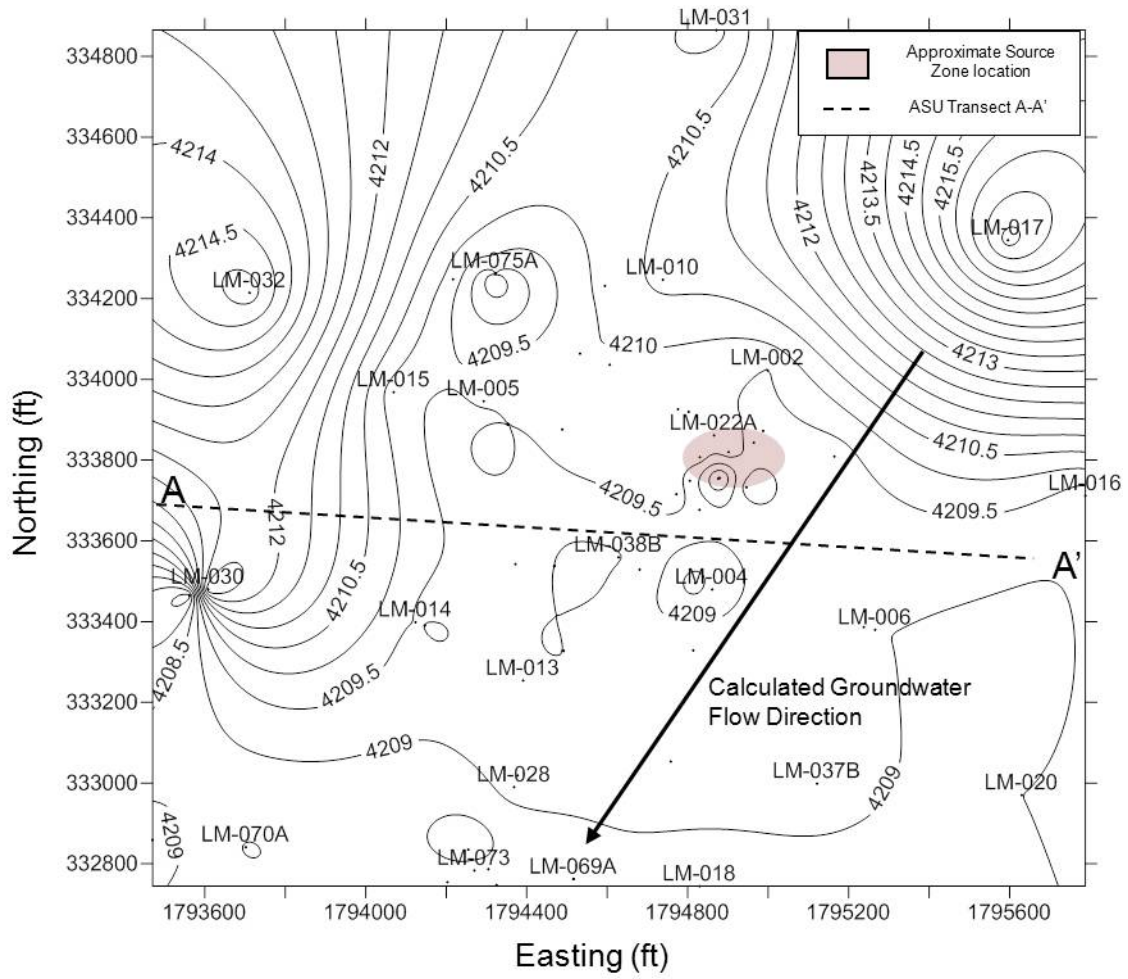

Figure 3: Groundwater Contour Map– April 10, 2009



Photo from Google Maps

Figure 4: Vapor Sampling Locations – Sludge Drying Beds

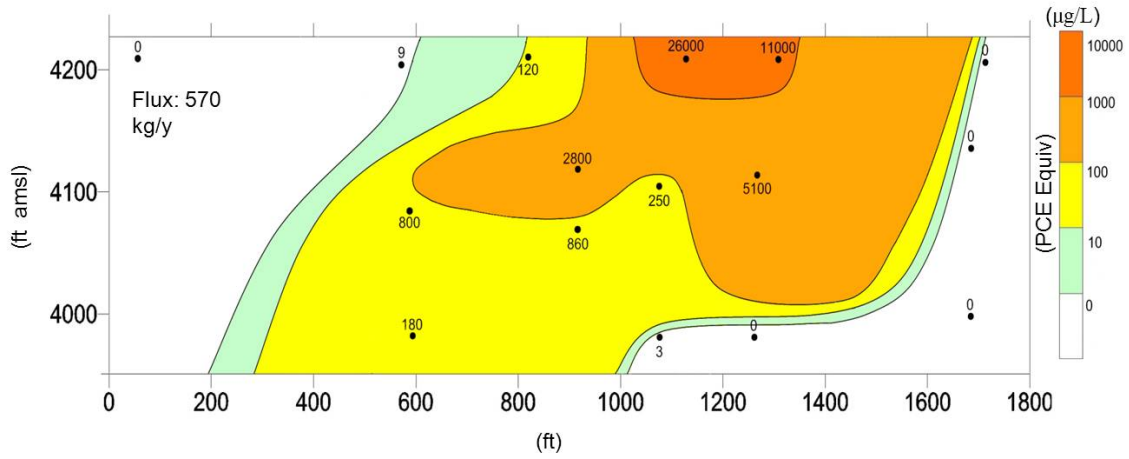

Figure 5A: Vertical Groundwater Concentration Contour Plot Along Transect A-A': Event 1 – July-Aug 2008

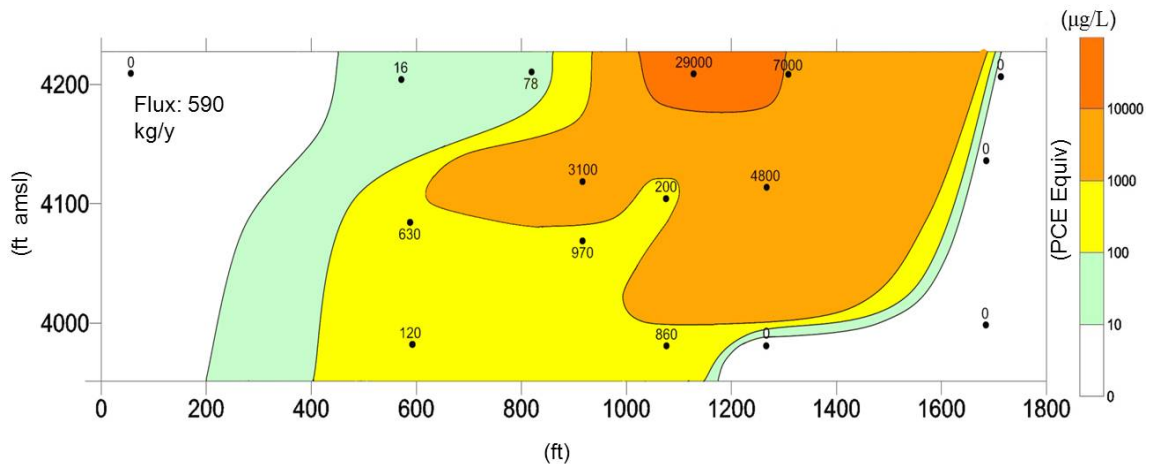

Figure 5B: Vertical Groundwater Concentration Contour Plot Along Transect A-A': Event 2 – Apr-May 2009

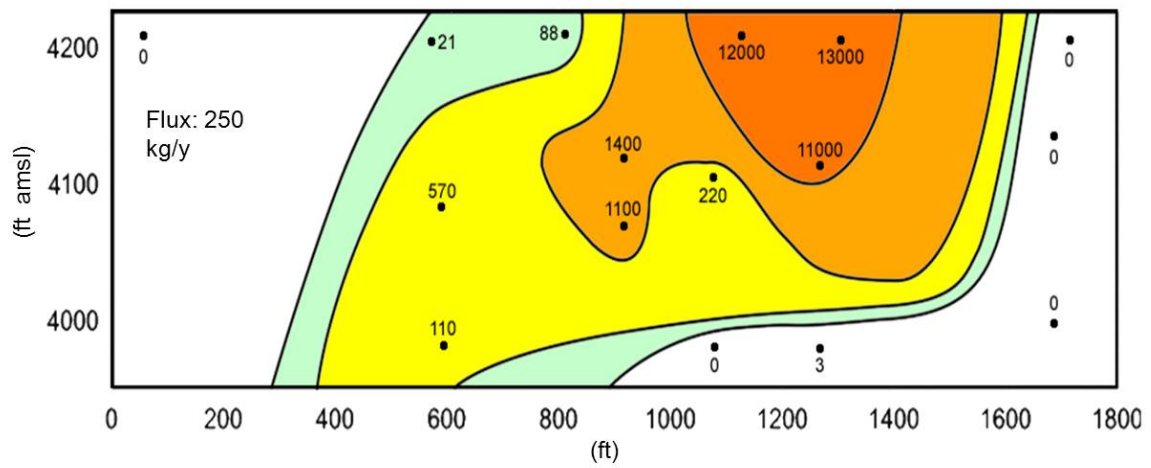

Figure 5C: Vertical Groundwater Concentration Contour Plot Along Transect A-A': Event 3 – September 2010: PCE Equivalence concentration values in µg/L

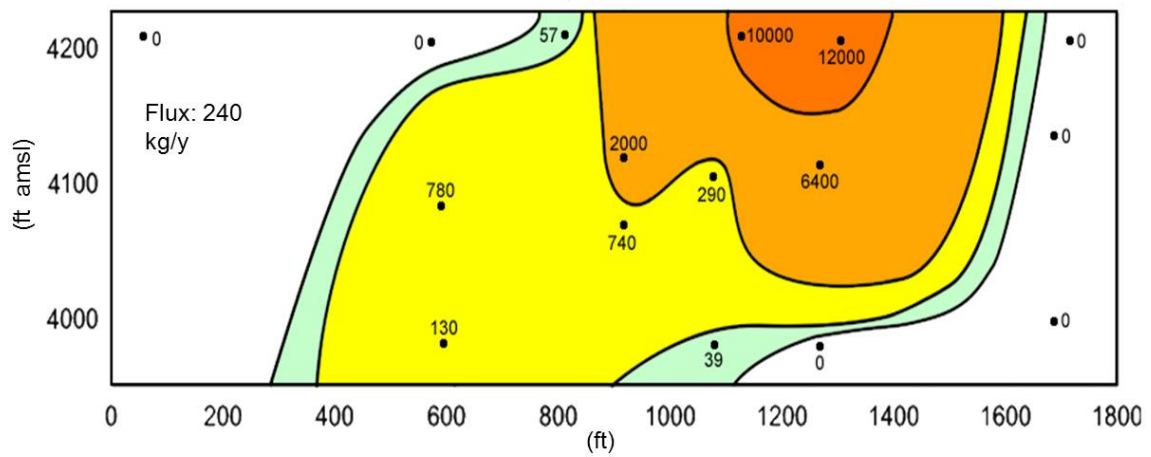

Figure 5D: Vertical Groundwater Concentration Contour Plot Along Transect A-A':

Event 4 – August 23, 2011

Input Data and Grid

Data Input Instructions
 Enter value directly
 Value calculated by model
 (Don't enter any data)

Site Location and I.D.: **Hill AFB**
 Description: **Little Mountain Test Annex**

4. CHOOSE TRANSECT **5. CHOOSE TIME PERIOD** 1

6. ENTER TRANSECT DATA
 6.1 Distance of Transect 1 from Source 100 (ft)

6.2 Darcy Velocity Hydraulic Conductivity 6.6 Sampling Interval Mid Point of Sampling Interval

6.3 Hydraulic Conductivity Units ft/d
 6.4 Uniform Hydraulic Conductivity? No
 6.5 Uniform Hydraulic Gradient? Yes

Hydraulic Gradient 8.50E-04 (ft/ft)

Monitoring Point	Distance of Monitoring Point from Start of Transect (ft)	Sampling Interval (ft MSL)		Plume Top (ft MSL)	Plume Bottom (ft MSL)	Hydraulic Conductivity (ft/d)	Concentration (ug/L)	
		Top	Bottom				Constituent A	Constituent B
		TCE						
1 Start of Transect	0						0	0
2 End of Transect	1720						0	0
3 4	1309	4208	4188	4220	3970	17.71	11000	
4 4B	1267	4116	4096	4220	3970	111.29	5100	
5 4B	1267	3983	3963	4220	3970	113.3	0	
6 6	1714	4209	4189	4220	3970	6.46	0	
7 6B	1685	4140	4120	4220	3970	15.6	0	
8 6B	1685	4002	3982	4220	3970	14.23	0	
9 7	820	4213	4193	4220	3970	10.27	120	
10 14	571	4207	4187	4220	3970	3.59	9	
11 30	56	4212	4192	4220	3970	3.73	0	
12 38A	1128	4212	4192	4220	3970	90	26000	
13 38B	1076	4108	4088	4220	3970	2.25	250	
14 38B	1076	3983	3963	4220	3970	113.2	3	
15 65A	916	4122	4102	4220	3970	130.3	2800	

7. CHOOSE GRID (OPTIONAL) **8. SELECT CONSTITUENT FOR CALCULATIONS**

Current Grid: Number of rows **10**, Number of columns **11**
 Refine Grid By: 1, Refined Grid: 10
1 11

TCE Constituent B

Next Step: Back to Transect Calculator Screen Import MW Data Export MW Data See Conc/Flux Grids

Continue Data Input Clear Screen Paste Example Restore Table Formatting Print HELP

Figure 6: Mass Flux Input Example: Event 1 – July-Aug 2008

Interpolation Error Results

Site Location and I.D.:
Description:

Hill AFB
Little Mountain Test Annex

without the monitoring point shown in column one.
4. The "Contribution of Selected Point to Total Mass Flux" column represents the percent contribution each removed point makes to the total mass flux calculated in the "Mass Flux Result" screen and shown on this screen as "Total Mass Flux Including All Points". If the percent change is large then there is high uncertainty in the mass flux calculation.

Next Step:
Mass Flux Summary

Back to Mass Flux Result

Print

Back to Data Input

HELP

SELECT TRANSECT TO VIEW

Transect 1

SELECT TIME PERIOD TO VIEW

1

TCE Interpolation Methods

Hydraulic Conductivity: Nearest Neighbor
Concentration: Nearest Neighbor
Hydraulic Gradient: Uniform

Total Mass Flux Including All Points

1.57E+03 (g/day)

						RESULTS		
End of Transect	Top of Sampling Interval	Bottom of Sampling Interval	Parameter Examined	Parameter Value Removed For Analysis	Parameter Units	Total Mass Flux Excluding Selected Point and Interpolating (g/day)	Contribution of Selected Point to Total Mass Flux (%)	
1	Start of Transect		Conductivity	3.73E+00	ft/d	1.57E+03	0.0	
2	4.00E+00	4208.0	4188.0	Conductivity	3.73E+00	ft/d	1.57E+03	0.0
3	4B	4116.0	4096.0	Conductivity	3.55E+00	ft/d	1.57E+03	0.0
4	4B	3983.0	3963.0	Conductivity	6.31E+01	ft/d	1.56E+03	0.6
5	6.00E+00	4209.0	4189.0	Conductivity	7.39E+01	ft/d	1.57E+03	0.1
6	6B	4140.0	4120.0	Conductivity	1.03E+01	ft/d	1.58E+03	-0.4
7	6B	4002.0	3982.0	Conductivity	1.30E+02	ft/d	1.52E+03	3.2
8	7.00E+00	4213.0	4193.0	Conductivity	1.41E+02	ft/d	1.56E+03	0.5
9	1.40E+01	4207.0	4187.0	Conductivity	2.25E+00	ft/d	1.58E+03	-0.9
10	3.00E+01	4212.0	4192.0	Conductivity	1.13E+02	ft/d	1.57E+03	0.0
11	38A	4212.0	4192.0	Conductivity	9.00E+01	ft/d	8.87E+02	43.6
12	38B	4108.0	4088.0	Conductivity	1.11E+02	ft/d	1.38E+03	12.4
13	38B	3983.0	3963.0	Conductivity	1.13E+02	ft/d	1.57E+03	0.0
14	65A	4122.0	4102.0	Conductivity	1.77E+01	ft/d	2.07E+03	-34.9
15	65A	4070.0	4050.0	Conductivity	1.56E+01	ft/d	1.57E+03	0.0
16	67A	4075.0	4055.0	Conductivity	1.42E+01	ft/d	1.57E+03	0.0
17	67A	3985.0	3965.0	Conductivity	6.45E+00	ft/d	1.57E+03	0.0
18	End of Transect		Conductivity	6.45E+00	ft/d	1.57E+03	0.0	
19	Start of Transect		Concentration	0.00E+00	ug/L	1.57E+03	0.0	
20	4.00E+00	4208.0	4188.0	Concentration	0.00E+00	ug/L	1.57E+03	0.0
21	4B	4116.0	4096.0	Concentration	9.00E+00	ug/L	1.57E+03	-0.2
22	4B	3983.0	3963.0	Concentration	8.00E+02	ug/L	1.53E+03	2.8
23	6.00E+00	4209.0	4189.0	Concentration	1.80E+02	ug/L	1.59E+03	-1.4
24	6B	4140.0	4120.0	Concentration	1.20E+02	ug/L	1.58E+03	-0.8
25	6B	4002.0	3982.0	Concentration	2.80E+03	ug/L	1.43E+03	9.0
26	7.00E+00	4213.0	4193.0	Concentration	8.60E+02	ug/L	1.78E+03	-13.5
27	1.40E+01	4207.0	4187.0	Concentration	2.50E+02	ug/L	1.59E+03	-1.1
28	30	4212	4192	Concentration	3.00E+00	ug/L	1.58E+03	-0.6
29	38A	4212	4192	Concentration	2.60E+04	ug/L	8.76E+02	44.3
30	38B	4108	4088	Concentration	5.10E+03	ug/L	1.64E+03	-4.3
31	38B	3983	3963	Concentration	0.00E+00	ug/L	1.88E+03	-19.9
32	65A	4122	4102	Concentration	1.10E+04	ug/L	1.52E+03	3.2
33	65A	4070	4050	Concentration	0.00E+00	ug/L	1.57E+03	0.0
34	67A	4075	4055	Concentration	0.00E+00	ug/L	1.57E+03	0.0
35	67A	3985	3965	Concentration	0.00E+00	ug/L	1.57E+03	0.0
36	End of Transect		Concentration	0.00E+00	ug/L	1.57E+03	0.0	

Figure 10A: Uncertainty Analysis: Event 1 – July-Aug 2008

Interpolation Error Results

Site Location and I.D.: Hill AFB
 Description: Little Mountain Test Annex

Next Step: Mass Flux Summary

Buttons: Back to Mass Flux Result, Print, Back to Data Input, HELP

SELECT TRANSECT TO VIEW: Transect 1
 SELECT TIME PERIOD TO VIEW: 2

without the monitoring point shown in column one.
 4. The "Contribution of Selected Point to Total Mass Flux" column represents the percent contribution each removed point makes to the total mass flux calculated in the "Mass Flux Result" screen and shown on this screen as "Total Mass Flux Including All Points". If the percent change is large then there is high uncertainty in the mass flux calculation.

TCE Interpolation Methods
 Hydraulic Conductivity: Nearest Neighbor
 Concentration: Nearest Neighbor
 Hydraulic Gradient: Uniform

Total Mass Flux Including All Points: 1.65E+03 (g/day)

						RESULTS		
End of Transect	Top of Sampling Interval	Bottom of Sampling Interval	Parameter Examined	Parameter Value Removed For Analysis	Parameter Units	Total Mass Flux Excluding Selected Point and Interpolating (g/day)	Contribution of Selected Point to Total Mass Flux (%)	
1	Start of Transect		Conductivity	3.73E+00	ft/d	1.65E+03	0.0	
2	4.00E+00	4208.0	4188.0	Conductivity	3.73E+00	ft/d	1.65E+03	0.0
3	4B	4116.0	4096.0	Conductivity	3.59E+00	ft/d	1.65E+03	-0.1
4	4B	3983.0	3963.0	Conductivity	6.31E+01	ft/d	1.64E+03	0.4
5	6.00E+00	4209.0	4189.0	Conductivity	7.39E+01	ft/d	1.64E+03	0.0
6	6B	4140.0	4120.0	Conductivity	1.03E+01	ft/d	1.65E+03	-0.3
7	6B	4002.0	3982.0	Conductivity	1.30E+02	ft/d	1.59E+03	3.4
8	7.00E+00	4213.0	4193.0	Conductivity	1.41E+02	ft/d	1.64E+03	0.5
9	1.40E+01	4207.0	4187.0	Conductivity	2.25E+00	ft/d	1.66E+03	-0.7
10	3.00E+01	4212.0	4192.0	Conductivity	1.13E+02	ft/d	1.61E+03	2.1
11	38A	4212.0	4192.0	Conductivity	9.00E+01	ft/d	8.82E+02	46.4
12	38B	4108.0	4088.0	Conductivity	1.11E+02	ft/d	1.46E+03	11.1
13	38B	3983.0	3963.0	Conductivity	1.13E+02	ft/d	1.65E+03	0.0
14	65A	4122.0	4102.0	Conductivity	1.77E+01	ft/d	1.96E+03	-19.4
15	65A	4070.0	4050.0	Conductivity	1.56E+01	ft/d	1.65E+03	0.0
16	67A	4075.0	4055.0	Conductivity	1.42E+01	ft/d	1.65E+03	0.0
17	67A	3985.0	3965.0	Conductivity	6.46E+00	ft/d	1.65E+03	0.0
18	End of Transect		Conductivity	6.46E+00	ft/d	1.65E+03	0.0	
19	Start of Transect		Concentration	0.00E+00	ug/L	1.65E+03	0.0	
20	4.00E+00	4208.0	4188.0	Concentration	0.00E+00	ug/L	1.65E+03	0.0
21	4B	4116.0	4096.0	Concentration	1.60E+01	ug/L	1.65E+03	-0.1
22	4B	3983.0	3963.0	Concentration	6.30E+02	ug/L	1.61E+03	2.1
23	6.00E+00	4209.0	4189.0	Concentration	1.20E+02	ug/L	1.66E+03	-1.1
24	6B	4140.0	4120.0	Concentration	7.80E+01	ug/L	1.66E+03	-0.9
25	6B	4002.0	3982.0	Concentration	3.10E+03	ug/L	1.49E+03	9.6
26	7.00E+00	4213.0	4193.0	Concentration	9.70E+02	ug/L	1.88E+03	-14.2
27	1.40E+01	4207.0	4187.0	Concentration	2.00E+02	ug/L	1.67E+03	-1.2
28	30	4212	4192	Concentration	8.60E+02	ug/L	1.62E+03	1.7
29	38A	4212	4192	Concentration	2.90E+04	ug/L	8.68E+02	47.3
30	38B	4108	4088	Concentration	4.80E+03	ug/L	1.55E+03	5.5
31	38B	3983	3963	Concentration	0.00E+00	ug/L	1.94E+03	-17.9
32	65A	4122	4102	Concentration	7.00E+03	ug/L	1.63E+03	1.2
33	65A	4070	4050	Concentration	0.00E+00	ug/L	1.65E+03	0.0
34	67A	4075	4055	Concentration	0.00E+00	ug/L	1.65E+03	0.0
35	67A	3985	3965	Concentration	0.00E+00	ug/L	1.65E+03	0.0
36	End of Transect		Concentration	0.00E+00	ug/L	1.65E+03	0.0	

Figure 10B: Uncertainty Analysis: Event 2 – Apr-May 2009

Interpolation Error Results

Site Location and I.D.:
Description:

Hill AFB
Little Mountain Test Annex

INSTRUCTIONS

1. The table below shows all concentration and, if applicable, non-uniform conductivity/Darcy velocity and gradient input data.
2. During the uncertainty analysis, each of the points in the table are removed one at a time and the mass flux calculated without that point using the interpolation scheme specified in the Data Input section (note that

[Next Step: Mass Flux Summary](#)
[Back to Mass Flux Result](#)
[Print](#)

[Back to Data Input](#)
[HELP](#)

SELECT TRANSECT TO VIEW: Transect 1
 SELECT TIME PERIOD TO VIEW: 3

TCE Interpolation Methods

Hydraulic Conductivity: Nearest Neighbor
 Concentration: Nearest Neighbor
 Hydraulic Gradient: Uniform

Total Mass Flux Including All Points

7.16E+02 (g/day)

						RESULTS		
End of Transect	Top of Sampling Interval	Bottom of Sampling Interval	Parameter Examined	Parameter Value Removed For Analysis	Parameter Units	Total Mass Flux Excluding Selected Point and Interpolating (g/day)	Contribution of Selected Point to Total Mass Flux (%)	
1	Start of Transect		Conductivity	1.60E-03	cm/sec	7.16E+02	0.0	
2	4.00E+00	4208.0	4188.0	Conductivity	1.60E-03	cm/sec	7.16E+02	0.0
3	4B	4116.0	4096.0	Conductivity	1.60E-03	cm/sec	7.17E+02	-0.1
4	4B	3983.0	3963.0	Conductivity	3.00E-02	cm/sec	6.98E+02	2.6
5	6.00E+00	4209.0	4189.0	Conductivity	2.80E-02	cm/sec	7.17E+02	-0.1
6	6B	4140.0	4120.0	Conductivity	3.20E-02	cm/sec	7.15E+02	0.2
7	6B	4002.0	3982.0	Conductivity	3.80E-02	cm/sec	6.66E+02	7.0
8	7.00E+00	4213.0	4193.0	Conductivity	1.20E-02	cm/sec	7.57E+02	-5.7
9	1.40E+01	4207.0	4187.0	Conductivity	7.50E-04	cm/sec	7.23E+02	-1.0
10	3.00E+01	4212.0	4192.0	Conductivity	4.20E-03	cm/sec	7.16E+02	0.0
11	38A	4212.0	4192.0	Conductivity	3.20E-02	cm/sec	4.05E+02	43.4
12	38B	4108.0	4088.0	Conductivity	2.70E-03	cm/sec	1.07E+03	-50.0
13	38B	3983.0	3963.0	Conductivity	3.70E-02	cm/sec	6.97E+02	2.7
14	65A	4122.0	4102.0	Conductivity	7.20E-03	cm/sec	6.58E+02	8.1
15	65A	4070.0	4050.0	Conductivity	6.00E-03	cm/sec	7.17E+02	-0.1
16	67A	4075.0	4055.0	Conductivity	6.00E-03	cm/sec	7.16E+02	0.0
17	67A	3985.0	3965.0	Conductivity	3.50E-03	cm/sec	7.16E+02	0.0
18	End of Transect		Conductivity	3.50E-03	cm/sec	7.16E+02	0.0	
19	Start of Transect		Concentration	0.00E+00	ug/L	7.16E+02	0.0	
20	4.00E+00	4208.0	4188.0	Concentration	0.00E+00	ug/L	7.16E+02	0.0
21	4B	4116.0	4096.0	Concentration	2.10E+01	ug/L	7.17E+02	-0.2
22	4B	3983.0	3963.0	Concentration	5.70E+02	ug/L	6.66E+02	6.9
23	6.00E+00	4209.0	4189.0	Concentration	1.10E+02	ug/L	7.41E+02	-3.5
24	6B	4140.0	4120.0	Concentration	8.80E+01	ug/L	7.53E+02	-5.1
25	6B	4002.0	3982.0	Concentration	1.40E+03	ug/L	6.98E+02	2.5
26	7.00E+00	4213.0	4193.0	Concentration	1.10E+03	ug/L	7.18E+02	-0.3
27	1.40E+01	4207.0	4187.0	Concentration	2.20E+02	ug/L	7.23E+02	-1.0
28	30	4212	4192	Concentration	0.00E+00	ug/L	7.18E+02	-0.2
29	38A	4212	4192	Concentration	1.20E+04	ug/L	4.98E+02	30.4
30	38B	4108	4088	Concentration	1.10E+04	ug/L	6.78E+02	5.4
31	38B	3983	3963	Concentration	3.00E+00	ug/L	1.10E+03	-53.7
32	65A	4122	4102	Concentration	1.30E+04	ug/L	6.39E+02	10.8
33	65A	4070	4050	Concentration	0.00E+00	ug/L	7.84E+02	-9.5
34	67A	4075	4055	Concentration	0.00E+00	ug/L	7.16E+02	0.0
35	67A	3985	3965	Concentration	0.00E+00	ug/L	7.16E+02	0.0
36	End of Transect		Concentration	0.00E+00	ug/L	7.16E+02	0.0	

Figure 10C: Uncertainty Analysis: Event 3 – September 2010

Interpolation Error Results

Site Location and I.D.: Hill AFB
 Description: Little Mountain Test Annex

INSTRUCTIONS:
 1. The table below shows all concentration and, if applicable, non-uniform conductivity/Darcy velocity and gradient input data.
 2. During the uncertainty analysis, each of the points in the table are removed one at a time and the mass flux calculated without that point using the interpolation scheme specified in the Data Input section (note that

Next Step: **Mass Flux Summary**

Buttons: Back to Mass Flux Result, Print, Back to Data Input, HELP

SELECT TRANSECT TO VIEW: Transect 1
 SELECT TIME PERIOD TO VIEW: 4

TCE Interpolation Methods
 Hydraulic Conductivity: Nearest Neighbor
 Concentration: Nearest Neighbor
 Hydraulic Gradient: Uniform

Total Mass Flux Including All Points: **6.64E+02** (g/day)

						RESULTS	
End of Transect	Top of Sampling Interval	Bottom of Sampling Interval	Parameter Examined	Parameter Value Removed For Analysis	Parameter Units	Total Mass Flux Excluding Selected Point and Interpolating (g/day)	Contribution of Selected Point to Total Mass Flux (%)
1 Start of Transect			Conductivity	1.60E-03	cm/sec	6.64E+02	0.0
2 4.00E+00	4208.0	4188.0	Conductivity	1.60E-03	cm/sec	6.64E+02	0.0
3 4B	4116.0	4096.0	Conductivity	1.60E-03	cm/sec	6.64E+02	0.0
4 4B	3963.0	3963.0	Conductivity	3.00E-02	cm/sec	6.39E+02	3.8
5 6.00E+00	4209.0	4189.0	Conductivity	2.80E-02	cm/sec	6.64E+02	-0.1
6 6B	4140.0	4120.0	Conductivity	3.20E-02	cm/sec	6.63E+02	0.1
7 6B	4002.0	3962.0	Conductivity	3.80E-02	cm/sec	5.94E+02	10.6
8 7.00E+00	4213.0	4193.0	Conductivity	1.20E-02	cm/sec	6.92E+02	-4.3
9 1.40E+01	4207.0	4187.0	Conductivity	7.50E-04	cm/sec	6.72E+02	-1.3
10 3.00E+01	4212.0	4192.0	Conductivity	4.20E-03	cm/sec	6.64E+02	0.0
11 38A	4212.0	4192.0	Conductivity	3.20E-02	cm/sec	4.05E+02	39.1
12 38B	4108.0	4088.0	Conductivity	2.70E-03	cm/sec	8.72E+02	-31.4
13 38B	3963.0	3963.0	Conductivity	3.70E-02	cm/sec	6.53E+02	1.7
14 65A	4122.0	4102.0	Conductivity	7.20E-03	cm/sec	6.11E+02	8.0
15 65A	4070.0	4050.0	Conductivity	6.00E-03	cm/sec	6.65E+02	-0.1
16 67A	4075.0	4055.0	Conductivity	6.00E-03	cm/sec	6.64E+02	0.0
17 67A	3965.0	3965.0	Conductivity	3.50E-03	cm/sec	6.64E+02	0.0
18 End of Transect			Conductivity	3.50E-03	cm/sec	6.64E+02	0.0
19 Start of Transect			Concentration	0.00E+00	ug/L	6.64E+02	0.0
20 4.00E+00	4208.0	4188.0	Concentration	0.00E+00	ug/L	6.64E+02	0.0
21 4B	4116.0	4096.0	Concentration	0.00E+00	ug/L	6.66E+02	-0.3
22 4B	3963.0	3963.0	Concentration	7.80E+02	ug/L	5.93E+02	10.6
23 6.00E+00	4209.0	4189.0	Concentration	1.30E+02	ug/L	6.99E+02	-5.3
24 6B	4140.0	4120.0	Concentration	5.70E+01	ug/L	7.19E+02	-8.3
25 6B	4002.0	3962.0	Concentration	2.00E+03	ug/L	6.03E+02	9.2
26 7.00E+00	4213.0	4193.0	Concentration	7.40E+02	ug/L	6.87E+02	-3.4
27 1.40E+01	4207.0	4187.0	Concentration	2.90E+02	ug/L	6.70E+02	-0.9
28 30	4212	4192	Concentration	3.90E+01	ug/L	6.65E+02	-0.2
29 38A	4212	4192	Concentration	1.00E+04	ug/L	4.73E+02	28.7
30 38B	4108	4088	Concentration	6.40E+03	ug/L	6.53E+02	1.7
31 38B	3963	3963	Concentration	0.00E+00	ug/L	8.88E+02	-33.7
32 65A	4122	4102	Concentration	1.20E+04	ug/L	5.71E+02	14.1
33 65A	4070	4050	Concentration	0.00E+00	ug/L	7.27E+02	-9.5
34 67A	4075	4055	Concentration	0.00E+00	ug/L	6.64E+02	0.0
35 67A	3965	3965	Concentration	0.00E+00	ug/L	6.64E+02	0.0
36 End of Transect			Concentration	0.00E+00	ug/L	6.64E+02	0.0

Figure 10D: Uncertainty Analysis: Event 4 – August 2011

APPENDIX E: DISTURBANCE TESTING

Chapter 5 from:

Ekre, R., 2013, Source Zone Mass Depletion of Chlorinated Aliphatic Hydrocarbons:
Estimation of Rates and Insight into Source Architecture: Doctoral Dissertation, Arizona State
University, April 2013.

Chapter 5

CHARACTERIZING DNAPL SOURCE ZONE ARCHITECTURE THROUGH GROUNDWATER TRANSECT SAMPLING AND DISTURBANCE TESTING

5.1 Introduction

The source zone mass depletion rates calculated using the source zone natural attenuation (SZNA) assessment approach introduced in Chapter 2, are specific to the points in time when data are collected. Project managers, regulators, and others parties are also interested in projecting how those rates might change in the future (the “Group III” questions in Chapter 2); however, a detailed understanding of the source zone is needed to make those projections. For example, an understanding of where the source zone mass is stored and factors controlling source zone mass release are needed. “Source zone architecture” is a term that has been used in recent years to refer to the source zone mass distribution and its relationship to the subsurface geology (Sale and McWhorter, 2001; Lemke et al., 2004; Fure et al., 2006; Lemke and Abriola, 2006;). Except for hypothetical modeling exercises and idealized controlled release studies where the source zone architecture is created or easily visualized, it is not clear that any practicable ways of sufficiently characterizing source zone architecture have emerged.

The source zone architecture, especially if it contains dense non-aqueous phase liquid (DNAPL), is expected to be complex and highly variable in space. Absent a confining layer, large DNAPL spills can penetrate deep into aquifers, with lateral diversions caused by changes in soil structure. This may result in multi-level pooling, long ganglia, and dissolved sources in low permeability zones, which leads to spatially variable depletion rates under natural and engineered treatment scenarios.

This need for source zone architecture information is not unique to the assessment of SZNA. For example, many DNAPL researchers have assumed known or idealized source zone architecture as foundational components of their studies and modeling approaches. In addition, this information is also critical to optimal selection, design, and operation of in situ treatment systems. For example, one key conclusion from ESTCP project ER0314 (“*Critical Evaluation of State-of-the-Art In Situ Thermal Treatment Technologies for DNAPL Source Zone Treatment*”), was that inadequate characterization of even the most basic source zone architecture information (location, length, width, depth) was leading to under-designed in situ thermal remediation systems and only partially-treated source zones (Stroo et al., 2012; Triplett-Kingston et al., 2010).

Locating and characterizing a DNAPL-impacted source zone usually involves discrete soil coring and sampling of monitoring wells, followed by laboratory chemical analyses of the soil and water samples. Professional judgment is then used to determine the extent of the source

zone and to occasionally estimate the DNAPL mass present. As mentioned above, studying the experience of many projects suggests that this approach leads to poor delineation, and generally underestimation of source zone extent. In addition, current site assessment technologies are insufficient for determining source zone architectural details required in modeling, such as pool to ganglia ratios (Stroo et al., 2012).

Thus, practicable alternative or complementary approaches to conventional source zone characterization are needed to minimize the potential for under-designing treatment systems and to be able to project the future trajectory for source zone natural attenuation at any given site. Exploring innovations in practicable source zone characterization is the focus of this chapter, which discusses a possible two-step source characterization process:

- Delineating the location, length, width and depth of the source zone through use of sampling transects, and then
- Assessing the architecture and release characteristics of different regions of the source zone using system disturbances and responses.

5.2 Delineating the Location, Length, Width and Depth of the Source Zone through Use of Sampling Transects

Delineating the location, length, width and depth of the source zone is well-accepted as being critical to treatment technology selection, design, operation and monitoring; it is also critical to assessing SZNA. Despite that, experience suggests that conventional sampling approaches and subsequent data reduction using randomly- or regularly-spaced sampling locations often lead to poor delineation at even the most basic level.

The use of a different approach has been explored in this work, utilizing as a first step a multi-depth groundwater sampling transect oriented perpendicular to groundwater flow and placed just down-gradient of the suspected source zone location. Experiences from the field work discussed in Chapter 3, suggest that this approach can quickly provide a much clearer and more confident assessment of the source zone width and depth and some insight to the spatial variability.

Figures 5.1 illustrate this approach conceptually and Figure 5.2 present sample data from a site outlined in Chapter 3. The variation in concentrations with depth and width within the transect quickly provide valuable insight as to the general nature of the sources as seen in Figures 5.2 and 5.3.

Once the source zone width and depth have been estimated, the source zone length can be determined by conducting additional multi-depth groundwater sampling transects moving up-gradient of the first one as illustrated in Figure 5.1 where the disturbance location transect would represent another transect used to delineate the length of the source, Figures 5.3 and 5.4 present this sampling approach at Site 2 from Chapter 3.

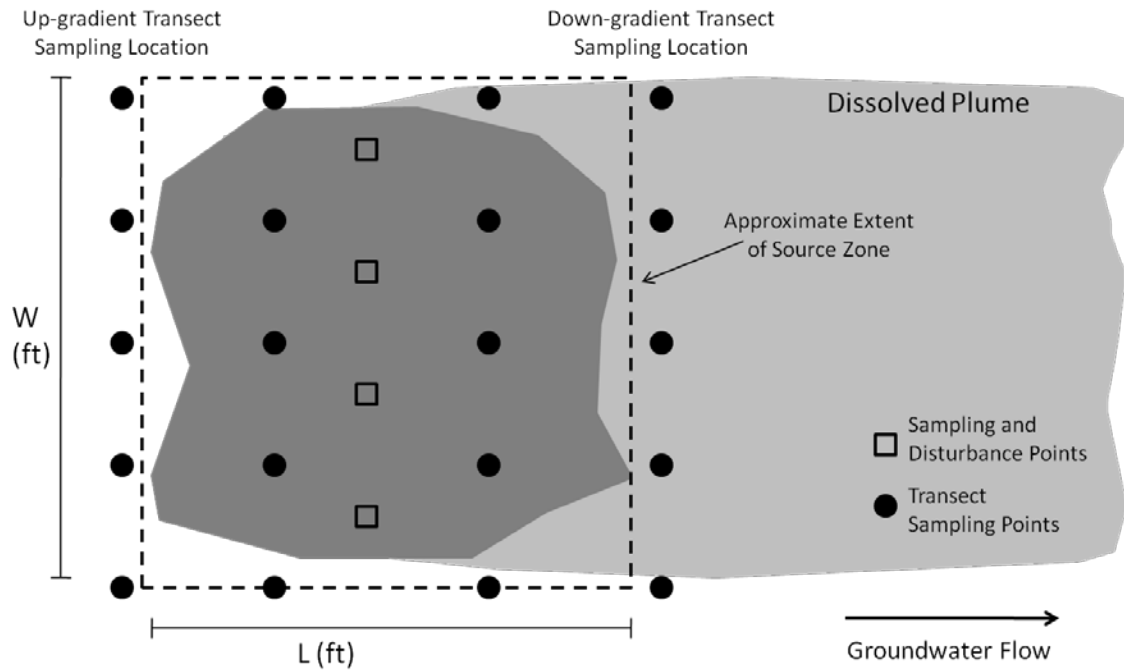

Figure 5.1: Plan view schematic illustrating the multiple transect approach to source delineation and locations for system disturbance tests.

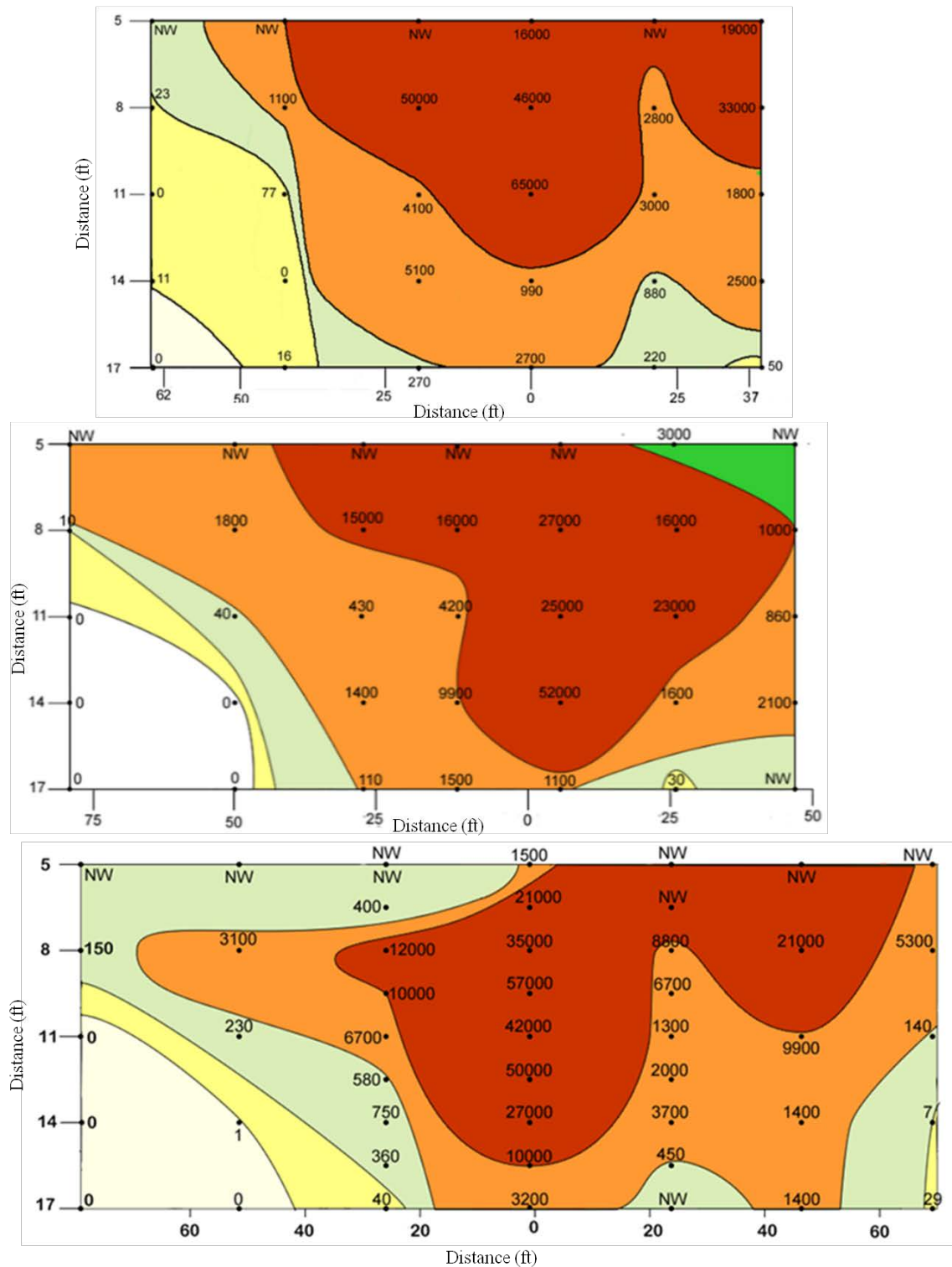

Figure 5.2: Site 2 - event 3: successive (C, B, A) vertical transect contour plots oriented perpendicular to groundwater flow with PCE Equivalent concentrations ($\mu\text{g/L}$).

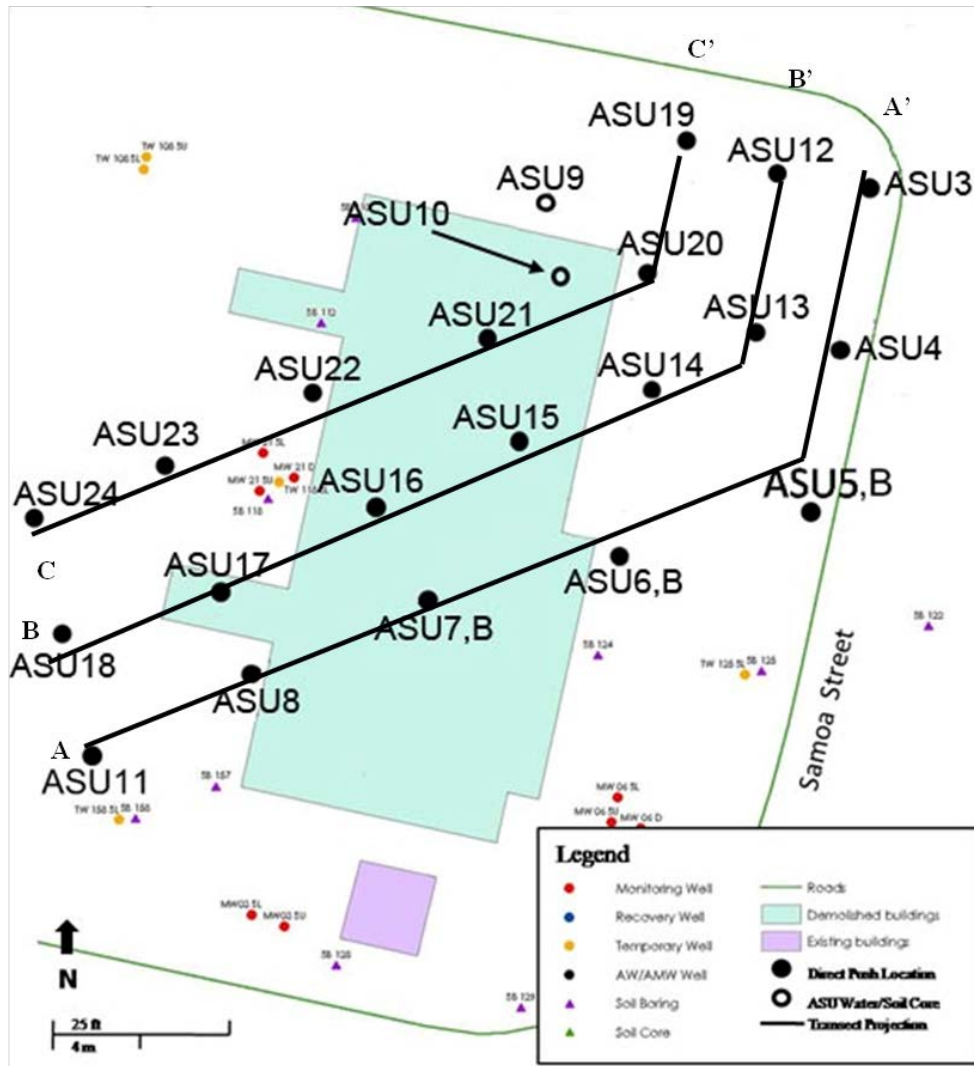

Figure 5.3: Site 2 - event 3: plan view of successive transect sampling.

5.3 Probing the Architecture of Different Regions of the Source Zone Using System Disturbances and Responses

The transect-based approach above is a practicable way to assess the gross characteristics of the source zone (location, length, width, thickness, source strength). Additional independent characterization tools are needed, however, if one wishes to better understand the detailed nature of the mass storage: DNAPL pools, ganglia, and dissolved contaminants in non-transmissive zones.

The use of macro-scale inter-well partitioning tracer tests has been explored by others as a means of estimating DNAPL mass within a given zone (Annable et al., 1998), but this approach has not gained widespread use. The partitioning tracer concept has also been adapted to single-well push-pull tests with some proof-of-concept success at DNAPL saturation measurement (Istok et al., 2002). The advantage of these is that much less volume of water is

produced during the testing phase, thereby making the logistics of the testing easier. In either case the testing results in an estimated average pore concentration of NAPL within the test region which may provide useful information regarding source mass. However the testing provides little insight to source structure (e.g., ganglia vs. pools), which controls source zone mass release vs. time behavior.

The alternative explored here at the laboratory proof-of-concept level is the use of *in-situ* system disturbances to probe source zone characteristics. The basic hypothesis is that the post-disturbance transient response of a system reveals information about that system. One example that many are familiar with in the DoD context is the use of respirometry testing for assessing aerobic biodegradation rates at petroleum hydrocarbon sites; in that case the disturbance is the addition of air and the response that is tracked is the oxygen depletion with time (Aichinger et al., 1992; Davis et al., 2007, AFCEE, 1995). Another example is the short-term injection of air below the water table at air sparging sites and monitoring the transient pressure pulse (Johnson et al., 2001). The shape of the pressure vs. time response reveals information about the air distribution about the injection well. In the field work described in Chapter 3, disturbances (injection and recovery of a tracer gas) are used to estimate effective vapor phase diffusion coefficients (Johnson et al., 1998).

Following on this theme, a source zone characterization approach that involves two basic steps is envisioned:

- The location, length, width, thickness, and current discharge strength of the source zone are characterized as above using multiple multi-depth transects.
- Specific portions of the source are identified as being of interest (e.g., high concentration zones) and are then disturbed and localized responses vs. time are measured. The disturbance locations are selected based on the transect information from the first step.
- The disturbance response vs. time data are then analyzed and source zone features are extracted from the data reduction.

In the case where the dissolved concentration is monitored, it is hypothesized that the concentration vs. time response can be used to infer mass storage and mass release characteristics of the source zone.

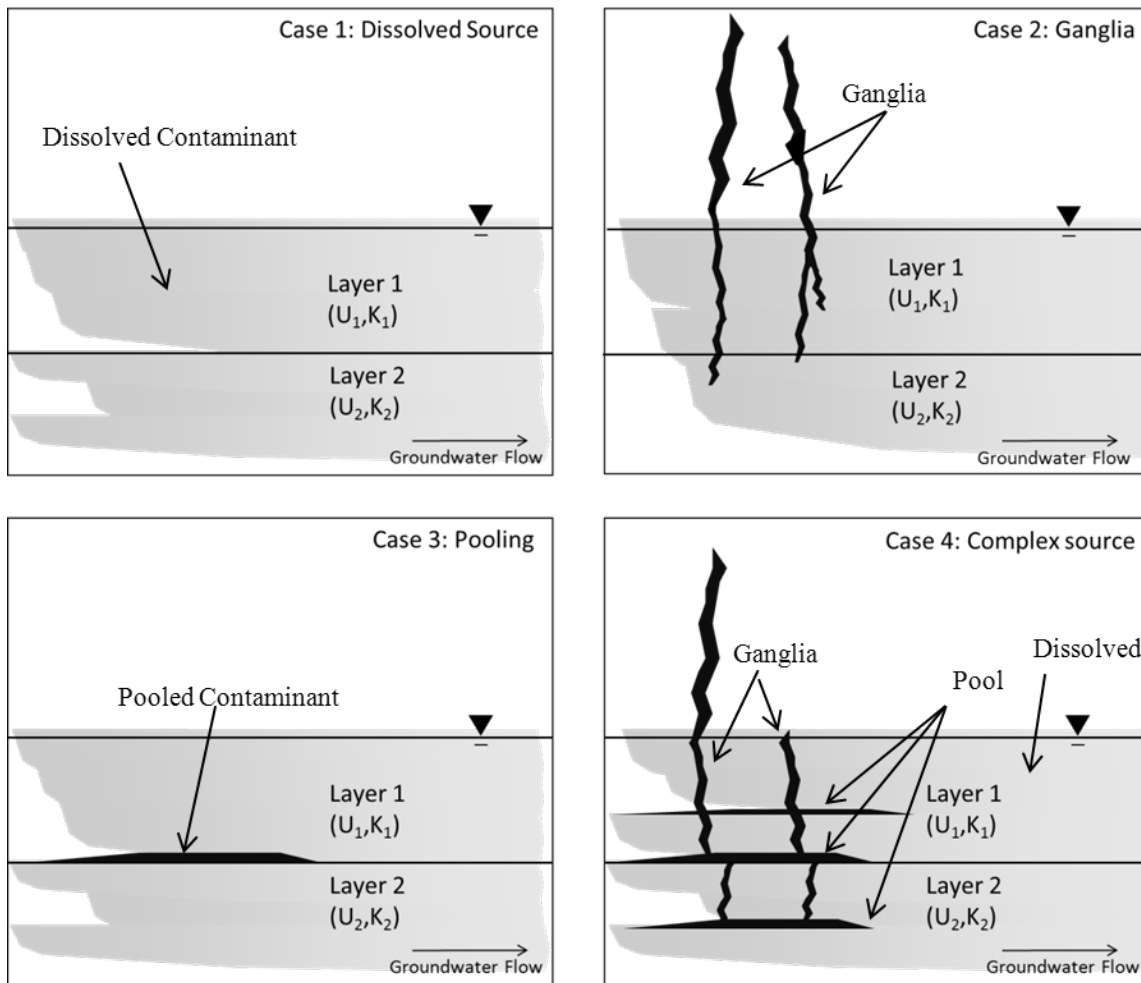

Figure 5.4: Idealized DNAPL source architectures.

At a very simplistic level, one can consider DNAPL source zone architectures as being aggregates of four basic building blocks: DNAPL pools, DNAPL ganglia, DNAPL penetrated into non-transmissive (low permeability) zones, and dissolved phase storage in non-transmissive zones. For example, four idealized architectures, or combinations of these building blocks, are shown in Figure 5.4. Knowing which of these building blocks are present in a given source would be valuable information for SZNA assessment and treatment technology selection.

5.4 Proof of Concept Testing at the Laboratory Scale

As discussed above, it is hypothesized that the post-disturbance transient response of a system reveals information about that system; in this case the source zone chemical distribution is disturbed and then the dissolved concentration response is monitored.

Proof-of-concept testing is used below to assess if the rebound of dissolved DNAPL chemical concentration following a system perturbation could provide insight to which of the four source zone architecture building blocks are present at a site. We anticipate that in certain

instances, such as Case 4 in Figure 5.4, that one aspect of the system may mask another; for example, when pools and ganglia are both present, sequential disturbances might be necessary to discern if one or the other or both are present. Possible approaches for creating system disturbances are discussed below.

5.4.1 System Disturbance Options.

Remediation technology selection (e.g., in situ chemical oxidation (ISCO), electrical resistive heating (ERH), bioremediation, air sparging, soil vapor extraction) often involves short-term pilot-scale testing, and these short-term tests are forms of system disturbances. One goal of this proof-of-concept experimentation is to identify ways to leverage existing practices to minimize costs while providing significant additional benefit for understanding the structure of the source. Possible disturbances include:

1. Injection of clean water
2. Air sparging
3. In situ chemical oxidant (ISCO) or other reactant delivery
4. Localized soil heating

It is imagined that there is a strategic ordering of different disturbances that reflects what can be learned from each. For example, the presence or absence of DNAPL ganglia and pools might be readily determined from clean water injections alone, while distinguishing between ganglia and pools might require a more aggressive disturbance like ISCO delivery or localized heating.

5.5 Physical Model Studies: Materials and Methods.

5.5.1 Overview.

A two-dimensional physical aquifer model was constructed of 314 stainless steel with internal dimensions of approximately 1.22 m x 1.22 m x 0.1 m (4 ft x 4 ft x 2 in). A 3/4-inch thick piece of transparent Plexiglas was used on the front of the tank to allow viewing of the model aquifer. Sampling ports were installed in the Plexiglas and consisted of 0.32 cm (1/8 inch) stainless steel Swagelok fittings fitted with Restek thermolite septa.

Water inlet and outlet ports used 1.27 cm (1/2 in) stainless steel Swagelok fittings installed in the bottom of the tank approximately 2 cm from the left and right side of the tank. A straight thread was bored in the tank to allow a 1.27 cm (1/2 in) Geoprobe PVC well screen to be threaded into the opposite side (within tank) for water distribution. The well screen extended from above the lower granite layer through the gravel layer at the top of the tank. A schematic of the laboratory tank is presented in Figures 5.5 and 5.6.

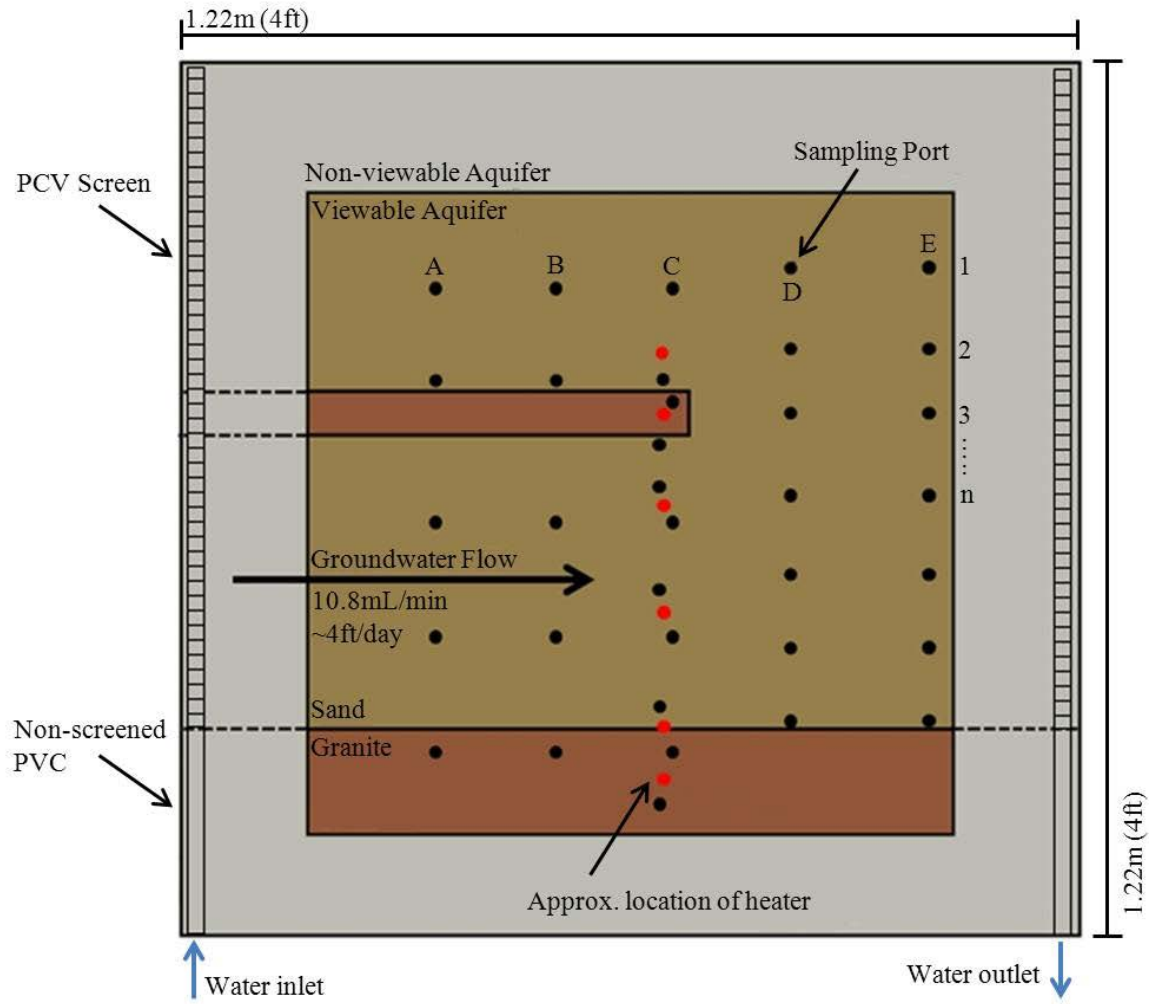

Notes: Ports are labeled A-E from right to left, and 1 to n from top to bottom

Figure 5.5: Overview of tank.

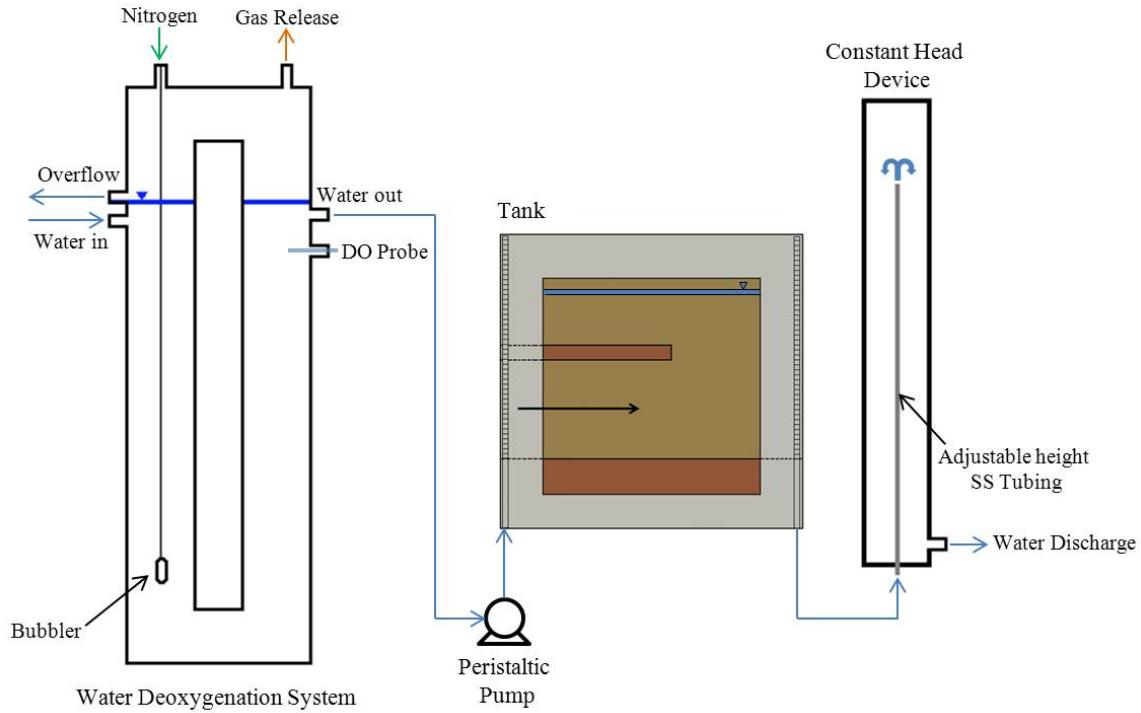

Figure 5.6: Experimental schematic.

5.5.2 Packing Structure and Porous Materials.

In order to create the basic source architecture components (pools, ganglia, dissolved), it was necessary to have contrasting soil layers within the tank. To accomplish this, two types of aquifer materials (50 mesh sand, decomposed granite) were chosen based on their contrasting hydraulic properties (three orders of magnitude difference in hydraulic conductivity). In addition, the two materials have contrasting colors, allowing for easy viewing of the aquifer structure.

The more permeable medium sand comprised the majority of the aquifer while the decomposed granite was used to create low permeability layers where NAPL could pool. Properties of the aquifer materials are provided in Table 5.1.

Table 5.1

Aquifer Material Properties

Material	f_{oc} [g-OC/g-soil]	Hydraulic Conductivity [cm/s]	Porosity [cm ³ -pores/cm ³ - soil]	Bulk Density [g-soil/cm ³ - soil]	Plasticity Index
Sand	0.23%	6.1×10^{-2}	0.32	1.58	NA
Decomposed Granite	1.8%	3.3×10^{-6}	0.40	1.73	6.9

The aquifer materials were packed into the tank dry in approximately 10-15 cm (4-6 in) lifts that were compacted by pounding. During the filling of the tank stainless steel conductive heaters were placed into the soil through Swagelok ports installed in the back of the tank. The heaters were custom ordered from Chromalox; the 300 watt cartridge heaters were 0.64 cm diameter x 10 cm long (1/4 in x 4 in) with a stainless steel sheath and a 1.3 cm (0.5 in) cold section. Locations of heaters in tank apparatus are displayed in Figure 5.5.

Following the packing, the tank was saturated from the bottom up, by gravity feed of deoxygenated reverse osmosis (RO) water over the course of approximately one week. During that time, approximately 35 L of water were used to saturate the soils. This measured volume closely matches the calculated theoretical value using an estimated soil porosity and tank dimensions and is reinforced by tracer test data.

After the tank was saturated, horizontal flow was initiated and allowed to stabilize for approximately one week. A constant head device was used to set the down-gradient water level, while a peristaltic pump was set at a consistent speed to induce flow across the tank. All water entering the tank was deoxygenated using the continuously operating counter-current nitrogen sparging system shown in Figure 5.6. Flows were set to create an approximate one-day mean residence time across the tank. To better quantify the flow field, a tracer test was performed using sodium bromide and the visual dye fluorescein; a snapshot from one test is shown in Figure 5.7 below.

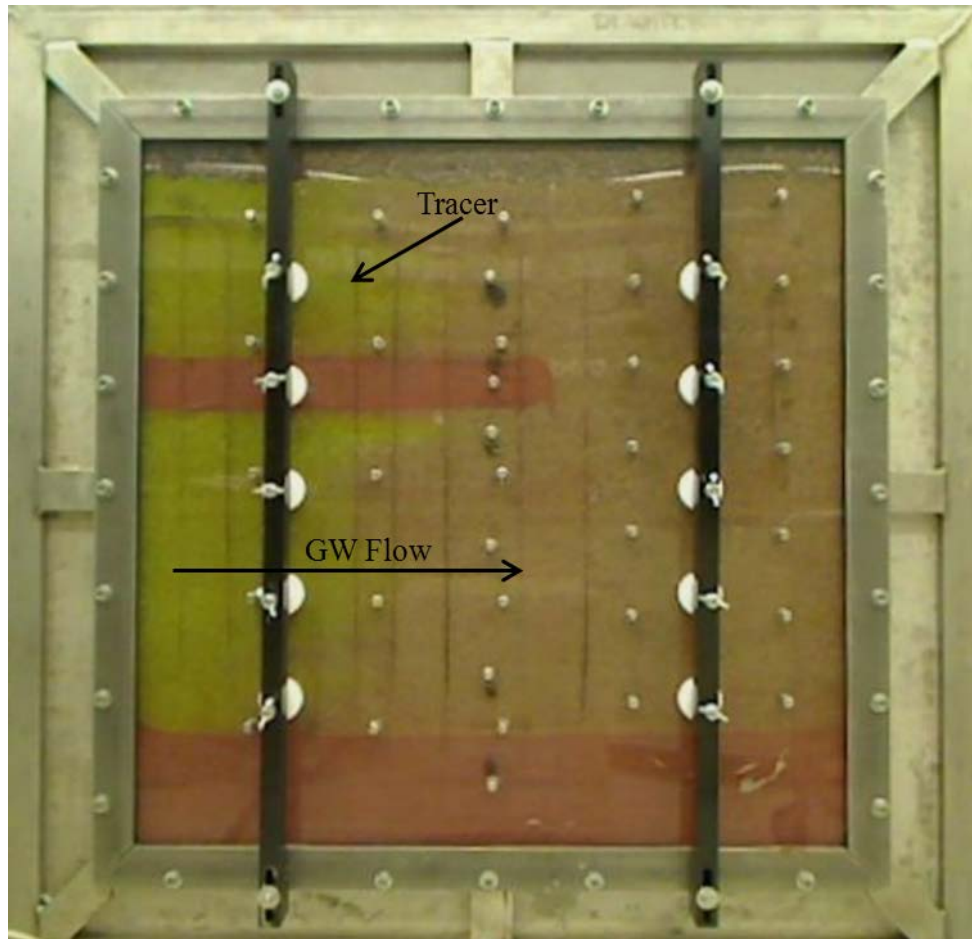

Figure 5.7: Dye tracer testing photo: yellow/green color is fluorescein dye front moving across the tank.

5.5.3 Aquifer Characterization: Tracer Testing.

Flow field characterization used a 60 mg/L Br⁻ tracer solution, prepared using reverse osmosis (RO)-treated water and sodium bromide. The flow through the tank during the tracer testing was increased to approximately 48 mL/min from 10.8 mL/min to reduce the time necessary for breakthrough.

Samples of the effluent were gathered approximately every 15-20 minutes. Each 20 ml sample was analyzed using a Dionex Ion Chromatograph (IC). Figure 5.8 presents the resulting bromide tracer response curve. The calculated mean residence time across the tank at the elevated flow rate (48 mL/min) was 380 minutes (6.33 h). Extrapolating this result to the lower flow-rate used in the disturbance testing (~10.8 mL/min), results in a mean residence time of approximately 1.2 d (28 h). This was close, but slightly slower than the design retention time in the tank (1 day); however, the higher flow rate at a fixed effluent head results in a higher water table level at the influent side of the tank, so the residence time vs. flow rate relationship will not be inversely proportional as assumed for the extrapolation. To verify this, a visual tracer test was performed on the tank.

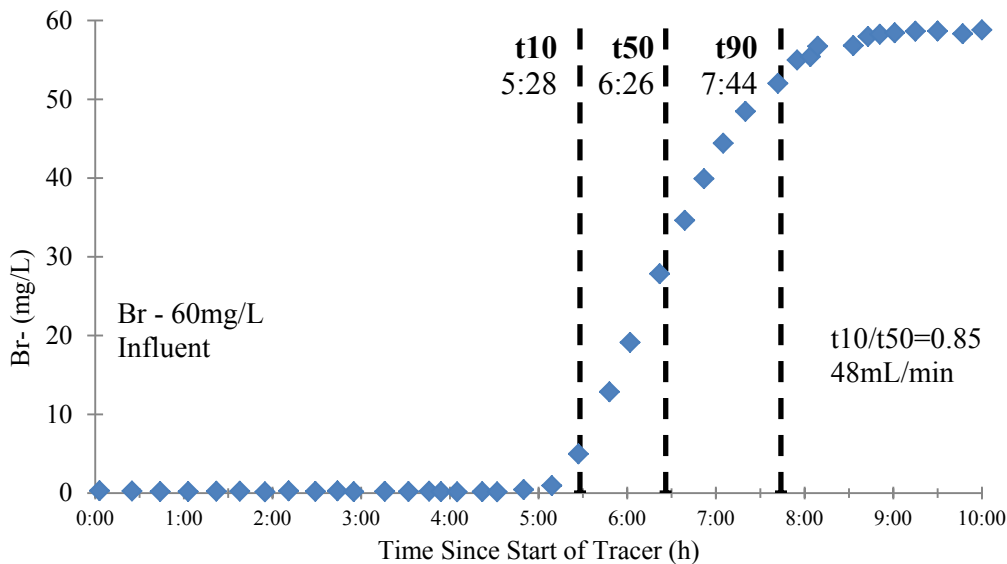

Figure 5.8: Bromide tracer plot.

Immediately following the bromide tracer, an additional visual tracer test was performed. To begin the sodium bromide solution was replaced with a yellow orange dye (fluorescein) as the influent to the tank. A solution of fluorescein was prepared with 8 g of fluorescein in 20 L of water. This dye was then used as the influent to the tank for approximately 2 h at 48 mL/min. Throughout the visual tracer testing, pictures were taken every 1 h to capture the flow of the fluorescein dye across the tank; a time-lapse video compiled from these pictures is available in the supplemental information on CD. The visualization showed that due to the elevated water table, which resulted in no capillary fringe or vadose zone, a small amount of short circuiting was taking place at the top of the tank. This had the effect of decreasing the overall residence

time in the tank during both tracer tests, but should not have an effect during normal experimentation with a lower water table. Visual dye tracer tests were later used, to verify the average linear velocity during experimental flow conditions. The visual tracers confirmed the linear velocity in the tank of 1.2 m/d (4 ft/d) at the experimental flow conditions (10.8 mL/min).

5.5.4 Disturbance Testing Conditions.

For a given disturbance, there is a finite window of time before the system rebounds back to near pre-disturbance conditions, and that time is primarily controlled by the local groundwater flow rate. For the proof-of-concept laboratory-scale tests, the size of each disturbance was selected to create about a 2-h post-treatment monitoring period at the disturbance location and about a 4-h post-treatment duration at the down-gradient monitoring point. Two of the four disturbances used in this work involved liquid injection (clean water and chemical oxidant solution). For those cases, Equation 5.1 below was used to determine the injection volume of about 500 ml. It is based on the assumption that the injection moves out radially from the injection point across the full-thickness of the tank:

$$\text{Injection Volume (mL)} = \pi(t \times LV)^2 \times d \times \theta_T \quad 5.1$$

Where:

- t = Contact time required (h) [2]
- LV = Average linear velocity (cm/h) [5.08]
- d = Thickness of tank (cm) [5.08]
- θ_T = Total porosity (cm³-pores/cm³-soil) [0.32]

To verify the estimate, a practice injection with a 500 mL fluorescein dye solution was conducted. As expected, a cylinder was formed similar to the one shown in Figure 5.9 using potassium permanganate, with slight elongation in the down-gradient direction due to background flow conditions. This is the expected result for the superposition of the radial injection flow on top of the relatively uniform background water flow field. For reference, the ~500 mL injection is equivalent to approximately 1.6 L soil volume (0.5 L/0.32 L-pores/L-soil = 1.56 L-soil).

The two liquid disturbance tests (water, ISCO) involved injecting solutions into the tank using a 22 gauge x 1.5” needle affixed to Norprene tubing with a Luer-lock fitting. Approximately 500 mL of the liquids were pumped into the tank at ~75 mL/min using a peristaltic pump as summarized in Table 5.2. To view injected solution distribution and movement within the tank, fluorescein dye was added to the clean water injections at 400 mg/L. This was not necessary during the ISCO disturbance test, as potassium permanganate (KMnO₄), which forms a deep purple color, was used.

During the air sparging disturbance testing, breathing-grade air was injected into the aquifer using the needle apparatus attached to a Dwyer Rate-Master flow-meter to control air-

flow. Air was injected into the aquifer for 10 min at 1 L/min and 40 psig line pressure (measured upstream of the needle and flow meter). This rate and time period de-watered the disturbance location similar (Figure 5.10) to what would occur in field applications and was based on air sparging conditions outlined in Johnson et al. (2001).

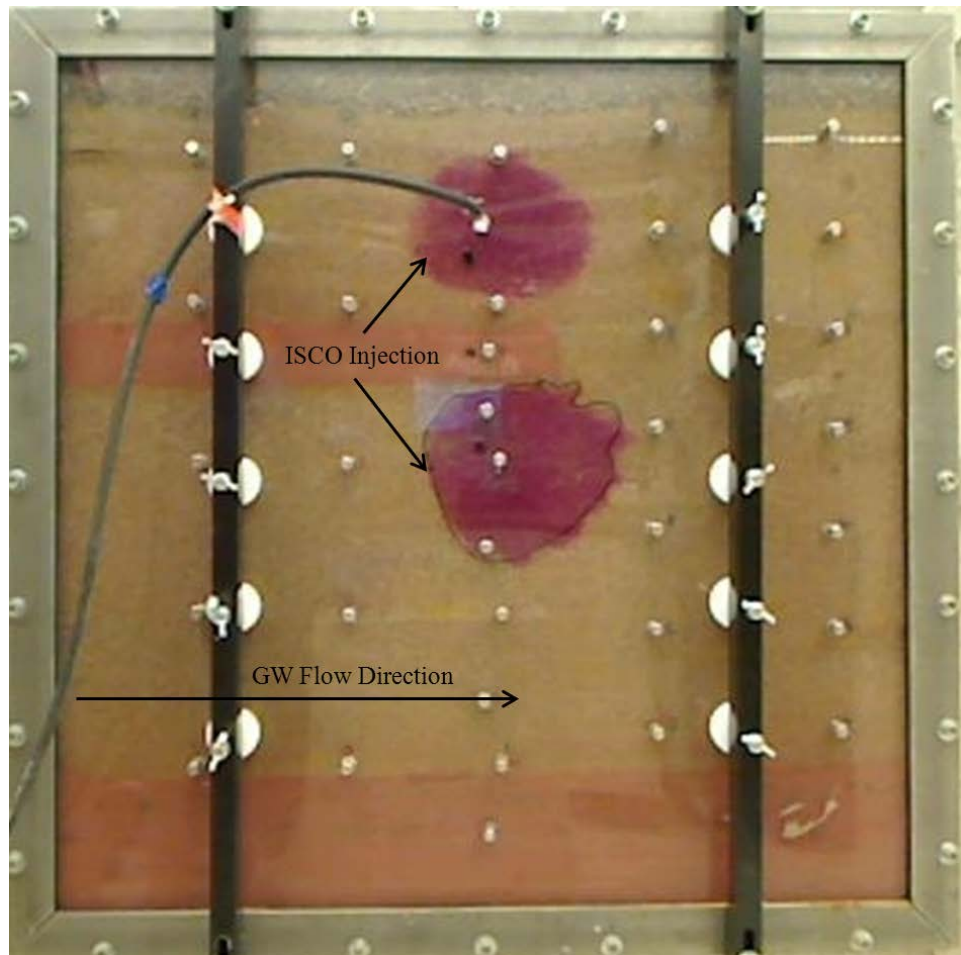

Figure 5.9: Example of disturbance geometry during ISCO injections: up-gradient side is compressed while down-gradient is elongated due to background water flow.

Table 5.2

Disturbance Test Parameters

Disturbance Type	Volume	Rate	Notes	Order of Tests
Clean Water	500 mL	~75 mL/min	Spiked with 0.4 g/L Fluorescein	1
Heating	NA	NA	Heated until ~99 C	2
ISCO (aqueous oxidant solution)	500 mL	~75 mL/min	1% by wt. KMnO_4 : Samples quenched with excess sodium thiosulfate	3
Air Sparging (air)	10 L	1 L/min	Breathing-grade air	4

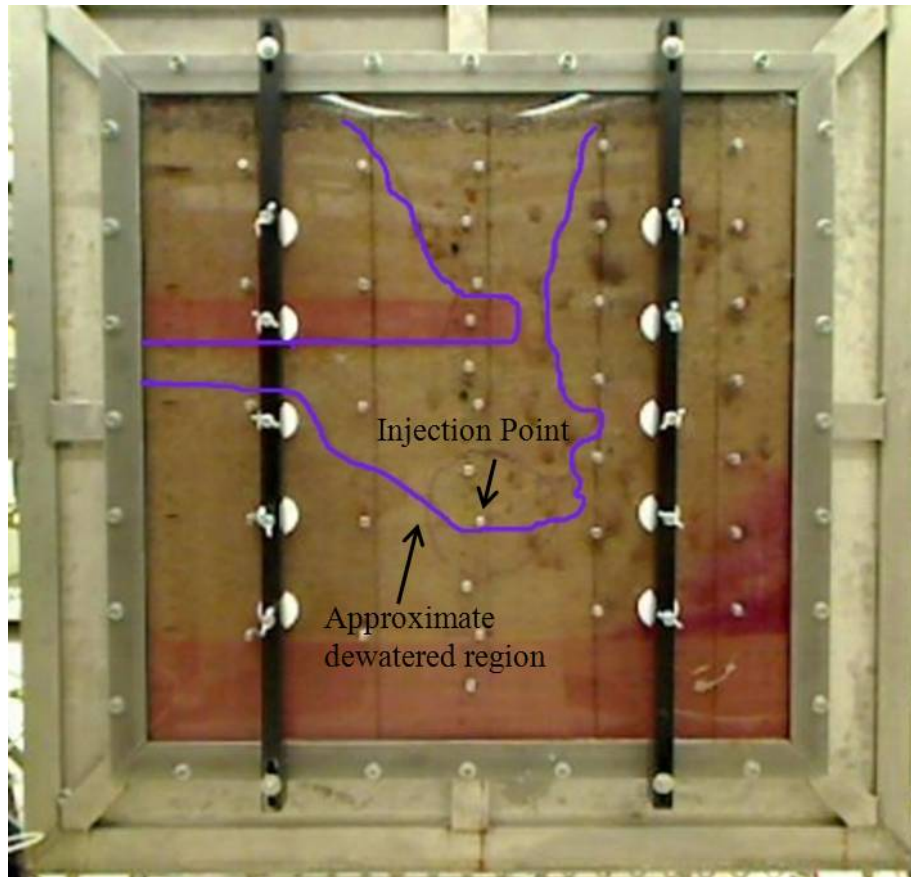

Figure 5.10: Example de-watered region during an air sparging disturbance.

Prior to initiating the air sparging disturbance test, 2-L water reservoirs were connected at the influent and effluent ports and set to the constant head level in the tank. These were needed because the injected air displaces water from the soil pores. During air injection, water flowed from the tank to the reservoirs, and upon cessation of air injection, water flowed back into the tank into the formerly air-filled pore space. The down-gradient reservoir was filled with tank effluent water, while the up-gradient reservoir was filled with clean RO water. The extent of the resulting air distribution is shown in Figure 5.10.

5.5.5 Post-disturbance Sampling Procedure.

Water samples were extracted from selected tank ports using 5 mL disposable slip tip syringes fitted with 22 gauge x 1.5 in needles. Where necessary (within NAPL regions) 22 mm glass-fiber TCLP 0.45 μm disposable syringe filters were used to prevent DNAPL entrainment into water samples.

The extracted 5 mL sample was then injected into a 40 mL VOA vial that had been pre-filled with 25 mL of RO water; so as to not pressurize the sample, 5 mL of headspace was removed following injection of sample water. The dilution was accounted for following GC analyses, by multiplying the resultant water concentration by the six-fold dilution relative to 30 mL standards.

5.5.6 Source Creation.

5.5.6.1 Type I – Dissolved Source Creation.

A solution of approximately 2.5 mg/L PCE in RO water was prepared and used for influent feed water. The tank effluent concentration was sampled and analyzed with time for PCE to determine when the tank had reached steady conditions. Steady conditions were defined as a minimum of three consecutive days of effluent concentrations within 10% of each other; it took approximately one week to meet this criterion.

Upon reaching steady effluent conditions, the sampling ports where the disturbance tests were to take place were monitored for an additional two days to ensure that steady PCE concentration conditions had been achieved locally; using the requirement that concentrations be within 10% of each other. A picture of the dissolved source tank in operation is provided in Figure 5.11.

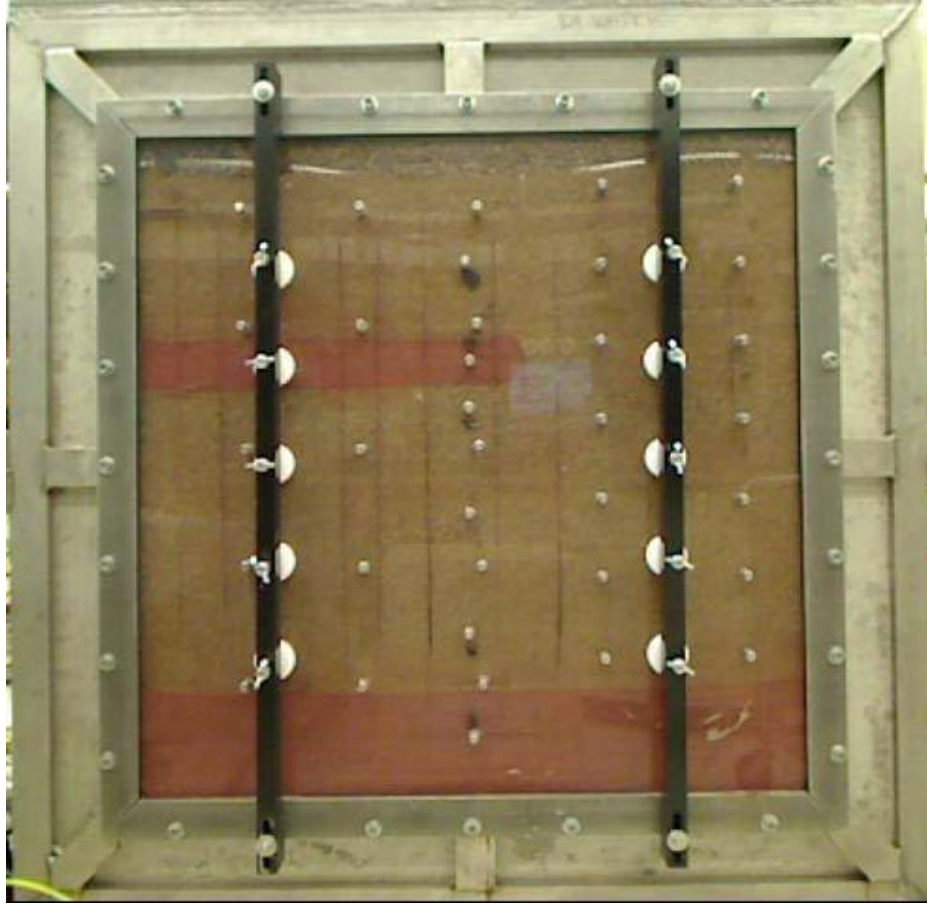

Figure 5.11: Type I dissolved source.

5.5.6.2 Type II – Ganglia Source Creation.

A pure stock of Sigma Aldrich ACS grade PCE was dyed with Fischer 86% Sudan IV red dye. Two separate 2 mL PCE doses were injected into Port C4 shown in Figure 5.5 with approximately 2 h in between. The volume was selected by estimating the PCE impacted area, the distance down to the lower permeability layer, and assuming a 10-20% residual DNAPL pore saturation. Immediately following the PCE injection, a camera was setup to capture the migration of DNAPL through the aquifer. A picture of the ganglia is presented in Figure 5.12.

An additional seven-day period of tank effluent and sampling port monitoring was used to verify steady conditions. As with the Type I dissolved source, steady conditions were defined as three consecutive days with dissolved concentrations within 10% at all sampled locations (bulk effluent, disturbance location, up and down-gradient ports).

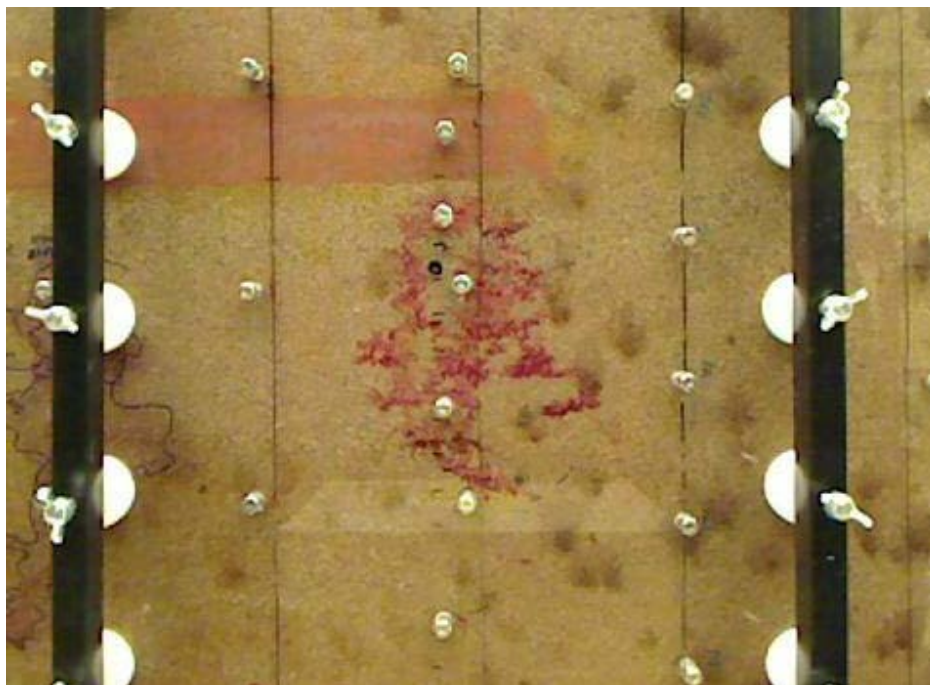

Figure 5.12: Type II ganglia source (PCE is dyed red).

5.5.6.3 Type III – Pooled Source Creation.

A pure stock of Sigma Aldrich ACS grade PCE was dyed with Fischer 86% Sudan IV red dye. A single dose of 4 mL of PCE was slowly injected (0.5 mL/min) into Port B5 directly above the lower granite layer in the tank. Similar to the ganglia case discussed above, the volume was selected by estimating the PCE impacted area and the height of the pool. Following the injection of the PCE, the tank was monitored for steady conditions. For the pooling this was achieved in five days; for consistency with the other tests, an additional two days of monitoring were conducted prior to the first disturbance test. No photo of the pooled source is available.

5.5.7 Contaminant Removal between Disturbance Tests.

Following each disturbance test, the tank was drained through the bulk effluent screen. Air was then pumped through all of the front ports of the tank, with it exiting from the top of the tank through a single port. This effluent air was monitored for PCE concentrations until non-detect conditions were encountered.

Following non-detect of PCE within the exit air stream, the tank was re-flooded by gravity with deoxygenated RO water. Flow was reinitialized and both tank effluent and interior port water samples were collected for testing. If PCE was detected, the tank was drained and the air injection procedure was repeated. Only when non-detect conditions were encountered for all locations was a subsequent disturbance test undertaken; the dissolved detection limit (MDL) for PCE was 1 μ g/L.

5.6 Disturbance Tests Results

The disturbance tests results are presented below in Figures 5.13 to 5.17 by disturbance type, comparing the results for each disturbance across all idealized source zone architecture components (dissolved chemicals/Type I, DNAPL ganglia/Type II, DNAPL pools/Type III). Two graphs are displayed for each disturbance/source combination; the first contains data from samples collected from the port through which the disturbance was created (e.g., location where solution is injected), while the second displays data from the port immediately down-gradient of the disturbance location. The identifiers for the ports sampled during each test are provided in the figure captions, and their locations are shown in Figure 5.5.

For ease of comparison, the dissolved PCE concentrations are normalized by pre-disturbance concentrations for each test, and the time origin ($t=0$) is the start of the disturbance test (e.g., the start of clean water injection or air injection).

The first implementation of the clean water disturbance test used a slower background water flow rate (5.4 mL/min flow rate or 2 ft/d average linear velocity) than other tests (10.8 mL/min or 4 ft/d). This allowed evaluation of the effect of flow rate on the concentration vs. time response; the response (dissolved concentration vs. time) for the lower flow rate case was expected to be qualitatively similar but with a longer time scale than the higher flow rate case, and with the timing being extended in proportion to the ratio of the (higher flow rate/lower flow rate). That hypothesis was tested by converting the slower flow rate data set to an equivalent higher flow rate response by multiplying the time (t) for each concentration value (C) by the ratio of the (lower flow rate/higher flow rate). As expected, the C vs. t response curves were identical when adjusted in this way as shown in Figure 5.13.

a) First Location: Ports C2 and D2

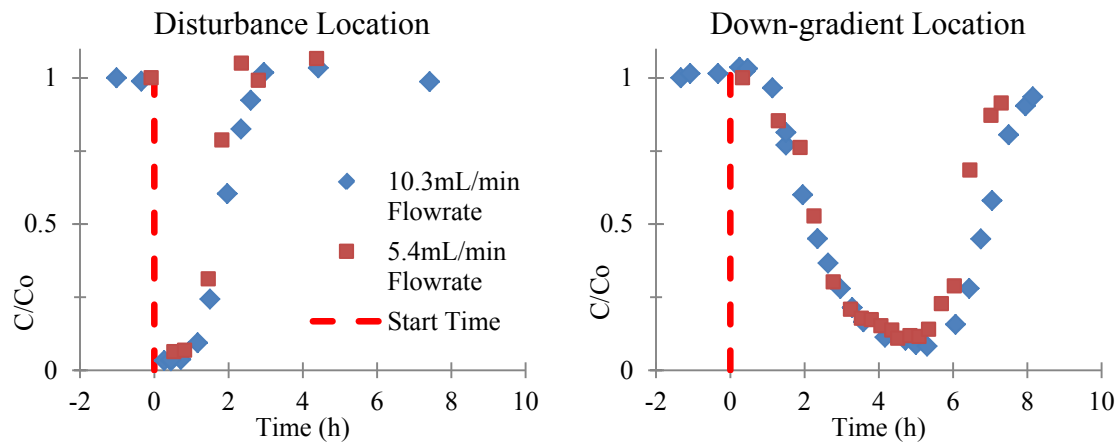

b) Second Location: Ports C8 and D6

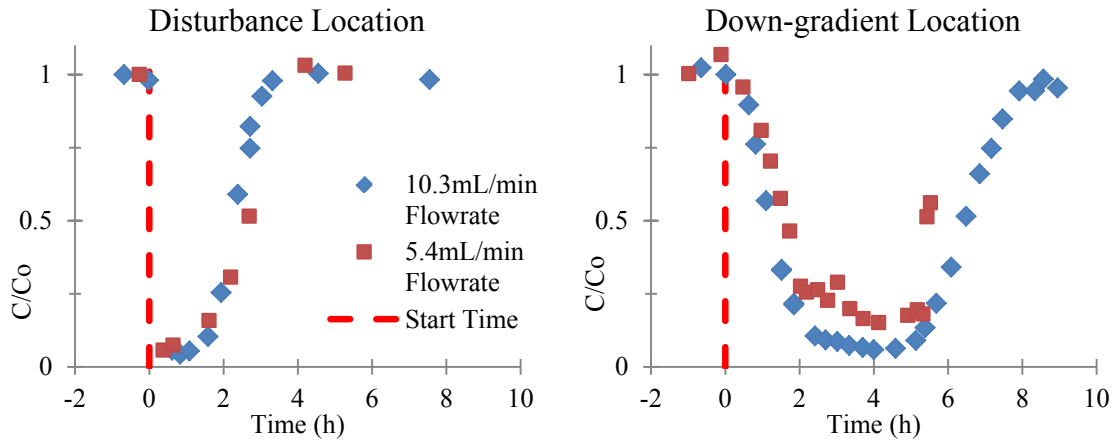

Figure 5.13: Water disturbance test in a dissolved source for two different water flow rates: Note – The time values of the 5.4 mL/min flowrate samples were scaled to match those of the 10.4 mL/min testing as described in the text.

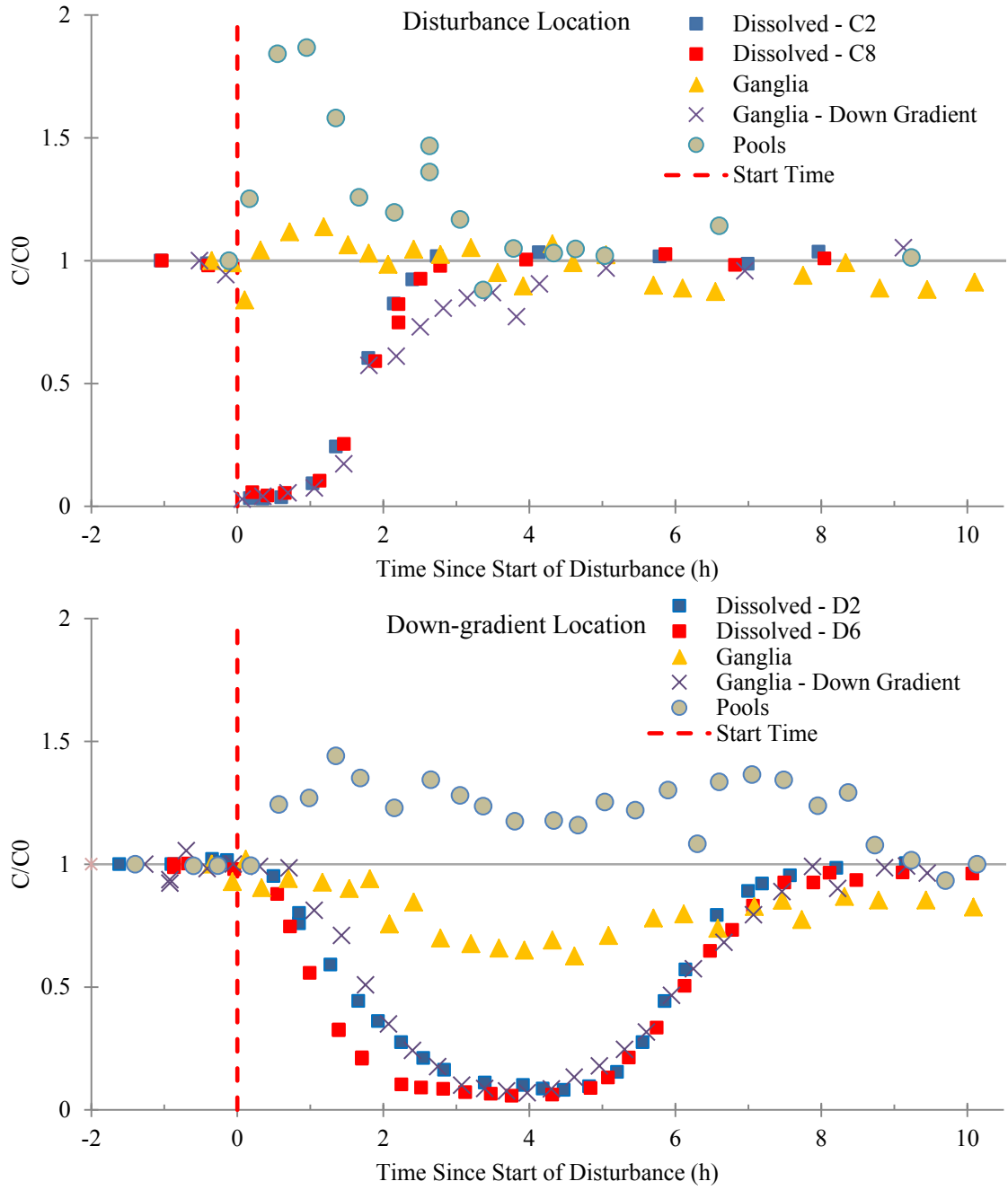

Figure 5.14: Water disturbance testing for all source types: Notes – ports C2,C8 and D2, D6 used for ganglia and dissolved sources; Ports B5, C10 used for pooled source: disturbance parameters are outlined in Table 5.2: ganglia – down gradient refers to a water injection down-gradient of the DNAPL ganglia during the second phase of testing.

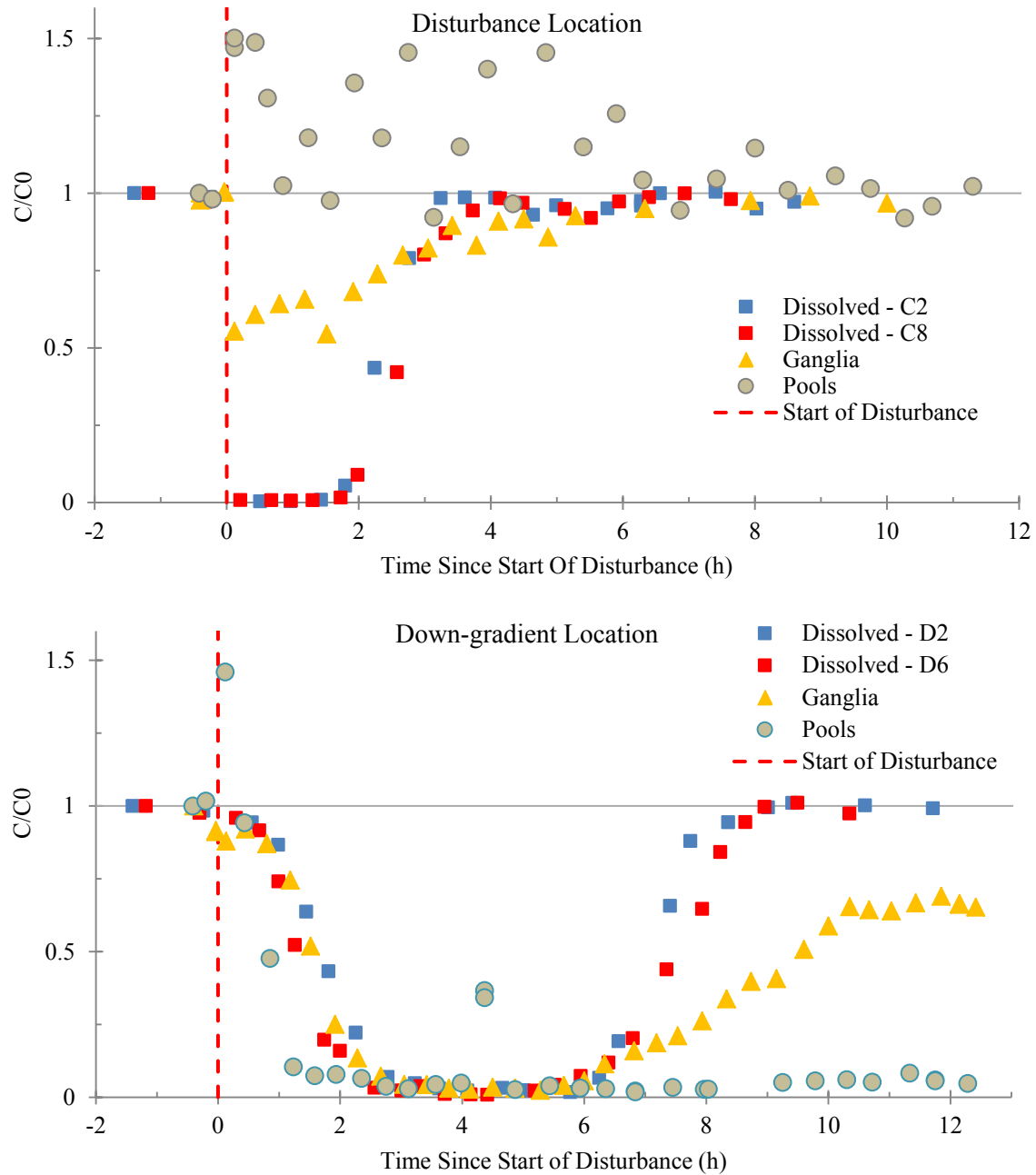

Figure 5.15: ISCO disturbance testing for all source types: Notes - ports C2, C8 and D2, D6 used for ganglia and dissolved sources; Ports B5, C10 used for pooled source: disturbance parameters are outlined in Table 5.2: background flow of 1.2 m/d (~4 ft/d).

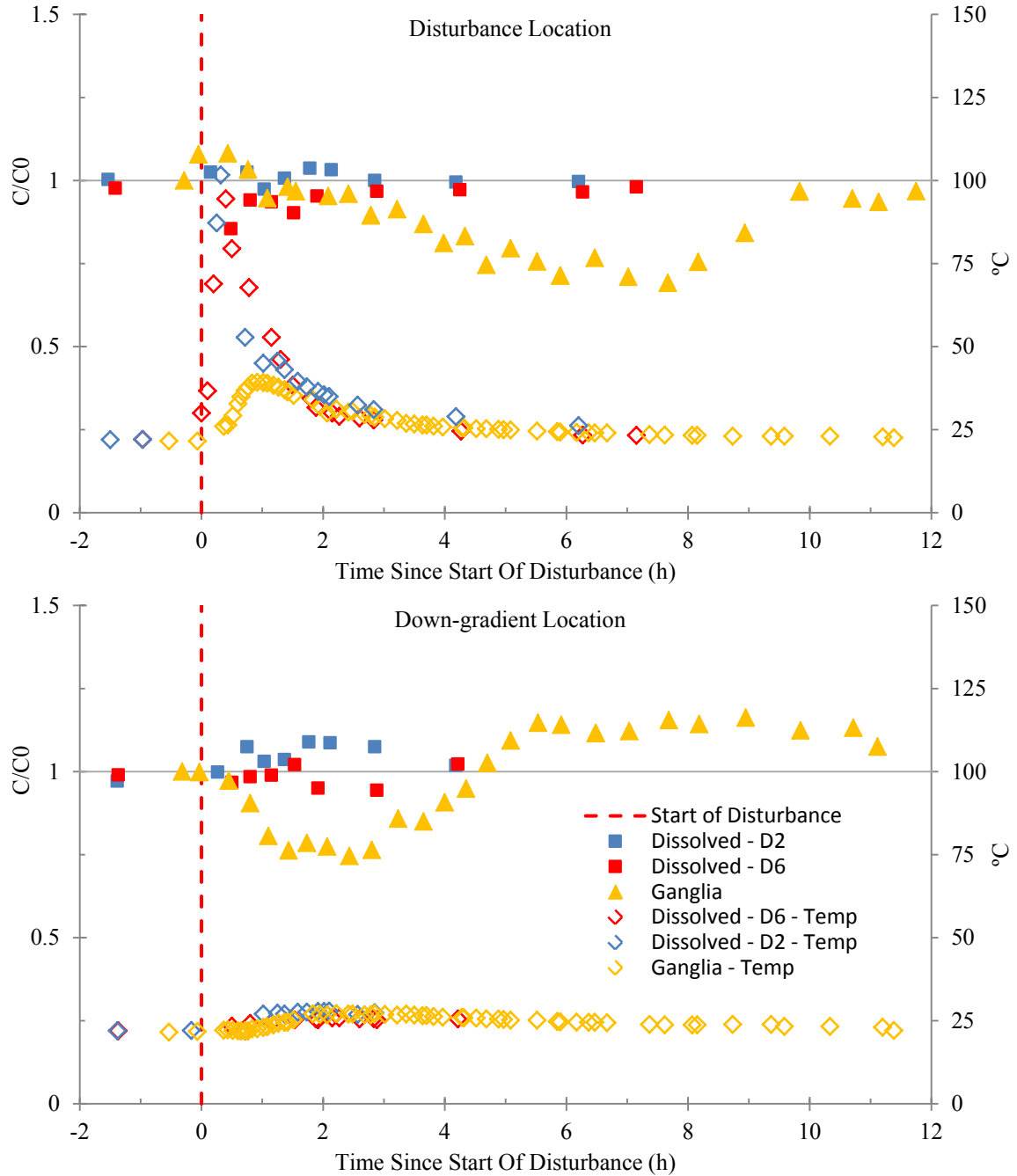

Figure 5.16: Heating disturbance testing for all source types: Notes - ports C2,C8 and D2, D6 used for ganglia and dissolved sources; Ports B5, C10 used for pooled source: There is no Type III Source data; an electrical short damaged the heating elements when the testing was started, so a DNAPL pool source test was not conducted.

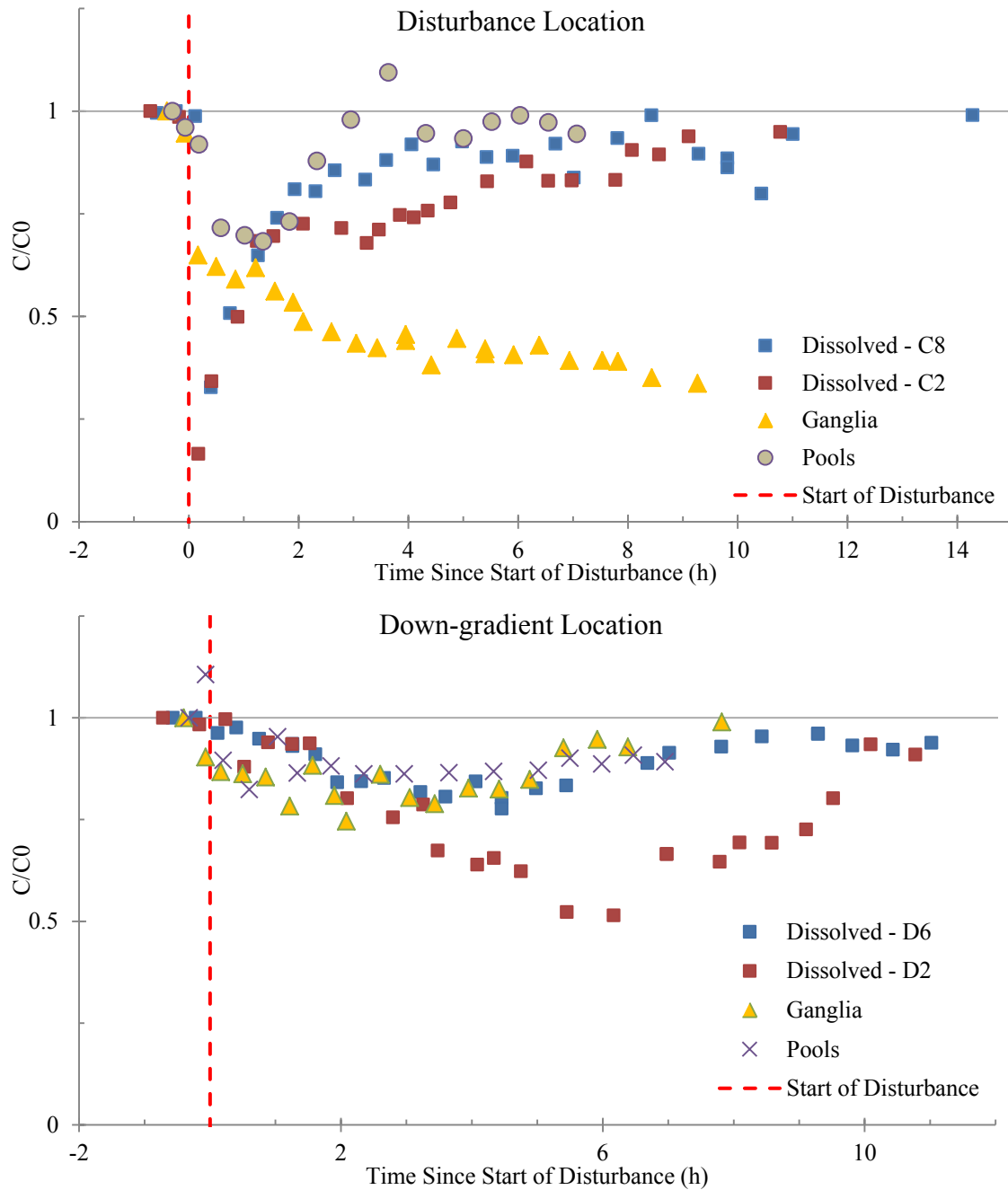

Figure 5.17: Air sparging disturbance testing for all source types: Notes - ports C2,C8 and D2, D6 used for ganglia and dissolved sources; Ports B5, C10 used for pooled source: disturbance parameters are outlined in Table 5.2: background flow of 1.2 m/d (~4 ft/d).

5.7 Discussion

During this proof-of-concept testing, four different disturbance tests (water injections, ISCO, heating, air sparging) were investigated for identifying source architectures. These

disturbances were chosen as two are components of remedial technology pilot-testing field activities at some sites (air sparging and ISCO), one would be relatively simple to implement (clean water injection), and the fourth could possibly be implemented with modification of direct-push characterization tools (heating).

Two sampling locations were utilized during each test, and they are referred to as the “disturbance” and “down-gradient” locations. For actual field implementation, placement and analysis of data from a down-gradient sampling location would be complicated by the uncertainty of whether the portion of the aquifer between the sampling points contained DNAPL. Therefore, in a field setting, it is likely that only the disturbance location would be sampled, and the test would become a “push-pull” type test with a similar sampling approach to that of Istok et al., (2002) for the clean water and ISCO variants. In light of this, emphasis is placed on the analysis of the disturbance location sampling data in the following discussion.

5.7.1 Water Disturbance Test Results.

The water disturbance test results are presented in Figure 5.14. In brief:

- Dissolved Source: Injection of clean water into the dissolved source resulted in an immediate and order-of-magnitude decrease in concentration at the injection point, and this concentration remained depressed for a period of time related to the injection volume and ambient water flow rate as anticipated by Equation 5.1. The down-gradient concentration vs. time behavior is similar, but begins after a time delay that can be estimated as the (distance down-radius of disturbance)/average linear velocity). It also has a broader time period of low concentrations than the disturbance location as it experiences the full width of the clean water packet while the disturbance location only sees the up-gradient half of the clean water packet as it flows past.
- DNAPL Ganglia Source: There was a slight increase in the dissolved concentration at the injection point. The increase dissipated over a time period similar to the concentration rebound that happened in the clean water injection case (as anticipated by Equation 5.1). This is likely because DNAPL dissolves into the injected water as it flows out from the disturbance point through the residual DNAPL region. That same water then flows down-gradient through the DNAPL and past the disturbance point after the injection stops. Concentrations at the down-gradient sampling location, on the other hand, declined and then rebounded. That location first sees the down-gradient half of the clean water packet, which had little contact with DNAPL during the injection.
- DNAPL Pool Source: The injection of clean water directly above a pooled source resulted in an immediate rise in contaminant concentrations at the injection point, and this concentration remained elevated for a period of time related to the injection volume and ambient water flow rate as described by Equation 5.1. The down-gradient concentration vs. time behavior is similar, but has a lower peak and it begins after a time delay that can be estimated as the (distance down-radius of disturbance)/average linear velocity). It has a broader time period of elevated concentrations than the disturbance location as it experiences the full width of the

injected water packet while the disturbance location only sees the up-gradient half of the injected water packet as it flows past.

In reviewing these data, it appears that a clean water injection disturbance can discriminate between testing volumes having only dissolved contamination and those containing NAPL. With respect to the potential for differentiating between DNAPL ganglia and pools, the magnitude of the increase in the concentration vs. time response at the disturbance location was greater for pools than ganglia, but the overall response was similar in these tests. Whether or not this will be true for all cases may depend on then the proximity of the injection point to the DNAPL pool or ganglia, and that was not examined in these studies. Thus, increases or non-depressed concentrations following clean water injection, probably can be used to identify DNAPL regions, but not differentiate pool and ganglia sources without additional lines of evidence. Understanding of the site geology might be helpful as pools typically form on top of high/low permeability contrasts.

5.7.2 ISCO Disturbance Test Results.

The ISCO disturbance test results are presented in Figure 5.15. In brief:

- Dissolved Source: An ISCO injection into the dissolved source resulted in an immediate and order of magnitude decrease in concentration near the injection point, and this concentration remained depressed for a period of time related to the injection volume and ambient water flow rate as anticipated by Equation 5.1. The down-gradient concentration vs. time behavior is similar, but begins after a time delay that can be estimated as the (distance down-radius of disturbance)/average linear velocity). It also has a broader time period of low concentrations than the disturbance location as it experiences the full width of the ISCO solution packet while the disturbance location only sees the up-gradient half of the ISCO solution packet as it flows past.
- DNAPL Ganglia Source: Relative to the dissolved source case there was a smaller change (~50% concentration reduction) at the injection point for the ganglia source. This is likely because DNAPL dissolves into the injected oxidant as it flows through the residual DNAPL region. That same water then flows back through the DNAPL after the injection stops effectively increasing the contact time with the ganglia source. The down-gradient location experienced a larger order-of-magnitude decrease. The contaminant concentration rebounded more slowly and less fully for the ISCO disturbance; this might reflect partial treatment of the DNAPL ganglia mass as the same behavior was not seen with the dissolved source/ISCO disturbance case. It should be noted that the partial concentration rebound, however, would only be observed if other DNAPL sources were not located up-gradient of the disturbance location
- DNAPL Pool Source: The ISCO injection directly above a pooled source resulted in an immediate rise in contaminant concentrations near the injection point, however the concentrations varied with time in a way not observed with other tests; there were 1-1.5X increases from pre-test conditions with no apparent temporal pattern of higher and lower levels. The down-gradient concentration vs.

time behavior is very different from that at the disturbance location. There was an order-of-magnitude decrease in concentration and no rebound to pre-test conditions after 12 h of post-disturbance monitoring.

In reviewing these data, it appears that an ISCO solution injection disturbance can discriminate between testing volumes having only dissolved contamination and those containing NAPL. With respect to the potential for differentiating between DNAPL ganglia and pools, only the DNAPL pool source resulted in a transient increase in concentration and that might be a key differentiating characteristic. Whether or not this will be true for all cases may depend on then the proximity of the injection point to the DNAPL pool or ganglia, and that was not examined in these studies.

5.7.3 Heating Disturbance Test Results.

The heating disturbance results are presented in Figure 5.16. In brief:

- Dissolved Source: The heating disturbance in the dissolved source resulted in little to no change in PCE concentration at either the disturbance point or down-gradient sampling location.
- Ganglia Source: The heating disturbance resulted in a slight decrease in contaminant concentration several hours after the heating was conducted. It is hypothesized that the response is due to vertical flow initiated by the temperature-induced water buoyancy changes.
- Pool Source: When the testing of the pooled source began an electrical short occurred that damaged the heating elements.

Most of the concentration vs. time responses are similar for the heating disturbance. The exception is a transient 25% depression in concentrations for the ganglia source/heating disturbance case. Elevated concentrations were expected for both ganglia and pooled sources due to the presence of DNAPL and heating possibly increasing the dissolved concentrations; however this was not observed. In fact, the ganglia responses for the disturbance and down-gradient sampling locations are opposite of what was expected; the down-gradient response shows an immediate decrease in concentration while the disturbance location has a lag before the slight decline in concentration. It is possible that the localized heating resulted in a buoyancy driven alteration of the water flow path and that this is the cause of the unexpected results. Should the heating test be deemed viable for in-field application, additional bench-scale testing should be undertaken to verify whether or not vertical flow occurs.

5.7.4 Air Sparging Disturbance Test Results.

The air sparging disturbance test results are presented in Figure 5.17. In brief:

- Dissolved Source: Injecting 10 L of air at 1 L/min in the dissolved source resulted in an immediate and near order-of-magnitude decrease in dissolved concentration at the injection point, followed by about 8 – 9 h rebound. The initial concentration reduction is likely caused by stripping of contaminant from the

water by the injected air; while the 8 – 9 h rebound is likely tied to partitioning of dissolved contaminant into the residual trapped gas within the aquifer.

- DNAPL Ganglia Source: Following the air sparging disturbance, the contaminant concentrations near the injection point decreased immediately by ~35% and continued a slow decline to about 30% of the pre-test concentration over the course of the monitoring (~11 h). The initial decrease and subsequent decline is likely related to mass removal from DNAPL ganglia during air injection, It should be noted that the partial concentration rebound, however, would only be observed if other DNAPL sources were not located up-gradient of the disturbance location.
- DNAPL Pool Source: Air sparging directly above a pooled source resulted in concentration vs. time behavior that is similar to that for the dissolved source case. The down-gradient sampling location displayed a similar response (decrease in concentration slow rebound) with a time delay and less reduction in concentration levels.

In reviewing these data, it appears that an air sparging disturbance test might be capable of distinguishing regions with ganglia from regions without ganglia.. The concentration response for all other source types eventually rebounded to pre-testing conditions while the ganglia source did not.

5.8 Conclusion

This chapter presents a sequential approach for characterizing DNAPL source zones. The first step involves the use of multiple cross-gradient groundwater sampling transects to bound the extent of contamination and identify high source strength areas. Use of this approach was illustrated at the beginning of this chapter for a field demonstration site.

Once the general geometry of the source is known and some insight is gained concerning higher strength regions, it might be desirable to more surgically assess specific areas for gross source zone architecture features, such as DNAPL ganglia and pools. That information might be useful for projection of future SZNA rates or for remedial system design. This chapter explored the local assessment of architecture features using four *in-situ* disturbance tests through proof-of-concept testing in a two-dimensional laboratory physical model. The disturbance tests were applied to the following conditions: dissolved source only, DNAPL ganglia and associated dissolved plume, and a DNAPL pool and its associated dissolved plume.

With respect to evaluation of the disturbance test data, the emphasis was on their ability to answer the following questions:

1. Is there DNAPL present in the test region?
2. If so, can the type of DNAPL distribution be identified? (e.g., DNAPL ganglia vs. DNAPL pools)

Table 5.3 below summarizes the utility of the disturbance tests, based on the results from these initial proof-of-concept studies.

Table 5.3

*Utility of Disturbance Tests for Local Characterization of SZNA Features**

Disturbance Type	Question		
	Is DNAPL present in test region?	Can features of the DNAPL distribution be identified?	
		Ganglia	Pool
Water	Yes	Possible ^{b,c}	Possible ^{b,c}
ISCO	Yes ^b	Limited ^{b,c}	Yes ^d
Heating ^a	No	NA	NA
Air Sparging	Yes ^{c,d,e}	Yes ^b	No ^e

* - based on concentration vs. time response at the disturbance location

a – There is no pooled source data, when the testing was started an electrical short damaged the heating elements, and no test was possible

b – only if other DNAPL sources are not located up-gradient

c – with a thorough understanding of site geology

d – data suggest it might be possible, but more testing needed at a wider range of conditions

e – might not differentiate dissolved sources and pools; more testing needed

Of the four disturbances tested, the clean water and ISCO solution injections appear to be the most useful for determining the presence or absence of DNAPL. The utility of the ISCO solution will be dependent on its reaction rate and mass oxidant relative to DNAPL mass in ganglia; a slowly-reacting oxidant would provide results similar to a clean water injection, while a rapidly-reacting high-strength oxidant might produce similar results for ganglia and dissolved sources (as the ganglia could be fully treated by the injection in that case). The air sparging disturbance might also have similar behavior, depending on the duration and flow rate of air injection (as it could volatilize the DNAPL in the test zone), so more test combinations of flow rate and disturbance duration need to be investigated. It is unknown whether or not the heating test could help identify DNAPL pools, because that condition was not tested.

The data suggest that tests resulting in DNAPL mass depletion (ISCO, air sparging) might be designed to differentiate regions with ganglia and pools; these could be applied after regions containing DNAPL are identified by a first disturbance test. For example, a clean water injection might be used to determine the presence of DNAPL and that might be followed by an air sparging test to determine if the DNAPL is distributed as ganglia or a pool. Knowledge of

subsurface geology will be critical in this determination as DNAPL pools tend to form at permeability contrasts.

Of the potential disturbance types investigated, the clean water injection appears to be the most practicable, considering possible permitting and logistical issues, and costs. It also has the potential to provide valuable information concerning the presence or absence of DNAPL, and the response behavior dependence on time, groundwater flow velocity, and injection volume is predictable for idealized sources.

To place testing times and injection volumes needed at a field site in context, a range of times and injection volumes is presented in Table 5.4 for hypothetical sites spanning a range of average linear groundwater velocities. When determining injection volumes the minimum volume removed per sample must be taken into consideration and the total injection volume must be significantly larger than the total sampling volume. For example, the minimum sample volume is likely to be about 100 mL – 1000 mL for sampling from small-diameter wells (e.g., 2.54-cm diameter) and direct push points. It could also be as large 100 L or more for conventional wells and deeper depths. Therefore, injection volumes of <10 L are unlikely given the need to sample multiple times to determine the transient concentration vs. time response. Ideally, one would employ an in situ sensor that could provide concentration data without any groundwater sample collection and removal.

As can be seen from Table 5.14, groundwater velocity plays a significant role in determining both injection volume and time of testing. For sites with slower groundwater velocities significantly longer testing periods may be needed for the system to return to steady conditions, while sites with elevated linear velocities steady conditions will return much more quickly.

Table 5.4

Injection Volumes for Disturbance Tests under field conditions

Net Volume Injected (total volume – tubing and well bore volume)	Distance Away from Injection Point Tested in Sub-surface Assuming a 0.3-m vertical interval	Duration of Disturbance [h]		
		For different average linear groundwater velocities		
[L]	[m]	0.03 m/d	0.3 m/d	3 m/d
10	0.10	3.4	0.34	0.034
100	0.32	11	1.1	0.11
1000	1.0	34	3.4	0.34

Further testing of this concept is warranted, given the initial results. These tests were conducted in a two-dimensional physical model with single source zone features. It is unknown how responses might be different in three-dimensions and in settings with multiple source zone features, such as co-located ganglia and pools. In addition, it is unknown how sensitive the concentration vs. time response might be to the relative locations of the source feature vs. the monitoring location vs. the groundwater flow path.

APPENDIX F: SAMPLING METHODS

This Appendix contains supplemental information on the quality assurance/quality control measures that were followed for this investigation.

Calibration of Analytical Equipment and Quality Assurance Sampling

Analytical methods for field analyses are as follows:

- Dissolved Chlorinated Solvent and Petroleum Hydrocarbon Concentrations in Groundwater: Dissolved chlorinated solvent and petroleum hydrocarbon concentrations in groundwater will be analyzed using gas chromatography and a heated headspace method. Field GC-FID/PID/DELCD/TCD analyses will be conducted on a dedicated SRI Instruments Model 8610C gas chromatograph using MXT and CTR type columns for separation. The heated headspace method involves 30-ml of sample warmed in a 40-ml VOA vial to 35°C followed by 0.5 ml on-column injection of headspace onto the GC. The instrument will be calibrated each day against at least three different concentrations spanning the concentration range of interest (e.g. 10, 100, 1000 µg/L for dissolved concentrations). Based on experience with this instrument, reporting levels of about 1 – 5 µg/L are possible for the anticipated chemicals of interest in groundwater and no matrix or environmental interferences are expected during these groundwater sample analyses. QA for instrument operation will be maintained by calibration standard analyses and blank, duplicate or replicate sample analyses on a frequency of not less than 1:20 samples.
- General Water Quality (pH, EC, DO, ORP, and T): General water quality measurements will be made with a portable water quality meter and flow through cell (Horiba U-22 or similar, or individual meters with flow through cell for DO measurement). Meter use and daily calibrations will be as per manufacturer's instruction.
- Nitrate (NO₃⁻) / nitrite (NO₂⁻): Depending on the demonstration site, it might be possible to run nitrate/nitrite analyses in the field. Field analyses would utilize a HACH colorimetric test kit and samples would be run as per manufacturer's instructions. Replicate and blank sample analyses will be performed on a minimum of 1:20 samples for QA purposes. If samples for nitrate/nitrite analysis are not run in the field, they would be sent to the ASU laboratories for analysis. Laboratory analysis is described below in Section 3.7.2.
- Slug Testing: Slug testing will be performed in permanent monitoring well installations with well diameters 2-in (5.1 cm) or greater and a sufficient depth of water (>4 ft). Slug tests will utilize either one or two 4-ft (1.2 m) long slugs to obtain a minimum 1-ft (0.3-m) displacement within the monitoring well. A Solinst Levelogger submersible transducer/data-logger will be used to monitor water level recovery during each test.
- Aquifer Specific-Capacity Tests: Specific-capacity tests are conducted using an electronic water level indicator, a volumetric cylinder, a peristaltic pump, and a stop watch. In either a monitoring well or a direct-push rod driven to the desired depth, the water level is measured until stable. Then the polyethylene tubing inlet is lowered a

specified distance (e.g. 6 in) below the stable water level and the peristaltic pump is run at a high speed to draw the water down to that level (this is apparent by slugs of air coming up in the tubing). At this point, the flow is measured by recording how much time it takes to collect 1-L of water, or under low flow conditions, how much water is collected in a 10-minute interval.

- Water Level Measurement: Water levels will be measured using a Solinst Model 101 electronic water level meter or similar.

Analytical methods for laboratory analyses are as follows:

- Dissolved Chlorinated Solvent and Petroleum Hydrocarbon Concentrations in Groundwater: Laboratory analyses using the GC-FID/PID/DELCD/TCD will be the same as those shown for field analyses.
- DOC: DOC measurements will be conducted on a Shimadzu Model 5050A Total Organic Carbon Analyzer with autosampler. Instrument calibration will involve a four point calibration suitable for the concentration ranges anticipated (e.g. 1, 10 to 10 mg/L) using a solution of potassium hydrogen phthalate in water. Samples will be filtered using a 0.45 um filter, acidified to a pH of 3.0 s.u., and a 7 mL sample will be placed in the autosampler for analysis. QA for instrument operation will be maintained by calibration standard analyses and blank, duplicate or replicate sample analyses on a frequency of not less than 1:20 samples.
- Anion analysis (SO_4^{2-} and Cl^-): SO_4^{2-} and Cl^- will be analyzed using a Dionex Model D-120 Ion Chromatograph with autosampler. Instrument calibration anion species will involve a three point calibration suitable for the concentration ranges anticipated (e.g. 1, 10 to 10 mg/L) using water solution of suitable salts. A 5 ml sample will be used for sample analysis. QA for instrument operation will be maintained by calibration standard analyses and blank, duplicate or replicate sample analyses on a frequency of not less than 1:20 samples.
- Cation analysis (Fe^{2+} and Mn^{2+}): Fe^{2+} and Mn^{2+} will be analyzed using a Perkin Elmer Model 3110 Atomic Absorption Spectrometer (AA) with a Fe/Mn/Cu/Zn lamp and acetylene-nitrous oxide flame or Thermo iCap 6300 Inductively Coupled Plasma (ICP). Instrument calibration will involve a four point calibration suitable for the concentration ranges anticipated (e.g. 1, 10 to 10 mg/L) using a water solution of suitable salts. QA for instrument operation will be maintained by calibration standard analyses and blank, duplicate or replicate sample analyses on a frequency of not less than 1:20 samples.
- Alkalinity and COD: Alkalinity and COD analyses will be made with HACH test kits. Test measurements will be made as per manufacturer instructions. Replicate and blank sample analyses will be performed on a minimum of 1:20 samples for QA purposes.
- Nitrate (NO_3^-) / nitrite (NO_2^-): Nitrate/nitrite will be analyzed using a Dionex Model D-120 Ion Chromatograph with autosampler. Instrument calibration anion species will involve a three point calibration suitable for the concentration ranges anticipated (e.g. 1, 10 to 10 mg/L) using water solution of suitable salts. A 5 ml sample will be used for sample analysis. QA for instrument operation will be maintained by calibration standard

analyses and blank, duplicate or replicate sample analyses on a frequency of not less than 1:20 samples.

- *Dehalococcoides*: The presence and concentration of *Dhc* will be determined using polymerase chain reaction techniques. RNA will be extracted from the biomass using the RNeasy kit (Qiagen) with modifications to improve lysis (Krajmalnik-Brown et al., 2004). Analysis for the presence and quantity of *Dhc* will be performed using membrane filtration followed by PCR. PCR analyses will be conducted on either an Eppendorf Master Cycler Thermocycler, or an Eppendorf Realplex Thermocycler. Positive controls will be performed using general bacteria primers to indicate the presence of inhibitors. In addition, a clean water sample will be taken at the field site to eliminate possible contamination from aerosols. If inhibitors are detected within the samples, steps will be taken to remove the inhibitory effects on the PCR process, and the samples will be reanalyzed using the same method. If contamination is present within the clean water sample, the samples must be recorded using Real-time PCR. This will provide an indication of the amount of contamination that was possible at the site due to aerosols etc. This level may then be used to adjust the reported levels within the other samples in an Eppendorf Thermocycler. QA for instrument operation will be maintained by calibration standard analyses and blank, duplicate or replicate sample analyses on a frequency of not less than 1:20 samples.
- Dissolved H₂: Reduced gas chromatography will be used to determine hydrogen concentrations in groundwater. Samples will be analyzed using a 1 µl on column injection of aqueous sample using a Ametek Trace Analytical Model TA3000 gas chromatograph equipped with a reduction gas detector. The typical detection limit for this instrument is 10 µg/L. Instrument calibration will involve a three point calibration suitable for the concentration ranges anticipated (e.g. 10, 100 to 1000 µg/L). QA for instrument operation will be maintained by calibration standard analyses and blank, duplicate or replicate sample analyses on a frequency of not less than 1:20 samples.

Decontamination Procedures

The decontamination procedures used for groundwater sampling depended on the method of sampling. Where possible disposable equipment was used.

- peristaltic pump with disposable polyethylene tubing
- a manual tubing check valve pump with disposable polyethylene tubing
- stainless steel mini-bailer, cleaned (decontaminated) before/after each use
- disposable bailer
- downhole electric or bladder pump, cleaned (decontaminated) before/after each use (e.g., temporary or permanent monitoring well, and/or nature of multi-level completion).

Water level meters were decontaminated between each well

Sample Documentation

Each location and/or sample will be coded with a unique sample name/number coded to identify the sampling location and depth. All samples measurements will be labeled with the location name along with the date and time of sample collection and the initials of the sampler. This data, along with a brief sample description, will also be logged both in the sampler's field book as well as on a master field data sheet which is available for viewing by all site personnel.

All sample locations will be measured (via hard-line measurement or survey tied to known locations) and recorded for mapping purposes. New monitoring installations used for groundwater elevation determination will also be surveyed for top of casing elevation.

APPENDIX G: HEURISTIC SAMPLING GUIDELINES

Chapter 4 from:

Ekre, R., 2013, Source Zone Mass Depletion of Chlorinated Aliphatic Hydrocarbons:
Estimation of Rates and Insight into Source Architecture: Doctoral Dissertation, Arizona State
University, April 2013.

EFFECT OF SAMPLING DENSITY ON DISCHARGE ESTIMATES AND A HEURISTIC SAMPLING APPROACH FOR CAH ASSESSMENT

4.1 Introduction

The source zone natural attenuation (SZNA) assessment paradigm for chlorinated aliphatic hydrocarbons (CAHs) introduced in Chapter 2 uses data from down-gradient groundwater sampling transects and vapor profiles above CAH source zones to estimate overall SZNA mass loss rates as illustrated in Figure 4.1. For all four sampling events at the three CAH-impacted demonstration sites discussed in Chapter 3, the dominant component of source zone mass loss was mass discharge across the groundwater sampling transect. Whether or not this is the case at other sites will depend on the extent to which the source zone is submerged below the water table and the extent to which surface conditions might impede or encourage vapor transport. For those CAH-impacted sites where the majority of SZNA mass loss is attributable to fluxes across the down-gradient groundwater transect, it is important to have sufficient confidence in the contaminant mass discharge estimate and to understand the magnitude of the potential error. For some decision-making, confidence that the estimate is within an order of magnitude of the true value might be sufficient, while in other cases, being within 50% of the true value might be important. An example of the latter could be the use of successive annual SZNA mass loss rate assessments to project long-term site conditions, while an example of the former might be use of the SZNA contaminant mass loss rate to determine whether or not a source will be present decades to centuries in the future.

This chapter emphasizes point-based sampling transects for estimating mass discharge in groundwater from CAH source zones. It should be noted that there are other approaches, such as the integral pumping tests and passive mass flux meters discussed by Kubert and Finkel (2006), Goltz et al. (2007), ITRC (2010), and Beland-Pelletier et al. (2011). Each approach has potential applicability in some settings, with the point-based transect approach being attractive for sites where direct-push sampling or permanent multi-levels are economical at sufficient sampling density. Experiences from Einarson and Mackay (2001), Guilbeault et al. (2005), Triplett-Kingston et al. (2010), Mackay et al. (2012), and this work show that transect sampling data can also be used to efficiently delineate the source zone width and depth, and provide insight to spatial variability within the source zone (Stroo et al., 2012)

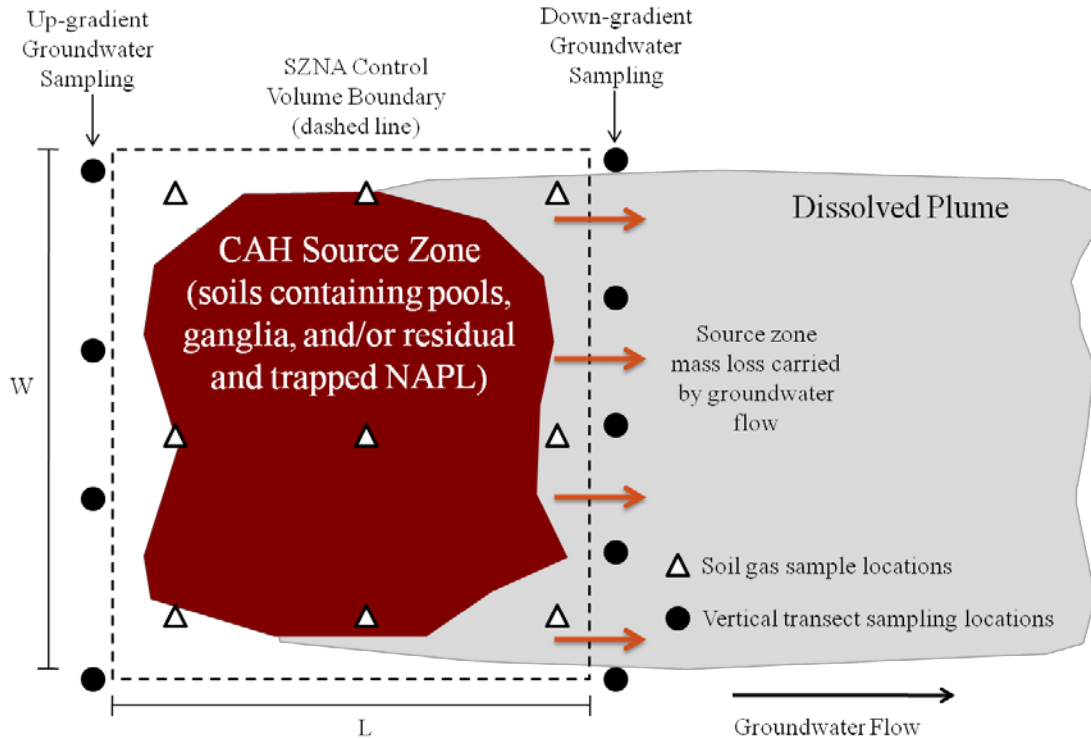

Figure 4.1: Generalized CAH SZNA assessment plan-view schematic.

If the decision is made to utilize the point-based groundwater sampling transect approach, site-specific decisions regarding transect placement and lateral and vertical sampling point spacing must be made. Increasing the number of sample locations is expected by many to correspond to increases in cost and confidence; therefore, there is interest in gaining a better understanding of the trade-offs between sampling density and uncertainty in mass discharge estimates.

Recent studies have focused on the relationship between sampling density and errors in mass discharge estimates (e.g., Guilbeault et al. 2005; Kubert and Finkel 2006; Li et al. 2007; Mackay et al., 2012). These include analyses using simulated data sets with known answers, and analyses using high spatial density data sets from field sites as discussed below.

Kubert and Finkel (2006) compared mass discharge assessment methods through sampling and analyses of 100 realizations of transport model-generated dissolved plumes emanating from 10-m wide x 4-m (full aquifer thickness) sources. Their sampling transects were built from grids having lateral well spacing ranging from 0.75 m to 7.5 m and 0.25-m to 1.25-m vertical spacing. The majority of their analysis focused on use of point-wise measured mass discharge values (i.e., from passive flux monitors); however, they did evaluate three different approaches for using discrete hydraulic conductivity, hydraulic gradient, and concentration data to estimate mass discharge, including combinations of vertical and area-wide averaging of hydraulic conductivity and gradient data. In their study, the largest errors in mass discharge estimate were associated with multiplying point-wise values of hydraulic conductivity and

concentration with a site-wide hydraulic gradient value to estimate sub-transect mass discharges that would later be summed to determine the contaminant mass discharge across the full transect. Interestingly, errors did not seem to reduce as sampling density increased for that method, while it did for other data analysis methods. For those other data analysis methods, they concluded that estimation errors decrease significantly with decreasing horizontal well spacing and then become insensitive to further reductions in well spacing when it is less than the spatial correlation length scale. This general relationship between error and sampling density is repeated in most of the studies mentioned below.

Modeling work by Li et al. (2007) examined the trade-offs between mass discharge and sampling density for a relatively small 7.9 m wide x 9.8 m deep transect (~26 ft x 32 ft). They simulated spills into permeability fields generated from field data statistics and predicted the resulting dissolved groundwater plumes about 4 m down-gradient of the spills for times in the future corresponding to 1%, 50%, and 98% spill mass removal by dissolution. Their source width was approximately 2 to 3 m, or about $1/3^{\text{rd}}$ of the source width in the Kubert and Finkel (2006) study. Concentration and permeability fields representative of many simulated spills and spill settings from Li et al. (2007) are presented in Figure 4.2.

These dissolved concentration and permeability fields were then sampled, as if they were real sites, at different densities on a regular grid. Each sampling location was assumed to provide characterization information for a fixed area, with areas of 0.3048-m wide x 0.3048-m deep and 0.3048-m wide x 0.6096-m deep areas assumed for 1- and 2-ft well screens (0.3048 and 0.6096 m), respectively. The calculated mass discharges were compared with true values and the relationship between error (and accuracy) and sampling density was examined, with the sampling density defined as the number of sampling points x characterized area/point (either 0.09 or 0.18 m²/point)/total transect area (77.3 m²). They present results for sampling schemes involving 9 to 208 samples, representing roughly 1% to 25% of the transect cross section (or 0.12 to 3.6 points/m²).

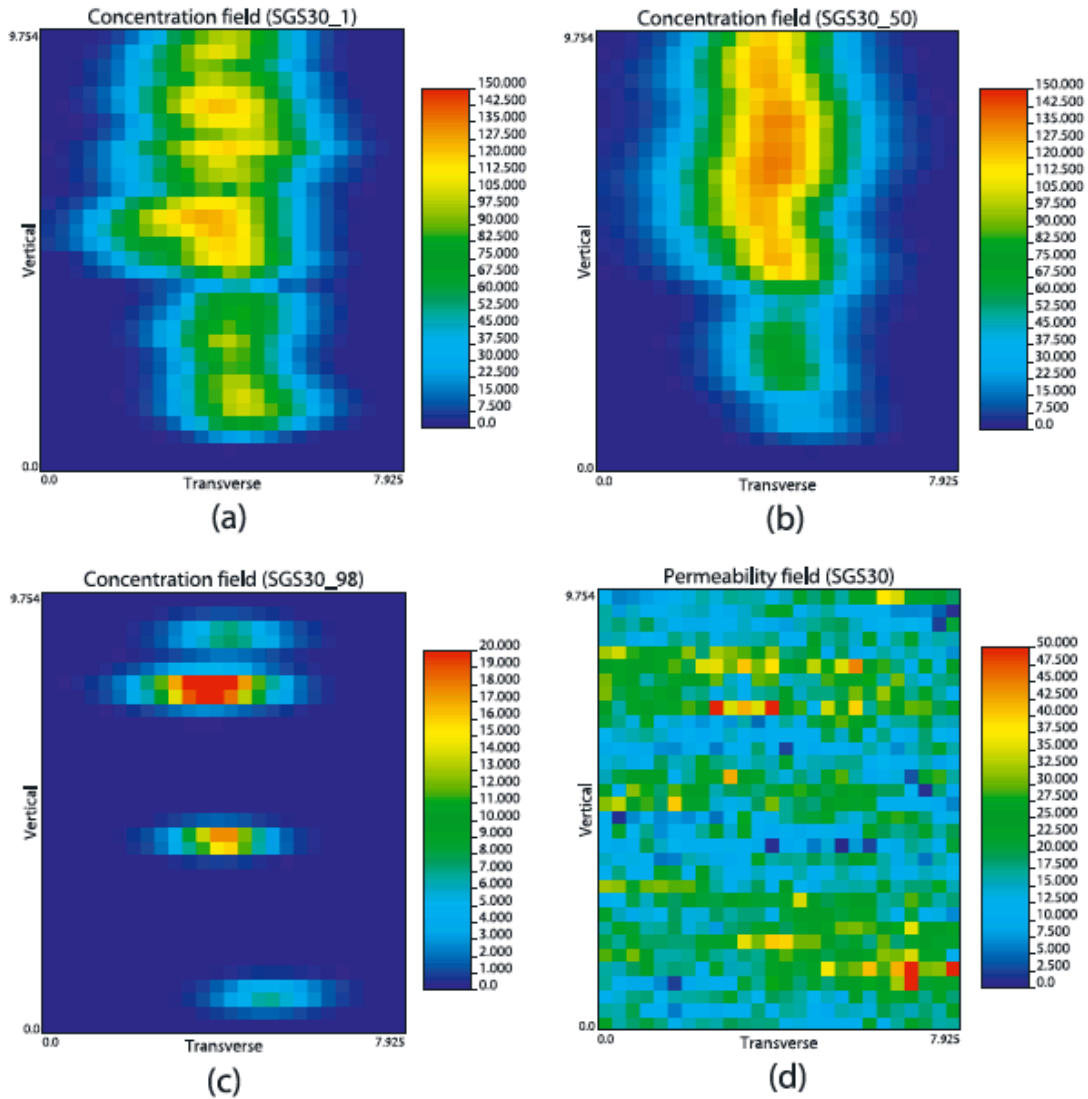

Figure 4.2: Representative concentration and permeability fields reproduced from Li et al. (2007) for: (a) 1% source zone mass loss, (b) 50% source zone mass loss, (c) 98% source zone mass loss, (d) permeability.

Figure 4.3, reproduced from Li et al. (2007), presents the mean absolute error of prediction ($MAEP = (\text{estimated discharge} - \text{true discharge})/\text{true discharge}$) normalized by the true value vs. sampling density for the 1%, 50%, and 98% mass loss scenarios. As can be seen, sampling densities as low as 1% are sufficient to provide estimates of mass discharge within 30% of the true value for the 1% and 50% mass loss scenarios, while sampling densities $>7\%$ are needed to reach the same level of accuracy for the 98% mass loss scenario. The differences are attributed to the degree of spatial variability and scale of the dissolved plume cores shown in Figure 4.2. Significant increases in error, or loss of accuracy, with decreasing sampling density occur when the sample spacing is larger than the scale of the dissolved plume cores shown in Figure 4.2. For example, $n=64$ corresponds to about a 7% sampling density (as defined by Li et

al. 2007), and this is roughly a 1-m scale lateral sample spacing on a regular grid having the width and height used in this work. As noted by Li et al. (2007), sampling densities >7% have not historically been typical for real sites.

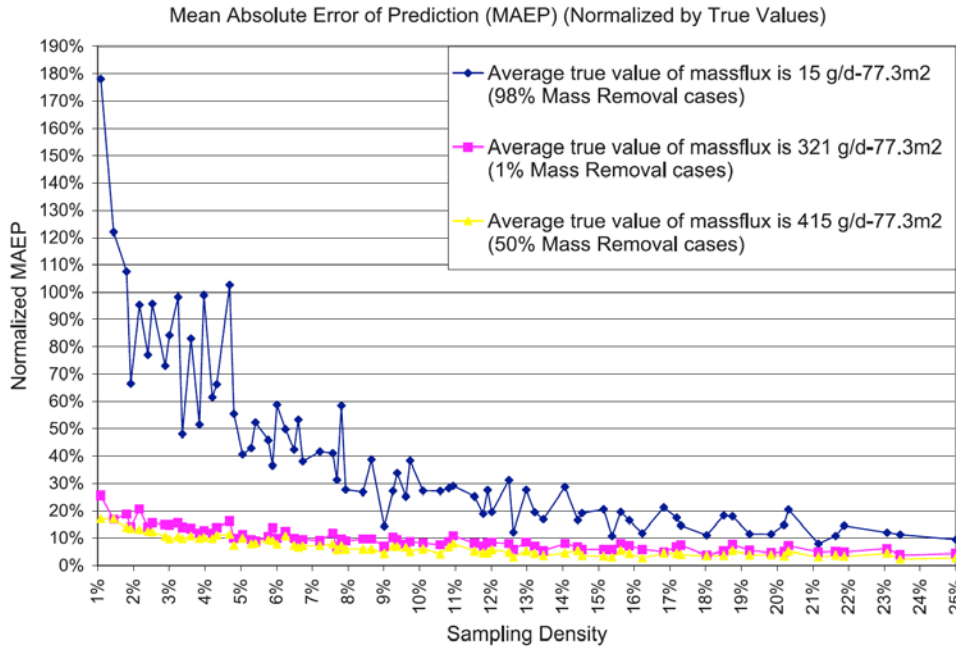

Figure 4.3: Normalized error of predicted mass discharge vs. sampling density (from Li et al., 2007); MAEP = (estimated discharge – true discharge)/true discharge.

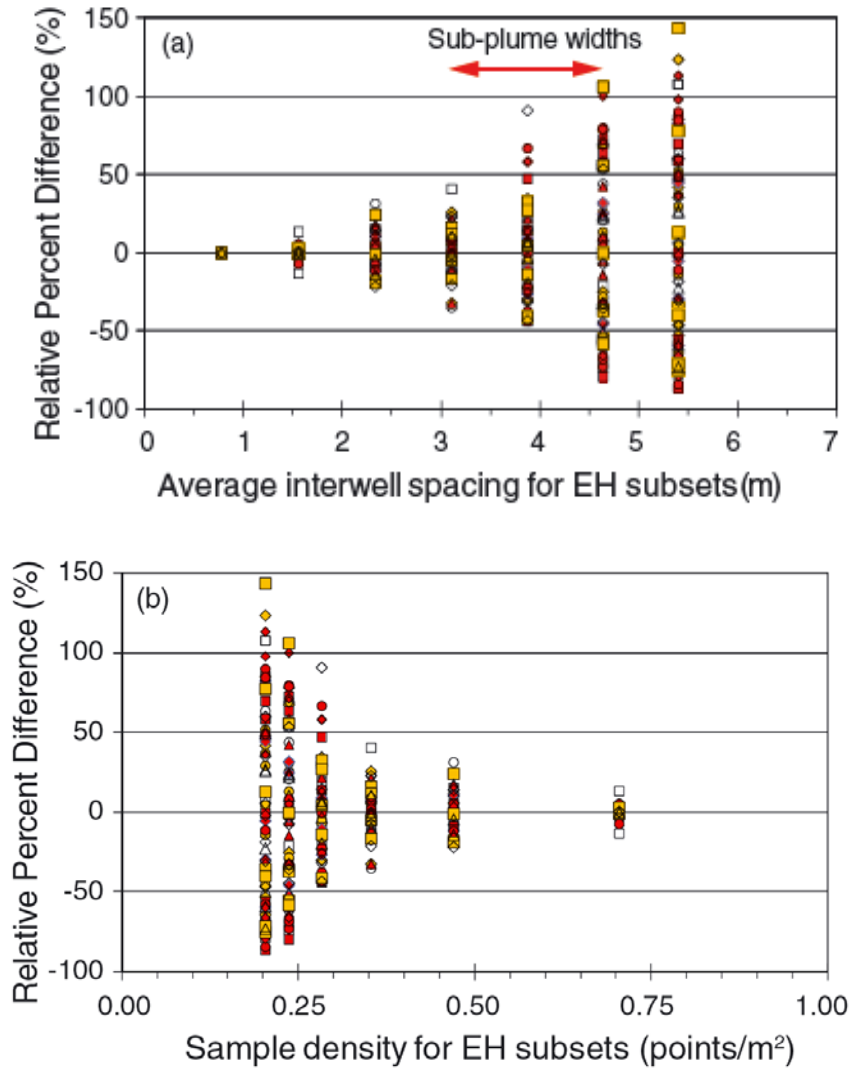

Figure 4.4: RPD in mass discharge vs. inter-well spacing and sampling density from Mackay et al. (2012). RPD is defined in Equation 4.1

Mackay et al. (2012) examined the issue of sampling density vs. accuracy through examination of field data. At their study site they created a bromide tracer plume in a 0.9-m thick and relatively homogeneous sand aquifer, and then sampled it at three transects perpendicular to groundwater flow using wells screened fully through the aquifer and spaced 0.52 - 0.77 m apart. Their overall groundwater plume was approximately 10-m to 15-m wide (increasing with time and distance from release point), with two sub-plumes that were each about 3-m to 5-m wide. These were approximately of the same scale as the Li et al. (2007) simulated plumes.

Mackay et al. (2012) were able to validate their sampling and analysis approach by comparing calculated cumulative mass over time at each of three transects with the known release mass, and achieved very good agreement. They then used the data from one transect to look the effect of decreasing transect resolution (increasing well spacing) on accuracy of the

mass discharge estimate. The sampling points were restricted to subsets of the actual sampling grid, while the error was quantified as the relative percent difference:

$$RPD = 100 \times \left(\frac{M^D - M_{best}^D}{M_{best}^D} \right) \quad 4.1$$

Where:

M^D = Mass discharge for the sub-set sampling plan

M_{best}^D = Mass discharge estimate from the highest sampling density (use of all field data points)

Their results, presented in Figure 4.4, show that mass discharge estimates could be as much as 2.5 times larger than the true value for their lowest sampling density (0.2 points/m²; 5.4 m lateral spacing) and about 1.2 times for their highest sampling density (0.7 points/m²; 0.77 m lateral spacing). The relative percent difference increases to >50% for inter-well spacing increases from roughly 3-m to 4-m, which is approximately equal to the sub-plume widths.

Guilbeault et al. (2005) investigated three CAH contaminated sites using multi-level sampling. The field methods used were similar to those employed in this work in that they relied on discrete vertical sampling, and the data reduction was similar in that mass discharges were calculated for sub-areas and then summed. Sample spacing was about 15 cm vertically across the three sites and 0.5- 2.0 m, 2 – 5 m, and 4- 10 m laterally across their test sites. Guilbeault et al. (2005) did not explore the relationship between sampling density and mass discharge; they did rank-order their sub-areas by mass discharge and plotted cumulative percentage of total mass discharge vs. percentage of total transect area. This revealed that that 90% of the mass discharge traveled through less than approximately 20% of the transect area at their sites, as shown in Figure 4.5.

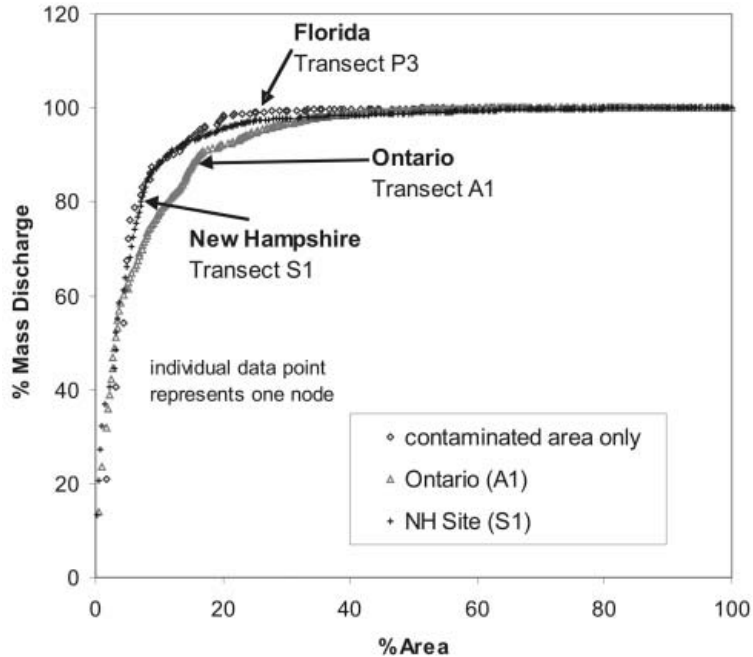

Figure 4.5: Percent of total mass discharge as a function of percentage of area sampled (Guilbeault et al. 2005).

While some of authors related mass discharge estimate error to normalized quantities like the percentage of transect area characterized or points/m², some of those arguably involve arbitrary inputs (e.g., area characterized per sample point); therefore, care must be taken in trying to generalize or compare results between studies. What is common between them is the observation that the mass discharge estimate error is sensitive to sample spacing when the lateral and vertical spacings are greater than the half-width and half-thickness, respectively, of the core plume areas projected on the transect.

In this work we also examine the relationship between sample spacing and mass discharge estimate error for two CAH source zones that are wider and deeper than those examined by Kubert and Finkel (2006), Li et al. (2007), and Mackay et al. (2012). This is of interest because the sample spacings used in those studies are currently not practicable on a routine basis for larger plumes. The analysis approach used here is similar to that used by Mackay et al. (2012), in that mass discharge estimates corresponding to lower resolution subsets of high-density sample grids are compared with the result from the highest resolution sampling. In addition, use of a heuristic sampling rule to guide sample spacing decisions for larger-scale CAH source zones and associated dissolved plumes is examined.

4.2 Sites and Sampling Data Sets

Site 1 is a former base dry cleaning facility with groundwater impacted by PCE and degradation daughter products (TCE, DCE, VC). The subsurface consists primarily of fine sands and silty sands to a depth of approximately 5.5-6 m bgs (18-20 ft bgs), followed by a clay unit approximately 1.8-2.4 m (6-8 ft) thick, and sand, clayey sand, sandy clay, and clay with traces of

shell fragments to a depth of approximately 18 m bgs (60 ft bgs). At approximately 18 m bgs (60 ft bgs) a limestone confining unit is encountered. Depth to groundwater on-site is approximately 1.8 m (6 ft). CAHs are present in the groundwater above and below the clay unit to a depth of approximately 18 m bgs (60 ft bgs) as shown in the transect contour plot in Figure 4.6. The sampling resolution at this site was approximately 1.5 m to 2.0 m vertical spacing x 10 m to 20 m lateral spacing, with the highest resolution in the plume core. The data set includes a total of 64 points (64 points/ $\sim 1600\text{m}^2$).

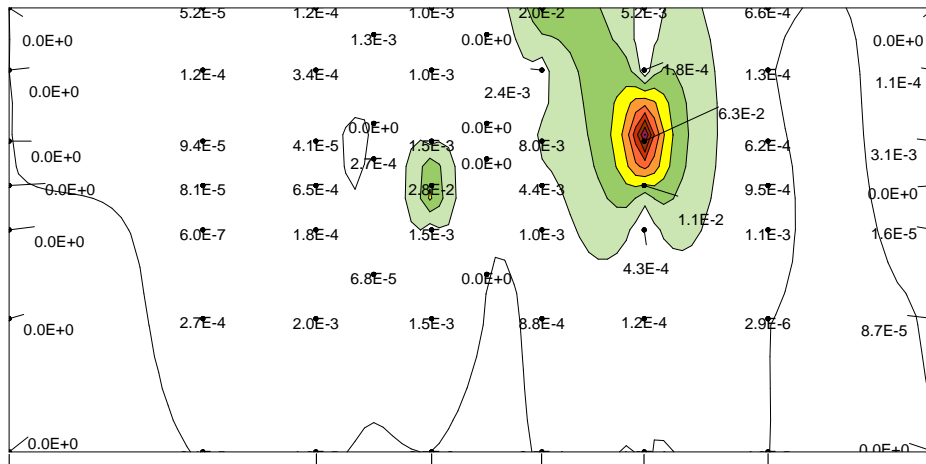

Figure 4.6: Site 1 event 4 normalized CAH mass flux contour with values of PCE equivalent flux ($\text{kg}/\text{m}^2\text{-y}$). Flux contour is normalized to maximum point specific flux from the fourth event.

Site 2 is also a former base dry cleaning facility with groundwater impacted by PCE and degradation daughter products (TCE, DCE, VC). The surficial aquifer extends down to approximately 5.2-5.5 m bgs (17-18 ft bgs) and consists primarily of fine sands and silty sands with a few discontinuous lenses of finer-grained silty clay and clayey sand. A thin peat unit (0.3-1 m thick) below the surficial aquifer is followed by a clay layer (1-2 m thick) at depths from approximately 5.5 to 8.2 m bgs (17-27 ft bgs). The core of the plume is located within the 2.4 to 3.4 m bgs (8-11 ft bgs) interval as shown in Figure 4.7. The sampling resolution at Site 2 was approximately 0.9 m vertical spacing x 10 m lateral spacing and includes a total of 62 points (62 points/ $\sim 150\text{m}^2$).

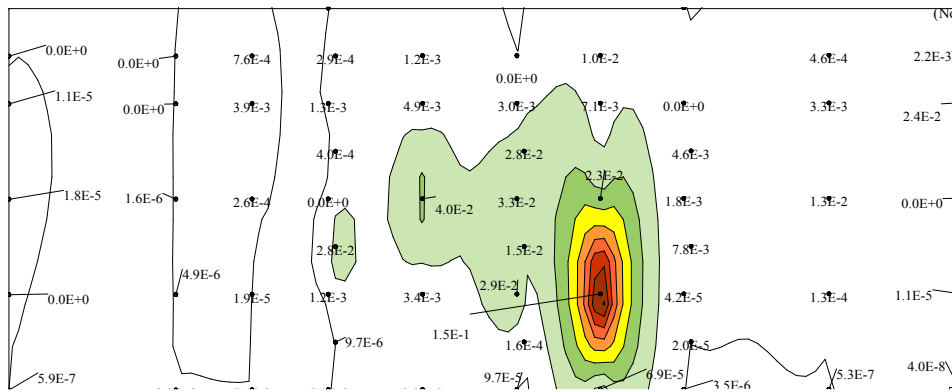

Figure 4.7: Site 2 event 4 normalized CAH mass flux contour with values of PCE equivalent flux ($\text{kg}/\text{m}^2\text{-y}$). Flux contour is normalized to maximum point specific flux from the fourth event.

Cumulative mass discharge percentage vs. cumulative transect sub-grid area plots similar to those presented by Guilbeault et al. (2005) were prepared for the data sets to see if they were similar before using them for subsequent analyses. In total, there were eight field events (four at each site) and all exhibit similar behavior as shown in Figure 4.8. A large percentage (80% – 90%) of the mass discharge at each site occurs within 20% of the transect area.

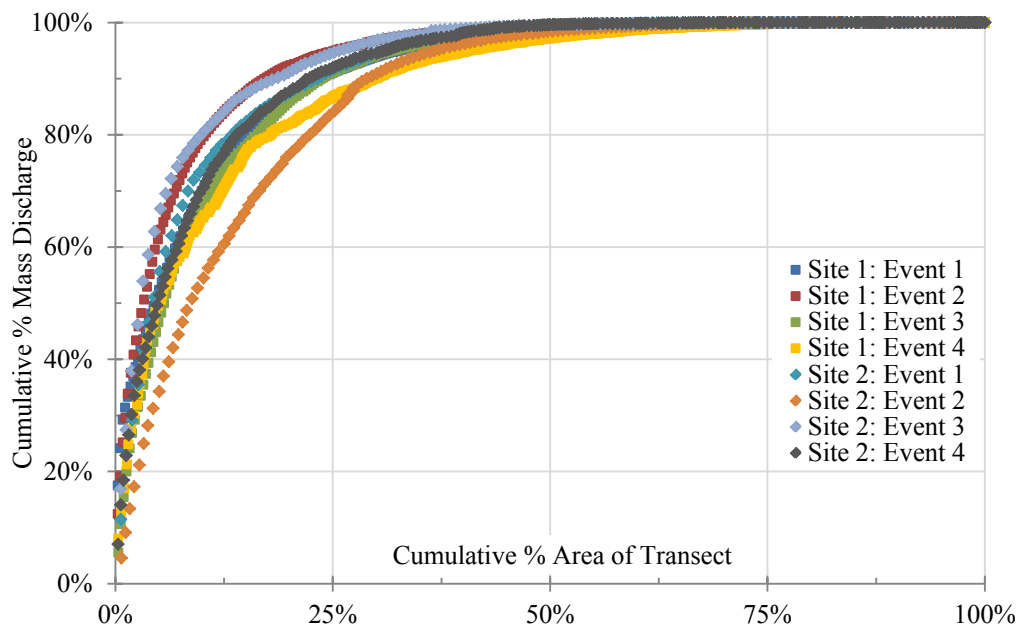

Figure 4.8: Comparison of cumulative percentage mass discharge vs. cumulative percentage transect area.

4.3 Dependence of Mass Discharge Estimate Error on Sample Spacing

To determine the level of uncertainty in discharge estimates that result from utilizing various practical sample spacings at larger CAH impacted sites, a range of sampling scenarios will be examined using the data sets at Sites 1 and 2 described in Chapter 3. Using the discrete sampling data available, different practical sampling scenarios will be developed and the resultant difference in mass discharge rates will be presented and compared.

4.3.1 Sampling Subset Scenarios.

As in the Mackay et al. (2012) work, existing sampling data sets were used and errors in mass discharge estimates were calculated using the mass discharge estimate for the full data set as the assumed best value. All hypothetical sampling scenarios were restricted to subsets of actual field data locations.

The sampling scenarios used in the following analyses were developed independent of prior knowledge of site geology, and scenarios used were limited to realistic sampling schemes using profession judgment. This entails sampling locations that are regularly spaced, with possible offset vertical intervals, and no random sample placements. An example of several scenarios that were used may be found in Figure 4.9.

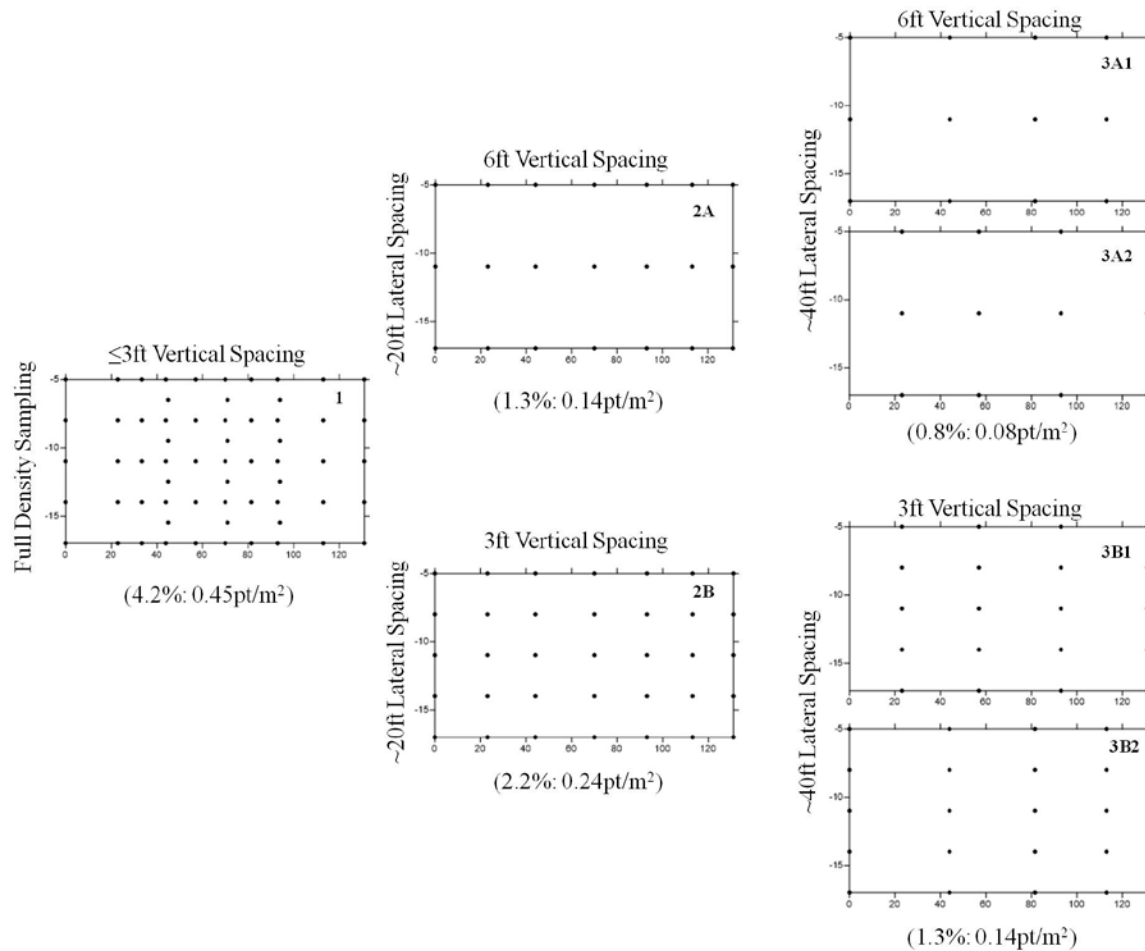

Figure 4.9: Example sub-set sampling scenarios in cross-sectional view: Fully density sampling (left-most plot) defines M_d^{Best} . Sampling densities as defined by Li et al., (2007) and Mackay et al., (2012) are listed below each scenario.

There are a few features common that are inherent to this type of analysis. With reductions in sampling density there are increases in the number of possible combinations of lateral and vertical spacings. For example, for a simple site with 10 total field data sampling locations, there are 45 possible combinations of hypothetical eight-sampling point scenarios and 252 possible combinations of a five-point scenarios. All sampling scenarios used for the two field sites examined may be found in Appendix G.

For ease of comparison to Li et al. (2007) and Mackay et al. (2012), sampling densities were calculated in the same manner as each respective study (MAEP and RPD, where $MAEP \approx RPD$). In the Li et al. (2007) work, each sampling location was assumed to represent one-square foot of the aquifer ($=0.0929 \text{ m}^2$). The number of wells times the sampling area per well was then divided by the total area of the vertical transect plane in determining the sampling density (Eq. 4.2)

$$\text{Sampling Density (\%)} = n(0.0929\text{m}^2)/W \times D \quad 4.2$$

Where:

n = number of sampling locations

W = width of transect (m)

D = depth of transect (m)

The representativeness of this assumed areal value per sampling point largely depends on how samples are collected (direct-push vs. wells, and purge vs. no-purge sampling), and it is possible that this 1 ft² per sample assumption could over- or under-estimate the true sampling area for each sample at a real site (dependent on sampling method used)

In Mackay et al. (2012), sampling density was defined as sampling points per square meter of the transect (points/m²).

For each sub-set sampling scenario analyzed in this work, the estimated mass discharge was converted to a relative percent difference (RPD) using Equation 4.1 as defined in Mackay et al. 2012: It should be noted that this metric results in an absolute minimum value of -100 i.e., discharge estimated at zero when in actuality it is some positive value. The upper bounds on the value of RPD however, are infinite i.e., discharge estimate can be infinitely large in comparison to true value. This has the result of compressing the data on the negative axis, however a value near -100 which would indicate a site is clean when in fact it is not, is much worse than an RPD of 100, 400, 600 etc.

4.3.2 Site 1 and Site 2 Results.

Figures 4.9 and 4.10 present results of the set of hypothetical sub-set sampling scenarios developed for Site 1 and Site 2 respectively. In general, both plots show better agreement with the presumed true value (highest sampling density scenario result) as the sampling density increases, similar to trends in the Li et al. (2007) and Mackay et al (2012) studies. The range of values suggest that, in most cases, the variation from the highest density sampling scenario is generally within a factor of two for many sampling scenarios. For Site 1, agreement seems to be within 50% for sampling densities >0.25%; for Site 2, that same level of agreement occurs at about sampling densities >1.5%. As previously state the use of sampling percentages to generalize results between sites is tenuous. What is important is that a reasonable difference in discharge estimates is possible at lower sampling rates. However, there are a few discharge estimates at Site 2 that result in a RPD value near -100. This value of RPD is significant and suggests using a simple grid approach for site sampling is not sufficient by itself for determining mass discharge rates with confidence; instead additional sampling guidelines are needed.

It is important to note that the hypothetical sampling scenarios used in generating Figures 4.10 and 4.11 were created without influence of the knowledge of the subsurface structure. The effect

of using the subsurface knowledge on sampling plan design is detailed in the next section in an effort increase confidence in discharge estimates.

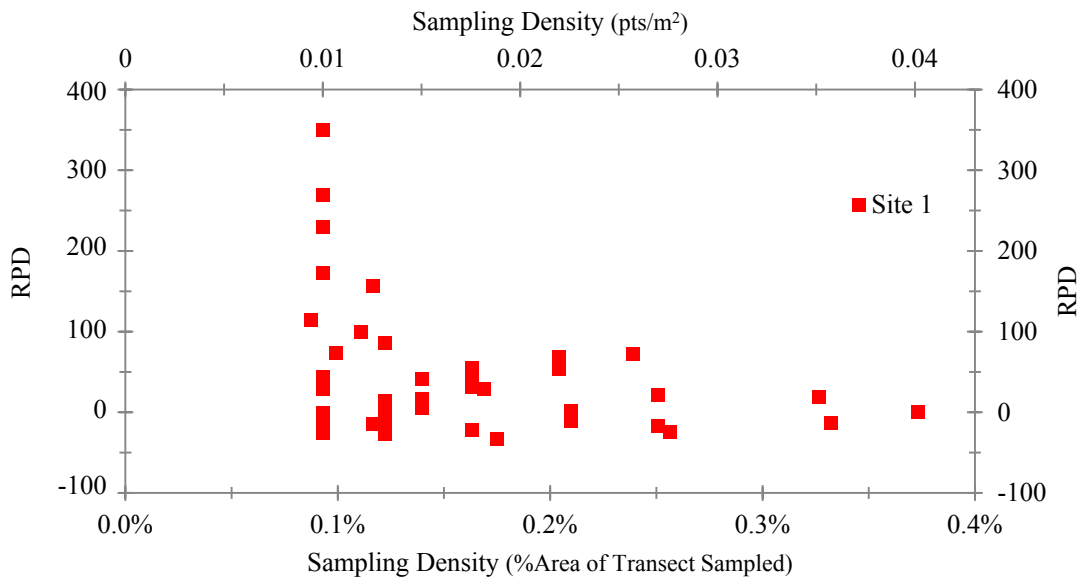

Figure 4.10: Site 1 RPD vs. variable sampling density at site for all subset sampling scenarios.

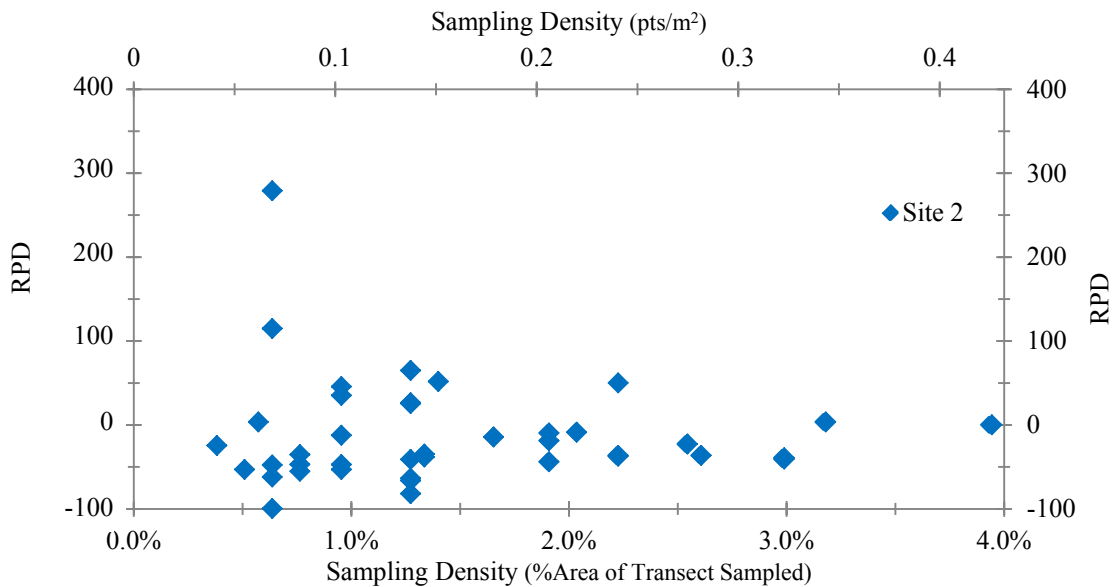

Figure 4.11: Site 2 RPD vs. variable sampling density at site for all subset sampling scenarios.

4.4 Heuristic Sampling Guidelines for Large-Source Sites

4.4.1 Sampling Guidelines.

The sampling densities used in, or recommended from, research studies are unlikely to be implemented in practice except at other research sites or sites where high-accuracy mass discharge estimates are critical. This could change with innovations in sampling that lead to quicker transect sampling at the same or less cost than what is practicable with conventional tools. Data from this work suggest that mass discharge estimates within about a factor of two of true values might be obtainable with a <1% areal sampling densities. This level of uncertainty might be sufficient for corrective action decision-making at many sites, plus additional valuable insight is gained into source structure through transect sampling (Guilbeault et al., 2005; Triplett-Kingston et al., 2010; ITRC 2010).

Still, general sampling guidelines are needed for practitioners to maximize the benefit of a fixed sampling density limited by practical considerations. Based on experience gained from this project, the following sampling guidelines using practical and commonplace sampling tools are suggested for larger CAH source zones:

- Collect a soil core and visually observe to identify distinctive geologic layers.
- Use an initial coarse sampling approach to quickly delineate the boundaries of the plume (~30m horizontal spacings, ~7.5m vertical spacings, with a minimum of one sample in each unit); use on-site chemical analysis screening tools to ensure transect spans the full width of the dissolved contamination.
- Using initial site data for plume boundaries, resample the plume at a higher density
 - Use lateral spacings of no more than the width of contamination divided by 6 across the full width of the plume.
 - Collect a minimum of one sample in each distinct hydraulic unit; constrain the largest vertical separation between samples at same location to depth divided by 6 and not to exceed 7.5m, though higher resolution (<3 m) is preferred.
 - Use highest resolution sampling in suspected core of the plume (<3m vertical intervals)

4.4.2 Sampling Guideline Application Example.

An example of the iterative sampling strategy is depicted in Figure 4.12 for a ~100 m wide x 15 m thick plume in a three-layer system, this would correspond to a minimum of ~8 locations x 3 depths

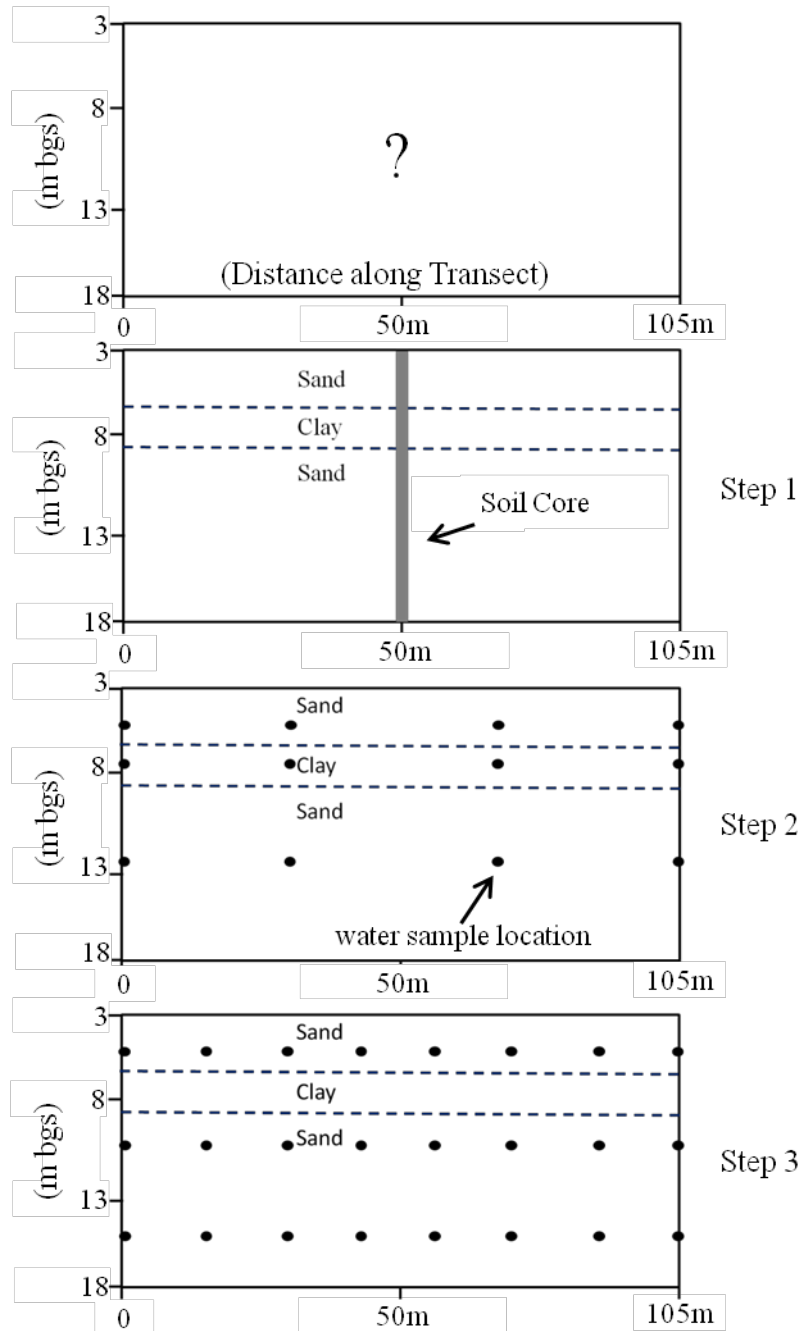

Figure 4.12: Iterative sampling guideline steps at a hypothetical ~100m x 15m thick CAH source. No water is recoverable from the clay layer, so during Step 3 no sample locations are place within the layer. It should be noted that the size of this hypothetical case matches that of Site 1.

4.4.3 Examining Effects on Discharge Estimates using Guidelines.

In light of the previously proposed sampling guidelines, the sampling scenarios previously discussed and used to generate discharge rates for Figures 4.10 and 4.11 were re-

examined. The same sampling scenarios were again plotted in Figures 4.13 and 4.14 with those sampling scenarios that adhered to the previously proposed heuristic sampling guidelines differentiated from those sampling scenarios that did not follow the guidelines. The maximum and minimum discharge charge estimates of the scenarios that meet the sampling criteria are highlighted on the graph by horizontal lines. Statistical descriptions of the difference between these sampling groups are presented in Table 4.1.

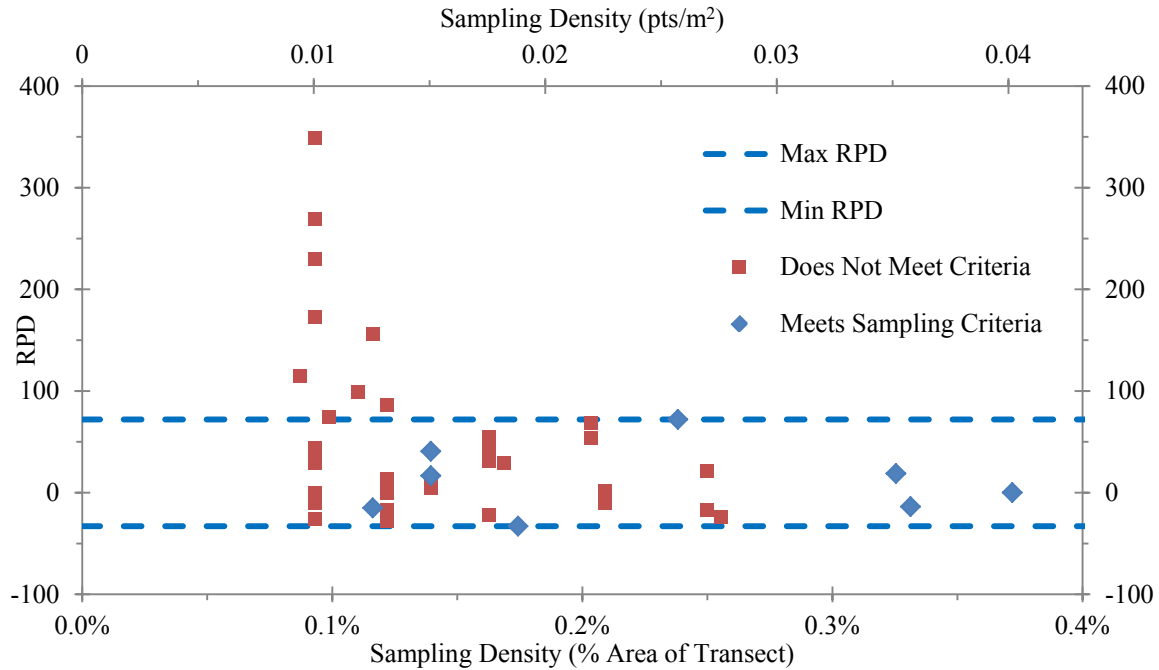

Figure 4.13: Site 1 RPD vs. sampling density, with indicators for sampling scenarios that meet proposed sampling criteria. Notes: True value is defined as the discharge estimate from the densest sampling scenario; max and min RPD refer to sampling scenarios that meet the sampling criteria outlined above.

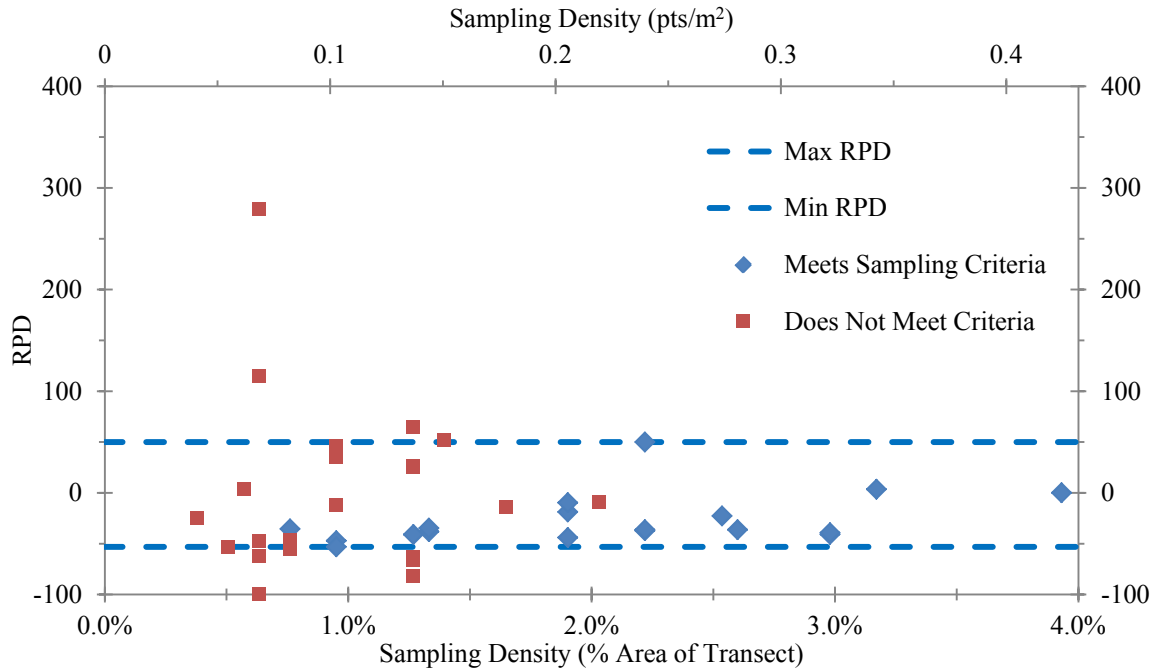

Figure 4.14: Site 2 RPD vs. sampling density, with indicators for sampling scenarios that meet proposed sampling criteria. Notes: True value is defined as the discharge estimate from the densest sampling scenario; max and min RPD refer to sampling scenarios that meet the sampling criteria outlined above.

Table 4.1

Descriptive Statistics for Ranges of Discharge Results for Sampling Scenarios

Criteria Met?	#	Relative Percent Difference (RPD)			% of True Value			Sampling Density					
		Max	Min	Avg.	Max	Min	Avg.	%			pts/m ²		
								Max	Min	Avg.	Max	Min	Avg.
Y	26	72	-53	-15	172	47	85	3.9	0.12	1.5	0.42	0.12	0.16
N	58	350	-100	31	450	0.3	130	2.4	0.09	0.5	0.22	0.009	0.05

Note: True value is defined as discharge estimate of highest density sampling scenario

Examining Figures 4.13 and 4.14, it can be seen that those scenarios that meet the sampling criteria outlined fall within a relatively small range, at most a factor of two greater than the best estimate (Table 4.1). Most importantly the scenarios that resulted in the extreme RPD values (near -100) are eliminated by applying the guidelines. This would suggest that the sampling criteria previously outlined, may provide a relatively robust method to assess mass discharge rates at similarly sized CAH impacted sites at practical sampling densities.

Remedial actions at the sites sampled during this work were minimal prior to the site characterization using the method outlined in Chapter 2. Thus, the sample criteria outlined may only apply to sites that have had minimal to no mass removal (<50%) prior to the initial sampling as is suggested by Li et al., (2007). Sites that have had significant amounts of CAH removal may require larger sampling densities to identify the residual pockets of contamination that remain. Though even in these cases it is possible that, with a thorough understanding of site geology, those regions of residual-contamination (likely lower-K units) may be targeted to identify an accurate mass discharge.

For sites that display characteristics significantly different from those encountered e.g. less than 30 – 45m in width, the guidelines may not be applicable. In a case such as modeled by Li et al., 2007 where the source was less than 10m wide, the proposed guidelines would likely miss the contamination. In an effort to improve the sampling guidelines, for cases such as the one outlined above it is suggested that additional work be undertaken, if possible using existing high density sampling data, to test/refine the sampling criteria for variations of estimated mass discharge rates.